

1 **PARTIAL SAFETY FACTORS FOR PRESTRESSED CONCRETE GIRDERS**
2 **STRENGTHENED WITH CFRP LAMINATES**

3 D. Dias-da-Costa¹, L.A.C. Neves², S. Gomes³, R. Graça-e-Costa⁴, S.A. Hadigheh⁵, P. Fernandes⁶

4 ¹Associate Professor, School of Civil Engineering, Univ. of Sydney, Sydney, NSW 2006, Australia;
5 Institute for Sustainability and Innovation in Structural Engineering, Dept. of Civil Engineering,
6 Univ. of Coimbra, Rua Luís Reis Santos, Coimbra 3030–788, Portugal (corresponding author).
7 Email: daniel.diasdacosta@sydney.edu.au

8 ²Assistant Professor, Resilience Engineering Research Group, University of Nottingham, Faculty of
9 Engineering, University Park, United Kingdom.

10 ³Researcher, IISSE, Department of Civil Engineering, University of Coimbra, Rua Luís Reis Santos,
11 3030–788 Coimbra, Portugal.

12 ⁴Assistant Professor, CEPAC, Universidade do Algarve, Campus de Gambelas, 8005-139 Faro,
13 Portugal; CERis-ICIST, DECivil, Instituto Superior Técnico, Universidade de Lisboa, Av. Rovisco
14 Pais, 1049-001 Lisboa, Portugal.

15 ⁵Lecturer, School of Civil Engineering, The University of Sydney, Sydney, NSW 2006, Australia.

16 ⁶Associate Professor, Civil Engineering Department, Instituto Politécnico de Leiria, Portugal; CERis-
17 ICIST, DECivil, Instituto Superior Técnico, Universidade de Lisboa, Av. Rovisco Pais, 1049-001
18 Lisboa, Portugal.

19

20

21 **Abstract**

22 This paper provides a framework for the calibration of partial safety factors in prestressed concrete
23 (PC) girders strengthened in flexure with carbon fibre-reinforced polymer (CFRP) laminates. A
24 hybrid approach was proposed to take advantage of comprehensive non-linear numerical models in
25 reliability analysis using a first order reliability method (FORM) in conjunction to the response
26 surface method (RSM). The PC girders selected for analyses were taken from real structures designed
27 and built since the 1980s, based on old standards, now requiring strengthening and upgrade due to
28 partial corrosion of prestressing strands. Using the proposed approach, a sensitivity analysis was
29 performed to identify the most relevant variables and assess the area of CFRP laminates needed to
30 restore the capacity to new design standards. Following this study, a partial safety factor was proposed
31 for strengthening PC girders using CFRP laminates. A sensitivity analysis also showed the traffic
32 loads and model uncertainties to be the most important variables for calibration.

33 **Keywords:** CFRP laminates; concrete girder; reliability; numerical models; partial safety factors;
34 target reliability index.

35 Introduction

36 Many reinforced concrete (RC) bridges built in the last decades using precast prestressed concrete
37 (PC) girders are currently in need of retrofit or upgrade due to degradation and increasing traffic. As
38 interventions are progressively undertaken, the use of externally bonded fibre-reinforced polymer
39 (EB FRP) laminates is a competitive technique when compared with other options (e.g., concrete
40 jacketing or epoxy-bonded steel plates). This is due to the low weight and thickness of FRP laminates,
41 easy application, high stiffness and strength, corrosion protection and reasonable costs (CEB-FIB
42 2001).

43 There are currently several guidelines applicable to EB FRP laminates, such as the CEB-FIB (2001),
44 ACI 440.2R-08 (2008), CNR (2001), TR-55 (2000), and the AS 5100.8 (2017). To design
45 strengthening solutions using FRP laminates, the guidelines adopt a limit state approach, where safety
46 or reduction factors, respectively, γ and ϕ , are either applied to the overall resistance or to each
47 material property, depending on the standard. A summary of these factors for carbon FRP (CFRP)
48 laminates is shown in Table 1.

49 Despite the standards available, there are still limitations in terms of their scope of application.
50 Specifically, the partial safety factors were mostly developed for new construction and may not
51 directly apply to rehabilitation/strengthening of existing structures. In this case, the assessment of the
52 partial safety factor to be adopted certainly depends on the type of structure and loading conditions
53 such as flexural, on the confinement (Baji 2017), on the standard adopted in the original design,
54 current state of damage, as well as, on the new standard in place when rehabilitation is sought. In the
55 European context, for example, this issue is particularly critical given that many structures were
56 designed using former national guidelines, which are often less demanding than the new guidelines
57 now in use by all partner countries.

58 Several researchers (Coelho et al. 2018; El-Tawil and Okeil 2002; Monti and Santini 2002; Okeil et
59 al. 2002; Plevris et al. 1995) addressed the uncertainties in the quantification of safety factors
60 applicable to structures strengthened in flexure with FRP laminates. The general approach is based
61 on the creation of a database with a wide range of parameters and Monte Carlo simulations for each
62 designed member. The resulting randomly generated data sets are then used to develop a resistance
63 model for strength. The probability of failure and the reliability index are normally assessed using a
64 first order reliability method (FORM) with the subsequent calibration of flexural resistance factors.
65 One of the first studies in this scope was carried out by Plevris et al. (1995) focusing on reinforced
66 concrete beams strengthened with CFRP laminates. The authors classified the strength and the

67 ultimate strain of the concrete and area of the CFRP laminates as most relevant properties, and
68 calibrated safety factors for a target reliability index of 3.0. It should be mentioned that this study did
69 not include structural rehabilitation. This was addressed later in the studies from Okeil et al. (2002),
70 and El-Tawil and Okeil (2002), where CFRP laminates were used to restore the capacity of degraded
71 bridge girders. The strength reduction factors were calibrated for target reliability index factors of
72 around 3.75. Atadero and Karbhari (2008) performed a reliability study on RC T-beams strengthened
73 with CFRP laminates using real design situations. They developed a methodology to calibrate the
74 strength factors for flexural strengthening based on three reliability indices (2.5, 3.0 and 3.5). They
75 used a simplified analytical model for the debonding of CFRP laminates and showed the reliability
76 of beams to strongly depend on the amount of reinforcement that remains uncorroded in the damaged
77 structure. Intermediate crack and end debonding failure modes on FRP-retrofitted RC T-beams were
78 considered by Pham and Al-Mahaidi (2008). Their study found that the type of debonding
79 significantly decreases reduction factors in the reliability analysis.

80 It is quite common to perform reliability studies using simplified analytical models with a common
81 assumption of perfect bond between FRP and substrate. In fact, limited research has considered
82 intermediate crack debonding – even if this effect is critical in the analysis of safety factors (Pham
83 and Al-Mahaidi 2008). It is not yet known to which extent the underlying simplifications are safe for
84 design. For example, the interaction of cracks and the debonding, or the failure of the FRP laminates,
85 all are highly related phenomena, and their consideration in numerical models could potentially lead
86 to more demanding safety/reduction factors based on reliability analyses. The study presented in this
87 paper contributes towards these research questions by focusing on the reliability analysis of PC bridge
88 girders strengthened in flexure with CFRP laminates.

89 The girders selected for analysis are taken from existing PC bridges requiring strengthening based on
90 a set of idealised damage due to corrosion of prestressing steel. The girders were originally designed
91 and built since the 1980s using old standards, in which case any strengthening solution sought here –
92 attachment of CFRP laminates– needs to comply with new standards, in this case European Standards
93 EN1991-2 (2002) and EN1992-2 (2005). The paper quantifies the partial safety factors that could be
94 used for designing the strengthening solution with CFRP laminates and presents a new hybrid
95 procedure to take advantage of non-linear FEM models to accurately simulate the material and
96 structural behaviour thus obtaining a more refined solution in reliability analysis.

97 The proposed hybrid method combines an analytical simplified model to obtain a first estimate on
98 the reliability index, after which an advanced FEM model searches for a more refined solution for
99 designing the strengthened structure. The study also focusses on the requirements created by the
100 replacement of old standards by the Eurocodes, since these are often significantly more demanding

101 in terms of safety and loads. Up to the authors knowledge, the study presented in this paper is the first
102 that directly proposes a hybrid method for reliability analysis and quantifies partial safety factors for
103 damaged prestressed concrete girders strengthened with bonded CFRP laminates in the scope of the
104 Eurocodes. The new framework is quite general and can be easily adapted to other codes.

105 **Design cases**

106 The bridges studied in this paper are based on a simply-supported structural scheme widely used in
107 main roads connecting mid-sized towns in Portugal. The span is relatively short when compared with
108 most recent practice in construction and ranges between 13 and 19 m. The bridge was designed for
109 one traffic lane in each direction, with a side-walk on both sides. The structure was composed of three
110 prestressed concrete 'I'-shaped girders – see cross-section defined in Figure 1 and dimensions in
111 Table 2. The mean concrete compressive strength, f_{cm} , was 43 MPa, the mean tensile strength, f_{ctm} ,
112 was 3.2 MPa and the mean Young's modulus, E_{cm} , was 34 GPa. Please note that the notation adopted
113 is in accordance with Eurocode 2 EN1992-2 (2005).

114 The bridges complied with the provisions from REBAP (1983) with design loads given in RSA
115 (1983). It is worth mentioning that both ultimate and service limit states were considered in the
116 original design. The exterior girder is typically the most critical and is herein considered for further
117 analyses. The three representative spans adopted are, 13 m, 16 m and 19 m, in which case the
118 corresponding main dimensions of the exterior girder are summarised in Table 2.

119 It should be mentioned that the design loads required by the new European Standards EN1991-2
120 (2002) and EN1992-2 (2005) can be significantly higher than those obtained with the old standard.
121 For example, the ratio between live and dead bending moments for the shortest span reaches a factor
122 of 3 in the new standard, whereas the same factor drops to 2 in the old one. This means that upgrading
123 the girder also requires strengthening to meet the new standard. The unstrengthened (or undamaged)
124 situation is the reference (D0) in the study that follows. In addition, six damaged scenarios are chosen
125 for the same girder caused by corrosion of prestressing strands. Such scenarios are defined by
126 assuming the loss of area for the prestressing strands ranging from 10 to 30% affecting one (Dx) or
127 the two (2Dx) levels of reinforcement. A summary of all scenarios and the remaining (i.e. uncorroded)
128 area of the prestressing strands, A_p , is given in Table 3.

129 The strengthening of the PC girders is to be achieved using CFRP laminates with anchorage at both
130 ends, as to obtain the maximum benefit from strengthening with CFRP laminates (Garden and
131 Hollaway 1998; Quantrill and Hollaway 1998). The area of the CFRP laminates should restore the
132 structural capacity of the girders.

133 Proposed hybrid model for reliability analysis

134 This section proposes a hybrid model for reliability analysis using the design cases defined in the
135 previous section, with the purpose of determining the design area of CFRP laminates to comply with
136 the reliability index as defined by EN 1990 (2002).

137 *General background*

138 Failure is herein defined as the random structural resistance, R , being lower than the current random
139 load demand, S , in which case (Bucher 2009; FERUM 2010; Melchers 2017):

$$140 \quad P_f = P(R - S < 0), \quad 1$$

141 and structural reliability is defined by $1 - P_f$, which identifies the probability of the structure
142 performing its intended function. The relationship $R - S$ is designated by limit state function and is
143 a boundary separating acceptable and unacceptable structural performance depending on the random
144 variables defined. Graphically, the probability of failure corresponds to the grey volume represented
145 in Figure 2.a if only two variables are considered.

1461 The reliability index, β , and the probability of failure, can both be shown to be equivalent.

$$4 \quad \beta = \frac{b}{\sigma}$$

147 Geometrically, the former parameter directly measures the minimum distance from the origin to the
148 failure domain. This point is the so-called design point – see representation in Figure 2.b (r^*, s^*) –
149 and its cosines direction measure the importance of each parameter on the probability of failure, where
150 a positive value means that an increase of the mean value also increases safety (see Figure 2.c).

151 The limit state function is typically defined using several variables that may not be normally
152 distributed. In this case, the random variables are transformed from the original space to a standard
153 normal space, which simplifies calculations since the transformed variables will follow an
154 approximated normalised distribution. This normalisation can be applied using the Nataf
155 transformation described by Melchers (2017). It should be mentioned that there is not usually a
156 closed-form equation available for the limit state function. Therefore, the derivation of the reliability
157 index requires an iterative approach to identify the design point. FORM uses a Taylor expansion in
158 the neighbourhood of the design point that is progressively refined. For highly non-linear problems,
159 however, a combination of FORM with the response surface method (RSM) can be more effective.
160 The RSM is used to approximate the non-linear limit state function by a regression function of lower-
161 order polynomials (Bucher, 2009) using selected support points for each random variable. The

163 approximated limit state function, and the second applies FORM to determine the reliability index
 164 for the approximated limit state function. Both are applied sequentially until converging into a design
 165 point within an acceptable threshold.

166 In the following section, a new methodology is proposed for the efficient use of RSM and FORM
 167 with advanced non-linear numerical models for prestressed concrete girders strengthened with CFRP
 168 laminates. The methodology combines both analytical and numerical models to limit the use of time-
 169 consuming calculations in the search for the design point.

170 *Methodology implemented*

171 The limit state function, G , was herein defined by the difference between the resistance and
 172 standardised traffic loads, as follows:

1731 $G = g_{ml} - g_{tl}$, 2
 7
 3

1741 where g_{ml} is the maximum traffic load scale factor supported by the girder – obtained using the
 7
 4 g

1751 analytical and FEM models as described ahead – and g_{tl} is the traffic load scale factor. The model
 7
 5 uncertainties are considered as:

1761 $g = q_E q_R g$
 7
 6

1771 $G = g_{ml} (q_E)^{q_R} - g_{tl}$, 3
 7
 7

1781 where q_R is the resistance model uncertainty and q_E is the load model uncertainty. The resistance
 7
 8 q q

179 uncertainty is directly multiplied by the scale factor, whereas the load uncertainty is assigned to the
 180 structural model to affect both traffic and remaining loads.

181 The maximum traffic scale factor is obtained from the ultimate load, and is a function of all remaining
 182 random variables, including dead loads. Therefore, the limit state function can be written as:

1831 $G = g_{ml} (q_E; \eta_1; \eta_2; \eta_3; \dots; \eta_n)^{q_R} - g_{tl}$, 4
 8
 3

1841 where ϵ_i stands for the random variables.

8

4

n

185 A hybrid process is herein proposed using RSM and FORM to efficiently take advantage of
186 comprehensive non-linear numerical models. For this purpose, analytical and numerical models are
187 progressively used in the analysis to calculate the area of laminates needed for strengthening the
188 structure and reach the necessary target index. This parameter is taken from EN 1990 (2002) for a
189 level of high economic, social and environmental consequences for structural failure, in which case
190 β_i is 4.3. Please note that more details about each model are provided ahead.

191 The analytical model is used to calculate the area of the strengthening laminate, A_f , corresponding to
192 the target reliability index defined in the standard. The area of the laminate is searched incrementally,
193 so that each step starts by guessing the area and then obtaining the reliability index using RSM and
194 FORM. If this index is within 1% error of the target, the non-linear numerical model is engaged in a
195 second stage of analysis leading to a more accurate search. This procedure is very efficient, since the
196 use of a computationally demanding non-linear model is minimal and only applied to fine-tune the
197 final reliability index.

198 Within each cycle of analysis, the iterative procedure first calculates the reliability index, as
199 represented in Figure 3. This is carried out by initialising the design points, dp_0 , and reliability index,
200 b_0 , with mean values used for the random variables. RSM is then applied to define the response
201 surface in the neighbourhood of the design and support points. Analytical and numerical models are
202 used to run structural analyses and define the response surfaces. Finally, a new estimate for the design
2032 points, d_{n+1} , is obtained from FORM by calculating the maximum load scale factor at the design

0
3

2042 point, dp_n , including an updated reliability index, b_{n+1} . If the change in the reliability index is less

0
4

b

205 than 1% the procedure stops and convergence is found. Otherwise, a new surface approximation is
206 calculated with RSM based on the most recent approximation for the design points and the whole
207 cycle starts.

208 *Probabilistic models*

209 Only the most significant variables are herein considered random following the recommendations
210 found in (Gomes et al. 2014). These are the steel strand strength, f_p , CFRP laminates strength, f_t , and
211 resistance model uncertainties, Q_R , on the side of the resistance models, and traffic loads scale factor,
212 g_{tl} , dead loads, g_{dl} , self-weight of concrete, g_c , and load model uncertainties, Q_E , on the side of the
213 load model. Table 4 summarises the statistical descriptions for the adopted variables.

214 In the definition of the distribution types and coefficients of variation (COV) for each variable,
215 available bibliography was considered. The steel strand strength model was selected based on the
216 study from Jacinto et al. (2012). The CFRP laminates strength model was defined after a probabilistic
217 study by Gomes et al. (2018), where the Weibull distribution was shown to be accurate for
218 probabilistic analyses. The dead loads corresponding to the weight of sidewalks, guard rails and
219 asphalt are considered uniformly distributed over the girder, following a normal distribution with a

221 The statistic values of the traffic loads, Q , can be assumed to have a normal distribution according to
 222 von Scholten and Vejdirektoratet (2004). Considering that the nominal values defined in the standard
 223 correspond to the 95 th percentile and that the bridge lifetime horizon is 50 years for the strengthened
 224 situation, the distribution for the maximum load asymptotically approaches a Gumbel distribution
 225 with mean and standard deviation values (Ang and Tang 2007) provided by the following:

$$226 \quad \eta = u_n + \frac{g}{a_n} \quad 5$$

$$227 \quad s = \frac{p}{\sqrt{6a_n}} \quad 6$$

228 where g is the Euler–Mascheroni constant (0.5772), n is the time in years, u_n is the shape parameter
 229 and a_n is the scale parameter.

230 The characteristic value of traffic loads from Gumbel distribution is found using the following
 231 equation:

$$2322 \quad Q_k = \frac{\eta_{tl}}{1 + 1.866V_{tl}}, \quad 7$$

3
2

2332 where η_{tl} and V_{tl} are respectively the mean and the coefficient of variation (COV) of the traffic
 3
3 η

234 loads, Q . The 95 th percentile loads scale factor is herein taken as 1 and the COV 0.15 (Atadero and
 235 Karbhari 2008; El-Tawil and Okeil 2002; Wisniewski 2007).

236 The model uncertainties were defined following the range of recommendations in (El-Tawil and
 237 Okeil 2002; JCSS 2001), with a mean value of 1.05 and COV of 0.105.

238 It should be mentioned that effects of the ageing of the epoxy and fatigue loads were not considered
 239 in the analyses.

240 *Structural analysis*

241 This section briefly describes the two approaches used for performing the structural analysis of the
 242 girders.

243 - Analytical model

244 The analytical model is based on a cross-sectional analysis using the stress-strain diagram shown in

245 Figure 4 for a linear strain distribution over the girder depth. Plane sections were assumed to remain
246 plane after bending, in which case the flexural moment is computed as follows:

247 $M = F_c z_c + F_p z_p + F_f z_{fu}$ 8

2482 where F_c is the compressive force in concrete, z_c is the distance from the neutral axis to the upper
4
8

2492 fibre, x , to the concrete force, F_p is the force due to prestressing strands, z_p is the distance between
4
9

2502 the prestressing strands and the neutral axis, F_f is the force due to CFRP laminates, and z_f is the
5
0

251 distance from the CFRP laminates to the neutral axis.

252 The constitutive model for concrete under compression is modelled using the stress-strain relation
253 given in EN 1992-1-1 (2004):

254 $\frac{s_c}{f_c} = \frac{k h - h^2}{1 + (k - 2) h}$, 9

255 with

256 $h = \frac{\epsilon_c}{\epsilon_{c1}}$ and $k = 1.05 E_c \frac{|\epsilon_{c1}|}{f_c}$ 10

257 where ϵ_{c1} is the strain at peak stress according to EN 1992-1-1 (2004), E_c is the secant Young's
258 modulus of concrete, and f_c is the concrete cylinder compressive strength. The tensile strength of
259 concrete is disregarded in the analysis.

260 The ultimate strength of the cross-section is calculated in two main stages of analysis. In the first
261 stage, the stress state at the cross-section is calculated before strengthening, so that the stress/strains
262 installed just before applying the CFRP laminates are known. This first step is critical to assess the
263 initial strain at the soffit of the girder, where CFRP laminates are going to be applied, and that will
264 no longer be transferred to the laminates once the strengthening system is fully operational. In the
265 second stage of analysis, the ultimate moment of the girder is finally obtained by identifying which
266 failure mode occurs first, i.e. the mode with the lowest bending moment. All possible situations are
267 accounted for, e.g. debonding and failure at CFRP laminates, crushing of concrete, prestressing
268 strands reaching the 0.1% proof stress before (or simultaneously) with failure at CFRP laminates.
269 During each stage of analysis all calculations are performed following a standard iterative procedure
270 that searches for the location of the neutral axis and assures the balance of forces inside the cross-
271 section.

272 - Numerical model

273 A finite element model based on the discrete strong discontinuity approach (DSDA) is used to
274 perform the advanced analysis of the structural behaviour of the concrete girders strengthened with

275 CFRP laminates (Dias-da-Costa et al. 2018b). The model is based on finite elements enhanced by
276 additional degrees of freedom that are progressively placed along the crack paths to measure their
277 widths. The effect of the crack opening is then transmitted to the edges of the enhanced element as a
278 rigid body movement that increases the overall deformability of the structure due to damage
279 propagation and development (see Figure 5a). During the structural analysis, new cracks are activated
280 inside each element whenever the strength of concrete is reached, therefore preventing the maximum
281 tensile stress to rise above it. Each crack undergoes a traction-separation law that softens the tensile
282 stress, simultaneously reducing the stiffness of the element while increasing the crack width. The
283 development of the model from a conceptual and mathematical points of view can be found in (Dias-
284 da-Costa et. al 2009).

285 The embedded cracks can naturally interact with steel and strengthening material, thus capturing the
286 local debonding and increased deformation due to damage of the materials. This capability is critical
287 to accurately predict the ultimate strength of the member (Dias-da-Costa et al. 2018b). Figure 5b
288 compares a discrete crack model with smeared models in the neighbourhood of highly-localised stress
289 fields caused by the opening of a crack and represents the local stretching and failure of the CFRP
290 laminates. Such model was shown to provide reliable results in terms of crack propagation, crack
291 patterns and crack openings for both service and ultimate loads in concrete members under flexural
292 loads (Dias-da-Costa et al. 2010; 2017 and 2018aa). A detailed presentation about the implementation
293 aspects can be found in (Dias-da-Costa et al. 2009; 2013 and 2013).

294 The numerical model is validated using experimental data from flexural tests performed on PC
295 girders, one with and two without CFRP laminates (Fernandes 2007; Fernandes et al. 2013) – see
296 Figure 6a. The ‘I’-shaped girders were tested under flexural loading. The active reinforcement was
297 composed by twelve 3/8" prestressing bonded strands at bottom and two 3/8" unbonded post-
298 tensioning strands at the top of the cross-section – see Figure 6b. The stirrups in the web were 5 mm
299 bars with 500 MPa yield stress in a two-legged arrangement with 150 mm spacing along the span.
300 The pre-tensioning strands were initially stretched to 1,430 MPa before pouring concrete and kept
301 attached to the precast table, i.e., not engaged with the girder until day 5. At that age, six pre-
302 tensioning strands were released and the post-tensioning strands were stretched to 1,160 MPa. Next,
303 the six remaining pre-tensioning strands were cut from the table and the girder fully demoulded. The
304 post-tensioning strands were only installed to avoid premature failure due to the high level of stress
305 applied by the pre-tensioning strands at such an early age. It should be highlighted that once the
306 girders are finally taken to the construction site to erect the bridge, the post-tensioning strands are
307 meant to be deactivated after enough vertical load is applied to the structure. These girders were part
308 of a linkage project with precast industry to study the economical and practical possibility of

309 extremely short turnaround times, in which case high-strength concrete was used to allow enough
310 compressive strength when releasing the pre-tensioning strands at an early age. The girders were
311 designed and experimentally tested by one of the co-authors and were selected for validation of the
312 numerical model given that very detailed information was available. The properties for the high-
313 strength concrete were experimentally characterised and are listed in Table 5. The strengthening of
314 the girder was also addressed by the original experimental programme. The CFRP laminates used in
315 the strengthened girder consisted of two CFK 150/2000 with rectangular cross-section of
316 $100 \times 1.4 \text{ mm}^2$ anchored at the extremities. Figure 7 shows the failure after the tests.

317 The numerical simulations are based on 2D analysis using the finite element mesh shown in Figure
318 8. Plane stress bilinear (i.e. 4-node) elements are adopted for simulating concrete, whereas linear truss
319 (i.e. 2-node) elements are used for simulating steel reinforcements and CFRP laminates. Since the
320 CFRP laminates are very thin, their bending is negligible compared to the axial component. This
321 makes it particularly suitable for simulation using 2-node elements showing only axial stiffness, i.e.,
322 standard truss elements – these are also used for modelling the strands and stirrups. The truss elements
323 are connected to the concrete elements using zero-thickness interface elements, which directly follow
324 the bond-slip law of the CFRP laminates. Further details can be found in (Dias-da-Costa et al. 2018b),
325 where focus was given to the modelling of concrete slabs strengthened with CFRP laminates and its
326 interaction with fracture. Interface elements are also adopted to model the bond behaviour of the
327 prestressed strands. The stirrups are modelled using the 2-node truss elements directly connected to
328 the concrete elements with 150 mm along the beam with the area of the two-legged arrangement
329 described earlier. Given that the stress state in the girder is mostly bidimensional for the structural
330 and loading schemes adopted, this assures that the confinement provided by the stirrups and resistance
331 against shear are adequately approximated.

332 The concrete is assumed elastoplastic under compression as defined in EN 1992-1-1 (2004). For
333 tension, embedded cracks are used to capture the non-linear effect using a bilinear softening law with
334 the fracture energy defined by CEB-FIP Model Code 1990 (1991). The prestressing strands and
335 stirrups are modelled considering the bilinear law defined in EN 1992-1-1 (2004) with the parameters
336 shown in Table 5, whereas the CFRP laminates are modelled with a linear elastic behaviour. Perfect
337 bond conditions are assumed between concrete and reinforcements, whereas the bond between CFRP
338 laminates and concrete is modelled using the simplified model proposed by Lu et al. (2005) – see
339 Appendix A for more details. The *automatic* method proposed by Graça-e-Costa et al. (2013) is used
340 to overcome convergence issues during the stages of concrete cracking and crushing, yielding of steel
341 reinforcements, and local debonding at CFRP laminates-concrete interfaces (Graça-e-Costa et al
342 2012; 2013).

343 It should be mentioned that two different procedures can be usually followed to simulate the forces
344 due to the pre-tensioning strands. The first option consists in applying a negative uniform temperature
345 variation to the pre-tensioning strands at day 5 corresponding to the opposite stretch that was applied
346 to the strands before casting, i.e. corresponding to 1,430 MPa. The second option available – which
347 was the one followed in this paper – directly applies the compressive force caused by the pre-
348 tensioning strand to the girder. These stresses are the same that appear when the pre-tensioning strand
349 is finally cut from the precast table. The initial tensile strain/stress in the pre-tensioning strands is
350 stored and considered when computing the total tensile stress at the strand. Naturally, the tensile stress
351 of the strand obtained just after releasing is lower than 1,430MPa, both numerically and
352 experimentally, due to the bending and axial shortening of the girder caused by compressive forces.
353 Figure 8 represents all forces applied to the girder – external load F and internal forces P_1 , P_2 and P_3
354 due to the strands. All material parameters adopted in the validation simulations are summarised in
355 Table 5.

356 Figure 9 shows a comparison between experimental and numerical results for both strengthened and
357 non-strengthened girders. The main stages related with the onset of cracking, the yielding of
358 prestressed reinforcement and concrete crushing are also represented. In summary, a good agreement
359 is observed between numerical and experimental data. In summary, a good agreement is observed
360 between numerical and experimental data. It should be mentioned that even though the numerical
361 model can simulate the global debonding of CFRP laminates accurately – see (Dias-da-Costa et al.
362 2018b) for a detailed validation of the model– this failure mode could not develop due to the material
363 properties of the cross-section and anchorage of the CFRP laminates. Therefore, the strengthened
364 girder fails with crushing of concrete after the yielding of prestressed tendons, thus confirming the
365 experimental findings. The crack pattern at failure is shown in Figure 10 for both strengthened and
366 non-strengthened models.

367 **Results and discussion**

368 *Reliability index and prestressing area before strengthening*

3693 Figure 11 shows the variation of the reliability index, β , with the area of pre-tensioning steel, A_p ,
6
9 b
370 based on RSA (1983) and EN1991-2 (2002) for the girders with strengthening laminates. In both
371 cases, the reliability index increases with the amount of uncorroded prestressing area in the girder.
372 For similar areas, the reliability values based on the former standard are significantly higher than the

373 ones obtained with the latter code, and in some cases this difference can reach more than 200% – e.g.

374 when the area of pre-tensioning steel is 1,652 mm². This difference is mainly related to the more
375 demanding traffic load requirements in the current standard. Reliability is strongly influenced by the
376 amount of prestressing area of the girder (Atadero and Karbhari 2008) and results show that
377 strengthening is required to reach the target reliability index defined in the new standard in all design
378 cases.

379 A sensitivity plot for both traffic load models is shown in Figure 12. The most influential variable is
3803 the traffic load, g_{tl} , followed by the load and resistance uncertainties, q_E and q_R . The dead loads,
8
0

381 g_{dl} , and the concrete self-weight, g_c , have a reduced influence in general, whereas the steel strand
382 strength, f_p , has a sensitivity factor close to 0.18. Despite the differences in traffic load models and
383 safety requirements, the cosines direction at design point are nearly the same in both standards.

384 *Sensitivity analysis and design point for the strengthened girders*

385 The area of the CFRP laminates calculated according to the procedure described previously is
386 summarised in Table 6. During the analyses, the possibility of the CFRP laminates debonding and
387 fracturing before concrete crushing and/or the yielding of the steel strands is properly accounted for.
388 All design cases require CFRP laminates to reach the target reliability index, with the flexural
389 capacity of the girders increasing up to 74% for the most degraded cases, B13-2D3, to restore the full
390 capacity according to the EN1991-2 (2002). The reference design case, i.e. the undamaged girder,
391 only requires an upgrade of a maximum of 25%, which directly reflects the increment due to the
392 provisions of the current standard.

393 The relative importance of the seven random variables considered in the reliability study is presented
394 in Figures 13a-c based on the cosines direction at design points in the normalised space. For each
395 random variable, the several scenarios of corroded pre-tensioning strands are considered. The
396 leftmost bar corresponds to the highest area of pre-tensioning steel and the rightmost bar to the lowest.
397 From these charts, it can be observed that traffic loads, g_{tl} , play a fundamental role in the analysis,
398 being always the most significant variable, in some cases reaching an importance of almost 0.80.

399 The load uncertainties also have an important weight in the analysis, ranging from 0.40 to 0.60. In
400 respect to the other loads, namely concrete self-weight, g_c , and dead loads, g_{dl} , both of them present
401 lower sensitivity factors, usually smaller than 0.15. On the other hand, the resistance parameter
402 showing the highest importance is the resistance uncertainty, q_R , presenting values around -0.40 for
403 all analyses. The steel strand strength, f_p , shows values of nearly -0.10 for bridges B13 and B19 and

404 can reach -0.20 for bridge B16. The CFRP laminates strength, f_f , exhibits values up to -0.30, assuming

405 greater importance than the steel strand strength in most analyses. This can be related to the loss of
406 pre-tensioning steel.

407 Table 7 shows the reliability index and design points used for the calibration of CFRP laminates
408 partial safety factors, i.e., the cases for which the area of CFRP laminates leads to values closest to
409 the target reliability index. Reliability indices are slightly higher than the target of 4.3. This occurs
410 because the numerical model is more accurate than the analytical model for simulating the structural
411 behaviour. However, it should be mentioned that the differences are in the order of 6%, meaning that
412 design using simplified models is safe for the calibration of partial safety factors for CFRP.

413 As expected, the design values in Table 7 show that the resistance variables, f_p, f_f and q_R are generally
414 lower than the corresponding mean values. The opposite trend is observed in the load variables, $g_c,$

4154 d_l, s_l and E . Traffic loads exhibit the higher deviation from the mean value, which shows the
1
5 g, g, q

416 importance they have for the calibration process.

417 *Calculation of partial safety factors*

418418

419419

420420

421 Table 8 presents the partial safety factors calculated for each model based on the characteristic value
422 for the distribution. The partial safety factors obtained for the CFRP laminates have an average of
423 1.16. This is consistent with the recommendations found in design guides. For instance, for the design
424 of concrete structures using CFRP end anchored laminates, CEB-FIB (2001) recommends the use of
425 a safety factor of 1.20, a value slightly higher than the one found in this paper. CNR (2001)
426 recommends a factor of 1.10 and TR-55 (2000) is more conservative, suggesting a factor of 1.54 for
427 the same type of strengthening.

428 **Conclusions**

429 This paper proposed a new hybrid procedure to perform reliability analyses efficiently combining
430 analytical and advanced non-linear FEM models to overcome the simplifications normally assumed
431 in reliability studies. The framework developed uses a discrete crack model to capture the interaction
432 between concrete cracks and local debonding of CFRP laminates and was applied to calibrate the
433 partial safety factor required for designing the strengthened PC girders.

434 The PC girders were taken from existing bridges built to connect small cities since the 1980s, with
435 spans ranging from 13 to 19 m, and originally designed with previous standards. Several corrosion
436 damage scenarios were considered when determining the area of CFRP laminates needed to restore
437 the structural capacity to current standards. The following conclusions are highlighted:

- 438 - the partial safety factor for designing strengthening of PC girders with CFRP laminates is in
439 the range of 1.16, and was observed not to change significantly with the span;
- 440 - the use of advanced non-linear models entails higher accuracy in the simulation of both
441 material and structural behaviour, particularly concerning the interaction of concrete cracking
442 with the local debonding of CFRP laminates. However, given that the differences relatively
443 to simplified analytical models were found to be in the range of 6%, the use of simplified
444 models for future studies targeting code calibration of partial safety factors for CFRP
445 laminates could be sufficient;
- 446 - the sensitivity analysis carried out shown the traffic loads and model uncertainties to be the
447 most significant parameters for the calibration process, assuming high values compared with
448 dead load, concrete self-weight and steel strand strength. Thus, it is important to assess the

449 model uncertainties for further reliability analysis, particularly in the case of more advanced
450 models now widely available.

451 It is worthwhile mentioning that the methodology presented in this paper is fully general and can
452 easily be adapted to different standards and geometries where the stress-state is predominantly two-
453 dimensional. The generalisation to three-dimensional structures, however, will require the
454 development of discrete crack models with more robust algorithms to be able to reliably track the
455 geometry of crack propagation, and therefore remain more precise than the uncertainty of the input
456 data.

457 **Acknowledgements**

458 S. Gomes acknowledges the financial support of the Portuguese Science and Technology Foundation
459 (FCT) through the Ph.D. grant number SFRH/BD/76345/2011. D. Dias-da-Costa would like to
460 acknowledge the support from the Australian Research Council through its Discovery Early Career
461 Researcher Award (DE150101703) and Linkage grant (LP140100591). This work was also supported
462 by FCT, within ISISE, project UID/ECI/04029/2013.

463 **Data Availability Statement**

464 Some or all data, models, or code generated or used during the study are available from the
465 corresponding author by request.

466

467 **Appendix A - Adopted bond-slip law**

468 Lu et al. (2005) model, which is adopted as FRP-to-concrete bond-slip law in this paper, is defined
 469 by the following equations:

$$470 \quad \tau = \tau_{max} \sqrt{\frac{s}{s_0}} \quad \text{if } s \leq s_0, \quad \text{B-1}$$

$$471 \quad \tau = \tau_{max} e^{-\frac{\alpha s}{\tau_{max} s_0} - \frac{\beta}{\tau_{max} s_0}} \quad \text{if } s > s_0, \quad \text{B-2}$$

472 with

$$473 \quad s_0 = 0.0195 b_w f_t, \quad \text{B-3}$$

$$474 \quad \tau_{max} = a_1 b_w f_t, \quad \text{B-4}$$

$$475 \quad a = \frac{1}{\frac{G_f}{\tau_{max} s_0} - \frac{2}{3}}, \quad \text{B-5}$$

$$476 \quad b_w = \frac{2.25 - b_f / b_c}{1.25 + b_f / b_c}, \quad \text{B-6}$$

$$477 \quad G_f = 0.309 b_w^2 \sqrt{f_t}, \quad \text{B-7}$$

478 where τ_{max} is the maximum local bond stress, s is the local slip, s_0 is the local slip at τ_{max} , f_t is the
 479 concrete tensile strength, b_c and b_f are, respectively, the widths of concrete prism and FRP plate, and
 480 G_f is the interfacial fracture energy.

481

482 References

- 483 AASHTO (American Association of State Highway and Transportation Officials). (2012). "Guide
484 Specifications for Design of Bonded FRP Systems for Repair and Strengthening of Concrete Bridge
485 Elements." AASHTO (2012), Washington, DC.
- 486 ACI (American Concrete Institute). (2008). "Guide for the design and construction of externally bonded FRP
487 system for strengthening concrete structures." ACI 440.2R-08, Michigan.
- 488 Ang, A. and Tang, W. (2007). "Probability concepts in engineering: Emphasis on applications in civil &
489 environmental engineering." 2nd Edition, John Wiley & Sons, Chichester.
- 490 Atadero, R. A. and Karbhari, V. M. (2008). "Calibration of resistance factors for reliability based design of
491 externally-bonded FRP composites." *Composites Part B: Engineering*, 39(4), 665-79. doi:
492 10.1016/j.compositesb.2007.06.004.
- 493 Baji, H. (2017). "Calibration of the FRP Resistance Reduction Factor for FRP-Confined Reinforced Concrete
494 Building Columns." *Journal of Composites for Construction*, 21(3), 04016107.
495 doi: 10.1016/j.compstruct.2016.07.003.
- 496 Bucher, C. (2009). "Computational Analysis of Randomness in Structural Mechanics: Structures and
497 Infrastructures Book Series, volume 3." CRC Press, London.
- 498 CEB-FIB (Comité euro-international du béton). (2001). "Externally bonded FRP reinforcement for RC
499 structures.", fib Bulletin No. 14, Geneva, Switzerland.
- 500 CEB-FIP (Comité euro-international du béton). (1991). "CEB-FIP Model Code 1990 : Design Code". Thomas
501 Telford Services Ltd, London.
- 502 CEN (European Committee for Standardization). (2002). "Eurocode 1: Actions on structures- Part 2: Traffic
503 loads on bridges.", EN1991-2, Brussels.
- 504 CEN (European Committee for Standardization). (2005). "Eurocode 2: Design of concrete structures.
505 Concrete bridges - design and detailing rules." EN1992-2, Brussels.
- 506 CEN (European Committee for Standardization). (2002). "Eurocode 0: Basis of structural design." EN 1990,
507 Brussels.
- 508 CEN (European Committee for Standardization). (2004). "Eurocode 2: design of concrete structures, Part 1-
509 1: General rules and rules for buildings." EN 1992-1-1, Brussels.
- 510 CNR. (2001). "Guide for the design and construction of externally bonded FRP systems for strengthening
511 existing structures." National Research Council, Advisory Committee on Technical
512 Recommendations for Construction, Rome, Italy.
- 513 Coelho, M., Neves, L. and Sena-Cruz, J. (2018). "Designing NSM FRP systems in concrete using partial safety
514 factors." *Composites Part B: Engineering*, 139, 12-23. doi: 10.1016/j.compositesb.2017.11.031.
- 515 Dias-da-Costa, D., Alfaiate, J., Sluys, L. J., Areias, P. and Júlio, E. N. B. S. (2013). "An embedded formulation
516 with conforming finite elements to capture strong discontinuities." *International Journal For
517 Numerical Methods In Engineering*, 93(2), 224-44. doi: 10.1002/nme.4393.
- 518 Dias-da-Costa, D., Alfaiate, J., Sluys, L. J. and Júlio, E. (2009). "A discrete strong discontinuity approach."
519 *Engineering Fracture Mechanics*, 76(9), 1176-201. doi: 10.1016/j.engfracmech.2009.01.011.
- 520 Dias-da-Costa, D., Alfaiate, J., Sluys, L. J. and Júlio, E. N. B. S. (2010). "A comparative study on the modelling
521 of discontinuous fracture by means of enriched nodal and element techniques and interface elements."
522 *International Journal of Fracture*, 161(1), 97-119. doi: 10.1007/s10704-009-9432-6.
- 523 Dias-da-Costa, D., Cervenka, V. and Graça-e-Costa, R. (2018a). "Model uncertainty in discrete and smeared
524 crack prediction in RC beams under flexural loads." *Engineering Fracture Mechanics*, 199, 532-43.
525 doi: 10.1016/j.engfracmech.2018.06.006.

- 526 Dias-da-Costa, D., Graça-e-Costa, R., Ranzi, G. and Smith, S. T. (2018b). "Assessment of the Behavior of
527 FRP-Strengthened RC Slabs Using a Discrete Crack Model." *Journal of Composites for Construction*,
528 22(6), 1–14. doi: 10.1061/(ASCE)CC.1943-5614.0000881.
- 529 Dias-da-Costa, D., N. F. do Carmo, R. and Graça-e-Costa, R. (2017). "Numerical modeling of concrete beams
530 under serviceability conditions with a discrete crack approach and noniterative solution-finding
531 algorithms." *Structural Concrete*, 18(1), 225-36. doi: 10.1002/suco.201600130.
- 532 El-Tawil, S. and Okeil, A. M. (2002). "LRFD flexural provisions for prestressed concrete bridge girders
533 strengthened with carbon fiber-reinforced polymer laminates." *ACI Structural Journal*, 99(2), 181-90.
- 534 Fernandes, P. 2007, "Vigas de Grande Vão Prefabricadas em Betão de Alta Resistência Pré-Esforçado [Precast
535 prestressed high-strengt concrete girders with long-span girders]". Ph.D. thesis, Department of Civil
536 Engineering, University of Coimbra.
- 537 Fernandes, P., Sena-Cruz, J., Fernandes, C., Silva, P., Dias-da-Costa, D. and Júlio, E. (2013). "Flexural
538 response of HSC girders strengthened with non- and prestressed CFRP laminates." In Proc. FRPRCS-
539 11. Guimarães, Portugal.
- 540 FERUM (2010). "*Finite element reliability using matlab*." <http://www.ifma.fr/FERUM>.
- 541 Garden, H. N. and Hollaway, L. C. (1998). "An experimental study of the failure modes of reinforced concrete
542 beams strengthened with prestressed carbon composite plates." *Composites Part B: Engineering*,
543 29(4), 411-24. doi: 10.1016/S1359-8368(97)00043-7.
- 544 Gomes, S., Dias-da-Costa, D., Neves, L. A. C., Hadigheh, S. A., Fernandes, P. and Júlio, E. (2018).
545 "Probabilistic-based characterisation of the mechanical properties of CFRP laminates." *Construction*
546 *and Building Materials*, 169, 132-41. doi: 10.1016/j.conbuildmat.2018.02.190.
- 547 Gomes, S., Neves, L., Dias-da-Costa, D., Fernandes, P. and Júlio, E. (2014). "Probabilistic Analysis of High
548 Strength Concrete Girders Strengthened with CFRP". *Vulnerability, Uncertainty, and Risk:*
549 *Quantification, Mitigation, and Management*, 1274–82, United Kingdom. doi:
550 10.1061/9780784413609.128.
- 551 Graça-e-Costa, R., Alfaiate, J., Dias-da-Costa, D., Neto, P. and Sluys, L. J. (2013). "Generalisation of non-
552 iterative methods for the modelling of structures under non-proportional loading." *International*
553 *Journal of Fracture*, 182(1), 21-38.
- 554 Graça-e-Costa, R., Alfaiate, J., Dias-da-Costa, D. and Sluys, L. J. (2012). "A non-iterative approach for the
555 modelling of quasi-brittle materials." *International Journal of Fracture*, 178(1), 281-98. doi:
556 10.1007/s10704-012-9768-1.
- 557 ISIS (2001). "*Strengthening reinforced concrete structures with externally-bonded fibre reinforced polymers*",
558 Design Manual No. 4, ISIS Canada Corporation, The Canadian Network of Centres of Excellence on
559 Intelligent Sensing for Innovative Structures, Winnipeg, Manitoba, Canada.
- 560 Jacinto, L., Pipa, M., Neves, L. A. C. and Santos, L. O. (2012). "Probabilistic models for mechanical properties
561 of prestressing strands." *Construction and Building Materials*, 36, 84-9. doi:
562 10.1016/j.conbuildmat.2012.04.121.
- 563 Joint Committee on Structural Safety (JCSS). (2001). "*Probabilistic Model Code*". 12th Draft <
564 https://www.jcss.byg.dtu.dk/Publications/Probabilistic_Model_Code > (28 Jan 2018)
- 565 Japanese Society of Civil Engineers (JSCE). (2001). "*Recommendations for upgrading of concrete structures*
566 *with use of continuous fiber sheets - Concrete Series No. 41*.", Tokyo, Japan.
- 567 Lu, X. Z., Teng, J. G., Ye, L. P. and Jiang, J. J. (2005). "Bond–slip models for FRP sheets/plates bonded to
568 concrete." *Engineering Structures*, 27(6), 920-37. doi: 10.1016/j.engstruct.2005.01.014.
- 569 Melchers, R. E. (2017). "*Structural reliability analysis and prediction, 3rd edition*." Wiley.
- 570 Ministério da Habitação, Obras Públicas e Transportes. (1983). "*Regulamento de estruturas de betão armado*
571 *e pré-esforçado [Reinforced and prestressed concrete structures standard]*." REBAP DL no. 349-
572 C/83, Lisbon, Portugal.

- 573 Ministério da Habitação, Obras Públicas e Transportes. (1983). "*Regulamento de segurança e acções para*
574 *estruturas de edifícios e pontes [Buildings and bridges load and safety standard].*" RSA DL no. 235/83
575 31st May, Lisbon, Portugal.
- 576 Monti, G. and Santini, S. (2002). "Reliability-based Calibration of Partial Safety Coefficients for Fiber-
577 Reinforced Plastic." *Journal of Composites for Construction*, 6(3), 162-7. doi: 10.1061/(ASCE)1090-
578 0268(2002)6:3(162).
- 579 Okeil, A. M., El-Tawil, S. and Shahawy, M. (2002). "Flexural reliability of reinforced concrete bridge girders
580 strengthened with carbon fiber-reinforced polymer laminates." *Journal of Bridge Engineering*, 7(5),
581 290-9. doi: 10.1061/(ASCE)1084-0702(2002)7:5(290).
- 582 Pham, H. B. and Al-Mahaidi, R. (2008). "Reliability analysis of bridge beams retrofitted with fibre reinforced
583 polymers." *Composite Structures*, 82(2), 177-84. doi: 10.1016/j.compstruct.2006.12.010.
- 584 Plevris, N., Triantafillou, T. C. and Veneziano, D. (1995). "Reliability of RC members strengthened with CFRP
585 laminates." *Journal of Structural Engineering*, 121(7), 1037-44. doi: 10.1061/(ASCE)0733-
586 9445(1995)121:7(1037).
- 587 Quantrill, R. J. and Hollaway, L. C. (1998). "The flexural rehabilitation of reinforced concrete beams by the
588 use of prestressed advanced composite plates." *Composites Science and Technology*, 58(8), 1259-75.
589 doi: 10.1016/S0266-3538(98)00002-5,
- 590 Standards Australia. "*Bridge design- Part 8: Rehabilitation and strengthening of existing bridges.*" AS 5100.8
591 (2017), Sydney, Australia.
- 592 TR-55 (2000). "*Design guidance for strengthening concrete structures using fibre composite materials.*" The
593 Concrete Society, Crowthorne, Berkshire.
- 594 Schneider, J. (1997). "*Introduction to safety and reliability of structures.*" International Association for Bridge
595 and Structural Engineering, Zurich, Switzerland.
- 596 von Scholten, C. and Vejdirektoratet, D. (2004). "*Reliability-based classification of the load carrying capacity*
597 *of existing bridges.*" The Directorate, Denmark.
- 598 Wisniewski, D. F. (2007). "Safety Formats for the Assessment of Concrete Bridges." PhD thesis, Universidade
599 do Minho, Portugal."
- 600600
- 601601

602 **Figures caption list**

603 Figure 1. Cross-section and details of the exterior girder (dimensions are in meters if not stated
6046 otherwise).

0
4 Figure 2. (a) Joint density function $f_{R,S}(r,s)$ of two random variables with marginal density

6056
0
5

6066 functions f_r and f_s ; (b) Reliability index and design point in the standard space, assuming a linear
0
6

607 limit state function and two random variables u_1 and u_2 ; and (c) cosines direction \mathbf{a} at design point
608 u^* . Figure adapted from Schneider (1997).

609 Figure 3. Flowchart showing both stages of analysis and iterative cycles.

610 Figure 4. Stress-strain diagram for cross-sectional analysis of PC girders.

611 Figure 5. (a) Finite elements with embedded cracks. (b) Interaction between FRP and cracks in the
612 scope of discrete and smeared models.

613 Figure 6. Loading scheme and cross-section of the girder: (a) side view (dimensions in m); and (b)
614 cross-section (dimensions in mm unless stated otherwise).

615 Figure 7. Tested PC girder: (a) control, and (b) CFRP-strengthened girders.

616 Figure 8. Mesh used in finite element analysis including loading and boundary conditions.

617 Figure 9. Load-displacement curves for: (a) non-strengthened; and (b) CFRP-strengthened girders.

618 Figure 10. Detail of the deformed shape and crack pattern at failure: (a) identification of the detailed
619 region; (b) non-strengthened; and (c) CFRP-strengthened girders. Note: for illustration purpose crack
620 widths are magnified by a factor of 20 and only widths above 0.25 mm are shown.

621 Figure 11. Reliability index as a function of the area of the pre-tensioning steel in non-strengthened
622 girders according to: (a) RSA (1983); and (b) EN1991-2 (2002)

623 Figure 12. Cosines direction at design point.

624 Figure 13. Cosines direction at design point as a function of the pre-tensioning steel (a) B13, (b) B16,
6256 and (c) B19.
2
5
6266
2
6

627 Table list

6286 Table 1. Summary of safety and reduction factors, respectively g_f and \bar{r}_f .

2
8

Design guideline	Safety/Reduction factor
CEB-FIB (2001)	$g_f = 1.20$ to 1.35
CNR (2001)	$g_f = 1.10$ to 1.50
TR-55 (2000)	$g_f = 1.10$ to 3.50
JSCE (2001)	$g_f = 1.20$ to 1.30
ACI 440.2R-08 (2008)	$\bar{r}_f = 0.85$ to 0.95
AASHTO (2012)	$\bar{r}_f = 0.85$
ISIS (2001)	$\bar{r}_f = 0.75$
AS 5100.8 (2017)	$\bar{r}_f = 0.65$ to 0.80

629629

630630

631631

632632

6336 Table 2. Geometry of the bridge girders considered in the study.

3

3

Bridge	h	b	b_w	Span (m)
B13	0.6	0.4	0.15	13
B16	0.9	0.6	0.2	16
B19	1.2	0.6	0.2	19

6346

3

4

6356

3

5

636636

637637

638

Table 3. Cases of structural deterioration.

<u>Case</u>	<u>% of loss</u>	<u>A_p (mm²)</u>
D0	0	2,240
D1	10	2,142
D2	20	2,044
D3	30	1,946
2D1	2 ' 10	2,044
2D2	2 ' 20	1,848
2D3	2 ' 30	1,652

639639

640640

641641

642 Table 4. Statistical properties for the random parameters.

Variable	Mean	Standard deviation	COV	Distribution type
Steel strand strength, f_p (MPa)	1674	50	0.03	Normal
CFRP strength f_t (MPa)	2686	215	0.08	Weibull
Resistance model uncertainties, q_R	1.0	0.13	0.13	Log-normal
Traffic loads, g_{it}	0.78	0.12	0.15	Gumbel
Dead loads, g_{dl} (kN/m)	10.83	1.08	0.10	Normal
Concrete self-weight, g_c (kN/m ³)	25.0	1.0	0.04	Normal
Load model uncertainties, q_E	1.05	0.11	0.10	Log-normal

643643

644644

645645

646646

647

Table 5. Main material parameters for the validation models.

	Parameter	Value
Concrete	Compressive strength	120 MPa
	Tensile strength	5.5 MPa
	Young's modulus	59 GPa
	Fracture energy	0.2 N/mm
Prestressing steel	0.1% proof-stress	1,640 MPa
	Young's modulus	200 GPa
Steel Reinforcement	Tensile strength	500 MPa
	Young's modulus	200 GPa
CFRP	Ultimate strength	2,300 MPa
	Young's modulus	165 GPa

6486

4

8

6496

4

9

Table 6. Summary of bridges used for calibration.

Bridge	% steel loss	A_p (mm ²)	A_f (mm ²)	Flexural resistance (kNm)	
				Initial	Strengthened
B13	0	2,240	477	2,352	2,902
B13-D1	10	2,142	531	2,239	2,904
B13-D2	20	2,044	586	2,125	2,908
B13-D3	30	1,946	641	2,011	2,914
B13-2D1	2'10	2,044	586	2,135	2,908
B13-2D2	2'20	1,848	688	1,916	2,922
B13-2D3	2'30	1,652	781	1,696	2,945
B16	0	2,240	453	3,336	4,181
B16-D1	10	2,142	508	3,174	4,186
B16-D2	20	2,044	570	3,011	4,194
B16-D3	30	1,946	625	2,849	4,202
B16-2D1	2'10	2,044	563	3,021	4,193
B16-2D2	2'20	1,848	672	2,704	4,213
B16-2D3	2'30	1,652	781	2,385	4,254
B19	0	2,240	445	4,354	5,446
B19-D1	10	2,142	508	4,140	5,453
B19-D2	20	2,044	563	3,926	5,463
B19-D3	30	1,946	625	3,712	5,478
B19-2D1	2'10	2,044	563	3,936	5,441
B19-2D2	2'20	1,848	680	3,518	5,472
B19-2D3	2'30	1,652	789	3,097	5,533

654

655

Table 7. Reliability index and design points used for calibration.

Bridge	b	f_p^* MPa	f_f^* MPa	g_c^* kN/m ³	g_{dl}^* kN/m	g_{tl}^*	q_R^*	q_E^*
B13	4.36	1,652	2,640	25.4	11.2	1.41	0.78	1.29
B13-D1	4.38	1,666	2,676	25.0	11.2	1.48	0.77	1.25
B13-D2	4.35	1,648	2,539	25.0	10.6	1.42	0.78	1.27
B13-D3	4.41	1,649	2,512	25.3	10.6	1.42	0.78	1.28
B13-2D1	4.32	1,653	2,471	24.9	11.0	1.42	0.78	1.24
B13-2D2	4.33	1,644	2,398	25.1	11.1	1.32	0.80	1.29
B13-2D3	4.34	1,651	2,405	25.1	10.3	1.28	0.80	1.34
B16	4.43	1,649	2,679	25.1	11.3	1.51	0.77	1.23
B16-D1	4.47	1,627	2,585	25.5	11.4	1.30	0.80	1.36
B16-D2	4.57	1,656	2,445	25.3	11.6	1.30	0.80	1.38
B16-D3	4.65	1,615	2,421	24.6	10.6	1.32	0.79	1.35
B16-2D1	4.44	1,628	2,484	25.2	11.0	1.33	0.79	1.33
B16-2D2	4.62	1,672	2,512	25.1	10.8	1.49	0.77	1.27
B16-2D3	4.42	1,641	2,524	25.4	10.8	1.41	0.78	1.29
B19	4.58	1,649	2,752	24.9	11.1	1.48	0.77	1.30
B19-D1	4.45	1,658	2,561	26.0	11.9	1.31	0.80	1.34
B19-D2	4.45	1,657	2,493	25.3	11.7	1.48	0.77	1.21
B19-D3	4.57	1,649	2,492	25.2	10.9	1.38	0.79	1.35
B19-2D1	4.53	1,656	2,568	25.3	11.0	1.42	0.78	1.33
B19-2D2	4.53	1,660	2,513	25.3	11.3	1.42	0.78	1.31
B19-2D3	4.48	1,650	2,521	25.7	10.6	1.47	0.77	1.24

656

657

658

659

660

Table 8. Partial safety factors for CFRP.

Bridge	g_f	Bridge	g_f	Bridge	g_f
B13	1.12	B16	1.12	B19	1.09
B13-D1	1.12	B16-D1	1.12	B19-D1	1.13
B13-D2	1.16	B16-D2	1.18	B19-D2	1.20
B13-D3	1.17	B16-D3	1.20	B19-D3	1.18
B13-2D1	1.19	B16-2D1	1.18	B19-2D1	1.15
B13-2D2	1.21	B16-2D2	1.18	B19-2D2	1.18
B13-2D3	1.19	B16-2D3	1.17	B19-2D3	1.18

661

662

663

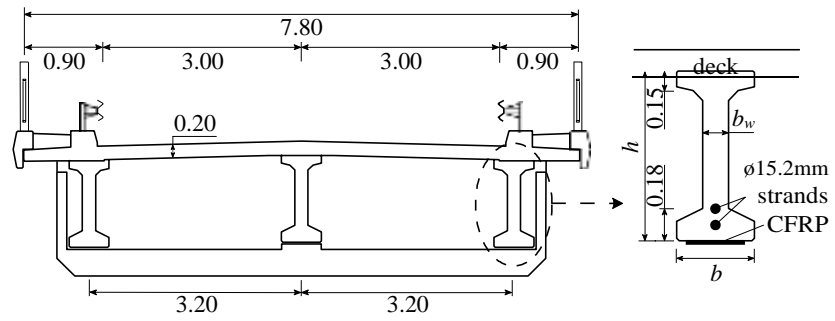

Figure 1. Cross-section and details of the exterior girder (dimensions are in meters if not stated otherwise).

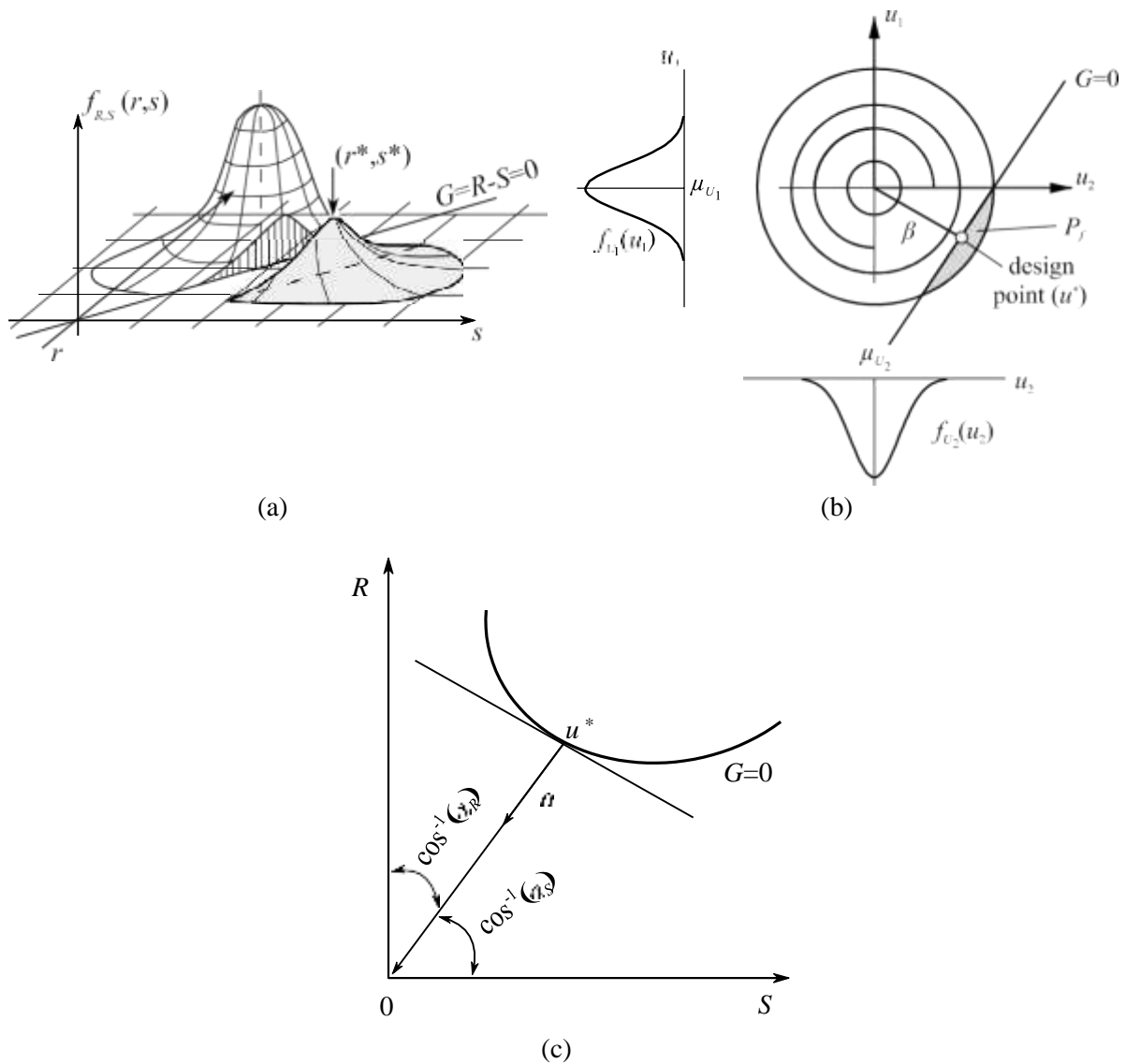

Figure 2. (a) Joint density function $f_{R,S}(r,s)$ of two random variables with marginal density functions f_r and f_s ; (b) Reliability index and design point in the standard space, assuming a linear limit state function and two random variables u_1 and u_2 ; and (c) cosines direction α at design point u^* . Figure adapted from Schneider (1997).

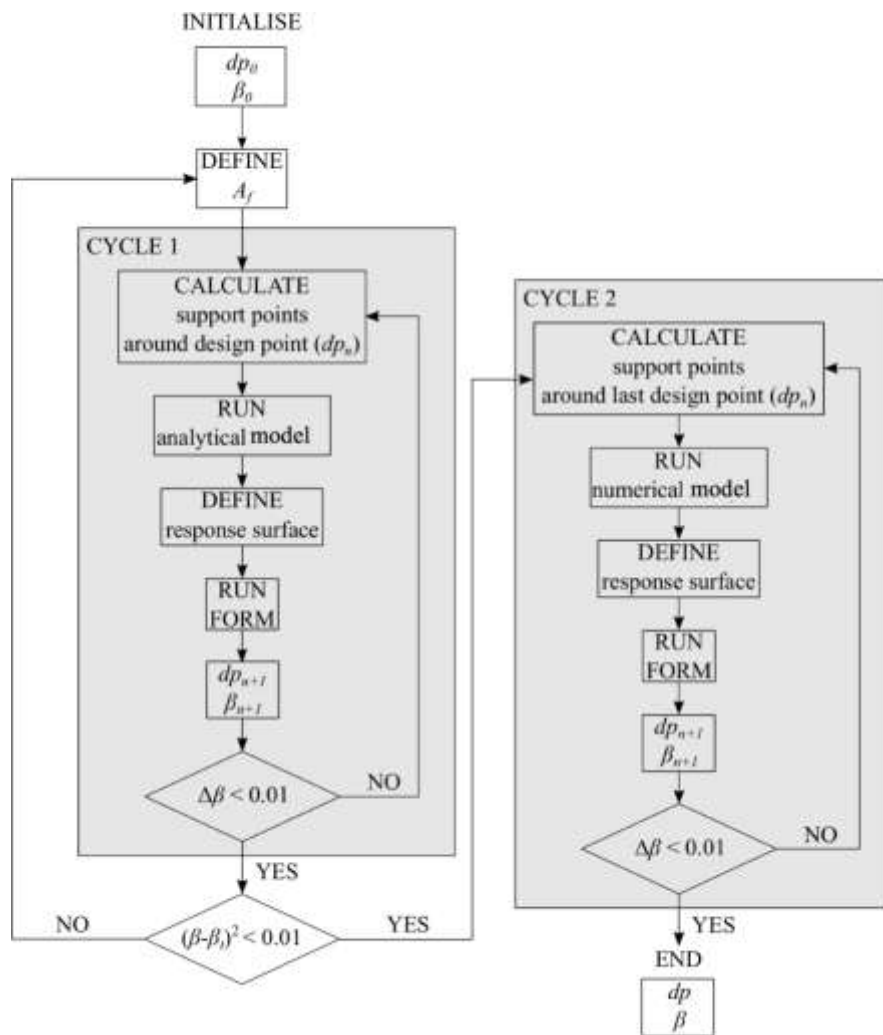

Figure 3. Flowchart showing both stages of analysis and iterative cycles.

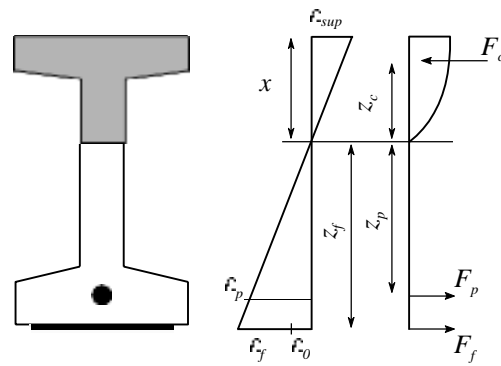

Figure 4. Stress-strain diagram for cross-sectional analysis of PC girders.

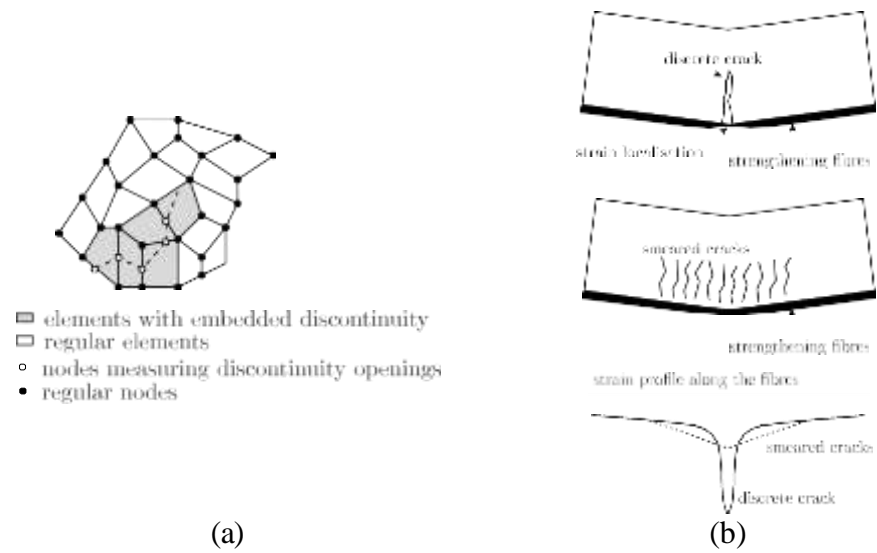
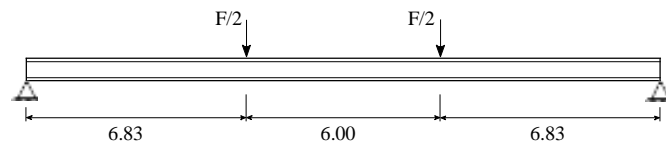
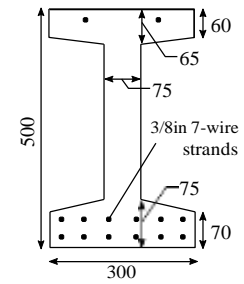

Figure 5. (a) Finite elements with embedded cracks. (b) Interaction between FRP and cracks in the scope of discrete and smeared models.



(a)



(b)

Figure 6. Loading scheme and cross-section of the girder: (a) side view (dimensions in m); and (b) cross-section (dimensions in mm unless stated otherwise).



(a)



(b)

Figure 7. Tested PC girder: (a) control, and (b) CFRP-strengthened girders.

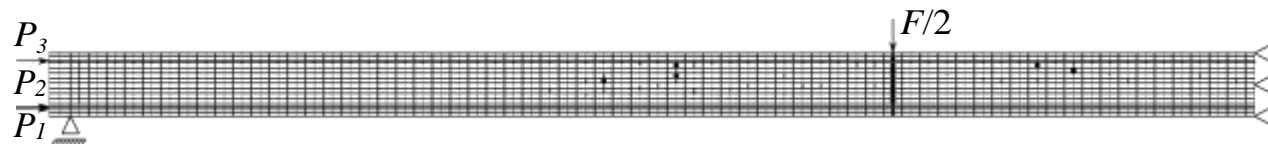
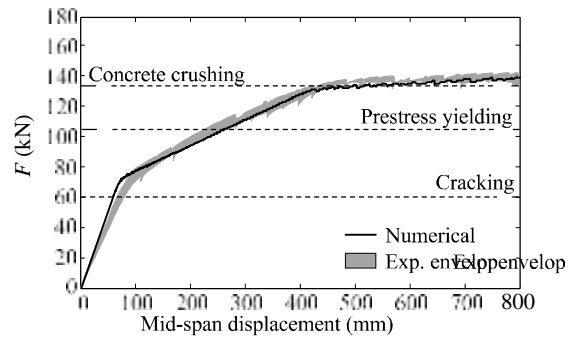
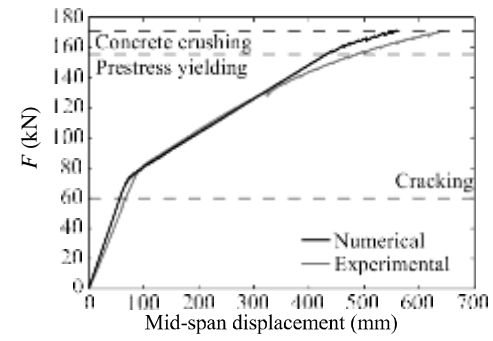

Figure 8. Mesh used in finite element analysis including loading and boundary conditions.



(a)



(b)

Figure 9. Load-displacement curves for: (a) non-strengthened; and (b) CFRP-strengthened girders.

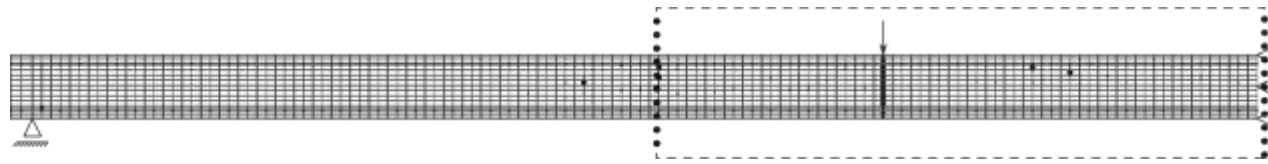

(a)

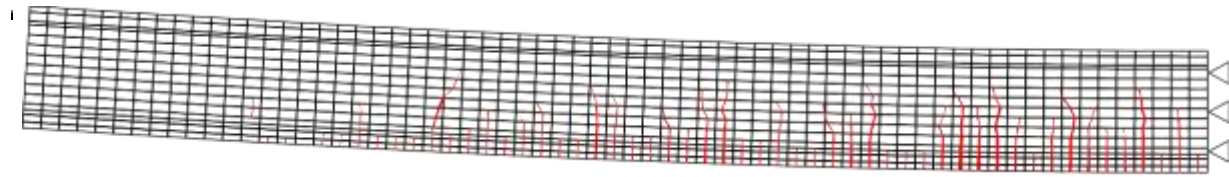

(b)

(b)

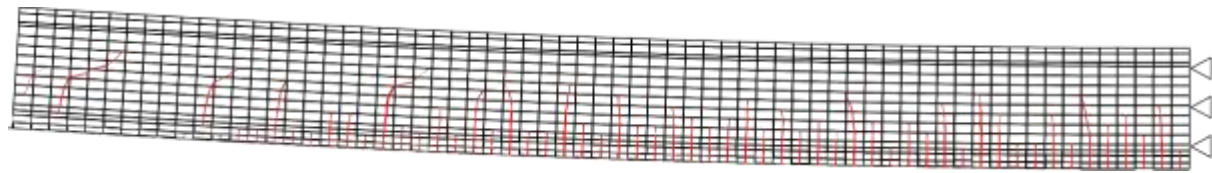

(c)

(c)

Figure 10. Detail of the deformed shape and crack pattern at failure: (a) identification of the detailed region; (b) non-strengthened; and (c) CFRP-strengthened girders. Note: for illustration purpose crack widths are magnified by a factor of 20 and only widths above 0.25 mm are shown.

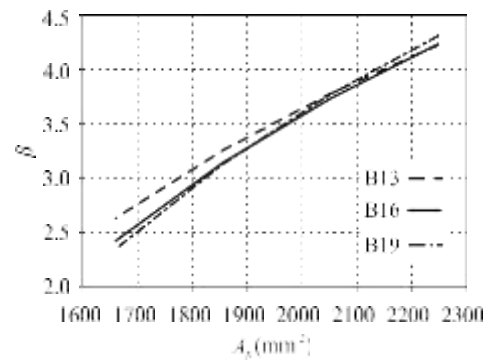

(a)

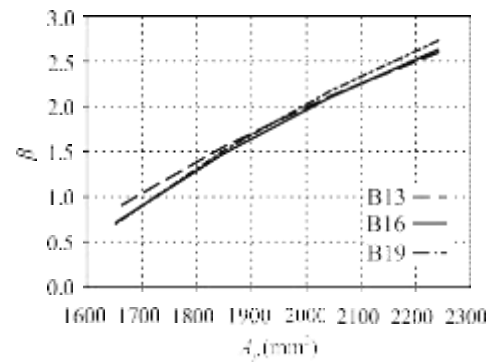

(b)

Figure 11. Reliability index as a function of the area of the pre-tensioning steel in non-strengthened girders according to: (a) RSA (1983); and (b) EN1991-2 (2002)

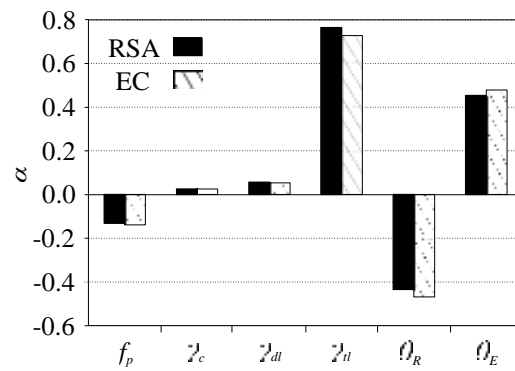
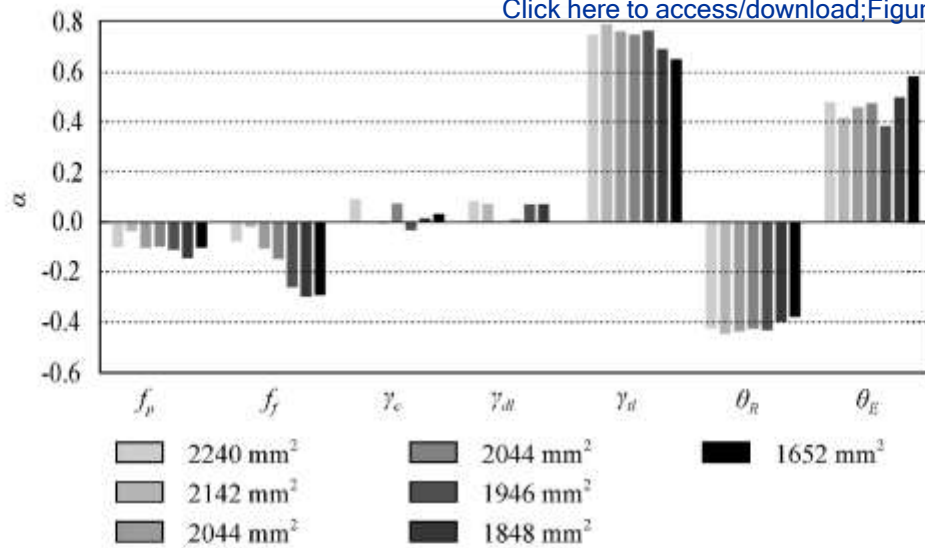

Figure 12. Cosines direction at design point.

Figure 13

[Click here to access/download:Figure;Fig13.pdf](#)



(a)

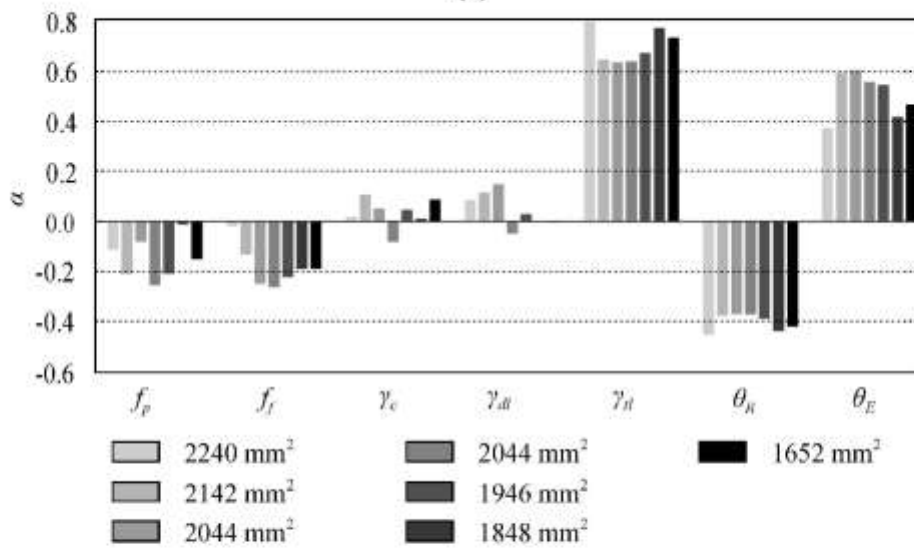

(b)

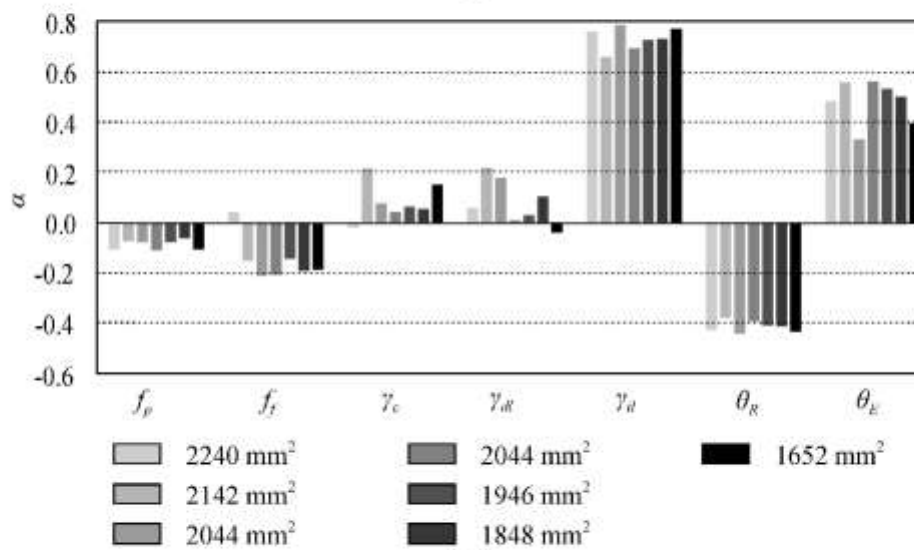

(c)

Figure 13.. Cosines direction at design point as a function of the pre-tensioning steel (a) B13, (b) B16, and (c) B19.