

Tracking Control of High Order Input Reference Using Integrals State Feedback and Coefficient Diagram Method Tuning

by Alfian Ma'arif

Submission date: 11-Feb-2022 11:48AM (UTC+0700)

Submission ID: 1759832314

File name: tegrals_State_Feedback_and_Coefficient_Diagram_Method_Tuning.pdf (4.23M)

Word count: 6753

Character count: 33389

10

Received September 12, 2020, accepted September 25, 2020, date of publication October 6, 2020, date of current version October 16, 2020.

Digital Object Identifier 10.1109/ACCESS.2020.3029115

Tracking Control of High Order Input Reference Using Integrals State Feedback and Coefficient Diagram Method Tuning

ALFIAN MA'ARIF¹, (Member, IEEE), ADHA IMAM CAHYADI², SAMIADJI HERDJUNANTO², AND OYAS WAHYUNGGORO²

¹Department of Electrical Engineering, Universitas Ahmad Dahlan, Yogyakarta 55191, Indonesia

²Department of Electrical Engineering, Universitas Gadjah Mada, Yogyakarta 55281, Indonesia

Corresponding author: Alfian Ma'arif (alfianmaarif@ee.uad.ac.id)

This work was supported in part by the Universitas Ahmad Dahlan Grant.

ABSTRACT The purpose of the research is tracking control to follow the input reference signal such as step, ramp, parabolic, and high order reference stably. The challenge is rising when high order input references, such as parabolic or polynomial, are used in the advanced system. Like in satellite and missile launcher systems, the triple integrator systems have to follow parabolic or polynomial trajectory with high stability required. The research proposed an integrals state feedback controller to combine simple state feedback control with cascade-layered integral control. The order of the input reference defines the structure and number of integrals used. Along Coefficient Diagram Method in its tuning process, the proposed controller guaranteed to have good stability and zero steady-state error. Simulation results and mathematical proofs of stability and zero steady-state error are provided on the paper. The proposed method can follow various input references such as the ramp, parabolic, polynomial, and higher-order reference based on the simulation and mathematical proofs. The stability using the pole location also shown the negative poles that give a stable system.

INDEX TERMS Integrals control, state feedback, tracking control, input reference, coefficient diagram.

I. INTRODUCTION

The goal of tracking control is to follow any kind of reference signal. There are some reference signals such as impulse [1], [2], step [3], [4], ramp [5], parabolic [6], [7], parabola [8], periodic [9], sine [10], pulse [1], [11], and random [1], which commonly used in control, robotic and industrial systems as input reference. There are also less popular polynomial references, such as third-order polynomial reference, fourth-order polynomial reference, and higher-order reference (HOR), which are used in the trajectory system or more complex and advanced systems.

Some researches about tracking control of step, ramp, and parabolic signals have been done. Some control techniques have been proposed, such as the Servo System with Polynomial Differential Operator [12], Coefficient Diagram Controller [13], State Feedback with One and a Half Integrator [14], Proportional Integral Derivative (PID) Controller [15], Type III PID Controller [16], [17], Fuzzy

Controller [18], nonlinear tracking control [19] and backstepping [20]. However, those researches have not been evaluated for input signal tracking with higher reference order than the parabolic signal. Therefore, this research proposes a new control approach to track high order input references.

In tracking control, it is essential to track the reference stably, especially polynomial ones. As mentioned earlier, some polynomial references with higher-order are used in complex and advanced systems. For example, a satellite system has a parabolic orbit trajectory. Hence, it needs a stable and robust parabolic tracking controller. In other cases, a missile acceleration has polynomial reference to track and follow a target in the missile launcher system. Both satellite and missile launcher systems can be seen as triple integrator systems and belong to high order systems [21].

Some previous research had been done to track time-varying signal, which is another term of polynomial input references for specific control purposes: i.e., fault-tolerant tracking [22], asymptotic tracking [23], and fixed-time tracking [24]. However, based on the literature review, there has been no tracking control study for the triple integrator system

13

The associate editor coordinating the review of this manuscript and approving it for publication was Jun Shen.

to date. Besides, most proposed controllers can be suitable only for specific goals with complex calculations or structure design.

Some common and simpler controllers, such as conventional PID and fuzzy controllers, are not suitable to be applied. The PID controller may be able to stabilize those high order systems (integrating system) [25] and high order input reference [26], but it has bad transient system performance. In other words, it cannot track the reference stably. Meanwhile, a fuzzy controller design takes a lot of effort and experimental data. It will be more confusing to tune the fuzzy parameters [18], [27]. Moreover, the fuzzy controller cannot guarantee that the augmented system will result in good performance and stability [28]. Thus, it is inadequate to use those common controllers in tracking control of triple integrator systems.

This research proposes to solve this problem by using a state feedback controller combined with the integral control. Both methods are already proposed for tracking control separately, with their respective pros and cons [29]. In this paper, the proposed integral control design has some layers in the structure, like a cascade. The cascade is based on the order of the input references used for tracking.

The structure design of the controller is crucial for tracking control. However, state feedback and integral gains also need to be determined carefully to guarantee good system performances. The controller needs to be easy to design in any kind of reference used in the system with stable and accurate tracking. Some methods that may solve this tuning problem are pole placement [30], pole assignment [31], Linear Quadratic Regulator (LQR) [32], [33], metaheuristics algorithm [34], Linear Matrix Inequalities (LMI) [35] and Coefficient Diagram Method (CDM) [36], [37]. The only method among those previously mentioned methods which has standard parameters as a tuning method is CDM. It can avoid the trial and error of the tuning process. Hence, the effort and time consumed in tuning the controller parameters can be efficient [38]. Thus, this research uses the coefficient diagram method as the tuning method for state feedback and integral gains needed in the controller design.

The structure of the research will be briefly explained follows. The first section is the introduction. The next section is the Input Reference that discusses the kind of input reference signal. The third section is the integrals state feedback design for high order input reference. Then, the next section discusses the theory of the coefficient diagram method. Later, the Ackermann formula used in the coefficient diagram method is explained in the next section. The fifth is about the steady-state error that discusses the final value theorem and input substitution. The sixth section is the results and discussions. The last part is the conclusion and future work.

II. INPUT REFERENCE

There are many kinds of input reference signals. They can be seen in Table 1. Some others that are not listed in the table are pulse, sine, parabola, periodic, impulse, and random signal.

TABLE 1. High Order Input Reference Signals

Order Reference (<i>i</i>)	Input Reference	Time	Integral (<i>i</i>)
0	Step	t^0	1
1	Ramp	t^1	2
2	Parabolic	t^2	3
3	Polynomial 3-order	t^3	4
4	Polynomial 4-order	t^4	5
⋮	⋮	⋮	⋮
<i>i</i>	Polynomial <i>i</i> -order	t^{i-1}	<i>i</i>

Pulse and random signals can be described as 'series' of step units. Hence they can be categorized into step reference. Meanwhile, the parabola, periodic, sine wave signals can be seen as the parabolic equation so that it belongs to the third order of input reference. The impulse signal is a special case because its order is lower than the step signal, but it still requires one integral in the control structure.

Table 1 also shows the order of time and reference for each signal. The step input reference signal is a first-order reference signal and has a zero level time order. A control system requires one integrator to stabilize the step reference input signal. In contrast, the ramp signal is a second-order reference signal and has a level one-time order. The control system requires two integrators to stabilize it. Likewise, the pattern continues for reference signals with higher order.

The basic idea of the design is the increase in the reference signal's order also increases the reference signal's order so the system has no steady-state error. The characteristic of integral control is that it can eliminate steady-state errors. Therefore, the control system requires additional integral control to eliminate the steady-state error.

III. INTEGRALS STATE FEEDBACK

The system is modeled in the state space form as

$$\dot{x} = Ax + Bu \tag{1}$$

$$y = Cx \tag{2}$$

where x is the state, u is the control signal, y is the output, $A_{m \times m}$ is a constant state matrix, $B_{m \times 1}$ is the constant input matrix, and $C_{1 \times m}$ is the constant output matrix.

Then, the system is augmented to the proposed integrals state feedback controller. The integrals state feedback control scheme for stabilizing step, ramp, parabolic, or polynomial input reference is shown in Fig. 1. The f is the integrals control. The detailed scheme of $\sum f$ is shown in Fig. 1(b). The variable i is the order of integral control, as shown in Table 1.

For simplicity, the input reference signal is assumed as a unit step first as it requires the simplest structure design. This controller design later will be compared to the proposed controller and called a "conventional" method.

The new equation based on Fig. 1 is

$$\dot{z} = \hat{A}z + \hat{B}u + Fr \tag{3}$$

$$y = \hat{C}z \tag{4}$$

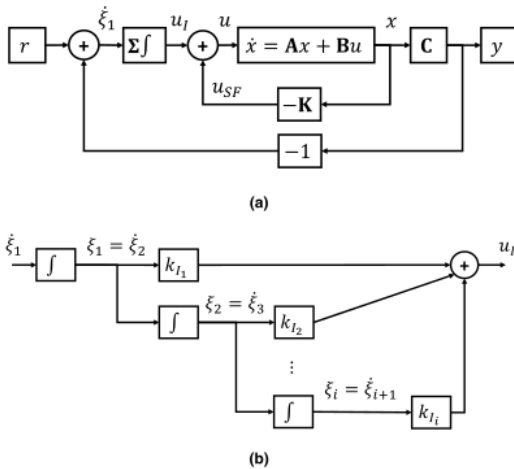

FIGURE 1. Integral state feedback.

where

$$z = \begin{bmatrix} x \\ \xi \end{bmatrix}$$

$$\hat{\mathbf{A}} = \begin{bmatrix} \mathbf{A} & \mathbf{0} \\ -\mathbf{C} & \mathbf{0} \end{bmatrix} \quad \hat{\mathbf{B}} = \begin{bmatrix} \mathbf{B} \\ \mathbf{0} \end{bmatrix} \quad \hat{\mathbf{C}} = \begin{bmatrix} \mathbf{C} \\ \mathbf{0} \end{bmatrix}^T \quad \mathbf{F} = \begin{bmatrix} \mathbf{0} \\ \mathbf{1} \end{bmatrix}$$

where z is the new state, ξ is the state variable, $\hat{\mathbf{A}}_{n \times n}$ is the new state constant matrix, $\hat{\mathbf{B}}_{n \times 1}$ is the new input constant matrix, $\hat{\mathbf{C}}_{1 \times n}$ is the new output constant matrix, \mathbf{F} is the constant reference matrix, and $n = m + i$ is the dimension of integrals state feedback.

The u is the control signal, that is a sum of the integral control signal (u_I) and state feedback control signal (u_{SF}). It can be written as,

$$u = u_I + u_{SF} \tag{5}$$

The state feedback control is

$$u_{SF} = -[k_1 \quad k_2 \quad \dots \quad k_n] \begin{bmatrix} x_1 \\ x_2 \\ \vdots \\ x_n \end{bmatrix} \tag{6}$$

$$= -\mathbf{K}x \tag{7}$$

where $\mathbf{K} = [k_1 \quad k_2 \quad \dots \quad k_n]$ is the state feedback gain.

A. INTEGRALS CONTROL

The proposed method of integral control structure for high-order input references will be explained in this part. The reference is assumed to have i order of reference. Based on Fig. 1(b), the integral control signal can be written as

$$u_I = [k_{I1} \quad k_{I2} \quad \dots \quad k_{Ii}] \begin{bmatrix} \xi_1 \\ \xi_2 \\ \vdots \\ \xi_i \end{bmatrix} \tag{8}$$

$$= \mathbf{K}_I \xi \tag{9}$$

where $\mathbf{K}_I = [k_{I1} \quad k_{I2} \quad \dots \quad k_{Ii}]$ is the integrals gain.

The derivation of integrals blocks based on Fig. 1(b) can be seen as integral states and written as follows

$$\begin{aligned} \dot{\xi}_1 &= r - y = r - \mathbf{C}x & (10) \\ \dot{\xi}_2 &= \xi_1 \\ \dot{\xi}_3 &= \xi_2 \\ &\vdots \\ \dot{\xi}_{i+1} &= \xi_i \end{aligned} \tag{11}$$

Therefore, the matrix of integrals can be written as

$$\dot{\xi} = \begin{bmatrix} 0 & 0 & 0 & \dots & 0 \\ 1 & 0 & 0 & \dots & 0 \\ 0 & 1 & 0 & \dots & 0 \\ \vdots & \vdots & \ddots & \ddots & \vdots \\ 0 & 0 & 0 & 1 & 0 \end{bmatrix} \xi + \begin{bmatrix} r - \mathbf{C}x \\ 0 \\ 0 \\ \vdots \\ 0 \end{bmatrix} \tag{12}$$

Now, let assume the used reference is ramp signal. Based on (10), (11), and (12), the integral state matrix for a unit ramp is,

$$\mathbf{I}_{\text{ramp}} = \begin{bmatrix} 0 & 0 \\ 1 & 0 \end{bmatrix} \tag{13}$$

Meanwhile, the integral state matrix for unit parabolic as input reference becomes

$$\mathbf{I}_{\text{parabolic}} = \begin{bmatrix} 0 & 0 & 0 \\ 1 & 0 & 0 \\ 0 & 1 & 0 \end{bmatrix} \tag{14}$$

Furthermore, the integral state matrix for High Order Reference can be written as

$$\mathbf{I}_{\text{HOR}} = \begin{bmatrix} 0 & 0 & 0 & \dots & 0 \\ 1 & 0 & 0 & \dots & 0 \\ 0 & 1 & 0 & \dots & 0 \\ \vdots & \vdots & \ddots & \ddots & \vdots \\ 0 & 0 & 0 & 1 & 0 \end{bmatrix} \tag{15}$$

The first row in (15) can be deleted. Then the matrix will have the identity matrix apart from the last column of zero. It can be rewritten as a general matrix as follow,

$$\mathbf{I}_{\text{HOR}} = [\mathbf{I}_{i \times i} \quad \mathbf{0}] \tag{16}$$

³⁷ where \mathbf{I} is the identity matrix, and i is the order of reference from Table 1.

B. THE AUGMENTED SYSTEMS

The system must fulfill controllability conditions (\mathbf{M}) and state controllability conditions (\mathbf{P}) to apply the proposed integrals state feedback control. Respectively, the criteria are

$$\mathbf{M} = [\mathbf{B} \quad \mathbf{A}\mathbf{B} \quad \mathbf{A}^2\mathbf{B} \quad \dots \quad \mathbf{A}^{n-1}\mathbf{B}] \tag{17}$$

$$\mathbf{P} = \begin{bmatrix} \mathbf{A} & \mathbf{0} & \mathbf{B} \\ -\mathbf{C} & \mathbf{0} & \mathbf{0} \\ \mathbf{0} & \mathbf{I}_{\text{HOR}} & \mathbf{0} \end{bmatrix} \tag{18}$$

where the rank of those matrices must not equal to zero.

After the system is proved to be controllable and completely state controllable, the controller design is continued. The new proposed augmented system design for the high order reference as input is

$$\dot{z} = \hat{A}z + \hat{B}u + Fr \quad (19)$$

$$y = \hat{C}z \quad (20)$$

where

$$z = \begin{bmatrix} x \\ \xi \end{bmatrix}$$

$$\hat{A} = \begin{bmatrix} A & 0 & 0 \\ -C & 0 & 0 \\ 0 & I_{HOR} & 0 \end{bmatrix} \quad \hat{B} = \begin{bmatrix} B \\ 0 \\ 0 \end{bmatrix} \quad \hat{C} = \begin{bmatrix} C \\ 0 \\ 0 \end{bmatrix}^T$$

$$F = \begin{bmatrix} 34 \\ 1 \\ 0 \end{bmatrix} \quad (24)$$

The overall control signal is the sum between the state feedback control signal and the integral control signal. By substituting (7) and (9) into (5), it can be rewritten as follows,

$$\begin{aligned} u &= u_{SF} + u_I = -Kx + K_I \xi \\ &= -\hat{K}z \end{aligned} \quad (21)$$

where

$$\hat{K} = [k_1 \ k_2 \ \dots \ k_n \ | \ -k_{I_1} \ -k_{I_2} \ \dots \ -k_{I_i}] \quad (22)$$

Matrix \hat{K} is the controller gain matrix and will be tuned by using the coefficient diagram method.

Hence, finally, the augmented system state-space equations can be rewritten. By substituting (21) to (19), the state error equation becomes

$$\dot{z} = (\hat{A} - \hat{B}\hat{K})z + Fr \quad (23)$$

$$y = \hat{C}z \quad (24)$$

The equation (23) and (24) is the final closed-loop system with the proposed control signal.

IV. COEFFICIENT DIAGRAM METHOD AND ACKERMANN FORMULA

The coefficient diagram method (CDM) is used in the research to tune the proposed controller's parameter. The target polynomial (closed-loop polynomial) is the system's characteristic polynomial with the control signal augmented in CDM. The target polynomial for the system in (23) is

$$P_T = \alpha_0 \left[\sum_{i=2}^n \left(\prod_{j=1}^{i-1} \frac{1}{\gamma_{i-j}^j} \right) (\tau s)^i \right] + \tau s + 1 \quad (25)$$

$$= \alpha_n s^n + \alpha_{n-1} s^{n-1} + \dots + \alpha_1 s + \alpha_0 \quad (26)$$

where α_n is the coefficient of the closed-loop polynomial, or desired polynomial in s -plane), γ_n is the stability index, τ is the equivalent time constant and

$$\alpha_0 = \frac{\prod_{j=1}^{n-1} \gamma_{n-j}^j}{\tau^n} \quad (27)$$

The standard form of the stability index, γ_n , is

$$\gamma_{n-1} = \dots = \gamma_3 = \gamma_2 = 2 \quad \gamma_1 = 2.5 \quad (28)$$

The standard form is from past research that gives the best response with fast settling time and a little overshoot characteristic. The equivalent time constant, τ , is

$$\tau = \frac{1}{3} t_s \quad (29)$$

where t_s is the settling time, and it can be chosen between 2.5 and 3 seconds for the good system's response.

The Ackermann Formula will be used to obtain Integrals state feedback from Coefficient Diagram Method. It is a well-known method to determine the state feedback gain matrix [29]. First, a system is represented in state-space as follows,

$$\dot{z} = Az - Bu \quad (30)$$

with the state feedback control signal as

$$u = -Kz \quad (31)$$

Hence, the equation of system (30) with state feedback control (31) becomes

$$\dot{z} = (A - BK)z \quad (32)$$

Let assume a new equation to substitute the $A - BK$,

$$\tilde{A} = A - BK \quad (33)$$

so that the desired characteristic equation is

$$\begin{aligned} |sI - A + BK| &= |sI - \tilde{A}| \\ &= s^n + \alpha_1 s^{n-1} + \dots + \alpha_{n-1} s + \alpha_n \\ &= 0. \end{aligned} \quad (34)$$

Based on the Cayley-Hamilton theorem, \tilde{A} satisfied its own characteristic equation as

$$\phi(\tilde{A}) = \tilde{A}^n + \alpha_1 \tilde{A}^{n-1} + \dots + \alpha_{n-1} \tilde{A} + \alpha_n I = 0 \quad (36)$$

By considering (33) and following identities,

$$A^2 = (A - BK)^2 = A^2 - ABK - BK\tilde{A} \quad (37)$$

$$\begin{aligned} \tilde{A}^3 &= (A - BK)^3 = A^3 - A^2BK - BK\tilde{A} \\ &\quad - BK\tilde{A}^2 \end{aligned} \quad (38)$$

with $n = 3$, the characteristic equation from (36) becomes

$$\begin{aligned} \alpha_3 I + \alpha_2 \tilde{A} + \alpha_1 \tilde{A}^2 + \tilde{A}^3 \\ = \alpha_3 I + \alpha_2 A + \alpha_1 A^2 + A^3 - \alpha_2 BK \\ - \alpha_1 ABK - \alpha_1 BK\tilde{A} - A^2BK - BK\tilde{A} \\ = BK\tilde{A}^2 \end{aligned} \quad (39)$$

Therefore, we can get

$$\alpha_3 I + \alpha_2 \tilde{A} + \alpha_1 \tilde{A}^2 + \tilde{A}^3 = \phi(\tilde{A}) = 0 \quad (40)$$

$$\alpha_3 I + \alpha_2 A + \alpha_1 A^2 + A^3 = \phi(A) \neq 0 \quad (41)$$

By substituting (40) and (41) in α_3 into (39), we obtained

$$\phi(\tilde{\mathbf{A}}) = \phi(\mathbf{A}) - \alpha_2 \mathbf{BK} - \alpha_1 \mathbf{ABK} - \mathbf{BK}\tilde{\mathbf{A}}^2 - \alpha_1 \mathbf{BK}\tilde{\mathbf{A}} - \mathbf{ABK}\tilde{\mathbf{A}} - \mathbf{A}^2 \mathbf{BK} \quad (42)$$

Since $\phi(\tilde{\mathbf{A}}) = 0$, then the equation becomes

$$\phi(\mathbf{A}) = \mathbf{B}(\alpha_2 \mathbf{K} - \alpha_1 \mathbf{K}\tilde{\mathbf{A}} - \mathbf{K}\tilde{\mathbf{A}}^2) + \mathbf{AB}(\alpha_1 \mathbf{K} - \mathbf{K}\tilde{\mathbf{A}}) + \mathbf{A}^2 \mathbf{BK} \quad (43)$$

$$= [\mathbf{B} \mid \mathbf{AB} \mid \mathbf{A}^2 \mathbf{B}] \begin{bmatrix} \alpha_2 \mathbf{K} - \alpha_1 \mathbf{K}\tilde{\mathbf{A}} - \mathbf{K}\tilde{\mathbf{A}}^2 \\ \alpha_1 \mathbf{K} - \mathbf{K}\tilde{\mathbf{A}} \\ \mathbf{K} \end{bmatrix} \quad (44)$$

By multiplying both sides of (44) by the inverse of the controllability matrix, we obtained

$$[\mathbf{B} \mid \mathbf{AB} \mid \mathbf{A}^2 \mathbf{B}]^{-1} \phi(\mathbf{A}) = \begin{bmatrix} \alpha_2 \mathbf{K} - \alpha_1 \mathbf{K}\tilde{\mathbf{A}} - \mathbf{K}\tilde{\mathbf{A}}^2 \\ \alpha_1 \mathbf{K} - \mathbf{K}\tilde{\mathbf{A}} \\ \mathbf{K} \end{bmatrix} \quad (45)$$

By multiplying both sides of (45) by $[0 \ 0 \ 1]$, we obtained

$$[0 \ 0 \ 1] [\mathbf{B} \mid \mathbf{AB} \mid \mathbf{A}^2 \mathbf{B}]^{-1} \phi(\mathbf{A}) = [0 \ 0 \ 1] \begin{bmatrix} \alpha_2 \mathbf{K} - \alpha_1 \mathbf{K}\tilde{\mathbf{A}} - \mathbf{K}\tilde{\mathbf{A}}^2 \\ \alpha_1 \mathbf{K} - \mathbf{K}\tilde{\mathbf{A}} \\ \mathbf{K} \end{bmatrix} \quad (46)$$

which can be written as

$$\mathbf{K} = [0 \ 0 \ 1] \times [\mathbf{B} \mid \mathbf{AB} \mid \mathbf{A}^2 \mathbf{B}]^{-1} \phi(\mathbf{A}) \quad (47)$$

For an arbitrary positive integer n , the state feedback gain is

$$\mathbf{K} = [0 \ 0 \ \dots \ 0 \ 1] \times [\mathbf{B} \mid \mathbf{AB} \mid \dots \mid \mathbf{A}^{n-1} \mathbf{B}]^{-1} \phi(\mathbf{A}) \quad (48)$$

where

$$\phi(\mathbf{A}) = \mathbf{A}^n + \alpha_1 \mathbf{A}^{n-1} + \dots + \alpha_{n-1} \mathbf{A} + \alpha_n \mathbf{I} \quad (49)$$

Therefore, the Ackerman formula for determining the integral(s) state feedback gain is

$$\hat{\mathbf{K}} = [0 \ \dots \ 0 \ 1] \times [\mathbf{B} \mid \mathbf{AB} \mid \dots \mid \mathbf{A}^{n-1} \mathbf{B}]^{-1} \phi(\mathbf{A}) \quad (50)$$

where

$$\phi(\mathbf{A}) = \mathbf{A}^n + \alpha_1 \mathbf{A}^{n-1} + \dots + \alpha_{n-1} \mathbf{A} + \alpha_n \mathbf{I} \quad (51)$$

39 STEADY STATE ANALYSIS

Steady-state error evaluation is used to testify whether the controller is able to reach the reference value in ideally 'infinite' time. It can be achieved from simulation results or mathematical calculations. The calculation of steady-state error can be done by using two methods: final value theorem and input substitution. Both of the methods are represented in the research.

The first one is the final value theorem. The steady-state error value can be calculated based on the following equations

$$\lim_{s \rightarrow 0} s E(s) = \lim_{s \rightarrow 0} s R(s) [1 - C(sI - A)^{-1} B] \quad (52)$$

where $R(s)$ is the reference signal in s -domain.

The other one is the input substitution; for the step and ramp reference, respectively, the input substitution is

$$e(\infty)_{step} = 1 - y_{ss} = 1 - \mathbf{CA}^{-1} \mathbf{B} \quad (53)$$

$$e(\infty)_{ramp} = \lim_{t \rightarrow \infty} (t - y_{ss}) = \lim_{t \rightarrow \infty} \left([1 + \hat{\mathbf{C}} \hat{\mathbf{A}}^{-1} \hat{\mathbf{B}}] t + \hat{\mathbf{C}} (\hat{\mathbf{A}}^{-1})^2 \mathbf{B} \right) \quad (54)$$

Then, the input substitution for the parabolic reference is as follows. Given the system in state-space form as

$$\dot{z} = \mathbf{A}z + \mathbf{B}u \quad (55)$$

$$y = \mathbf{C}z \quad (56)$$

If the reference signal is a parabolic reference, $r = t^2$, the steady-state solution, z_{ss} for z is

$$z_{ss} = \mathbf{U}t^2 + \mathbf{V}t + \mathbf{W} \quad (57)$$

where, \mathbf{U} , \mathbf{V} , \mathbf{W} are constant. Also,

$$\dot{z}_{ss} = \mathbf{U}t + \mathbf{V} \quad (58)$$

Substituting $r = t^2$ along with (57) and (58) into (55) and (56) yields

$$\mathbf{U}t + \mathbf{V} = \mathbf{A}(\mathbf{U}t^2 + \mathbf{V}t + \mathbf{W}) + \mathbf{B}t^2 \quad (59)$$

$$y_{ss} = \mathbf{C}(\mathbf{U}t^2 + \mathbf{V}t + \mathbf{W}) \quad (60)$$

In order to balance (59), the matrix of coefficient t^2 , $\mathbf{AU} = -\mathbf{B}$ or

$$\mathbf{U} = -\mathbf{A}^{-1} \mathbf{B} \quad (61)$$

Equating constant terms in (62), we have $\mathbf{AV} = \mathbf{U}$, or

$$\mathbf{V} = \mathbf{A}^{-1} \mathbf{U} \quad (62)$$

Equating constant terms in (62), we have $\mathbf{AW} = \mathbf{V}$, or

$$\mathbf{W} = \mathbf{A}^{-1} \mathbf{V} \quad (63)$$

Substituting (61), (62), and (63) into (60) yields

$$y_{ss} = \mathbf{C}(-\mathbf{A}^{-1} \mathbf{B}t^2 + \mathbf{A}^{-1}(-\mathbf{A}^{-1}) \mathbf{B}t + \mathbf{A}^{-1}(-\mathbf{A}^{-1})(-\mathbf{A}^{-1}) \mathbf{B}) \quad (64)$$

$$= -\mathbf{C}(-\mathbf{A}^{-1} \mathbf{B}t^2 + (\mathbf{A}^{-1})^2 \mathbf{B}t + (\mathbf{A}^{-1})^3 \mathbf{B}) \quad (65)$$

The steady-state error for parabolic reference is

$$\begin{aligned}
 e(\infty) &= \lim_{t \rightarrow \infty} (t^2 - y_{ss}) \\
 &= \lim_{t \rightarrow \infty} (1 + \mathbf{CA}^{-1}\mathbf{B})t^2 + \mathbf{C}(\mathbf{A}^{-1})^2 \mathbf{B}t \\
 &\quad + \mathbf{C}(\mathbf{A}^{-1})^3 \mathbf{B}
 \end{aligned} \tag{66}$$

The steady-state error for the high order reference is

$$\begin{aligned}
 e(\infty) &= \lim_{t \rightarrow \infty} (t^i - y_{ss}) \\
 &= \lim_{t \rightarrow \infty} (1 + \mathbf{CA}^{-1}\mathbf{B})t^i + \sum_{n=1}^i \mathbf{C}(\mathbf{A}^{-1})^{n+1} \mathbf{B}t^{i-n}
 \end{aligned} \tag{67}$$

where i is the order input reference. The steady-state error for infinity time can be calculated using the final value theorem in (52) and input substitution in (67).

VI. CONTROLLER DESIGN ALGORITHM

The design process to tune the integrals state feedback using the coefficient diagram method and Ackermann formula will be described as follows,

1. Find the state matrix constant size (m) based on the \mathbf{A} matrix system, the input reference order based on Table 1 (for ramp $i = 2$, for parabolic $i = 3$ and so on), and the state matrix of augmented system $n = m + i$. For example, the parabolic reference will be used for the triple integrator system. The system model is,

$$\mathbf{A} = \begin{bmatrix} 0 & 1 & 0 \\ 0 & 0 & 1 \\ 0 & 0 & 0 \end{bmatrix} \quad \mathbf{B} = \begin{bmatrix} 0 \\ 0 \\ 1 \end{bmatrix} \quad \mathbf{C} = \begin{bmatrix} 1 \\ 0 \\ 0 \end{bmatrix}^T \tag{68}$$

$$\begin{aligned}
 \widehat{\mathbf{A}} &= \begin{bmatrix} \mathbf{A} & 0 & 0 \\ -\mathbf{C} & 0 & 0 \\ 0 & \mathbf{I}_{HOR} & 0 \end{bmatrix} \\
 &= \begin{bmatrix} 0 & 1 & 0 & 0 & 0 & 0 \\ 0 & 0 & 1 & 0 & 0 & 0 \\ 0 & 0 & 0 & 0 & 0 & 0 \\ -1 & 0 & 0 & 0 & 0 & 0 \\ 0 & 0 & 0 & 1 & 0 & 0 \\ 0 & 0 & 0 & 0 & 1 & 0 \end{bmatrix}
 \end{aligned} \tag{69}$$

$$\widehat{\mathbf{B}} = [\mathbf{B} \ 0]^T = [0 \ 0 \ 1 \ 0 \ 0 \ 0]^T \tag{70}$$

2. Check the rank of controllability and state controllability matrices using (17) and (18).
3. Define the closed-loop polynomial or target polynomial from (25), (26), (27), (28), and (29). In the previous example case with the desired settling time t_s as 3 seconds. Thus the equivalent time constant τ is 1 second. The target polynomial can be defined as follows.

$$\alpha_0 = \frac{\gamma_5 \gamma_4^2 \gamma_3^3 \gamma_2^4 \gamma_1^5}{\tau^6} \tag{71}$$

$$\begin{aligned}
 \mathbf{P}_T &= \alpha_0 \left(\frac{\tau^6}{\gamma_5 \gamma_4^2 \gamma_3^3 \gamma_2^4 \gamma_1^5} s^6 + \frac{\tau^5}{\gamma_4 \gamma_3^2 \gamma_2^3 \gamma_1^4} s^5 \right. \\
 &\quad \left. + \frac{\tau^4}{\gamma_3 \gamma_2^2 \gamma_1^3} s^4 + \frac{\tau^3}{\gamma_2 \gamma_1^2} s^3 + \frac{\tau^2}{\gamma_1} s + \tau s + 1 \right) \\
 &= \alpha_6 s^6 + \alpha_5 s^5 + \alpha_4 s^4 + \alpha_3 s^3 + \alpha_2 s^2 + \alpha_1 s + \alpha_0
 \end{aligned} \tag{72}$$

$$\tag{73}$$

4. Find the integrals state feedback gain by applying the Ackermann formula. For the previous example case, this step can be rewritten as follows

$$\begin{aligned}
 \widehat{\mathbf{K}} &= [0 \ 0 \ 0 \ 0 \ 0 \ 1] \\
 &\quad \times [\mathbf{B} \ \widehat{\mathbf{A}}\mathbf{B} \ \widehat{\mathbf{A}}^2\mathbf{B} \ \widehat{\mathbf{A}}^3\mathbf{B} \ \widehat{\mathbf{A}}^4\mathbf{B} \ \widehat{\mathbf{A}}^5\mathbf{B}]^{-1} \\
 &\quad \times \phi(\widehat{\mathbf{A}})
 \end{aligned} \tag{74}$$

where

$$\begin{aligned}
 \phi(\widehat{\mathbf{A}}) &= \widehat{\mathbf{A}}^6 + \alpha_1 \widehat{\mathbf{A}}^5 + \alpha_2 \widehat{\mathbf{A}}^4 + \alpha_3 \widehat{\mathbf{A}}^3 + \alpha_4 \widehat{\mathbf{A}}^2 \\
 &\quad + \alpha_5 \widehat{\mathbf{A}} + \alpha_6 \mathbf{I}
 \end{aligned} \tag{75}$$

VII. RESULTS AND DISCUSSION

There are some examinations in the section. The first examination is to track and to stabilize the triple integrator system using the proposed controller for ramp and parabolic reference. The result will compare the conventional (integral state feedback) and proposed controller (integrals state feedback). The second examination is about control the system for the polynomial reference. The third examination is about the integrals state feedback design for low order reference. The fourth examination is about the stability analysis using the pole position.

Simulations made in the research are done in MATLAB. The controlled system is a triple integrator system. The system model is written as follows

$$G(s) = \frac{1}{s^3} \tag{76}$$

or in the state space form has matrices as

$$\mathbf{A} = \begin{bmatrix} 0 & 1 & 0 \\ 0 & 0 & 1 \\ 0 & 0 & 0 \end{bmatrix} \quad \mathbf{B} = \begin{bmatrix} 0 \\ 0 \\ 1 \end{bmatrix} \quad \mathbf{C} = \begin{bmatrix} 1 \\ 0 \\ 0 \end{bmatrix}^T \tag{77}$$

CDM parameters used for all later-mentioned controller designs are as follows. The targeted settling time is $t_s = 3$ hence $\tau = 1$ is used. The stability indexes used are the recommended standard stability index parameter as in (28).

A. RAMP AND PARABOLIC INPUT REFERENCE

First, the system is checked based on the criteria mentioned in (17) and (18). Both ranks of the controllability matrix (\mathbf{M}) and state controllable matrix (\mathbf{P}) are 4. Thus, the system is able to be controlled by the proposed integrals state feedback method.

The augmented system for ramp input tracking based on the algorithm is

$$\dot{z} = \widehat{\mathbf{A}}z + \widehat{\mathbf{B}}u + \mathbf{F}r \tag{78}$$

$$y = \widehat{\mathbf{C}}x \tag{79}$$

where

$$\hat{\mathbf{A}} = \begin{bmatrix} A & 0 \\ -C & 0 \\ 0 & \mathbf{I}_{HOR} \end{bmatrix} = \begin{bmatrix} 0 & 1 & 0 & 0 & 0 \\ 0 & 0 & 1 & 0 & 0 \\ 0 & 0 & 0 & 0 & 0 \\ -1 & 0 & 0 & 0 & 0 \\ 0 & 0 & 0 & 1 & 0 \end{bmatrix} \quad (80)$$

$$\hat{\mathbf{B}} = \begin{bmatrix} \mathbf{B} \\ 0 \end{bmatrix} = \begin{bmatrix} 0 \\ 0 \\ 1 \\ 0 \\ 0 \end{bmatrix} \quad \hat{\mathbf{C}} = \begin{bmatrix} \mathbf{C} \\ 0 \end{bmatrix}^T = \begin{bmatrix} 1 \\ 0 \\ 0 \\ 0 \\ 0 \end{bmatrix} \quad \mathbf{F} = \begin{bmatrix} 0 \\ 0 \\ 0 \\ 1 \\ 0 \end{bmatrix} \quad (81)$$

The closed-loop polynomial is

$$\begin{aligned} \mathbf{P}_T &= \alpha_5 s^5 + \alpha_4 s^4 + \alpha_3 s^3 + \alpha_2 s^2 + \alpha_1 s + \alpha_0 \\ &= s^5 + 20s^4 + 200s^3 + 1000s^2 + 2500s + 2500 \end{aligned} \quad (82)$$

The controller gains can be found by using the Ackermann formula. The process can be briefly described from the following equations.

$$\hat{\mathbf{K}} = \begin{bmatrix} 0 & 0 & 0 & 0 & 1 \end{bmatrix} \times \begin{bmatrix} \hat{\mathbf{B}} & \hat{\mathbf{A}}\hat{\mathbf{B}} & \hat{\mathbf{A}}^2\hat{\mathbf{B}} & \hat{\mathbf{A}}^3\hat{\mathbf{B}} & \hat{\mathbf{A}}^4\hat{\mathbf{B}} \end{bmatrix}^{-1} \phi(\hat{\mathbf{A}}) \quad (83)$$

where

$$\begin{aligned} \phi(\hat{\mathbf{A}}) &= \hat{\mathbf{A}}^5 + \alpha_1 \hat{\mathbf{A}}^4 + \alpha_2 \hat{\mathbf{A}}^3 + \alpha_3 \hat{\mathbf{A}}^2 + \alpha_4 \hat{\mathbf{A}} + \alpha_5 \mathbf{I} \\ &= \hat{\mathbf{A}}^5 + 20\hat{\mathbf{A}}^4 + 200\hat{\mathbf{A}}^3 + 1000\hat{\mathbf{A}}^2 + 2500\hat{\mathbf{A}} + 2500\mathbf{I} \end{aligned} \quad (84)$$

Hence, the obtained controller gain matrix is

$$\hat{\mathbf{K}} = \begin{bmatrix} k_1 & k_2 & k_3 & | & k_{I1} & k_{I2} \\ 1000 & 200 & 20 & | & 2500 & 2500 \end{bmatrix} \quad (85)$$

Parabolic input tracking requires a similar controller design process. The augmented system for parabolic input tracking is mentioned in (69), (70), (73), and (74). Meanwhile, the obtained controller gain matrix for parabolic input is

$$\begin{aligned} \hat{\mathbf{K}} &= \begin{bmatrix} k_1 & k_2 & k_3 & | & k_{I1} & k_{I2} & k_{I3} \\ 8000 & 800 & 40 & | & 40000 & 100000 & 100000 \end{bmatrix} \end{aligned} \quad (86)$$

The augmented system performances, for both ramp and parabolic input tracking using integrals state feedback, then, are compared to conventional method performance results. The conventional method is the implementation of state feedback control, with only one integral gain used.

The system response of ramp and parabolic input reference is shown in Fig. 2 and Fig. 3. It is shown that the proposed controller can follow the parabolic reference. Meanwhile, the conventional controller cannot follow the reference. There is a steady-state error in a conventional controller.

The simulation showed that the proposed controller could stabilize the system to follow the reference signal. Based on

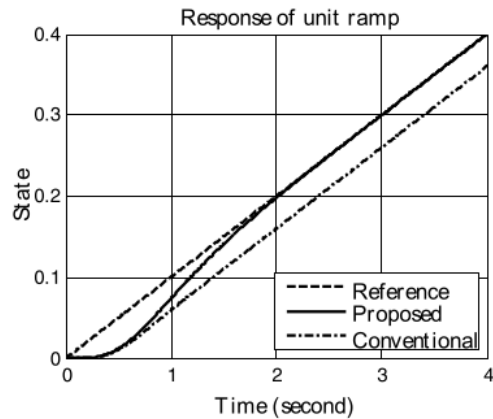

FIGURE 2. Integral state feedback for ramp input reference.

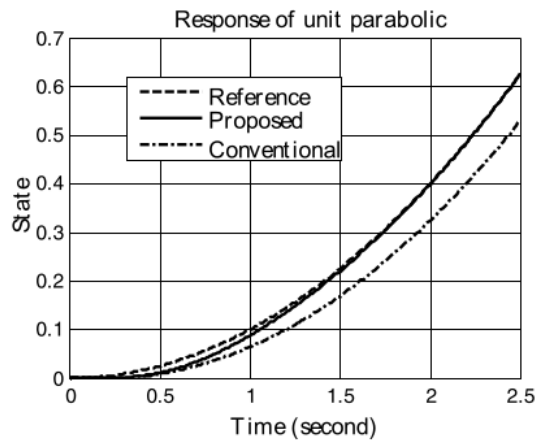

FIGURE 3. Integral state feedback for parabolic input reference.

Fig. 2 and Fig. 3, the proposed controller is able to track both ramp and parabolic references stably. However, the conventional method implementation shows that there are some tracking errors. The steady-state error values can be calculated by using input substitution and final value theorem. These mathematical proofs supported the simulation results. The steady-state error calculation by using input substitution for ramp input reference and parabolic can be calculated using (53) and (54). Meanwhile, the final value theorem for input reference can be calculated using (52).

Then, the steady-state error by using the input reference for the proposed controller is

$$e_{ss_ramp}(\infty) = \lim_{t \rightarrow \infty} (0t + 0) = 0 \quad (87)$$

$$e_{ss_parabolic}(\infty) = \lim_{t \rightarrow \infty} (0t^2 + 0t + 0) = 0 \quad (88)$$

Meanwhile, the steady-state error by using the Final value theorem for the ramp input proposed tracking

controller is

$$\begin{aligned} \lim_{s \rightarrow 0} sE(s) &= \lim_{s \rightarrow 0} \frac{1}{s^2} \left[1 - \frac{2500s + 2500}{s^5 + 20s^4 + 200s^3 + 1000s^2 + 2500s + 2500} \right] \\ &= \frac{0}{2500} = 0 \end{aligned} \quad (89)$$

The steady-state error for parabolic by using the Final value theorem for the proposed controller is

$$\begin{aligned} \lim_{s \rightarrow 0} sE(s) &= \lim_{s \rightarrow 0} \frac{1}{s^3} \left[1 - \frac{40000s^2 + 10000s + 100000}{s^6 + 400s^5 + 800s^4 + 8e^3s^3 + 4e^4s^2 + 1e^5s + 1e^5} \right] \\ &= 0 \end{aligned} \quad (90)$$

where e^n is the 10^n .

The input substitution and final value theorem proof result for the proposed controller in (87), (88), (89), and (90) shown that the proposed controller has zero steady-state error. Thus the controller can track the input reference.

Then, the conventional integral state feedback has steady-state error as

$$e_{ss_ramp}(\infty) = \lim_{t \rightarrow \infty} (0t + 0.4) = 0.4 \quad (91)$$

$$e_{ss_parabolic}(\infty) = \lim_{t \rightarrow \infty} (0t^2 + t + 0.2) = \infty \quad (92)$$

The final value theorem of conventional integral state feedback for ramp input reference is

$$\begin{aligned} \lim_{s \rightarrow 0} sE(s) &= \lim_{s \rightarrow 0} \frac{1}{s^2} \left[1 - \frac{2500}{s^5 + 20s^4 + 200s^3 + 1000s^2 + 2500s + 2500} \right] \\ &= \frac{1000}{2500} = 0.4 \end{aligned} \quad (93)$$

The final value theorem of conventional integral state feedback for parabolic input reference is

$$\begin{aligned} \lim_{s \rightarrow 0} sE(s) &= \lim_{s \rightarrow 0} \frac{1}{s^3} \left[1 - \frac{2500}{s^5 + 20s^4 + 200s^3 + 1000s^2 + 2500s + 2500} \right] \\ &= \frac{1000}{0} = \infty \end{aligned} \quad (94)$$

The input substitution and final value theorem result for the conventional controller in (91), (92), (93), and (94) showed that the conventional controller has steady-state error 0.4

for ramp input reference and infinity for the parabolic reference. Thus the conventional controller cannot track the input reference. The completed mathematical proof is shown in Table 2.

TABLE 2. Steady state error (SSE).

Controller	Ramp Method		Parabolic Method	
	FVT	IS	FVT	IS
Conventional Integral State Feedback	0.4	0.4	∞	∞
Proposed Integrals State Feedback	0	0	0	0

FVT = Final Value Theorem, IS = Input Substitution

B. POLYNOMIAL INPUT REFERENCE TRACKING

The second examination is about control the system for the polynomial reference. It is stabilized the high order input reference, such as third-order polynomial until fifth-order polynomial.

The result is shown in Fig. 4, Fig. 5, and Fig. 6. The numerical simulation showed that the proposed controller could follow the high order reference. Meanwhile, the conventional controller gave the steady-state error response. Further, the mathematical proof result is shown in Table 3 by using the Final Value Theorem and Input Substitution. There is infinity steady-state error in the conventional controller and zero steady-state error in the proposed controller.

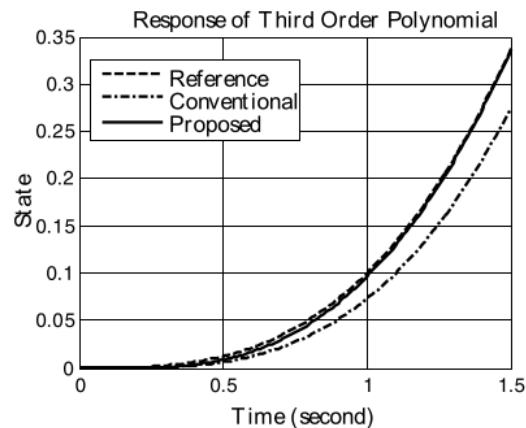

FIGURE 4. System response of third order polynomial input reference.

C. STABILITY ANALYSIS USING POLE LOCATION

Some mathematical proofs of the augmented system's stability are presented in this sub-section. Pole locations for stability are used. The closed-loop polynomials or the targeted polynomial tuned by using CDM shown in Table 4 where $n = m + i$ is the augmented matrix size from $A_{n \times n}$ matrix size and order of reference (i). The first row is the desired

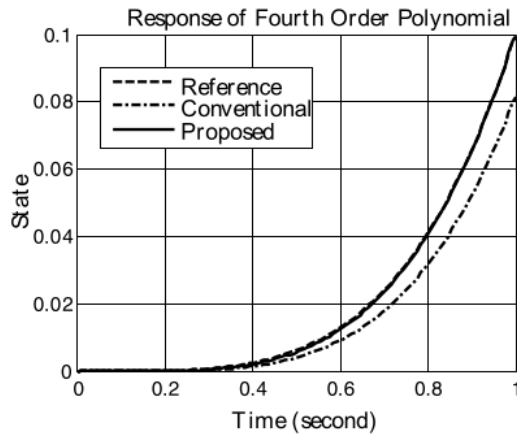

FIGURE 5. System response of fourth order polynomial input reference.

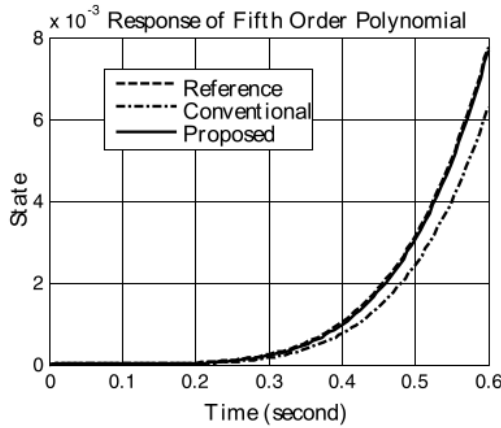

FIGURE 6. System response of fifth order polynomial input reference.

TABLE 3. Steady state error (SSE).

Controller	Third Order Polynomial Method		Fourth Order Parabolic Method		Fifth Order Parabolic Method	
	FVT	IS	FVT	IS	FVT	IS
Conventional	∞	∞	∞	∞	∞	∞
Integral State Feedback	∞	∞	∞	∞	∞	∞
Proposed Integrals State Feedback	0	0	0	0	0	0

FVT = Final Value Theorem, IS = Input Substitution

polynomial for the ramp reference. The second row is the desired polynomial for parabolic reference, and so on.

It is shown that the targeted polynomials from the fifth-order until the ninth order of s give the negative root. Thus, the desired polynomials will result in a stable system. Thus, it is clear that the system has a stable system. Then, for the system (19) using a controller (21), have pole location will always in a left-hand plane (LHP) with the minimum real pole is -2.84 and -2.95 .

TABLE 4. Pole location of closed loop or target polynomial.

n	Desired Polynomial (P_T)	Pole Position
5	$s^5 + 20s^4 + 200s^3 + 1000s^2 + 2500s + 2500$	$s_{1,2} = -5.56 \pm 6.39i$ $s_{3,4} = -3.02 \pm 1.76i$ $s_5 = -2.84$
6	$s^6 + 40s^5 + 800s^3 + 4e^4s^2 + e^5s + e^5$	$s_{1,2} = -11.14 \pm 13.04i$ $s_{3,4} = -3.22 \pm 1.86i$ $s_5 = -8.32$ $s_6 = -2.95$
7	$s^7 + 80s^6 + 3200s^5 + 64e^3s^4 + 64e^4s^3 + 32e^5s^2 + 8e^6s + 8e^6$	$s_{1,2} = -22.25 \pm 26.07i$ $s_{3,4} = -3.2 \pm 1.86i$ $s_5 = -14.64$ $s_6 = -11.49$ $s_7 = -2.95$
8	$s^8 + 160s^7 + 128e^2s^6 + 512e^3s^5 + 1024e^4s^4 + 1024e^5s^3 + 512e^6s^2 + 128e^7s + 128e^7$	$s_{1,2} = -44.50 \pm 52.13i$ $s_{3,4} = -3.21 \pm 1.84i$ $s_5 = -30.02$ $s_6 = -20.85$ $s_7 = -10.74$ $s_8 = -2.95$
9	$s^9 + 320s^8 + 512e^2s^7 + 4096e^3s^6 + 16384e^4s^5 + 32768e^5s^4 + 32768e^6s^3 + 16384e^7s^2 + 4096e^8s + 4096e^8$	$s_{1,2} = -89.50 \pm 104.26i$ $s_{3,4} = -3.21 \pm 1.84i$ $s_5 = -59.98$ $s_6 = -42.03$ $s_7 = -19.83$ $s_8 = -10.75$ $s_9 = -2.95$

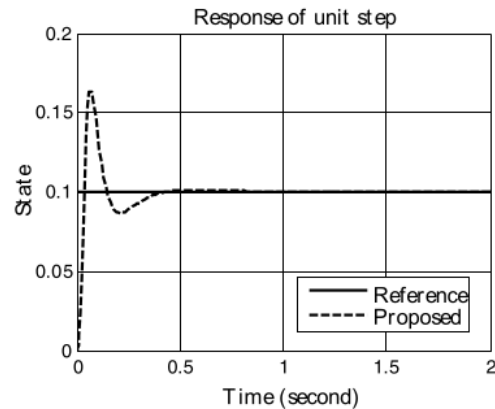

FIGURE 7. System response of step input reference.

D. HIGH ORDER INTEGRALS STATE FEEDBACK FOR LOW ORDER REFERENCE

Based on previous examinations for ramp, parabolic, and some polynomials input tracking, it can be seen that the proposed method still lack flexibility with its design. Hence, to see the importance of the design, further examination is done.

Hypothetically, the controller design for higher-order input reference should be able to track lower-order input references. Hence, integrals state feedback design for fifth-order input reference is applied to the triple integrator system with lower-order references such as step, ramp, and parabolic units.

The simulation result for step tracking is shown in Fig. 7. The step response test results in zero steady-state error with overshoot 62.94 percent and undershoot. The overshoot is

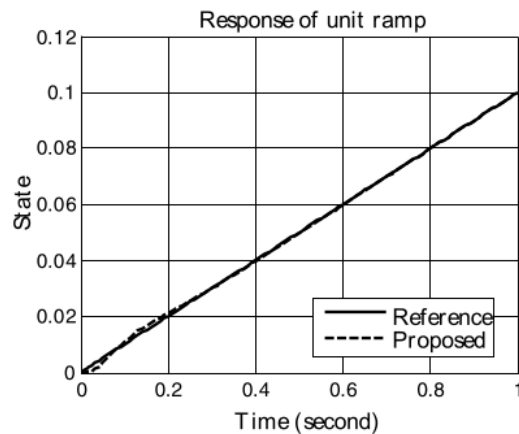

FIGURE 8. System response of ramp input reference.

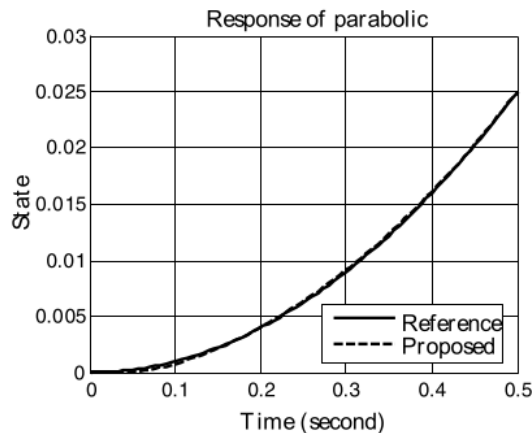

FIGURE 9. System response of parabolic input reference.

likely to happen since the number of integrals corresponds to the aggressiveness of the system's response. Too many integrals are used in the system cause the system tends to have a bigger overshoot. However, it is shown that the system is able to be stabilized in general.

The augmented system's response for 36^{p} and parabolic tracking is shown in Fig. 8 and Fig. 9. The controller is able to control the system stably while tracking the reference value. The augmented system also achieved zero steady-state error. There is no oscillation detected in the response. Thus the high order controller design can be implemented for low order reference.

VIII. CONCLUSION

The paper proposes about integrals state feedback design for tracking high order input references. The coefficient diagram tunes the 7^{p} parameter controller. The simulation and mathematical proof show that the proposed controller can track the high

order input reference. Meanwhile, the conventional controller has a steady-state error.

The stability analysis using pole location shows that the closed-loop polynomial has a negative pole. Thus, the system is stable. The integrals state feedback design for fifth-order input reference can track all of the references from step until the parabolic reference. Thus the high order controller design can be implemented for lower-order reference.

Future work of the research may include further analysis of system performances on a real-time experiment, especially on the state feedback controller's practical implementation.

27 ACKNOWLEDGMENT

The author would like to deliver thanks to the reviewer and editor.

REFERENCES

- [1] D. E. Seborg, T. F. Edgar, D. A. Mellichamp, and F. J. Doyle, III, *Process Dynamics and Control*. Hoboken, NJ, USA: Wiley, 2016.
- [2] M. Samuel, M. Mohamad, M. Hussein, and S. M. Saad, "Lane keeping maneuvers using proportional integral derivative (PID) and model predictive control (MPC)," *J. Robot. Control*, vol. 2, no. 2, pp. 78–82, 2021.
- [3] W. Dong, G.-Y. Gu, X. Zhu, and H. Ding, "A high-performance flight control approach for quadrotors using a modified active disturbance rejection technique," *Robot. Auto. Syst.*, vol. 83, pp. 177–187, Sep. 2016.
- [4] A. Latif, A. Z. Arfianto, H. A. Widodo, R. Rahim, and E. T. Helmy, "Motor DC PID system regulator for mini conveyor drive based-on MATLAB," *J. Robot. Control*, vol. 1, no. 6, pp. 185–190, 2020.
- [5] M. S. Tavazoei, "Ramp tracking in systems with nonminimum phase zeros: One-and-a-half integrator approach," *J. Dyn. Syst., Meas., Control*, vol. 138, no. 3, Mar. 2016, Art. no. 031002.
- [6] B. Kamel, I. Benaoumeur, B. Laredj, and A.-F. Zoubir, "Integral backstepping approach for mobile robot control," *Telkomnika (Telecommun. Comput. Electron. Control)*, vol. 15, no. 3, p. 1173, Sep. 2017.
- [7] M. Chen, "Robust tracking control for self-balancing mobile robots using disturbance observer," *IEEE/CAA J. Automatica Sinica*, vol. 4, no. 3, pp. 458–465, 2017.
- [8] J. Ling, Z. Feng, D. Yao, and X. Xiao, "Non-linear contour tracking using feedback PID and feedforward position domain cross-coupled iterative learning control," *Trans. Inst. Meas. Control*, vol. 40, no. 6, pp. 1970–1982, Apr. 2018.
- [9] D. Limon, M. Pereira, D. Munoz de la Pena, T. Alamo, C. N. Jones, and M. N. Zeilinger, "MPC for tracking periodic references," *IEEE Trans. Autom. Control*, vol. 61, no. 4, pp. 1123–1128, Apr. 2016.
- [10] A. K. Jain and S. Bhasin, "Tracking control of uncertain nonlinear systems with unknown constant input delay," *IEEE/CAA J. Automatica Sinica*, vol. 7, no. 2, pp. 420–425, Mar. 2020.
- [11] R. Uswarman, S. Istiqhara, and D. H. Tri Nugroho, "Sliding mode control with gain scheduled for magnetic levitation system," *Jurnal Ilmiah Teknik Elektro Komputer dan Informatika*, vol. 5, no. 1, pp. 36–43, Jul. 2019.
- [12] D. H. Kim, T. H. Nguyen, P. S. Pratama, H. K. Kim, Y. S. Jung, and S. B. Kim, "Servo system design for speed control of AC induction motors using polynomial differential operator," *Int. J. Control, Autom. Syst.*, vol. 15, no. 3, pp. 1207–1216, Jun. 2017.
- [13] M. Haeri and M. S. Tavazoei, "CDM-based closed-loop transfer function design for ramp input," *Trans. Inst. Meas. Control*, vol. 33, no. 5, pp. 558–572, Jul. 2011.
- [14] M. S. Tavazoei, "Ramp tracking in systems with nonminimum phase zeros: One-and-a-half integrator approach," *J. Dyn. Syst., Meas., Control*, vol. 138, no. 3, Jan. 2016, Art. no. 031002.
- [15] Q. Zhao, Z. Qin, and J. Sun, "Influence of design reference on tracking performance of feedback control," *Trans. Tianjin Univ.*, vol. 24, no. 1, pp. 66–72, Jan. 2018.
- [16] K. G. Papadopoulos, E. N. Papastefanaki, and N. I. Margaris, "Explicit analytical PID tuning rules for the design of type-III control loops," *IEEE Trans. Ind. Electron.*, vol. 60, no. 10, pp. 4650–4664, Oct. 2013.
- [17] K. G. Papadopoulos, N. D. Tselepis, and N. I. Margaris, "Type-III closed loop control systems-digital PID controller design," *J. Process Control*, vol. 23, no. 10, pp. 1401–1414, Nov. 2013.

- [18] Y. Yu, H.-K. Lam, and K. Y. Chan, "T-S fuzzy-model-based output feedback tracking control with control input saturation," *IEEE Trans. Fuzzy Syst.*, vol. 26, no. 6, pp. 3514–3523, Dec. 2018.
- [19] W. Lin, Z. Lu, and W. Wei, "Asymptotic tracking control for wind turbines in variable speed mode," *IEEE/CAA J. Automatica Sinica*, vol. 4, no. 3, pp. 569–576, 2017.
- [20] C.-H. Lin and J.-C. Ting, "Novel nonlinear backstepping control of synchronous reluctance motor drive system for position tracking of periodic reference inputs with torque ripple consideration," *Int. J. Control, Autom. Syst.*, vol. 17, no. 1, pp. 1–17, Jan. 2019.
- [21] N. S. Nise, *Control Systems Engineering*, 7th ed. Hoboken, NJ, USA: Wiley, 2015.
- [22] J.-G. Sun, S.-M. Song, and G.-Q. Wu, "Fault-tolerant track control of hypersonic vehicle based on fast terminal sliding mode," *J. Spacecraft Rockets*, vol. 54, no. 6, pp. 1304–1316, Nov. 2017.
- [23] J. A. Moreno, "Asymptotic tracking and disturbance rejection of time-varying signals with a discontinuous PID controller," *J. Process Control*, vol. 87, pp. 79–90, Mar. 2020.
- [24] Z. Wang, Y. Su, and L. Zhang, "Fixed-time attitude tracking control for rigid spacecraft," *IET Control Theory Appl.*, vol. 14, no. 5, pp. 790–799, Mar. 2020.
- [25] N. Tan, "Computation of stabilizing PI-PD controllers," *Int. J. Control, Autom. Syst.*, vol. 7, no. 2, pp. 175–184, Apr. 2009.
- [26] C. Onat, "A new design method for PI-PD control of unstable processes with dead time," *ISA Trans.*, vol. 84, pp. 69–81, Jan. 2019.
- [27] I. Rizal, F. Arif, A. Firdausi, and G. P. N. Hakim, "Nebulizer operational time control based on drug volume and droplet size using fuzzy sugeno method," *J. Robot. Control*, vol. 2, no. 2, pp. 94–97, 2021.
- [28] X.-L. Lin, C.-F. Wu, and B.-S. Chen, "Robust H_∞ adaptive fuzzy tracking control for MIMO nonlinear stochastic Poisson jump diffusion systems," *IEEE Trans. Cybern.*, vol. 49, no. 8, pp. 3116–3130, Aug. 2019.
- [29] K. Ogata, *Modern Control Engineering*. Upper Saddle River, NJ, USA: Prentice-Hall, 2010.
- [30] J. Zhai, L. Gao, and S. Li, "Robust pole assignment for linear control systems in a circular region using novel global harmony search algorithm," *Int. J. Control, Autom. Syst.*, vol. 14, no. 3, pp. 713–722, Jun. 2016.
- [31] M. Hammouche, A. Mohand-Ousaïd, P. Lutz, and M. Rakotondrabe, "Robust interval luenberger observer-based state feedback control: Application to a multi-DOF micropositioner," *IEEE Trans. Control Syst. Technol.*, vol. 27, no. 6, pp. 2672–2679, Nov. 2019.
- [32] M. A. M. Cheema, J. E. Fletcher, D. Xiao, and M. F. Rahman, "A linear quadratic regulator-based optimal direct thrust force control of linear permanent-magnet synchronous motor," *IEEE Trans. Ind. Electron.*, vol. 63, no. 5, pp. 2722–2733, May 2016.
- [33] T. Jennawasin and D. Banjerpongchai, "Design of state-feedback control for polynomial systems with quadratic performance criterion and control input constraints," *Syst. Control Lett.*, vol. 117, pp. 53–59, Jul. 2018.
- [34] T. Tarczewski and L. M. Grzesiak, "An application of novel nature-inspired optimization algorithms to auto-tuning state feedback speed controller for PMSM," *IEEE Trans. Ind. Appl.*, vol. 54, no. 3, pp. 2913–2925, May 2018.
- [35] G. G. Koch, L. A. Maccari, R. C. L. F. Oliveira, and V. F. Montagner, "Robust H_∞ state feedback controllers based on linear matrix inequalities applied to grid-connected converters," *IEEE Trans. Ind. Electron.*, vol. 66, no. 8, pp. 6021–6031, Aug. 2019.
- [36] J. P. Coelho, T. M. Pinho, and J. Boaventura-Cunha, "Controller system design using the coefficient diagram method," *Arabian J. Sci. Eng.*, vol. 41, no. 9, pp. 3663–3681, Sep. 2016.
- [37] A. Ma'arif, A. I. Cahyadi, O. Wahyunggoro, and H. Herianto, "Servo state feedback based on coefficient diagram method in magnetic levitation system with feedback linearization," in *Proc. 3rd Int. Conf. Sci. Technol. Comput. (ICST)*, Jul. 2017, pp. 22–27.
- [38] A. Ma'arif, A. I. Cahyadi, and O. Wahyunggoro, "CDM based servo state feedback controller with feedback linearization for magnetic levitation ball system," *Int. J. Adv. Sci., Eng. Inf. Technol.*, vol. 8, no. 3, p. 930, Jun. 2018.



ALFIAR MA'ARIF (Member, IEEE) received the bachelor's degree from the Department of Electrical Engineering, Universitas Islam Indonesia, Indonesia, in 2014, and the M.Eng. degree from the Department of Electrical Engineering, Universitas Gadjah Mada, Indonesia, in 2017.

Since 2019, he has been a Lecturer with the Department of Electrical Engineering, Universitas Ahmad Dahlan. His research interests include control systems and computer programming.



ADHA IMA CAHYADI received the bachelor's degree from the Department of Electrical Engineering, Faculty of Engineering, Universitas Gadjah Mada, Indonesia, in 2002, the master's degree in control engineering from King's College London, UK, in 2005, Thailand, and the D.Eng. degree from Tokai University, Japan, in 2008.

He is currently a Lecturer with the Department of Electrical Engineering and Information Technology, Universitas Gadjah Mada. His research areas involve control systems, tele manipulation systems, and robotics.



SAMI HERDJUNANTO received the bachelor's degree from Universitas Gadjah Mada, Indonesia, the master's degree from Ohio State University, USA, and the Ph.D. degree from Universitas Gadjah Mada.

He is currently a Lecturer with the Department of Electrical Engineering and Information Technology, Universitas Gadjah Mada. His research area includes control systems.



OYAS WAHYUNGGORO received the bachelor's and master's degrees from Universitas Gadjah Mada, Indonesia, and the Ph.D. degree from Universiti Teknologi Petronas, Malaysia.

He is currently a Lecturer with the Department of Electrical Engineering, Universitas Gadjah Mada. His research area includes intelligent control systems.

...

Tracking Control of High Order Input Reference Using Integrals State Feedback and Coefficient Diagram Method Tuning

ORIGINALITY REPORT

17%

SIMILARITY INDEX

10%

INTERNET SOURCES

11%

PUBLICATIONS

6%

STUDENT PAPERS

PRIMARY SOURCES

- 1** Iswanto Iswanto, Alfian Ma'arif. "Robust Integral State Feedback Using Coefficient Diagram in Magnetic Levitation System", IEEE Access, 2020
Publication 1%
- 2** repository.umy.ac.id
Internet Source 1%
- 3** Submitted to Indian Institute of Technology Guwahati
Student Paper 1%
- 4** Abdul Rehman Khan, Ameer Tamoor Khan, Masood Salik, Sunila Bakhsh. "An Optimally Configured HP-GRU Model Using Hyperband for the Control of Wall Following Robot", International Journal of Robotics and Control Systems, 2021
Publication 1%
- 5** bpi.uad.ac.id
Internet Source 1%

6	Internet Source	1 %
7	"AETA 2015: Recent Advances in Electrical Engineering and Related Sciences", Springer Science and Business Media LLC, 2016 Publication	1 %
8	www.defaultrisk.com Internet Source	1 %
9	Iswanto Iswanto, Alfian Maarif. "Robust Integral State Feedback Using Coefficient Diagram in Magnetic Levitation System", IEEE Access, 2020 Publication	1 %
10	Chaochao Shen, Hao Zhong, Yang Zhang, Yiwen Tang, Yining Zhang. "Design Method of 6-Element Boundary Gain for LLC Resonant Converter of Electric Vehicle", IEEE Access, 2020 Publication	1 %
11	Submitted to SASTRA University Student Paper	<1 %
12	dokumen.pub Internet Source	<1 %
13	dro.dur.ac.uk Internet Source	<1 %

14 Iswanto Iswanto, Alfian Ma'arif, Bilah Kebenaran, Prisma Megantoro. "Design of gas concentration measurement and monitoring system for biogas power plant", Indonesian Journal of Electrical Engineering and Computer Science, 2021
Publication

15 Andreas P. Sandiwan, Adha Cahyadi, Samiadji Herdjunto. "Robust proportional-derivative control on SO(3) with disturbance compensation for quadrotor UAV", International Journal of Control, Automation and Systems, 2017
Publication

16 Qasem Al-Tashi, Said Jadid Abdulkadir, Helmi Md Rais, Seyedali Mirjalili, Hitham Alhussian. "Approaches to Multi-Objective Feature Selection: A Systematic Literature Review", IEEE Access, 2020
Publication

17 ijac.net
Internet Source

18 ujcontent.uj.ac.za
Internet Source

19 Submitted to University of Sydney
Student Paper

20

Internet Source

<1 %

21

Alla Eddine Toubal Maamar, M'hamed Helaimi, Rachid Taleb, Mostefa Kermadi, Saad Mekhilef, Addy Wahyudie, Muhyaddin Rawa. "Analysis and Small Signal Modeling of Five-Level Series Resonant Inverter", IEEE Access, 2021

Publication

<1 %

22

Iswanto Iswanto, Ahmad Ataka, Reka Inovan, Oyas Wahyunggoro, Adha Imam Cahyadi. "Disturbance Rejection for Quadrotor Attitude Control Based on PD and Fuzzy Logic Algorithm", International Review of Automatic Control (IREACO), 2016

Publication

<1 %

23

Submitted to University of Lincoln

Student Paper

<1 %

24

Submitted to Cork Institute of Technology

Student Paper

<1 %

25

V. Calderaro, C. Cecati, A. Piccolo, P. Siano. "Chapter 12 Adaptive Fuzzy Control for Variable Speed Wind Systems with Synchronous Generator and Full Scale Converter", Springer Science and Business Media LLC, 2010

Publication

<1 %

26 Ahmad Fadzil, M.H.. "Determination of foveal avascular zone in diabetic retinopathy digital fundus images", Computers in Biology and Medicine, 201007

Publication

<1 %

27 Alfian Ma'Arif, Wahyu Rahmaniar, Marco Antonio Marquez Vera, Aninditya Anggari Nuryono, Rania Majdoubi, Abdullah Cakan. "Artificial Potential Field Algorithm for Obstacle Avoidance in UAV Quadrotor for Dynamic Environment", 2021 IEEE International Conference on Communication, Networks and Satellite (COMNETSAT), 2021

Publication

<1 %

28 Submitted to Cranfield University

Student Paper

<1 %

29 beei.org
Internet Source

<1 %

30 id.scribd.com
Internet Source

<1 %

31 opus.bibliothek.uni-wuerzburg.de
Internet Source

<1 %

32 www.journalmt.com
Internet Source

<1 %

33 Md. Asif Hasan, Raj Kumar Mishra, Srishti Singh. "Speed Control of DC Motor Using

<1 %

Adaptive Neuro Fuzzy Inference System Based PID Controller", 2019 2nd International Conference on Power Energy, Environment and Intelligent Control (PEEIC), 2019

Publication

34

Qiang Gao, Shasha Chen, Yi Li, Junfang Li. "A largely model independent solution for the position control of a typical inverted pendulum system", Proceedings of the 33rd Chinese Control Conference, 2014

Publication

<1 %

35

coek.info

Internet Source

<1 %

36

journal2.uad.ac.id

Internet Source

<1 %

37

www.scribd.com

Internet Source

<1 %

38

A. Preumont. "Chapter 10 Analysis and Synthesis in the Frequency Domain", Springer Science and Business Media LLC, 2011

Publication

<1 %

39

Qianwen Duan, Yao Mao, Hanwen Zhang, Wenchao Xue. "Add-on integration module-based proportional-integration-derivative control for higher precision electro-optical tracking system", Transactions of the Institute of Measurement and Control, 2021

Publication

<1 %

40 R. Cordero, T. Estrabis, G. Gentil, E. A. Batista, C. Q. Andrea. "Development of a Generalized Predictive Control System for Polynomial Reference Tracking", IEEE Transactions on Circuits and Systems II: Express Briefs, 2021
Publication <1 %

41 Yuxi Cai, Yingjie He, Hongwei Zhou, Jinjun Liu. " Active-Damping Disturbance-Rejection Control Strategy of Grid-Connected Inverter Based on Inverter-Side-Current Feedback ", IEEE Journal of Emerging and Selected Topics in Power Electronics, 2021
Publication <1 %

42 acris.aalto.fi
Internet Source <1 %

43 indonesiamengglobal.com
Internet Source <1 %

44 www.coursehero.com
Internet Source <1 %

45 www.mdpi.com
Internet Source <1 %

46 David E. Bossert, Steven L. Morris, Wayne F. Hallgren, Thomas R. Yechout. "Introduction to Aircraft Flight Mechanics", American Institute of Aeronautics and Astronautics (AIAA), 2003
Publication <1 %

47

Sadjad Madanzadeh, Ali Abedini, Ahmad Radan, Jong-Suk Ro. "Application of quadratic linearization state feedback control with hysteresis reference reformer to improve the dynamic response of interior permanent magnet synchronous motors", ISA Transactions, 2019

Publication

<1 %

Exclude quotes On

Exclude matches Off

Exclude bibliography On