

# A DIGITAL BEAM-PHASE CONTROL SYSTEM FOR A HEAVY-ION SYNCHROTRON WITH A DOUBLE-HARMONIC CAVITY SYSTEM\*

J. Grieser<sup>†</sup>, D. Lens, IAT, TU Darmstadt, Germany

U. Hartel, TEMF, TU Darmstadt, Germany

H. Klingbeil, TEMF, TU Darmstadt; GSI, Darmstadt, Germany

U. Laier, K.-P. Ningel, S. Schäfer, B. Zipfel, GSI, Darmstadt, Germany

## Abstract

For the new Facility for Antiproton and Ion Research (FAIR) at GSI Helmholtzzentrum für Schwerionenforschung GmbH (<http://www.gsi.de>), the heavy-ion synchrotron SIS18 will be operated with a double-harmonic cavity system. The second cavity, running at twice the fundamental frequency, is used to create a lengthened bucket which introduces nonlinearities to the control system.

To damp longitudinal rigid dipole oscillations a digital feedback system consisting of a filter and an integrator is used. For the existing single-harmonic setup an FIR-filter is implemented which realizes a multiple bandpass filter with the first passband centre frequency close to the synchrotron frequency. Both, the feedback gain and the passband frequency of the filter depend on the actual value of the synchrotron frequency.

It was shown by simulations and in an experiment that this setup can be transferred to a double-harmonic cavity system obtaining similar results for the region of stabilizing feedback parameters, if the oscillation frequency of the bunch barycenter is considered instead of the synchrotron frequency of a linearized bucket.

## DOUBLE-HARMONIC CAVITY SYSTEM

After construction of the new accelerator facility, the particles in SIS 18 will be accelerated by the combined radio frequency voltage

$$V(\varphi) = \hat{V}_1 \sin(\varphi - \varphi_{gap}) + \hat{V}_2 \sin(2\varphi - 2\varphi_{gap} + \psi) \quad (1)$$

where  $\varphi = \omega_{RF}t$  is the phase of a particle crossing the cavity at time instant  $t$ ,  $\varphi_{gap}$  is the actuating variable which is used to damp the dipole oscillations and  $\psi$  is a rigid phase shift between the cavities taking into account their positions in the ring.  $\hat{V}_2$  and  $\psi$  are chosen depending on  $\hat{V}_1$  and the desired voltage  $V_R = V(\varphi_R)$  seen by the synchronous (or reference) particle in order to create a saddle point at  $\varphi_R^1$  as can be seen in Fig. 1 [1].

\* The project described in this paper was accomplished by using the infrastructure of GSI Helmholtzzentrum für Schwerionenforschung GmbH. The author alone is responsible for its content.

<sup>†</sup> jgrieser@rtr.tu-darmstadt.de

<sup>1</sup> Throughout this paper the index  $R$  indicates values referring to the reference particle.

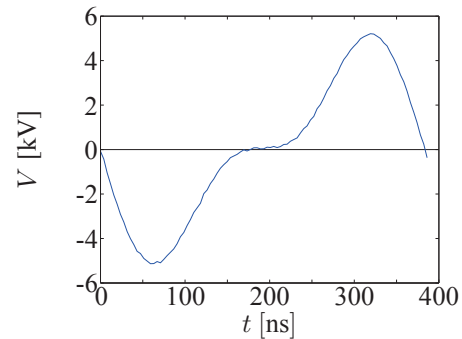

Figure 1: Double harmonic RF voltage according to (1) as it was realized in the experiment ( $V(\varphi_R) = 0$  and  $\hat{V}_1 = 4$  kV).

It is obvious that the resulting voltage can not be linearized around  $\varphi_R$  as it is usually done in the single-harmonic case to calculate the oscillation frequency of the bunch barycenter (further denoted as *coherent synchrotron frequency*  $f_{syn,coh}$ ). However, an estimation of the coherent synchrotron frequency is possible if the length of the bunch is known [2, 3].

## CONTROL LOOP

An overview of the feedback loop is given in Fig. 2. Electrical (analog or digital) signals are marked with a black arrow while optical signals are indicated by a dashed red arrow.

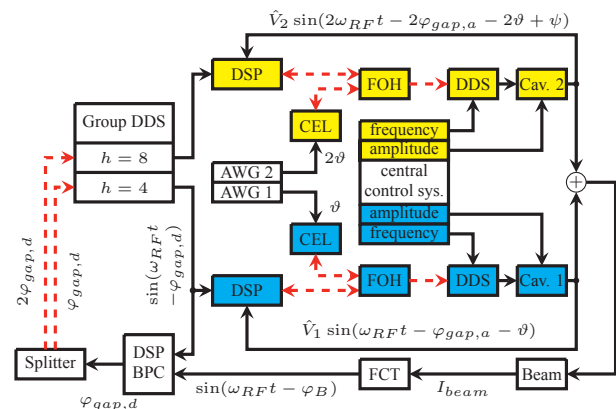

Figure 2: Feedback loop.

The cavities are each driven by a Direct Digital Synthe-

sizer (DDS) creating a sinusoidal signal with the respective frequency. Cavity 1 runs with  $h = 4$  and cavity 2 with  $h = 8$ , where  $h = \frac{\omega_{RF}}{\omega_R}$  is the harmonic number. To each gap voltage an additional phase shift  $\vartheta$  (respectively  $2\vartheta$ ) can be applied by means of an input voltage at the Calibration Electronics Modules (CEL). This is done with an arbitrary wave generator (AWG) which is used to excite dipole oscillations. Communication between the CEL, the cavity DSP and the cavity DDS is accomplished by a Fiber Optical Hub (FOH) which is also connected to the central control system (not shown in Fig. 2).

Both cavities synchronize with a group DDS signal whose phase can be changed by the splitter which doubles the desired phase shift  $\varphi_{gap,d}$  at its input for the second cavity. Beam phase control is realized in the digital signal processor (DSP) indicated with 'DSP BPC' in Fig. 2. It consists of a phase detector, a digital filter and an integrator as can be seen in Fig. 3.

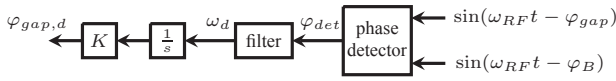

Figure 3: Block diagram of the beam phase control DSP algorithm.

The phase detector computes the phase difference  $\varphi_{det} = \varphi_B - \varphi_{gap}$  where  $\varphi_B$  is the phase of the barycenters of the bunches which are assumed to oscillate coherently. Up to now no bunch-by-bunch control is implemented for SIS 18 and in the experiment all bunches are excited with the same phase shift. The filter in Fig. 3 is an FIR-filter with the following transfer function, which was introduced in [4] and further discussed in [5]:

$$H_F(z) = -\frac{1}{4} + \frac{1}{2}z^{-1/(2T_s f_{pass})} - \frac{1}{4}z^{-1/T_s f_{pass}} \quad (2)$$

where  $f_{pass}$  is the passing frequency of the filter. The parameter  $K$  is used to change the total gain of the feedback.

Note that the sum of the filter coefficients equals zero which results in a suppression of any input offset. Furthermore all even multiples of the passing frequency are suppressed. Integration is realized by the sum

$$\varphi_{gap}(n) = K \cdot (\omega_d(n-1) + H_F \cdot \varphi_{det}(n)) \quad (3)$$

which is performed every  $T_s = 3.22 \mu s$ . At passing frequency, the filter supplies a phase shift of  $180^\circ$  resulting in a total phase shift of  $-90^\circ$  for the complete feedback if no time delays are present.

## SIMULATION AND EXPERIMENTAL RESULTS

In this section the results of macro particle simulations are compared to the measurements taken during a beam experiment which took place on November 21st/22nd 2012 [6]. After acceleration (at a kinetic beam energy of  $E_{kin} =$

$120 \frac{MeV}{u}$ ) the bunch was excited to perform dipole oscillations by shifting the gap voltage of cavity 1 by  $\vartheta = 20^\circ$  and of cavity 2 by  $2\vartheta = 40^\circ$  as can be seen in Fig. 4.

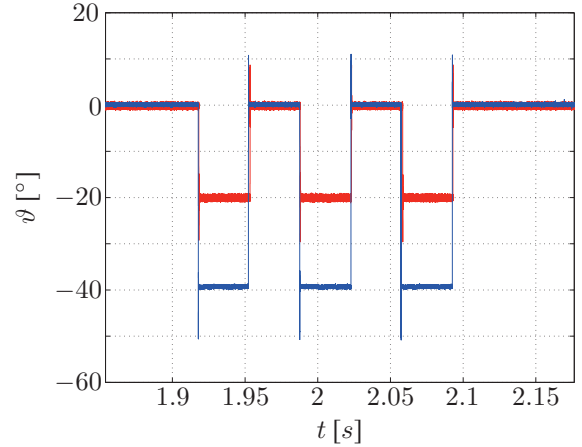

Figure 4: Phase shift  $\vartheta$  (resp.  $2\vartheta$ ) applied in the experiment: **cavity 1**, **cavity 2**.

At the same time the feedback-loop was closed, i. e. acceleration of the beam was done in open-loop mode. Tab. 1 gives an overview over the parameter specifications in the simulation and the experiment.

Table 1: Parameter specifications for simulation and experiment

parameter	value
ion type	$^{283}\text{Uranium}^{73+}$
number of ions	ca. $5 \cdot 10^8$
kinetic energy	$E_{kin} = 120 \frac{MeV}{u}$
gap voltages	$\hat{V}_1 = 4 \text{ kV}, \hat{V}_2 = 2 \text{ kV}$
coherent synchrotron frequency	$f_{syn,coh} \approx 780 \text{ Hz}$
phase shift for dipole oscillation	$\vartheta = 20^\circ$
phase shift for double-harmonic operation	$\psi = 180^\circ$
harmonic number (fundamental frequency)	$h = 4$

Fig. 5 shows the simulated relative emittance for the feedback parameters  $K$  and  $f_{pass}$  limited to twice the initial value for sake of clarity.

It is worth noticing that better results are obtained in the region between  $f_{pass} = f_{syn,coh}$  and  $f_{pass} = 1.5f_{syn,coh}$ . Changing the passing frequency leads to a phase shift for the desired frequency compensating time delays as can be seen in Fig. 6 showing the phase response of the filter for  $f_{pass} \approx 1.3f_{syn,coh}$ .

Fig. 7 shows the dipole oscillation with an open control loop while the closed-loop case can be seen in Fig. 8, both at a phase shift from  $\vartheta = -20^\circ$  to  $\vartheta = 0^\circ$  according to

Fig. 4. Both plots are not offset compensated.

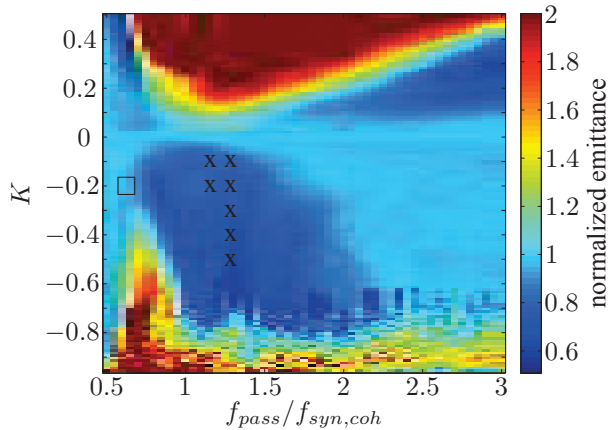

Figure 5: Simulation and experimental results: the color indicates the emittance growth normalized to the open-loop case. An 'X' denotes a stable and a square an unstable setting in the experiment.

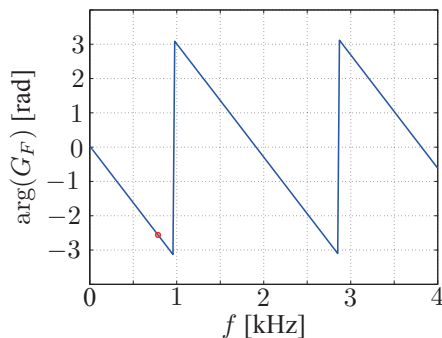

Figure 6: Phase response of filter (2) for  $f_{pass} = 1$  kHz. The red dot marks the value at  $f = f_{syn,coh} = 780$  Hz.

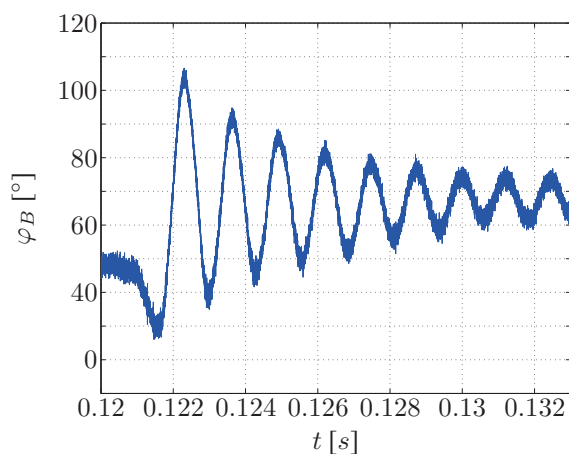
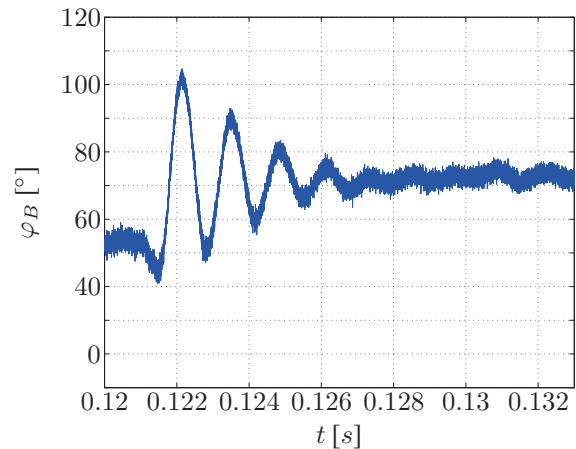

Figure 7: Measured dipole oscillation in open-loop case.

## CONCLUSION AND OUTLOOK

It was demonstrated in an experiment that longitudinal rigid dipole oscillations can be damped by feeding back the phase difference between the bunch barycenter and the gap

Figure 8: Measured dipole oscillation in closed-loop case with  $K = -0.1$  and  $f_{pass}/f_{syn,coh} \approx 1.3$ .

voltage with an FIR-filter and an integrator if the oscillation frequency of the bunch barycenter is known. Furthermore, the beam behaviour in the closed-loop case can be simulated accurately. The bunches were effectively damped even for large disturbances with high oscillation amplitudes.

Future work will consider beam phase control with a dual-harmonic cavity system also during acceleration of the beam, as well as bunch-by-bunch control.

## ACKNOWLEDGMENT

The authors would especially like to thank C. Thielmann and A. Klaus for their contribution to the machine experiment. We are also grateful to the staff members from several departments of GSI, including Accelerator Operation, Synchrotrons and Beam Instrumentation.

## REFERENCES

- [1] K.-P. Ningel et al., "Dual Harmonic Operation at SIS 18", Proceedings of IPAC 2010, Kyoto, Japan, 2010
- [2] O. Boine-Frankenheim et al., "Space Charge Effects in Bunches for Different RF Wave Forms", Phys. Rev. Special Topics - Accelerators and Beams 8, 2005
- [3] J. Grieser et al., "A Method to Obtain the Frequency of the Longitudinal Dipole Oscillation for Modelling and Control in Synchrotrons with Single or Double Harmonic RF Systems", Proceedings of IPAC 2012, New Orleans, USA, 2012
- [4] H. Klingbeil et al., "A Digital Beam-Phase Control System for Heavy-Ion Synchrotrons", IEEE Trans. Nucl. Science, Vol. 54, No. 6, 2007
- [5] J. Grieser et al., "Comparison of Filter Designs for a Digital Beam-Phase Feedback System in a Heavy-Ion Synchrotron", accepted for 21st Mediterranean Conference on Control and Automation, Chania, 2013
- [6] H. Klingbeil et al., "Beam experiment: Dual-Harmonic Beam Phase Control in SIS 18", GSI Darmstadt, internal note 07012013, Nov. 2012