

## **CLEANING GENIE: AN INTERNATIONAL CASE STUDY IN INTEGRATED PRODUCT DEVELOPMENT**

Lawrence Farrugia<sup>1</sup>, Laura Roa Castro<sup>2</sup>, Nesrine Ben Beldi<sup>3</sup>, Andreas Wünsch<sup>4</sup>,  
Jens Hagman<sup>5</sup>, and Zsuzsa Drágár<sup>6</sup>

<sup>1</sup>Concurrent Engineering Research Unit, University of Malta, Malta

<sup>2</sup>IRT SystemX, Ecole Centrale Paris, France

<sup>3</sup>PSA Peugeot Citroen, ENSAM, France

<sup>4</sup>Otto-von-Guericke University Magdeburg, Germany

<sup>5</sup>Royal Institute of Technology, Sweden

<sup>6</sup>University of Miskolc, Hungary

*Keywords: Integrated Product Development, Cleaning Delicate Objects, International Collaboration, Interdisciplinarity*

### **ABSTRACT**

This paper documents the product development project that was carried out following the first session of the Integrated Product Development Summer School (ipdISS14). The first part of this summer school was held in Malta in May 2014. The second part was held in Magdeburg in September. The team was comprised of six members from five EU institutions and the aim of the project was develop a cleaning solution for delicate objects by using an Integrated Product Development methodology. The report presents the process in detail as well as important lessons learned. The final solution proposed, *Cleaning Genie*, is a cleaning add-on for cordless screwdrivers for the consumer market.

Many households are lacking effective and cost efficient means of cleaning delicate objects, little did they know that the common cordless screwdriver that most of them have in their toolbox together with the affordable *Cleaning Genie* add-ons can solve their cleaning problems. *Cleaning Genie* is targeting an enormous consumer market by applying bundling and low price strategies.

### **1 INTRODUCTION**

This report is part of a product development project that was made by a multinational interdisciplinary team aiming to develop an artefact for cleaning delicate objects. The product was developed based on the need to provide customers with a *cost-effective* and *simple* solution, which *does not require the use of aggressive chemicals* for the purpose of cleaning delicate objects made out of porcelain and glass.

The objective of the assigned product development project was to:

1. Enable the participants of the summer school to experience a typical product development process. Such a process is typically attributed by the need to work both together as well as independently and in parallel.
2. To provide the opportunity to stakeholders to experience and address challenges pertaining to logistical issues, project execution, and multiple (often conflicting) concurrent views.
3. Enable the participants to conduct a product development exercise that entails the use of support tools such as quality function deployment, morphological matrix, and function means tree.

4. Allow the project members to develop a product by considering not only design issues but also to take into consideration business and manufacturing aspects.
5. To develop a product intended to clean delicate objects such as wine glasses and porcelain objects.

The team was comprised of six members from five EU institutions. The project team met on a weekly basis in order to discuss current development issues while planning short and long term goals. A minutes and task agenda was created in order to follow the work. Between meetings the team worked in parallel. In addition the team reported the project to Prof. Sándor Vajna and Prof. Jonathan Borg, who were the organizers of the summer school. The team used various online collaboration tools such as *Google Hangouts*, *Dropbox*, and *Google Drive*.

## 2 PRODUCT DEVELOPMENT PHASES

The product development project was comprised of 5 phases. The upcoming chapters in this document will explain the underlying processes and rationale behind the decisions made throughout each phase of the project.

- Phase 0: Recognition of Need
- Phase 1: Investigation of Need
- Phase 2: Product Principle
- Phase 3: Product Design
- Phase 4: Product Preparation and Execution

The sections describe the objective of each phase in the product development process, outline the product development support tools/methods employed, identify the difficulties encountered if any, and outline the outcomes emanating from each of the described phase.

## 3 PHASE 0: RECOGNITION OF THE NEED

The objective of this stage was to understand the structure of the customer requirements. This was achieved through the creation of a survey questionnaire. The responses obtained from the survey questionnaire were analysed and summarised. The survey was compound of five questions aiming to define the users profile, to delimit the term of a delicate object, and to explore typical means for cleaning. The results are shown in Figure 24.

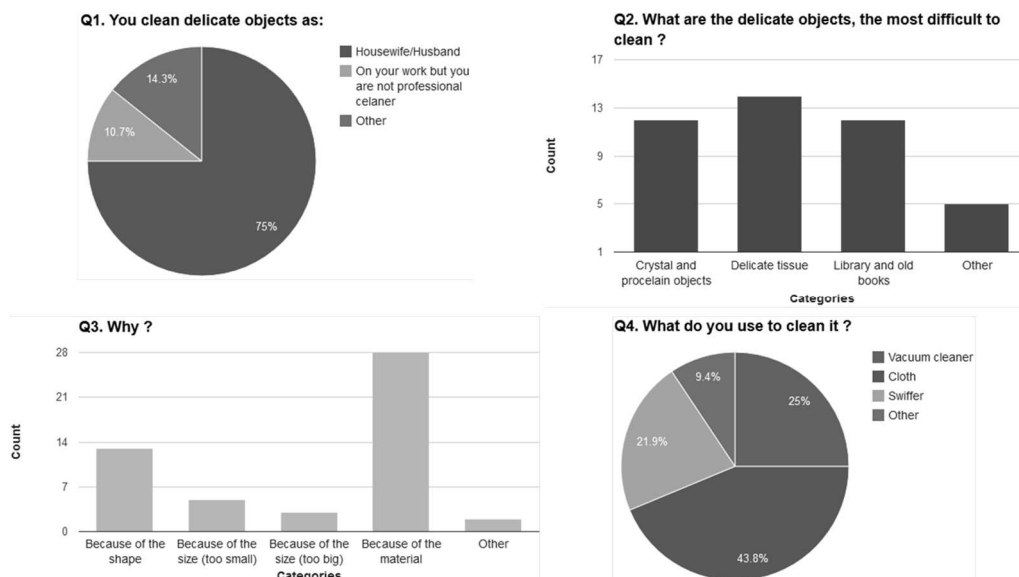

Figure 24: Results of the survey questionnaire

From the survey results, the main decisions were:

1. Focus the system to clean the objects in a home use context more than in a professional one.
2. Concentrate the effort on porcelain and crystal objects, but keeping in mind the need of a universal solution allowing the books cleaning also.
3. To proceed by defining the particular space on the market and to get some inspiration how delicate objects can be cleaned the team did a research on existing solutions on the market.

There are many interesting solutions, how delicate objects with their external and internal surfaces can be cleaned. The market results showed very useful solutions for cleaning and polishing wine decanters by hand and polishing glasses and floors automatically. The team also found some extraordinary gadgets like an ultrasonic cleaner or a cleaning putty. Apart from industrial solutions for cleaning that exists in the market, such as the ones mentioned before, chemical and physical solutions can be used for cleaning purpose. These types of products are not necessarily commercialized in the market but constitute the basic substances for cleaning.

#### 4 PHASE 1: INVESTIGATION OF THE NEED

Following the research into existing artefacts and the analysis of the approach obtained from a web-based survey questionnaire, Quality Function Deployment (QFD) was used in order to list the customer requirements and investigate how these requirements are fulfilled via predefined specifications. The result of the QFD is the House of Quality [Ak90]. Figure 25 illustrates the House of Quality that was used throughout this phase of the product development process.

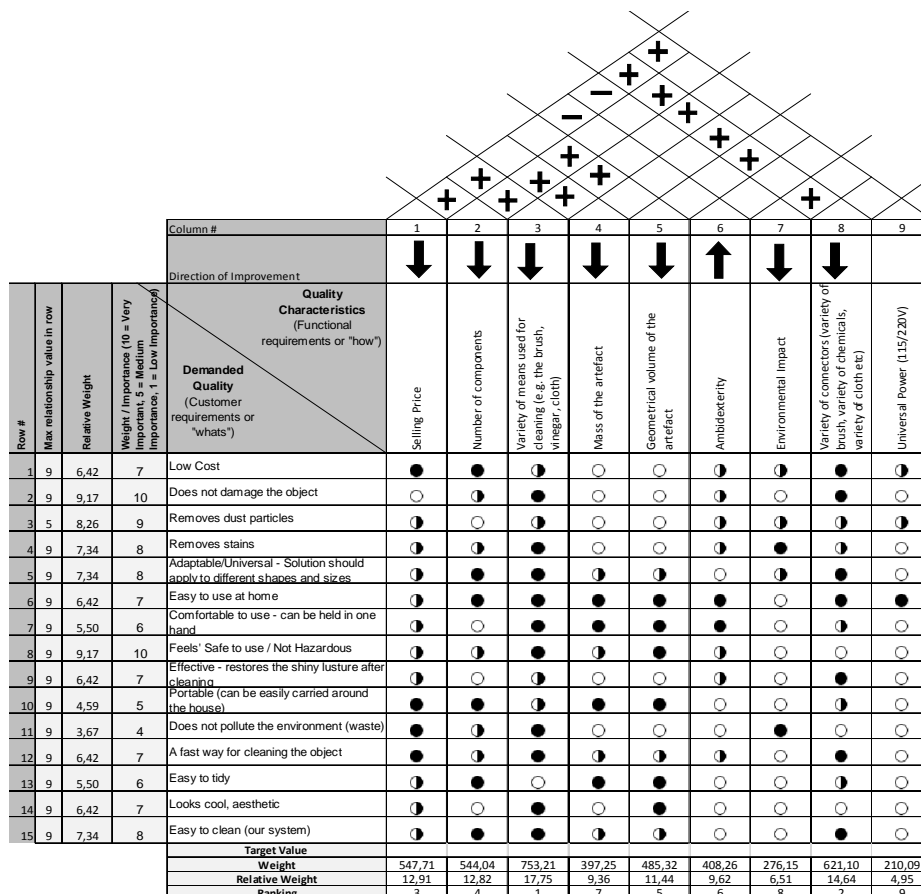

Figure 25: House of Quality

Based on the inputted data a score is assigned to each technical requirement of the product. The score is based on the strength of the interrelationships between customer requirements, the technical

specifications and the relative importance of each customer requirement. The technical requirements are ranked based on the respective scores that they obtained.

A high score, e.g. one that is obtained by the variety of means, indicates that the fulfilment of this particular technical requirement has a profound influence on a wide variety of customer needs. Hence if this technical requirement is not fulfilled by the artefact to be developed, many of the customer needs will also remain unfulfilled.

## 5 PHASE 2: PRODUCT PRINCIPLE













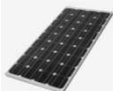

In the conceptual design phase the essential problems are identified through abstraction, establishing function structures, searching for appropriate working principles and combining these into a working structure, the product concept [PB07].

For the conceptual design the team decided to use the Morphological Box [Zw66] and created different concepts of the product. This stage of the product development process represents the most important stage because all decisions made here define the fundamental properties and behaviour of the product. Furthermore this is a very creative stage. Due to this reasons the work at this stage was not done in parallel, basically, because all members of the team needed to be involved into the creativity process.

### 5.1 Conceptual Design: Morphological Box

A division of the major task of the product was done. The resulting tasks were separated into several sub-functions and collected in a morphological box. For the various sub-functions the morphological box was filled with different solutions and then, the team worked on the principles of each solution. Table 10 shows an extract of the morphological box.

Table 10: Extract of the morphological box

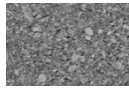
Solution Sub-functions		Solution						
		1	2	3	4	5	6	7
1	Delivering energy	 Hand Operated	 Battery	 Solar	 Electrical Socket			
2	Removing dust particles (mechanically)	 No Means	 Blowing Air	 Sucking Air	 Cloth	 Ultrasonic (Vibrations)	 Brushes	 Sticky Surface
3	Provide ample grip (does not slip from hand)	 No Means	 Rubber Surface	 Foam	 Cork			

In this stage of the product development process the team had a lot of discussions. The morphological box was filled in a meeting by all team members to generate synergies in the creativity process. This step was kind of a bottleneck in the development process because no one worked in parallel at this time and everybody worked on the same task. However, involving all team members was very important to slow down and find good solutions and an applicable product concept.

## 5.2 Evaluation of Synthesised Design Concepts

An important phase in the product development project was the evaluation of the generated concepts. In total five concepts were generated. The simple added weight (SAW) approach was used to evaluate the concepts. The reason for choosing this particular multiple criteria decision making technique was due to its inherent simplicity and ability to produce clear results.

Following the generation of concepts, the next step in the evaluation process was to identify the evaluation criteria. Reference was made to relevant documentation pertaining to QFD in order to identify key technical requirements. Following the evaluation process and further evaluation the team agreed that concept C2 should be chosen and developed further as illustrated in Figure 26.

This concept is like the Black and Decker mouse but for cleaning. The main body contains a tank for white vinegar or any kind of detergent and a motor to rotate the flexible wash pillow. by using the manual pump it is possible to moisten the wash pillow. To use the wash pillow for polishing, we need s.th. to wring it out by "one button". That's the weakness of this concept.

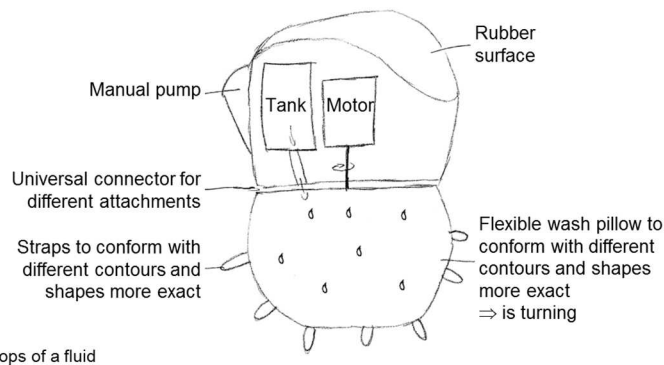

Figure 26: The selected concept C2

## 6 PHASE 3: PRODUCT DESIGN

After deciding about the concept the team wanted to develop the product, it's important to start defining the technical specifications for it. This work was done in three phases:

1. The study of the technical possible and realistic solutions that can be adopted
2. The definition of system performances and requirements to include
3. The consideration of the design constraints that have to be solved and to be taken into account.

Each phase allowed defining accurately the system that the team wanted to design regarding the constraints with respect to the customer requirements and system performances. In order to design the wash pillow add-on, the following points had to be considered:

- A technical system for holding it
- A system for giving it the required power
- A safety and maintenance system

Basically, there are two types of holding for screwdrivers that can be used for the add-on as illustrated in Figure 27.



Figure 27: Types of add-ons ([online01], [online02])

The two systems are composed mainly from the same parts and have the same technical specifications apart from the cleaning part device. The main body composed of a screwdriver, like the one presented in Figure 27, allows an automatic functioning and rotation of the connector part holding the cleaning device.

## 6.1 Designing the technical solution

From the technical specifications, a first solution for the add-on was designed as shown in Figure 28. This first design solution allowed the team to fix more accurately the design constraints that were considered for the optimization process.

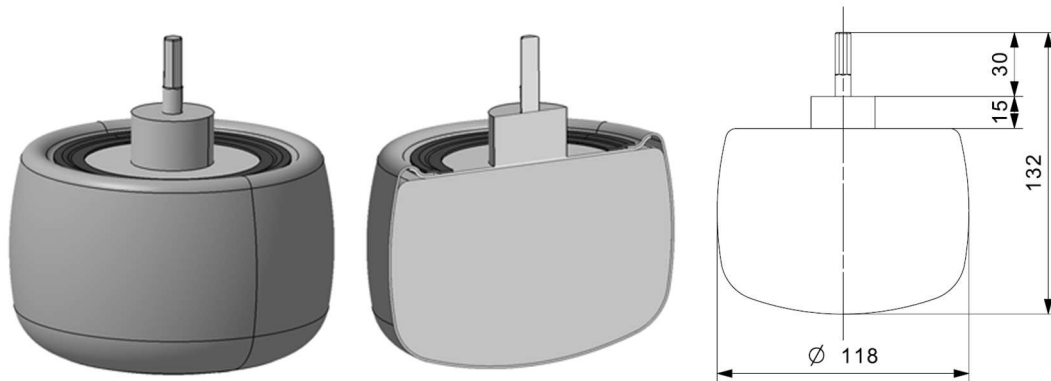

Figure 28 : First design solution

In order to optimize the add-on, a mathematical optimization algorithm based on the gradient descent method was used. For use comfort, the shape of the cleaning part was changed in order to easy attempt all kinds of surfaces. Figure 29 shows the optimized shape of the add-on.

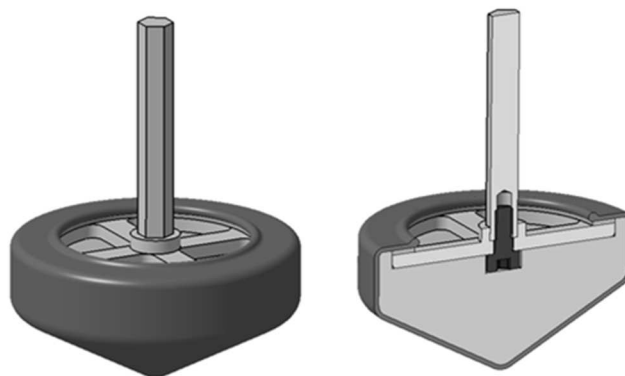

Figure 29: Optimised design solution for add-on #1

The important components of the solution are:

- A *main shaft* that transmits the rotating torque from the electric motor of the screwdriver to the add-on and that holds all other parts of the add-on and contains the connector.
- A *flywheel ring* that is the base plate for the cleaning components (the sponge and the skin). It rotates with the axe and the cleaning parts. Due to this fact its inertial centre is defined in the axe of the main shaft.
- The *cleaning body* (the skin and the sponge) is mounted through a clip on the flywheel ring and thus is rotating at the same speed of the flywheel and the main shaft. It has a conic shape in order to attain all kind of area to clean such us corners.

The same work was done to design the second add-on which is shown in Figure 30. The new main shaft length and flywheel dimensions and also the length of the cleaning part were calculated. The

main shaft for this solution is shorter than the first add-on for maintaining issues while the add-on is rotating. The cleaning body is made of simple tissue such the one used for cleaning human faces etc. and as for the first add-on, the main shaft and the flywheel can be made from plastic or steel.



*Figure 30: Optimised design solution for add-on #2*

## **7 PHASE 4: PRODUCT PREPARATION AND EXECUTION**

### **7.1 Manufacturing Plan**

In order to choose the materials to be used for the add-on and to design the manufacturing process, each component of the add-on was handled separately.

#### **7.1.1 Material Selection**

Material selection was done regarding the properties and specification of the product, and comparing different materials accomplishing selected features. The decision for the skin was to use microfibre clothes, in order to improve the shine of the object through lower laundering costs and a longer life cycle.

#### **7.1.2 Manufacturing Process**

Figure 8 shows a hierarchy of manufacturing process. For the project primarily shaping process, assembly, and test processes only were used. This decision is based on the simplicity of the add-on. The choice of different shaping process for each part was done taking in account the material to be employed and the volume to be produce by using the PRIMA selection matrix [SB13].

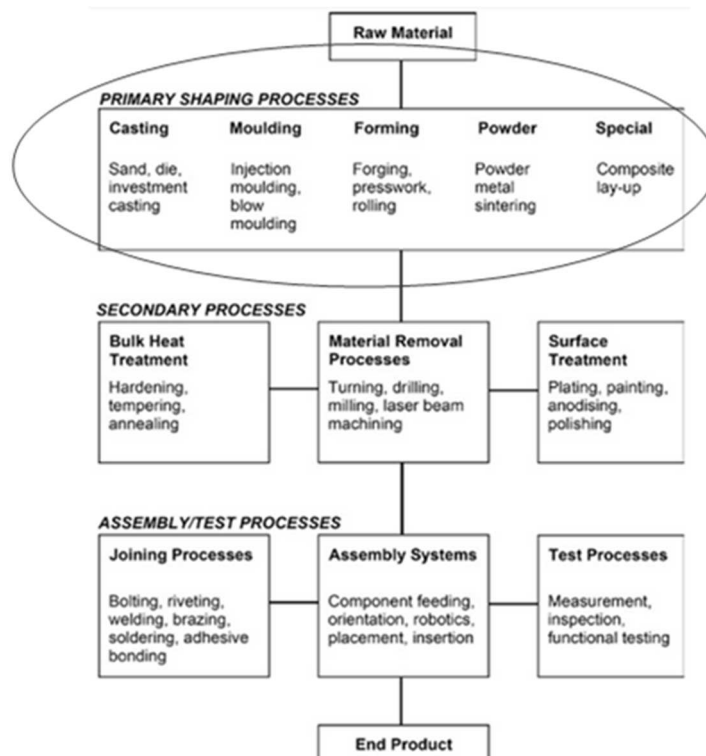

Figure 31: Hierarchy of Manufacturing Processes [SB13]

The decision concerning the assembly and tests processes was taken regarding mainly the assembly system selection chart. A production of 1.000 to 10.000 units is the approach for the first year. In this case, the decision for the assembly process is the manual one as recommended on Figure 32.

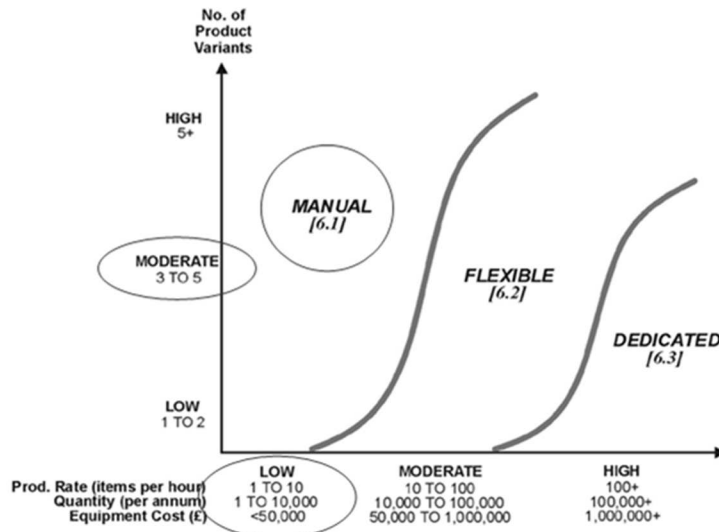

Figure 32 : Assembly System Selection Chart [SB13]

## 7.2 Business Plan

The aim is to sell *Cleaning Genie* through traditional online and offline retailers as well as through an own online store. A conventional retail business model will be used. When distributing to retailers the team aims for a mark-up of 2 of net production cost. Retailers normally price consumers goods to end customers at a mark-up of 2,5. Retailers tend to be sensitive to producers undercutting them in price through direct sales.



But the team envisaged an online store to sell *Cleaning Genie* for the same price as traditional retailers since the team acknowledges the importance of gaining the reach of traditional retailers. The benefits with these pricing strategies are significant larger margins compared to selling to retailers when selling through the envisaged own online store.

**7.3 Target Market**

Two market segments, the market for cordless drills and the market for delicate cleaning objects, drive the market for the *Cleaning Genie*. Its target customer is a household that owns a cordless screwdriver and also has a need to clean delicate objects. First step in the market analysis is hence to estimate the number of households that own a cordless screwdriver. Unfortunately, the amount of available data and reporting from major producers is limited, likely due to a fiercely competitive marketplace where sales data is a closely guarded secret.

In order to make reasonable estimates the team needed to rely on aggregated market size and count backwards with reasonable estimates. The market for electric drills is estimated to be worth close to 5 billion USD by the year 2009. For the market for power tools as a whole they estimated that cordless would be around 25% also at close to 5 billion USD. In this estimate the team members choose to make a conservative approximation that the global market for cordless drills would be worth around 2 billion USD, reflecting the higher growth rate for cordless compared to plug-in drills.

In order to estimate the total sales in units one has to find out the average consumer price for cordless drills. A search on Amazon.com reveals a significant difference in price between different types and sized cordless screwdrivers, with prices from 3,5 USD to 200 USD. For simplicity reasons the team members assume a mean price of 50 USD. Table 11 summarises these findings and concludes that it can be estimated that around 40 million units of cordless drills are sold globally on an annual basis. Assuming in a conservative manner that the average lifespan of a cordless drill is 5 years and due to the uncertain nature of the estimates no growth rates have been seen during the last 5 years gives a of 200 million units of functioning cordless drills on the global market place. The team members estimate that around 80% of those are owned by private households, which results in a total addressable market of 160 million households.

*Table 11: Market data*

Market size of electric drills	5 billion USD
Cordless power tools (share of total)	20%
Market size of cordless drills	2 billion USD
Cordless drills (annual units sold)	40 million units

**7.4 Marketing strategies**

*Cleaning Genie* targets the mass consumer market, a market notorious for its high barriers in terms of marketing costs. Therefore the authors believe it to be of high importance to apply conventional as well as unconventional marketing strategies in order to reach the mass market consumers. Ideally, marketing efforts should be undertaken to increase brand awareness in all sales channels, i.e. traditional retailers and the *Cleaning Genie* web shop.

The below list reveals some of the marketing strategies planned to be undertaken.

- *Direct sales to retailers:* Although labour and resource intensive, it is of high importance to establish a contact with large retailers such as Home Depot and Lowe’s in the US and Kingfisher in

Europe. This initial contact will require first extensive sales efforts in terms of materials and meetings, and in the long run also extensive price negotiations.

- *Bundling together with cordless screwdrivers*: Possibilities exist to bundle the *Cleaning Genie* together with existing cordless screwdrivers on the market. This could be made possible through partnerships with producers such as Bosch and Black+Decker. This would create a win-win situation since the added features of the cordless screwdriver could lead to increased sales for the producer and *Cleaning Genie* alike. In similarity with direct sales to retailers will the bundling strategy demand significant time and resources but with the added benefit that, if successful, it would utilize existing distribution and sales channels through the producers.
- *Online marketing*: In the new economy there are plenty of means to achieve big results with frugal budgets, provided that the offering is appealing enough. Through the use of inexpensive yet well produced videos on YouTube the *Cleaning Genie* team aims to attract attention to this new form of cleaning in a fun and engaging way. Efforts will also be undertaken for marketing on Google, ads on Facebook and other more viral activities (competitions etc.) on social media in general. In addition to driving sales to the *Cleaning Genie* web shop, these activities could increase brand awareness that would simplify the direct sales process towards retailers and producers.

## 8 LESSONS LEARNED

This paper is the result of the product development project that was carried out following the first session of the Integrated Product Development Summer School that was held in Malta between the 5th and 9th of May 2014. The team was comprised of six members from five EU institutions. The team developed a cleaning solution for delicate objects by using an Integrated Product Development methodology. The main lessons learned are the following:

- The initial phases of product development require continuous and persistent communication among all team members.
- The characteristic fuzziness of the initial phases makes it difficult for product development stakeholders to work in parallel.
- The early phases of product development have a significant influence on subsequent phases and issues such as manufacturing and assembly.
- A good product development process needs an *inter-disciplinary team* in order to develop the product from different perspectives.
- A structured product development approach can enable product development stakeholders to develop a product which takes into consideration cost, time and quality issues.

## REFERENCES

- [Ak90] Akao, Y.: *Quality function deployment: Integrating customer requirements into product design*, Productivity Press, Cambridge, Mass, 1990
- [online01] <http://www.powertoolsdirect.com/dewalt-dcf680g2-motion-activated-screwdriver-7-2-volt-2-x-1-0ah-li-ion>, 30.08.2014
- [online02] <http://trenddokument.com/2010/10/27/bosch-ixo-vino-akkuschrauber-fur-genieser/>, 30.08.2014
- [PB07] Pahl, G.; Beitz, W.; Feldhusen, J.; Grote, K.-H.: *Engineering Design - A Systematic Approach*, 3<sup>rd</sup> Edition, 2007
- [SB13] Swift K.G.; Booker J.D.: *Manufacturing process selection Handbook*, 1<sup>st</sup> Edition, 2013
- [Zw66] Zwicky, F.: *Entdecken, Erfinden, Forschen im Morphologischen Weltbild*. München: Droemer- Knaur 1966–1971.