



## BIROn - Birkbeck Institutional Research Online

---

Enabling Open Access to Birkbeck's Research Degree output

### Explainable credit scoring through generative adversarial networks

<https://eprints.bbk.ac.uk/id/eprint/47370/>

Version: Full Version

**Citation: Han, Seongil (2021) Explainable credit scoring through generative adversarial networks. [Thesis] (Unpublished)**

© 2020 The Author(s)

---

All material available through BIROn is protected by intellectual property law, including copyright law.

Any use made of the contents should comply with the relevant law.

---

[Deposit Guide](#)  
Contact: [email](#)

Explainable Credit Scoring  
through  
Generative Adversarial Networks

by

Seongil Han

Department of Computer Science and Information Systems  
Birkbeck College, University of London  
Malet Street, London, WC1E 7HX  
United Kingdom

Email: [s.han@dcs.bbk.ac.uk](mailto:s.han@dcs.bbk.ac.uk)

29 September 2021

THESIS SUBMITTED IN THE FULFILLMENT OF THE  
REQUIREMENTS FOR THE DEGREE OF DOCTOR OF  
PHILOSOPHY (PHD) IN COMPUTER SCIENCE AND  
INFORMATION SYSTEMS IN UNIVERSITY OF LONDON

# Abstract

Credit scoring has been playing a vital role in mitigating financial risk that could affect the sustainability of financial institutions. An accurate and automated credit scoring allows to control the financial risk by using the state-of-the-art and data-driven analytics.

The primary rationale of this thesis is to understand and improve financial credit scoring models. The key issues that occur in the process of developing credit scoring model using the state-of-the-art machine learning (ML) techniques, are identified and investigated. Through the proposed models using ML approaches in this thesis, the challenges in credit scoring can be resolved. Therefore, the existing credit scoring models can be improved by novel computer science techniques in realistic problem of the areas as follows.

First, an interpretability aspect of credit scoring as eXplainable Artificial Intelligence (XAI) is examined by non-parametric tree-based ML models combining with SHapley Additive exPlanations (SHAP). In this experiment, the suitability of tree-based ensemble models is also assessed in imbalanced credit scoring dataset, comparing the performance of different class imbalance. In order to achieve explainability as well as high predictive performance in credit scoring, we propose a model named as NATE which is Non-parametric approach for Explainable credit scoring. This explainable and comprehensible NATE allows us to analyse the key factors of credit scoring by SHAP values both locally and globally in addition to robust predictive power for creditworthiness.

Second, the issue of class imbalance is investigated. Class imbalance in datasets occurs when there are a huge number of differences of observations between the classes in the dataset. The imbalanced class in real-world credit scoring datasets results in the biased classification performance for creditworthiness. As an approach to overcome the limitation of traditional resampling methods for class imbalance, we propose a model named as NOTE which is Non-parametric Oversampling Techniques for Explainable credit scoring. By using conditional Wasserstein Generative Adversarial Networks (cWGAN)-based oversampling technique paired with Non-parametric Stacked Autoencoder (NSA), NOTE as a generative model allows to oversample minority class with reflecting the complex and non-linear patterns in the dataset. Therefore, NOTE predicts the classification and explains the credit scoring model with unbiased performance on a balanced credit scoring dataset.

Third, incomplete data is also a common issue in credit scoring datasets. This missingness normally distorts the analysis and prediction for credit scoring, and results in the misclassification for creditworthiness. To address the issue of missing values in the dataset and overcome the limitation of conventional imputation methods, we propose a model named as DITE which is Denoising Imputation TEchniques for missingness in credit scoring. By using the extended Generative Adversarial Imputation Networks (GAIN) paired with randomised Singular Value Decomposition (rSVD), DITE is capable of replacing missing values with plausible estimation through reducing the noise and capturing complex missing patterns in dataset.

To evaluate the robustness and effectiveness of the proposed models for key issues, namely, model explainability, class imbalance, and missingness in the dataset, the performances of models using ML are compared against the benchmarks of literature on publicly available real-world financial credit scoring datasets, respectively. Our experimental results successfully demonstrated the robustness and effectiveness of the novel concepts used in the models by outperforming the benchmarks. Furthermore, the proposed NATE, NOTE and DITE also lead to a better model explainability, suitability, stability, and superiority on complex and non-linear credit scoring

datasets. Finally, this thesis demonstrated that the existing credit scoring models can be improved by novel computer science techniques in real-world problem of credit scoring domain.

This research has been supervised by Dr Andrea Calí and Dr Alessandro Provetti.

# Declaration

I, Seongil Han, confirm that this thesis and the work presented in it are my own. I also confirm that all the information derived from other sources has been cited and acknowledged within the thesis.

Signature:

---

Date:

---

# Acknowledgements

I would like to express my deepest gratitude to following people who have supported my PhD journey.

First, I would like to thank my principal supervisors, Dr. Andrea Calí and Dr. Alessandro Proveti, for their wonderful guidance, support, trust and expertise. Andrea Cali and Alessandro Proveti were excellent mentors. Second, I would like to thank my advisory supervisor, Dr. Paul D. Yoo, for his invaluable feedback, advice, encouragement and support throughout the projects. Paul D. Yoo was a superb motivator. Third, I would like to thank colleagues at Birkbeck Institute for Data Analytics and Birkbeck Knowledge Lab in MAL159 for your friendship.

Finally, I record my special thanks to my wife Suhlim for her love. I could not have done this journey without her support.

# Contents

<b>1</b>	<b>Introduction</b>	<b>16</b>
1.1	Background . . . . .	16
1.2	Motivation . . . . .	19
1.3	Contributions . . . . .	24
1.4	Outline . . . . .	27
1.5	Publications . . . . .	28
<b>2</b>	<b>Machine Learning</b>	<b>30</b>
2.1	Concepts . . . . .	30
2.1.1	The Learning Process . . . . .	31
2.1.2	The Hypothesis Space . . . . .	32
2.2	Evaluation and Selection for Models . . . . .	33
2.2.1	Error and Overfitting . . . . .	33
2.2.2	Performance Measures . . . . .	36
2.3	Classification Algorithms . . . . .	42
2.3.1	Basic Form of Linear Models . . . . .	42
2.3.2	Logistic Regression . . . . .	43



2.3.3	Decision Tree . . . . .	46
2.3.4	Ensemble Models . . . . .	48
2.3.5	Neural Network . . . . .	54
<b>3</b>	<b>Credit Scoring</b>	<b>58</b>
3.1	Concepts . . . . .	58
3.2	Modelling . . . . .	61
3.3	Credit Scoring Datasets . . . . .	64
3.3.1	Preconditions of Datasets . . . . .	64
3.3.2	Collection of Datasets . . . . .	64
3.3.3	Preprocessing of Datasets . . . . .	67
3.4	Summary for Designing Proposed Credit Scoring Model . . . .	73
3.5	Explainable Models: Parametric vs Non-parametric . . . . .	73
3.6	Class Imbalance . . . . .	75
3.7	Missing Values . . . . .	78
<b>4</b>	<b>Non-parametric Approach for Explainable Credit Scoring on Imbalanced Class</b>	<b>80</b>
4.1	Introduction . . . . .	80
4.2	Related Work . . . . .	83
4.2.1	Explainability as XAI in Credit Scoring . . . . .	83
4.2.2	Ensemble Approach with Oversampling Techniques in Credit Scoring . . . . .	86
4.3	NATE: <u>N</u> on- <u>p</u> Arame <u>T</u> ric approach for <u>E</u> xplainable credit scoring on imbalanced class . . . . .	88

4.4	Results . . . . .	99
4.4.1	Benchmarks on the Original Dataset . . . . .	99
4.4.2	Performance Comparison on Resampled Dataset . . . . .	101
4.4.3	Performance Comparison: Undersampling vs Oversampling . . . . .	104
4.4.4	Interpretability of Predictions . . . . .	106
4.5	Conclusion . . . . .	109
<b>5</b>	<b>GAN-based Oversampling Techniques for Imbalanced Class</b>	<b>111</b>
5.1	Introduction . . . . .	111
5.2	Related Work . . . . .	114
5.2.1	GAN-based Oversampling . . . . .	114
5.2.2	Generating Tabular Data by GAN . . . . .	116
5.3	NOTE: <u>Non-parametric</u> <u>Oversampling</u> <u>Techniques</u> for <u>Explainable</u> credit scoring . . . . .	117
5.4	Results . . . . .	129
5.4.1	The Generative Performance . . . . .	129
5.4.2	The Predictive Performance . . . . .	132
5.5	Conclusion . . . . .	139
<b>6</b>	<b>GAN-based Imputation Techniques for Missing Values</b>	<b>141</b>
6.1	Introduction . . . . .	141
6.2	Related Work . . . . .	144
6.2.1	Imputation Methods for Missing Values . . . . .	144
6.2.2	Mechanism for Missing Values . . . . .	147

6.3	DITE: <u>D</u> enoising <u>I</u> mputation <u>T</u> Echniques for missingness in credit scoring . . . . .	149
6.4	Results . . . . .	157
6.5	Conclusion . . . . .	161
<b>7</b>	<b>Conclusions</b>	<b>163</b>
7.1	Introduction . . . . .	163
7.2	Summary of Contributions . . . . .	164
7.3	Future Work . . . . .	167
<b>A</b>	<b>Abbreviations</b>	<b>169</b>
<b>B</b>	<b>Additional materials for NOTE</b>	<b>172</b>
	<b>References</b>	<b>175</b>

# List of Figures

1.1	The number of studies for balancing datasets in credit scoring models (Dastile et al., 2020) . . . . .	22
2.1	10-fold cross-validation . . . . .	35
2.2	Confusion matrix for credit scoring, where good means good credit or not defaulted, and bad means bad credit or defaulted	38
2.3	An example of ROC curve . . . . .	41
2.4	The number of studies for evaluating performance in credit scoring models (Dastile et al., 2020) . . . . .	42
2.5	Linear model and logistic curve . . . . .	44
2.6	A hypothetical example of DT model in credit scoring . . . . .	47
2.7	The structure of parallel and sequential ensemble . . . . .	49
2.8	The structure of random forest . . . . .	50
2.9	The structure of neural network with four inputs (features) $x_1, x_2, x_3, x_4$ , two outputs $y_1, y_2$ , and n hidden layers . . . . .	55
3.1	The process of credit scoring . . . . .	60
3.2	The general framework for credit scoring using ML models . . . . .	62
3.3	Missing values in features on credit scoring datasets (GMSC, HE, and DC in order) . . . . .	68

3.4	The structure of SAE . . . . .	71
4.1	Comparison between LR and GB regarding the error of explanation and accuracy (Lundberg et al., 2020) . . . . .	84
4.2	The imbalanced class on GMSC dataset, where 0 means not defaulted (good credit) and 1 means defaulted (bad credit) . . . . .	86
4.3	The balanced class distribution by NearMiss . . . . .	90
4.4	The synthetic sample generated by SMOTE . . . . .	91
4.5	The balanced class distribution by SMOTE . . . . .	91
4.6	The system architecture . . . . .	94
4.7	The performance comparison for accuracy and AUC between ML models on original dataset . . . . .	96
4.8	The performance comparison for accuracy (above) and AUC (below) between ML models on original dataset . . . . .	97
4.9	AUC improvement of classification models by undersampling method (NearMiss) against LR on original dataset (IR=13.9) . . . . .	101
4.10	AUC improvement of classification models by oversampling method (SMOTE) against LR on original dataset (IR=13.9) . . . . .	102
4.11	The ROC of non-parametric classifier against parametric model on original dataset (above) and balanced dataset (below) . . . . .	103
4.12	AUC improvement of classification models by undersampling method (NearMiss) against LR on original dataset (IR=13.9) . . . . .	104
4.13	AUC improvement of classification models by oversampling method (SMOTE) against LR on original dataset (IR=13.9) . . . . .	105
4.14	SHAP value plot for individual sample predicted by GB . . . . .	106
4.15	SHAP value plot for individual sample predicted by GB . . . . .	106
4.16	SHAP decision plot for individual sample predicted by GB . . . . .	107

4.17	SHAP decision plot for individual sample predicted by GB . .	107
4.18	Comparison of the average of SHAP feature importance on GB	108
4.19	Comparison of the aggregation of SHAP values on the features	108
5.1	The imbalanced class on HE dataset . . . . .	118
5.2	The non-parametric stacked autoencoder (NSA), where codings are latent features of original dataset . . . . .	120
5.3	The structure of GAN-based generation for synthetic data . .	121
5.4	The structure of cGAN-based generation for synthetic data . .	122
5.5	The system architecture of NOTE . . . . .	124
5.6	t-SNE through PCA on original imbalanced dataset (left) and generated balanced dataset (right) . . . . .	127
5.7	PCA of minority class with 1,189 original samples (left) and 3,582 generated samples (right) . . . . .	129
5.8	AUC improvement of classification models by oversampling methods against non-resampling . . . . .	130
5.9	AUC improvement of classification models by extracting and denoising methods against benchmarks (Engelmann and Lessmann, 2021), AUC of ET: N/A . . . . .	131
5.10	Comparison of SHAP feature importance on RF of NOTE, where en1, en2 and en3 are latent representation extracting from NSA . . . . .	135
5.11	SHAP value plot for individual sample predicted by RF of NOTE . . . . .	136
5.12	SHAP decision plot for individual sample predicted by RF of NOTE . . . . .	136

5.13	SHAP value plot for individual sample predicted by LR of NOTE . . . . .	137
5.14	Comparison of feature importance on tree-based models of NOTE, where en1, en2 and en3 are latent representation extracting from NSA . . . . .	138
6.1	The complete data without missing values on the features (a) and incomplete data with missing values on the features (b), where $x_1, x_2, \dots, x_d$ represent the features and $t$ denotes the label (García-Laencina et al., 2010) . . . . .	147
6.2	The conceptual architecture of rSVD . . . . .	151
6.3	The architecture of GAIN . . . . .	153
6.4	The system architecture of DITE . . . . .	156
6.5	RMSE comparison for imputation performance on missingness	157
6.6	RMSE comparison for GAIN-based imputation methods on default credit card with 20% missing data . . . . .	159
6.7	RMSE comparison for imputation performance of the proposed NITE against the best four imputation methods on default credit card with 20%, 50% and 80% missing data . . . . .	161
B.1	Comparison between real and generated distribution of numerical features by NOTE on HE dataset . . . . .	172
B.2	The loss of generator and discriminator in NOTE (cWGAN) on HE dataset . . . . .	173
B.3	The loss of generator and discriminator in GAN on HE dataset	174

# List of Tables

3.1	The characteristics of the real-world credit scoring datasets used in this study . . . . .	62
3.2	The descriptions of features in GMSC, HE and DC datasets . . . . .	65
4.1	GMSC dataset . . . . .	87
4.2	Undersampled dataset . . . . .	90
4.3	Oversampled dataset . . . . .	92
4.4	The performance comparison for accuracy and AUC between ML models on original dataset . . . . .	95
4.5	The performance comparison of AUC on different IR of dataset . . . . .	99
4.6	Searching space for hyperparameters in Table 4.5 . . . . .	100
4.7	The increment of AUC (over - under) between oversampling and undersampling . . . . .	104
4.8	Features on GMSC dataset used in NATE . . . . .	109
5.1	Oversampled minority class on HE dataset by NOTE . . . . .	127
5.2	Comparison between original and generated distribution on two categorical features of the minority class. Proportion in brackets . . . . .	128



5.3	AUC comparison after hyperparameter optimisation* between none and oversampling methods (NOTE GAN SMOTE) combined with extracting three latent representation on HE dataset. Benchmarks (Engelmann and Lessmann, 2021) in brackets . . .	133
5.4	AUC comparison after hyperparameter optimisation* between NOTE and cWGAN with rSVD on HE dataset. Benchmarks (Engelmann and Lessmann, 2021) for cWGAN oversampling without extraction . . . . .	134
5.5	Features on HE dataset used in NOTE . . . . .	137
6.1	The examples of imputation methods . . . . .	145
6.2	RMSE comparison for imputation performance of the proposed DITE against the benchmarks on default credit card with 5%, 10%, 15% and 20% missing data . . . . .	157
6.3	RSME comparison for imputation performance of the proposed DITE against GAIN-based imputation methods on default credit card with 20% missing data . . . . .	158
6.4	RMSE comparison for imputation performance of the proposed DITE against the best four benchmarks of GAIN-based imputation on default credit card with 20%, 50% and 80% missing data . . . . .	160

# Chapter 1

## Introduction

This chapter introduces the background of machine learning, credit scoring, and their importance to financial institutions in Section 1.1. The research topics are discussed with the motivations in Section 1.2. The contributions of the thesis are described in Section 1.3. Finally, the chapter concludes with a summary of the outline of this thesis in Section 1.4.

### 1.1 Background

Machine learning (ML) is an area of Artificial intelligence (AI) (McCarthy et al., 2006) and a subset of AI that adopts mathematical and statistical disciplines to endow machines (i.e. computers) with ability to learn and improve from experience or data (Jordan and Mitchell, 2015; Mitchell et al., 1997). Recently, ML has been drawing attention and highlights from interdisciplinary research and is widely used in many real-life applications such as object detection, image classification, speech recognition, automated driving, healthcare, and many other domains.

Compared to conventional computing programming that makes algorithms based on “certain” rules, which define the relationship between input and output, in ML rules are inferred by learning the relationship between

input data and output data. Aided by the availability of large data sets and of high computational power these days, ML has been playing an important role in the decision making process of many areas in this recent environment.

Furthermore, the advancement of novel computer science techniques has encouraged ML models to develop credit scoring based on big data-driven analytics and decide credit worthiness more accurately and efficiently. Most financial institutions and Financial Technology (FinTech) companies have employed ML-based models to assess the credit risk for the purposes of innovating the traditional financial business model and its application. The purposes are as follows:

1. for expanding the existing business model in order to grant credit to a larger population.
2. for developing a new business model in order to grant credit to the applicants who are on the borderline of credit worthiness.
3. for achieving an efficient model in order to offer the credit with lower cost and higher speed by exquisite, accurate and automated credit scoring.
4. for evaluating the potential risk of sustainability in order to impede the loss that could be incurred by defaulted credit.

Therefore, it is vital to propose core concepts and the most common approaches in ML-based credit assessment. Furthermore, it is an essential task to explore and develop credit scoring models using ML with considering key issues and challenges in the modelling process, and improve the application of credit scoring using the state-of-the-art ML techniques in these transformational situations of traditional financial systems. This thesis contributes to the literature in the concepts and the common applicable techniques of ML and credit scoring in Chapter 1,2, and 3. In addition, this study expands the key issues of ML-based credit scoring to improve the application by the state-of-the-art ML techniques of computer science in Chapter 4, 5, and 6.

The term of credit scoring is employed to describe the probability of credit applicants' default and evaluate the risk of applicants that would default on financial obligation (Hand and Henley, 1997). Credit scoring models have been used as the purpose of assigning applicants to one of two groups, which are good credit applicants and bad credit applicants (Brown and Mues, 2012). An applicant who has good credit is expected to repay principals and interest, i.e., financial obligation. An applicant who has bad credit, is probable to default on financial obligation.

Financial institutions utilise a wide range of the credit applicants' information, such as demographics, asset, income, payment behaviour and delinquency history, to analyse the characteristics of the applicants in order to classify (or discriminate) between good credit and bad credit (Kim and Sohn, 2004).

In addition to financial industry, the area of credit scoring has also been actively studied by academics (Kumar and Ravi, 2007; Lin et al., 2011), and has been regarded as one of the applicable domains for data analytics and operational research methods (Baesens et al., 2009). Mathematical modelling and classification approaches are applied to estimate who has a good or bad credit and to support the decision making process (Jiang, 2009). The primary aim of credit scoring is thus to classify the applicants' creditworthiness, i.e., discrimination problem, and to provide probability of default (PD) for credit applicants (Lee and Chen, 2005).

Therefore, the problem of credit scoring is essentially related to binary classification (not defaulted or defaulted) or multi-class classification (probability of default) (Brown and Mues, 2012) and supports the decision making process as to whether or not to allow and extend the credit at a certain time (Xia et al., 2017).

As discussed, most financial institutions have recently used the state-of-the-art machine learning (ML) models for accurate and automated credit scoring since ML models have potential to improve the evaluation of the traditional credit scoring through state-of-the art computational techniques.

ML could discover the credit factors for those applicants who have been classified as poor credit based on traditional credit scoring and rejected for credit application (Bazarbash, 2019).

For example, Jagtiani and Lemieux (2017) and He et al. (2018) showed the robust performance for assessing credit risk on real-world credit scoring data of Lending Club<sup>1</sup> using ML-based approaches, when compared to the traditional credit scoring. This means that ML-based credit scoring models are capable of classifying the applicants exquisitely, particularly in the cases where the credit applicants do not have strong credit history. Therefore, FinTech credit scoring models have promising potential for exquisite and accurate performance by improving the traditional models.

## 1.2 Motivation

Over the last decade, the literature for credit scoring has been extensively studied to investigate the challenges that can occur in the process of credit scoring. Even though the advancement of ML models has been applied to credit scoring and ML-based credit scoring has strengths and promising potential, there are still several primary issues in the modelling process (Dastile et al., 2020; Florez-Lopez, 2010): model explainability, class imbalance and missing values in credit scoring datasets.

These challenges make credit scoring models complex and complicated and interrupt accurate estimation of PD by reducing classification performance of the ML model, even though ML-based models have achieved more accurate predictions than traditional credit scoring approaches.

Therefore, this thesis will address these three aspects, namely, model explainability, class imbalance and missing values, and focus on how to overcome the limitation of these three issues using state-of-the-art computer science techniques.

---

<sup>1</sup>[www.lendingclub.com](http://www.lendingclub.com)

Logistic regression (LR) is regarded as the standard in the industry and supported by the research literature since it can be easily implemented, estimated with fast speed, and interpreted for a credit scoring model (He et al., 2018). However, it shows a limited classification performance on non-linear credit scoring datasets since it fails to capture the complexity and non-linearity. On the other hand, non-parametric tree-based ML models are able to capture non-linear relationships between credit risk features and credit worthiness that LR fails to detect, by exploring the relationship in the partition of samples (Bazarbash, 2019).

Many studies also show that tree-based ML ensemble models perform better in credit scoring when compared to the single algorithm, which is a benchmark, such as LR (Nanni and Lumini, 2009; Xia et al., 2017; Xiao et al., 2016). These ensemble approaches have been drawing attention and are currently regarded as the mainstream in the application of credit scoring (He et al., 2018; Wang et al., 2011).

This means that the previous studies for credit scoring models have mostly focused on the accuracy and ignored the aspect of interpretability of credit scoring models, or have still employed the explainable standard parametric LR model at the expense of a limited predictive accuracy to some extent.

Aside from classification performance, the explainability for credit scoring is also essential. According to the Basel II Accord<sup>2</sup>, financial institutions are required to report sustainable credit scoring models so that the financial supervision authorities can evaluate the soundness of financial institutions' activities (Florez-Lopez and Ramon-Jeronimo, 2015). Furthermore, the Financial Stability Board (FSB)<sup>3</sup> suggested that macro-level risk could result from "lack of interpretability and auditability of AI and ML methods" (Board, 2017). Croxson et al. (2019) demonstrated that "a degree of

---

<sup>2</sup>Recommendations on banking laws and regulations issued by Basel Committee on Banking Supervision

<sup>3</sup>International organisation that monitors and makes recommendations about the global financial system

explainability” may be dictated by law.

Finally, Ethics Guidelines for Trustworthy AI were suggested by the European Commission High-Level Expert Group in April 2019. According to the guidelines, the main concepts for eXplainable AI (XAI) can be divided into three factors, which are ‘human-in-loop oversight, transparency and accountability’ (Bussmann et al., 2021).

In addition, comprehensive models are required to update the previous simple credit scoring models so that the practitioners can replace them with more exquisite models in the decision-making process of persuading managers, since the final process is normally counter-intuitive (Lessmann et al., 2015; Xia et al., 2017).

According to Dastile et al. (2020), 74 academic studies for credit scoring in the period of the year 2010 to the year 2018 show that only 8% of the studies considered the model explainability. This is the limitation of literature for credit scoring and a critical gap between academia and industry since credit scoring models are required to be interpretable for the prediction under the Basel II Accord, as discussed earlier.

A recent study suggested by Lundberg and Lee (2017) enables to explain the prediction of ML models. According to their studies, the SHapley Additive exPlanations (SHAP) values allow to evaluate the contribution of each feature both globally and locally for the prediction of models, and, hence, this novel concept could expand the credit scoring model to the aspect of explainability.

To balance and resolve the trade-off between the explainability and accuracy, non-parametric tree-based models which are combined with ‘TreeExplainer’ as well as ‘LinearExplainer’, are proposed in this thesis. These proposed models, hence, enable us to analyse the prediction by SHAP values. This recent state-of-the-art study about eXplainable AI (XAI) allows to overcome the limitation of trade-off for credit scoring models and makes models both explainable and accurate in credit scoring.

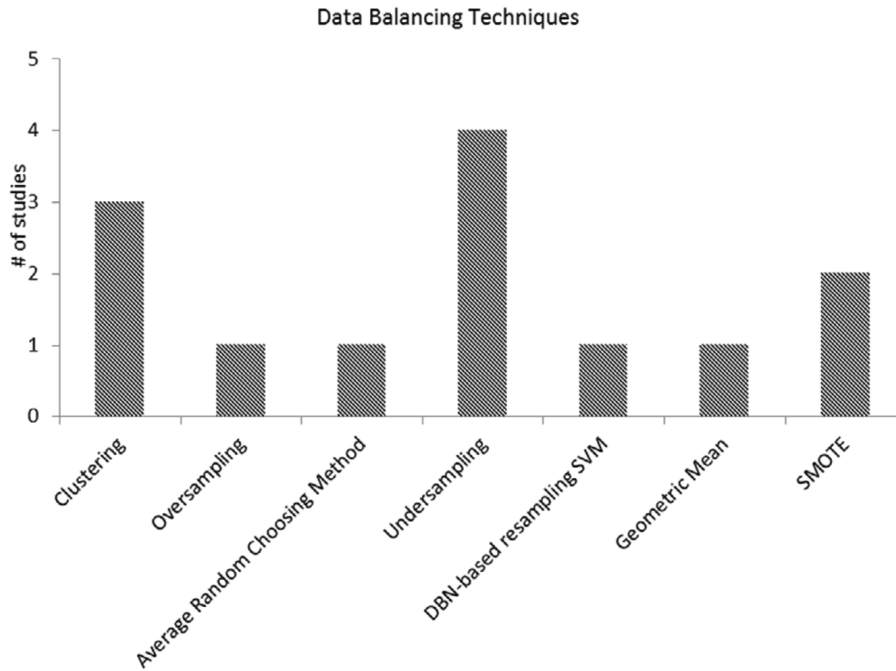

Figure 1.1: The number of studies for balancing datasets in credit scoring models (Dastile et al., 2020)

On the other hand, credit scoring datasets are mostly imbalanced in the real-world where the good credit applicants are far greater than the bad credit applicants (Dastile et al., 2020). Since the accuracy of ML models tends to be biased towards the majority class in cases where the datasets show imbalanced class, it is a necessary process to resample and balance the datasets for mitigating the bias.

However, only 18% of the studies in the literature for credit scoring models have shown that the balancing approaches are applied to the datasets (Dastile et al., 2020). Furthermore, 18% of the studies have mostly employed either undersampling or oversampling (e.g. SMOTE) as a balancing approach, as shown in Figure 1.1.

It has been seen as a main weakness that undersampling methods result in the loss of available information and oversampling methods lead to the overfitting in the models. Finally, these weaknesses result in the loss of



accuracy and reduce the classification performance for credit scoring models.

To overcome the limitation of conventional undersampling and oversampling techniques, and improve the performance of classification on imbalanced dataset, Generative Adversarial Networks (GAN)-based oversampling technique is suggested. GAN is one of generative models proposed by Ian Goodfellow and consists of a generator, which generates artificial data, and a discriminator, which distinguishes real data from artificial data (Goodfellow et al., 2014).

To address the problem of class imbalance in the domain of credit scoring, GAN can be an effective alternative when compared to conventional oversampling techniques. Recently, GAN has been employed to improve the classification accuracy for imbalanced class in diverse areas. The results have been showing a promising performance in the research (Douzas and Bacao, 2018). Since GAN learns the distribution of original dataset and generates the artificial data as close as real data, the distribution of generated dataset for credit scoring can reflect latent features in the original dataset and be employed to overcome the limitation of conventional oversampling techniques such as overfitting and noise.

As discussed, missingness in dataset is another main issue to interfere accurate credit scoring. Credit scoring datasets in the real-world are commonly noisy, redundant and incomplete (Nazabal et al., 2020).

Recently, many generative models have been proposed to handle the problem of missingness in datasets. Generative models such Variational AutoEncoders (VAE) and Generative Adversarial Networks (GAN) have strong advantages in that they are able to capture the latent characteristics, patterns and structures of distribution. These strengths might allow to interpret the distribution of dataset, approximate missing or incomplete data, and finally make better predictions (Valera and Ghahramani, 2017).

To address the issue of missingness in the domain of credit scoring, Generative Adversarial Imputation Networks (GAIN) proposed by Yoon et al. (2018), using GAN architecture, can be a flexible approach when compared

to conventional imputation methods. GAIN as a generative model has been proved to be an effective and expressive unsupervised learning method to estimate incomplete values in datasets. It allows to understand the distribution of complex datasets, capture the latent patterns of missingness, and finally replace the missing values with plausible values similar to the original data (Li et al., 2017).

With this generative imputation method, the problem of missing values on credit scoring datasets can be overcome. A complete credit scoring dataset through imputation, hence, could possibly lead to improve the classification performance and achieve more accurate credit scoring, which is an essential goal.

In this thesis, the entire process of modelling for credit scoring will be discussed by using the state-of-the-art ML techniques and three different real-world credit scoring datasets. The novel techniques mentioned above will be applied to the modelling process in order to overcome the key issues of credit scoring.

### **1.3 Contributions**

In this thesis, credit scoring models using ML approaches are placed by focusing on overcoming the limitation of key issues encountered on modelling process of credit scoring. We

1. apply SHAP (SHapley Additive exPlanations) to credit scoring models for eXplainable Artificial Intelligence (XAI);
2. compare and quantify the differences in the application of parametric and non-parametric approaches for credit scoring models;
3. suggest the application of extended Generative Adversarial Networks (GAN) for addressing the issue of class imbalance on credit scoring dataset;

4. propose the application of extended Generative Adversarial Imputation Networks (GAIN) for addressing the problem of missing values on credit scoring dataset.

To overcome these key issues by the proposed models, we investigate the suggested topics and propose the approaches through the implementation and validation of models to evaluate credit risk in the following chapters.

In Chapter 4, we propose a novel Non-pArameTic approach for Explainable credit scoring, named NATE, to balance the trade-off between explainability and classification performance for models on imbalanced dataset. The model explains the classification as an eXplainable Artificial Intelligence (XAI) using SHAP (SHapley Additive exPlanations), suggested by Lundberg and Lee (2017) with robust classification performance.

The key contributions of Chapter 4 in this thesis are as follows:

- To demonstrate the efficacy of non-parametric models on non-linear dataset for credit scoring
- To present the standard oversampling method by SMOTE synthesising the minority class on imbalanced dataset, compared with undersampling method by NearMiss
- To propose the architecture of non-parametric models on non-linear and imbalanced credit scoring dataset
- To achieve the explainability aspect for practical application in credit scoring as XAI as well as high predictive performance of the proposed non-parametric model

In Chapter 5, we propose a novel oversampling technique extending GAN-based oversampling approach, named NOTE (Non-parametric Oversampling Techniques for Explainable credit scoring), to overcome the limitation of SMOTE on imbalanced dataset. In addition to unsupervised generative learning, it effectively extracts latent features by Non-parametric Stacked

Autoencoder (NSA) in order to capture the complex and non-linear patterns. Furthermore, it explains the classification as an eXplainable Artificial Intelligence (XAI) using SHAP (SHapley Additive exPlanations) as suggested by Lundberg and Lee (2017).

The key contributions of Chapter 5 in this thesis are as follows:

- To demonstrate the effectiveness of extracted latent features using NSA, compared with denoising method by randomised Singular Value Decomposition (rSVD) on non-linear credit scoring dataset
- To present the advancement of cWGAN by overcoming the problem of mode collapse in the training process of GAN and determine the suitability, stability and superiority of cWGAN generating the minority class on imbalanced dataset, compared with the benchmarks by GAN and SMOTE
- To propose an architecture of a non-parametric model for non-linear and imbalanced dataset
- To suggest new benchmark results that outperform the state-of-the-art model by Engelmann and Lessmann (2021) on HE (Home Equity) dataset
- To enable the explainability aspect of the proposed model for practical application in credit scoring as XAI

In Chapter 6, we propose a novel imputation technique extending GAIN-based imputation technique, named DITE (Denoising Imputation TEchniques for missingness in credit scoring), in order to solve the issues of missing values in credit scoring datasets.

The key contributions of Chapter 6 in this thesis are as follows:

- To demonstrate the effectiveness of denoising method by randomised Singular Value Decomposition (rSVD) in credit scoring dataset

- To present the advancement of GAIN imputation paired with rSVD by improving the classification performance in incomplete credit scoring dataset, compared with the benchmarks by original GAIN, the variants of GAIN, and conventional statistical and ML imputation approaches
- To propose an architecture of credit scoring model for dataset with missingness
- To suggest new benchmark results that outperform the state-of-the-art model by Yoon et al. (2018) on DC (Default of Credit card clients) dataset for missing value imputation
- To enable the practical application of imputation for missingness on incomplete credit scoring datasets

The key contribution of Chapter 3 in this thesis is as follows:

- To overview the concept and process of credit scoring using machine learning and address the key issues of credit scoring

The key contribution of Chapter 2 in this thesis is as follows:

- To overview theoretical concepts, basic (parametric) and tree-based (non-parametric) algorithms of machine learning and its application to credit scoring

## 1.4 Outline

The thesis is organised as follows:

- **Chapter 2** explains the theoretical concepts of ML, evaluation and selection for ML models, and classification algorithms.

- **Chapter 3** presents the concepts, datasets and the issues of credit scoring, and the modelling process for the application of ML to credit scoring
- **Chapter 4** applies and develops the non-parametric approach for explainable credit scoring on non-linear and imbalanced ‘Give Me Some Credit (GMSC)’ dataset, named NATE, in order to balance the trade-off between explainability and classification performance in the models. The results are analysed and compared with the benchmark as the standard LR model and literature.
- **Chapter 5** proposes the GAN-based oversampling techniques, named NOTE, in order to overcome the limitation of the SMOTE as the standard oversampling method and improve the classification performance on non-linear and imbalanced ‘Home Equity (HE)’ dataset. The results are analysed and compared with the state-of-the-art benchmarks of literature on non-linearity and imbalanced class of credit scoring dataset.
- **Chapter 6** proposes the GAIN-based imputation techniques, named DITE, in order to fill in the missing values and improve imputation performance of incomplete dataset for accurate credit scoring on ‘Default of Credit card clients (DC)’ dataset. The results are analysed and compared with the state-of-the-art benchmarks of literature for imputation methods on credit scoring dataset with missingness.
- **Chapter 7** concludes with the summaries, highlights the limitation, and suggests the future work.

## 1.5 Publications

The following work supports this thesis.

- Seongil Han, Paul D. Yoo, Alessandro Proveti, Andrea Calí. Non-parametric Oversampling Techniques for Explainable Credit Scoring. Proceedings of the VLDB Volume 15 for VLDB 2022 (Submitted on 02 September 2021, under review)

# Chapter 2

## Machine Learning

This chapter presents the concepts of machine learning, especially with binary classification on a supervised learning process in Section 2.1. The evaluation and selection for machine learning models are described in Section 2.2. The machine learning algorithms are detailed in Section 2.3.

### 2.1 Concepts

As discussed earlier, ML is a field of study that improves the systems by machine (or computer) as a tool, using experience (Jordan and Mitchell, 2015; Mitchell et al., 1997). In computational systems, the experience conforms to the form of data.

The main goal of ML is to develop a model that follows learning algorithms, which are deduced from data. If there exists learning algorithms, a new model based on data would be generated with the experience, which maps to data. This means that the model can result in the corresponding output when it confronts new input. Compared to computer science, which is a field of research that studies algorithms, ML is a field of research that studies learning algorithms or pattern recognition.



Furthermore, the final aim of ML is to make prediction by applying the learning algorithms that learn the patterns and regularities in data. ML models have the capability to analyse big-data containing insightful information by using strong machinery (or computational) power (Bazarbash, 2019).

As a discipline in ML, data or datasets are essential to make machines learn. In general, a dataset  $D = \{x_1, x_2, \dots, x_m\}$  is given with  $m$  samples. Each sample  $x$  is described by  $d$  features or attribute values. Therefore, each sample  $x_i = (x_{i1}; x_{i2}; \dots; x_{id})$  is a vector  $x_i \in X$  in  $d$ -dimensional sample space  $X$ , where  $d$  is a dimensionality of sample  $x_i$ .

### 2.1.1 The Learning Process

The process that makes models by using datasets is called as learning or training, and is accomplished through certain learning algorithms. A learning process was defined as “improving performance measure when executing tasks through some type of training experience” by Jordan and Mitchell (2015).

The set of training samples is called as training set  $X = \{x_1, x_2, \dots, x_m\}$ . Learning algorithm can map the certain rule that is latent to the data and the certain rule is called as hypothesis. This latent rule is referred to as ground-truth in the domain of ML. The aim of the learning process is to figure out the ground-truth or access to the ground-truth as close as possible. In other words, the goals of learning are:

1. To make a hypothesis based on the dataset
2. To figure out the latent rule

To make prediction through the model, a training set is composed of input data and corresponding output information, which is termed as label and denoted as  $y_i \in Y$ , where  $Y = \{y_1, y_2, \dots, y_3\}$  is a label space and a set of all labels.

Learning of cases where the prediction values are discrete values, is known as classification. On the other hand, learning of cases where the prediction values are continuous values is called regression. The goal of this learning process is to map the input or samples  $X$  to the output or labels  $Y$  for the prediction. This is called supervised learning, which is a principal concept of ML (Jordan and Mitchell, 2015). The classification is a supervised learning that classifies the samples into separating classes. For classification, the cases where the classes are divided into two groups are binary classification. Cases where the classes are divided into more than two groups are multi-class classification.

In formal form, the prediction or classification is to approximate a function  $f : X \rightarrow Y$  which maps input space  $X$  to output space  $Y$ , with learning training set  $\{(x_1, y_1), (x_2, y_2), \dots, (x_m, y_m)\}$ . The function is called as a model or classifier. A model is optimised by the parameters to generate a mapping from sample space  $X$  to label space  $Y$  (Jordan and Mitchell, 2015). After that, the trained (or optimised) model can be employed to predict (or classify) unseen samples. Depending on the values of output in label space  $Y$  as discussed, the learning can be defined as follows:

1.  $Y = \{-1, +1\}$  or  $\{0, 1\}$  (i.e.,  $|Y| = 2$ ) for binary classification;
2.  $|Y| > 2$  for multi-class classification;
3.  $Y = \mathbb{R}$  for regression.

In the domain of credit scoring, modelling probability of default (PD) is a classification since the prediction is binary, i.e., not defaulted or defaulted. On the other hand, modelling loss given default (LGD) is a regression since the prediction is quantitative real value (Bazarbash, 2019).

### 2.1.2 The Hypothesis Space

ML can be considered as inductive learning since it learns from the samples, especially the training set, and deduces the latent rule in the dataset. This

learning process is conducted by a learning algorithm for generalisation. As discussed, the function  $f$  or model as a learning algorithm is performed during the learning process. The space of functions or models is called as hypothesis space  $H$ . Therefore, the learning process can be defined as the procedures of exploring hypotheses in hypothesis space  $H$ , with the aim of finding a ‘fit (optimal or suitable)’ hypothesis. Depending on whether the training set has label (target) data or not, or in other words whether the label in the training set is available or not, the learning process can be divided into two groups as follows:

1. supervised learning when the training set has label data and the model is trained, based on the labelled dataset
2. unsupervised learning when the training set does not have label data and the model is trained, based on the unlabelled dataset. In this case, the model is applied to cluster the samples depending on the similarity of features.

Therefore, the classification and regression as discussed earlier are general supervised learnings.

## 2.2 Evaluation and Selection for Models

### 2.2.1 Error and Overfitting

The difference between the predictive value  $f(x)$  by the model or function  $f$  and actual value  $y$  is referred to as an error. In addition, the error on a training set by the model is called as a training error or empirical error. The error on new or unseen data is called as a generalised error. The aim of the learning process is to build the model with the minimum of generalised error. However, the generalised error can only be obtained on unseen data after building the model. To find the optimal model  $h$  on hypothesis space

$H$ , hence, training error or empirical error can be used instead of generalised error. In formal form, the training error as loss function can be utilised as a measure of the difference between the predictive value  $h(x)$  by hypothesis and actual value  $y$ . The optimal model  $h$  can be defined as the minimum error (difference). Therefore, the optimal model  $h$  is obtained by minimising loss function  $L$ . The process for loss minimisation can be expressed as follows (Kennedy, 2013):

$$L(h(x), y) = \int L(h(x), y) dP(x, y) \quad (2.1)$$

where  $L$  represents the loss function,  $y$  indicates the actual label, and  $P(x, y)$  denotes the joint probability of  $x$  and  $y$ .

As discussed, training error on a training set can be used to minimise the loss function  $L$ , i.e., error, for finding the optimal model  $h$ . This estimation of the loss function based on the available training set is provided by the induction principle, i.e., inductive learning (Müller et al., 2018).

The aim of inductive learning is to find the optimal model  $h$  with having robust performance on new or unseen data. However, the model is trained and parameterised by the training error on the training set, and this might lead to reduce the generalised performance on new data. This is called as overfitting in ML. Since the generalised error on new data cannot be obtained directly as discussed, the model needs to be evaluated by the testing error on a testing set. The testing error is considered as the approximation of generalised error, based on the assumption that the testing set and new data (unseen data) are independent and identically distributed (i.i.d.).

In the learning process, the issue of overfitting is commonly addressed when the model is evaluated (Bazarbash, 2019). A model with the issue of overfitting shows normally a low training error and high testing error, and results in making inaccurate predictions on the testing set due to being over-parameterised (Bazarbash, 2019).

To mitigate the problem of overfitting, the model can be assessed by the

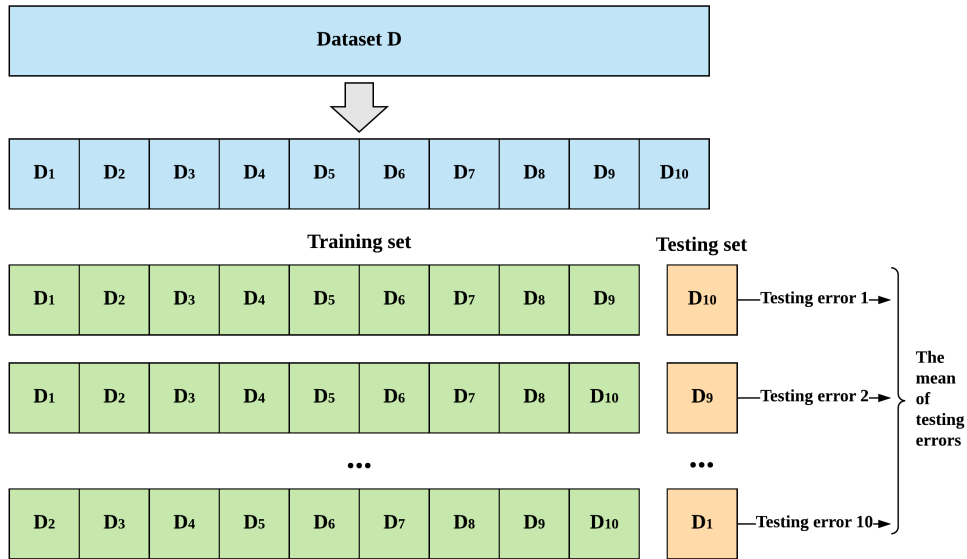

Figure 2.1: 10-fold cross-validation

method of cross-validation. This means that data is randomly divided into two groups called as training set and testing set. The training set can be used to train the model for estimating parameters of the model, i.e., parameterised, and the model can be evaluated on a testing set for estimating testing error, which is regarded as the approximation of generalised error as discussed.

In practice, k-fold cross-validation is generally applied to evaluate the model. The dataset  $D$  is randomly partitioned into  $k$  disjoint sets with equal number of observations reflected by the characteristics of the original distribution  $D$  (i.e.  $D = D_1 \cup D_2 \cup \dots \cup D_k$ ,  $D_i \cap D_j = \emptyset$ ,  $i \neq j$ ). Then,  $k - 1$  partitions are used to train the model and the remaining one partition is used to evaluate the testing error based on the performance measure (e.g., MSE). The performance measure for the model will be discussed further in the next section. With this method, the average of  $k$  testing errors can be obtained on  $k$  partitions and it can be expressed as follows:

$$\frac{1}{k} \sum_{i=1}^k (MSE)_i \quad (2.2)$$

‘ $k = 10$ ’ is frequently used for the cross-validation, and ‘ $k = 5$ ’ and ‘ $k = 20$ ’

are also commonly employed. Figure 2.1 shows the 10-fold cross-validation.

Furthermore, ML models need to be optimised by hyper-parameters that control the configuration of the algorithms. These hyper-parameters are used to minimise the cross-validation testing error (Bazarbash, 2019). Therefore, the dataset  $D$  can be partitioned into three subsets: training set  $D_{train}$ , validation set  $D_{validation}$ , and testing set  $D_{test}$ , where training set  $D_{train}$  is employed to estimate the parameters of the model, validation set  $D_{validation}$  is used to optimise hyper-parameters, and testing set  $D_{test}$  is utilised to evaluate the testing error (Bazarbash, 2019).

With this process, the parameterised and hyper-parameterised model as optimal hypothesis  $h$  can have generalisation and be selected. This process is referred to as model selection.

## 2.2.2 Performance Measures

The performance measure can be defined as minimising the overall error of estimation, and the overall error is evaluated with the average difference between the estimated value of the target feature and actual value of label in the dataset (Bazarbash, 2019).

In order to evaluate the performance for generalisation of classifiers or learners, measures or standards for evaluating performance should be necessary. The performance measure needs to reflect the aim of modelling. This means that understanding whether the modelling is good or not, is relative since the decision on which modelling is good, depends on neither algorithms nor dataset, but on the aim of data analysis.

For the prediction models, there exists a dataset  $D$  such that

$$D = \{(x_1, y_1), (x_2, y_2), \dots, (x_m, y_m)\}, \text{ where } y_i \text{ is a label for } x_i.$$

To measure the performance of classifier  $f$ , the difference  $f(x) - y$  between predictive result  $f(x)$  and actual label  $y$  needs to be compared and analysed.

## Error and Accuracy

The performance measure frequently used in regression models is Mean Squared Error (MSE) and can be expressed as follows:

$$E(f; D) = \frac{1}{m} \sum_{i=1}^m (f(x_i) - y_i)^2 \quad (2.3)$$

where  $E(\cdot)$  is error.

Performance measures used in classification models are error rate and accuracy. Error rate is a ratio misclassifying samples in all samples and accuracy is a ratio classifying correctly in all samples.

Error rate in sample dataset  $D$  can be expressed as follows:

$$E(f; D) = \frac{1}{m} \sum_{i=1}^m \mathbb{I}(f(x_i) \neq y_i) \quad (2.4)$$

where  $\mathbb{I}$  is an indicator function.

Accuracy can be expressed as follows:

$$Acc(f; D) = \frac{1}{m} \sum_{i=1}^m \mathbb{I}(f(x_i) = y_i) = 1 - E(f; D) \quad (2.5)$$

Since error rate and accuracy for performance measures cannot be applied in all classification problems depending on the aim of data analysis, different methods, which could be precision and recall, might be necessary in some cases.

## Confusion Matrix

For binary classification problem, the predictive class and the actual(observed) class are represented as four categories with True Positive (TP), False Negative (FN), True Negative (TN), False Positive (FP), where the sum of TP,

FP , TN and FN equals to the number of total samples. A confusion matrix consists of these four categories.

Figure 2.2 shows 2 x 2 confusion matrix and means the classification performed by the model.

Observed	Predicted		
	Good(0)	Bad(1)	
Good(0)	TN	FP	TN + FP
Bad (1)	FN	TP	FN + TP
	TN+FN	FP+TP	TP+FP+FN+TN

Figure 2.2: Confusion matrix for credit scoring, where good means good credit or not defaulted, and bad means bad credit or defaulted

As mentioned above, the details of four categories are as follows:

- True Positive (TP) are positive samples classified correctly as positive
- False Negative (FN) are samples classified as negative, but actually positive
- True Negative (TN) are negative samples classified correctly as negative
- False Positive (FP) are samples classified as positive, but actually negative

In the domain of credit scoring, TN is the number of good credit applicants classified correctly as good credit (not defaulted), FP is the number of



good credit applicants classified incorrectly as bad credit (defaulted), FN is the number of bad credit applicants classified incorrectly as good credit (not defaulted), and TP is the number of bad credit applicants classified correctly as bad credit (defaulted).

Evaluation measures for classification performance can be derived from the number in the confusion matrix, which are precision, recall (sensitivity), specificity, false positive rate (FPR, type I error, false alarm), false negative rate (FNR, type II error), F-measure, G-mean, accuracy (ACC) and so on. These measures can be used for evaluating the performance of models in credit scoring. The measures are defined as follows:

- $Precision = \frac{TP}{TP + FP}$

- $Recall (sensitivity) = \frac{TP}{TP + FN}$

- $Specificity = \frac{TN}{TN + FP}$

- $Type I error = \frac{FP}{FP + TN}$

- $Type II error = \frac{FN}{FN + TP}$

- $F - measure = \frac{2 \times Precision \times Recall}{Precision + Recall}$

- $G - Mean = \sqrt{Sensitivity \times Specificity}$

- $Accuracy (ACC) = \frac{TP + TN}{TP + FP + FN + TN}$

In the domain of credit scoring, ACCuracy (ACC) is one of the most popular measures for evaluating performance, which is defined as the proportion of correctly classified samples, i.e., the sample size of correct prediction divided by the total sample size (Xia et al., 2017). However, the accuracy does not reflect the effect of imbalanced class in the dataset and it shows the overall prediction accuracy of the dataset (He et al., 2018). This means that the biased high accuracy tends to be occurred in imbalanced dataset. Therefore, other measures for evaluating performance need to be considered together. Since the accuracy cannot solely distinguish between good credit and bad credit applicants on imbalanced dataset, the aim of modelling should be reflected by performance measures when the predictions of models are evaluated, as discussed earlier.

Therefore, type I error (FP) and type II error (FN) are also selected for evaluating performance at the same time. Type I error means that good credit applicants (class 0) are misclassified as bad credit applicants (class 1), whereas type II error means that bad credit applicants (class 1) are misclassified as good credit applicants (class 0) as shown in Figure 2.2 confusion matrix.

These two errors incur misclassification costs caused by loss (Xia et al., 2017). According to the meanings of type I error and type II error, type II error is followed by the loss of lending, and type error I is followed by the loss of latent profit to financial institutions. Type II error (FN) is regarded as more costly and more damaging than type I error (FP) in the domain of credit scoring (Marqués et al., 2012; West, 2000; Xia et al., 2017).

### **Area under receiver operating characteristics curve**

The Area Under the Receiver Operating Characteristic curve (AUROC), also known as AUC, is a measure that evaluates the discriminative power of models. It is frequently used as the performance measure based on the

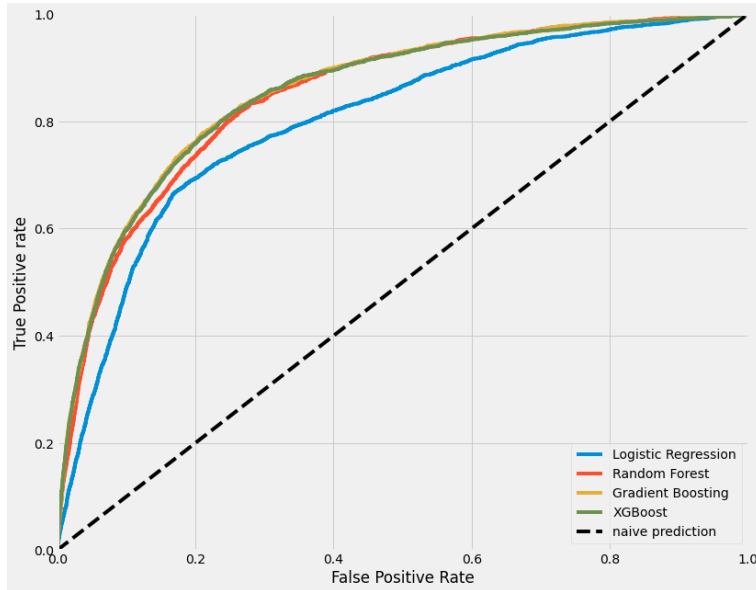

Figure 2.3: An example of ROC curve

Receiver Operating Characteristic (ROC) curve (Fawcett, 2004) in the developed model for credit scoring on imbalanced dataset. AUROC represents the area under ROC curve and the value of AUC is in the interval  $[0, 1]$ . The models with higher AUC are regarded as they show the better classification performance. Since AUC is not affected by the class distribution or error cost, it is preferable to the other performance metrics on imbalanced dataset (Fawcett, 2006).

As shown in Figure 2.3, ROC is the curve that the x-axis shows the false positive rate (FPR) by computing  $(1 - \text{specificity, i.e., type I error})$ , and y-axis represents the true positive rate (TPR, i.e., sensitivity). In other words, the ROC curve shows a complete report for positive class (bad credit applicant or defaulted) by model prediction. Therefore, AUROC can be employed to evaluate the classification performance effectively as the measure for separability (Baesens et al., 2003).

Percentage Correctly Classified (PCC) is normally called as ACCuracy (ACC), which easily tends to be biased towards the majority class in the imbalance dataset as discussed. Therefore, AUC is regarded as the standard

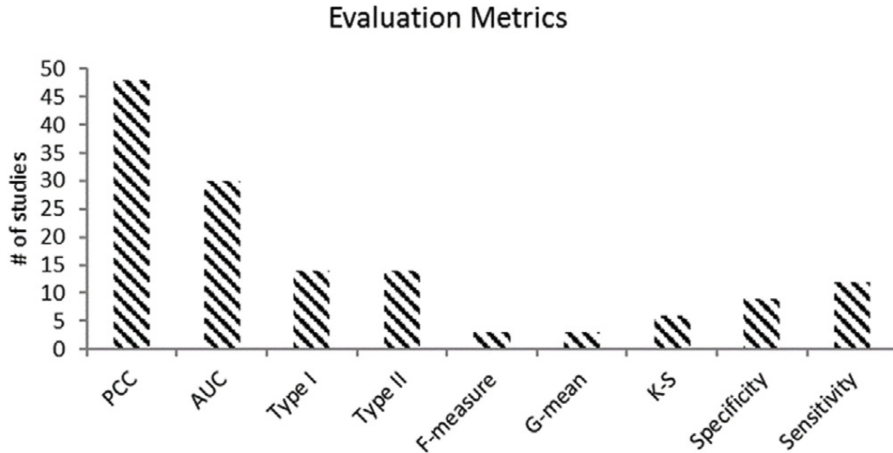

Figure 2.4: The number of studies for evaluating performance in credit scoring models (Dastile et al., 2020)

measure for evaluating classification performance on imbalanced dataset, as supported by the literature (Haixiang et al., 2017; Huang and Ling, 2005). Figure 2.4 shows the metrics for evaluating the performance in the literature of credit scoring models. As can be seen, AUC is one of two frequently used measurements in the domain of credit scoring (Dastile et al., 2020).

## 2.3 Classification Algorithms

### 2.3.1 Basic Form of Linear Models

Suppose that there exists samples  $x = (x_1; x_2; \dots; x_d)$  with  $d$  features and let  $x_i$  be value having  $i$ -th feature. Then, a linear model can be defined as a model that learns prediction function by linear combination of features. It is expressed as follows:

$$f(x) = w_1x_1 + w_2x_2 + \dots + w_dx_d + b = \omega^T x + b \quad (2.6)$$

where  $\omega = (w_1; w_2; \dots; w_d)$  denotes the weights related to each feature  $(x_1; x_2; \dots; x_d)$  of sample  $x$ ,  $b$  represents the intercept term.  $\omega$  and  $b$  can be

obtained after the learning process.

Although the linear model is simple and easy to develop modelling, it has an important basic concept of ML for credit scoring. This parametric and statistical method, called Linear Discriminant Analysis (LDA), was proposed by Fisher (1936) and it was suggested to develop a credit scoring model by Fair Isaac Company in the late 1960s (Thomas, 2000). The statistical approaches for credit scoring model have been used until ML methods have replaced them with data analytics and computational AI techniques, which have performed better for credit scoring than statistical approaches (Huang et al., 2004).

As shown in Eq. 2.6, the statistical approaches are developed to analyse the data and find the linear relationship between input and output with the assumption of distribution, while ML methods are constructed to acquire the latent rule directly based on enormous data without any assumptions (Ratner, 2017).

Although LDA is a simple and easy method, it has a main weakness. Since LDA makes assumption on the linear relationship between the variables, it might not capture the non-linearity on complex and non-linear data and lead to the lack of accuracy (Šušteršič et al., 2009). Since most credit scoring datasets are complex and non-linear, this parametric and statistical LDA is limited to develop credit scoring models.

### 2.3.2 Logistic Regression

Even though AI and data analytics-based credit scoring models have become mainstream approaches, the parametric and statistical logistic regression (LR) is regarded as the standard of the credit scoring industry (Hand and Zhou, 2010) and widely applied in practice because of its simplicity, interpretability and balanced error distribution (Finlay, 2011; Lessmann et al., 2015).

A prediction value  $z = \omega^T x + b$  that regression model outputs through

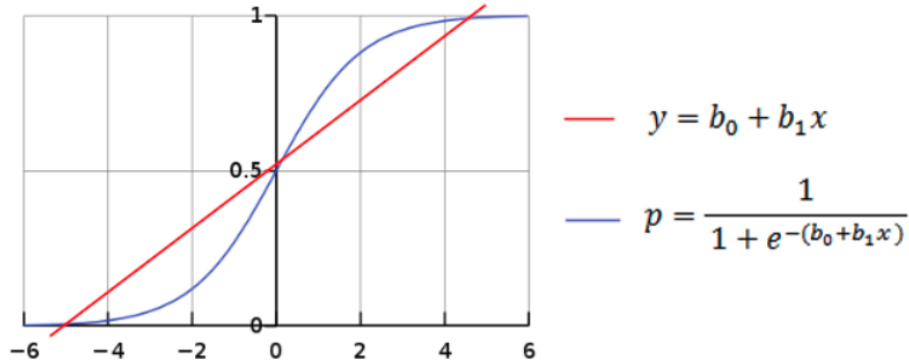

Figure 2.5: Linear model and logistic curve

linear combinations of variables, is continuous value in the range  $[-\infty, +\infty] \in \mathbb{R}$ , where  $\omega = (w_1; w_2; \dots; w_d)$ . In order for the application of classification in credit scoring as a binary problem, the prediction values  $z$  should be changed into a probability between 0 and 1.

This can be done with the LR model, which predicts a probability of default (PD) for credit applicants. LR explains the relationship between input features and the label feature since the problem for credit scoring can be regarded as a binary classification by distinguishing between good credit applicant and bad credit applicant (Thomas, 2000). This means that LR outputs a probability of a sample that belongs to a specific classification (Xia et al., 2017). The LR model can be expressed as follows:

$$y = \frac{1}{1 + e^{-z}} = \frac{1}{1 + e^{-(\omega^T x + b)}} \quad (2.7)$$

$$\implies \ln\left(\frac{y}{1-y}\right) = \omega^T x + b \quad (2.8)$$

where,  $y$  is the probability of  $x$  belonging to positive class and  $1 - y$  is the probability of  $x$  belonging to negative class. In the domain of credit scoring, if  $y$  is the probability of classifying a good credit applicant, then  $1 - y$  is the probability of classifying a bad credit applicant.

$\frac{y}{1-y}$  is called as the odds, which means the ratio of the probability that  $x$  belongs to positive class relative to the probability that  $x$  belongs to negative class. If log is taken in odds, it can be changed as follows:

$$\ln\left(\frac{y}{1-y}\right) \quad (2.9)$$

This is called as log odds or logit. This transformation shows that the prediction value of linear regression can be approximated to log odds of the input variables. This means that logit transformation is used for a link that the probability of the class relates to a linear function of input attributes (Worth and Cronin, 2003). Logit transformation can be analysed as having strong points as follows:

- It is not necessary to make assumption on the distribution of sample dataset and the prediction model for the probability of classification can be made directly by sample dataset. This helps to escape from a possible problem caused by wrong assumption of the distribution of sample dataset.
- LR is used for not only predicting the class label but also predicting the approximate probability. This helps the cases where the decision making process should be done based on the probability.

For example, the good credit applicant and bad credit applicant in the domain of credit scoring can be defined using LR model as follows:

$$P(y = 0 \mid x) = \frac{1}{1 + e^{-(\omega^T x + b)}} \quad (2.10)$$

and

$$P(y = 1 \mid x) = 1 - P(y = 0 \mid x) = \frac{e^{(\omega^T x + b)}}{1 + e^{(\omega^T x + b)}} \quad (2.11)$$

where  $x \in \mathbb{R}^n$  represents the feature vector of credit applicant,  $P(y = 0 \mid x)$  is the probability of classifying  $x$  as a good credit applicant, and

$P(y = 1 | x)$  is the probability of classifying  $x$  as a bad credit applicant. The coefficients ( $\omega$  and  $b$ ) for parameters of model can be derived using maximum likelihood method on a training set (Myung, 2003).

As shown in Eq. 2.8, LR model is built with the linear relationship between logit and independent variables. The linear characteristic of LDA and LR can be applied to develop the parametric model when the data is linear (Akkoc, 2012; Thomas, 2000; West, 2000). Consequently, this means that the predictive performance of LR might decrease as similar to LDA if the data is non-linear (Ong et al., 2005).

Nevertheless, LR model has commonly been used and regarded as the standard in the domain of credit scoring until now since it is simple and interpretable in satisfying the explainability for credit scoring (Lessmann et al., 2015).

### 2.3.3 Decision Tree

A decision tree (DT) is built with a hierarchical structure of flow that begins from a root node, proceeds to internal nodes through each decision, and ends at the terminal node (Bazarbash, 2019). This process is termed a recursive partitioning (Hand and Henley, 1997). The terminal node shows the final decision or prediction. DT can be used for both regression and classification models, which is called as Classification And Regression Tree (CART). For the classification, DT splits the dataset recursively based on information (Quinlan, 1986). In other words, the selection to split at each node is decided to maximise the purity, which is a measure of information. The other measure of information can be impurity, Gini (Breiman et al., 1984) and Entropy (Quinlan, 1986). DT is a non-parametric method to analyse outcome based on the information of input (Lee et al., 2006).

In the DT model of ML, the size of the tree needs to be controlled in order to avoid overfitting. When DT is built, the part of the tree with redundant and less predictive power can be pruned since this pruning process



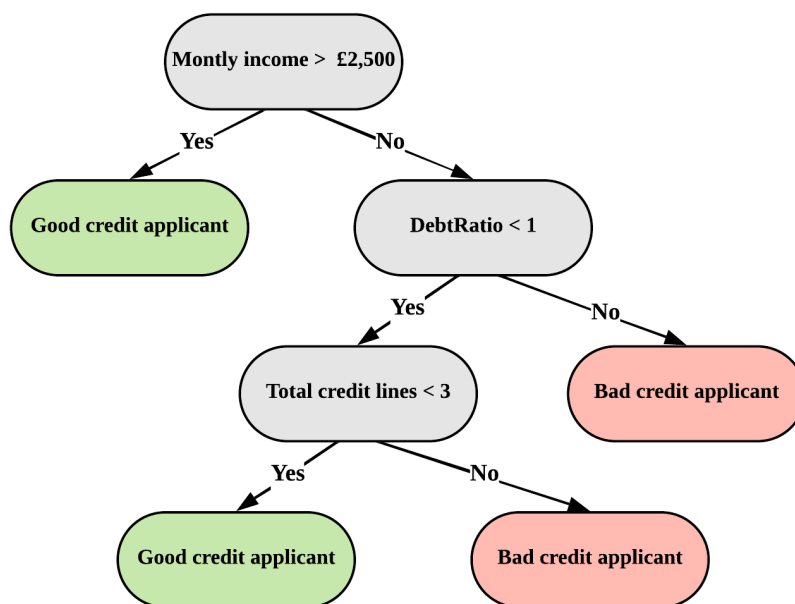

Figure 2.6: A hypothetical example of DT model in credit scoring

can reduce the complexity of the tree. Consequently, this leads to improve the accuracy by reducing the overfitting (Mansour, 1997). For example, the maximum depth of the tree and the minimum number of samples remaining in the final nodes can be managed and optimised by hyperparameters tuning in models.

DT has the advantages that it is easy to be interpreted and illustrated as the flow of the decision making process for communication (Bazarbash, 2019), as shown in Figure 2.6. Since the process of decision by the model is similar to the process of decision by practitioners, DT can offer clear explanation and illustration to credit applicants. The DT model in the domain of credit scoring was first suggested by Makowski (1985).

However, DT has the disadvantages that it has not commonly been used in practice for the modelling process, especially in FinTech. The disadvantages are as follows (Bazarbash, 2019):

- DT models are easily to be overfitted in the training process and, there-

fore, the models cannot output the generalised prediction.

- If the dataset has high dimensionality, “curse of dimensionality” happens and DT models output a local optimal solution, not a global optimal solution. This means that DT models can be sensitive to the noise in the dataset, and consequently, can be unstable.
- DT models tend to be biased easily when the dataset shows strong class imbalance, which is a common issue in credit scoring datasets.

To impede the restriction and overcome the limitation of the DT model, DT has been extended to the ensemble learning approaches. With ensemble learning, the variance or bias can be reduced and the prediction can be improved. Random Forest (RF) and Gradient Boosting (GB) models are two main DT-based ensemble methods (Bazarbash, 2019).

### 2.3.4 Ensemble Models

Ensemble learning algorithms combine multiple classifiers that operate different hypotheses in order to model one optimal hypothesis, enhancing the performance of the model (Nascimento et al., 2014). Since datasets obtained from different sources have their own characteristics in terms of size, form and the label features, a single ML algorithm as the standard, i.e., LR, is not able to model all credit scoring datasets (Xia et al., 2017). Furthermore, the “no free lunch theorem” by Wolpert and Macready (1997) supports that a single complex classifier is not a perfect solution for modelling credit scoring.

Recently, the ensemble approaches have been improved and they have shown the robustness to perform the classification for accurate credit scoring. Nanni and Lumini (2009) presented the comparative results by ensemble approach for credit scoring. In addition, Lessmann et al. (2015) showed that ensemble methods outperform the single ML algorithm and statistical approaches in the domain of credit scoring. These results of recent studies encourage further research of its effectiveness and robustness.

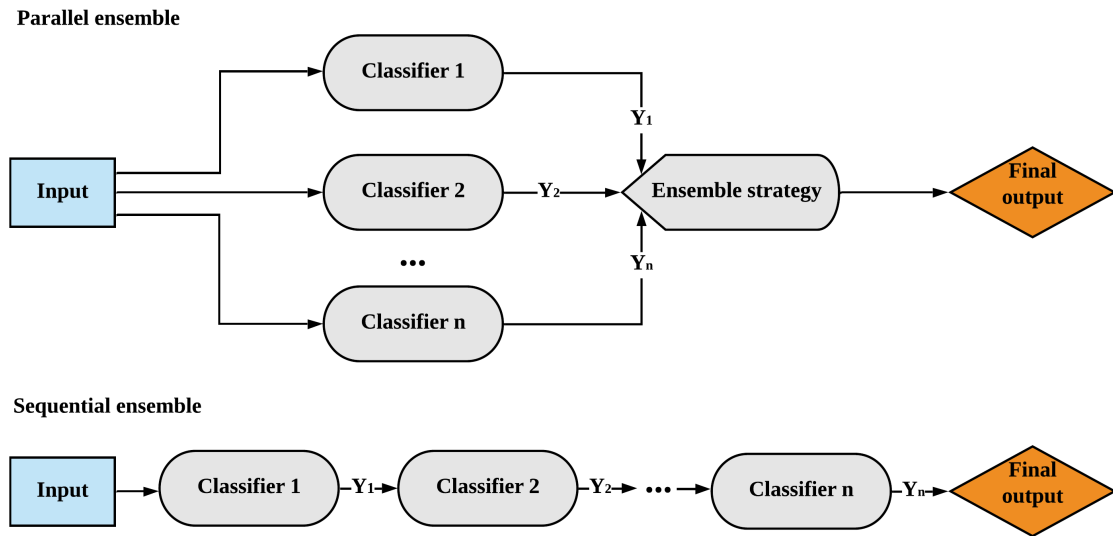

Figure 2.7: The structure of parallel and sequential ensemble

Ensemble methods can be grouped into two ways according to their structures, which are parallel and sequential ensembles (Duin and Tax, 2000) as shown in Figure 2.7. In parallel ensemble, the different learning algorithms are combined with parallel structure, and each algorithm generates the models and output predictions independently. Then, final prediction is confirmed by ensemble strategy, e.g. the majority voting. On the other hand, the different learning algorithms in sequential structure are connected consecutively, and each algorithm corrects the previous models. Then, the final algorithm outputs the updated final prediction. The parallel methods such as bagging (Breiman, 1996) and RF, have a weak relationship between individual learners, while, on the other hand, the sequential methods such as boosting (Schapire, 1990) and GB, have relatively a strong relationship between individual learners.

There have been popular ensemble approaches in the literature of credit scoring: parallel method using random forest (RF) (Yeh et al., 2012), bagging (Paleologo et al., 2010; Wang et al., 2012), multiple classifier systems (Ala'raj and Abbod, 2016a; Finlay, 2011), and sequential method using gradient boosting (GB) (Brown and Mues, 2012) and boosting (Dietterich, 2000).

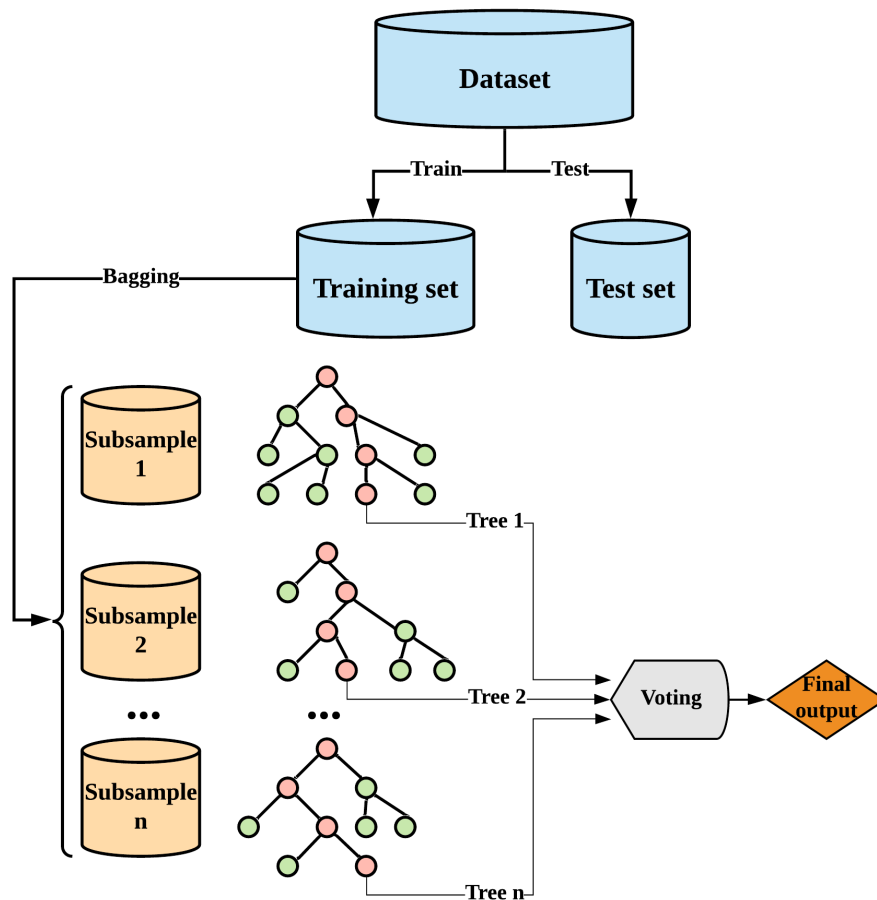

Figure 2.8: The structure of random forest

According to Bazarbash (2019), RF and GB are the two most commonly used ML algorithms in the domain of credit risk modelling. Furthermore, Brown and Mues (2012) proved that RF and GB perform well for credit scoring due to their non-parametric characteristics when compared to other ML algorithms.

### Random Forest (RF)

RF is a non-parametric tree-based ensemble model. Suggested by Breiman (2001) and also known as forest of randomised trees, it performs the bagging

algorithm by searching random subspace. To produce subsets from the original training set, the bootstrapped sampling is used. Then, several unrelated DTs as the base learners in parallel structure are trained in these subsets, which is termed forest. After DTs have been trained in the forest, every tree classifies the input samples and the majority voting as ensemble strategy is performed to determine the final prediction (Xia et al., 2018). Figure 2.8 shows the process of RF. RF has the strengths as follows (He et al., 2018):

- RF can process high dimensionality in dataset without feature selection due to decorrelation stage (Biau, 2012). Compared to DT, RF are relatively less prone to be overfitted and have comparatively more robust generalised prediction than DT.
- RF can show each feature importance.
- RF has high speed for training and low computational cost in parallel structure.

Since RF takes these advantages, it has been widely applied in the real-world areas of medicine, finance and commerce (Bazarbash, 2019). Thus, it is also beneficial for modelling a credit scoring dataset.

However, RF is not easy to interpret the prediction, especially when the number of randomised trees or features in samples is large. Although feature importance, which ranks the contribution of features for final prediction, can be obtained, it only shows the importance of each feature globally across entire samples, not a certain sample. Nevertheless, the features with importance in making predictions could be identified by the rank of features in the models (Bazarbash, 2019). Therefore, the results of credit scoring can be analysed and evaluated by feature importance of RF.

## **Gradient Boosting Decision Tree (GBDT)**

GBDT, in short GB, is also a non-parametric tree-based ensemble model. Proposed by Friedman (2001), it combines a series of weak base classifiers

into one strong model and enhances the classification performance. The weak base classifier, which is generally and commonly independent DT with a few branches, refers to a model that performs better slightly than a random prediction (Xia et al., 2017).

Compared to the bagging algorithms that model the base learners in parallel structure, GB performs boosting algorithms in sequential structure of base learners. Boosting algorithms enable the additive base classifiers to correct the errors and mistakes, and minimise the loss function consecutively until the update becomes limited, where the loss function evaluates how well the model fits the dataset (Xia et al., 2017).

DTs as the base learners are employed with GB in this thesis. The performance of GB is improved by minimising the loss function and updating the errors sequentially in previous trees. The final prediction is the sum of predictions weighted by all previous trees (Bazarbash, 2019). Similarly, GB allows to rank the contribution of features for final prediction by feature importance globally on entire samples.

Given a dataset  $D \{(x_k, y_k)\}_{k=1}^n$

with  $n$  samples, where  $x$  represents a set of feature vector and  $y$  denotes the corresponding response vector, suppose that there exists the optimal function  $F^*(x)$  that maps feature vector  $x$  to the response vector  $y$  such that the loss function  $\Psi(y, F(x))$  can be minimised as follows:

$$F^*(x) = \operatorname{argmin} \Psi(y, F(x)) \quad (2.12)$$

where  $F^*(x) \in F(x)$ . Suggested by Friedman (2001),  $F^*(x)$  is estimated by greedy function approximation of GB in an additive form: GB is updated sequentially by taking the sum of previous base learners as follows:

$$F^*(x) = \sum_{k=0}^K f_k(x) = \sum_{k=0}^K \beta_k h(x; \theta_k) \quad (2.13)$$

where  $f_0(x)$  is an initial base learner and  $f_k(x)$  is the  $k$ -th base learner in  $k$ -th boost for the boosts  $k=1, 2, \dots, K$ . The optimal  $k$ -th base learner  $f_k(x)$  can be parameterised with the function  $\beta_k h(x; \theta_k)$ , where  $\beta_k$  represents the optimal coefficient and  $\theta_k$  denotes the optimal parameter for base learner.

Therefore, optimal function  $F^*(x)$  can be obtained by those parameters  $\beta_k$  and  $\theta_k$  using Eq. 2.12 and Eq. 2.13. This can be expressed as follows:

$$(\beta_k, \theta_k) = \underset{\beta, \theta}{\operatorname{argmin}} \sum_{i=1}^n \Psi(y_i, F_{k-1}(x_i) + \beta h(x_i; \theta)) \quad (2.14)$$

Finally, using Eq. 2.13 and Eq. 2.14,  $F_k(x)$  can be expressed as follows:

$$F_k(x) = F_{k-1}(x) + \beta_k h(x; \theta_k) \quad (2.15)$$

The idea of greedy function approximation by Friedman (2001) is that the optimal  $\beta_k$  and  $\theta_k$  can be searched to construct the optimal base learner, and then optimal function  $F^*(x)$  can be approximated with the additive form of these constructed base learners.

## Extreme Gradient Boosting (XGB)

Chen and Guestrin (2016) suggested XGB, which is an advanced version of GB, in order to optimise the loss function and estimation of GB.

Given a dataset  $D \{(x_k, y_k)\}_{k=1}^n$

with  $n$  samples and  $m$  features, where  $x$  represents a set of feature vectors and  $y$  denotes the corresponding response vector, suppose that there exists the optimal function  $F^*(x)$  that maps feature vector  $x$  to the response vector  $y$  such that the loss function  $\Psi(y, F(x))$  can be minimised. By similar concepts and ways with GB,  $F^*(x)$  is estimated by function approximation in an additive form as follows:

$$F_K(x) = \sum_{k=1}^K f_k(x) \quad (2.16)$$

where  $F_k(x)$  represents the  $k$ -th prediction in the boosts  $k=1, 2, \dots, K$ .

XGB uses Taylor's expansion to approximate the loss function quickly and employs a regularised term to manage the complexity of the tree as learners (Xia et al., 2018) as follows:

$$L_K(F(x_i)) = \sum_{i=1}^n \Psi(y_i, F_K(x_i)) + \sum_{k=1}^K \Omega(f_k) \quad (2.17)$$

where  $F_K(x_i)$  represents the  $i$ -th sample's prediction on  $k$ -th boost, and  $\Omega(f) = \gamma T + 0.5 \times \lambda \|\omega\|^2$  as regularisation term.  $\gamma$  is the parameter for complexity,  $\lambda$  is a fixed coefficient, and  $\|\omega\|^2$  is the L2 norm for leaf weights (Xia et al., 2017).

### 2.3.5 Neural Network

Neural network (NN) has successfully been applied in the area of natural language process, computer vision and image, etc. The NN model has been used to improve classification performance since it has a strong predictive performance. Based on the motivation by the functioning of biological neuron (Jain et al., 1996), NN is built in a similar structure to the human brain in order to learn non-linear and complex patterns between features and output through inner layers. (Bhattacharyya and Maulik, 2013).

Figure 2.9 shows an example of the structure of NN. Features  $x_i = \{x_1, \dots, x_4\}_{i=1}^4$  are employed to calculate the values of nodes  $z_i = \{z_1, \dots, z_5\}_{i=1}^5$  in the first hidden layer. Then, nodes  $z_i = \{z_1, \dots, z_5\}_{i=1}^5$  are used as inputs to evaluate the nodes in the next hidden layer. The evaluated values obtained by sigmoid function  $\sigma(x) = \frac{1}{1 + e^{-x}}$  are the form of weighted sum



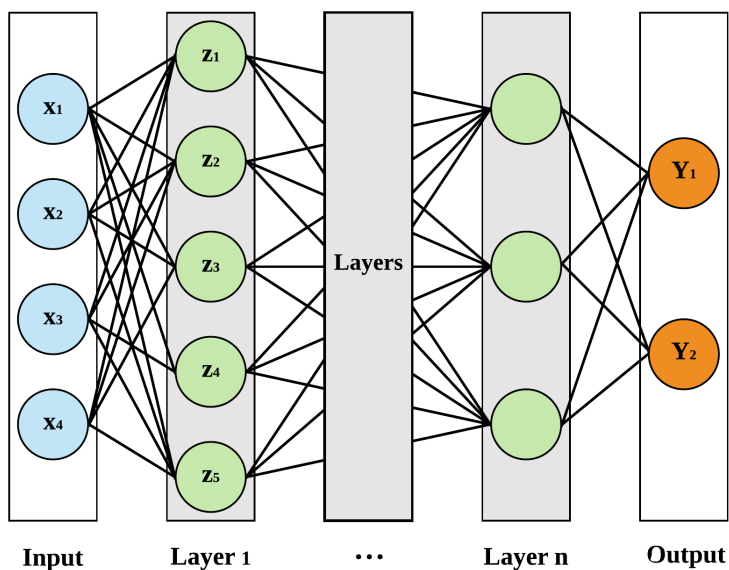

Figure 2.9: The structure of neural network with four inputs (features)  $x_1, x_2, x_3, x_4$ , two outputs  $y_1, y_2$ , and  $n$  hidden layers

of inputs and are in the range  $[0, 1] \in \mathbb{R}$ . The sigmoid function is termed the activation function in the architecture of NN. It is a one of the activation functions which include softmax, hyperbolic tangent, and rectifier function (Bazarbash, 2019).

In the case of Figure 2.9, the node  $z_1$  can be calculated as follows:

$$z_1 = \frac{1}{1 + e^{-(w_1x_1 + w_2x_2 + w_3x_3 + w_4x_4 + b)}} \quad (2.18)$$

where weights  $w_1, w_2, w_3$ , and  $w_4$  can be estimated by the contribution of each feature  $x_1, x_2, x_3$ , and  $x_4$  to the node  $z_1$  and the constant  $b$  is used to adjust the bias.

Since Eq. 2.18 is similar to the form of LR, NN can be regarded as the combinations of numerous LR where the outputs of previous layer are employed as the inputs of the next layers (Bazarbash, 2019). Five coefficients,  $w_1, w_2, w_3, w_4$  and  $b$ , need to be calculated for evaluating one  $z$  in the first layer. Since there are five nodes,  $z_1, z_2, z_3, z_4$  and  $z_5$ , in the first hidden layer,

25 parameters need to be estimated. This means that the more the number of layers are in the NN, the number of parameters increases exponentially.

In the domain of credit scoring, NN has been used to improve the predictive performance as an alternative to the LR model (Angelini et al., 2008; Atiya, 2001). As an example of Figure 2.9, suppose that the credit applicant  $x$  has four features,  $x_1, x_2, x_3$ , and  $x_4$ . These four inputs are sent to each five nodes  $z$  in the first layer. The weights for the five nodes  $z$  are evaluated, and the values are accordingly processed to the activation function. Then, the results are served as the inputs in the next layer. This process proceeds until the final layer leads to a final prediction.

Deep NN, which is commonly called as deep learning, is the extended version of NN having a number of hidden layers. To train deep NN models, it is, hence, required to have more optimal architecture and high computational power (Bazarbash, 2019).

The NN model has the main advantage that it is flexible regardless of the assumption and characteristic of the data distribution, and is able to capture complicated, complex and non-linear patterns in the data. This means that NN has superior ability to capture deeper relational characteristics between features and the output (He et al., 2020).

However, NN is a black box model in which the extracted patterns are not comprehensible and interpretable by human beings (He et al., 2020). Due to the lack of explainability, the NN model is not able to justify the prediction for a credit applicant that is classified as either good credit or bad credit. Furthermore, financial institutions are required to report the transparency in the process of credit scoring to both regulators and credit applicants under the Basel Accord, as discussed earlier. Therefore, interpretability is a major drawback of the NN model. In addition, Hamori et al. (2018) argued that the performance of deep learning models depends on the architecture of models such as the number of hidden layers and the kind of activation function. They showed that the ensemble approaches such as bagging and boosting performed better than deep NN on ‘Default of Credit card clients (DC)’

dataset (which dataset will be discussed in Chapter 3 and Chapter 6).

Nevertheless, NN has been employed in financial application such as daily stock return (Yeh et al., 2015), credit card fraud detection (Fu et al., 2016), mortgage risk management (Sirignano et al., 2016), and credit risk management (Neagoe et al., 2018) since NN shows the superior predictive performance. It has been shown in studies that NN outperformed the parametric statistical LDA and LR in terms of predictive performance (Abdou et al., 2008; Lee and Chen, 2005; West, 2000).

# Chapter 3

## Credit Scoring

This chapter expands the concepts of credit scoring to machine learning approaches in Section 3.1 and describes the process of credit scoring modelling in Section 3.2. The three datasets which are employed in this thesis are introduced and explained in Section 3.3. The process of designing credit scoring model is summarised in Section 3.4. Following the overview of real-world credit scoring datasets, the real-world problems of credit scoring models are suggested in Section 3.5, Section 3.6 and Section 3.7, respectively.

### 3.1 Concepts

As discussed in Chapter 2, the aim of learning, i.e., machine learning, is not to have good performance or correct assignment in training set, but to classify labels correctly by applying the trained model to an unseen dataset. The classification process for credit scoring proceeds to assess credit risk for existing or new applicants in financial institutions, as to whether or not to extend and allow the credit at a certain time. Therefore, the problem of credit scoring is related to binary or multi-class classification and supports the decision making process (Xia et al., 2017).

Credit risk can be defined as the risk of loss resulting from any change

in the applicants' creditworthiness (Anderson, 2007). As discussed earlier, an applicant who has good credit is likely to repay principals and interest, i.e., financial obligation, and this action leads to profit for financial institutions. An applicant who has bad credit is likely to default on financial obligation and this action leads to loss for financial institutions. In order to impede the risk that could be occurred by the defaulters, a critical and accurate evaluation for credit applicants should be applied to the decision making process of classifying risk levels.

This means that credit risk could influence on non-performing financial obligation, which is highly associated with bankruptcy and affects the sustainability of financial institutions. Therefore, the risk should be managed (Munkhdalai et al., 2019). In order to manage and minimise credit risk as mentioned above, a data analytic approach is used for evaluating creditworthiness of the applicants, which is known as credit scoring.

Hand and Henley (1997) defined credit scoring as "the term used to describe formal statistical methods for classifying credit applicants into good and bad risk classes". Lyn et al. (2002) believed that the credit scoring is a "set of decision models and their underlying techniques that aid lenders in the granting of customer credit". Thomas et al. (2005) suggested the aim of credit scoring 'to improve these decisions and make decisions consistent and automated in credit application'.

Credit score can be modelled by using data on past applicants in order to check the default risk of current or new applicants. In other words, financial institutions collect the data, analyse them, and make decisions whether a credit application is accepted or rejected. This process is based on the assumption that creditworthiness is time independent and can be deduced from past experience or data.

The architecture of the system in the context of credit scoring is able to derive a score or probability of default in order to assess credit risk or default risk of the applicant. This is supported by the information on the repayment behaviour of past borrowers as well as demographic information. As shown

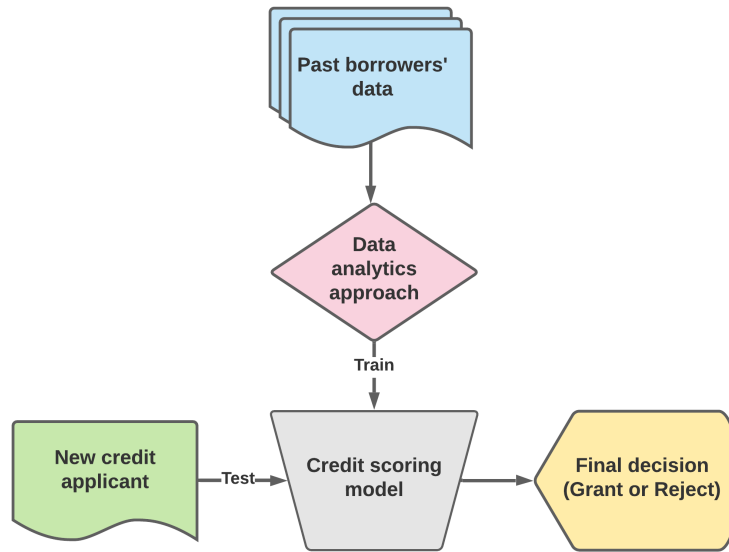

Figure 3.1: The process of credit scoring

in Figure 3.1, the past borrowers' data is collected and analysed in order for new credit applicants to be classified based on the past data.

If the information about repayment behaviour is included in the dataset and the feature which describes the repayment behaviour can be considered as the label of default risk for new applicants, a model can be developed with ML approaches that map the attributes of credit applicants to estimate the label of default risk.

This system is a supervised ML model. With this characteristic, most ML models for credit scoring are supervised models. The past data, including repayment behaviour or delinquency information, is utilised to train the credit scoring model (Bazarbash, 2019).

This system, finally, helps the decision making process for assigning the applicant to the probability of risk level. Furthermore, the advancement of data analysis as well as the enormous amount of data have enabled to employ the ML model and make credit decisions more accurate. Therefore, the concept and process for credit scoring meshes with the learning process of ML as discussed in Chapter 2, and the ML modelling process can be applied

theoretically in the domain of credit scoring.

The set of training samples is called as training set  $X = \{x_1, x_2, \dots, x_m\}$ , and in the credit scoring domain  $X$  is a set of credit applicants. To make prediction through models, the training set is composed of input data and corresponding output information, which is termed label and denoted as  $y_i \in Y$ , where  $Y = \{y_1, y_2, \dots, y_m\}$  is a label space and a set of all labels. Similarly,  $Y$  is a set of targets for each credit applicant, which is granted (accepted) or rejected. Therefore, the prediction for credit application is to model a function  $f : X \rightarrow Y$  which maps  $X$  to  $Y$ , with learning training set  $\{(x_1, y_1), (x_2, y_2), \dots, (x_m, y_m)\}$ .

In other words, after the samples as credit applicants are utilised to develop and train the model, the trained model is able to assess the probability of default for credit application. Since the result of credit application is credit-worthy or not, the model for credit scoring can be regarded as binary classification.

## 3.2 Modelling

Credit scoring can be built by a supervised machine learning (ML) model if the data for labelled target feature is available, and the credit scoring is modelled by the labelled data. After the supervised learning is processed, the classification for credit applicants as the probability of default (PD) is performed, based on the credit scoring by modelling the relationship between input and output features.

As discussed, the information about demographics, asset, income and so on of credit applicants is utilised as input features in order to predict the PD. In addition to these features, if the data has the information about the repayment behaviour of past borrowers or delinquency and this feature can be regarded as time independent for future credit applicants, then the ML model can be trained with this label about the repayment behaviour or delinquency

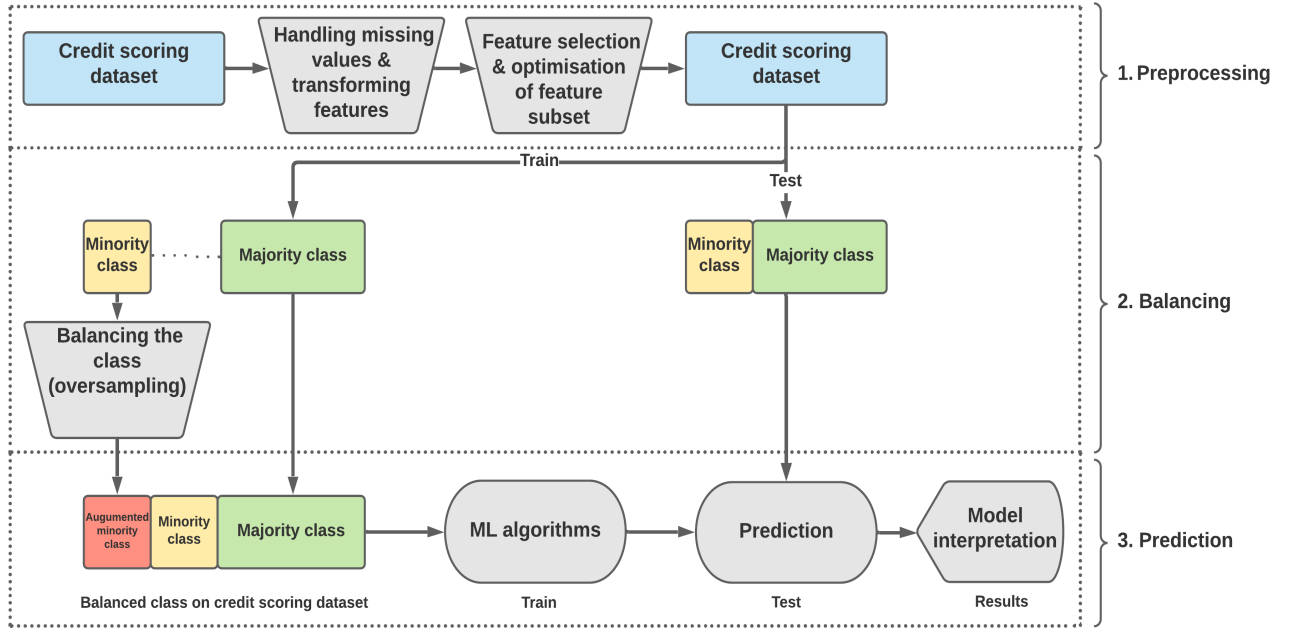

Figure 3.2: The general framework for credit scoring using ML models

Table 3.1: The characteristics of the real-world credit scoring datasets used in this study

Name	Source	Samples	Not defaulted	Defaulted	Num. columns*	Cat. columns**	Minority class (%)	∃ Missing values
GMSC	Kaggle	150,000	139,974	10,026	10	0	6.68%	Yes
HE	Baesens et al. (2016)	5,960	4,771	1,189	10	2	19.94%	Yes
DC	UCI MLR	30,000	23,364	6,636	14	9	22.12%	No

\*Numeric columns \*\*Categorical columns

by supervised learning (Bazarbash, 2019). Therefore, it is essential to confirm whether or not the information about repayment behaviour or delinquency is included in the dataset of credit scoring.

The supervised learning for credit scoring can be defined as exploring a model  $f : \mathbb{R}^n \rightarrow \{0, 1\}$  or  $\{-1, +1\}$  which maps a feature vector  $x \in \mathbb{R}^n$  to a predicted class label  $\hat{y} \in \{0, 1\}$  or  $\{-1, +1\}$ . This can be expressed as follows:

$$f_{\alpha} : x \rightarrow \hat{y} \quad (3.1)$$

where  $\alpha$  is the set of parameters for the model.



A labelled dataset  $D$  can be formed from the information of past credit applicants in order to search for model parameters.

The labelled dataset  $D$  can be expressed as follows:

$$D = \{(x_1, y_1), \dots, (x_k, y_k), \dots, (x_m, y_m)\} = \{(x_k, y_k)\}_{k=1}^m \quad (3.2)$$

where  $x_k \in \mathbb{R}^n$  represents the feature vector of  $k$ -th credit applicant and  $y_k \in \{0, 1\}$  or  $\{-1, +1\}$  denotes the corresponding label class in the set of classes (good credit applicant = 0 and bad credit applicant = 1, or good credit applicant = +1 and bad credit applicant = -1).

The dataset  $D$  is split into two groups, which are training set  $D_{train} \subset D$  and test set  $D_{test} \subset D$  as discussed in Chapter 2, where  $D_{train} \cap D_{test} = \emptyset$  (i.e., disjoint) and  $D_{train} \cup D_{test} = D$ .

As discussed earlier, it is important to confirm that the information about repayment behaviour or delinquency is included in the credit scoring dataset for supervised learning by ML. The three real-world credit scoring datasets used in this thesis include the feature about the repayment behaviour or delinquency, which can be used as the label or target feature in modelling as shown in Table 3.2.

After the dataset  $D$  is split into training set  $D_{train}$  and test set  $D_{test}$ , the parameters  $\alpha$  for model  $f$  are searched on the  $D_{train}$  by minimising loss (cost) function  $L$ . The loss function  $L$  can be expressed as follows:

$$L(f; D_{train}) = \sum_{\forall x_k \in D_{train}} d(y_k, \hat{y}_k) \quad (3.3)$$

where  $\hat{y}_k = f(x_k)$  is the prediction by model, and  $d(y_k, \hat{y}_k)$  is the measure of distance, such as Mean Square Error (MSE), Root Mean Square Error (RMSE) or Cross-Entropy. The optimal parameters  $\alpha^*$  for the model can be obtained by

$$\alpha^* = \operatorname{argmin} L(f; D_{train}) \quad (3.4)$$

Then, the performance of trained model  $f_{\alpha^*}$  is evaluated on the testset  $D_{test}$  with the performance measures as discussed in Chapter 2. Figure 3.2 shows the general framework for the system architecture of credit scoring using ML.

## 3.3 Credit Scoring Datasets

The preconditions of three credit scoring datasets which are used to evaluate the proposed models in Chapter 4, Chapter 5 and Chapter 6 are presented in Section 3.3.1 and the credit scoring datasets are described specifically in Section 3.3.2. The preprocessing methods for original datasets are suggested in Section 3.3.3.

### 3.3.1 Preconditions of Datasets

The characteristics and description of the datasets used in this study are shown in Table 3.1 and Table 3.2. The selection of these datasets is motivated by the benchmarks in the literature of credit scoring (Awan et al., 2021; Boughaci and Alkhaldeh, 2020; Camino et al., 2019; Engelmann and Lessmann, 2021; Yoon et al., 2018). This choice allows to compare the performance of our proposed models with the benchmarks and suggest the quantitative analysis comparatively.

### 3.3.2 Collection of Datasets

A credit scoring dataset is composed of a group of features which can statistically be analysed to be predictive in the classification of creditworthiness (Siddiqi, 2012). Credit scoring allows the financial institutions to assess the creditworthiness of the applicants by using a structured and tabular dataset. Features in the credit scoring dataset describe the characteristics of the credit applicant, including the demographics, the number of credit lines, and repay-

Table 3.2: The descriptions of features in GMSC, HE and DC datasets

Name of feature in GMSC	Description	Type
<b>SeriousDlqin2yrs</b>	Applicant experienced 90 days past due delinquency or worse	Y/N (1 or 0)
RevolvingUtilizationOfUnsecuredLines	Total balance on credit cards and personal lines of credit	percentage
age	Age of in years	integer
NumberOfTime30-59DaysPastDueNotWorse	Number of times applicant has been 30-59 days past due but no worse in the last 2 years.	integer
DebtRatio	Monthly debt payments, alimony, living costs divided by monthly gross income	percentage
MonthlyIncome	Monthly income	real
NumberOfOpenCreditLinesAndLoans	Number of Open loans (installment like car loan or mortgage) and Lines of credit	integer
NumberOfTimes90DaysLate	Number of times applicant has been 90 days or more past due.	integer
NumberRealEstateLoansOrLines	Number of mortgage and real estate loans including home equity lines of credit	integer
NumberOfTime60-89DaysPastDueNotWorse	Number of time applicant has been 60-89 days past due but no worse in the last 2 years.	integer
NumberOfDependents	Number of dependents in family excluding themselves (spouse, children etc.)	integer
Name of feature in HE	Description	Type
<b>BAD</b>	Applicant defaulted on loan or seriously delinquent or applicant paid loan	Y/N (1 or 0)
LOAN	Amount of the loan request	integer
MORTDUE	Amount due on existing mortgage	integer
VALUE	Value of current property	integer
REASON	DebtCon = debt consolidation; HomeImp = home improvement	category
JOB	Occupational categories	category
YOJ	Years at present job	integer
DEROG	Number of major derogatory reports	integer
DELINQ	Number of delinquent credit lines	integer
CLAGE	Age of oldest credit line in months	real
NINQ	Number of recent credit inquiries	integer
CLNO	Number of credit lines	integer
DEBTINC	Debt-to-income ratio	real
Name of feature in DC	Description	Type
LIMIT_BAL	Amount of given credit in NT dollars (includes individual and family/supplementary credit)	integer
SEX	Gender (1=male, 2=female)	category
EDUCATION	(1=graduate school, 2=university, 3=high school, 4=others, 5=unknown, 6=unknown)	category
MARRIAGE	Marital status (1=married, 2=single, 3=others)	category
AGE	Age in years	integer
PAY_1, PAY_2, ..., PAY_6	Repayment status in September, August, ..., April 2005 (category*(-2,-1,0, ..., 8))	category
BILL_AMT1, BILL_AMT2, ..., BILL_AMT6	Amount of bill statement in September, August, ..., April 2005 (NT dollar)	integer
PAY_AMT1, PAY_AMT2, ..., PAY_AMT6	Amount of previous payment in September, August, ..., April 2005 (NT dollar)	integer
<b>default.payment.next.month</b>	Default payment	Y/N (1 or 0)

\*-2=no consumption, -1=pay duly, 0=the use of revolving credit, 1=payment delay for one month, 2=payment delay for two months, ..., 8=payment delay for eight months, 9=payment delay for nine months and above

ment behaviours and so on. These features are generally a group of a set of non-time series or non-time stamp, and ‘mutually exclusive values or a range of non-overlapping numbers’ (Kennedy, 2013). This suggests that the characteristics of the dataset in the domain of credit scoring include various aspects such as the predictive power of features for classification and the correlation and collinearity between the features. Therefore, credit scoring datasets are commonly regarded as complex and non-linear dataset.

All credit scoring datasets used in this thesis vary in terms of the distribution of samples, the number of features, and the distribution of corresponding classes. For example, three datasets show moderate to strong imbalanced class. Table 3.2 shows the detailed characteristics of credit scoring datasets.

In Chapter 4, ‘Give Me Some Credit (GMSC<sup>1</sup>)’ dataset is used to validate the robustness of non-parametric tree-based approach with resampling method for explainable credit scoring, focused on oversampling and model interpretability. This proposed model is named as Non-pArameTric approach for Explainable credit scoring (NATE) on imbalanced class.

In Chapter 5, ‘Home Equity (HE<sup>2</sup>)’ dataset is used to validate the efficacy of non-parametric tree-based oversampling technique for explainable credit scoring, focused on non-linear and complex dataset. This approach is cWGAN-based oversampling method paired with Stacked AutoEncoder (SAE), named as Non-parametric Oversampling Techniques for Explainable credit scoring (NOTE).

In Chapter 6, ‘Default of Credit card clients (DC<sup>3</sup>)’ dataset is used to evaluate the superiority of denoising imputation techniques for credit scoring dataset with missingness, focused on the estimation of missing values. This approach is GAIN-based imputation method paired with randomised Singular Value Decomposition (rSVD), named as Denoising Imputation TEchniques (DITE) for missingness in credit scoring.

GMSC dataset is obtained from Kaggle ‘Give Me Some Credit’ competition, and HE dataset comes from a previous paper of credit scoring literature (Baesens et al., 2016). DC dataset (Yeh and Lien, 2009) is acquired from a previous paper of credit scoring literature and UCI Machine Learning Repository (UCI MLR) (Dua et al., 2017). The footnote provides the access to the three datasets.

As shown in Table 3.1 and Figure 3.3, GMSC and HE datasets have missing values in features. Missing values are common in credit scoring datasets. The study of missing values will be discussed further in Chapter 6 using DC dataset, since DC dataset does not have missing values in features. This allows to simulate the research of missing values and imputation

---

<sup>1</sup><https://www.kaggle.com/c/GiveMeSomeCredit>

<sup>2</sup><http://www.creditriskanalytics.net/datasets-private2.html>

<sup>3</sup><http://archive.ics.uci.edu/ml/datasets/default+of+credit+card+clients>

methods in the dataset, comparing the original complete DC dataset with the incomplete DC dataset including generated missingness.

Table 3.2 shows the descriptions of features in GMSC, HE and DC datasets. Within the three datasets as shown in Table 3.2, bad credit samples are defined as the cases that target features named as ‘SeriousDlqin2yrs’, ‘BAD’, ‘default.payment.next.month’, respectively, are specified as 1, which means the applicant has defaulted on the loan or financial obligation. On the other hand, good credit samples are classified as the cases that the label is specified as 0, which means the applicant has paid a financial obligation on time. These target features are binary class label as 0 or 1.

For the transformation of features, e.g., feature scaling, the range of features in dataset affects the training process of specific models such as Support Vector Machine (SVM) and Neural Network (NN) although non-parametric tree-based models are rarely affected by the scale (Xia et al., 2018). More details for data preprocessing methods are discussed in the next section.

### 3.3.3 Preprocessing of Datasets

Since the quality of dataset plays a vital role as famously known as ‘Garbage in, Garbage out’ (Beam and Kohane, 2018) in enhancing the generalised performance of models, preprocessing datasets is essential for modelling credit scoring (García et al., 2012). According to García et al. (2015), the quality of dataset can be evaluated with three factors which are accuracy, completeness and consistency, while for the real-world dataset this is not the case. Noise, outliers and missing values in real-world datasets are generally included. These deficiencies cause a problem in the training process of the model since they make it difficult to extract the latent rules reflected in the dataset (Kotsiantis et al., 2006). Therefore, preprocessing the dataset is a crucial step prior to the modelling process and it consists of methods such as data imputation for missing values, standardisation and normalisation

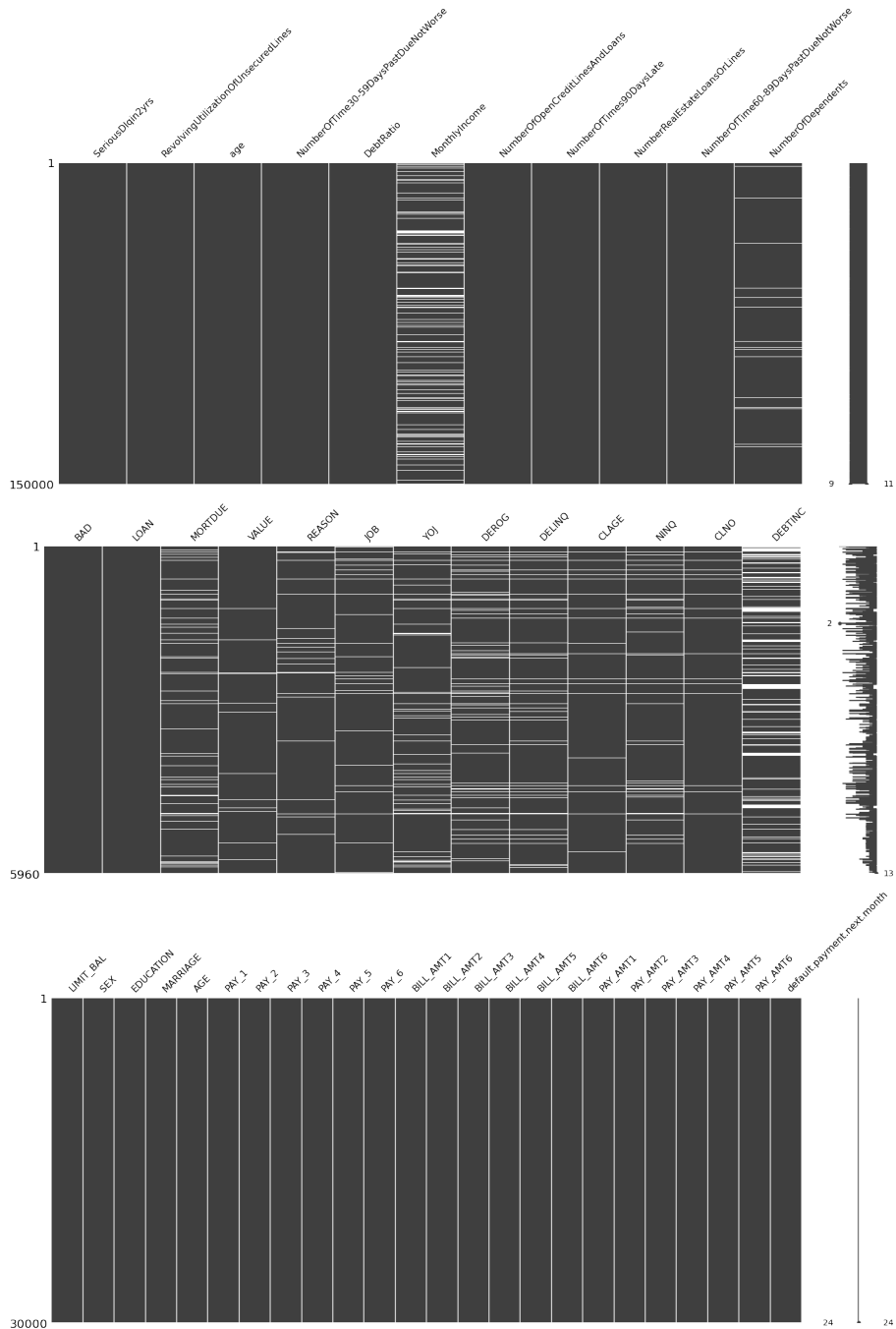

Figure 3.3: Missing values in features on credit scoring datasets (GMSC, HE, and DC in order)

for feature scaling and feature selection and feature engineering for optimal subset, etc.

Credit scoring datasets in the real-world have generally missing values. This missingness might affect the modelling process or distort the analysis of the prediction stage in the model (Jerez et al., 2010; McKnight et al., 2007). Therefore, the missingness in the dataset needs to be handled in the stage of data preprocessing. Substituting missing values with the estimated values in the dataset is preferable to deleting the samples with missing values (Acuna and Rodriguez, 2004). This imputation approaches for missingness in the dataset will be discussed further in Chapter 6.

Figure 3.3 shows the missing values in three credit scoring datasets, respectively. In Chapter 4 and Chapter 5, GMSC and HE datasets are pre-processed to handle any missing values before building the model for credit scoring. As suggested by Acuna and Rodriguez (2004), Lessmann et al. (2015), and Ala'raj and Abbod (2016b) in the literature of credit scoring, missing values in categorical or nominal columns are replaced with the most frequent category in the remaining samples. In addition, missing values in numerical columns are replaced with the mean value in the remaining samples.

On the other hand, features in the dataset have a diverse range of values. The ML models such as Support Vector Machine (SVM) and Neural Networks (NN) are sensitive to the range of input values. In order to reduce the unnecessary bias and enhance the prediction performance in models, the dataset needs to be transformed with normalisation. This rescales the range of values in features to be in the interval  $[0, 1] \in \mathbb{R}$ . The normalisation is expressed as follows:

$$Normalised(V_i) = \frac{V_i - \min(V_i)}{\max(V_i) - \min(V_i)} \quad (3.5)$$

In this thesis, normalising the dataset is utilised in the preprocessing stage in Chapter 5 and Chapter 6. Specifically, the HE dataset in Chapter 5 is normalised prior to the stage of Stacked AutoEncoder (SAE) for extracting

the latent features in a non-linear dataset since SAE is a kind of NN. The DC dataset in Chapter 6 is normalised prior to the stage of randomised Singular Value Decomposition (rSVD) for reducing the noise in the dataset since the imputation approach in Chapter 6 is based on GAIN algorithms, which GAIN is a kind of NN.

As discussed, the scale of features does not greatly affect non-parametric tree-based models (Xia et al., 2018). This thesis mainly focuses on non-parametric tree-based approaches for credit scoring modelling.

In order to simplify the training process of models, Feature Selection (FS) or Feature Engineering (FE) can be applied (Falangis and Glen, 2010). The optimal subset of the original dataset is able to improve prediction performance by reducing the dimensionality of features in the dataset (Guyon and Elisseeff, 2003). The process of FS or FE is normally applied to the dataset after the process of substituting the missing values with estimated values and normalising features in the dataset. The subset of original dataset through FS or FE, hence, has the most effective and least redundant features for training the models.

The difference between FS and FE is that FS optimises a subset of features from all features in the dataset, while FE generates new features from the current features (Dastile et al., 2020). Liang et al. (2015) argued that FS does not always guarantee the performance improvement of models. In addition, Liu and Schumann (2005) also argued that “there is no economic theory to represent which features are relevant to creditworthiness, and the process of choosing the best subset of existing features is unsystematic and dominated by arbitrary trial”. However, Bijak and Thomas (2012) and Brown and Mues (2012) suggested that the least redundant features can improve the performance of the credit scoring model.

SAE is a type of AutoEncoder (AE) and can be used to extract the features for FE. AE is an unsupervised NN that is fully connected to reconstruct the representation or codings for feature extraction (Hinton and Salakhutdinov, 2006). AE consists of encoder and decoder. Figure 3.4 shows



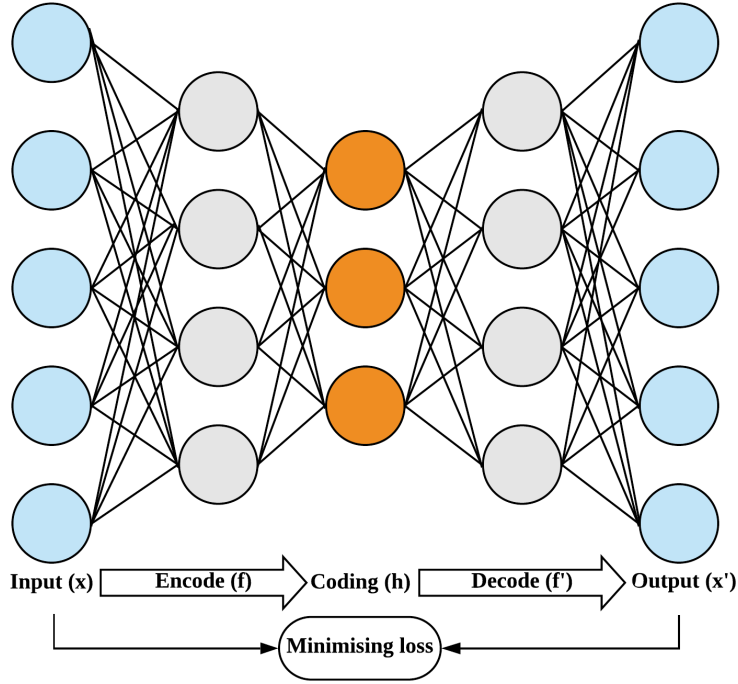

Figure 3.4: The structure of SAE

the structure of AE. In the process of encode, non-linear mapping function  $f$  maps input  $x$  to the representation  $h$  in hidden layer. The encoding can be expressed as follows:

$$h = f(\omega x + b) \quad (3.6)$$

where  $\omega$  denotes the weight between the input  $x$  and the representation  $h$ , and  $b$  represents the bias.  $\omega$  and  $b$  can be obtained after the learning process.

In the process of decode,  $x'$  can be obtained by the representation  $h$  in hidden layer. The decoding can be expressed as follows:

$$x' = f'(\omega' h + b') \quad (3.7)$$

where  $\omega'$  denotes the weight between the representation  $h$  and the output

$x'$ , and  $b'$  represents the deviation. Therefore,  $x'$  is the reconstruction as the output.

AE is trained to minimise the loss, i.e. minimising the reconstruction error. The loss function  $L$  can be expressed as follows:

$$L(x, x') = \frac{1}{N} \sum_{x_k \in D_{train}} \|x - x'\|^2 \quad (3.8)$$

where  $D_{train} = \{(x_k)\}_{k=1}^N$  is a training set.

The loss function  $L$  can be minimised by the iterative learning. With this process, SAE can be used to extract latent characteristics in features since it has the capability to deal with non-linear and complex data for classification (Zhang et al., 2020).

For GMSC dataset in Chapter 4, three features describing the number of late payments after due date, which are ‘NumberOfTime30-59DaysPastDueNotWorse, NumberOfTime60-89DaysPastDueNotWorse, NumberOfTimes90DaysLate’ are combined into a new single feature named as ‘CombinedDefaulted’. Then, ‘NumberOfTime60-89DaysPastDueNotWorse, NumberOfTimes90DaysLate’ are dropped. In addition, two features presenting the number of loans, which are ‘NumberOfOpenCreditLinesAndLoans, NumberRealEstateLoansOrLines’ are merged into a new single feature named as ‘CombinedCreditLoans’. Then, ‘NumberOfOpenCreditLinesAndLoans, NumberRealEstateLoansOrLines’ are dropped. Through this FE, the total number of features on GMSC dataset finally changes from 10 to 8.

For HE dataset in Chapter 5, SAE is applied to the original dataset for extracting the latent characteristics. The extracted three features, which are named as “en1, en2, en3”, are merged into existing features. The total number of features on HE dataset, hence, changes from 12 to 15.

## 3.4 Summary for Designing Proposed Credit Scoring Model

The previous sections discussed the essential steps to build a credit scoring model using ML. The proposed models in this thesis mainly follow the general framework of system architecture shown in Figure 3.2. Therefore, all steps can be summarised as follows:

1. Collecting the dataset
2. Preprocessing the dataset
3. Selecting the features or engineering the features
4. Developing the classifiers and modelling credit scoring
5. Evaluating the predictive performance of built credit scoring model
6. Predicting the classification and explaining the credit scoring model as XAI

These main steps need to proceed sequentially in order to obtain the necessary levels of effectiveness and robustness.

The conceptual and experimental system architecture of the proposed credit scoring model was overviewed. The next sections will discuss the three key issues of credit scoring in more details.

## 3.5 Explainable Models: Parametric vs Non-parametric

LR is regarded as the industry standard for credit scoring. It is supported by the literature of research, since it shows the acceptable level of performance

as well as interpretability when compared to the performance of other classifiers (He et al., 2018). As a parametric model, LR has the advantages of explainability, interpretability, less computational cost for resource and time, and less demand for a huge training dataset.

The parametric model can be expressed with the form of function that connects the target feature to input features in a relational and linear way. However, the parametric model normally does not have strong predictive performance in a non-linear and complex dataset. It shows poor prediction power, which is its main weakness (Bazarbash, 2019).

On the other hand, tree-based models such as RF, GB and XGB are non-parametric models. These non-parametric models are trained on minimal functional assumptions in the learning process from the dataset. This characteristic allows to make models flexible. Therefore, tree-based models, as non-parametric models, have high predictive performance when compared to LR. The prediction power generally tends to increase as the number of samples increases in training tree-based models.

In addition, Russell and Norvig (2002) emphasised that non-parametric models are appropriate and robust in the cases where the data is sufficient and the prior knowledge of the domain is not necessary, and the attention for feature selection is not vital. However, tree-based models tend to be prone to overfitting and, hence, optimal hyperparameters are necessary to be searched by tuning in the training process. Furthermore, it is hard to understand tree-based models and interpret the reasons for prediction.

To overcome this trade-off between the explainability and the predictive power of parametric and non-parametric models in the domain of credit scoring, non-parametric tree-based models which are combined with recent study about explainable AI are proposed. These proposed explainable models allow us to analyse the prediction by SHAP (SHapley Additive exPlanations) values in addition to high predictive performance.

In Chapter 4, this paper performs a comparative experiment between parametric LR and non-parametric tree-based ensemble models for classifi-

cation based on imbalanced credit scoring dataset. In the domain of credit scoring, the problem of class imbalance is common since most applicants for loan have good credit and the remaining few applicants have bad credit. Therefore, a large class imbalance is present and datasets normally show the Imbalance Ratio (IR).

In the experiment, the robustness of non-parametric models such as RF, GB and XGB is analysed, and whether both the standard oversampling and undersampling techniques for imbalanced dataset could improve the performance of classification for credit scoring, is discussed. Furthermore, hyperparameters are optimised to deal with the problem of overfitting in tree-based models, and these tree-based models are interpreted by ‘Explainer’, as suggested by Lundberg and Lee (2017).

The results from this experiment present that GB and XGB outperformed LR in classification performance. Furthermore, oversampling methods are superior to undersampling ways for handling the imbalanced class problem. Finally, GB with oversampling technique performs best in the credit scoring dataset.

### **3.6 Class Imbalance**

In the classification problem, the machine learning model is trained, based on the assumption that the training dataset has the same number of distribution in each corresponding class (Japkowicz, 2000). If the number of difference between each class is not very large, the machine learning model would not be affected much in prediction of classification, while otherwise, the learning process in machine learning would be complicated and the accuracy for performance is biased towards the majority class (Haixiang et al., 2017).

However, in realistic application of credit scoring, most datasets are frequently imbalanced since applicants who have good credit are much greater than applicants who have bad credit. Therefore, the trained model tends to

be overfitted and predict the most common class by maximising the accuracy of overall classification (Drummond and Holte, 2005). This causes to misclassify the label in the classification problem. Cases where the number of difference between each class is large in the classification problem are called as class imbalance.

In the domain of credit scoring, the problem of class imbalance is termed Low Default Portfolios (LDPs), where most applicants for loan have good credit and the remaining few applicants have bad credit. That is, datasets have a much smaller number of samples in the minority class of bad credit applicants than in the majority class of good credit applicants. Therefore, a large class imbalance is present and datasets normally show imbalance ratio (Brown and Mues, 2012).

When compared to balanced datasets, imbalanced datasets normally cause challenges in the learning process for the classification model and result in that machine learning techniques might not be able to handle the problem of class imbalance. Therefore, this would lead to misclassification in discriminating the creditworthiness of applicants for loan.

According to Hand and Henley (1997), financial institutions could prevent a significant amount of loss if the accuracy of classification for credit scoring techniques would be improved with only a percent. Furthermore, He et al. (2018) emphasised that misclassifying a bad applicant as good is more costly than misclassifying a good applicant as bad, since this would lead to latent loss for loans.

As discussed, financial institutions evaluate the potential risk and the creditworthiness of potential borrowers using credit scoring models. This impedes the loss that could be incurred by defaulted credit. The profit and loss of financial institutions thus highly depends on credit scoring models.

Recently, most financial institutions have used the state-of-the-art machine learning models for accurate credit scoring. However, imbalanced classes, a disproportionate ratio of observations in each class, are a common issue in the machine learning classification for credit scoring. Although

Synthetic Minority Oversampling TEchnique (SMOTE) has been the most widely used to oversample the minority class, its performance is still not reaching an acceptable level as neighbouring examples which can be from other classes are not taken into consideration. It also performs poorly when data is high-dimensional and non-linear. When the overlapping of classes is increased, it can introduce additional noise.

As an alternative, Generative Adversarial Networks (GAN) has recently gained popularity. GAN generates synthetic distribution after learning original data, which makes it capable to model complex and non-linear distributions. Several recent studies based on conditional Wasserstein GAN (cWGAN) have shown robust performance in modelling tabular data for credit scoring with both numerical and categorical features. A limited number of studies, however, have been conducted on extracting latent features from non-linear credit scoring data and the existing studies have not considered the explainability aspect for credit scoring models.

In Chapter 5, this paper hence proposes a novel oversampling technique named NOTE (Non-parametric Oversampling Techniques for Explainable Credit Scoring) to overcome such limitations. NOTE consists of three main components. First, non-parametric stacked autoencoder (NSA) extracts latent features that contain non-linear features. Second, cWGAN is utilised to oversample the minority class. Third, using the reconstructed balanced dataset with latent features, the credit scoring classification considering the explainable ML aspect is performed.

Our experimental results successfully demonstrated the utility of the novel concepts used in NOTE by outperforming the state-of-the-art oversampling methods by improving the classification accuracies 3.8% in gradient boosting, 11.6% in decision tree and 17.1% in logistic regression. This could also lead to a better model explainability and stability, particularly for non-linear credit scoring datasets.

## 3.7 Missing Values

The Basel Accord has suggested that credit risk management by models using internal data is beneficial to evaluate the risk factors of financial institutions, namely, probability of default (PD), loss given default (LGD), exposure at default and maturity (EAD) (Basel, 2004). Among these risk components, internal datasets are an essential source for PD estimation (Florez-Lopez, 2010).

As discussed, financial institutions evaluate the probability of default (PD) and the creditworthiness of potential credit borrowers using credit scoring models based on internal datasets. In a real-life application of credit scoring, however, datasets are very often incomplete or have missing values or do not contain sufficient records for PD estimation (Carey and Hrycay, 2001; Zentralbank, 2004).

This missingness in datasets makes it difficult to design credit prediction models, or it might distort analysis when classification models make a prediction process (Jerez et al., 2010; McKnight et al., 2007). Furthermore, a complete dataset is generally necessary to train the state-of-the-art ML models before the process of prediction (Ruiz-Chavez et al., 2018; Smieja et al., 2018).

Nevertheless, the problem of missing values has often been ignored, or basic and simple methods such as removing samples with missing values or mean imputation for missing values, have been applied to cope with incomplete datasets in the analysis of credit scoring (Jerez et al., 2010; Nationalbank, 2004).

As such, many studies have been suggested to deal with the problem of missing data. The approaches can be categorised into two groups, which are deletion and imputation (or substitution). In practice, the imputation methods are preferable to the deletion since they allow to use all available information in the dataset. Furthermore, it is regarded as the most appropriate and valid process for dealing with incomplete dataset to replace the missing



values with the estimated values. As a result, the complete dataset obtained by imputation can be used for modelling credit scoring (Nationalbank, 2004).

As an alternative to statistical imputation and conventional ML imputation methods, Generative Adversarial Imputation Networks (GAIN) (Yoon et al., 2018) as Generative Adversarial Networks (GAN)-based imputation approach has been proposed and shown promising results to fill the missing values in tabular dataset. GAIN was introduced to impute the missing values using GAN architecture in an adversarial way, and it was proved to be more robust than conventional imputation methods. Since GAN learns the characteristics of original data distribution, this makes it capable to understand complex and non-linear missing patterns of original distributions, and finally help fill the missing data with plausible values.

With the state-of-the-art imputation method as denoising GAIN, in Chapter 6 this paper proposes a novel imputation technique named DITE (Denoising Imputation TEchniques) for missing values in a credit scoring dataset. DITE consists of three main steps. First, the dataset is rescaled by normalisation and denoised by randomised Singular Value Decomposition (rSVD). Second, GAIN is utilised to fill in incomplete values in the dataset. Third, using complete dataset after imputation, credit scoring classification is performed.

Our experimental results showed that the use of the novel concepts in DITE outperformed the state-of-the-art imputation methods by improving the imputation performance 7.04%, 6.34 % and 13.38 % on 20%, 50% and 80% missing condition of dataset, respectively. This could finally lead to a more accurate credit scoring model on an incomplete credit scoring dataset.

## Chapter 4

# Non-parametric Approach for Explainable Credit Scoring on Imbalanced Class

### 4.1 Introduction

If the number of differences between each class is not very large, a machine learning model would not be affected much in prediction of classification while, otherwise, the learning process in machine learning would be complicated and the accuracy for performance would be biased towards the majority class (Haixiang et al., 2017).

However, in realistic application of credit scoring, most datasets are frequently imbalanced since applicants who have good credit are much greater than applicants who have bad credit. Cases where the number of differences between each class is large in the classification problem are known as class imbalance. In the domain of credit scoring, the problem of class imbalance is referred to as Low Default Portfolios (LDPs), where most applicants for loan have good credit and the remaining few applicants have bad credit. That is, datasets have a much smaller number of samples in the minority class of

bad credit applicants than in the majority class of good credit applicants. Therefore, a large class imbalance is present and datasets normally show imbalance ratio (Brown and Mues, 2012).

When compared to balanced datasets, imbalanced datasets normally cause challenges in the learning process for the classification model and result in that machine learning techniques might not be able to handle the problem of class imbalance. Therefore, this would lead to misclassification in discriminating creditworthiness of the applicants for loan.

To address the issue of imbalanced class, resampling methods have been proposed (Burez and Van den Poel, 2009). Synthetic Minority Oversampling TEchnique (SMOTE) has been the most widely used to oversample the minority class, since oversampling techniques enable to use all available information, while undersampling techniques discard the part of all available information and result in the loss of information (Zheng et al., 2020).

As mentioned earlier, LR is regarded as the industry standard for credit scoring and is supported by the research literature since it has been showing acceptable performance with interpretability, when compared to the performance of other classifiers (Brown and Mues, 2012; He et al., 2018). However, it shows limited classification performance for non-linear credit scoring dataset since it fails to capture the non-linearity. On the other hand, non-parametric tree-based models are able to capture the non-linear relationships between credit risk features and credit worthiness that LR fails to detect, by exploring the relationship in the partition of samples (Bazarbash, 2019).

Many studies have also shown that non-parametric tree-based ensemble models perform better in credit scoring, when compared to the single algorithms which is a benchmark such as LR (Nanni and Lumini, 2009; Xia et al., 2017; Xiao et al., 2016). These ensemble approaches, hence, have been drawing attention and are regarded as mainstream in the application of credit scoring (He et al., 2018).

However, non-parametric models such as tree-based algorithms are not easy to interpret the prediction although they have high prediction power.

Unexplainable models as black box artificial intelligence (AI) are not appropriate in the area of finance (Bussmann et al., 2021). On the other hand, parametric models such as LR have high interpretability although they have limited predictive performance.

To resolve this trade-off between the explainability and the prediction performance in the domain of credit scoring, the tree-based non-parametric models which are combined with ‘TreeExplainer’ as well as ‘LinearExplainer’ are proposed. These comprehensible models allow us to analyse the prediction by SHAP (SHapley Additive exPlanations) values in addition to high predictive performance. Lundberg and Lee (2017) suggested to explain the prediction by SHAP, which evaluates the contribution of each feature, both globally and locally, for the prediction of models.

The aim of this chapter, hence, is to propose Non-parametric tree-based ensemble models for Explainable credit scoring, named NATE, such as random forest (RF), gradient boosting (GB) and extra gradient boosting (XGB) for improving classification performance on imbalanced credit scoring dataset.

The size of the dataset will be changed by sampling methods to see how the performance of non-parametric tree-based ensemble models are affected by various class imbalance. Especially the robustness of non-parametric tree-based models will be analysed, and whether undersampling and oversampling techniques for imbalanced dataset could improve the performance of classification for credit scoring, will be discussed in a diverse range of class imbalance. Furthermore, the prediction will be explained as ‘eXplainable Artificial Intelligence (XAI)’ in order to understand the classification for credit scoring.

The key contributions of this study are as follows:

- To demonstrate the efficacy of non-parametric models on non-linear dataset for credit scoring
- To present the standard oversampling method by SMOTE synthesising the minority class on imbalanced dataset, compared with undersam-

pling method by NearMiss

- To propose the architecture of non-parametric models on non-linear and imbalanced credit scoring datasets
- To achieve the explainability aspect for practical application in credit scoring as XAI as well as high predictive performance of the proposed non-parametric model

We hypothesise that the proposed NATE will not only improve the classification performance with capturing non-linearity on imbalanced dataset, but also build a model that are explainable for the reasons of credit scoring prediction.

The remainder of this paper is organised as follows: Section II discusses the related studies. Section III describes the proposed NATE with its concepts. Section IV presents the results and evaluates the performance of NATE with the comparison on parametric models using oversampling and undersampling techniques. Finally, Section V concludes with the summarises of the findings from this study.

## 4.2 Related Work

This section discusses the related studies on evolving explainable non-parametric tree-based models for interpretability and resampling approaches for imbalanced class.

### 4.2.1 Explainability as XAI in Credit Scoring

Explainability is important in the domain of credit scoring for both financial institutions and credit applicants. Chen et al. (2016) described the rationale that linear discriminant analysis (LDA) and LR can capture the optimal linear combination of input features and make credit scoring models explainable

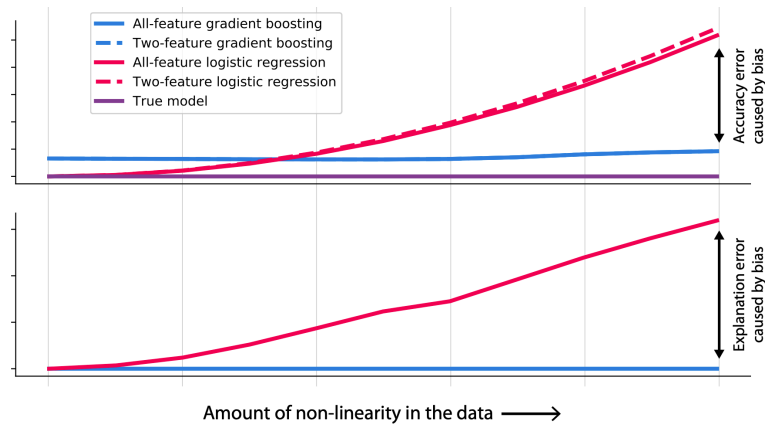

Figure 4.1: Comparison between LR and GB regarding the error of explanation and accuracy (Lundberg et al., 2020)

for the prediction. Despite this advantage, statistical models are often limited in terms of predictive power. This has been seen as their main weakness (Bazarbash, 2019).

Tree-based ML ensemble classifiers such as RF and GB have been the most popular non-linear predictive models in use (Hastie et al., 2009; Lundberg et al., 2020). These models are applied to the areas that make predictions based on a set of input attributes and the predictions need to be both accurate for results and explainable for reasons. In other words, accuracy and explainability need to be balanced in the models, e.g., the fields of medicine and finance (Murdoch et al., 2019). Explainability means that the ways ML classifiers utilise input features for making predictions can be understood (Lundberg et al., 2020).

Since LR uses logistic function, its coefficient can be easily interpretable. However, interaction between variables is ignored with using linear decision boundary. As tree-based algorithms such as RF and GB can be trained in complex and non-linear decision boundary, this means that tree-based models are hard to understand the prediction (Engelmann and Lessmann, 2021). Although DT can be interpreted by decision path, construction of multiple trees in the decision path for tree-based ensemble models makes the

prediction less interpretable.

Recently, a number of research have emerged and been studied in the field of explainable AI (XAI), and one of the study by Lundberg et al. (2020) is about the method to make tree-based models explainable for decisions using input contribution. A related study by Lundberg and Lee prior to Lundberg et al. (2020) suggested ‘TreeExplainer’ with SHAP (SHapley Additive exPlanations)(Lundberg and Lee, 2017), which is a united approach based on Shapley values of coalitional game theory. Shapley (1953) suggested the values which correspond to the average of each contribution of the players with a pay-off concept in cooperative game theory. This Shapley values can be applied to estimate the contribution of each input feature for each prediction of ML models (Bussmann et al., 2021). In other words, they allow to explain the prediction of ML models, enable the analysis of ML models and help us understand them, regarding both how much each feature contributes for target feature globally and how a certain sample is predicted by SHAP values of features in the certain sample locally. In addition to ‘TreeExplainer’, Lundberg and Lee (2017) also proposed ‘LinearExplainer’ that it allows us to analyse the prediction by LR globally and locally using the same ways, although its coefficient can be easily interpretable as discussed above.

On the other hand, the measure of feature importance in tree-based ensemble models is able to compute the importance of each input and explain the reasons for prediction. However, it is limited since feature importance shows only the importance across entire samples, not on each case for the prediction.

Furthermore, tree-based ensemble models are more appropriate to capture the non-linearity in the dataset. According to the results by experiments on medical datasets (Lundberg et al., 2020) and as shown in Figure 4.1, the greater degree of non-linearity in the dataset, the greater the explanation error and accuracy error although tree-based GB shows stability. This means that explainability as well as accuracy drops as non-linearity in the dataset increases, since other irrelevant features are also selected for the prediction of

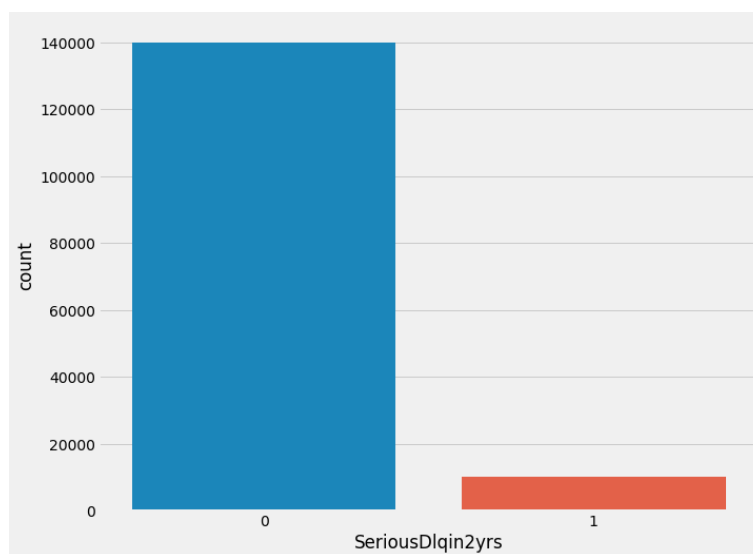

Figure 4.2: The imbalanced class on GMSC dataset, where 0 means not defaulted (good credit) and 1 means defaulted (bad credit)

the model and the relation between target feature and training features becomes less explainable (Lundberg et al., 2020). This implies that tree-based models are preferable to linear models if the accuracy is the same by each case.

#### 4.2.2 Ensemble Approach with Oversampling Techniques in Credit Scoring

Many studies have tried to optimise the classification performance in the problem of imbalanced class on credit scoring datasets. One of the approaches to deal with imbalanced class is a resampling techniques, as discussed earlier. Resampling techniques are to adjust the number of samples and balance the classes on original data by reducing the number of majority or by increasing the number of minority. Since oversampling techniques allow to use all available information, they have been extensively preferable to undersampling methods in the studies.



Table 4.1: GMSC dataset

Dataset	#Samples	#Good	#Bad	Imbalance ratio	#Features
GMSC	150,000	139,974	10,026	13.961	10

Chawla et al. (2002) proposed Synthetic Minority Oversampling Technique (SMOTE). This method generates new samples between the cases in the minority class and their neighbours in the same class using local information by K-Nearest Neighbours (KNN) algorithm rather than directly duplicates the samples in the minority class (He et al., 2018). Han et al. (2005) suggested Borderline-SMOTE (B-SMOTE) and Hu et al. (2009) recommended Modified-SMOTE (M-SMOTE). Both B-SMOTE and M-SMOTE are the variants of SMOTE to overcome the limitation of SMOTE and improve classification performance, since the sample in minority class and its neighbouring sample might be in the different class when SMOTE oversamples the minority class.

He et al. (2008) proposed the ADaptive SYNthetic (ADASYN) sampling approach for imbalanced datasets using weighted distribution in the samples of minority class. This method allows to reduce the biased performance towards class imbalance.

Batista et al. (2004) proposed the comparative experiments using resampling methods such as oversampling and undersampling on diverse imbalanced datasets. Their findings concluded that oversampling methods generally show more accurate results than undersampling methods regarding AUROC. Brown and Mues (2012) suggested comparative results using diverse algorithms to see the effect of resampling method on imbalanced credit scoring datasets. The results showed that RF and GB performed well compared to LR on imbalanced credit scoring datasets. Marqués et al. (2013) proposed resampling techniques on imbalanced credit scoring datasets and proved that resampling methods, especially oversampling approaches, consistently improve the classification performance. On the other hand, Khoshgoftaar et al. (2007) argued that an even distribution does not guarantee an

optimal performance when handling the issue of class imbalance.

Zieba et al. (2016) employed extreme gradient boosting (XGB) for bankruptcy prediction on credit datasets and showed the better results against the benchmark. Xiao et al. (2016) proposed the ensemble approach based on supervised clustering in order to partition the samples of each class and improved classification performance on credit scoring. Xia et al. (2017) utilised XGB model with Bayesian hyperparameter tuning and showed the aspect of interpretability as well as the improvement of classification performance in credit scoring.

These studies have shown that non-parametric tree-based ensemble approaches have been increasing to improve the performance on imbalanced credit scoring as well as on balanced dataset. Therefore, non-parametric tree-based ensemble models combined with ‘TreeExplainer’ can overcome the limitation of predictive performance in LR as the standard as well as adding interpretability for prediction in the domain of credit scoring.

### **4.3 NATE: Non-pArameTric approach for Explainable credit scoring on imbalanced class**

The NATE consists of four stages, which are as follows:

1. Collecting GMSC dataset
2. Balancing the dataset to undersample the majority class (good credit sample) by NearMiss or to oversample the minority class (bad credit samples) by SMOTE
3. Predicting classification on both parametric models and non-parametric models using oversampled and undersampled dataset for comparison
4. Explaining the model by ‘TreeExplainer’ and ‘LinearExplainer’ as XAI

These stages need to process sequentially in order to obtain the necessary levels of effectiveness.

GMSC (Give Me Some Credit) dataset is used to test tree-based ensemble classifiers for evaluating the performance on different imbalance ratios against LR. The dataset shows the demographics, payment behaviour and delinquency information for the samples and comes from Kaggle competition which is called as ‘Give me some credit’. The dataset is widely used as the benchmark in the study of credit scoring literature (Engelmann and Lessmann, 2021).

There are 150,000 samples in the dataset with approximately 140,000 not defaulted credit samples and 10,000 defaulted credit samples, respectively. Bad credit samples are defined as the cases that target feature named ‘SeriousDlqin2yrs’ is specified as 1, which means the applicant has defaulted on the loan. On the other hand, good credit samples are classified as the cases that the label is specified as 0, which means the applicant has paid a financial obligation. This is a binary class label. The dataset was used due to its non-linearity in the results (Engelmann and Lessmann, 2021) for validating the robustness of non-parametric models against the parametric model.

The initial dataset shows the percentage of minority class in total as 6.684 % and Imbalance Ratio (IR) as 13.961, which is the number of the majority class divided by the number of the minority class. The dataset contains 10 features that can directly be interpreted into a credit scoring system, excluding target feature. Table 4.1 shows the description of the dataset and Figure 4.2 shows the imbalanced class in the dataset.

In order to have the different imbalance ratio or proportion in credit samples of the dataset, the number of distribution in the dataset has been changed to give different class distribution. This could be done by sampling techniques that are used for changing distribution of imbalanced dataset with under-sampling good credit samples or over-sampling bad credit samples, since the number of good credit samples is much higher than the number of

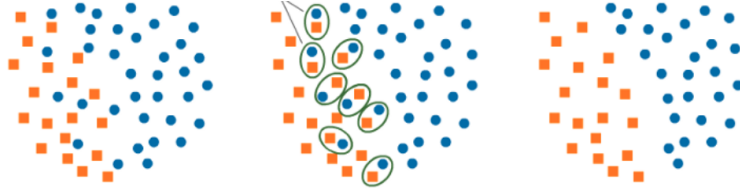

Figure 4.3: The balanced class distribution by NearMiss

Table 4.2: Undersampled dataset

Undersampling #good	7%(original)	15%	32%	50%
Imbalance ratio	13.961	5	2	1
#Not defaulted	139,974	50,130	20,052	10,026
#Defaulted	10,026	10,026	10,026	10,026

bad credit samples as described above.

There are two standard techniques that have been commonly used for dealing with imbalanced class, which are NearMiss for undersampling and SMOTE for oversampling. Table 4.2 and 4.3 show the resampled credit dataset with different imbalanced ratio and distributions of good credit and bad credit, respectively.

By the method of undersampling, NearMiss suggested by Mani and Zhang (2003), has been applied to the original dataset. NearMiss is an undersampling method that eliminates the samples of majority class randomly using the distance-based or near-neighbour method. When the samples of majority class and the samples of minority class are neighbouring, the samples of the majority class are removed until the class distributions are balanced. Figure 4.3 shows the balanced class distribution by NearMiss.

From 139,974 good credit samples, 50,130 samples have been used to make the ratio of class imbalance as 5 and the percentage of bad credit class in total as 15 %; 20,052 samples have been used to make the ratio of class imbalance as 2 and the percentage of bad credit class in total as 33 %; 10,026 samples have been used to make the ratio of class imbalance as 1

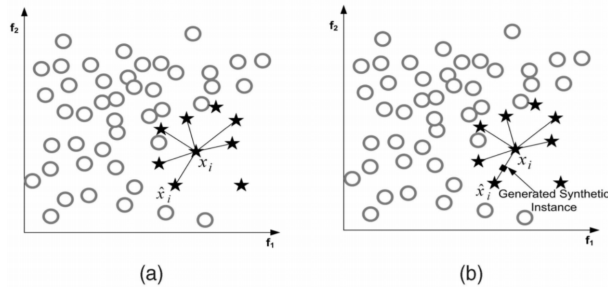

Figure 4.4: The synthetic sample generated by SMOTE

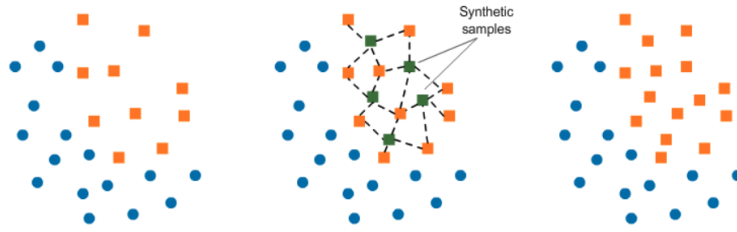

Figure 4.5: The balanced class distribution by SMOTE

and the percentage of bad credit class in total as 50 %. NearMiss, finally, undersampled the majority samples, which was reduced to the total number of minority samples and the dataset has been balanced.

On the other hand, by the method of oversampling, Synthetic Minority Oversampling Technique (SMOTE) suggested by Chawla et al. (2002) has been applied to the original dataset. SMOTE is an oversampling method that generates synthetic samples using local information near the samples by K-Nearest Neighbour (KNN). After selecting a sample  $x_i$  in the minority class, neighbouring  $\hat{x}_i$  is determined by KNN as shown in Figure 4.4 (a). Then,  $x_{synthetic}$  between existing samples of minority class is randomly generated with  $\lambda$  in interval  $[0, 1]$  as shown in Figure 4.4 (b). Finally, the number of the minority class is oversampled to the same number of the majority class as shown in Figure 4.5. SMOTE can be expressed as follows:

$$x_{synthetic} = x_i + \lambda(\hat{x}_i - x_i), \lambda \in [0, 1] \quad (4.1)$$

From 10,026 bad credit samples, 24,228 samples have been used to make the ratio of class imbalance as 5.622 and the percentage of bad credit class in total as 15 %; 65,797 samples have been used to make the ratio of class imbalance as 2.064 and the percentage of bad credit class in total as 32 %; 135,867 samples have been used to make the ratio of class imbalance as 1 and the percentage of bad credit class in total as 50 %. SMOTE, finally, oversampled the minority samples, which increased to the total number of majority samples and the dataset has been balanced.

As a result, by resampling the class distribution, six datasets are created from the original dataset. The performance of non-parametric tree-based ensemble models can be evaluated and compared against the LR model on the original dataset of the percentage of class imbalance 6.694 % and imbalance ratio 13.961 as a benchmark.

Table 4.3: Oversampled dataset

<b>Oversampling #bad</b>	<b>7%(original)</b>	<b>15%</b>	<b>32%</b>	<b>50%</b>
Imbalance ratio	13.961	5.622	2.064	1
#Not defaulted	139,974	136,208	135,784	135,867
#Defaulted	10,026	24,228	65,797	135,867

Following balancing the class distribution by resampling techniques, tree-based ensemble algorithms perform the prediction for credit scoring as non-parametric approach.

Figure 4.6 shows the overall of system architecture. Through this experiment, it can be validated whether non-parametric algorithms paired with resampling techniques could improve the performance of classification in the cases where datasets show class imbalance, against the standard method as LR on original imbalanced dataset.

ML classifiers including tree-based models are employed for performance comparison and they are as follows:

Logistic Regression (LR) has been a commonly used model in the do-

main of credit scoring since it is easily interpretable (Cox, 1958). Linear Discriminant Analysis (LDA) is a statistical learning method to model a linear combination of features that separates the class (Fisher, 1936). Both LR and LDA are the parametric models. K-Nearest Neighbour (KNN) is a distance-based classifier to calculate the distance between input feature vectors and assign the points to the class of its K-nearest neighbours (Hensley and Hand, 1996). KNN is a non-parametric algorithm. Decision Tree (DT) splits the dataset recursively based on information for the classification (Quinlan, 1986) and is a non-parametric model. Naive Bayes (NB) is a probabilistic classifier based on Bayesian theorem (Rish et al., 2001). NB is commonly regarded as parametric model although it can be either parametric or non-parametric depending on the combination of parameters. Random Forest (RF) is an ensemble method aggregated with multiple decision tree classifiers (Breiman, 2001). Gradient Boosting (GB) is a boosting method to combine weak classifiers into one strong model and enhance the classification performance (Friedman, 2001). DT as base learner is used in the experiment of GB in this study. Both RF and GB are non-parametric models. Extreme Gradient Boosting (XGB) is non-parametric model that combines with tree-models of GB to classify different tasks and optimise them (Chen and Guestrin, 2016).

The performance measure of this experiment is the Area Under the Receiver Operator Characteristic curve (AUROC) as discussed in Chapter 2. As the accuracy of classification performance in imbalanced dataset tends to be biased towards the majority class as discussed earlier, the measure of performance as AUROC is used, which is the standard metric for evaluating classification for imbalanced dataset (Haixiang et al., 2017; Huang and Ling, 2005).

Following performing the prediction by ML models, the prediction can be interpreted by explanation with ‘TreeExplainer’ and ‘LinearExplainer’.

As discussed, SHAP suggested by Lundberg and Lee (2017) allows to explain the prediction of a certain sample by estimating the contribution of

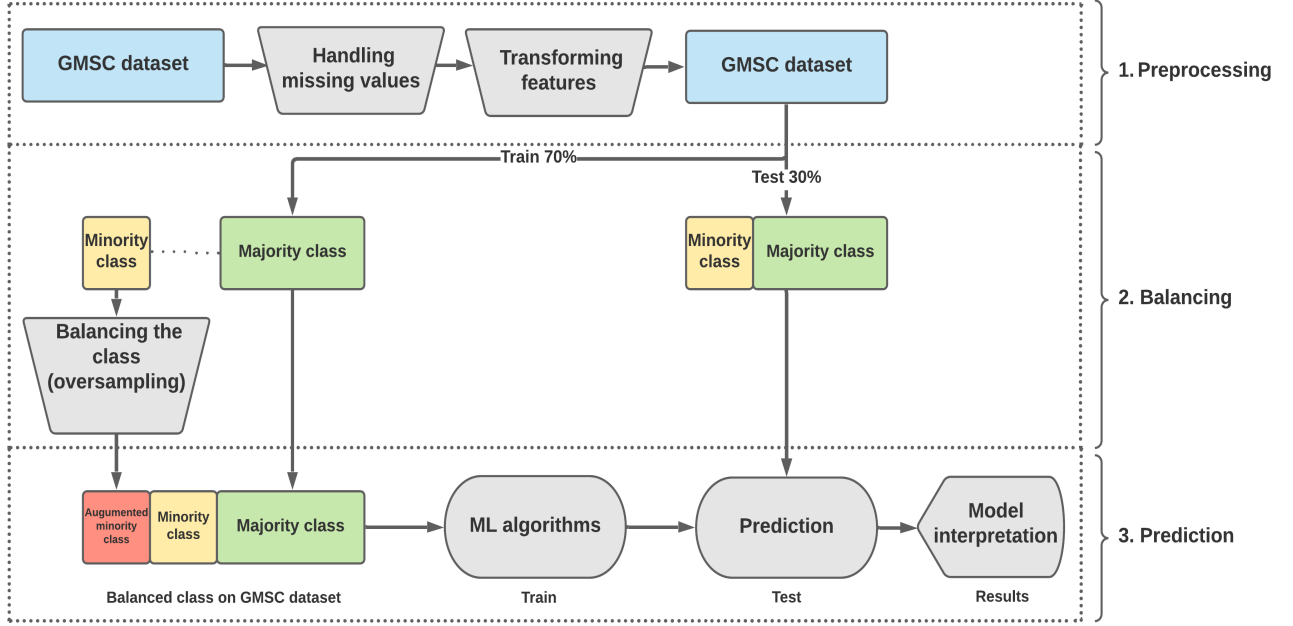

Figure 4.6: The system architecture

each feature. Both ‘TreeExplainer’ as the estimation for tree-based models and ‘LinearExplainer’ as the estimation for LR model can be applied to interpret ML models. SHAP can be represented by an additive form of feature attribution with Shapley values (Shapley, 1953) as follows:

$$g(z') = \phi_0 + \sum_{i=1}^M \phi_i z'_i \quad (4.2)$$

where  $g$  is the model for explanation, i.e., the approximation of the prediction,  $z' \in \{0,1\}^M$  is the coalitional vector (or called as ‘simplified features’ in the study of Lundberg and Lee (2017)), describing 1 as ‘present’ and 0 as ‘absent’,  $M$  is the maximum of coalitional size, i.e., the number of the employed input features, and  $\phi_i \in \mathbb{R}$  is the attribution for feature  $i$ .

For example, if the values for all features are present ( $z' = 1$ ), then Eq. 4.2 can be simplified as follows:



Table 4.4: The performance comparison for accuracy and AUC between ML models on original dataset

Classifier	Accuracy	AUC
LR	0.9323	0.7681
LDA	0.9326	0.8016
KNN	0.9311	0.5891
DT	0.8932	0.5943
NB	0.9311	0.7746
RF	0.9320	0.8246
GB	<b>0.9343</b>	<b>0.8542</b>
Bayes Net Boughaci and Alkhaldeh (2020)	0.9450	0.8550

$$g(x') = \phi_0 + \sum_{i=1}^M \phi_i \quad (4.3)$$

SHAP satisfies the following properties which are local accuracy, missingness and consistency. These characteristics were proved by Lundberg and Lee (2017). Their proof bridged the discrepancies between SHAP and Shapley values for the interpretation of ML models. For bridging the gap and interpreting ML models, Shapley value is defined as follows:

$$\phi_i(f, x) = \frac{1}{|M|!} \sum_{z' \subseteq x'} |z'|!(M - |z'| - 1)! [f_x(z') - f_x(z'nj)] \quad (4.4)$$

where  $f$  is trained model,  $z'nj$  indicates  $z'_j = 0$ ,  $x$  represents input features,  $x'$  denotes M selected input features, and  $f_x(z') - f_x(z'nj)$  is the feature contribution of sample  $i$  for each prediction (Bussmann et al., 2021).

As discussed, the characteristics of Shapley value can be applied to interpreting the models as follows (Bussmann et al., 2021):

- As local accuracy, the Shapley values can quantify with constructing

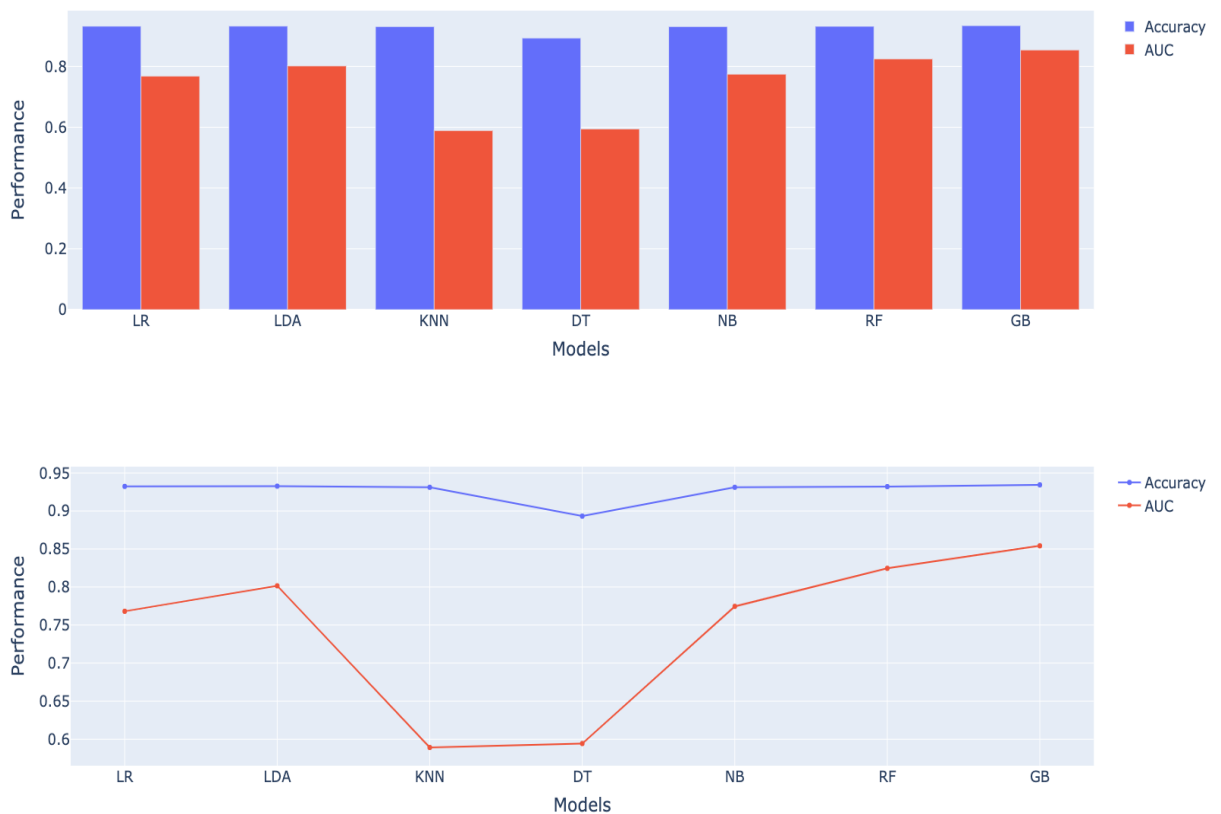

Figure 4.7: The performance comparison for accuracy and AUC between ML models on original dataset

an explainable model that estimates the original model by an additive form locally for a certain sample  $x$ .

- As missingness, if a feature is 0 (i.e., a feature is missing), then the Shapley value is 0 (i.e., a missing feature has zero attribution).
- As consistency, if the contribution of feature increases or decreases regardless of other features in the model, then Shapley value also increases or decreases.

With these characteristics, the Shapley values of the features are cal-

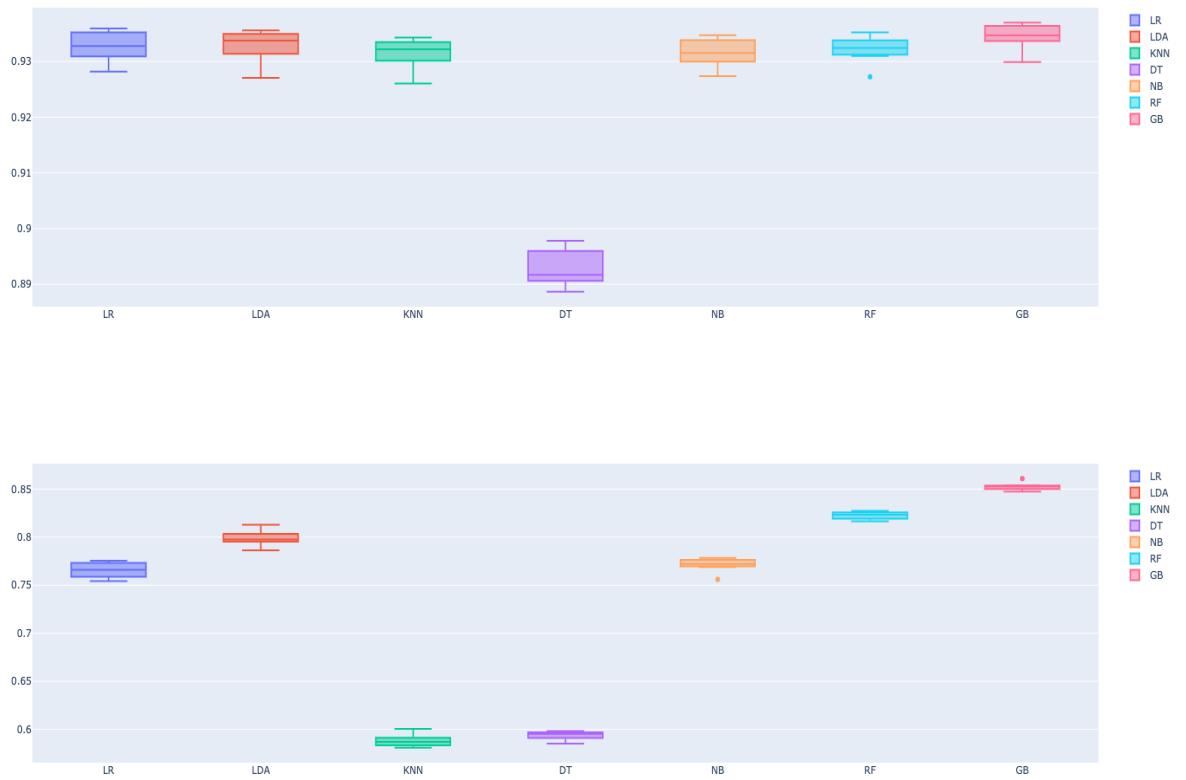

Figure 4.8: The performance comparison for accuracy (above) and AUC (below) between ML models on original dataset

culated by SHAP (Lundberg et al., 2020) for the explanation of predictions both locally and globally in credit scoring models.

On the other hand, Local Interpretable Model-agnostic Explanations (LIME) also allows to explain the prediction by building sparse linear models in the ML models. This means that LIME is able to explain how ML models work around the prediction by using local linearity. However, LIME lacks the local accuracy and consistency for the interpretation of models, whilst SHAP suggests the guarantee of the characteristics, according to Lundberg and Lee (2017). In addition to this lack of properties, there is no theoretical

basis why the prediction of ML models can be interpreted by using local linearity around the prediction, whilst SHAP is supported by mathematical proof as discussed earlier.

Furthermore, the primary models in the proposed NATE are non-parametric tree-based models. SHAP is based on the tree-based models and allows intuitively to visualise the explanation both locally and globally when compared to LIME. Therefore, SHAP supported by theoretical proof and intuitive visualisation is more appropriate to the explainable aspect of the prediction than LIME.

As shown in Figure 4.6, the overall system architecture for the proposed study is summarised as follows:

Firstly, credit scoring dataset is pre-processed. In this stage, features are transformed by methods such as standardisation and normalisation. Missing values in features are handled. Secondly, feature extraction techniques such as feature engineering are applied to datasets, as discussed in Section 3.3.3. During this process, the importance of features is calculated, subsets of features are optimised, model-based features are selected, and imbalanced datasets are resampled to certain ratio or balanced class, in order to decide the most effective and least redundant features or subsets before training ML models.

The ensemble classifiers such as RF, GB and XGB are employed to train the model and perform the classification with datasets of different imbalance ratio that are resampled by sampling techniques, in order to validate how class imbalance or imbalance ratio affects tree-based ensemble classifiers in the domain of credit scoring.

The results of performance for non-parametric models such as RF, GB and XGB are compared between the results of performance for parametric models such as LR as a benchmark which is the most frequently used classifier in the domain of credit scoring, as discussed.

Finally, the interpretation by ‘Explainer’ is performed to understand

Table 4.5: The performance comparison of AUC on different IR of dataset

Undersampling #good	7%(original)	15%	32%	50%
Imbalance ratio (IR)	13.961	5	2	1
#Not defaulted	139,974	50,130	20,052	10,026
#Defaulted	10,026	10,026	10,026	10,026
LR	0.7726	0.7916	0.8112	0.8272
RF	0.8489	0.8576	0.8744	0.8848
GB	<b>0.8561</b>	<b>0.8609</b>	<b>0.9156</b>	<b>0.9369</b>
XGB	0.8542	0.8581	0.9071	0.9274
Bayes Net Boughaci and Alkhaldeh (2020)	0.8550	N/A	N/A	N/A
Oversampling #bad	7%(original)	15%	32%	50%
Imbalance ratio (IR)	13.961	5.622	2.064	1
#Not defaulted	139,974	136,208	135,784	135,867
#Defaulted	10,026	24,228	65,797	135,867
LR	0.7726	0.8385	0.8342	0.8361
RF	0.8489	0.9299	0.9465	0.9561
GB	<b>0.8561</b>	<b>0.9510</b>	<b>0.9708</b>	<b>0.9808</b>
XGB	0.8542	0.9485	0.9657	0.9757
Bayes Net Boughaci and Alkhaldeh (2020)	0.8550	N/A	N/A	N/A

the contributions of input features for the prediction of credit scoring both locally and globally.

## 4.4 Results

This section evaluates classification performance by resampling and interprets the prediction by Explainer.

### 4.4.1 Benchmarks on the Original Dataset

Table 4.4 and Figure 4.7 show the performance comparison of accuracy and AUC on both parametric and non-parametric classifiers on original imbalanced credit scoring dataset. The accuracy and AUC for performance mea-

Table 4.6: Searching space for hyperparameters in Table 4.5

Algorithm	Hyperparameter	Value
LR	penalty	{‘none’, ‘L1’, ‘L2’, ‘elasticnet’}
	inverse penalty coefficient C	loguniform(1e-5, 100)
	solver	{‘newton-cg’, ‘lbfgs’, ‘liblinear’}
RF	n_estimators	[100, 1000]
	max_features	{‘auto’, ‘sqrt’}
	max_depth	[1, 20]
	min_samples_split	{1, 2, 5, 10}
	min_samples_leaf	{1, 2, 4, 8}
	bootstrap	{‘True’, ‘False’}
GB	n_estimators	[100, 1000]
	learning_rate	{‘0.01’, ‘0.1’, ‘0.5’}
	max_depth	[1, 20]
	Base learner	Decision Tree
XGB	n_estimators	[100, 1000]
	learning_rate	{‘0.01’, ‘0.1’, ‘0.5’}
	max_depth	[1, 20]
	Base learner	Decision Tree

sure are calculated by 10-fold cross validation. Since the number of samples in each class has a huge difference, i.e., the dataset is heavily imbalanced, the accuracy is biased towards the majority class as shown in Table 4.4. This implies that the accuracy is not a proper measure for evaluating the performance. Therefore, AUC as another metric is considered at the same time, as discussed earlier.

As shown in Table 4.4, Figure 4.7 and Figure 4.8, GB has the highest accuracy and AUC. When compared to parametric algorithms such as LR, LDA and NB, non-parametric ensembles classifiers such as RF, GB, and XGB show better results aligned with the previous studies in both accuracy and AUC. It is proved that RF, GB, and XGB as non-parametric models

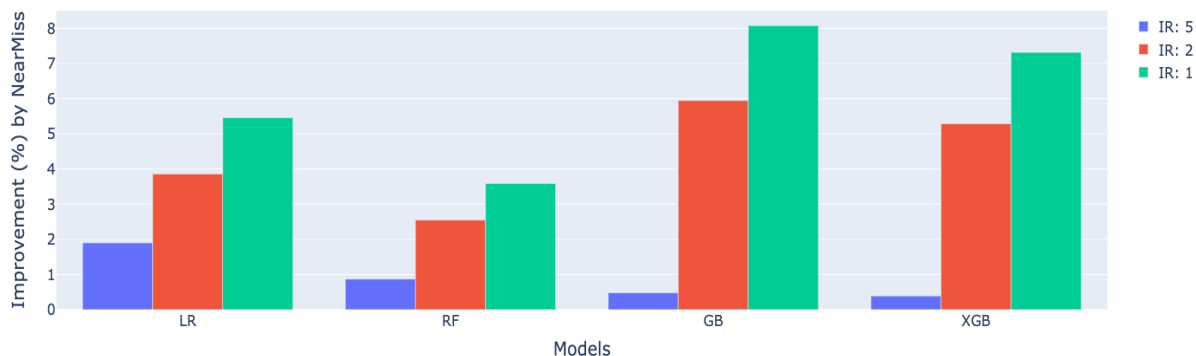

Figure 4.9: AUC improvement of classification models by undersampling method (NearMiss) against LR on original dataset (IR=13.9)

have the ability to focus on local features in imbalanced dataset and non-linear dataset (Brown and Mues, 2012). Therefore, non-parametric models need to be explored further regarding classification performance, based on the justification of these results.

#### 4.4.2 Performance Comparison on Resampled Dataset

The performance of classifiers on varying imbalance ratio between the classes is compared on seven datasets including the original dataset in order to validate the effect of imbalanced dataset.

In order for the performance comparison between parametric and non-parametric models, 70% of the dataset is used to train the models and the remaining 30% of the dataset is used to test the models for evaluating the performance by AUC. In addition, tree-based models with non-pruning have the risk of overfitting on the dataset. Hyperparameters of LR, RF, GB and XGB, hence, are optimised by random search with 3-fold cross validation over searching space on balanced dataset (IR=1), in order to have optimal performance. Table 4.6 shows the searching space for hyperparameters.

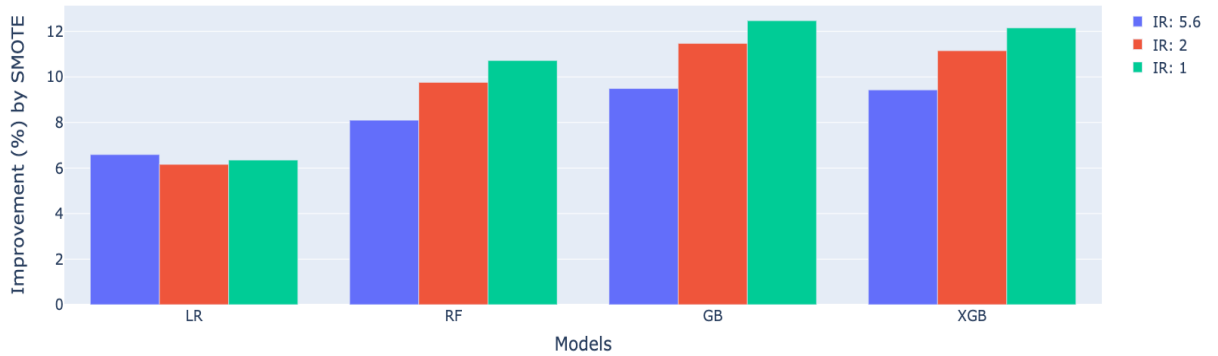

Figure 4.10: AUC improvement of classification models by oversampling method (SMOTE) against LR on original dataset (IR=13.9)

Table 4.5 shows the AUC comparison of tree-based ensemble classifiers against LR as a benchmark on the different IR by undersampling and oversampling techniques. Figure 4.9 and Figure 4.10 show the AUC improvement by NearMiss and SMOTE, respectively. As shown in Table 4.5, Figure 4.9 and Figure 4.10, most classifiers perform better on lower imbalance ratio by both undersampling NearMiss and oversampling SMOTE, which means the more similar the number of class distributions are, the better performance we can expect. It is proved that resampling methods are robust in imbalanced dataset, and especially SMOTE as oversampling method improved the performance further than NearMiss as undersampling approach.

Furthermore, non-parametric models such as RF, GB and XGB have better results against LR as the benchmark on both original imbalanced and resampled balanced dataset as shown in Table 4.5. This means that non-parametric models can capture the non-linearity if the dataset is complex and non-linear. Therefore, the efficacy of non-parametric models on non-linear credit scoring datasets is demonstrated.

In addition, Engelmann and Lessmann (2021) proved that oversampling technique in non-linear dataset showed the best classification performance



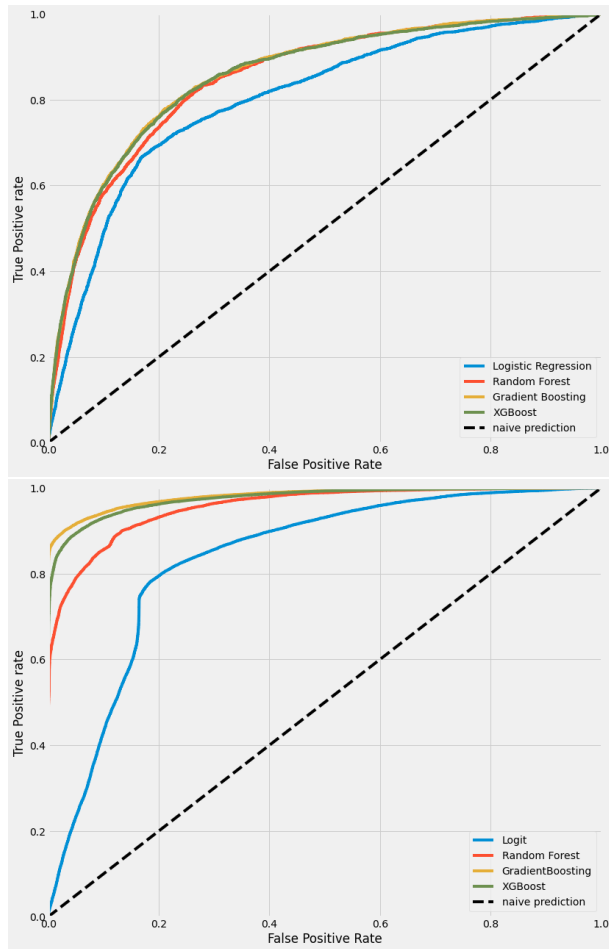

Figure 4.11: The ROC of non-parametric classifier against parametric model on original dataset (above) and balanced dataset (below)

when paired with tree-based models like RF, GB and XGB. Therefore, Table 4.5 supports their results by Engelmann and Lessmann (2021) since GMSC dataset is non-linear credit scoring dataset, and the standard oversampling method paired with tree-based models is suggested on imbalanced non-linear datasets.

As shown in Table 4.5, Figure 4.8, Figure 4.9 and Figure 4.10, GB has the best results on all imbalance ratios on imbalanced datasets as well as on the balanced dataset by both undersampling and oversampling methods.

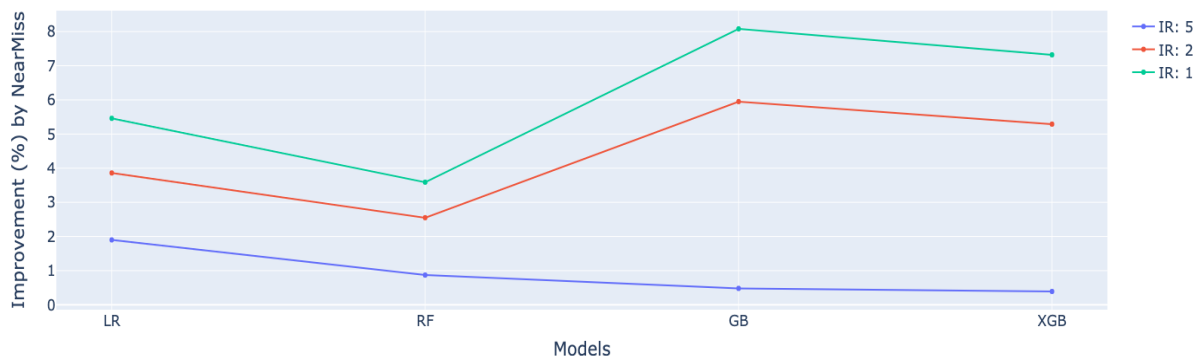

Figure 4.12: AUC improvement of classification models by undersampling method (NearMiss) against LR on original dataset (IR=13.9)

Finally, Figure 4.11 shows that the resampling method by SMOTE improved the AUCs of the models against non-resampling.

### 4.4.3 Performance Comparison: Undersampling vs Oversampling

The performance of classifiers by undersampling and oversampling, is compared with same imbalanced ratio in the dataset, in order to validate the

Table 4.7: The increment of AUC (over - under) between oversampling and undersampling

Imbalanced distribution	15%	32%	50%
Imbalance ratio	5	2	1
LR	0.0469	0.0230	0.0089
RF	0.0723	0.0721	0.0713
GB	0.0901	0.0552	0.0439
XGB	0.0904	0.0586	0.0483

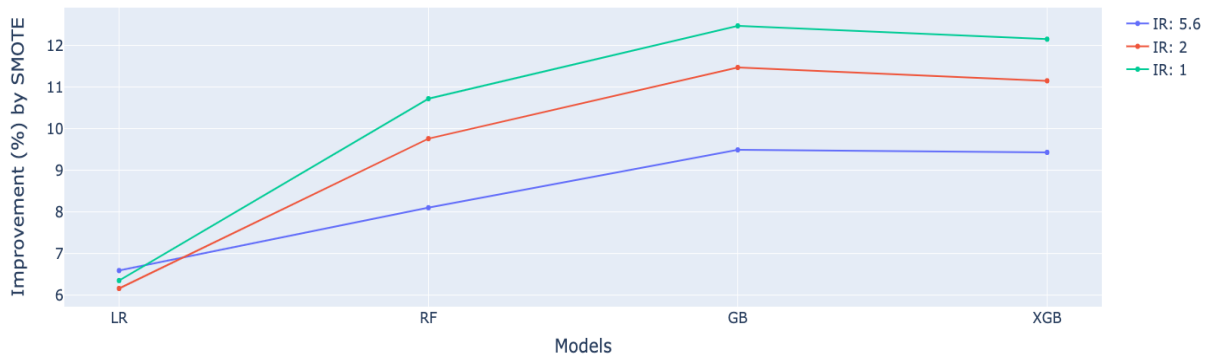

Figure 4.13: AUC improvement of classification models by oversampling method (SMOTE) against LR on original dataset (IR=13.9)

effect of resampling techniques. The difference of AUC is obtained by AUC of oversampling minus AUC of undersampling, based on the same imbalance ratios of resampled dataset and the different sampling methods.

As shown in Table 4.7, most classifiers perform better with oversampling techniques since the values are positive. For example, the increments of AUC on RF are 0.0723, 0.0721 and 0.0713 in the cases of 15%, 32% and 50% bad credit samples in total, respectively. The increments of AUC on GB are 0.0901, 0.0552 and 0.0439 in the cases of 15%, 32% and 50% bad credit samples in total, respectively. The increments of AUC on XGB are 0.0904, 0.0586 and 0.0483 in the case of 15%, 32% and 50% bad credit samples in total, respectively.

As shown in Figure 4.12 and Figure 4.13, SMOTE improved AUCs further than NearMiss in both all classifiers and imbalance ratio. Therefore, NATE successfully suggested the architecture of non-parametric models on non-linear and imbalanced credit scoring dataset by achieving the best AUC.

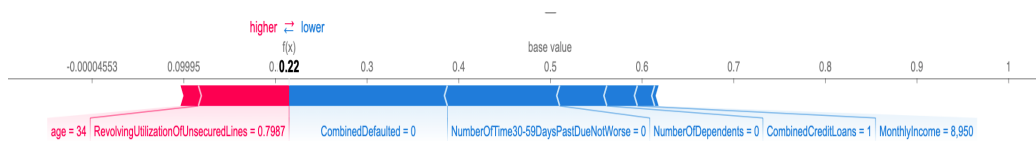

Figure 4.14: SHAP value plot for individual sample predicted by GB



Figure 4.15: SHAP value plot for individual sample predicted by GB

#### 4.4.4 Interpretability of Predictions

Figure 4.14 and Figure 4.16 show the interpretation of the prediction for credit scoring on an individual good credit applicant. It explains which features contribute to the prediction when a certain individual sample is classified as ‘not defaulted’, and helps us interpret the model locally. ‘CombinedDefaulted = 0’ and ‘NumberOfTime30-59DaysPastDueNotWorse = 0’ are two of the most important features for the prediction in non-defaulter.

More details are shown in Figure 4.14, where the base value 0.5 is a turning point and threshold between a good and bad credit applicant. The blue features such as ‘CombinedDefaulted = 0’ and ‘NumberOfTime30-59DaysPastDue-NotWorse = 0’ push the sample to the left which is the direction to the good credit, and the red features such as ‘RevolvingUtilizationOfUnsecuredLines=0.799’ and ‘age=34’ push the sample to the right which is the direction to the bad credit. Through the combination of each feature impact in the NATE, the sample is finally classified as a good credit applicant with the value 0.22, which is below the threshold 0.5

Furthermore, NATE shows how the model classifies the applicant as a good credit through the decision path in the process, as shown in Figure 4.16. The decision starts from ‘DebtRatio’ at the bottom, moves onto the next features, and finishes at ‘CombinedDefaulted’, reflecting the magnitude

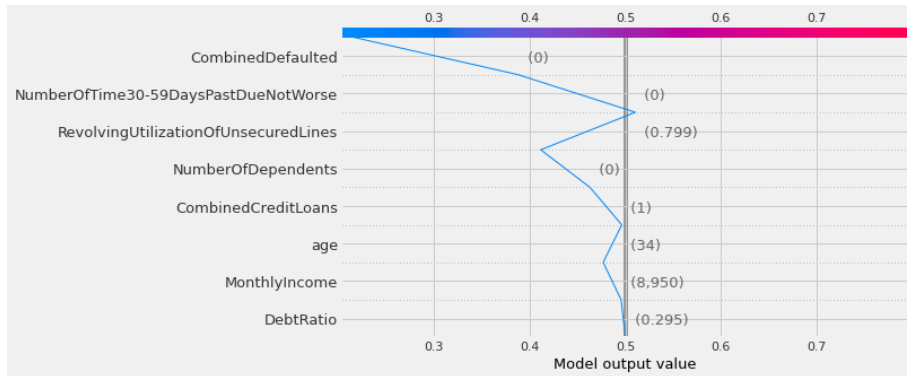

Figure 4.16: SHAP decision plot for individual sample predicted by GB

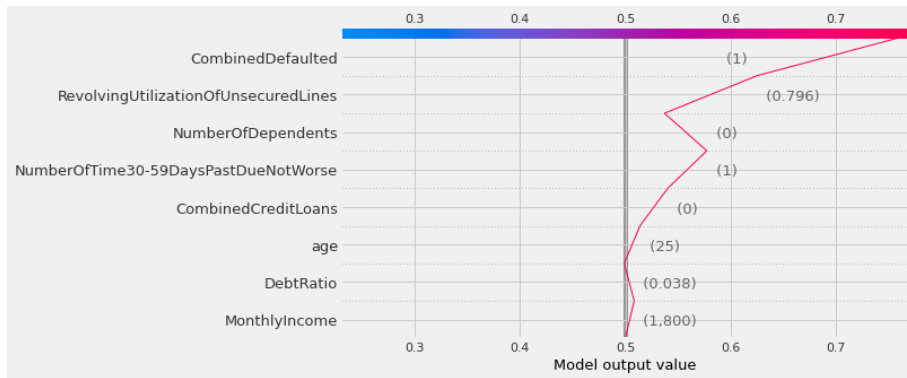

Figure 4.17: SHAP decision plot for individual sample predicted by GB

of features impact. Finally, NATE classifies this sample as a good credit applicant, which is the left from the middle as the base value 0.5.

On the other hand, Figure 4.15 and Figure 4.17 show the interpretation of the prediction for bad credit scoring on an individual credit applicant which is classified as 'defaulted'. 'CombinedDefaulted = 1' and 'RevolvingUtilizationOfUnsecuredLines = 0.796' are two of the most important features for the prediction in the defaulter.

Therefore, Figures 4.14, 4.15, 4.16 and 4.17 show that the models can be interpreted by Shapley values and the contribution of each feature in a certain sample can be explained locally.

With the average of Shapley values across entire samples, the model can

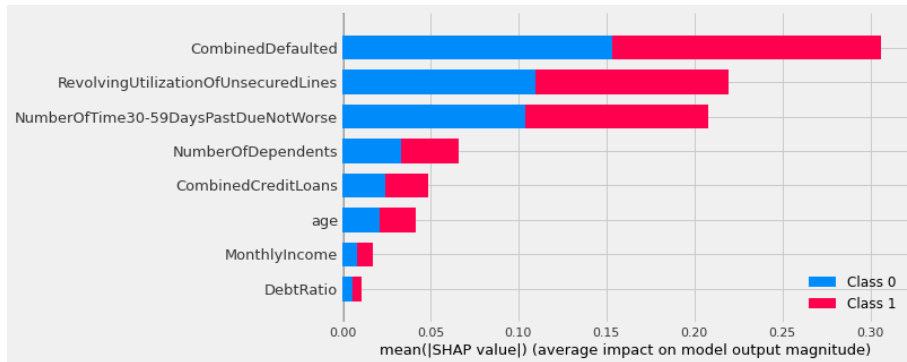

Figure 4.18: Comparison of the average of SHAP feature importance on GB

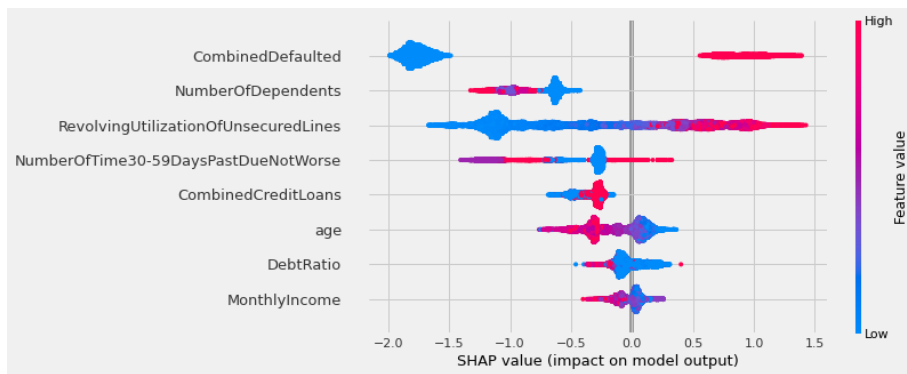

Figure 4.19: Comparison of the aggregation of SHAP values on the features

also be analysed and interpreted globally. Figure 4.18 shows the average of SHAP values for feature importance on all samples. Figure 4.19 shows the aggregation of SHAP values for all features on entire samples.

As shown in Figure 4.18, ‘CombinedDefaulted’ and ‘RevolvingUtilizationOfUnsecuredLines’ are the two most important features for the prediction of GMSC dataset in general.

Finally, NATE achieved the explainability aspect for practical application in credit scoring as XAI combined with SHAP as well as high predictive performance.

Table 4.8: Features on GMSC dataset used in NATE

Feature	Description	Type
SeriousDlqin2yrs*	Applicant experienced 90 days past due delinquency or worse	Y/N (1 or 0)
RevolvingUtilizationOfUnsecuredLines	Total balance on credit cards and personal lines of credit	percentage
age	Age of in years	integer
NumberOfTime30-59DaysPastDueNotWorse	Number of times applicant has been 30-59 days past due but no worse in the last 2 years.	integer
DebtRatio	Monthly debt payments, alimony, living costs divided by monthly gross income	percentage
MonthlyIncome	Monthly income	real
NumberOfOpenCreditLinesAndLoans	Number of Open loans (installment like car loan or mortgage) and Lines of credit	integer
NumberOfTimes90DaysLate	Number of times applicant has been 90 days or more past due.	integer
NumberRealEstateLoansOrLines	Number of mortgage and real estate loans including home equity lines of credit	integer
NumberOfTime60-89DaysPastDueNotWorse	Number of time applicant has been 60-89 days past due but no worse in the last 2 years.	integer
NumberOfDependents	Number of dependents in family excluding themselves (spouse, children etc.)	integer

\*SeriousDlqin2yrs is a feature for class label.

## 4.5 Conclusion

In this study, a non-parametric approach for explainable credit scoring as XAI was proposed on varying class distribution in GMSC dataset. The study presented the robustness of non-parametric tree-based models when compared to parametric LR as the standard model in the domain of credit scoring. The study also showed the effectiveness of resampling dataset where a large class imbalance is present. The performance measure for classification was evaluated by AUC.

The experimental results showed that the non-parametric ensemble models, especially GB and XGB outperform LR on balanced dataset as well as original large imbalanced dataset. The classification performance of tree-based ensemble models had better results when the imbalanced dataset becomes balanced, i.e., the lower the imbalance ratio, the better the performance. With regard to comparison of resampling techniques between under-sampling and oversampling, SMOTE showed better results than NearMiss on imbalanced dataset. The robustness of oversampling method was applied to all different imbalance ratio in this study.

To overcome the limitation of LR and balance the trade-off between accuracy and explainability, non-parametric tree-based model paired with ‘TreeExplainer’ was used to improve the classification performance and interpret the model both locally and globally. Any single prediction as well as the overall prediction were analysed by the contribution of features through

SHAP. Therefore, the proposed NATE as XAI allows to make an explainable credit scoring model for practical application. Therefore, the risk factors as well as high predictive power on credit applicants can be evaluated and explained by NATE.



# Chapter 5

## GAN-based Oversampling Techniques for Imbalanced Class

### 5.1 Introduction

Credit risk can be defined as the risk of loss resulting from the applicants' creditworthiness (Anderson, 2007). This would mean that credit risk could influence on non-performing financial obligation, which is highly associated with bankruptcy. As it could affect the sustainability of financial institutions, managing it by accurate credit scoring is of great importance (Munkhdalai et al., 2019).

Logistic regression (LR) has been most commonly used for credit scoring evaluation. It is regarded as the standard for credit scoring. As a parametric model, learned LR models are explained and interpreted and are built with less computational cost in terms of resource and time, and less demand for a huge training dataset. Parametric models can be expressed with the form of function that connects the target feature to input features in a relational and linear way. However, parametric models are often limited in terms of

predictive power. This has been seen as their main weakness. (Bazarbash, 2019).

On the other hand, tree-based models such as random forest (RF) and gradient boosting (GB) are non-parametric. Non-parametric models are trained on minimal functional assumptions in the learning process from the dataset (Bazarbash, 2019). This characteristic allows the models to be much more flexible and this leads tree-based models, as non-parametric models, to better predictive performance when compared to LR. While parametric models are interpretable, the predictions of non-parametric tree-based models are difficult to explain.

Today, we observe a great effort on applying the state-of-the-art machine learning (ML) technologies to credit scoring. However, there are still two main issues (Dastile et al., 2020), namely, imbalanced class in the dataset and model explainability. In the classification problem, having a balanced dataset is of great significance as it contributes to the learning process. ML models are trained on the assumption that the datasets have the same or similar number of distribution in each corresponding class (Japkowicz, 2000). In a real-life application of credit scoring, however, datasets are very often imbalanced. The models learned by imbalanced class tend to predict the most common class by maximising the accuracy of overall classification, which leading to the label misclassification in the classification problem (Drummond and Holte, 2005; Longadge and Dongre, 2013). Imbalanced class refers to the case that the ratio of observations populated by each class is not distributed evenly and is skewed to one class (Ebenuwa et al., 2019). The aim of most methods that address the problem of imbalanced class is thus to improve the classification accuracy for minority class.

To address the problem of class imbalance at data level, re-sampling methods have widely been used (Burez and Van den Poel, 2009). They balance the classes by reducing the number of majority or by increasing the number of minority. Oversampling technique such as Synthetic Minority Over-sampling TEchnique (SMOTE) is the typical method (Chawla et al.,

2002). Oversampling techniques enable to use all available information in the dataset, while undersampling techniques discard some parts of all available information (Zheng et al., 2020). One potential issue with oversampling is that it could generate overlapping data, which can be regarded as additional random noise (Engelmann and Lessmann, 2021). The model that learns from the dataset including duplicated data tends to have overfitting problem.

As an approach to overcome the limitation of conventional oversampling techniques, Generative Adversarial Networks (GAN)-based oversampling technique has recently been proposed. GAN learns the overall distribution of the minority class and oversamples the minority class similarly with real data. Its generated distribution can thus reflect latent characteristics in the original dataset. In addition, it has been reported that GAN can overcome the issue of overfitting as well as the limitation of conventional oversampling techniques such as class overlapping and additional noise.

This study, hence, extending the GAN-based oversampling technique, proposes a novel oversampling technique named NOTE (Non-parametric Oversampling Techniques for Explainable credit scoring). In addition to unsupervised generative learning, it effectively extracts latent features by non-parametric stacked autoencoder (NSA) in order to capture the complex and non-linear patterns and explains the classification as an eXplainable Artificial Intelligence (XAI) using SHAP (SHapley Additive exPlanations) as suggested by Lundberg and Lee (2017).

The key contributions of this study are as follows:

- To demonstrate the effectiveness of extracted latent features using NSA, compared with denoising method by randomised singular value decomposition (rSVD) in a non-linear credit scoring dataset
- To present the advancement of cWGAN by overcoming the problem of mode collapse in the training process of GAN and determine the suitability, stability and superiority of cWGAN generating the minority class in imbalanced dataset, compared with the benchmarks by GAN

and SMOTE

- To propose an architecture of a non-parametric model for non-linear and imbalanced dataset
- To suggest new benchmark results that outperform the state-of-art model by Engelmann and Lessmann (2021) on HE (Home Equity) dataset
- To enable the explainability aspect of the proposed model for practical application in credit scoring as XAI

We hypothesise that the proposed NOTE will not only capture the latent features of non-linearity, but also build models that are explainable for the reasons of classification.

The remainder of this paper is organised as follows: Section II discusses the related studies and identifies the gaps in the current technologies. Section III describes the proposed NOTE with its novel concepts. Section IV presents the results evaluating the performance of NOTE with the benchmarks on the recent studies. Finally, Section V concludes with the summaries of the findings from this study.

## 5.2 Related Work

This section discusses the related studies on GAN-based oversampling and synthesising tabular data with numerical and categorical features using GAN.

### 5.2.1 GAN-based Oversampling

As mentioned earlier, conventional oversampling techniques tend to copy and duplicate data, and as a result, the models turn to be overfitted by sampling techniques and have biased performance. On the other hand, GAN-based

oversampling techniques generate similar data after learning the distribution of original data. Oversampling the minority class, i.e., bad credit samples, by GAN in the domain of credit scoring, can thus balance the dataset before training the model and overcome the limitation of oversampling techniques such as SMOTE.

With this advantage, GAN has been applied to many domains such as image, videos, computer vision and so on, and has performed well in unstructured data (Ravanbakhsh et al., 2017; Schlegl et al., 2017). Recently, to address the issues of class imbalance and missing values in structured data or tabular data, extensive studies based on GAN have also emerged.

Fiore et al. (2019) proposed the fraud detection mechanism to improve the detective performance on credit card fraud by oversampling the minority class with vanilla GAN and compared its results with SMOTE. Douzas and Bacao (2018) also suggested the advanced resampling method against the variants of SMOTE to improve the classification performance by oversampling the minority class on varying imbalanced datasets with conditional GAN (cGAN), which is a variant of vanilla GAN and assigns the output generated by GAN to a specific class. However, the datasets of all these studies consisted of numerical features only, not having categorical features and, specifically, the datasets with categorical features were not considered when the data was generated by a GAN.

Seo et al. (2018) developed a meta learning methodology to prevent the overfitting due to the standard sampling techniques on imbalanced data. The study compared the performance of classification for models on imbalanced loan payment dataset by oversampling the minority class through GAN against SMOTE. The results proved that the imbalanced dataset can be analysed through GAN by improving the performance to overcome the limitation of overfitting by SMOTE. Xu and Veeramachaneni (2018) proposed tabular GAN (tGAN) to synthesise tabular data while generating discrete and continuous data simultaneously, and showed that tGAN outperformed the conventional generative models. Son et al. (2020) applied the oversampling

method using borderline-cGAN (bcGAN) to the borderline cases between the majority class and the minority class in order to avoid overlapping class and also presented the comparative results between bcGAN and conventional oversampling techniques such as SMOTE.

However, the above mentioned research only dealt with numerical dataset without categorical features. Therefore, the studies are limited in the performance of generating categorical features using GAN-based oversampling since credit scoring datasets normally consist of both numerical and categorical features.

In the domain of credit scoring, Engelmann and Lessmann (2021) recently suggested an oversampling method using conditional Wasserstein GAN (cWGAN) to generate synthetic data for both numerical and categorical features. The paper compared the results against the standard oversampling techniques with generally used algorithms. The paper also proved that cWGAN successfully generated categorical features as well as numerical features to overcome the imbalanced problem for the minority class and improved the classification performance on both linear and non-linear credit scoring datasets.

### **5.2.2 Generating Tabular Data by GAN**

Since tabular datasets for credit scoring are generally composed of different types of data with both numerical and categorical features as well as the numerical values can have complex distributions like multi-modal or thick-tailed distribution, it could be hard to generate both numerical and categorical data simultaneously using GAN (Xu and Veeramachaneni, 2018). Specifically, for numerical data, there are some cases where it should be a certain range and positive with the characteristics of feature, e.g., age should be from 1 and almost less than 100 and integer. For categorical data, it could be nominal or ordinal or both.

As such, many studies have been proposed to generate synthetic tabu-

lar data with both numerical and categorical features using the variants of GAN, focusing on how to deal with generating the diverse types and characteristics of data simultaneously, and overcome the limitation of original GAN due to mode collapse in modelling categorical values and complex numerical distribution such as a multi-modal dataset (Srivastava et al., 2017).

Choi et al. (2017) proposed Medical GAN (MedGAN) to generate categorical synthetic data for binary columns of diagnosis on patients' records in the domain of health. This study overcame the limitation of privacy risk by using a combination of autoencoder and GAN. Xu et al. (2019) designed conditional tabular GAN (ctGAN) to model multi-categorical columns with the architecture of one-hot encodings, softmax activation function and Wasserstein distance for loss updating previous tGAN (Xu and Veeramachaneni, 2018) and showed the improvement of generative performance in categorical features when compared to their previous tGAN.

Therefore, these studies showed that modelling tabular synthetic data simultaneously for complex numerical distribution and multi categorical data depends on GAN architecture. As a result, the architecture has been improved by updating the changes of structure and loss function. The advancement of GAN will be applied to oversample the minority class and balance credit scoring dataset in this paper.

### **5.3 NOTE: Non-parametric Oversampling Techniques for Explainable credit scoring**

The NOTE consists of four stages, which are as follows:

1. Collecting HE dataset
2. Extracting latent representation by NSA and merging with original dataset
3. Oversampling the minority class (defaulted credit samples) by cWGAN

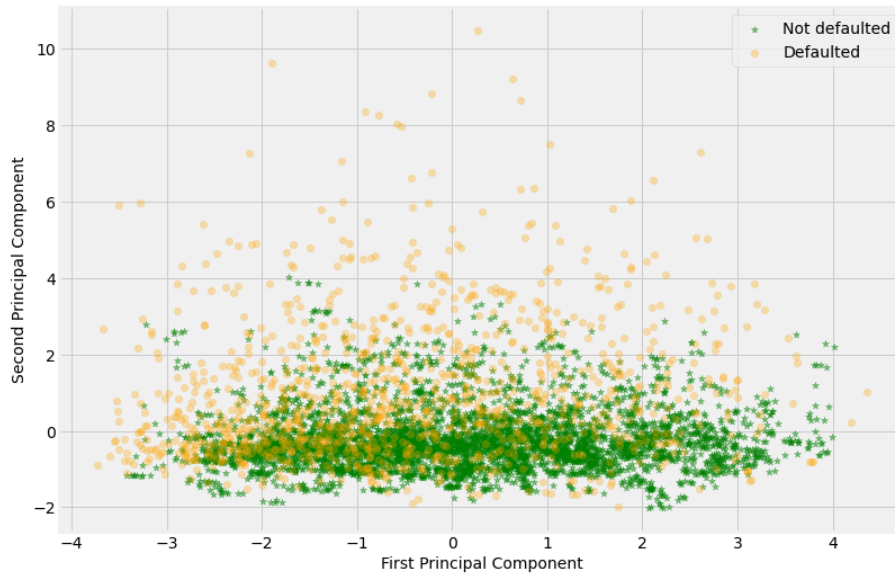

Figure 5.1: The imbalanced class on HE dataset

4. Predicting the classification and explaining the model by ‘TreeExplainer’ and ‘LinearExplainer’

These stages need to process sequentially in order to obtain the necessary levels of effectiveness.

HE (Home Equity) dataset (Baesens et al., 2016) shows the characteristics and delinquency information for the samples of mortgage applicants and comes from a previous paper of credit scoring literature. It consists of 5,960 samples with 4,771 not-defaulted credit samples and 1,189 defaulted credit samples, respectively. Bad credit samples are defined as the cases that target feature named ‘BAD’ is specified as 1, which means the applicant has defaulted on the loan. On the other hand, good credit samples are classified as the cases that the label is specified as 0, which means the applicant has paid a financial obligation. This is a binary class label. The dataset was used due to its non-linearity in the results by Engelmann and Lessmann (2021) for validating the robustness of NOTE.

The initial dataset shows the class imbalance in such manner that the



size of the majority class is larger than the minority class with the imbalance ratio (IR) as 4.012. IR is the number of the majority class divided by the number of the minority class. The dataset contains 12 features excluding target feature. Figure 5.1 shows the distribution of imbalanced class on the dataset using principal component analysis (PCA) with two principal components (Jolliffe, 1986).

Through extracting latent representation, the non-linear information is acquired from the dataset. To overcome the limitation of principle component analysis (PCA), which is able to capture only linear characteristics in the dataset for feature extraction, autoencoder can be suggested and applied for extracting non-linear patterns in the dataset if the dataset is strongly non-linear and complex.

Neural network (NN) is employed to use non-linear transformation and produce latent characteristics for learning representation of data (Bengio et al., 2013). This process can be performed with non-parametric stacked autoencoder (NSA), which is an unsupervised learning method consisting of encoder (encoding input data to make the latent representation or codings), and decoder (decoding the latent representation or codings to reconstruct the input) (Hinton and Salakhutdinov, 2006). Figure 5.2 shows the structure of NSA. NSA is trained to minimise the loss, i.e. minimising the reconstruction error. The loss function  $L$  can be expressed as follows:

$$L(x, x') = \frac{1}{n} \sum_{x_k \in D_{train}} \|x - x'\|^2 \quad (5.1)$$

where  $D_{train} = \{(x_k)\}_{k=1}^n$  is a training set.

Therefore, codings can be regarded as the result of extraction from representation learning and the latent vectors from NSA are concatenated into the original dataset after the process of representation learning.

Furthermore, Engelmann and Lessmann (2021) proved that oversampling technique by cWGAN in non-linear dataset showed the best classi-

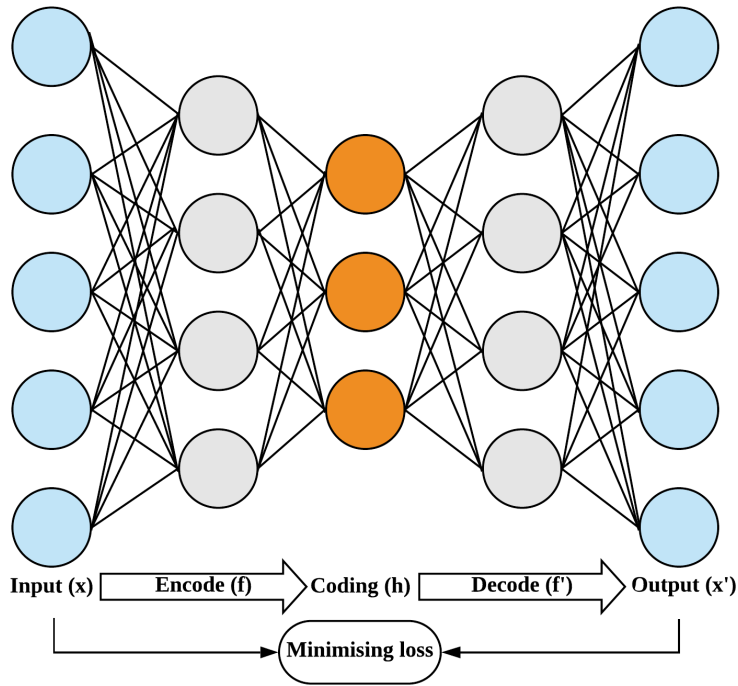

Figure 5.2: The non-parametric stacked autoencoder (NSA), where codings are latent features of original dataset

fication performance when paired with tree-based models like RF and GB. Therefore, the results imply that a promising performance would be expected if oversampling by cWGAN combined with NSA is applied to a strongly non-linear dataset and then the dataset with latent vectors is paired with tree-based ML algorithms, such as extra trees (ET), RF and GB.

Following feature generation by NSA, NOTE performs cWGAN-based oversampling to balance each class on the imbalanced dataset. Since the imbalanced dataset could cause a bias during the training of the model as discussed, the minority class of the dataset is oversampled to the same number with the majority class before the phase of model training.

Generative adversarial networks (GANs) (Goodfellow et al., 2014) is an architecture for learning generative models with an adversarial process and consists of two models. One model is the generator  $G$ , which generates

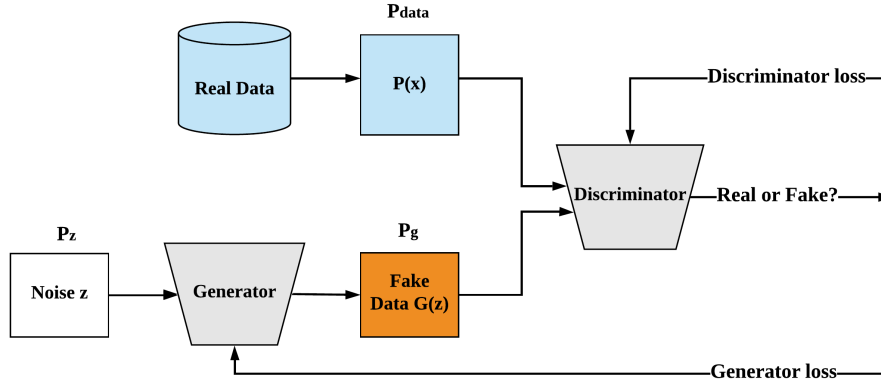

Figure 5.3: The structure of GAN-based generation for synthetic data

artificial samples trying to follow similar distribution with real data, and the other model is the discriminator  $D$ , which tries to distinguish real data from artificial or synthetic samples generated by  $G$  (Engelmann and Lessmann, 2021).

$G$  takes latent vector or noise  $z$  from noise distribution  $P_z$  as input and maps the noise  $z$  into data space  $\mathcal{X}$  for generating synthetic data. As discussed, two models  $G$  and  $D$  are trained together, where  $G$  is trained to generate synthetic or fake samples similar with real data in order to deceive  $D$ , while  $D$  is trained to discern real samples from generated or fake samples. This process is called as two-player minmax game and can be expressed with loss function as follows:

$$\min_G \max_D V(G, D) = E_{x \sim P_{data}(x)} [\log D(x)] + E_{z \sim P_z(z)} [\log(1 - D(G(z)))] \quad (5.2)$$

where  $P_{data}$  is the distribution of real data,  $P_z$  is the distribution of latent vector,  $P_g$  is the distribution of generated data and  $D(x)$  is the probability of  $x$  following real distribution  $P_{data}$ , not generated distribution  $P_g$ .

Figure 5.3 shows the structure of GAN-based generation. The objective of generator  $G$  can be achieved if generated distribution  $P_g$  is equal to the real distribution  $P_{data}$  as shown by Goodfellow et al. (2014), which is equivalent

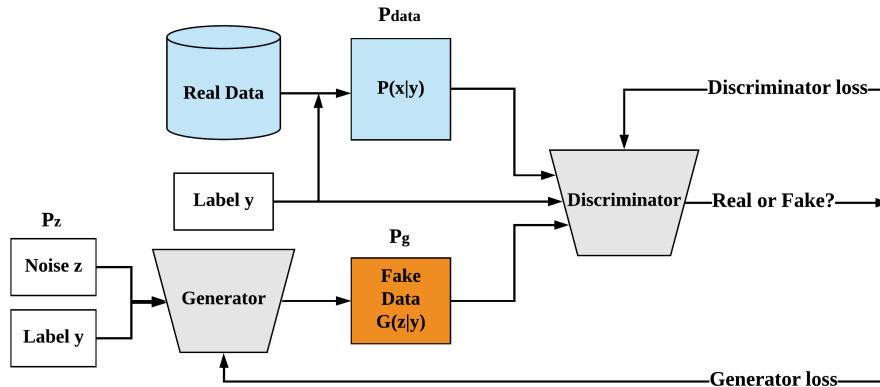

Figure 5.4: The structure of cGAN-based generation for synthetic data

with minimising the Jensen-Shannon Divergence (JSD) as the measure of how approximate two distributions are (Engelmann and Lessmann, 2021).

Since it is not possible to assign restriction or condition to synthetic samples when generating data with vanilla GAN, conditional GAN (cGAN) (Mirza and Osindero, 2014) as a variant of vanilla GAN was suggested to overcome the limitation of vanilla GAN.

Even though cGAN has a similar learning process to GAN, there is difference in the input variable of generator  $G$  (Mirza and Osindero, 2014). Generator  $G$  in cGAN takes restriction or condition  $y$  as well as noise  $z$  for inputs and maps both into data space  $\mathcal{X}$  for generating new data. Then, two models  $G$  and  $D$  are trained together in the same way as GAN. Figure 5.4 shows the structure of cGAN-based generation.

Condition  $y$  can be regarded as additional information that  $G$  and  $D$  consider as the label, when generating and discriminating fake data. This enables the generated output of sample to belong to a specific class, while enabling  $G$  to consider the class label. In other words, imposing the condition can make the training process more stable (Engelmann and Lessmann, 2021). cGAN can be expressed with loss function as follows:

$$\min_G \max_D V(G, D) = E_{x \sim P_{data}(x)} [\log D(x|y)] + E_{z \sim P_z(z)} [\log(1 - D(G(z|y)))] \quad (5.3)$$

In the area of ML, one of most important procedures can be the process of learning probability distribution. Therefore, learning the joint probability distribution of data is an essential process to make a generative model, which is equivalent that Maximum Likelihood Estimation (MLE) corresponds to minimising the Kullback-Leibler Divergence (KLD).

This can be expressed as follows:

$$\operatorname{argmax} \sum_{i=1}^n \log P_{\theta}(x_i) = \int_x P_r(x) \log P_{\theta}(x) dx = \operatorname{argmin}_{\theta} KL(P_r || P_{\theta}) \quad (5.4)$$

KLD is a measure of how one probability distribution is approximate with or different from an ideal reference distribution (Kullback and Leibler, 1951). KLD can be expressed by JSD, where JSD is also a measure of how similar two distributions are (Lin, 1991). Both KLD and JSD as mathematical approaches have been used to minimise the difference between two distributions.

According to KLD and JSD, ideal reference distribution and approximate distribution should have the same support if two distributions are approximate, where the set that probability variable  $P(\cdot)$  takes is called as support and can be expressed as the set  $\{x | P(x) > 0\}$ .

However, supports of two distributions in real data space are not the same since meaningful information is normally dense in a small part of data space when compared to the data space  $\mathcal{X}$ . Therefore, it is difficult for the loss function of GAN to calculate the distance between generated distribution  $P_g$  and real distribution  $P_{data}$ , and this causes a problem such as mode collapse and unstable learning in the training process of both GAN and cGAN (Mirza and Osindero, 2014).

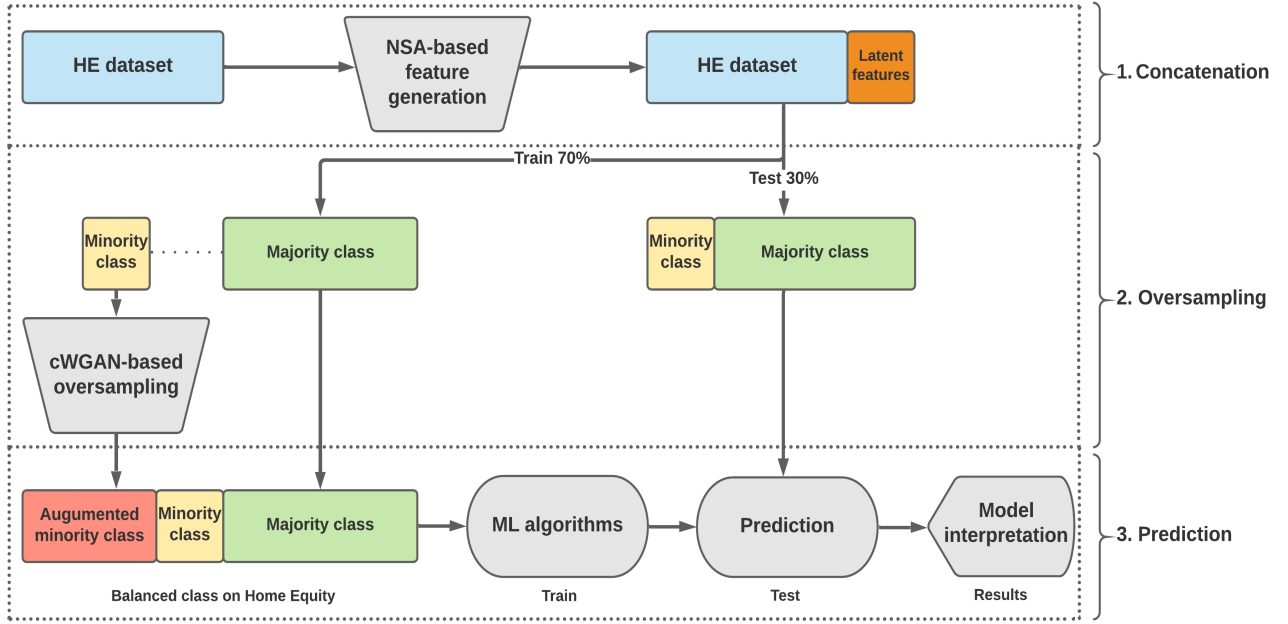

Figure 5.5: The system architecture of NOTE

To address the challenges of the training process of GAN and cGAN, Wasserstein distance instead of JSD was suggested to calculate the distance between two distributions and has been used by replacing the loss function of vanilla GAN and conditional GAN (cGAN), which are called as Wasserstein GAN (WGAN) and conditional Wasserstein GAN (cWGAN), respectively (Arjovsky et al., 2017).

Wasserstein distance can be analysed as the cost of the optimum transport plan to move the mass of probability mass function (Engelmann and Lessmann, 2021), and WGAN and cWGAN are trained to minimise the cost of loss function. The cost can be expressed as follows:

$$Cost = mass \times distance = \sum_{x \in X} \sum_{y \in Y} \gamma(x, y) \cdot \|x - y\|^p = E_{\gamma(x, y)}(\|x - y\|^p) \quad (5.5)$$

where  $x$  is one of bin in support of distribution  $P_r$ ,  $y$  is one of bin in

support of distribution  $P_\theta$ ,  $\gamma(x, y)$  is the distance between  $x$  and  $y$ , i.e. mass, and for any  $p \geq 1$ ,  $\|\cdot\|$  is Euclidean norm on  $\mathbb{R}^n$ .

To summarise the architecture of NOTE as the proposed model, Stacked AutoEncoder (SAE) which is one of the unsupervised generative models in deep neural networks, is applied to extract the latent information on non-linear credit scoring dataset before the process of oversampling approaches. After the process of the feature extraction, Conditional Wasserstein Generative Adversarial Network (cWGAN) which is also one of the unsupervised generative models in deep neural networks, is applied to oversample the minority class for dealing with imbalance issue in the class distribution. These two generative unsupervised deep learning models can finally improve the classification accuracy in the NOTE as the proposed credit scoring model.

Following oversampling the minority class by cWGAN, NOTE performs the prediction with ML models and the explanation with ‘TreeExplainer’ and ‘LinearExplainer’. Figure 5.5 shows the system architecture of NOTE. Five ML classifiers including tree-based models for performance comparison are as follows:

Logistic regression (LR) has been a commonly used model for binary classification (Cox, 1958). Decision tree (DT) splits the dataset recursively based on information for the classification (Quinlan, 1986). Extra trees (ET) is an ensemble method aggregating the results of multiple decision tree classifiers from forest (Geurts et al., 2006). Random forest (RF) is also an ensemble method aggregated with multiple decision tree classifiers (Breiman, 2001). ET and RF are similar conceptually; however, they are different from the manner of building decision trees in forest. Gradient boosting (GB) is a boosting method to combine weak classifiers into one strong model and enhance the classification performance (Friedman, 2001). DT as base learner is used in the experiment of GB in this study.

Tree-based ML ensemble classifiers such as ET, RF and GB have been the most popular non-linear predictive models in use (Hastie et al., 2009; Lundberg et al., 2020). These models are applied to the areas that make

predictions based on a set of input attributes and the predictions need to be both accurate for results and explainable for reasons. In other words, accuracy and explainability need to be balanced in the models, e.g., the fields of medicine and finance (Murdoch et al., 2019). Explainability means that the ways ML classifiers utilise input features for making predictions can be understood (Lundberg et al., 2020).

Since LR uses logistic function, its coefficient can be easily interpretable. However, complex interaction between variables is ignored as it uses linear decision boundary. On the other hand, tree-based algorithms such as RF and GB can be trained in complex and non-linear decision boundary. This means that tree-based models are hard to understand the prediction (Engelmann and Lessmann, 2021).

Although DT can be interpreted by decision path, the construction of multiple trees in the decision path for tree-based ensemble models makes the prediction less interpretable.

Recently, a number of research have emerged and been studied in the field of explainable AI (XAI). One of the studies by Lundberg et al. (2020) is about the approach to make tree-based models explainable for decisions using input contribution. A related study by Lundberg and Lee (2017) prior to Lundberg et al. (2020) suggested ‘TreeExplainer’ with SHAP (SHapley Additive exPlanations), which is a united approach based on Shapley values of game theory (Shapley, 1953).

SHAP allows to analyse and explain the prediction of ML models by estimating the contribution of each feature and help us understand them with respect to both how much each feature contributes for target feature globally and how a certain sample is predicted by SHAP values of features in the certain sample locally. SHAP can be represented by an additive form of feature attribution with Shapley values as follows:

$$g(z') = \phi_0 + \sum_{i=1}^M \phi_i z'_i \quad (5.6)$$



Table 5.1: Oversampled minority class on HE dataset by NOTE

Class	# Original	# Generated	Total
# Not defaulted (0)	4,771	0	4,771
# Defaulted (1)	1,189	3,582	4,771
<b>Total</b>	5,960	3,582	9,542



Figure 5.6: t-SNE through PCA on original imbalanced dataset (left) and generated balanced dataset (right)

where  $g$  is the model for explanation, i.e., the approximation of the prediction,  $z' \in \{0, 1\}^M$  is the coalitional vector (or defined as ‘simplified features’ in the study of Lundberg and Lee (2017)), describing 1 as ‘present’ and 0 as ‘absent’,  $M$  is the maximum of coalitional size, i.e., the number of the employed input features, and  $\phi_i \in \mathbb{R}$  is the attribution for feature  $i$ .

In addition to ‘TreeExplainer’, Lundberg and Lee (2017) also proposed ‘LinearExplainer’ to help us analyse the prediction by LR globally and locally using the same ways, although its coefficient can be easily interpretable as discussed above.

On the other hand, the measure of feature importance in tree-based ensemble models is able to compute the importance of each input and explain the reasons for prediction. However, it is limited since feature importance shows only the importance across entire samples, not on each case for the prediction.

Table 5.2: Comparison between original and generated distribution on two categorical features of the minority class. Proportion in brackets

Feature	Category	# Original (%)	# Generated (%)
REASON*	0	793 (66.7%)	2485 (69.4%)
	1	396 (33.3%)	1097 (30.6%)
	<b>Total</b>	1,189	3,582
Feature	Category	# Original (%)	# Generated (%)
JOB**	0	179 (15.1%)	523 (14.6%)
	1	125 (10.5%)	334 (9.3%)
	2	577 (48.5%)	1830 (51.1%)
	3	212 (17.8%)	725 (20.2%)
	4	38 (3.2%)	110 (3.1%)
	5	58 (4.9%)	60 (1.7%)
<b>Total</b>		1,189	3,582

\*REASON: two categories \*\*JOB: six categories

Furthermore, tree-based ensemble models are more appropriate to capture non-linearity in the dataset. According to the results by experiments on medical datasets (Lundberg et al., 2020), the greater the degree of non-linearity in the dataset, the greater the explanation error and accuracy error while tree-based GB shows the stability. This means that explainability as well as accuracy drops as non-linearity in the dataset increases, since other irrelevant features are used by the model and the relation between target feature and training features becomes less explainable (Lundberg et al., 2020). This implies that tree-based models are preferable to linear models if the accuracy is the same by each case.

Although deep neural networks (DNN) are more accurate and appropriate in the area of image and speech recognition and natural language process, DNN is a black box model, which means that it is incomprehensible for the reasons of prediction.

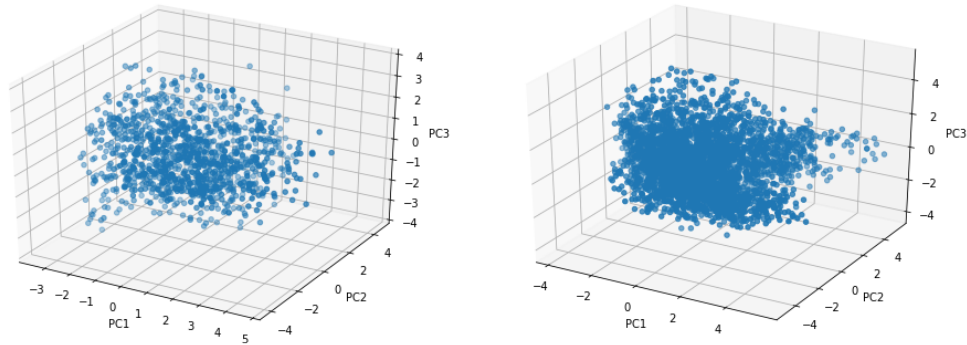

Figure 5.7: PCA of minority class with 1,189 original samples (left) and 3,582 generated samples (right)

These robustness of tree-based models has also been proved by the results of Engelmann and Lessmann (2021) when tree-based models are paired with cWGAN on non-linear credit scoring dataset. Therefore, it is expected that the proposed tree-based NOTE can output the stable explainability and performance with extracting non-linearity by NSA.

## 5.4 Results

This section evaluates the generative and predictive performance of NOTE.

### 5.4.1 The Generative Performance

Before the classification performance through oversampling is compared between none, NOTE, GAN, SMOTE and cWGAN as the benchmark of Engelmann and Lessmann (2021), the distribution of synthetic data needs to be evaluated for generative performance of NOTE on HE dataset. Table 5.1 shows the comparison for the number of each class on original imbalanced and balanced dataset after oversampling the minority class. In order to analyse the characteristics of original imbalanced and generated balanced dataset, t-distributed Stochastic Neighbour Embedding (t-SNE) (Van der

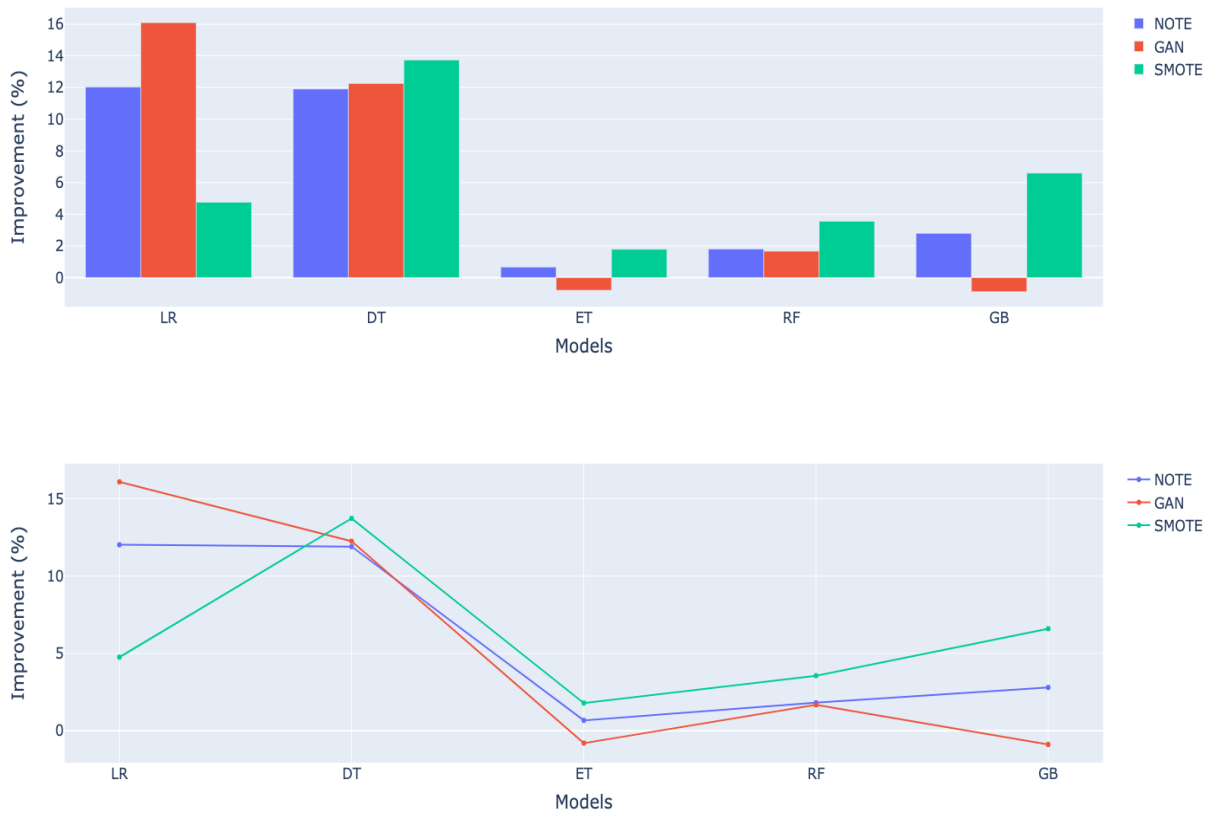

Figure 5.8: AUC improvement of classification models by oversampling methods against non-resampling

Maaten and Hinton, 2008) is applied to visualise each class in the dataset after being processed by PCA (Jolliffe, 1986). As can be seen in the left of Figure 5.6, the original imbalanced dataset is not linearly separable. After generating the minority class successfully by NOTE, two separable classes have distinguishable characteristics as shown in the right of Figure 5.6. This means that NOTE is effective to generate the minority class for reducing the issue of imbalanced class.

As shown in Table 5.2, for categorical features, the distributions of variables are managed to be approximated. NOTE successfully generated the

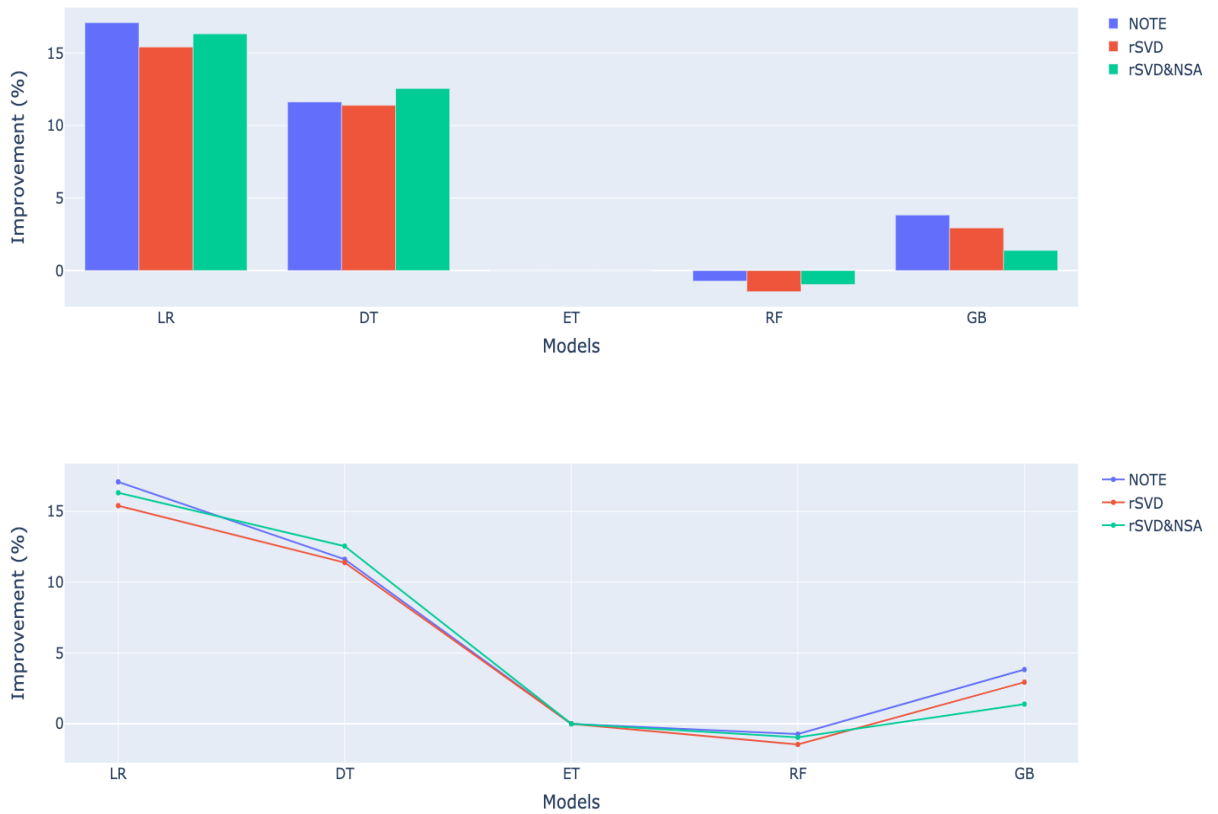

Figure 5.9: AUC improvement of classification models by extracting and denoising methods against benchmarks (Engelmann and Lessmann, 2021), AUC of ET: N/A

samples of minority class with maintaining the trend of original distribution, when the categories are both binary and multiple.

Figure 5.7 shows the analysis for distributions of original and generated minority class by NOTE after the learning process. The PCA was used for the visualisation to verify whether NOTE learns the characteristics of original data distribution. The distributions based on the first, second and third principal components are visualised. As shown in Figure 5.7, the distribution of generated minority class is similar to the distribution of original minority

class. Therefore, it can be analysed that NOTE successfully captured the characteristics of the original data.

After cWGAN learns the distribution of real data, 3,582 bad credit samples are generated by cWGAN to balance the class label, since the original dataset has 1,189 bad credit samples of minority class. These synthetic samples have similar distribution with the real dataset as discussed earlier and are merged into the minority class in the original dataset. Therefore, the number of bad credit samples is oversampled into 4,771 as the same with the number of good credit samples, as described in Table 5.1.

Therefore, the advancement of cWGAN was presented by overcoming the problem of mode collapse in the training process of GAN and by determining the suitability, stability and superiority of cWGAN generating the minority class on imbalanced credit scoring dataset.

### **5.4.2 The Predictive Performance**

To compare the proposed model NOTE against benchmarks as SMOTE for oversampling and rSVD for extraction, tree-based models such as DT, ET, RF and GB as well as LR for standard model in the domain of credit scoring are applied to perform the classification. These five classifiers are also trained with imbalanced original dataset to validate the efficacy of oversampling minority class and capturing latent features for non-linearity.

Since Engelmann and Lessmann (2021) also suggested hyperparameter tuning for future work in the paper and implied the performance improvement, the robustness of NOTE is validated with hyperparameter tuning. Hyperparameters of classifiers are optimised by random search with 3-fold cross validation over searching space in order to have optimal performance.

Tree-based models with non-pruning tend to be overfitted in the dataset and SMOTE also makes classifiers overfitted around local information as discussed earlier. This is a limitation of previous research since the results in the benchmarks of Engelmann and Lessmann (2021) were obtained without

hyperparameter optimisation. All tree-based models in NOTE were pruned to avoid overfitting in this paper.

Table 5.3: AUC comparison after hyperparameter optimisation\* between none and oversampling methods (NOTE GAN SMOTE) combined with extracting three latent representation on HE dataset. Benchmarks (Engelmann and Lessmann, 2021) in brackets

	<b>None</b>	<b>NOTE</b>	<b>GAN</b>	<b>SMOTE</b>
LR	0.8060 (0.7738)	0.9263 (0.7554)	0.9670 (N/A)	0.8536 (0.7723)
DT	0.7906 (0.7867)	0.9097 (0.7935)	0.9132 (N/A)	0.9280 (0.8047)
ET	0.9675 (N/A)	0.9742 (N/A)	0.9595 (N/A)	0.9854 (N/A)
RF	0.9507 (0.9733)	0.9688 (0.9761)	0.9674 (N/A)	0.9863 (0.9738)
GB	0.9222 (0.9213)	0.9502 (0.9119)	0.9133 (N/A)	0.9882 (0.9048)

\*Searching space for hyperparameters LR: penalty={‘none’, ‘L1’, ‘L2’, ‘elasticnet’}, inverse penalty coefficient C=loguniform(1e-5, 100), solver={‘newton-cg’, ‘lbfgs’, ‘liblinear’}; DT: max\_features={‘auto’, ‘sqrt’}, max\_depth=[1, 20], min\_samples\_split={1, 2, 5, 10}, min\_samples\_leaf ={1, 2, 4, 8}; ET: n\_estimators=[100, 1000], max\_features={‘auto’, ‘sqrt’}, max\_depth=[1, 20], min\_samples\_split={1, 2, 5, 10}, min\_samples\_leaf={1, 2, 4, 8}, bootstrap={‘True’, ‘False’}; RF: n\_estimators=[100, 1000], max\_features={‘auto’, ‘sqrt’}, max\_depth=[1, 20], min\_samples\_split={1, 2, 5, 10}, min\_samples\_leaf={1, 2, 4, 8}, bootstrap={‘True’, ‘False’}; GB: n\_estimators=[100, 1000], learning\_rate={‘0.01’, ‘0.1’, ‘0.5’}, max\_depth=[1, 20], Base learner=decision Tree, N/A = No results available in benchmarks (Engelmann and Lessmann, 2021)

As the accuracy of classification performance in imbalanced dataset also tends to be biased towards the majority class as discussed earlier, the measure of performance is the area under the curve (AUC), which is the standard metric for evaluating classification for imbalanced dataset (Haixiang et al.,

Table 5.4: AUC comparison after hyperparameter optimisation\* between NOTE and cWGAN with rSVD on HE dataset. Benchmarks (Engelmann and Lessmann, 2021) for cWGAN oversampling without extraction

	NOTE	rSVD	rSVD and NSA	Engelmann and Lessmann (2021)
LR	0.9263	0.9095	0.9186	0.7554
DT	0.9097	0.9074	0.9190	0.7935
ET	0.9742	0.9656	0.9741	N/A
RF	0.9688	0.9615	0.9665	0.9761
GB	0.9502	0.9413	0.9258	0.9119

\*Searching space for hyperparameters is the same with the above.

2017; Huang and Ling, 2005).

The baseline performance with original imbalanced dataset is compared to validate whether GAN-based oversampling techniques improve the performance against none or SMOTE, which is a common oversampling method as discussed earlier. With this benchmark and the results from the literature (Engelmann and Lessmann, 2021), the proposed NOTE is also compared to evaluate the effectiveness for extracting latent characteristics in non-linear dataset.

Table 5.3 and Figure 5.8 show AUC comparison of classification performance between none and oversampling methods. With respect to the efficacy of oversampling techniques, all oversampling techniques improved the performance against none-oversampling as shown in Table 5.3 and Figure 5.8 except ET paired with GAN and GB paired with GAN. Specifically, NOTE paired with ensemble tree-based models such as ET, RF and GB had better results than GAN, and NOTE paired with LR, DT, GB and SMOTE combined with LR, DT, RF and GB outperformed the benchmarks (Engelmann and Lessmann, 2021) and SMOTE paired with GB had the best result in the case.

The robustness of extracting latent vectors by NSA is evaluated by comparison with reducing the noise by rSVD. Singular value decomposition



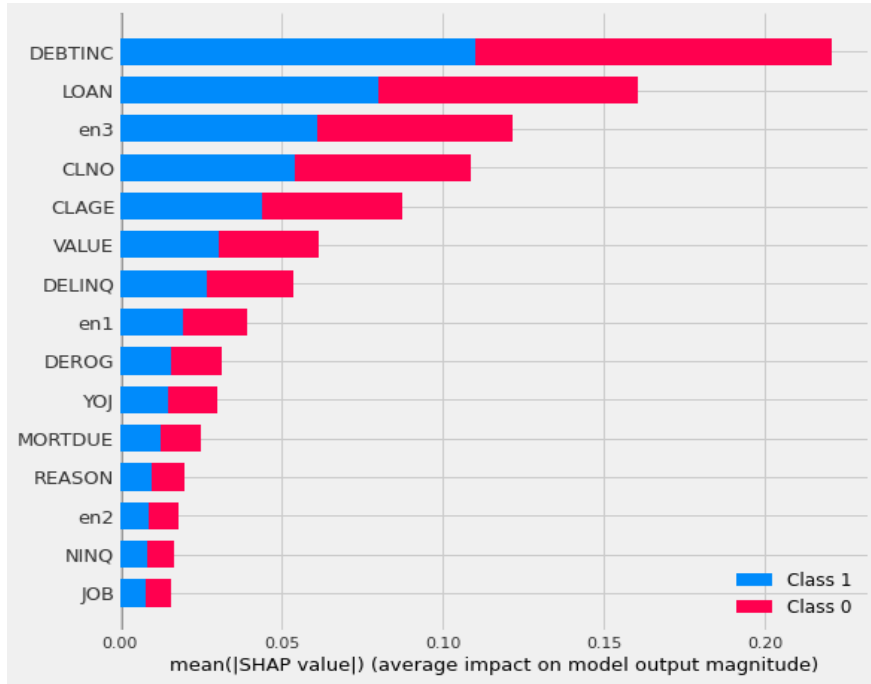

Figure 5.10: Comparison of SHAP feature importance on RF of NOTE, where en1, en2 and en3 are latent representation extracting from NSA

(SVD) for matrix decomposition has been commonly used for reducing dimensionality, analysing and compressing data (Erichson et al., 2019b).

Although SVD is computationally expensive, rSVD with the concept of randomness has been introduced to reduce the computational cost and allow the scalable transformation of matrix and capture the latent information in the dataset (Erichson et al., 2019a). Since Engelmann and Lessmann (2021) indicated the non-linearity for HE dataset in the paper, the rSVD method can also be applied for the reconstruction of data. The proposed NOTE is compared with cWGAN-based oversampling techniques through rSVD to check which methods are more effective to enhance the performance of cWGAN for generating plausible synthetic distribution, and the performance of classifiers for predicting classification.

Table 5.4 and Figure 5.9 show AUC comparison with five classifiers and three cases for capturing the latent features by NOTE, cWGAN combined

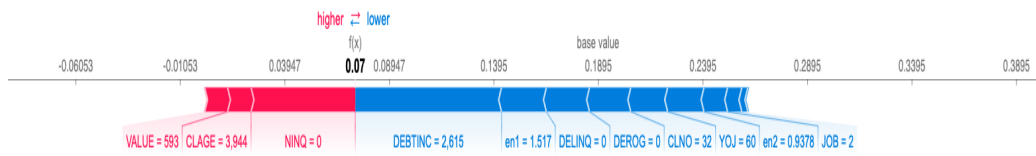

Figure 5.11: SHAP value plot for individual sample predicted by RF of NOTE

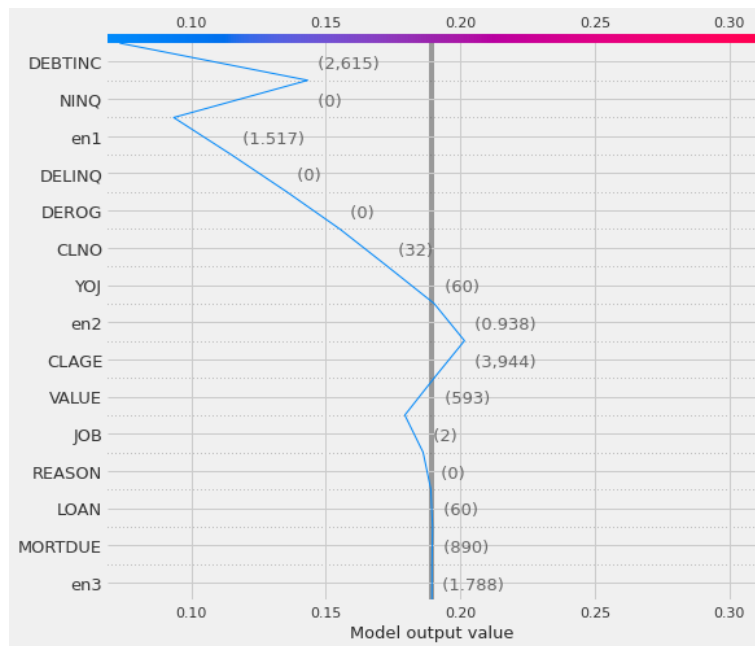

Figure 5.12: SHAP decision plot for individual sample predicted by RF of NOTE

with rSVD and cWGAN combined with both rSVD and NSA against cWGAN only on the dataset. When compared to the benchmarks by Engelmann and Lessmann (2021), AUCs were improved for all models except RF. These results also proved that the latent information could be acquired and be reflected or some noise could be reduced through the reconstruction methods if NSA or rSVD is conducted prior to the process of cWGAN oversampling.

It can be analysed that both NOTE and cWGAN paired with LR, DT and GB through rSVD have better AUCs than cWGAN only without the process of denoising or reconstruction as shown in Table 5.4 and Figure 5.9.

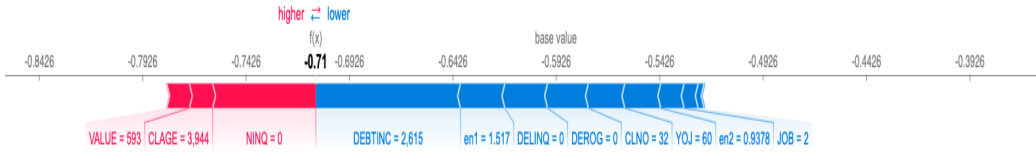

Figure 5.13: SHAP value plot for individual sample predicted by LR of NOTE

Table 5.5: Features on HE dataset used in NOTE

Feature	Description	Type
BAD*	Applicant paid loan, or applicant defaulted on loan or seriously delinquent	N (Not defaulted = 0) / Y (Defaulted = 1)
LOAN	Amount of the loan request	integer
MORTDUE	Amount due on existing mortgage	integer
VALUE	Value of current property	integer
REASON	DebtCon = debt consolidation; HomeImp = home improvement	category
JOB	Six occupational categories (Other, ProfExe, Office, Sales, Mgr, Self)	category
YOJ	Years at present job	integer
DEROG	Number of major derogatory reports	integer
DELINQ	Number of delinquent credit lines	integer
CLAGE	Age of oldest credit line in months	real
NINQ	Number of recent credit inquiries	integer
CLNO	Number of credit lines	integer
DEBTINC	Debt-to-income ratio	real

\*BAD is a feature for class label.

Especially, the AUC 0.9656 of cWGAN paired with ET through rSVD on the dataset as shown in Table 5.4, has a difference (0.86) with the result of AUC 0.9742, which was obtained by NOTE. This implies that the denoising process on non-linear dataset can also enhance the performance of classification as similar to the process of extracting information.

Furthermore, the fact that AUCs were improved for all models except RF as shown in Table 5.4 and Figure 5.9 shows that the proposed NOTE successfully extracted latent vectors from the original non-linear dataset and hence, AUCs were improved for LR, DT and GB as Engelmann and Lessmann (2021) proved that HE dataset is strongly non-linear. Therefore, the effectiveness of extracted latent features was demonstrated by using NSA and by comparing NSA with denoising method by rSVD on non-linear credit scoring dataset.

As a result, it was validated as an effective approach for improving classification performance to use the proposed NOTE paired with tree-based

ensemble classifiers if extracting latent vectors by NSA or reducing noise by rSVD is applied to non-linear and imbalanced dataset as Engelmann and Lessmann (2021) advised tree-based models in the paper, and their benchmark performance by Engelmann and Lessmann (2021) was improved further by NSA or rSVD to extract latent vectors. This means that NOTE successfully proposed a novel architecture of a non-parametric model for non-linear and imbalanced dataset.

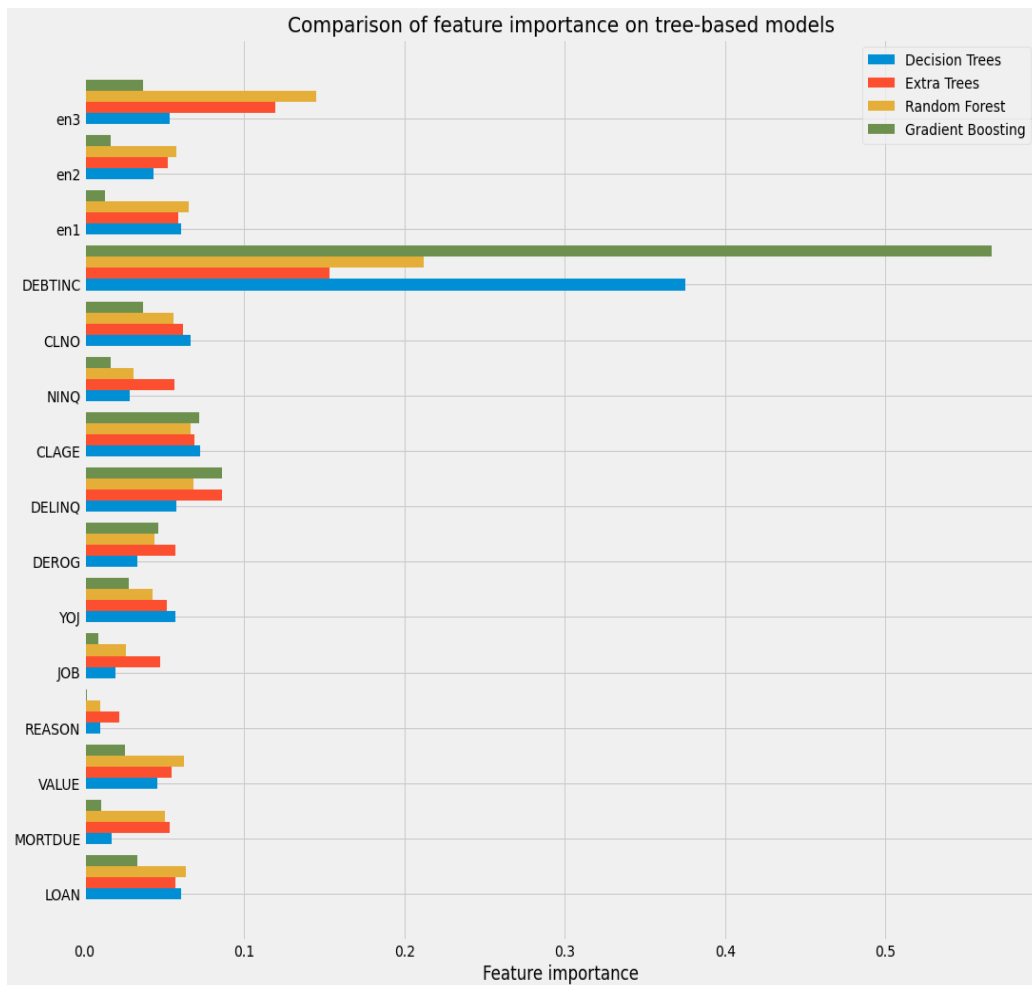

Figure 5.14: Comparison of feature importance on tree-based models of NOTE, where en1, en2 and en3 are latent representation extracting from NSA

Figures 5.10, 5.11, 5.12 and 5.13 explain the prediction by NOTE. Figure 5.10 shows the global interpretability of the prediction as the average of SHAP values for feature importance on all samples. Figure 5.11 shows local interpretability of a certain sample for RF of NOTE as an example. In addition, Figure 5.12 shows the decision path of the same sample starting from the bottom for the prediction similar to DT, and Figure 5.13 shows local interpretability of the same sample for LR of NOTE. The interpretability is analysed by SHAP which measures the contribution of features to the prediction for credit scoring. As shown in Figure 5.10, ‘DEBTINC’, ‘LOAN’ and ‘en3’ are the three most important features for the prediction on HE dataset in general. Especially, the fact ‘en3’ is one of the top three features indicates that NSA captured non-linearity successfully on HE dataset.

As discussed earlier, these figures can be described with ‘TreeExplainer’ on all tree-based models and ‘LinearExplainer’ on LR. These explainers allow to understand the models and analyse the reasons for explainability as XAI since the explainability is regarded as the key factor for both financial institutions and credit applicants. Therefore, the proposed NOTE enabled the interpretability for credit scoring.

On the other hand, Figure 5.14 shows the comparison of traditional feature importance between the proposed tree-based models such as DT, ET, RF and GB on NOTE across the entire samples.

Finally, NOTE achieved the explainability aspect for practical application in credit scoring as XAI combined with SHAP as well as high predictive performance.

## 5.5 Conclusion

In this paper, a novel oversampling technique named NOTE was proposed for the problem of imbalanced class in non-linear credit scoring dataset. The evaluation was performed with three oversampling techniques, two extraction

methods and five different classification algorithms against the benchmarks.

The results showed that NOTE generated the minority class successfully with the combination of advantages of NSA, cGAN and WGAN. The classification performance, hence, was significantly improved by the proposed NOTE against the standard model as LR on non-linear imbalanced credit scoring dataset and previous research about cWGAN-based oversampling for class imbalance. Furthermore, since NOTE is explainable by ‘TreeExplainer’ and ‘LinearExplainer’ both locally and globally for the prediction as well as stable for non-linear dataset, this affords the key advantages to practical application in credit scoring.

Future work could use deep learning models such as Convolutional Neural Networks (CNN) combined with tree-based ensemble models of NOTE as a hybrid for higher robustness in extracting non-linearity. Although CNN has been frequently used in voice recognition, natural language processing and computer vision problems, CNN could be applied to solve supervised classification problems on tabular datasets. The combination of the superior ability of CNN as feature extractor and the embedded method of tree-based NOTE as feature selector, can finally improve the classification performance by capturing non-linear characteristics and patterns in the datasets.

In addition, more heavily or absolutely imbalanced non-linear datasets in the diverse types of domain could be employed to validate the performance of NOTE for further study.

# Chapter 6

## GAN-based Imputation Techniques for Missing Values

### 6.1 Introduction

Credit scoring can be modelled from records or datasets that contain demographic, asset, income, payment behaviour, etc., as input features in relation to the creditworthiness. However, datasets in the real-world often have missing values or incomplete features for many reasons such that observations were not recorded and features were corrupted (Horton and Kleinman, 2007; Ibrahim et al., 2005; Yoon et al., 2018). For example, UCI Machine Learning Repository (Dua et al., 2017), which is a frequently used dataset collection, shows that 45% of datasets in the repository contain missing values (García-Laencina et al., 2010) and incomplete data are common for every case in observational studies such as social science and clinical trials (Li et al., 2015; Roderick et al., 2002; Schafer, 1997).

The issue of missing values reduces the number of available samples for analysis or might distort analysis when classification models make prediction process (Cheema, 2014; Jerez et al., 2010; McKnight et al., 2007). Hence, this drawback affects the performance of models as mentioned above, where

missing values or incomplete dataset can lead to the misclassification for the application of creditworthiness. In addition, ML models generally need complete data to be trained before the process of prediction (Ruiz-Chavez et al., 2018; Smieja et al., 2018). Due to this necessity of completeness in datasets for statistical and ML models, it is vital to deal with missing values appropriately (Bertsimas et al., 2017).

Nevertheless, the problem has often been ignored, or basic and simple methods such as removing samples with missing values or mean imputation in missing values, have been applied to cope with incomplete datasets in the analysis of credit scoring (Jerez et al., 2010; Nationalbank, 2004). The aim of dealing with missing values is to estimate the values similar to underlying complete dataset as close as possible (Bertsimas et al., 2017). The methods can be categorised into two groups (Kline, 2015), which are deletion and imputation.

Since deletion methods reduce the size of samples which have missing values, it might lead to the distortion for analysis as discussed and it cannot be the best way. Therefore, if the large portion of the samples comprises incomplete data, it leads to errors by the reduced size of samples (Little and Rubin, 2019). On the other hand, imputation methods, which are to replace incomplete portion of data with substituted values, are frequently employed. This way is called as missing data imputation (Salgado et al., 2016). This imputation is considered as the most appropriate and valid approach for dealing with incomplete datasets (Florez-Lopez, 2010). Imputation methods can be grouped into statistical and machine learning (ML) methods by approaches or generative methods by characteristics of imputation.

Therefore, the ability of handling missing values or incomplete datasets is important and required for classification to avoid large error or false estimation. Many studies based on statistics and ML have been introduced in order to handle this problem. They have shown that any methods do not guarantee the efficiency of the proposed methods. This means that the efficacy depends on the domain of the problem (e.g., number of samples, number



of features, pattern of missing data and the percentage of missing data in the dataset) (Jerez et al., 2010).

This study, hence, extending the GAIN-based imputation technique, proposes a novel imputation method named DITE (Denoising Imputation TEchniques for missingness in credit scoring) in order to solve the issues of missing values in credit scoring dataset for classification. First, the missingness is generated in the complete dataset. Then, the missing values in dataset are imputed by statistical and ML methods to see how the imputation performance is affected by various imputation techniques. Especially, imputation methods using ML techniques such as Multiple Imputation by Chained Equations (MICE) (Buuren and Groothuis-Oudshoorn, 2010), MissForest (Stekhoven and Bühlmann, 2012), Generative Adversarial Imputation Nets (GAIN) (Yoon et al., 2018), and the variants of GAIN in the domain of credit scoring will be analysed comparatively.

The aim of this study is to examine the robustness and effectiveness of DITE as well as to compare the imputation performance with the variants of GAIN, GAIN, MissForest and MICE.

The key contributions of this study are as follows:

- To demonstrate the effectiveness of denoising method by randomised singular value decomposition (rSVD) in a credit scoring dataset
- To present the advancement of GAIN imputation paired with rSVD by improving the imputation performance in an incomplete credit scoring dataset, compared with the benchmarks by original GAIN, the variants of GAIN, and conventional statistical and ML imputation approaches
- To propose an architecture of credit scoring model for datasets with missingness
- To suggest new benchmark results that outperform the state-of-the-art model by Yoon et al. (2018) on DC (Default of Credit card clients) dataset for missing value imputation

- To enable the practical application of imputation for missingness on incomplete credit scoring datasets

We hypothesise that the proposed DITE will not only reduce the noise in redundant and noisy datasets, but also build a model that are capable for suitable imputation on incomplete credit scoring datasets.

The remainder of this paper is organised as follows: Section II discusses the related studies and identifies the gaps in the current technologies. Section III describes the proposed DITE with its novel concepts. Section IV presents the results evaluating the performance of DITE with the benchmarks on the recent studies. Finally, Section V concludes with the summaries of the findings from this study.

## 6.2 Related Work

This section discusses the related studies on imputation methods and mechanism for missing values.

### 6.2.1 Imputation Methods for Missing Values

Imputation methods for missing values can be grouped into two ways, which are generally simple imputation methods and multiple imputation methods.

For single imputation methods such as mean/median/mode and regression, missing values are substituted with a single estimated value (Donders et al., 2006). Among them, mean imputation (Little and Rubin, 1989) to substitute missing value with overall sample mean is easily and generally used (Hammad Alharbi and Kimura, 2020). However, this method can underestimate the standard error and variance, and distort the basic distribution of data by ignoring the relations between features (Vriens and Melton, 2002). Regression imputation using existing (or complete) data in features by regression model to substitute missing value with predicted value, would be

Table 6.1: The examples of imputation methods

Method	Category	Reference
Mean imputation	Mean	Little and Rubin (1989)
Expectation Maximisation (EM)	EM	Dempster et al. (1977)
EM with bootstrapping	EM	Honaker et al. (2011)
K-Nearest Neighbour (KNN)	KNN	Troyanskaya et al. (2001)
MICE	ML-based regression trees	Buuren and Groothuis-Oudshoorn (2010)
MissForest	ML-based random forest	Stekhoven and Bühlmann (2012)
GAIN	GAN-based neural networks	Yoon et al. (2018)

an advanced method when compared to mean imputation. However, this method can also have the same issue regarding the standard error and variance (Baraldi and Enders, 2010). Therefore, the deficiency of single imputation methods does not reach the acceptable level of performance (Awan et al., 2021).

For multiple imputation methods such as Expectation Maximisation (EM) (Dempster et al., 1977) and MICE (Buuren and Groothuis-Oudshoorn, 2010), missing values are replaced with a set of values and these methods have been proposed to overcome the limitation of simple imputation methods (Yuan, 2010). When compared to single imputation, multiple imputation produces several values by predictive distribution and a set of values is combined to a single value after the process of analysis to impute missing values. However, this method costs more computationally since optimal iterations for convergence are not easy to be figured out (Kline, 2015), although multiple imputation allows to avoid unreliability of single imputation (Dong et al., 2021). In addition, MICE which is a regression-based method such as LR, has the limited performance to capture non-linearity (Seaman et al., 2012). This weakness, hence, might not reflect the interaction between features when taking imputation.

On the other hand, ML methods such as K-Nearest Neighbour (KNN) (Troyanskaya et al., 2001) imputation and MissForest (Stekhoven and Bühlmann, 2012) have been proposed and used commonly to impute missing values since these methods do not need the assumption for the distribution of data (Jerez

et al., 2010). Since MissForest is based on RF, it has shown the strengths to handle the non-linearity for replacing missing values with estimation in dataset (Stekhoven and Bühlmann, 2012). The studies have shown that the imputation by MissForest generally performs better than that of MICE (Shah et al., 2014).

Furthermore, Generative Adversarial Imputation Networks (GAIN) (Yoon et al., 2018) as a GAN-based substitution approach has been proposed and shown promising results to fill the missing values in tabular datasets. Yoon et al. (2018) introduced the generative model to estimate the missing values using GAN architecture in an adversarial way. As discussed, GAN as a generative model has been proved that it is accurate and effective for capturing the latent patterns in complex and non-linear datasets since the generative models are capable of modelling the distribution of original data (Awan et al., 2021). The GAIN using GAN has also been proved by Yoon et al. (2018) in the study that it is more robust than existing imputation methods such as AutoEncoder and MissForest. Table 6.1 shows the examples of imputation methods.

Nazabal et al. (2020) proposed the HI-VAE model to estimate heterogeneous incomplete (HI) tabular data with mixed continuous and discrete values, based on variational autoencoder (VAE). They also showed that predictive performance on complete data through HI-VAE has better results than original incomplete data. Camino et al. (2019) suggested a methodology to improve imputation performance of GAIN and VAE, and showed that their methods have better imputation performance on real-world datasets. With the variants of GAIN algorithms using advancement of GAN, Halmich (2020) developed Wasserstein GAIN (WGAIN) imputation techniques to improve the stability of the GAIN imputation method. The study showed comparative results against the benchmarks (Yoon et al., 2018) using WGAIN and achieved acceptable performance. Awan et al. (2021) also proposed a variant of GAIN algorithm as CGAIN using Conditional GAN (CGAN) to generate synthetic values for missingness. The study showed comparative results of performance for CGAIN against the benchmarks of existing impu-

$x_1$	$x_2$	$\dots$	$x_d$	$t$	$x_1$	$x_2$	$\dots$	$x_d$	$t$

**(a)**
**(b)**

Figure 6.1: The complete data without missing values on the features (a) and incomplete data with missing values on the features (b), where  $x_1, x_2, \dots, x_d$  represent the features and  $t$  denotes the label (García-Laencina et al., 2010)

tation methods.

### 6.2.2 Mechanism for Missing Values

Since it depends significantly on the mechanism of missingness to deal with the problem of missing values, the nature and effect of missingness needs to be analysed and taken into account on credit scoring datasets (Florez-Lopez, 2010).

Dataset without missing values can be denoted as  $X$  and dataset with missing values can be denoted as  $X_M$ . Therefore,  $X_M$  consists of two parts as follows:

$$X_M = \{X_o, X_m\} \tag{6.1}$$

where  $X_o$  is an observed and complete set, and  $X_m$  is a missing and incomplete set.  $M$  can be used as indicator matrix known generally for missing data.  $M$  indicates which inputs of  $X_M$  are observed or complete and which features of  $X_M$  are incomplete or missing, and is a binary matrix (García-Laencina et al., 2010). Figure 6.1 shows the missingness in the dataset.

Since missing values  $X_m$  can be estimated, based on observed values  $X_o$  by imputation methods, there are three different types of missing data

according to the characteristic of missingness, which means how the components of features became missing (Rubin, 1976). The characteristics of missingness can be categorised as follows (García-Laencina et al., 2010):

1. Missing completely at random (MCAR)
2. Missing at random (MAR)
3. Missing not at random (MNAR)

MCAR occurs when the probability  $P$  is independent of both observed and missing data and shows high level randomness, where the probability  $P$  is that the data or features are missing (García-Laencina et al., 2010).

$$P(M|X_m) = P(M) \quad (6.2)$$

MAR occurs when the missingness has dependency only on the observed data regardless of missing data and shows mid level randomness (García-Laencina et al., 2010).

$$P(M|X_m) = P(M|X_o) \quad (6.3)$$

MNAR occurs when the probability  $P$  is dependent on both observed and missing data and shows low level randomness, where the probability  $P$  is that the data or features are missing (García-Laencina et al., 2010).

$$P(M|X_m) = P(M|X_o, X_m) \quad (6.4)$$

The classification for characteristics of missingness is important since imputation methods can be applied in a certain pre-condition or assumption. When the data is in the category of MCAR or MAR, missing data is an ignorable mechanism (García-Laencina et al., 2010). This means that when MCAR or MAR occurs, imputation methods for missing data can be applied in the analysis of data regardless of the reason for missingness and it is possible to expect missing values (Schafer, 1997). Due to this reason, most

research for missing data imputation have been studied when missingness occurs in MCAR or MAR (Enders and Gottschall, 2011; García-Laencina et al., 2010). In this paper, the experiment will be performed to approximate and impute values for missing data under the assumption of MCAR.

### **6.3 DITE: Denoising Imputation TEchniques for missingness in credit scoring**

The DITE consists of four stages, which are as follows:

1. Collecting DC dataset
2. Rescaling and denoising original dataset by rSVD
3. Imputing the values generated by GAIN for missing data in incomplete dataset
4. Predicting the classification on complete dataset

These stages need to process sequentially in order to obtain the necessary levels of effectiveness.

Default of Credit card clients (DC) dataset (Yeh and Lien, 2009) contains demographic information, history of payment, default payment and delinquency for the samples of credit card clients. It comes from previous paper of credit scoring literature and UCI Machine Learning Repository (UCI MLR) (Dua et al., 2017). It consists of 30,000 samples with 23,364 good credit samples and 6,636 bad credit samples, respectively. Bad credit samples are defined as the cases where the target feature named ‘default.payment.next.month’ is specified as 1, which means the client has defaulted on the payment. On the other hand, good credit samples are classified as the cases that the label is specified as 0, which means the client has not defaulted on the payment. This is a binary class label. The dataset does not

contain missing values originally and was used due to the benchmark in the results (Awan et al., 2020; Camino et al., 2019; Halmich, 2020; Yoon et al., 2018).

The initial dataset shows the percentage of minority class in total as 22.12 % and Imbalance Ratio (IR) as 3.52, which is the number of the majority class divided by the number of the minority class. The dataset contains 23 features that can directly be interpreted into a credit scoring system, excluding target feature.

The concepts and methodologies for replacing missing values in the dataset with the estimation are introduced and described in this section.

In order for filling missing values in incomplete features of the dataset, the dataset can be substituted with the values obtained by statistical methods such as mean imputation (simple imputation), ML methods such as MICE, KNN, MissForest, and neural network (NN) methods such as GAIN. The results will be analysed comparatively as to whether the proposed model DITE is as robust against the benchmarks as GAIN-based methods, MissForest, MICE and simple imputation.

Before rSVD is applied for removing the noise in dataset, normalising the dataset can be conducted to make the training of GAIN less sensitive to the scale of features. It rescales the range of values in the dataset to be inside the interval  $[0, 1]$ , and enhances the performance of synthesising the data by GAIN. Since GAIN is one of the algorithms as NN, NN is sensitive to the scale when it weights input values.

The normalisation is expressed as follows:

$$Normalised(V_i) = \frac{V_i - \min(V_i)}{\max(V_i) - \min(V_i)} \quad (6.5)$$

where  $V_i$  is a value of feature, and  $\max(V_i)$  and  $\min(V_i)$  are the maximum and minimum of values in features, respectively.

After normalising the values in the dataset, rSVD is applied to the normalised dataset to remove the noise in order to enhance the performance



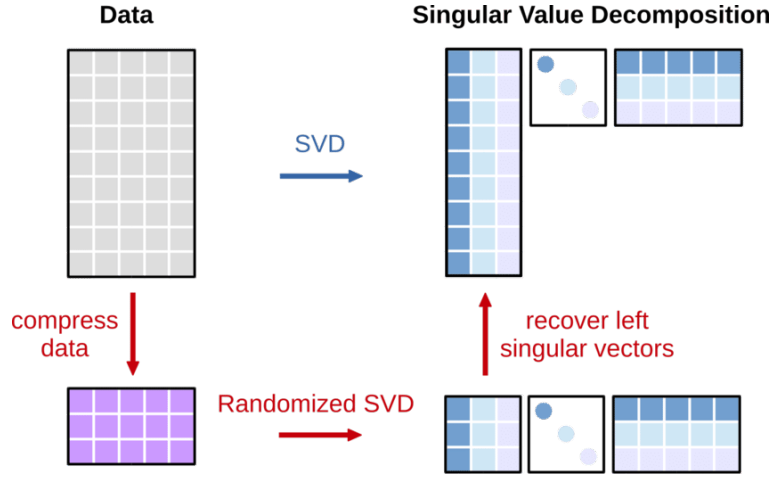

Figure 6.2: The conceptual architecture of rSVD

of GAIN as well. It is common that real-world credit scoring datasets have noise and redundant features (Xia et al., 2017). rSVD can thus be an effective method to reduce the noise before the process of imputation by GAIN.

Singular value decomposition (SVD) for matrix decomposition has been commonly used for reducing dimensionality and noise, analysing and compressing data, especially in image processing. The compressed image with reduced noise and extracted characteristics can be obtained by SVD.

SVD can also be applied to the imputation for missing values in tabular dataset, based on the assumption that the dataset consists of noisy samples of a linear combination with principal factors (Bertsimas et al., 2017). Through SVD, the principal factors, which are called as eigenvectors, can be obtained. These eigenvectors enhance GAIN algorithm to capture the patterns and characteristics of the dataset and estimate the values in the missing part of the dataset.

Given a matrix  $M \in \mathbb{R}^{m \times n}$  with  $m \times n$ , SVD can be expressed as follows:

$$M = U\Sigma V^T \quad (6.6)$$

where matrix  $U = [u_1, \dots, u_m] \in \mathbb{R}^{m \times m}$ , matrix  $V = [v_1, \dots, v_m] \in$

$\mathbb{R}^{n \times n}$ , and  $U$  and  $V$  are orthogonal. The left singular vectors in  $U$  show a basis for column space (the range) and the right singular vectors in  $V$  show a basis for domain space (the row) of the matrix  $M$  (Erichson et al., 2019c). The rectangular matrix  $\Sigma \in \mathbb{R}^{m \times n}$  has the corresponding singular values  $\sigma_1 \geq \dots \geq \sigma_n \geq 0$  in diagonal, representing the spectrum of data (Erichson et al., 2019c). That is,

$$M = U\Sigma V^T = [u_1, \dots, u_m]diag(\sigma_1, \dots, \sigma_n)[v_1, \dots, v_m]^T \quad (6.7)$$

Figure 6.2 shows the conceptual architecture of rSVD. Although SVD is computationally expensive, rSVD with concept of randomness has been introduced to reduce the computational cost. This concept allows the scalable transformation of matrix and captures the latent information in the dataset (Erichson et al., 2019a). In addition to the application of rSVD, Camino et al. (2019) and Hammad Alharbi and Kimura (2020) proved that imputation performance of GAIN was improved by normalised dataset. Therefore, a promising performance would be expected if denoising method by rSVD could be combined with the normalised dataset before imputation techniques by GAIN.

Following rescaling and denoising methods by normalisation and rSVD, DITE performs GAIN-based imputation to replace the missing values with generated data on the incomplete dataset.

GAIN (Yoon et al., 2018) was proposed to deal with the problem of missing values in dataset using the architecture of GANs (Goodfellow et al., 2014). Missing values are imputed by the conditional distribution or joint distribution of complete data matrix  $X$  as mentioned earlier in Section 6.2. Since GANs generate synthetic data through adversarial learning of generator and discriminator, missing values can be imputed using distribution of synthetic data rather than using expectation of multiple imputations such as MICE (Royston et al., 2011). Specifically, the discriminative models such as MICE and MissForest learn a function that maps the input  $x$  into output  $y$  and are able to fill the missing values using conditional probability  $P(y|x)$ .

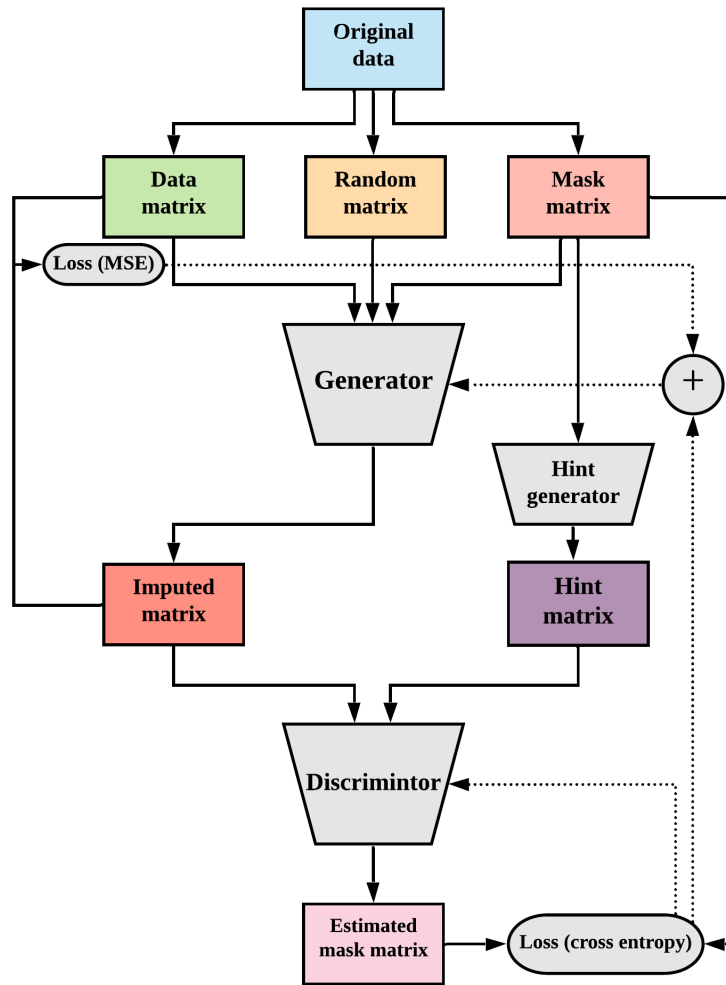

Figure 6.3: The architecture of GAIN

On the other hand, the generative models such as EM, Denoising AutoEncoder (DAE) and GAIN learn a probability distribution of data and are able to fill the missing values using joint probability  $P(x, y)$ .

GAIN algorithm is based on the architecture of GAN and consists of generator  $G$  and discriminator  $D$  as same with GAN. However, GAIN algorithm has unique characteristics when compared to standard GANs, and the objective of GAIN is different from the objective of GAN. Although GAN is trained to generate synthetic distribution from original distribution and to

distinguish whether the entire generated data is real or fake, GAIN is trained to fill in incomplete data of samples and to distinguish whether the generated values are real or fake, i.e. generator  $G$  generates plausible components for missing values in samples using the distribution of original data and discriminator  $D$  discriminates between each plausible generated (or imputed) components and observed components in the data (Yoon et al., 2018).

$G$  in GAIN takes the inputs: data matrix, random matrix and mask matrix. The mask matrix represents whether a value is present or absent, i.e., the marking of missing value, where a presence of value in matrix is marked as 1, while an absence of value in matrix is marked as 0.  $D$  in GAIN predicts the complete estimated mask matrix whose components show, for each component of data, whether the corresponding input value is observed or not (missing) in the original data by hint matrix from hint generator (Awan et al., 2021). Figure 6.3 shows the architecture of GAIN.

To compare GAN with GAIN architecture, two-player minmax game of GAN can be expressed with objective function as follows:

$$\min_G \max_D V(D, G) = E_{x \sim P_{data(x)}} [\log D(x)] + E_{z \sim P_z(z)} [\log(1 - D(G(z)))] \quad (6.8)$$

Based on the architecture of GAN, the objective function of GAIN can be expressed as follows:

$$\min_G \max_D V(D, G) = E_{\hat{X}, M, H} [M^T \log D(\hat{X}, H) + (1 - M)^T \log(1 - D(\hat{X}, H))] \quad (6.9)$$

where  $M$  is a mask matrix, which indicates the position of missing values in original incomplete matrix  $X$ , and  $H$  is a hint matrix, which prevents the discriminator  $D$  from learning dominantly when compared to generator  $G$ , and  $D(\hat{X}, H) = \hat{M}$  is the probability such that the imputed values are observed values.

Generator  $G$  takes inputs as data matrix  $\tilde{X}$ , random matrix  $Z$  and mask matrix  $M$ , and generates output as imputed matrix  $\hat{X}$ . Discriminator  $D$  takes inputs as imputed matrix  $\hat{X}$  and hint matrix  $H$ , and generates output as an estimated mask matrix  $\hat{M} = D(\hat{X}, H)$

The objective of generator  $G$  in GAIN is to generate plausible synthetic values as close as the observed value that mask matrix  $M$  indicates it equals to 1 (observed), in order to deceive the discriminator  $D$  that discriminates the plausible synthetic value as the real or observed value.

On the other hand, the objective of discriminator  $D$  in GAIN is to distinguish the observed value as the observed value that mask matrix  $M$  indicates it equals to 1 (observed), and distinguish the missing value as the missing value that mask matrix  $M$  indicates it equals to 0 (missing).

The process of GAIN is also a two-player minmax game as discussed earlier.

The loss of generator  $G$  in GAIN consists of two parts since  $G$  outputs the imputed matrix for both the observed values and the missing values. The first part shows the loss of imputed values and the second part represents the loss of observed values (Awan et al., 2021). The loss of generator  $G$  in GAIN, hence, can be expressed as follows:

$$L_G(m, \hat{m}, b) = - \sum_{i:b_i} (1 - m_i) \log(\hat{m}_i) + \alpha \sum_{j=1}^d m_j L_M(x_j, \hat{x}_j) \quad (6.10)$$

where  $\alpha$  denotes a positive hyperparameter and  $L_M(x_i, \hat{x}_i)$  is as follows (Yoon et al., 2018):

$$L_M(x_i, \hat{x}_i) = \begin{cases} m_i(\hat{x}_i - x_i)^2, & \text{if } x_i \text{ is continuous} \\ m_i(-x_i \log(\hat{x}_i)), & \text{if } x_i \text{ is binary} \end{cases} \quad (6.11)$$

The loss of discriminator  $D$  in GAIN can also be written by the form of cross entropy as follows:

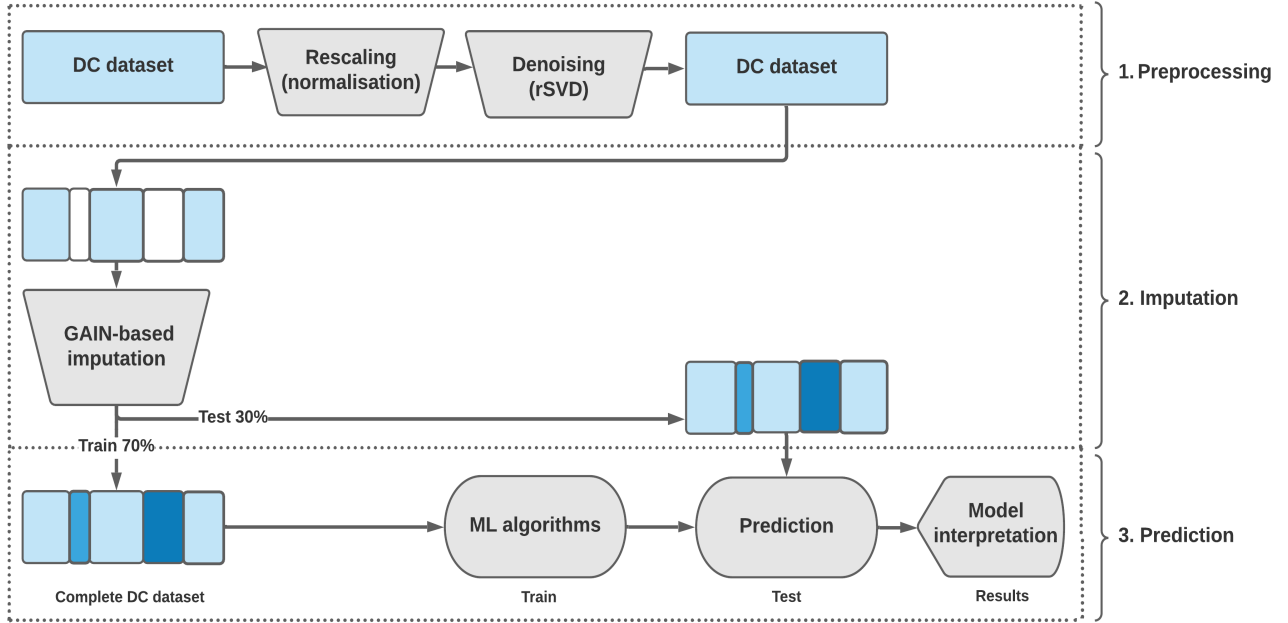

Figure 6.4: The system architecture of DITE

$$L_D(m, \hat{m}, b) = \sum_{i:b_i} (m_i \log(\hat{m}_i) + (1 - m_i) \log(1 - \hat{m}_i)) \quad (6.12)$$

where  $b_i$  is the  $i^{\text{th}}$  element of a random variable  $B = (B_1, \dots, B_d) \in \{0, 1\}^d$ , which is acquired by sampling  $k$  from  $\{1, \dots, d\}$  uniformly at random and  $m_i$  is the  $i^{\text{th}}$  element of mask matrix  $M$  (Yoon et al., 2018). Afterwards setting

$$B_j = \begin{cases} 1, & \text{if } j \neq k \\ 0, & \text{if } j = k \end{cases} \quad (6.13)$$

The imputation performance of DITE is compared against the benchmarks, which are MissForest as ML-based random forest imputation method and MICE as ML-based regression trees imputation method as well as the variants of GAIN approaches.

Following imputing the values generated by DITE, DITE performs the

Table 6.2: RMSE comparison for imputation performance of the proposed DITE against the benchmarks on default credit card with 5%, 10%, 15% and 20% missing data

	5%	10%	15%	20%
DITE	0.0724±0.0009	0.0763±0.0007	0.0818±0.0033	0.0857±0.0005
GAIN*	0.1447±0.0016	0.1482±0.0005	0.1532±0.0005	0.1561±0.0012
GAIN (Awan et al., 2021)	0.2428±0.0093	0.2109±0.0344	0.2442±0.0089	0.2426±0.0090
CGAIN (Awan et al., 2021)	0.2329 ±0.0039	0.2009±0.0022	0.2314 ±0.0035	0.2213±0.0099
MissForest (Awan et al., 2021)	0.2902±0.0010	0.2439±0.0079	0.2672±0.0025	0.2646±0.0026
MICE (Awan et al., 2021)	0.2479 ±0.0079	0.2491±0.0085	0.2479 ±0.0074	0.2480±0.0091

\*Implemented



Figure 6.5: RMSE comparison for imputation performance on missingness

prediction with complete dataset. Overall, Figure 6.4 shows the system architecture of DITE.

## 6.4 Results

To validate the efficacy of DITE (denoising GAIN-based imputation method) for missing values or incomplete data, missing values are generated randomly with the percentage of 5%, 10%, 15%, 20%, 50% and 80%. Removing values in the dataset is based on the assumption of MCAR in the complete dataset.

Table 6.3: RSME comparison for imputation performance of the proposed DITE against GAIN-based imputation methods on default credit card with 20% missing data

	<b>20%</b>
DITE	0.0857±0.0005
GAIN*	0.1561±0.0012
GAIN+vs** (Camino et al., 2019)	0.1190±0.0040
GAIN (Yoon et al., 2018)	0.1858±0.0010
CGAIN (Awan et al., 2021)	0.2213±0.0099
WGAIN (Halmich, 2020)	0.2712±0.0014

\*Implemented \*\*Variables split

The performance of DITE is evaluated by the metric as Root Mean Square Error (RMSE) in order to validate the imputation performance. The RMSE is the root of mean squared error (MSE) for the prediction  $f(x)$  with respect to label  $y$ . MSE can be expressed as follows:

$$MSE(f(x)) = E[(f(x) - y)^2] = \frac{1}{m} \sum_{i=1}^m (f(x_i) - y_i)^2 = \int_{x \sim D} (f(x) - y)^2 p(x) dx \quad (6.14)$$

where  $D$  is the distribution of data and  $p(\cdot)$  is the probability density function.

Before the classification performance through imputation is compared between DITE, GAIN, MissForest, and MICE as benchmarks, the imputation performance of DITE on DC dataset needs to be evaluated. The proposed DITE is compared against the state-of-the-art benchmarks of existing popular imputation methods such as the variants of GAIN: GAIN+vs (Camino et al., 2019), GAIN (Yoon et al., 2018), CGAIN (Awan et al., 2020), WGAIN (Halmich, 2020) and the standard ML-based imputation method such as MissForest and MICE.



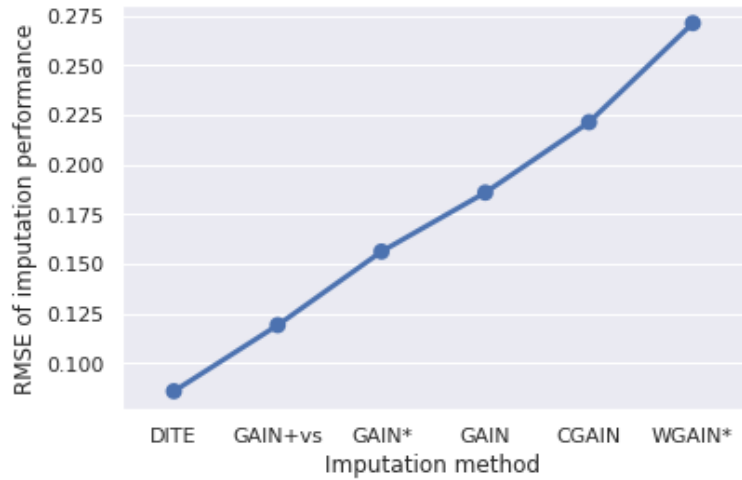

Figure 6.6: RMSE comparison for GAIN-based imputation methods on default credit card with 20% missing data

Table 6.2 and Figure 6.5 show RMSE comparison for imputation performance where the percentage of missing values ranges from 5% to 20%. The proposed DITE showed the best imputation performance when compared to other approaches. As can be seen, DITE outperformed the benchmarks on four different proportions of missing values. Furthermore, GAIN-based imputation methods showed superior results to ML-based method.

Table 6.3 and Figure 6.6 show RSME comparison for imputation performance between GAIN-based imputation methods on 20% missing data. DITE outperformed all other GAIN-based imputation models.

With the justification by the results of Table 6.3 and Figure 6.6, the four best models need to be analysed further on varying proportion of missing values since RMSE 0.2 can be regarded as the threshold for imputation performance on models and different percentage of missing values, as shown in Figure 6.6.

Table 6.4 and Figure 6.7 show RMSE comparison for imputation performance between the four best models, where the percentage of missing values ranges from 20% to 80%. The proposed DITE showed the best imputation

Table 6.4: RMSE comparison for imputation performance of the proposed DITE against the best four benchmarks of GAIN-based imputation on default credit card with 20%, 50% and 80% missing data

	20%	50%	80%
DITE	0.0857±0.0005	0.1292±0.0068	0.1449±0.0199
GAIN*	0.1561±0.0012	0.1926±0.0179	0.2787±0.0052
GAIN+vs**(Camino et al., 2019)	0.1190±0.0040	0.1840±0.0040	0.2550±0.0030
GAIN (Camino et al., 2019)	0.1230±0.0010	0.1940±0.0020	0.2700±0.0050

\*Implemented \*\*Variables split

performance when compared to other approaches. In addition, DITE outperformed the benchmarks on severe condition having 80% missing values.

As a result and as expected, the imputation performance of all GAIN-based models decreases when the percentage of missingness increases. However, GAIN-based imputation approaches outperformed ML-based imputation methods such as MICE and MissForest, as shown in Figure 6.5.

This implies that GAIN-based models have robust imputation power since they are updated by the feedback using the loss of cross entropy from the discriminator as well as the observed values in the dataset. GAIN-based models, hence, have the capability to resist high proportion of missingness in the dataset. With this reason, DITE showed the stable results comparatively although the proportion of missing data increases as shown in Figure 6.7.

Therefore, the advancement of GAIN imputation paired with rSVD was presented by improving the imputation performance on incomplete credit scoring dataset, compared with the benchmarks by original GAIN, the variants of GAIN, and conventional statistical and ML imputation approaches.

Finally, DITE successfully proposed a novel architecture of credit scoring model for datasets with missingness.



Figure 6.7: RMSE comparison for imputation performance of the proposed NITE against the best four imputation methods on default credit card with 20%, 50% and 80% missing data

## 6.5 Conclusion

In this paper, a novel imputation technique named DITE was proposed for the issue of missing values on credit scoring dataset. Designing the methodology for generative model was focused by expanding the state-of-the-art GAIN algorithm.

The empirical results showed that the proposed DITE generated the synthetic values successfully for missingness in the dataset by the combination of the advantages of normalisation, rSVD and GAIN, with reflecting the latent characteristics of the dataset. DITE outperformed the ML-based methods such as MICE and MissForest, and the variants of GAIN such as CGAIN and WGAIN, including GAIN in the imputation of missing values on credit scoring dataset. This robust imputation approach as DITE could finally result in the improvement of predictive performance for credit scoring against the benchmarks of other completion methods. Therefore, DITE can be applied to more accurate credit scoring, requiring the estimation of missing values on complex tabular datasets.

Future work could extend this novel methodology to more complicated areas such as text, voice recognition and missing image imputation.

# Chapter 7

## Conclusions

### 7.1 Introduction

In this thesis, the main purpose was focused on dealing with three key issues of the modelling process for explainable and accurate credit scoring. Three challenges were examined during developing credit scoring. First, the interpretability in credit scoring as XAI was examined with respect to the non-parametric approaches combining with the state-of-the-art SHAP values. In this experiment, the suitability of tree-based ensemble models was also assessed on imbalanced credit scoring dataset. Second, class imbalance on credit scoring was explored to quantify the prediction performance through generative resampling methods, expanding the state-of-the-art GAN algorithm paired with stacked autoencoder. Third, missingness on dataset was examined to assess generative imputation approaches, expanding the state-of-the-art GAIN algorithm. These three problems were handled by the proposed novel models, named NATE, NOTE and DITE, respectively. This thesis demonstrated the comparative results against the benchmarks to evaluate the proposed models. The proposed models achieved both explainability and robustness aligned with the main aim of this research.

Specifically, NATE outperformed the industry standard LR model, which

was used as a benchmark model in this thesis, and successfully explained the reasons for credit scoring by non-parametric tree-based approach with SMOTE on real-world imbalanced GMSC dataset. NOTE outperformed LR on non-linear, complex and imbalanced HE dataset, with extracting non-linear patterns by NSA and reflecting the non-linear characteristics of the minority class by cWGAN as well as with overcoming the limitation of SMOTE and interpreting the non-parametric models. DITE outperformed the state-of-the-art imputation methods by denoising dataset and generating substituted values on DC dataset with missing values, as a result, and allows to have potential for improving the predictive performance in credit scoring model.

## 7.2 Summary of Contributions

At the end of this thesis, the contributions of this work are provided with the summaries of each chapter in order to provide how this research contributes to the domain of credit scoring to the readers.

- **Chapter 2**

1. explained theoretical concepts of machine learning, evaluation and selection for machine learning models, and classification algorithms.
2. focused on ensemble models, i.e., non-parametric tree-based algorithms to validate the suitability, stability and superiority for the application of credit scoring in order to balance the trade-off between model explainability and predictive performance with reviewing the related literature of ensemble algorithms in the domain of credit scoring.

- **Chapter 3**

1. presented the overview about theoretical concepts and background of credit scoring and the applicability of machine learning.
2. designed the general system architecture for credit scoring model using machine learning as the process of development and implementation.
3. described the real-world credit scoring datasets and the preprocessing methods of original raw datasets.
4. addressed the three primary issues in the process of system architecture, namely, model explainability, imbalanced class and missing values on credit scoring datasets, supported by the related literature.
5. proposed the novel approaches using the state-of-the-art machine learning techniques for dealing with the key issues of credit scoring.
6. presented the results of the proposed models briefly as the showcase of novel approaches.

- **Chapter 4**

1. addressed the issues of model explainability and imbalanced class on credit scoring dataset with related work about SHAP and resampling methods.
2. demonstrated the efficacy of non-parametric models on non-linear GMSC (Give Me Some Credit) dataset for credit scoring
3. presented the standard oversampling method as SMOTE synthesising the minority class in imbalanced dataset, compared with undersampling method by NearMiss
4. proposed NATE as the system architecture of non-parametric approach on non-linear and imbalanced dataset for explainable credit scoring.

5. suggested the results that SMOTE outperforms NearMiss on the diverse imbalanced ratio of GMSC dataset and proved that over-sampling performs better than undersampling to improve the classification performance.
6. achieved the explainability aspect for practical application in credit scoring as XAI combined with SHAP as well as high predictive performance of the proposed non-parametric model.

- **Chapter 5**

1. addressed the issues of model explainability and imbalanced class on non-linear and complex dataset with related work about GAN-based oversampling methods and generating tabular data by GAN.
2. demonstrated the effectiveness of extracted latent features using NSA and compared NSA with denoising method by rSVD on non-linear HE (Home Equity) dataset for credit scoring.
3. presented the advancement of cWGAN by overcoming the problem of mode collapse in the training process of GAN and determined the suitability, stability and superiority of cWGAN generating the minority class on imbalanced dataset, compared with the benchmarks by GAN and SMOTE.
4. proposed NOTE as a novel architecture of a non-parametric model for non-linear and imbalanced dataset.
5. suggested new benchmark results that outperform the state-of-the-art model by Engelmann and Lessmann (2021) on HE dataset for classification performance.
6. enabled the explainability aspect of the proposed model for practical application in credit scoring as XAI.

- **Chapter 6**

1. addressed the issues of missingness in dataset with related work about the conventional imputation approaches for missing values and mechanisms of missingness.



2. demonstrated the effectiveness of denoising method by rSVD on DC (Default of Credit card clients) dataset for credit scoring.
3. presented the advancement of GAIN imputation paired with rSVD by improving the imputation performance on incomplete credit scoring dataset, compared with the benchmarks by original GAIN, the variants of GAIN, and conventional statistical and ML imputation approaches.
4. proposed DITE as a novel architecture of credit scoring model for datasets with missingness.
5. suggested new benchmark results that outperform the state-of-the-art models by Yoon et al. (2018) on DC dataset for imputation performance.
6. enabled the practical application of imputation for missingness on incomplete credit scoring dataset.

### 7.3 Future Work

As further research and future work, the proposed models as NATE, NOTE and DITE in this thesis can be extended to the followings.

NATE and NOTE as non-parametric tree-based models could be combined with CNN as a hybrid for higher robustness in extracting non-linearity. This hybrid approach could result in the improvement of predictive performance of models with the strengths of NATE and NOTE in the aspects of interpretability and explainability.

NOTE could be examined further in more sophisticated and complicated form for generative performance, e.g., the distribution ratio of class imbalance, absolute imbalanced class and multi-class distribution on the diverse domain of datasets. Furthermore, cost-sensitive loss function, as suggested by Al-Sawwa and Ludwig (2020), could also be considered and merged with NOTE as an algorithm-level approach. This method could lead to not

only the improvement of overall predictive performance of NOTE, but also the improvement of the accuracy of the classification for the minority class. This combination of data-level oversampling technique and algorithm-level cost-sensitive classification approach could finally be an optimal solution for imbalanced class.

DITE could be scrutinised further in more detailed experiments for imputation performance of the integer and categorical features, respectively since DC dataset is composed of the features with both integer and category. In other words, the imputation errors (RMSE) of DITE, the variants of GAIN and GAIN could be compared for integer, continuous and categorical features, respectively, as the missing rates increase on the diverse domain of datasets. Furthermore, DITE could be examined in the environment of absolutely skewed continuous features and highly imbalanced categorical features at a certain missingness rate (e.g. 20%), as suggested by Dong et al. (2021).

# Appendix A

## Abbreviations

AE	Auto-Encoder
AI	Artificial Intelligence
AUROC	Area Under the Receiver Operating Characteristic curve
bcGAN	borderline conditional Generative Adversarial Networks
cGAN	conditional Generative Adversarial Networks
CNN	Convolutional Neural Network
CS	Credit Scoring
ctGAN	conditional tabular Generative Adversarial Networks
cWGAN	conditional Wasserstein Generative Adversarial Networks
DITE	Denoising Imputation TEchniques for missingness in CS
DL	Deep Learning
DNN	Deep Neural Network
DT	Decision Tree
EAD	Exposure At Default

EM	Expectation-Maximisation
ET	Extra Tree
FE	Feature Engineering
FS	Feature Selection
GAIN	Generative Adversarial Imputation Networks
GAN	Generative Adversarial Networks
GB	Gradient Boosting
i.i.d.	independent and identically distributed
IR	Imbalance Ratio
JSD	Jensen-Shannon Divergence
KLD	Kullback-Leibler Divergence
KNN	K-Nearest Neighbour
LDA	Linear Discriminant Analysis
LDP	Low Default Portfolios
LGD	Loss Given Default
LR	Logistic Regression
MedGAN	Medical Generative Adversarial Networks
MICE	Multiple Imputation by Chained Equations
ML	Machine Learning
MLE	Maximum Likelihood Estimation
MSE	Mean Square Error
NATE	Non-parametric approach for Explainable CS
NB	Naive Bayes

NN	Neural Network
NOTE	Non-parametric Oversampling Techniques for Explainable CS
NSA	Non-parametric Stacked Autoencoder
PCA	Principal Component Analysis
PD	Probability of Default
RF	Random Forest
RMSE	Root Mean Square Error
ROC	Receiver Operating Characteristic
rSVD	randomised Singular Value Decomposition
SAE	Stacked Auto-Encoder
SHAP	SHapley Additive exPlanations
SMOTE	Synthetic Minority Oversampling TEchnique
SVD	Singular Value Decomposition
SVM	Support Vector Machine
tGAN	tabular Generative Adversarial Networks
t-SNE	t-distributed Stochastic Neighbour Embedding
UCI	University of California Irvine
VAE	Variational Auto-Encoders
XAI	eXplainable Artificial Intelligence
XGB	eXtreme Gradient Boosting

# Appendix B

## Additional materials for NOTE

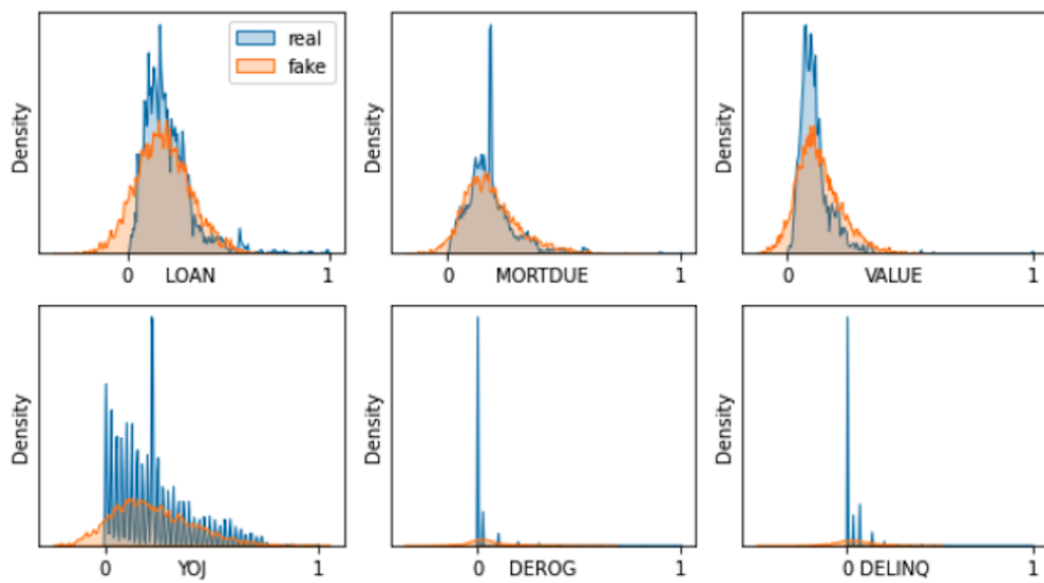

Figure B.1: Comparison between real and generated distribution of numerical features by NOTE on HE dataset

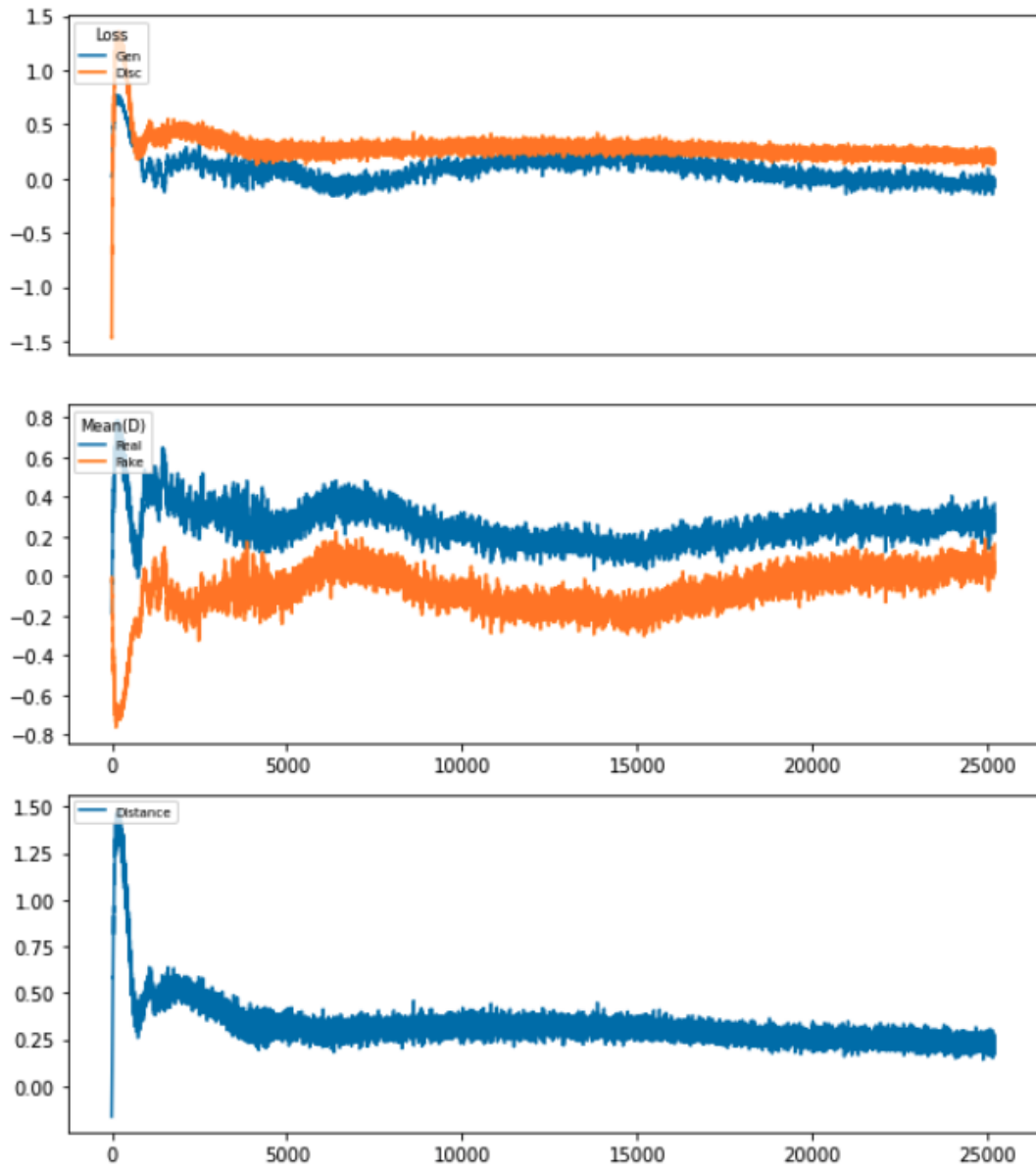

Figure B.2: The loss of generator and discriminator in NOTE (cWGAN) on HE dataset

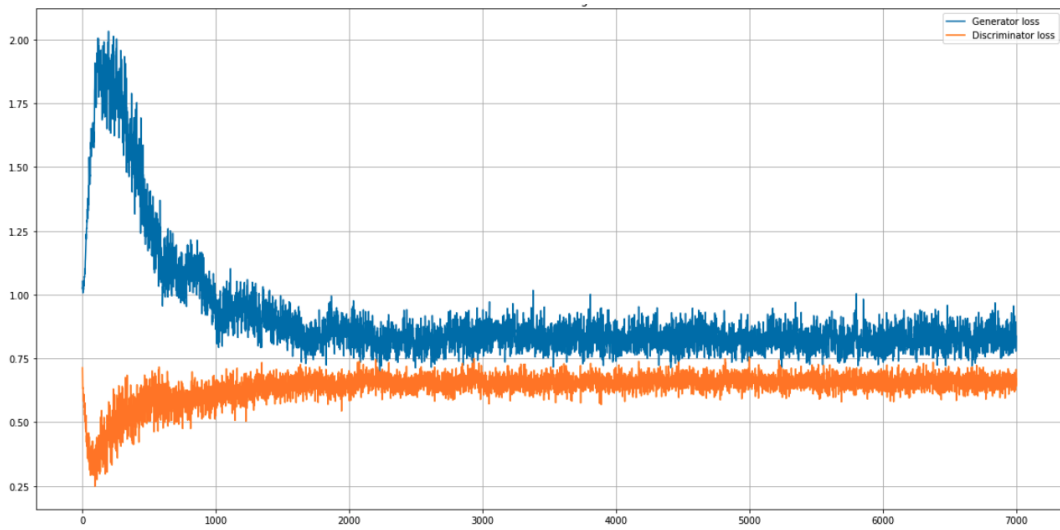

Figure B.3: The loss of generator and discriminator in GAN on HE dataset



# Bibliography

- Abdou, H., Pointon, J., and El-Masry, A. (2008). Neural nets versus conventional techniques in credit scoring in egyptian banking. *Expert Systems with Applications*, 35(3):1275–1292.
- Acuna, E. and Rodriguez, C. (2004). The treatment of missing values and its effect on classifier accuracy. In *Classification, clustering, and data mining applications*, pages 639–647. Springer.
- Akkoç, S. (2012). An empirical comparison of conventional techniques, neural networks and the three stage hybrid adaptive neuro fuzzy inference system (anfis) model for credit scoring analysis: The case of turkish credit card data. *European Journal of Operational Research*, 222(1):168–178.
- Al-Sawwa, J. and Ludwig, S. A. (2020). Performance evaluation of a cost-sensitive differential evolution classifier using spark–imbalanced binary classification. *Journal of Computational Science*, 40:101065.
- Ala’raj, M. and Abbod, M. F. (2016a). Classifiers consensus system approach for credit scoring. *Knowledge-Based Systems*, 104:89–105.
- Ala’raj, M. and Abbod, M. F. (2016b). A new hybrid ensemble credit scoring model based on classifiers consensus system approach. *Expert Systems with Applications*, 64:36–55.
- Anderson, R. (2007). *The credit scoring toolkit: theory and practice for retail credit risk management and decision automation*. Oxford University Press.

- Angelini, E., di Tollo, G., and Roli, A. (2008). A neural network approach for credit risk evaluation. *The quarterly review of economics and finance*, 48(4):733–755.
- Arjovsky, M., Chintala, S., and Bottou, L. (2017). Wasserstein generative adversarial networks. In *International conference on machine learning*, pages 214–223. PMLR.
- Atiya, A. F. (2001). Bankruptcy prediction for credit risk using neural networks: A survey and new results. *IEEE Transactions on neural networks*, 12(4):929–935.
- Awan, S. E., Bennamoun, M., Sohel, F., Sanfilippo, F., and Dwivedi, G. (2021). Imputation of missing data with class imbalance using conditional generative adversarial networks. *Neurocomputing*, 453:164–171.
- Awan, S. E., Bennamoun, M., Sohel, F., Sanfilippo, F. M., and Dwivedi, G. (2020). Imputation of missing data with class imbalance using conditional generative adversarial networks. *arXiv preprint arXiv:2012.00220*.
- Baesens, B., Mues, C., Martens, D., and Vanthienen, J. (2009). 50 years of data mining and or: upcoming trends and challenges. *Journal of the Operational Research Society*, 60(sup1):S16–S23.
- Baesens, B., Roesch, D., and Scheule, H. (2016). *Credit risk analytics: Measurement techniques, applications, and examples in SAS*. John Wiley & Sons.
- Baesens, B., Van Gestel, T., Viaene, S., Stepanova, M., Suykens, J., and Vanthienen, J. (2003). Benchmarking state-of-the-art classification algorithms for credit scoring. *Journal of the operational research society*, 54(6):627–635.
- Baraldi, A. N. and Enders, C. K. (2010). An introduction to modern missing data analyses. *Journal of school psychology*, 48(1):5–37.

- Basel, I. (2004). International convergence of capital measurement and capital standards: a revised framework. *Bank for international settlements*.
- Batista, G. E., Prati, R. C., and Monard, M. C. (2004). A study of the behavior of several methods for balancing machine learning training data. *ACM SIGKDD explorations newsletter*, 6(1):20–29.
- Bazarbash, M. (2019). Fintech in financial inclusion: machine learning applications in assessing credit risk. *International Monetary Fund*.
- Beam, A. L. and Kohane, I. S. (2018). Big data and machine learning in health care. *Jama*, 319(13):1317–1318.
- Bengio, Y., Courville, A., and Vincent, P. (2013). Representation learning: A review and new perspectives. *IEEE transactions on pattern analysis and machine intelligence*, 35(8):1798–1828.
- Bertsimas, D., Pawlowski, C., and Zhuo, Y. D. (2017). From predictive methods to missing data imputation: an optimization approach. *The Journal of Machine Learning Research*, 18(1):7133–7171.
- Bhattacharyya, S. and Maulik, U. (2013). *Soft computing for image and multimedia data processing*. Springer.
- Biau, G. (2012). Analysis of a random forests model. *The Journal of Machine Learning Research*, 13(1):1063–1095.
- Bijak, K. and Thomas, L. C. (2012). Does segmentation always improve model performance in credit scoring? *Expert Systems with Applications*, 39(3):2433–2442.
- Board, F. S. (2017). Artificial intelligence and machine learning in financial services: Market developments and financial stability implications. *Financial Stability Board*, page 45.
- Boughaci, D. and Alkhaldeh, A. A. (2020). Appropriate machine learning techniques for credit scoring and bankruptcy prediction in banking and

- finance: A comparative study. *Risk and Decision Analysis*, (Preprint):1–10.
- Breiman, L. (1996). Bagging predictors. *Machine learning*, 24(2):123–140.
- Breiman, L. (2001). Random forests. *Machine learning*, 45(1):5–32.
- Breiman, L., Friedman, J., Stone, C. J., and Olshen, R. A. (1984). *Classification and regression trees*. CRC press.
- Brown, I. and Mues, C. (2012). An experimental comparison of classification algorithms for imbalanced credit scoring data sets. *Expert Systems with Applications*, 39(3):3446–3453.
- Burez, J. and Van den Poel, D. (2009). Handling class imbalance in customer churn prediction. *Expert Systems with Applications*, 36(3):4626–4636.
- Bussmann, N., Giudici, P., Marinelli, D., and Papenbrock, J. (2021). Explainable machine learning in credit risk management. *Computational Economics*, 57(1):203–216.
- Buuren, S. v. and Groothuis-Oudshoorn, K. (2010). mice: Multivariate imputation by chained equations in r. *Journal of statistical software*, pages 1–68.
- Camino, R. D., Hammerschmidt, C. A., and State, R. (2019). Improving missing data imputation with deep generative models. *arXiv preprint arXiv:1902.10666*.
- Carey, M. and Hrycay, M. (2001). Parameterizing credit risk models with rating data. *Journal of banking & finance*, 25(1):197–270.
- Chawla, N. V., Bowyer, K. W., Hall, L. O., and Kegelmeyer, W. P. (2002). Smote: synthetic minority over-sampling technique. *Journal of artificial intelligence research*, 16:321–357.
- Cheema, J. R. (2014). A review of missing data handling methods in education research. *Review of Educational Research*, 84(4):487–508.

- Chen, N., Ribeiro, B., and Chen, A. (2016). Financial credit risk assessment: a recent review. *Artificial Intelligence Review*, 45(1):1–23.
- Chen, T. and Guestrin, C. (2016). Xgboost: A scalable tree boosting system. In *Proceedings of the 22nd acm sigkdd international conference on knowledge discovery and data mining*, pages 785–794.
- Choi, E., Biswal, S., Malin, B., Duke, J., Stewart, W. F., and Sun, J. (2017). Generating multi-label discrete patient records using generative adversarial networks. In *Machine learning for healthcare conference*, pages 286–305. PMLR.
- Cox, D. R. (1958). The regression analysis of binary sequences. *Journal of the Royal Statistical Society: Series B (Methodological)*, 20(2):215–232.
- Crosson, K., Bracke, P., and Jung, C. (2019). Explaining why the computer says ‘no’. *FCA*, 5:31.
- Dastile, X., Celik, T., and Potsane, M. (2020). Statistical and machine learning models in credit scoring: A systematic literature survey. *Applied Soft Computing*, 91:106263.
- Dempster, A. P., Laird, N. M., and Rubin, D. B. (1977). Maximum likelihood from incomplete data via the em algorithm. *Journal of the Royal Statistical Society: Series B (Methodological)*, 39(1):1–22.
- Dietterich, T. G. (2000). An experimental comparison of three methods for constructing ensembles of decision trees: Bagging, boosting, and randomization. *Machine learning*, 40(2):139–157.
- Donders, A. R. T., Van Der Heijden, G. J., Stijnen, T., and Moons, K. G. (2006). A gentle introduction to imputation of missing values. *Journal of clinical epidemiology*, 59(10):1087–1091.
- Dong, W., Fong, D. Y. T., Yoon, J.-s., Wan, E. Y. F., Bedford, L. E., Tang, E. H. M., and Lam, C. L. K. (2021). Generative adversarial networks for

- imputing missing data for big data clinical research. *BMC medical research methodology*, 21(1):1–10.
- Douzas, G. and Bacao, F. (2018). Effective data generation for imbalanced learning using conditional generative adversarial networks. *Expert Systems with applications*, 91:464–471.
- Drummond, C. and Holte, R. C. (2005). Severe class imbalance: Why better algorithms aren't the answer. In *European Conference on Machine Learning*, pages 539–546. Springer.
- Dua, D., Graff, C., et al. (2017). Uci machine learning repository.
- Duin, R. P. and Tax, D. M. (2000). Experiments with classifier combining rules. In *International Workshop on Multiple Classifier Systems*, pages 16–29. Springer.
- Ebenuwa, S. H., Sharif, M. S., Alazab, M., and Al-Nemrat, A. (2019). Variance ranking attributes selection techniques for binary classification problem in imbalance data. *IEEE Access*, 7:24649–24666.
- Enders, C. K. and Gottschall, A. C. (2011). Multiple imputation strategies for multiple group structural equation models. *Structural Equation Modeling*, 18(1):35–54.
- Engelmann, J. and Lessmann, S. (2021). Conditional wasserstein gan-based oversampling of tabular data for imbalanced learning. *Expert Systems with Applications*, 174:114582.
- Erichson, N. B., Mathelin, L., Kutz, J. N., and Brunton, S. L. (2019a). Randomized dynamic mode decomposition. *SIAM Journal on Applied Dynamical Systems*, 18(4):1867–1891.
- Erichson, N. B., Voronin, S., Brunton, S. L., and Kutz, J. N. (2019b). Randomized matrix decompositions using r. *Journal of Statistical Software*, 89(1):1–48.

- Erichson, N. B., Voronin, S., Brunton, S. L., and Kutz, J. N. (2019c). Randomized matrix decompositions using r. *Journal of Statistical Software*, 89(1):1–48.
- Falangis, K. and Glen, J. (2010). Heuristics for feature selection in mathematical programming discriminant analysis models. *Journal of the Operational Research Society*, 61(5):804–812.
- Fawcett, T. (2004). Roc graphs: Notes and practical considerations for researchers. *Machine learning*, 31(1):1–38.
- Fawcett, T. (2006). An introduction to roc analysis. *Pattern recognition letters*, 27(8):861–874.
- Finlay, S. (2011). Multiple classifier architectures and their application to credit risk assessment. *European Journal of Operational Research*, 210(2):368–378.
- Fiore, U., De Santis, A., Perla, F., Zanetti, P., and Palmieri, F. (2019). Using generative adversarial networks for improving classification effectiveness in credit card fraud detection. *Information Sciences*, 479:448–455.
- Fisher, R. A. (1936). The use of multiple measurements in taxonomic problems. *Annals of eugenics*, 7(2):179–188.
- Florez-Lopez, R. (2010). Effects of missing data in credit risk scoring. a comparative analysis of methods to achieve robustness in the absence of sufficient data. *Journal of the Operational Research Society*, 61(3):486–501.
- Florez-Lopez, R. and Ramon-Jeronimo, J. M. (2015). Enhancing accuracy and interpretability of ensemble strategies in credit risk assessment. a correlated-adjusted decision forest proposal. *Expert Systems with Applications*, 42(13):5737–5753.
- Friedman, J. H. (2001). Greedy function approximation: a gradient boosting machine. *Annals of statistics*, pages 1189–1232.

- Fu, K., Cheng, D., Tu, Y., and Zhang, L. (2016). Credit card fraud detection using convolutional neural networks. In *International Conference on Neural Information Processing*, pages 483–490. Springer.
- García, V., Marqués, A., and Sánchez, J. S. (2012). On the use of data filtering techniques for credit risk prediction with instance-based models. *Expert Systems with Applications*, 39(18):13267–13276.
- García, V., Marqués, A. I., and Sánchez, J. S. (2015). An insight into the experimental design for credit risk and corporate bankruptcy prediction systems. *Journal of Intelligent Information Systems*, 44(1):159–189.
- García-Laencina, P. J., Sancho-Gómez, J.-L., and Figueiras-Vidal, A. R. (2010). Pattern classification with missing data: a review. *Neural Computing and Applications*, 19(2):263–282.
- Geurts, P., Ernst, D., and Wehenkel, L. (2006). Extremely randomized trees. *Machine learning*, 63(1):3–42.
- Goodfellow, I., Pouget-Abadie, J., Mirza, M., Xu, B., Warde-Farley, D., Ozair, S., Courville, A., and Bengio, Y. (2014). Generative adversarial nets. *Advances in neural information processing systems*, 27:2672–2680.
- Guyon, I. and Elisseeff, A. (2003). An introduction to variable and feature selection. *Journal of machine learning research*, 3(Mar):1157–1182.
- Haixiang, G., Yijing, L., Shang, J., Mingyun, G., Yuanyue, H., and Bing, G. (2017). Learning from class-imbalanced data: Review of methods and applications. *Expert Systems with Applications*, 73:220–239.
- Halmich, C. (2020). *WGAIN: Data Imputation using Wasserstein GAIN*. PhD thesis, Universität Linz.
- Hammad Alharbi, H. and Kimura, M. (2020). Missing data imputation using data generated by gan. In *2020 the 3rd International Conference on Computing and Big Data*, pages 73–77.



- Hamori, S., Kawai, M., Kume, T., Murakami, Y., and Watanabe, C. (2018). Ensemble learning or deep learning? application to default risk analysis. *Journal of Risk and Financial Management*, 11(1):12.
- Han, H., Wang, W.-Y., and Mao, B.-H. (2005). Borderline-smote: a new over-sampling method in imbalanced data sets learning. In *International conference on intelligent computing*, pages 878–887. Springer.
- Hand, D. and Zhou, F. (2010). Evaluating models for classifying customers in retail banking collections. *Journal of the Operational Research Society*, 61(10):1540–1547.
- Hand, D. J. and Henley, W. E. (1997). Statistical classification methods in consumer credit scoring: a review. *Journal of the Royal Statistical Society: Series A (Statistics in Society)*, 160(3):523–541.
- Hastie, T., Tibshirani, R., and Friedman, J. (2009). The elements of statistical learning: data mining, inference, and prediction. pages 337–387.
- He, C., Ma, M., and Wang, P. (2020). Extract interpretability-accuracy balanced rules from artificial neural networks: A review. *Neurocomputing*, 387:346–358.
- He, H., Bai, Y., Garcia, E. A., and Li, S. (2008). Adasyn: Adaptive synthetic sampling approach for imbalanced learning. In *2008 IEEE international joint conference on neural networks (IEEE world congress on computational intelligence)*, pages 1322–1328. IEEE.
- He, H., Zhang, W., and Zhang, S. (2018). A novel ensemble method for credit scoring: Adaption of different imbalance ratios. *Expert Systems with Applications*, 98:105–117.
- Henley, W. and Hand, D. J. (1996). Ak-nearest-neighbour classifier for assessing consumer credit risk. *Journal of the Royal Statistical Society: Series D (The Statistician)*, 45(1):77–95.

- Hinton, G. E. and Salakhutdinov, R. R. (2006). Reducing the dimensionality of data with neural networks. *science*, 313(5786):504–507.
- Honaker, J., King, G., Blackwell, M., et al. (2011). Amelia ii: A program for missing data. *Journal of statistical software*, 45(7):1–47.
- Horton, N. J. and Kleinman, K. P. (2007). Much ado about nothing: A comparison of missing data methods and software to fit incomplete data regression models. *The American Statistician*, 61(1):79–90.
- Hu, S., Liang, Y., Ma, L., and He, Y. (2009). Msmote: Improving classification performance when training data is imbalanced. In *2009 second international workshop on computer science and engineering*, volume 2, pages 13–17. IEEE.
- Huang, J. and Ling, C. X. (2005). Using auc and accuracy in evaluating learning algorithms. *IEEE Transactions on knowledge and Data Engineering*, 17(3):299–310.
- Huang, Z., Chen, H., Hsu, C.-J., Chen, W.-H., and Wu, S. (2004). Credit rating analysis with support vector machines and neural networks: a market comparative study. *Decision support systems*, 37(4):543–558.
- Ibrahim, J. G., Chen, M.-H., Lipsitz, S. R., and Herring, A. H. (2005). Missing-data methods for generalized linear models: A comparative review. *Journal of the American Statistical Association*, 100(469):332–346.
- Jagtiani, J. and Lemieux, C. (2017). Fintech lending: Financial inclusion, risk pricing, and alternative information.
- Jain, A. K., Mao, J., and Mohiuddin, K. M. (1996). Artificial neural networks: A tutorial. *Computer*, 29(3):31–44.
- Japkowicz, N. (2000). The class imbalance problem: Significance and strategies. In *Proc. of the Int’l Conf. on Artificial Intelligence*, volume 56. Cite-seer.

- Jerez, J. M., Molina, I., García-Laencina, P. J., Alba, E., Ribelles, N., Martín, M., and Franco, L. (2010). Missing data imputation using statistical and machine learning methods in a real breast cancer problem. *Artificial intelligence in medicine*, 50(2):105–115.
- Jiang, Y. (2009). Credit scoring model based on the decision tree and the simulated annealing algorithm. In *2009 WRI World Congress on Computer Science and Information Engineering*, volume 4, pages 18–22. IEEE.
- Jolliffe, I. T. (1986). Principal components in regression analysis. In *Principal component analysis*, pages 129–155. Springer.
- Jordan, M. I. and Mitchell, T. M. (2015). Machine learning: Trends, perspectives, and prospects. *Science*, 349(6245):255–260.
- Kennedy, K. (2013). *Credit scoring using machine learning*. PhD thesis, Dublin Institute of Technology.
- Khoshgoftaar, T. M., Seiffert, C., Van Hulse, J., Napolitano, A., and Folleco, A. (2007). Learning with limited minority class data. In *Sixth International Conference on Machine Learning and Applications (ICMLA 2007)*, pages 348–353. IEEE.
- Kim, Y. S. and Sohn, S. Y. (2004). Managing loan customers using misclassification patterns of credit scoring model. *Expert Systems with Applications*, 26(4):567–573.
- Kline, R. B. (2015). *Principles and practice of structural equation modeling*. Guilford publications.
- Kotsiantis, S., Kanellopoulos, D., and Tampakas, V. (2006). On implementing a financial decision support system. *International Journal of Computer Science and Network Security*, 6(1a):103–112.
- Kullback, S. and Leibler, R. A. (1951). On information and sufficiency. *The annals of mathematical statistics*, 22(1):79–86.

- Kumar, P. R. and Ravi, V. (2007). Bankruptcy prediction in banks and firms via statistical and intelligent techniques—a review. *European journal of operational research*, 180(1):1–28.
- Lee, T.-S. and Chen, I.-F. (2005). A two-stage hybrid credit scoring model using artificial neural networks and multivariate adaptive regression splines. *Expert Systems with Applications*, 28(4):743–752.
- Lee, T.-S., Chiu, C.-C., Chou, Y.-C., and Lu, C.-J. (2006). Mining the customer credit using classification and regression tree and multivariate adaptive regression splines. *Computational Statistics & Data Analysis*, 50(4):1113–1130.
- Lessmann, S., Baesens, B., Seow, H.-V., and Thomas, L. C. (2015). Benchmarking state-of-the-art classification algorithms for credit scoring: An update of research. *European Journal of Operational Research*, 247(1):124–136.
- Li, C., Zhu, J., and Zhang, B. (2017). Max-margin deep generative models for (semi-) supervised learning. *IEEE transactions on pattern analysis and machine intelligence*, 40(11):2762–2775.
- Li, P., Stuart, E. A., and Allison, D. B. (2015). Multiple imputation: a flexible tool for handling missing data. *Jama*, 314(18):1966–1967.
- Liang, D., Tsai, C.-F., and Wu, H.-T. (2015). The effect of feature selection on financial distress prediction. *Knowledge-Based Systems*, 73:289–297.
- Lin, J. (1991). Divergence measures based on the shannon entropy. *IEEE Transactions on Information theory*, 37(1):145–151.
- Lin, W.-Y., Hu, Y.-H., and Tsai, C.-F. (2011). Machine learning in financial crisis prediction: a survey. *IEEE Transactions on Systems, Man, and Cybernetics, Part C (Applications and Reviews)*, 42(4):421–436.
- Little, R. J. and Rubin, D. B. (1989). The analysis of social science data with missing values. *Sociological Methods & Research*, 18(2-3):292–326.

- Little, R. J. and Rubin, D. B. (2019). *Statistical analysis with missing data*, volume 793. John Wiley & Sons.
- Liu, Y. and Schumann, M. (2005). Data mining feature selection for credit scoring models. *Journal of the Operational Research Society*, 56(9):1099–1108.
- Longadge, R. and Dongre, S. (2013). Class imbalance problem in data mining review. *arXiv e-prints*, pages arXiv–1305.
- Lundberg, S. M., Erion, G., Chen, H., DeGrave, A., Prutkin, J. M., Nair, B., Katz, R., Himmelfarb, J., Bansal, N., and Lee, S.-I. (2020). From local explanations to global understanding with explainable ai for trees. *Nature machine intelligence*, 2(1):56–67.
- Lundberg, S. M. and Lee, S.-I. (2017). A unified approach to interpreting model predictions. *Advances in Neural Information Processing Systems*, 30:4765–4774.
- Lyn, T., David, E. B., and Jonathan, C. N. (2002). Credit scoring and its applications. *Philadelphia: Society for Industrial and Applied Mathematics*.
- Makowski, P. (1985). Credit scoring branches out. *Credit World*, 75(1):30–37.
- Mani, I. and Zhang, I. (2003). knn approach to unbalanced data distributions: a case study involving information extraction. In *Proceedings of workshop on learning from imbalanced datasets*, volume 126.
- Mansour, Y. (1997). Pessimistic decision tree pruning based on tree size. In *MACHINE LEARNING-INTERNATIONAL WORKSHOP THEN CONFERENCE-*, pages 195–201. Citeseer.
- Marqués, A. I., García, V., and Sánchez, J. S. (2012). Exploring the behaviour of base classifiers in credit scoring ensembles. *Expert Systems with Applications*, 39(11):10244–10250.

- Marqués, A. I., García, V., and Sánchez, J. S. (2013). On the suitability of resampling techniques for the class imbalance problem in credit scoring. *Journal of the Operational Research Society*, 64(7):1060–1070.
- McCarthy, J., Minsky, M. L., Rochester, N., and Shannon, C. E. (2006). A proposal for the dartmouth summer research project on artificial intelligence, august 31, 1955. *AI magazine*, 27(4):12–12.
- McKnight, P. E., McKnight, K. M., Sidani, S., and Figueredo, A. J. (2007). *Missing data: A gentle introduction*. Guilford Press.
- Mirza, M. and Osindero, S. (2014). Conditional generative adversarial nets. *arXiv preprint arXiv:1411.1784*.
- Mitchell, T. M. et al. (1997). Machine learning. 1997. *Burr Ridge, IL: McGraw Hill*, 45(37):870–877.
- Müller, K.-R., Mika, S., Tsuda, K., and Schölkopf, K. (2018). An introduction to kernel-based learning algorithms. *Handbook of Neural Network Signal Processing*, pages 4–1.
- Munkhdalai, L., Munkhdalai, T., Namsrai, O.-E., Lee, J. Y., and Ryu, K. H. (2019). An empirical comparison of machine-learning methods on bank client credit assessments. *Sustainability*, 11(3):699.
- Murdoch, W. J., Singh, C., Kumbier, K., Abbasi-Asl, R., and Yu, B. (2019). Definitions, methods, and applications in interpretable machine learning. *Proceedings of the National Academy of Sciences*, 116(44):22071–22080.
- Myung, I. J. (2003). Tutorial on maximum likelihood estimation. *Journal of mathematical Psychology*, 47(1):90–100.
- Nanni, L. and Lumini, A. (2009). An experimental comparison of ensemble of classifiers for bankruptcy prediction and credit scoring. *Expert systems with applications*, 36(2):3028–3033.

- Nascimento, D. S., Coelho, A. L., and Canuto, A. M. (2014). Integrating complementary techniques for promoting diversity in classifier ensembles: A systematic study. *Neurocomputing*, 138:347–357.
- Nationalbank, O. (2004). *Guidelines on credit risk management: Rating models and validation*. Oesterreichische Nationalbank.
- Nazabal, A., Olmos, P. M., Ghahramani, Z., and Valera, I. (2020). Handling incomplete heterogeneous data using vaes. *Pattern Recognition*, 107:107501.
- Neagoe, V.-E., Ciotec, A.-D., and Cucu, G.-S. (2018). Deep convolutional neural networks versus multilayer perceptron for financial prediction. In *2018 International Conference on Communications (COMM)*, pages 201–206. IEEE.
- Ong, C.-S., Huang, J.-J., and Tzeng, G.-H. (2005). Building credit scoring models using genetic programming. *Expert Systems with Applications*, 29(1):41–47.
- Paleologo, G., Elisseeff, A., and Antonini, G. (2010). Subagging for credit scoring models. *European journal of operational research*, 201(2):490–499.
- Quinlan, J. R. (1986). Induction of decision trees. *Machine learning*, 1(1):81–106.
- Ratner, B. (2017). *Statistical and Machine-Learning Data Mining:: Techniques for Better Predictive Modeling and Analysis of Big Data*. CRC Press.
- Ravanbakhsh, M., Nabi, M., Sangineto, E., Marcenaro, L., Regazzoni, C., and Sebe, N. (2017). Abnormal event detection in videos using generative adversarial nets. In *2017 IEEE International Conference on Image Processing (ICIP)*, pages 1577–1581. IEEE.
- Rish, I. et al. (2001). An empirical study of the naive bayes classifier. In *IJCAI 2001 workshop on empirical methods in artificial intelligence*, volume 3, pages 41–46.

- Roderick, J., Little, A., and Rubin, D. B. (2002). *Statistical analysis with missing data*.
- Royston, P., White, I. R., et al. (2011). Multiple imputation by chained equations (mice): implementation in stata. *J Stat Softw*, 45(4):1–20.
- Rubin, D. B. (1976). Inference and missing data. *Biometrika*, 63(3):581–592.
- Ruiz-Chavez, Z., Salvador-Meneses, J., and Garcia-Rodriguez, J. (2018). Machine learning methods based preprocessing to improve categorical data classification. In *International Conference on Intelligent Data Engineering and Automated Learning*, pages 297–304. Springer.
- Russell, S. and Norvig, P. (2002). Artificial intelligence: a modern approach.
- Salgado, C. M., Azevedo, C., Proença, H., and Vieira, S. M. (2016). Missing data. *Secondary analysis of electronic health records*, pages 143–162.
- Schafer, J. L. (1997). *Analysis of incomplete multivariate data*. CRC press.
- Schapire, R. E. (1990). The strength of weak learnability. *Machine learning*, 5(2):197–227.
- Schlegl, T., Seeböck, P., Waldstein, S. M., Schmidt-Erfurth, U., and Langs, G. (2017). Unsupervised anomaly detection with generative adversarial networks to guide marker discovery. In *International conference on information processing in medical imaging*, pages 146–157. Springer.
- Seaman, S. R., Bartlett, J. W., and White, I. R. (2012). Multiple imputation of missing covariates with non-linear effects and interactions: an evaluation of statistical methods. *BMC medical research methodology*, 12(1):1–13.
- Seo, S., Jeon, Y., and Kim, J. (2018). Meta learning for imbalanced big data analysis by using generative adversarial networks. In *Proceedings of the 2018 International Conference on Big Data and Computing*, pages 5–9.
- Shah, A. D., Bartlett, J. W., Carpenter, J., Nicholas, O., and Hemingway, H. (2014). Comparison of random forest and parametric imputation models



- for imputing missing data using mice: a caliber study. *American journal of epidemiology*, 179(6):764–774.
- Shapley, L. S. (1953). A value for n-person games. *Contributions to the Theory of Games*, 2(28):307–317.
- Siddiqi, N. (2012). *Credit risk scorecards: developing and implementing intelligent credit scoring*, volume 3. John Wiley & Sons.
- Sirignano, J., Sadhwani, A., and Giesecke, K. (2016). Deep learning for mortgage risk. *arXiv preprint arXiv:1607.02470*.
- Smieja, M., Struski, L., Tabor, J., Zieliński, B., and Spurek, P. (2018). Processing of missing data by neural networks. *arXiv preprint arXiv:1805.07405*.
- Son, M., Jung, S., Moon, J., and Hwang, E. (2020). Bcgan-based over-sampling scheme for imbalanced data. In *2020 IEEE International Conference on Big Data and Smart Computing (BigComp)*, pages 155–160. IEEE.
- Srivastava, A., Valkoz, L., Russell, C., Gutmann, M., and Sutton, C. (2017). Veegan: Reducing mode collapse in gans using implicit variational learning. *Advances in Neural Information Processing Systems 30 (NIPS 2017) pre-proceedings*, 30.
- Stekhoven, D. J. and Bühlmann, P. (2012). Missforest—non-parametric missing value imputation for mixed-type data. *Bioinformatics*, 28(1):112–118.
- Šušteršič, M., Mramor, D., and Zupan, J. (2009). Consumer credit scoring models with limited data. *Expert Systems with Applications*, 36(3):4736–4744.
- Thomas, L. C. (2000). A survey of credit and behavioural scoring: forecasting financial risk of lending to consumers. *International journal of forecasting*, 16(2):149–172.

- Thomas, L. C., Oliver, R. W., and Hand, D. J. (2005). A survey of the issues in consumer credit modelling research. *Journal of the Operational Research Society*, 56(9):1006–1015.
- Troyanskaya, O., Cantor, M., Sherlock, G., Brown, P., Hastie, T., Tibshirani, R., Botstein, D., and Altman, R. B. (2001). Missing value estimation methods for dna microarrays. *Bioinformatics*, 17(6):520–525.
- Valera, I. and Ghahramani, Z. (2017). Automatic discovery of the statistical types of variables in a dataset. In *International Conference on Machine Learning*, pages 3521–3529. PMLR.
- Van der Maaten, L. and Hinton, G. (2008). Visualizing data using t-sne. *Journal of machine learning research*, 9(11).
- Vriens, M. and Melton, E. (2002). Managing missing data. *Marketing Research*, 14(3):12.
- Wang, G., Hao, J., Ma, J., and Jiang, H. (2011). A comparative assessment of ensemble learning for credit scoring. *Expert systems with applications*, 38(1):223–230.
- Wang, G., Ma, J., Huang, L., and Xu, K. (2012). Two credit scoring models based on dual strategy ensemble trees. *Knowledge-Based Systems*, 26:61–68.
- West, D. (2000). Neural network credit scoring models. *Computers & Operations Research*, 27(11-12):1131–1152.
- Wolpert, D. H. and Macready, W. G. (1997). No free lunch theorems for optimization. *IEEE transactions on evolutionary computation*, 1(1):67–82.
- Worth, A. P. and Cronin, M. T. (2003). The use of discriminant analysis, logistic regression and classification tree analysis in the development of classification models for human health effects. *Journal of Molecular Structure: THEOCHEM*, 622(1-2):97–111.

- Xia, Y., Liu, C., Da, B., and Xie, F. (2018). A novel heterogeneous ensemble credit scoring model based on bstacking approach. *Expert Systems with Applications*, 93:182–199.
- Xia, Y., Liu, C., Li, Y., and Liu, N. (2017). A boosted decision tree approach using bayesian hyper-parameter optimization for credit scoring. *Expert Systems with Applications*, 78:225–241.
- Xiao, H., Xiao, Z., and Wang, Y. (2016). Ensemble classification based on supervised clustering for credit scoring. *Applied Soft Computing*, 43:73–86.
- Xu, L., Skoularidou, M., Cuesta-Infante, A., and Veeramachaneni, K. (2019). Modeling tabular data using conditional gan. *Advances in Neural Information Processing Systems*, 32:7335–7345.
- Xu, L. and Veeramachaneni, K. (2018). Synthesizing tabular data using generative adversarial networks. *arXiv e-prints*, pages arXiv–1811.
- Yeh, C.-C., Lin, F., and Hsu, C.-Y. (2012). A hybrid kmv model, random forests and rough set theory approach for credit rating. *Knowledge-Based Systems*, 33:166–172.
- Yeh, I.-C. and Lien, C.-h. (2009). The comparisons of data mining techniques for the predictive accuracy of probability of default of credit card clients. *Expert Systems with Applications*, 36(2):2473–2480.
- Yeh, S.-H., Wang, C.-J., and Tsai, M.-F. (2015). Deep belief networks for predicting corporate defaults. In *2015 24th Wireless and Optical Communication Conference (WOCC)*, pages 159–163. IEEE.
- Yoon, J., Jordon, J., and Schaar, M. (2018). Gain: Missing data imputation using generative adversarial nets. In *International Conference on Machine Learning*, pages 5689–5698. PMLR.
- Yuan, Y. C. (2010). Multiple imputation for missing data: Concepts and new development (version 9.0). *SAS Institute Inc, Rockville, MD*, 49(1-11):12.

- Zentralbank, E. (2004). credit risk transfer by eu banks: activities, risks and risk management “. *European Central Bank Report, Frankfurt am Main*.
- Zhang, G., Wang, X., Li, R., Song, Y., He, J., and Lai, J. (2020). Network intrusion detection based on conditional wasserstein generative adversarial network and cost-sensitive stacked autoencoder. *IEEE Access*, 8:190431–190447.
- Zheng, M., Li, T., Zhu, R., Tang, Y., Tang, M., Lin, L., and Ma, Z. (2020). Conditional wasserstein generative adversarial network-gradient penalty-based approach to alleviating imbalanced data classification. *Information Sciences*, 512:1009–1023.
- Zieba, M., Tomczak, S. K., and Tomczak, J. M. (2016). Ensemble boosted trees with synthetic features generation in application to bankruptcy prediction. *Expert Systems with Applications*, 58:93–101.