



Research Article

## Watermelon Sorting Process by Frequency Identification and Artificial Neural Network

Komsan Wongkalasin and Teerapon Upachaban

Department of Mechanical Engineering, Faculty of Engineering, Nakhon Phanom University, Nakhon Phanom, Thailand

Wacharawish Daosawang

Department of Electrical Engineering, Faculty of Technology, Udon Thani Rajabhat University, Udon Thani, Thailand

Nattadon Pannucharoenwong\* and Phadungsak Ratanadecho

Department of Mechanical Engineering, Faculty of Engineering, Thammasat School of Engineering, Thammasat University, Phatumthani, Thailand

\* Corresponding author. E-mail: pnattado@engr.tu.ac.th DOI: 10.14416/j.asep.2021.12.004

Received: 12 July 2021; Revised: 31 July 2021; Accepted: 23 August 2021; Published online: 28 December 2021

© 2021 King Mongkut's University of Technology North Bangkok. All Rights Reserved.

### Abstract

This research aims to enhance the watermelon's quality selection process, which was traditionally conducted by knocking the watermelon fruit and sort out by the sound's character. The proposed method in this research is generating the sound spectrum through the watermelon and then analyzes the response signal's frequency and the amplitude by Fast Fourier Transform (FFT). Then the obtained data were used to train and verify the neural network processor. The result shows that, the frequencies of 129 and 172 Hz were suit to be used in the comparison. Thirty watermelons, which were randomly selected from the orchard, were used to create a data set, and then were cut to manually check and match to the fruits' quality. The 129 Hz frequency gave the response ranging from 13.57 and above in 3 groups of watermelons quality, including, not fully ripened, fully ripened, and close to rotten watermelons. When the 172 Hz gave the response between 11.11–12.72 in not fully ripened watermelons and those of 13.00 or more in the group of close to rotten and hollow watermelons. The response was then used as a training condition for the artificial neural network processor of the sorting machine prototype. The verification results provided a reasonable prediction of the ripeness level of watermelon and can be used as a pilot prototype to improve the efficiency of the tools to obtain a modern-watermelon quality selection tool, which could enhance the competitiveness of the local farmers on the product quality control.

**Keywords:** Watermelon ripeness, Fruit, Quality assessment, Acoustic vibration, Artificial neural network

### 1 Introduction

Thailand is an agricultural country with 34% of the population employed in agriculture [1], with rice being the most cultivated main crop. These plantations have to total combined area of 67 million hectares of arable land which accounted for 11.3% of the nationwide area [2]. After the harvest season, farmers often have areas for cultivating other crops that use less water to effectively

utilized rice fields to increase income outside the farming season. Watermelon is a popular type of plant that farmers in the Si Songkhram district Nakhon Phanom Province grow as a complementary crop due to the area's favorable topography and climate. For this reason, many large networks of watermelon farmers were established in this area. It is therefore important to raise the standard of cultivation and to strengthen the farmers in the area until they are capable

of exporting 6,000 t of watermelon per year which are equated to an income of 60–80 million baht per year.

Farmers can cultivate watermelons well, but still have problems in quality selection before distribution, which still requires experienced labor to observe the size and the ripeness of the watermelons to avoid affecting yield prices and consumer confidence [3].

In the past, efforts have been made to develop a tool for sorting the quality of watermelon, such as a set of devices to measure the sound frequency produced by tapping watermelon and to find the relationship of the sound frequency with the quality of the watermelon [4], [5]. Later on, the tapped sound frequency was developed to make it easier to compare the quality by converting the output sound signal into the spectrum of the frequency using the Fast Fourier Transform Method (FFT) [3], [6]–[11]. Additionally, a device was also developed to measure the vibration of watermelon caused by tapping [12]–[15], both of which gave the same accuracy as possible.

Product quality assessment technology using non-destructive techniques It is part of post-harvest management which is gaining more and more attention today. Because the quality can be assessed quickly and will not damage the output. Along with satisfactory results, this led to the development of an automatic quality sorter and an online detection system [16] and the management of large amounts of data and various variables for quality assessment. Neural network type control methods have been used which can detect patterns and correlations of data, and learn or be trained to verify product quality in the industry. In addition to the agricultural industry, neural network methods have been widely adopted, such as classifying or modelling the relationships between the primary and other dependent variables [17]–[20].

In this research, the researcher has studied the method for developing the device by transmitting the appropriate sound frequency through the watermelon fruit. Then the sound waves traveling through the watermelons fruit were measured and analyzed for the signals that were passed through. This was done by converting the signal obtained by the Fourier transform method into the amplitude of the sound wave. The values were determined as variables for the training of neural networks to learn and memorize to sort the watermelons with different ripeness levels

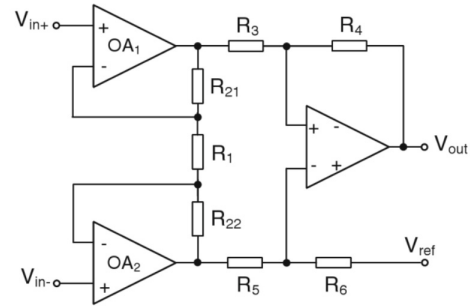


Figure 1: Instrumentation amplifiers circuit [21].

## 2 Materials and Methods

### 2.1 Operating principle for the prototype watermelon sorting machine

The prototype sorter developed has a working principle: amplifying the electrical signal of the wave to the desired size so that the wave can travel through the watermelon. It uses Operational amplifiers (op-amps) to amplify electrical signals. In amplifying electrical signals by using an instrumentation amplifier circuit (Instrumentation amplifier), which is a device with a high rate of electrical signal amplification. It can amplify small electrical signals with low noise. The circuit consists of 3 op-amps, the first part is the difference signal amplifier  $V_{in+}$  and  $V_{in-}$ , then amplifies the difference signal  $V_{out}$  as shown in Equation (1) and Figure 1 shows the instrumentation amplifier circuit [21].

$$A_v = \frac{V_{out}}{V_{in+} - V_{in-}} = \left(1 + \frac{2R_{21}}{R_1}\right) \frac{R_4}{R_3} \quad (1)$$

where

$A_v$  = the rate of amplification

$V_{out}$  = the output signal amplified by the op-amps (Volt: V)

$V_{in+}, V_{in-}$  = the signal before entering the op-amps

$R_1, R_{21} = R_{22}, R_3 = R_5, R_4 = R_6$

= the external resistance of the op-amps (Ohm:  $\Omega$ )

When transmitting an electrically amplified sound frequency through a melon fruit, the transmitted audio frequency signal is analyzed by converting the signal obtained using Fast Fourier Transform (FFT) to the amplitude of the sound wave [22], [23] as shown in Equation (2).

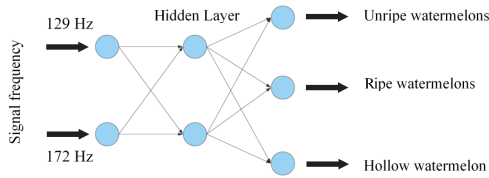


Figure 2: Feed-forward neural network model.

$$x[n] = \frac{1}{N} \sum_{k=0}^{N-1} X[k] e^{2\pi i n k / N} \quad n = 0, \dots, N-1 \quad (2)$$

where

$X[k]$  = the size of conversion domain

$x[n]$  = the size of signal in different frequency range measured randomly

The different amplitudes will serve as a database to train neural networks to be used in watermelon sorting. In this research, the feed-forward neural network is used to assign data from the input layer to the hidden layer and send it to the output layer in the same direction as data flow. The data processed in the amplifier circuit is transmitted in one direction from input and forward to output without any reverse of the data as shown in Figure 2.

In each layer, the data is passed through a simulated actuator function up to the output layer to determine the error value between the data in the output layer and the desired value. The Logistic sigmoid function with the maximum value of 1 [(Equation (3))], which being plotted in Figure 3, was applied. In the practice to adjust neuron network weight, when the actual network weight is close to the desired value, the training is stopped and the network weight is recorded. The variable used to train neural networks is the minimum required error (Goal) [17], [18].

$$f(x) = \frac{1}{1 + e^{-x}} \quad (3)$$

where

$f(x)$  = Logistic sigmoid function

$e \approx 2.71828$

## 2.2 Component of watermelon sorting machine

The watermelon sorter has 4 main parts including: frequency signal source, signal amplifier, frequency transmitter, and receiver unit. All display parts will be operated by the program developed by the

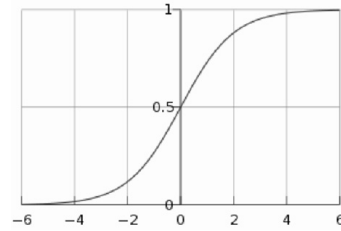


Figure 3: Logistic sigmoid function.

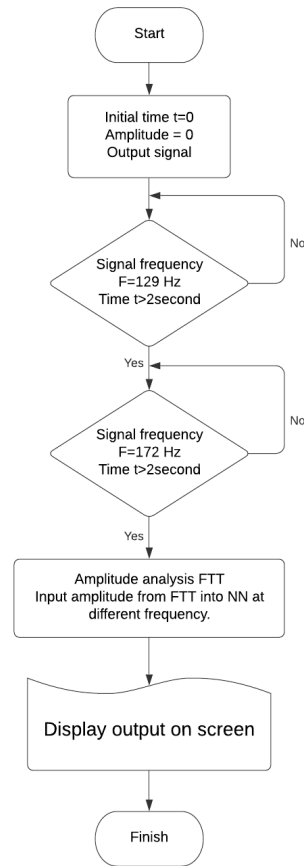
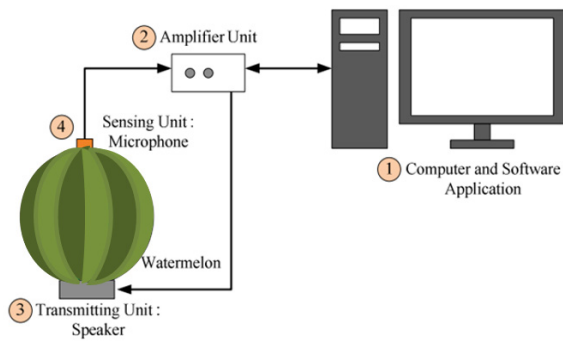


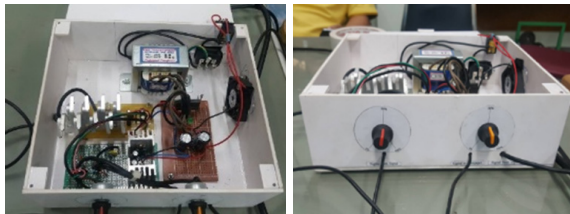
Figure 4: Programing process for watermelon sorting operation.

research team. Figure 4 shows the working process of the program for sorting watermelon.

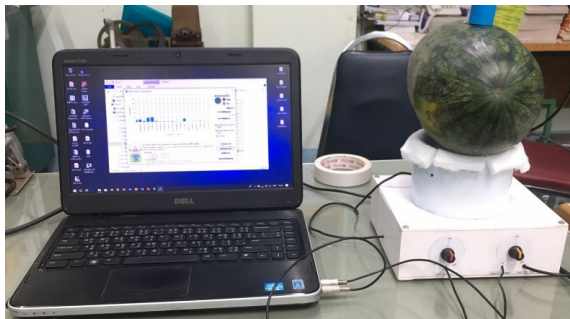
The working principle of the watermelon sorter is comprised of generating the signals by a computer program software application, which was developed via visual studio 2017, and using NAudio library to interface with the computer’s sound card (Figure 5 part 1). Then the signal was sent to the amplification unit



**Figure 5:** Principle operation of the sorting machine [10].

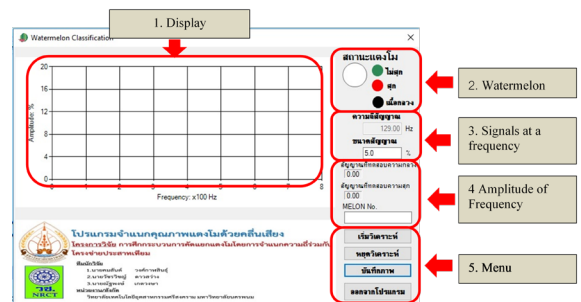


**Figure 6:** Signal amplifying unit and input/output frequency.



**Figure 7:** Input/output signal emitter.

(Figure 5 part 2 and Figure 6) to adjust the signal frequency accordingly. The frequency signal is sent out to the speakers, produces sound waves, and then passes through the melon. The transmitted signal was generated by a speaker as the signal transmitting unit. The speaker has a response frequency range of 0–20 kHz, an impedance of 4  $\Omega$ , and a maximum power of 20 W (Figure 5 part 3 and Figure 7). The audio receiver was attached to the other side of the fruit to detect the sound spectrum transformed through the watermelon (Figure 5 part 4) and sent back for analysis by the developed program to classify the quality of watermelon using



**Figure 8:** Display watermelon categorizing data in computer program.

the neural network. The results were displayed on the computer screen (Figure 8).

### 3 Results and Discussion

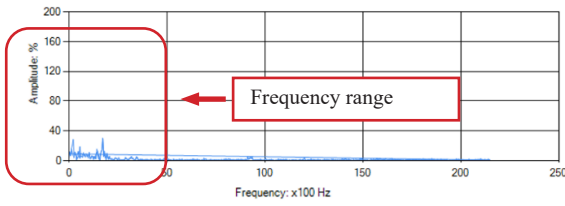
In this experiment, the Kinaree watermelon, which is one of the most popular varieties in Thailand was studied. The fruits were oval in shape and have the weight range of 1.1–2 kg.

#### 3.1 Finding the response frequency range

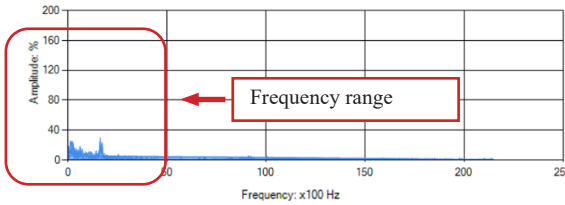
Initially, the natural frequency of the watermelon was used. Based on studies by Fang Wang and his colleagues [24], external vibrations were applied to the watermelon, and results were measured with acceleration transmissibility. The highest values were 35.125 and 77.034 Hz, which are both considered natural frequencies of watermelon. Therefore, in the experiment for the response frequency, 35 and 77 Hz signals (close to the natural frequency) were used to determine the range of the response.

Experimental results to find the response frequency range considering the amplitude of the input signal as shown in Figures 9 and 10.

Figures 9 and 10 showed that when transmitting at 35 and 77 Hz, the amplitude of the output frequency signal occurs at the frequency range from 0 to 4000 Hz. The response frequency range is the same regardless of the type of signal; transverse or longitudinal frequency of the watermelon. However, this preliminary trial can only find amplitude in a specific frequency range, but could not show the quality of the watermelon. So further experiments on the effect of the quality of the watermelon need to be tested.

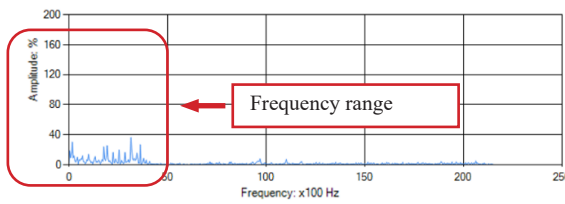


(a) Frequency response signal along the width of watermelon

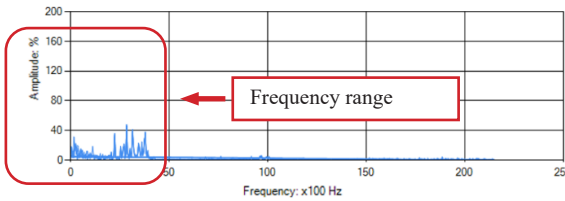


(b) Frequency response signal along the length of watermelon

Figure 9: Frequency range of 35 Hz.



(a) Frequency response signal along the width of watermelon



(b) Frequency response signal along the length of watermelon

Figure 10: Frequency range of 77 Hz.

### 3.2 Find the frequency in the frequency response range that affects the quality of watermelon

The response was found in the low-frequency range experiment, and Chyung Ay's study [3] by tapping the watermelon and measuring the frequency signal, it was found that the ripe watermelon had the highest amplitude at the frequency. Average  $172.62 \pm 9.21$  Hz.

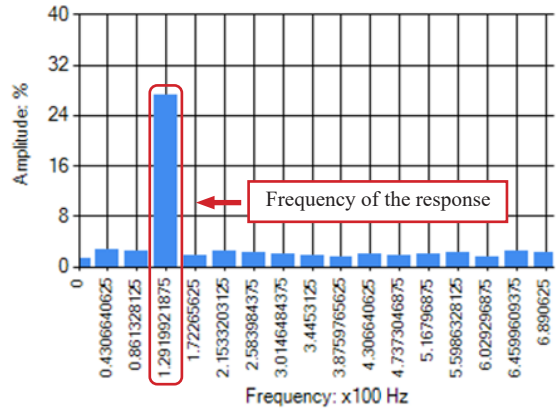


Figure 11: Amplitude value at a signal frequency of 129 Hz.

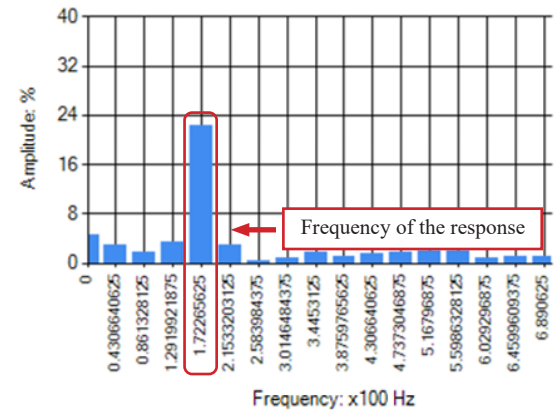


Figure 12: Amplitude value at a signal frequency of 172 Hz.

Not fully ripe watermelons occurred averaging  $174.20 \pm 9.88$  Hz and hollow watermelons occurred on average at  $137.77$  Hz. This is consistent with Diezma IB *et al.* [7] vibration of watermelons and frequency signals were measured. It was found that good quality melon resonated sound frequency 172 Hz and hollow watermelon at 129 Hz. Therefore, the frequency response reflecting watermelon's quality was determined within the frequency range of 100 to 200 Hz. The system sent signals at a frequency of 21 Hz, starting at 100 Hz and in 5 Hz increments up to 200 Hz.

Figure 11 demonstrated results at the frequency of 125 to 140 Hz where the amplitude is highest at 129 Hz. Figure 12 demonstrated results at a frequency range of 165 to 180 Hz where the amplitude is clearly high at 172 Hz. In this research, 129 Hz and 172 Hz

**Table 1:** Experimental result at the frequencies of 129 and 172 Hz

No.	Weight	Amplitude (129 Hz)				Amplitude (172 Hz)			
	kg	1	2	3	Avg.	1	2	3	Avg.
1	1.7	15.81	15.12	14.87	15.27	12.22	12.47	12.56	12.42
2	1.9	12.45	13.39	13.88	13.24	10.81	11.07	11.45	11.11
3	2.0	14.25	14.21	11.88	13.45	16.21	16.72	16.75	16.56
4	1.6	15.25	14.89	15.55	15.23	12.87	12.5	12.8	12.72
5	1.8	12.04	12.32	13.93	12.76	15.11	14.41	16.23	15.25
6	1.5	23.15	27.55	28.39	26.36	19.95	20.75	20.92	20.54
7	2.0	33.61	34.01	32.26	33.29	30.49	30.99	29.26	30.25
8	1.1	18.55	18.97	18.98	18.83	15.75	15.71	15.8	15.75
9	1.6	14.83	16.54	16.5	15.96	12.33	12.78	12.93	12.68
10	1.7	12.77	13.83	14.17	13.59	14.14	14.38	14.18	14.23
11	1.7	15.94	16	14.93	15.62	11	11.39	10.87	11.09
12	1.7	12.92	13.67	13.01	13.20	15.32	16.69	17.79	16.60
13	1.7	9.3	11.67	9.86	10.28	13.22	10.25	10.52	11.33
14	1.7	15.8	11.37	14.06	13.74	18.59	16.28	16.98	17.28
15	1.6	10.62	11.71	12.03	11.45	10.41	10.64	10.37	10.47
16	1.7	10.88	11.86	13.03	11.92	12.09	12.16	12.67	12.31
17	1.5	11.79	12.03	11.99	11.94	14.75	16.19	16.53	15.82
18	1.8	14.41	14.09	13.77	14.09	13.63	13.93	13.83	13.80
19	1.6	13.29	12.75	12.47	12.84	19.96	21.38	22.6	21.31
20	1.6	16.6	15.27	15.05	15.64	11.6	13.63	13.18	12.80
21	1.6	16.35	16.33	16.57	16.42	11.7	10.8	10.3	10.93
22	1.9	14.36	14.83	14.9	14.70	15.32	15.81	16.1	15.74
23	1.7	19.97	17.74	18.72	18.81	13.18	16.19	16.75	15.37
24	2.0	12.68	13.91	14.4	13.66	13.75	14.51	13.95	14.07
25	1.9	12.86	13.29	13.3	13.15	16.18	16.19	16.53	16.30
26	2.0	16.81	18.7	18.91	18.14	14.39	15.02	15.41	14.94
27	1.7	15.18	13.52	14.04	14.25	11.93	12.32	12.6	12.28
28	1.8	12.12	12.4	12.53	12.35	11.51	11.47	11.55	11.51
29	1.6	18.54	17.52	19.33	18.46	13.58	13.53	13.61	13.57
30	1.6	12.5	12.18	12.64	12.44	10.02	10.51	10.73	10.42

signals were used to transmit the signal into the melon fruit and to consider the difference in the amplitudes of the reflected frequency signals to determine the quality of the watermelon. In transmission, the frequency signal is transmitted at 2 s per frequency signal to find the average value of the amplitude.

### 3.3 Finding the response to categorize watermelon's quality

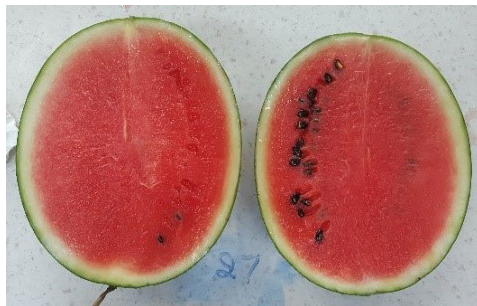
From Table 1, after the sound spectrum at the frequency of 129 Hz and 172 Hz were transmitted through the melon fruits, the output signal in each case was then transformed by FFT to study its amplitude and, then, was used as the indicator to classify the

watermelon quality. In this research, the quality of watermelons was divided into 3 characteristics: 1) not fully ripe watermelon, 2) fully ripe watermelon, and 3) near rotten watermelon as shown in Figure 13.

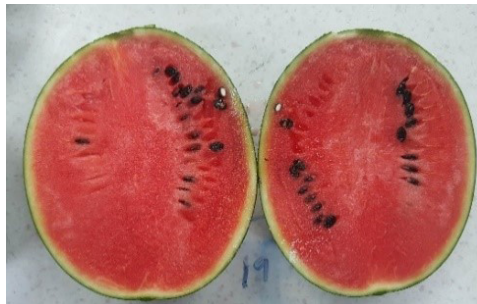
In the experiment, 30 watermelons were exposed to a frequency of 2 s for 3 repetitions per frequency per watermelon to ensure reproducibility. The average amplitudes were obtained and compared with the quality of watermelons by cutting watermelons to observe quality within the fruit watermelon. From the test results for sorting watermelon quality Screening with a machine that matches the cut to accurately see the meat inside the watermelon. The number of watermelons in the test was small, therefore, unable to fully tell about the accuracy of the machine.



(a) Not fully ripe watermelon  
(13.45 at 129 Hz and 11.67 at 179 Hz)



(b) Ripe watermelon  
(15.04 at 129 Hz and 15.59 at 179 Hz)



(c) Near rotten watermelon  
(29.83 at 129 Hz and 25.40 at 179 Hz)

**Figure 13:** Cross-sectional images of different stages of watermelon growth: (a) Not fully ripe watermelon, (b) Ripe watermelon, and (c) Near rotten watermelon with average amplitude.

From Table 2, the results were as follows.

1) The number of not fully ripe watermelons was 11, the highest, lowest and average amplitudes at 129 Hz were 15.95, 10.28 and 13.45, respectively, and at 172 Hz the amplitudes were 12.72, 10.42 and 11.67.

2) There were 16 ripe watermelons, the highest, lowest and average amplitudes at 129 Hz were 18.83, 11.94 and 15.04, respectively, and at 172 Hz were 21.31, 13.57 and 15.59, respectively.

3) Near rotten watermelon, the highest, lowest and average amplitudes at 129 Hz were 33.29, 26.36 and 29.83, respectively, and at 172 Hz the amplitude was 30.25, 20.54 and 25.40, respectively.

**Table 2:** Quality of the watermelon and the effect of the amplitude at frequencies of 129 Hz and 172 Hz

Quality inside the watermelon	Amount (fruits)	129 Hz	172 Hz
Not fully ripe watermelons	11	Max.	Max.
		15.95	12.72
		Min.	Min.
		10.28	10.42
		Avg.	Avg.
13.45	11.67		
Ripe watermelons	16	Max.	Max.
		18.83	21.31
		Min.	Min.
		11.94	13.57
		Avg.	Avg.
15.04	15.59		
Near rotten watermelon	2	Max.	Max.
		33.29	30.25
		Min.	Min.
		26.36	20.54
		Avg.	Avg.
29.83	25.40		

### 3.4 Neural network training

The frequency response values of 129 Hz and 172 Hz are fed to the network input layer. The weight obtained from training is used to calculate the system output. The number of nodes in the network output layer is equal to the watermelon quality classification. In this research, only ripe watermelon, not fully ripe watermelon, and near rotten watermelon were defined, as shown in Table 3. The separation of the quality will use the resulting amplitude.

**Table 3:** Output value demonstrating the quality of watermelon

Quality of Watermelon	Value of Designated Output
Ripe watermelon	[1; 0; 0]
Not fully ripe watermelon	[0; 1; 0]
Near rotten watermelon	[0; 0; 1]

### 3.5 Testing the function of the prototype watermelon sorter

In the screening test, 30 watermelons were used and the results were compared between the sorter and the actual internal meat. From the test results, the results were consistent with the dissection to see the meat inside the watermelon correctly. But because the number of watermelons in the test was small, it was impossible to fully tell the accuracy of the machine.

## 4 Discussion and Conclusions

From the experimental results in Table 2, considering the amplitude, it can be seen that at the frequency of 172 Hz the not fully ripe watermelon demonstrated the highest value (Max.12.72). This was less than the minimum value obtained from ripe watermelon (Min. 13.57). From the sample, there were only 2 watermelons that demonstrated the lowest value which were only slightly less than the maximum ripe watermelon. But considering the maximum value, there was a noticeable difference. It was observed that at 172 Hz, the very high amplitude indicates that the watermelon is near rotten. However, when considering the amplitude at 129 Hz, the tendency of the amplitude is the same as that at the frequency 179 Hz where the rotten watermelon is the highest. This was followed by ripe watermelon and the watermelon that is not fully ripe, respectively. The quality of watermelon is classified by the average amplitude values. The near rotten watermelon was 25.40, which was higher than the ripe watermelon 15.59 and the not fully ripe watermelon averaged at 11.67, which is the lowest value. This is consistent with research by Rouzbeh, *et al.* [12] which low-frequency range was applied to predict the degree of ripening of watermelon by producing frequency through melon fruit, then, measure the vibration frequency with laser doppler vibrometer and analyzing the signal value with FFT. Ripe watermelon had a higher FFT magnitude than the raw fruit. Another study in line with this research is a study by Ay [3], that predicted the ripening of watermelon by tapping on the fruit and using a microphone to pick up the sound frequency signal to compare the quality of watermelon. It was found that the ripe watermelon had the highest amplitude at the frequency of  $172.62 \pm 9.21$  Hz, and the highest amplitude of not fully ripe watermelons

occurred at  $174.20 \pm 9.88$  Hz.

According to previous research, the response of watermelons to sound wave depends on the mechanical characteristics of the pulp and the shape of the fruit [11]. The structure of watermelons harvested in each area has different species which may have different mechanical characteristics, such as the density of watermelon pulp, skin thickness, shape of the fruit, etc. Therefore, the scope of study was identified only for Kinaree watermelons that are commonly grown in the research area with the weight range of 1.1–2.0 kg, as shown in Table 1. If the tools used in this research are to be applied to other watermelon species, further specific studies are needed to improve the conditions for assessing the ripeness levels.

Although there were a lot of high-performance and cutting-edge techniques in neural network processing [19], [20], feed-forward neural network still suitable for this research, which the incoming data flows in one direction and due to few variables was considered. Using Neural Network to sort the quality of watermelon, ripe watermelon was correctly classified according to the parameters used in the neural network training. This information can add other variable data to be used in various sorting without limit depending on the number of samples. The study of the process of sorting watermelon by frequency classification in combination with the neural network was a guideline for solving the problem of sorting watermelon's quality. This new frequency signal emission technology can be used to support the traditional sorting technique, which was by tapping and listening to the sound, which was originally tapped to listen to the sound, was sent a frequency through the watermelon and then detected the reflected frequency signal. The signal values were mathematically converted to data as a learning condition for the neural network to extract the quality of the reflected wave properties by determining the quality. Therefore, the new technology is more reliable than the traditional method. Using the sorting tool will help to increase consumer confidence in the purchase of watermelon and can be used as a standard for certifying the quality of watermelon produced for sale in the future.

### Acknowledgments

This study was supported by the Program Management Unit for Human Resources & Institutional Development,



Research and Innovation, NXPO (grant number B05F630092) and Thailand Science Research and Innovation Fundamental Fund (Project No. 66082) and this research was funded by the National Research Council of Thailand (NRCT), funded by the Fiscal Year 2018 Research Fund, Nakhon Phanom University and Faculty of Engineering, Thammasat School of Engineering, Thammasat University was acknowledge.

## References

- [1] N. Pannucharoenwong, A. Worsanen, C. Benjapiyapom, J. Jongpluempiti, and P. Vengsungnle, "Comparison of bio-methane gas wobble index in different animal manure substrate," *Energy Procedia*, vol. 138, pp. 273–277, Oct. 2017.
- [2] S. Hemathulin, T. Lasopha, N. Pannucharoenwong, P. Rattanadecho, S. Echaroj, and A. Phongsavath, "Effect of the orientation of the rice seed swivel disc on the seed consumption rate of the dry paddy field sowing machine," *Journal of Research and Applications in Mechanical Engineering*, vol. 7, no. 2, pp. 112–121, Nov. 2019.
- [3] C. Ay, "Acoustic evaluation of watermelon internal quality-maturity, cavity existence and orientation," *Journal of Agriculture Science*, vol. 5, no. 4, pp. 57–69, 1996.
- [4] Y. Takeda, M. Sawaji, and J. Yasukawa, "The non-destructive measurement of ripeness of apples by sonic characteristics," *Nippon Shokukin Kogyo Gakkaishi (Japan)*, vol. 17, no. 8, pp. 358–360, 1970.
- [5] H. Yamamoto, M. Iwamoto, and S. Haginuma, "Acoustic impulse response method for measuring natural frequency of intact fruits and preliminary applications to internal quality evaluation of apples and watermelons," *Journal of Texture Studies*, vol. 11, no. 2, pp. 117–136, Jun. 1980.
- [6] R. Abbaszadeh, A. Moosavian, A. Rajabipour, and G. Najafi, "An intelligent procedure for watermelon ripeness detection based on vibration signals," *Journal of Food Science and Technology*, vol. 52, pp. 1075–1081, 2015.
- [7] B. Diezma-Iglesias, C. Valero, F. J. Garcia-Ramos, and M. Ruiz-Altisent, "Monitoring of firmness evolution of peaches during storage by combining acoustic and impact methods," *Journal of Food Engineering*, vol. 77, pp. 926–935, 2006.
- [8] F. Khoshnam, M. Namjoo, and H. Golbakhshi, "Acoustic testing for melon fruit ripeness evaluation during different stages of ripening," *Agriculturae Conspectus Scientificus*, vol. 80, no. 4, pp. 197–204, 2015.
- [9] W. Zeng, X. Huang, S. M. Arisona, and I. V. McLoughlin, "Classifying watermelon ripeness by analysing acoustic signals using mobile devices," *Personal and Ubiquitous Computing*, vol. 18, no. 7, pp. 1753–1762, 2014.
- [10] W. Daosawang, K. Wongkalasin, and N. Katewongsa, "A study sound absorption for ripeness and unripe classification of watermelon," in *8th International Electrical Engineering Congress (iEECON)*, 2020, doi: 10.1109/iEECON48109.2020.229521.
- [11] C. Ding, Z. Feng, D. Wang, D. Cui, and W. Li, "Acoustic vibration technology: Toward a promising fruit quality detection method," *Comprehensive Reviews In Food Science And Food Safety*, vol. 20, pp. 1655–1680, 2021.
- [12] A. Rouzbeh, R. Ali, M. Mohammad, D. Mojtaba, and A. Hojjat, "Evaluation of watermelons texture using their vibration responses," *Biosystems Engineering*, vol. 115, pp. 102–105, 2013.
- [13] A. Rouzbeh, M. Ashkan, R. Ali, and N. Gholamhassan, "An intelligent procedure for watermelon ripeness detection based on vibration signals," *Journal of Food Science and Technology*, vol. 52, no. 2, pp. 1075–1081, Jun 2013.
- [14] I. B. Diezma, M. Ruiz-Altisent, and P. Jancsó, "Vibrational analysis of seedless watermelons: Use in the detection of internal hollows," *Spanish Journal of Agricultural Research*, vol. 3, no. 1, pp. 52–60, Mar. 2005.
- [15] O. Gomonwattanapanich, N. Pannucharoenwong, P. Rattanadecho, S. Echaroj, and S. Hemathulin, "Vibration control of vehicle by active suspension with LQG algorithm," *International Journal of Automotive and Mechanical Engineering (IJAME)*, vol. 17, no. 2, pp. 8011–8018, 2020.
- [16] M. M. Alia, N. Hashima, S. K. Bejoa, and R. Shamsudin, "Rapid and nondestructive techniques for internal and external quality evaluation of watermelons: A review," *Scientia Horticulturae*, vol. 225, pp. 689–699, Nov. 2017.
- [17] F. Dara and A. Devolli, "Applying artificial neural networks (ANN) techniques to automated

- visual apple sorting,” *Journal of Hygienic Engineering and Design*, vol. 17, pp. 55–63, 2016.
- [18] M. S. B. S. Rizam, A. R. F. Yasmin, M. Y. A. Ihsan, and K. Shazana, “Non-destructive watermelon ripeness determination using image processing and artificial neural network (ANN),” *World Academy of Science, Engineering and Technology*, vol. 50, pp. 538–542, 2009.
- [19] S. Wang, Y. Zhang, Z. Dong, S. Du, G. Ji, J. Yan, J. Yang, Q. Wang, C. Feng, and P. Phillips, “Feed-forward neural network optimized by hybridization of PSO and ABC for abnormal brain detection,” *International Journal of Imaging Systems and Technology*, vol. 25, no. 2, pp. 153–164, 2015.
- [20] S. Wang, Y. Zhang, G. Ji, J. Yang, J. Wu, and L. Wei, “Fruit classification by wavelet-entropy and feedforward neural network trained by fitness-scaled chaotic ABC and biogeography-based optimization,” *Entropy*, vol. 17, pp. 5711–5728, 2015.
- [21] R. Wu, J. H. Huijsing, and K. A. Makinwa, *Precision Instrumentation Amplifiers and Read-Out Integrated Circuits*. New York: Springer Science+Business Media, 2013.
- [22] R. Phoophuangpairaj, “Automated classification of watermelon quality using non-flicking reduction and HMM sequences derived from flicking sound characteristics,” *Journal of Information Science and Engineering*, vol. 30, pp. 1015–1030, 2014.
- [23] R. Abbaszadeh, A. Rajabipour, M. H. Delshad, M. J. Mahjub, and H. Ahmadi, “Prediction of watermelon consumer acceptability based on vibration response spectrum,” *International Journal of Agricultural and Biosystems Engineering*, vol. 5, no. 6, pp. 365–368, 2011.
- [24] F. Wang, S. Ma, and W. Wei, “Frequency sweep test and modal analysis of watermelon during transportation,” *International Journal of Food Engineering*, vol. 13, no. 5, p. 10, 2017.