

Increase in Visibility of Light Signals

Pablo Ixtaina¹, Matías Presso² & Gustavo Marín²

¹ Laboratorio de Acústica y Luminotecnia de la Comisión de Investigaciones, Científicas de la Provincia de Buenos Aires LAL CIC, Argentina

² Instituto de Investigación en Tecnología Informática Avanzada INTIA – UNCPBA, Argentina

Correspondence: Pablo Ixtaina, Laboratorio de Acústica y Luminotecnia de la Comisión de Investigaciones Científicas, Camino Centenario y 506, Gonnet, Argentina. Tel: 54-221-484-2686. E-mail: pixtaina@yahoo.com

Received: April 2, 2015 Accepted: April 14, 2015 Online Published: April 23, 2015

doi:10.5539/mer.v5n1p35

URL: <http://dx.doi.org/10.5539/mer.v5n1p35>

Abstract

This work describes a study of perception of light signals used in aeronautics. Devices known as “obstruction light” (L-810 type, according to the Organization of International Civil Aviation OACI and the Federal Aviation Administration FAA) with LED technology were fed with square pulses of voltage, attaining flashes with imperceptible rise times. The lights were presented to observers, simulating the habitual vision conditions for these devices.

With this diagram, perceptive comparisons for different flash frequencies were carried out, exploring especially the transition zone between flickering and steady vision of light. The test showed that an important number of people experienced a perceptive increase in such transition zone. The phenomenon, which can be related with to Broca-Sulzer effect, could be used in order to improve the signal visibility.

Keywords: visual perception, pulsing light, leds, signal, sensation, intensity

1. Introduction

When the frequency of a periodic luminous stimulus is lower than certain value, the visual system perceives the successive “offs”, producing the sensation of flickering light. The limit or transition frequency is known as critical frequency of fusion (FCF). Above this frequency, the luminance variation stops being seen and the result is the sensation of “steady light”.

In this last condition, that is, frequencies higher than FCF, the sensation produced by pulsing lights can be estimated by means of the mathematical relation known as Talbot’s law (Moon, 1936; Talbot, 1834), which assigns a temporal integrating function to the visual system. Thus, if an intensity light $L_1(t)$, flickering periodically, is presented to an observer, the visual sensation L is adjusted to the equation:

$$L = \frac{1}{T} \int L_1(t) dt \quad (1)$$

In the Equation (1), L is the average of the train of light pulses and T is de pulse period.

If the flickering frequency is kept above the critical frequency, the light will be undistinguishable from another steady of equal value to that arising from Talbot’s law. The critical frequency is around 30~50 Hz and depends on the stimulus intensity and the observer’s age, among other factors.

Below the critical frequency, the light pulses will be perceived individually as a kind of flashes. The apparent brightness of the flashes is in agreement with their duration. For pulses lower than 0.2 s, Bloch’s law (Moon, 1936) establishes the persistence in the illumination product in the retina by duration of the “flash”. Therefore, the sensation produced by a light pulse of short duration is lower than that generated by the stimulus if it was permanent. There are several mathematic models that try to quantify the phenomenon (Ohno, 2002), being the model suggested by Blondel and Rey (1911) and Illuminating Engineering (1964) one of the most accepted ones at the beginning of the last century. In this model, the Effective Intensity I_{eff} of a pulsing light is expressed by the following equation:

$$I_{eff} = \frac{\int_{t_1}^{t_2} I(t) dt}{a + (t_2 - t_1)} \quad (2)$$

Where $I(t)$ is the instant intensity of the luminous pulse and “ a ” a constant (Blondel-Rey constant, $a = 0.2$ s). t_1 and t_2 are the times (in seconds) of the beginning and end of that part of the the instant intensity $I(t)$ when its value exceeds I_{eff} , with de condition of the choice of t_1 and t_2 maximizes the value of I_{eff} .

For pulses between 50 and 100 ms, of constant luminous intensity, it is observed an increase in the apparent brightness of flashes. This phenomenon is known as Broca – Sulzer (Brown, 1965; Hart Jr, 1987) effect and it mainly depends on the initial retinal illumination and on the pulse width.

2. The Study

The purpose of this work was to study the visual perception of the aeronautical light signal stimulated by pulses with frequencies close to the critical frequency at which flicker appears. The light signals, with LED technology, were fed with square pulses, verifying that the produced light also responded to this shape, with rise times practically negligible in relation to the pulse duration.

Thirty-five people, with normal vision and ages between 30 and 45 years old participated in the experience. From a fixed observation position, farther than 12 m from the source, the observers indicated their visual sensation for the presented alternatives. Figure 1 shows aspects of the experience.



Figure 1. Observer in position. Obstruction light used in the experience

The experience was developed in two stages. In the first one, variations of the permanent light intensity (not pulsing) that an observer is able to distinguish around a continuous intensity of reference were determined. For this, the observer was shown alternatively a same beacon, fed with a continuous reference voltage first, and then with a variable continuous voltage. Figure 2 shows a diagram of the test.

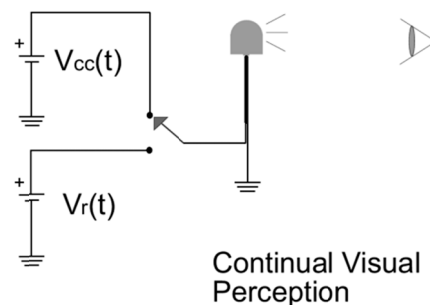

Figure 2. Circuit of visual perception test of continuous light

The variable source ($V_{cc}(t)$) took different values, slightly higher and lower than that of the reference ($V_r(t)$). The light was presented to the observer, who should indicate if he perceived it with higher, equal or lower brightness than the reference condition. With this test it was determined the range of intensities where the observers could not distinguish differences between both luminous intensities (perception threshold). Figure 3 shows voltage, current (excitations and reference) and perception graphs.

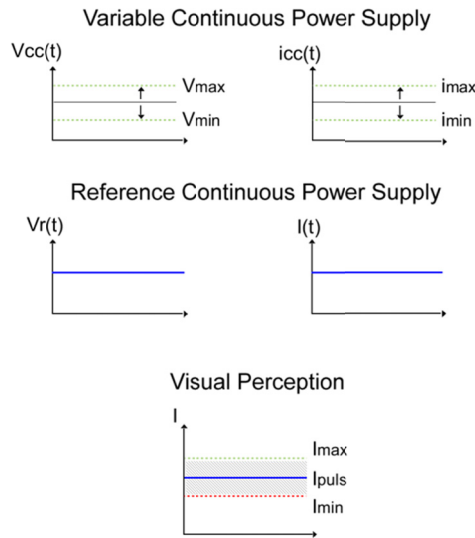

Figure 3. Graphs of voltage, current (excitations and reference) and perception

The second test consisted in exciting the light signal (beacon) by alternating either a square pulsing voltage of reference or a variable continuous voltage.

The frequency of voltage pulses was slightly increased in order to reach the critical frequency of each observer. Once the frequency was adjusted, the levels of voltage and current of the pulsing signal ($V_{puls}(t)$) were fixed. The experience began by presenting alternatively the beacon fed with this pulsed voltage and the variable continuous voltage to the observer, while being asked about his perception. Again, the observer had to indicate whether he perceived the beacon with higher, equal or less brightness than the condition of reference. Figures 4 and 5 show this second experience.

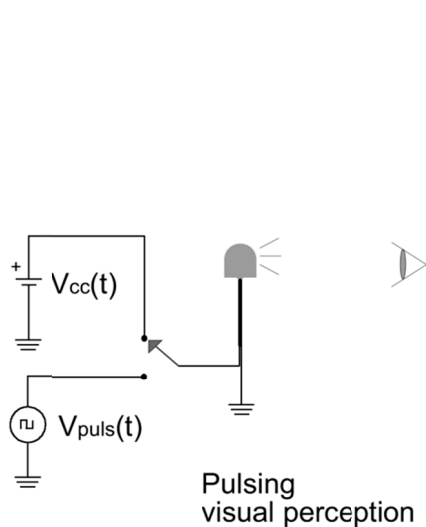

Figure 4. Circuit of visual perception test of continuous/pulsed light

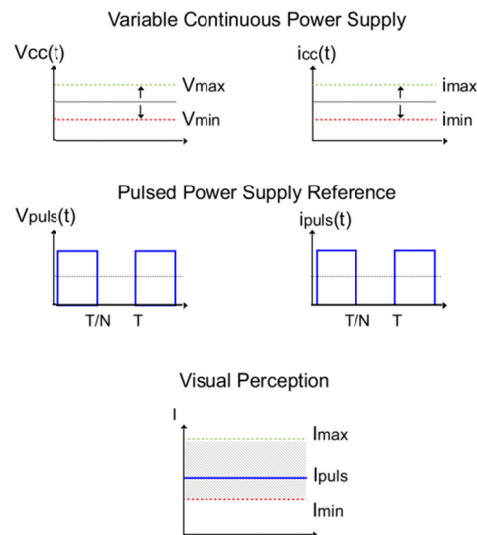

Figure 5. Graphs of voltage, current (excitations and reference) and perception

In both experiences, the switching of power source was carried out at random, so that the observer could not suspect which power source was being assessed. The signal was presented during the time necessary for the observer to give his opinion (higher, equal or lower than the previous vision), usually between 10 and 15 s. The switching to the following presentation was fast, tenths of seconds, in order to place a noticeable darkness between both images. The experience ended when the observer did not detect differences between successive presentations of the beacon.

During the tests, the light intensity I was measured permanently with a photo detector oriented in line with the observer's vision.

2.1 Voltage, Current and Supply Power

Voltages and currents of reference, either in the case of continuous supply or pulsed supply, were regulated in such a way that the consumed power per beacon was the same in both cases in order to be able to carry out a comparative analysis.

For the continuous supply, the power was:

$$P_r = I_{rcc} \cdot V_{rcc} \quad (3)$$

For the supply of the pulsed signal, the power was the product of effective values:

$$P_{efpuls} = I_{efpuls} \cdot V_{efpuls} \quad (4)$$

For a square wave:

$$I_{efpuls} = \frac{I_{p \max}}{\sqrt{N}} \quad (5)$$

Where $1/N$ is the fraction of the period where the square signal is not null.

Equally, for the effective voltage

$$V_{efpuls} = \frac{V_{p \max}}{\sqrt{N}} \quad (6)$$

The power was:

$$P_{efpuls} = \frac{I_{p \max} \cdot V_{p \max}}{N} \quad (7)$$

For the carried out tests the cycle of pulses was 50%, that is $N=2$.

As the beacon is basically a set of diodes, the total operation voltage is the sum of polarization voltages of diodes and is kept approximately constant for a range of current values. The ratio between power and current is approximately linear with a slope given by the total operation voltage of the beacon. This indicates that in a certain range, the beacon power is regulated proportionally with the current (green line in Figure 6).

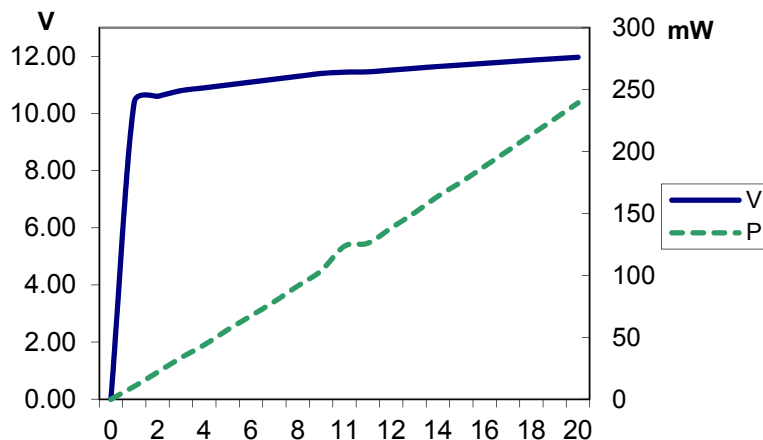

Figure 6. Voltage Curves – Current, Power – Beacon Current

For studying comparatively the visual sensation, the pulsing and continuous powers of reference were equaled:

$$P_r = P_{epuls} \quad (8)$$

As $N=2$ and $V_{pmax} \approx V_{rcc}$:

$$I_{pmax} \approx 2I_{rcc} \quad (9)$$

Such ratio was used for adjusting the reference sources.

3. Results

3.1 Continuous - Continuous Supply Comparison

Figure 7 shows the results obtained in this experience. There the intensity values regarding the reference versus each observer's appreciation were yielded.

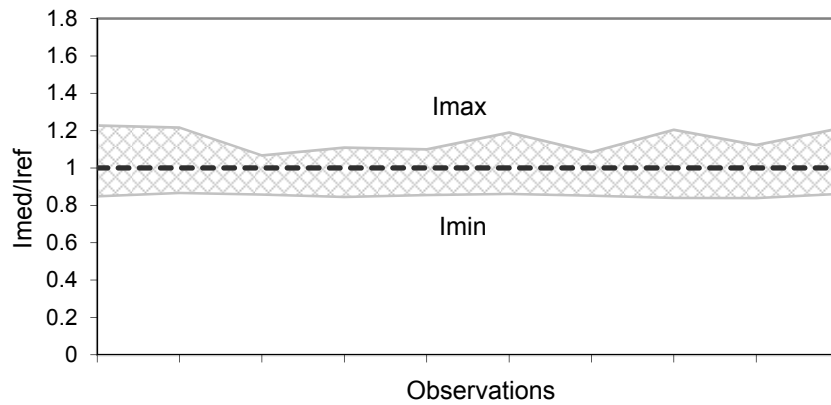

Figure 7. Light intensities and observer's appreciation between two continuous stimuli

The dots in the lower curve (I_{min}) determine the limit where each observer began to notice less light intensity from the variable source than from the reference. The dots of the upper curve (I_{max}) determine the limit where the observers noticed that the variable source was higher than the reference.

The marked zone (between I_{min} and I_{max} curves) corresponds to ratios for which the observers did not distinguish differences as regards the reference and it determines the perception threshold. For the experience which compares continuous supply versus continuous, this perception threshold was roughly $\pm 15\%$ around the reference, verifying that on average, any variation in intensity within that region was not perceived by the observers.

3.2 Continuous Supply - Pulsing Supply Comparison

First, a scanning in frequency was carried out in order to locate the critical frequency for each observer. Then, the source was adjusted close to this value with the condition that flashes could not be distinguished. Next, the steps described for the comparison were followed. The obtained results are indicated in Figure 8.

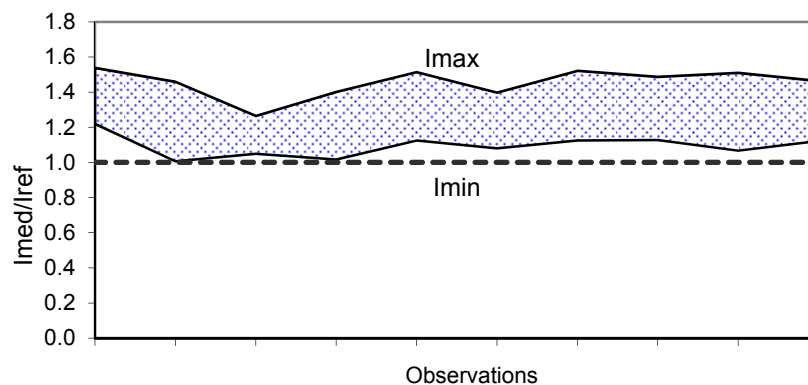

Figure 8. Light intensities and appreciation for a continuous stimulus and another pulsed

Just like in Figure 7, three regions are determined. Above curve I_{max} and below I_{min} , the observers detected differences (higher and lower than the reference, respectively). Between both curves (marked zone) the observers did not distinguish differences with respect to the reference. The lowest and highest average limit values were 1.09 and 1.45 respectively, and the range of difference was 0.362.

The same experience carried out at a higher frequency than the critical one yielded results similar to those in Figure 7, in some way verifying Talbot's law (Figure 9).

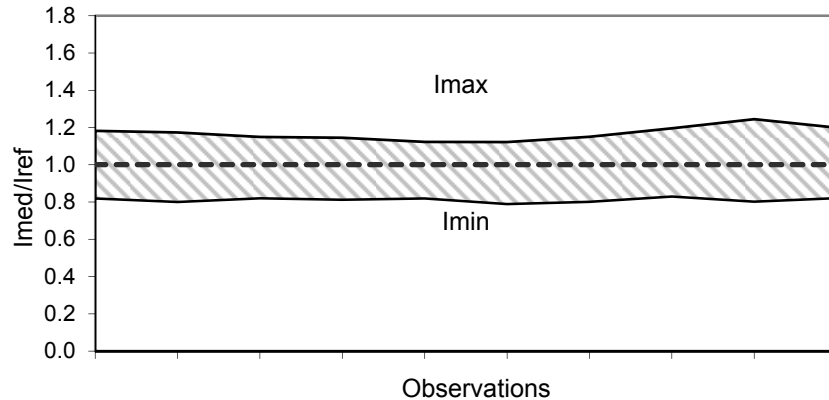

Figure 9. Light intensities and appreciation for a continuous stimulus and another pulsed ($f > FCF$)

4. Conclusions and Subsequent Analysis

The group of observers that participated in the tests did not distinguish variations of $\pm 15\%$ in the successive presentations of the beacon with continuous light. Taking into account the approximate symmetry around the reference, the range where existed observers' uncertainty was around 30%. The same tendency was verified by comparing continuous supply with pulsed supply, at higher frequencies than FCF. As expected, equivalence between supply power with continuous voltage and supply with pulses was evidenced.

Instead, the comparison carried out against the light pulsed at a frequency very close to FCF, just in the limit of non-flickering vision indicated that the observers noticed the difference when the continuous intensity was higher than 45% of the reference (as higher limit) or when the steady intensity was lower than 1.09 times the reference (as lower limit). In other words, the sensation produced in the observers by the beacon generating light pulses at the indicated frequency was the same as that produced by a continuous light with intensity between 9%-45% higher.

Translated to supply power (Figure 10) we can see a clear gain with respect to the pulsed light: it is needed higher continuous power (marked stripe) in order to obtain the same perceptive effect as with the pulsed supply (dotted line, taken as reference in the experience).

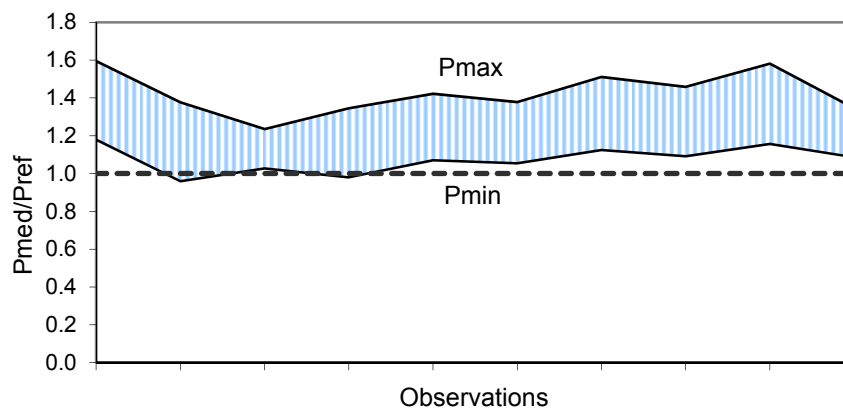

Figure 10. Power associated to light stimuli

Finally, unlike the isolated pulses that have a slighter effect than its real intensity (I_{eff} , of Blondel - Rey), multiple pulses, in the limit of continuous perception (critical frequency), would produce certain visual gain. This effect, which could be related to Broca – Sultzer, showed in average levels of perception increase of 36% and may well be used to improve the visibility of signals and beaconing devices

References

- Blondel, A., & Rey, J. (1911). Sur la perception des lumières brèves à la limite de leur portée. *J. Phys. Theor. Appl.*, 1(1), 530-550. <http://dx.doi.org/10.1051/jphysap:0191100107053000>
- Brown, J. L. (1965). Flicker an Intermittent Stimulation. In C. H. Graham (Ed.), *Vision and Visual Perception*. New York: John Wiley and Sons, Inc.
- Hart Jr, W. M. (1987). The temporal responsiveness of vision. In R. A. Moses, & W. M. Hart (Eds.), *Adler's Physiology of the eye, Clinical Application*. St. Louis: The C. V. Mosby Company.
- Illuminating Engineering. (1964). *IES Guide for Calculating the Effective Intensity of Flashing Signal Lights* (pp. 747-753).
- Moon, P. (1936). *The Scientific Basis of Illuminating Engineering*. McGraw Hill Company, London.
- Ohno, Y., (2002). Physical Measurement of Flashing Lights – Now and Then. *Proc. CIE Expert Symposium on Temporal and Spatial Aspects of Light and Colour Perception and Measurements*.
- Talbot, H. (1834). Experiments on Light. *Phil Mag*, 5.

Copyrights

Copyright for this article is retained by the author(s), with first publication rights granted to the journal.

This is an open-access article distributed under the terms and conditions of the Creative Commons Attribution license (<http://creativecommons.org/licenses/by/3.0/>).