

BADANIA DOŚWIADCZALNE ELEMENTÓW I KONSTRUKCJI BETONOWYCH

PUBLIKACJA POD PATRONATEM SEKCJI KONSTRUKCJI
BETONOWYCH KOMITETU INŻYNIERII LĄDOWEJ I WODNEJ PAN

ZESZYT NR 22

**Experimental
research of
concrete corbels
strengthened by
post – installed
reinforcement and
steel accessories**

**Badania krótkich wsporników
żelbetowych wzmacnianych zbrojeniem
wklejanym i stalowymi akcesoriami**

Tadeusz Urban
Łukasz Krawczyk
Michał Gołdyn

Badania wykonano ze środków statutowych
Katedry Budownictwa Betonowego

Department of Concrete
Structures, Lodz University of
Technology, Poland
Lodz 2019

Katedra Budownictwa Betonowego
Wydział Budownictwa, Architektury i Inżynierii Środowiska
Politechniki Łódzkiej
Łódź 2019

Recenzenci / Reviewers
Prof. dr hab. inż. Michał Knauff
Prof. dr hab. inż. Krystyna Nagrodzka – Godycka

Redaktor wydania / Editor – in – Chief
Prof. dr hab. inż. Tadeusz Urban

Tłumaczenie / Translation
dr inż. Łukasz Krawczyk

Skład tekstu / DTP
mgr inż. Jacek Filipeczak

©2019 Katedra Budownictwa Betonowego, Łódź, Polska
©2019 Department of Concrete Structures, Lodz University of Technology, Poland

ISBN 978-83-7283-980-0
ISSN 1230-6010
<https://doi.org/10.34658/kbb.2019.22>
DOI 10.34658/kbb.2019.22

Katedra Budownictwa Betonowego Politechniki Łódzkiej
Al. Politechniki 6, 90-924 Łódź, Polska
tel. (48) (42) 6313870, fax (48) (42) 6313584
Autor do korespondencji: Łukasz Krawczyk, e-mail: lukasz.krawczyk@p.lodz.pl

Wyniki badań prezentowanych w tym Zeszycie były podstawą dysertacji doktorskiej
Wzmacnianie krótkich wsporników żelbetowych zbrojeniem wklejanym

autor: dr inż. Łukasz Krawczyk

promotor: prof. dr hab. inż. Tadeusz Urban

recenzenci:

Prof. dr hab. inż. Michał Knauff

Prof. dr hab. inż. Krystyna Nagrodzka – Godycka

The results of the research presented in this Bulletin were the basis of the doctoral dissertation
Strengthening of short corbels with embedded through-section reinforcement

author: Łukasz Krawczyk, PhD

supervisor: Prof. Tadeusz Urban

reviewers:

Prof. Michał Knauff

Prof. Krystyna Nagrodzka – Godycka

STRESZCZENIE

Przedmiotem zeszytu jest problematyka wzmacniania istniejących krótkich wsporników żelbetowych. Postawiono tezę, że można skutecznie zwiększyć nośność wsporników za pomocą, wklejanego zbrojenia stalowego.

Zasadniczą część pracy stanowi opis własnych badań eksperymentalnych. Dotyczyły one dwóch kategorii wsporników: z umiarkowaną smukłością ścinania ($a_c/d = 0,5 \div 0,6$) i bardzo krępych ($a_c/d \approx 0,3$). Nim rozpoczęto proces wzmacniania, na każdy ze wsporników działała siła odpowiadająca około połowie obciążenia niszczonego, które ustalano na modelach referencyjnych. Wszystkie elementy były wzmacniane pod działającym obciążeniem. Jako dodatkowe zbrojenie stosowano pręty gwintowane M16 klasy 8.8. Część wsporników została zaopatrzona w stalowe akcesoria kotwione do betonu za pomocą śrub wklejanych. W trakcie badań mierzono odkształcenia na zbrojeniu wsporników i powierzchni betonu oraz rejestrowano rysy i szerokość ich rozwarcia. W jednej z serii wykonywano pomiary za pomocą systemu cyfrowej korelacji obrazu (Aramis). W sumie zbadano dziewiętnaście wsporników: sześć referencyjnych i trzynaście wzmocnionych. Użytkowano stopień wzmocnienia do 64% (przy zastosowaniu prętów wklejanych) i ponad 150% dla wzmocnienia akcesorium stalowym.

W wyniku analiz obliczeniowych stwierdzono, że dla wsporników z umiarkowaną smukłością ścinania metody oparte na modelach kratownicowych bardzo dobrze korespondują z wynikami badań własnych, a zbrojenie wklejone można traktować, tak jak pręty zabetonowane. Odmienna sytuacja jest w przypadku wsporników bardzo krępych. Wykazano, że istniejące sposoby obliczeń prowadzą do wyników tym bardziej konserwatywnych im mniejszy jest mechaniczny stopień zbrojenia elementu. Ze względu na odmienny sposób niszczenia osobno analizowano zachowanie wspornika z akcesorium stalowym (C – III), gdzie o zniszczeniu zadecydowała nośność wklejenia akcesorium.

W wyniku przeprowadzonych badań i analiz stwierdzono, że wsporniki o umiarkowanej i dużej smukłości ścinania $a_c/d \approx 0,5$ i niskim stopniu zbrojenia można skutecznie wzmacniać zbrojeniem wklejonym. Taki sposób wzmacniania jest mniej skuteczny dla elementów bardzo krępych $a_c/d \approx 0,3$.

SUMMARY

The subject of the Bulletin is strengthening of existing reinforced concrete corbels and the proposed thesis is that it is possible to effectively increase the carrying capacity of the corbels with embedded through-section (ETS) rods.

The main part of the dissertation is the author's own experimental research. The study covers two categories of corbels: one with moderate shear slenderness ($a_c/d = 0,5 \div 0,6$) and one with short span-to-depth ratios ($a_c/d \approx 0,3$). Prior to the start of the strengthening process, a force equivalent to about half of the ultimate load determined on the reference elements was applied to each corbel. All corbels were being strengthened under load. Threaded rods (M16, class 8.8) were used as additional reinforcement. Some of the corbels were equipped with a steel accessory anchored to the concrete with post-installed screws. During the tests deformations on the reinforcement and the concrete surface were measured and the cracks and their width were recorded. A digital image correlation system (Aramis) was used during one of the test series. On the whole, nineteen corbels were tested: six reference and thirteen strengthened ones. Increase of load capacity of up to 64% (using embedded through-section rods only) and over 150% for the steel accessory was observed.

As a result of calculation analyses, it was found that the methods based on the strut-and-tie models correspond very well with the results of the author's own tests for the moderate shear slenderness corbels and the post-installed reinforcement can be treated in the same way as the cast-in bars. The situation is different in the case of corbels with short span-to-depth ratios. It has been shown that the existing calculation methods lead to more conservative results if the mechanical reinforcement ratio of the element is smaller.

Due to the different method of destruction the corbel with steel accessory (C – III) was analyzed separately. In that case the ultimate load was determined by the load capacity of anchors.

As a result of the studies and analyses it was found that corbels with moderate and high shear slenderness $a_c/d \approx 0,5$ and low reinforcement ratio can be effectively strengthened by embedded through-section rods.

Such reinforcement is less effective in corbels with short span-to-depth ratios $a_c/d \approx 0,3$.

SPIS TREŚCI

Oznaczenia	
1. Wprowadzenie	9
2. Stan wiedzy	10
3. Badania własne	11
3.1. Zakres badań	11
3.2. Stanowiska badawcze i realizacja badań	11
3.3. Wzmocnienie zbrojeniem wklejanym	12
3.4. Procedura wzmacniania wsporników stalowymi akcesoriami	14
3.5. Wyniki badań	15
3.5.1. Serie A, B i C	15
3.5.2. Serie D i E	21
3.5.3. Wsporniki wzmacniane za pomocą stalowych akcesoriów	24
3.5.4. Analiza wsporników bardzo krótkich	27
4. Podsumowanie	28
Literatura	29
Poprzednio wydane zeszyty	31
Załącznik	33
Serie A i B	35
Seria C	65
Seria D	111
Seria E	185
Seria F	293

CONTENTS

Notation	
1. Introduction	9
2. State of the art	10
3. The author's research	11
3.1. Range of research	11
3.2. Test set ups and test procedures	11
3.3. Strengthening with ETS rods	12
3.4. Corbels strengthening procedure with steel accessory	14
3.5. Test results	15
3.5.1. Series A, B and C	15
3.5.2. Series D and E	21
3.5.3. Corbels strengthening with steel accessories	24
3.5.4. Analysis of very short corbels	27
4. Conclusions	28
References	29
Previously published Bulletins	31
Appendix	33
Series A i B	35
Series C	65
Series D	111
Series E	185
Series F	293

OZNACZENIA

Duże litery łacińskie

A_s	– pole przekroju pręta zbrojeniowego
F_c	– siła w krzyżulcu ściskanym
$F_{s,1}$	– siła w zbrojeniu głównym
$F_{s,diag}$	– siła w zbrojeniu ukośnym
$F_{s,link}$	– siła w strzemionach
ΣF_x	– suma rzutu siła na kierunek poziomy
V	– obciążenie przyłożone do wspornika
V_{X-X}	– obliczona nośność wspornika X – X
V_{col}	– obciążenie przyłożone do słupa
V_{EC2}	– nośność wspornika obliczona według EN-1992-1-1
V^{KNG}	– nośność wspornika obliczona według <i>Nagrodzkiej-Godyckiej</i>
V^{MC2010}	– nośność wspornika obliczona według Model Code 2010 (<i>Randla</i>)
$V^{Mohr,zbr}$	– nośność wspornika obliczona według hipotezy wytrzymałościowej <i>Mohra</i> z uwzględnieniem udziału zbrojenia
V^{S-F}	– nośność wspornika obliczona według podejścia shear – friction (<i>Masta</i>)
V_{ST}	– nośność wspornika obliczona według modelu strut and tie proponowanego przez autorów
V_w	– obciążenie przyłożone podczas wzmacniania
V_{test}	– nośność eksperymentalna wspornika

Małe litery łacińskie

a_c	– odległość od lica słupa do środka przyłożenia siły
a_c/d	– smukłość ścinania policzona jako iloraz a_c i d
a_c/h_c	– smukłość ścinania policzona jako iloraz a_c i h_c
d	– wysokość użyteczna wspornika
f_{cm}	– średnia wytrzymałość betonu zbadana na próbkach walcowych 150/300
f_{ym}	– średnia granica plastyczności zbrojenia
h_c	– wysokość wspornika
$\tan\theta$	– tangens kąta nachylenia krzyżulca ściskanego
w_k	– szerokość rozwarcia rysy

Małe litery greckie

ε_s	– odkształcenie pręta zbrojeniowego
ε_{ym}	– odkształcenie powodujące uplastycznienie pręta
ρ_l	– stopień zbrojenia podłużnego
θ	– kąt pomiędzy krzyżulcem ściskanym a kierunkiem poziomym
$\sigma_{R,max}$	– maksymalne naprężenia w betonie

NOTATION

Roman upper case letters

A_s	– cross section area of bar reinforcement
F_c	– force in strut
$F_{s,1}$	– force in main reinforcement
$F_{s,diag}$	– force in diagonal reinforcement
$F_{s,link}$	– force in stirrups
ΣF_x	– sum of force in horizontal direction
V	– loading applied to corbel
V_{X-X}	– calculated load carrying capacity of X – X corbel
V_{col}	– loading applied to column
V_{EC2}	– calculated load carrying capacity according to EN-1992-1-1
V^{KNG}	– calculated load carrying capacity according to <i>Nagrodzka-Godycka</i>
V^{MC2010}	– calculated load carrying capacity according to Model Code 2010 (<i>Randl</i>)
$V^{Mohr,zbr}$	– calculated load carrying capacity according to <i>Mohr's</i> hypothesis including contribution of reinforcement
V^{S-F}	– calculated load carrying capacity according to shear – friction (<i>Masta</i>) approach
V_{ST}	– calculated load carrying capacity according to the authors' proposition
V_w	– loading applied during strengthening
V_{test}	– experimental load carrying capacity

Roman lower case letters

a_c	– distance between column face and center of applied load
a_c/d	– shear slenderness calculated as quotient of a_c and d
a_c/h_c	– shear slenderness calculated as quotient of a_c and h_c
d	– effective depth of corbel
f_{cm}	– average concrete strength tested using cylinders 150/300
f_{ym}	– average yield strength of reinforcement
h_c	– height of corbel
$\tan\theta$	– tangent of the strut inclination angle
w_k	– width crack opening

Greek lower case letters

ε_s	– strain of reinforcement bar
ε_{ym}	– strain causing of yielding reinforcement bar
ρ_l	– ratio of longitudinal reinforcement
θ	– the angle between strut and horizontal direction
$\sigma_{R,max}$	– ultimate stress in concrete

1. WPROWADZENIE

W zeszycie przedstawiono wyniki badań eksperymentalnych wzmacniania krótkich wsporników żelbetowych za pomocą wklejanego zbrojenia i stalowych akcesoriów. Jako wklejane zbrojenie wzmacniające zastosowano pręty gwintowane. Podobne rozwiązanie było wykorzystane w badaniach *Urbana* [37, 38] i zespołu *Muttoniego* [20] do wzmacniania na ścinanie belek żelbetowych. Podobną koncepcję zastosowano również w badaniach wzmacniania na przebicie płaskich stropów żelbetowych [9, 10, 12].

Autorzy prezentowanych badań kierowali się zasadą możliwie najbardziej wiernego oddania warunków rzeczywistych, jakie wykonawca napotyka przy wzmacnianiu realnej konstrukcji. Istniejącej konstrukcji prawie nigdy nie można odciążyć całkowicie. Zwykle w badaniach doświadczalnych operacja wzmacniania jest prowadzona na elemencie nieobciążonym. W badaniach prezentowanych w tym zeszycie, wzmacniane wsporniki były poddane wstępnym obciążeniom i w trakcie wykonywania wzmocnienia utrzymywana była jego znaczna część.

Pierwszym celem badań, było rozpoznanie skuteczności metody na możliwie szerokiej grupie wsporników. Zdecydowano się sprawdzić zarówno wsporniki o umiarkowanej smukłości ścinania $a_c/d \approx 0,5$, jak i elementy bardzo krępe $a_c/d \approx 0,3$. We wszystkich badanych elementach zastosowano zbliżony stopień zbrojenia głównego $\rho_l \approx 0,4\%$.

1. INTRODUCTION

In this report the results of experimental research connected with strengthening concrete corbels by post-installed (embedded through section) rods and steel accessories are presented. Threaded rods were used as a post-installed (ETS) elements. A similar method was used by *Urban* [37, 38] and *Muttoni's team* [20] in order to strengthen concrete beams against shear and flat slabs against punching shear [9, 10, 12].

The authors wanted to faithfully simulate real conditions of strengthening process. The existing constriction hardly ever can be unloaded completely. In majority of the experimental research unloaded elements were strengthened. In the experimental investigations presented here the corbels were initially loaded and a significant part of the force was maintained during the strengthening process.

The first aim of the experimental research was to check efficiency of strengthening by ETS rods on a wide range of corbels. Among the experimental specimens some corbels with moderate shear slenderness $a_c/d \approx 0,5$ as well as very short ones $a_c/d \approx 0,3$. In all the investigated elements a similar ratio of main (flexural) reinforcement $\rho_l \approx 0,4\%$ was used.

2. STAN WIEDZY

W tym rozdziale zacytowano prace dostępne w literaturze przedmiotu opublikowane przed 2018 rokiem. W większości tych prac [2, 4, 6, 7, 13–17, 25, 35] wsporniki przed wzmocnieniem były „dziewicze”. Można uznać, że w tych przypadkach badano elementy zaprojektowane i wykonane ze zbrojeniem zewnętrznym. W badaniach *Nagrodzkiej-Godyckiej* [21, 26–30], *Corry* i *Dolana* [5] wsporniki wzmocniono po uprzednim zarysowaniu. Natomiast prace *Assihiego* i innych [3] oraz *Shadhana* i *Kadhina* [28] miały odpowiedzieć na pytanie czy obciążenie przed instalacją zbrojenia wzmacniającego ma wpływ na nośność wsporników. W obu tych badaniach stwierdzono, że istnieje wpływ historii obciążania na nośność elementów.

Wśród zacytowanych prac wyróżniają się publikacje *Nagrodzkiej-Godyckiej*, która w swych badaniach osiągnęła istotne stopnie wzmocnienia wsporników z dużym stopniem zbrojenia w skali naturalnej. Autorka ta w swych pracach zajmowała się między innymi efektywnością sprężenia zbrojenia zewnętrznego na nośność wsporników [21, 26, 27, 29].

Większość cytowanych publikacji [2–7, 13–17, 35] to prace opisujące wzmocnienia wsporników za pomocą taśm i mat CFRP, a w badaniach [31] GFRP. Taka sytuacja wpisuje się w obecny trend wykorzystywania kompozytów włóknistych w budownictwie. Łatwość montażu, niska gęstość, odporność na wpływy chemiczne są niewątpliwymi atutami. Jednocześnie w publikacjach na ogół są przemilczane wady tych materiałów, takie chociażby stosunkowo niska temperatura degradacji żywic.

Zdaniem autorów Zeszytu, nośność wsporników wzmocnianych taśmami CFRP jest ograniczana przez odpajanie otuliny. Utrata nośności następuje gwałtownie bez wcześniejszej wyraźnej sygnalizacji. Wydaje się, że problem ten nie powinien występować w przypadku stosowania mat FRP [2, 4, 5, 13–17, 31]. *Campione* [4] jako przyczynę zniszczenia badanych przez niego elementów wskazał rozrywanie mat na narożach wspornika i „debonding” w strefie zakładu. Podobne wnioski przedstawił *Shadhan* i *Kadhin* [35]. Natomiast *Ivanowa* [13–17] wykazała, że dla jednej lub dwóch warstw maty, nośność elementów obandażowanych matami jest mniejsza niż od tych z matami tylko na bocznych powierzchniach. Reasumując, nie ma jasnych dowodów eksperymentalnych świadczących o skuteczności wzmocnienia wsporników owiniętych matami CFRP.

Kriz i *Raths* w swej bardzo ważnej pracy [19] zaprezentowali różne możliwe typy zniszczeń krótkich wsporników, co stanowi punkt wyjścia do analizy oceny bezpieczeństwa konstrukcji i ewentualnej propozycji jej naprawy lub wzmocnienia.

2. STATE OF ART

This chapter quotes subject literature published before 2018. Most of the studies [2, 4, 6, 7, 13–17, 25, 35] describe corbels which were “unspoiled” before strengthening. It may be recognised that in these cases the elements were designed and made with external reinforcement. In *Nagrodzka-Godycka* [21, 26–30], *Corry* and *Dolan's* [5] experimental test, corbels were strengthened after previous cracking. On the other hand, *Assih et al* [3] as well as *Shadhan* and *Kadhin* [28] addressed the question of whether: the loading history has any influence on the strength of the corbel and state that the ultimate strength is influenced by loading history in both cases.

Among those quoted, noteworthy is *Nagrodzka-Godycka's* work who investigated natural scale corbels with high amount of reinforcement and achieved a significant ratio of strengthening. In her papers [21, 26, 27, 29], she focused on the effectiveness of external prestressed reinforcement.

Most of the quoted articles [2–7, 13–17, 35] describe corbels strengthened with carbon fiber reinforced polymer (CFRP) fabrics or strips and GFRP in [31]. This method of strengthening is frequently tested in civil engineering. Easy mounting, low density, resistance to chemical influences are unquestionable advantages of FRP materials. On the other hand, however, disadvantages of said materials, such as for instance low temperature of resin degradation are generally disregarded.

According to the authors, corbel load carrying capacity strengthened by CFRP strips is usually limited by debonding (spalling of concrete cover). Loss of the load carrying capacity is violent and is not preceded clear signaling. It seems that the described process should not occur in the case of using CFRP fabrics [2, 4, 5, 13–17, 31]. As the reason for his corbels failure *Campione* [4] indicates tearing FRP fabrics in the corner and debonding in the overlap length. Similar conclusions were presented by *Shadhan* and *Kadhin* [35]. *Ivanowa* [13–17] proved that load-carrying capacity of corbels wrapped by one or two fabric layers is lower than load-carrying capacity of corbels strengthened by fabrics on 2 faces only. In conclusion, clear experiential evidences proving effectiveness of strengthening of corbels by FRP materials is not known.

In their seminal paper, *Kriz* and *Raths* [19] presented different scenarios of short corbels failure. Their observations constitute a basis for analysis of structure safety and possible proposals for its repair or strengthening.

3 BADANIA WŁASNE

3.1 Zakres badań

Badania własne obejmowały dwa rodzaje elementów badawczych: z jednym wspornikiem (seria A, B i C) oraz z dwoma wspornikami (seria D, E, i F). Wsporniki jednostronne charakteryzowały się średnią smukłością ścinania $a_c/h_c \approx 0,50 \div 0,61$. Elementy z dwoma wspornikami miały znacznie mniejszą smukłość $a_c/h_c \approx 0,28 \div 0,33$. Wsporniki wzmacniano dwiema metodami: za pomocą wklejanego zbrojenia w postaci gwintowanych prętów oraz w przypadku części elementów stosowano stalowe akcesoria. Na rysunku 3.1 pokazano wszystkie typy badanych ciał próbnych.

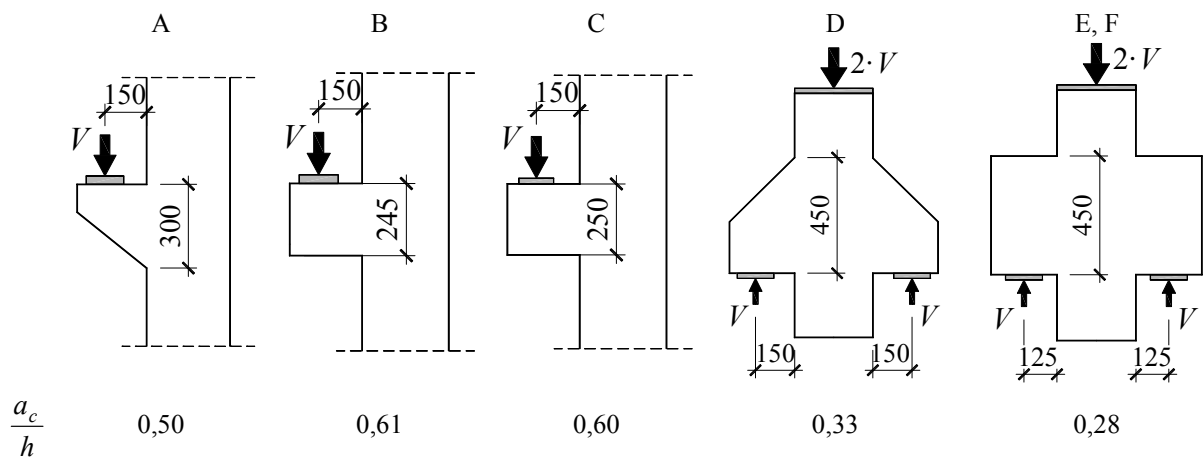

Rys. 3.1. Typy badanych wsporników poszczególnych serii

Fig. 3.1. Types of testing corbels series

3.2 Stanowiska badawcze i realizacja badań

Każdy typ elementów wymagał prowadzenia badań na różnych stanowiskach. Elementy z jednym wspornikiem słupowym badano na stanowisku pokazanym na rys. 3.2, a elementy z dwoma wspornikami na stanowisku widocznym na rys. 3.3.

3 THE AUTHOR'S RESEARCH

3.1 Range of research

The two types of elements were tested by authors. The series A, B and C were one-sided and series D, E and F were two-sided. The shear slenderness of corbels in series A B and C was $a_c/h_c \approx 0,50 \div 0,61$. The corbels in series D, E and F were more compact, their shear slenderness was $a_c/h_c \approx 0,28 \div 0,33$. The tested elements were strengthened by two different methods: post-installed by two different methods: post-installed by two different methods: post-installed (embedded through the section) rods and steel accessories. In the Figure 3.1 all types of tested specimens are shown.

3.2 Test set ups and test procedures

Each of two corbels types needed different type of the test set up. The one sided elements were investigated in the test set up shown in figure 3.2, and the two sided corbels were tested in the set up shown in figure 3.3.

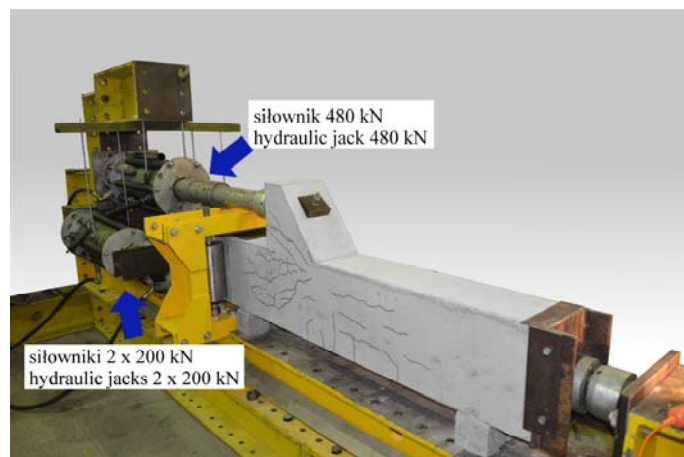

Rys. 3.2. Stanowisko badawcze dla elementów z jednym wspornikiem słupowym

Pierwsze stanowisko (rys. 3.2) zostało tak zaprojektowane, aby w możliwie najbardziej realny sposób odwzorowywać sytuację konstrukcji w budynku. W tym celu zastosowano dwa systemy siłowników hydraulicznych umożliwiających niezależne obciążanie słupa i wspornika.

The first set up (fig. 3.2) was designed to maximally realistically represent a building structure. To that end two systems of hydraulic jacks were used so that. Independent loading of the column and the corbel could be achieved.

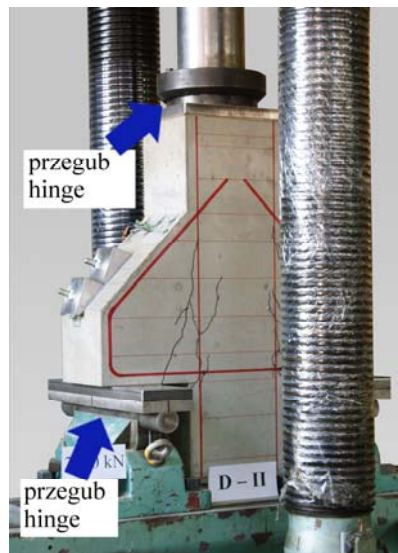

Rys. 3.3. Stanowisko badawcze dla elementów z dwoma wspornikami
Fig. 3.3. Testing set up for two sided corbels

Sterowanie siłą było prowadzone z dwóch odrębnych pulpityw. Najpierw przykładano obciążenie na słup do poziomu $V_{col} = 150$ kN, a następnie przystępowano do obciążania wspornika skokowo zwiększając siłę co 10 kN. Przy wysokim zaawansowaniu obciążenia zmniejszono skok siły do 5 kN. Każdy poziom obciążenia trwał około 5 min. w czasie którego dokonywano rejestracji rys, ich pomiarów szerokości oraz odkształceń zbrojenia i betonu. Badanie wsporników wzmacnianych wykonywano w trzech etapach. Najpierw obciążano słup, a następnie wspornik do poziomu siły, pod obciążeniem której rejestrowano odkształcenia zbrojenia głównego wspornika wynoszące około 2%. Wsporniki na tym poziomie obciążenia były już intensywnie zarysowane. Następnie częściowo odciążano wspornik i przystępowano do jego wzmacniania utrzymując stałe jego obciążenie. Po osiągnięciu przez klej pełnej wytrzymałości, co wymagało 1,5 godz. oczekiwania, kontynuowano badanie zwiększając stopniowo obciążenie wspornika aż do jego zniszczenia.

Badania wsporników dwuramiennych o mniejszej smukłości wymagały innego stanowiska badawczego, ze względu na znacznie większą nośność elementów. W tym celu wykorzystano maszynę wytrzymałościową o maksymalnym nacisku 6000 kN (patrz rys. 3.3). Zachowano podobną procedurę badawczą, jak przy poprzednich seriach. W serii D dodatkowo wykonano trzykrotne odciążenie (do 100 kN) i ponowne obciążenie (do 800 kN) wsporników przed ich wzmacnianiem. Elementy D wzmacniano pod obciążeniem 800 kN (po 400 kN na każdy wspornik), a w przypadku serii E i F pod siłą 1000 kN (po 500 kN na wspornik).

3.3 Wzmacnianie zbrojeniem wklejanym

Wklejanie prętów wzmacniających polegało na wykonaniu następujących czynności:

- trasowanie otworów,
- wiercenie otworów wiertarką udarową (rys. 3.4),

The control of the loading process was performed from two separate desktops. First, the applied loading of the column reached $V_{col} = 150$ kN. Next loading of the corbel was increased incrementally by 10 kN. At high level of loading, the step was decreased to 5 kN. Each level of the loading lasted for approximately 5 minutes, during which a time sketch of the cracking pattern, measurement of cracks widths as well as strain of concrete and reinforcement were made. Experimental investigations of the strengthened corbels was performed in three stages. First, loading at the column was applied, then loading at corbel was increased to the force causing the strain of the main reinforcement of about 2%. The corbels at this level of loading were intensively cracked. Then elements were partly unloaded and strengthening process started. A constants value of loading was maintained for the duration of the process. After curing time of the resin (about 1,5 hour) investigation was continued. Loading of the corbel was increased incrementally until the ultimate force was reached.

Experimental investigation of two-sided corbels characterized by lower shear slenderness required different type of test set up, because of much higher value of ultimate load. For this purpose, a machine able to generate 6000 kN of load was used (see Fig. 3.3). The investigation procedure was similar for all series. In series D, additionally, three cycles of unloading to 100 kN and reloading to 800 kN were performed. The elements in D series were strengthened under load equals 800 kN (400 kN for each corbel), in case E and F the force was 1000 kN (500 kN for each corbel).

3.3 Strengthening with ETS rods

Embedding through section depend entailed following actions:

- scribing of holes,
- drilling holes using hammer drill (Fig. 3.4),



Rys. 3.4. Wiercenie otworu z wykorzystaniem urządzenia zapewniającego projektowane położenie pręta wzmocniającego po jego wklejeniu
 Fig. 3.4. Drilling hole using device providing designed location of rod after its embedded

- czyszczenie otworów sprężonym powietrzem i szczotką drucianą (rys. 3.5),
- cleaning holes with compressed air and wire brush (fig. 3.5)

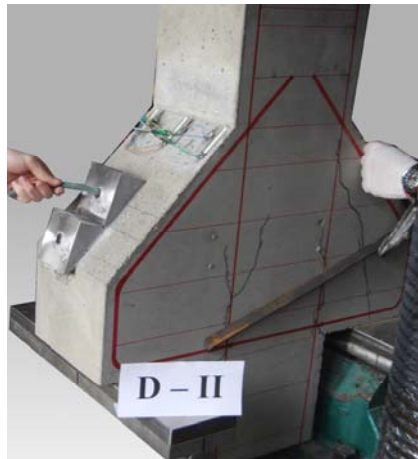

Rys. 3.5. Czyszczenie otworu: a) sprężonym powietrzem, b) drucianą szczotką
 Fig. 3.5. Cleaning hole with: a) compressed air, b) wire brush

- aplikacja kleju żywicznego z wykorzystaniem specjalistycznej dyszy zapewniającej wypełnienie otworu od jego dna na długości od 1/2 do 2/3 jego głębokości (rys. 3.6),
- application of resin mortar using a special nozzle ensuring filling the hole from its bottom with a length from 1/2 to 2/3 of its depth (fig. 3.6),



Rys. 3.6. Aplikacja kleju żywicznego
 Fig. 3.6. Application of resin

- osadzenie pręta zbrojeniowego w otwór ruchem obrotowym aż do uzyskania oporu przy dnie (rys. 3.7),

- embedment of the rod in the hole using rotational movement until the resistance at the bottom is reached (Fig. 3.7),



Rys. 3.7. Osadzenie pręta zbrojeniowego
Fig. 3.7. Embedment of threaded rod

- oczekiwanie na osiągnięcie przez klej pełnej wytrzymałości (w zależności od temperatury otoczenia trwało to od 60 do 90 min.),
- nałożenie na końcówkę wystającego pręta z elementu podkładki i zablokowanie jej nakrętką.

- waiting for the adhesive to reach full strength (60 – 90 minutes), depending on the ambient temperature,
- applying a washer and screwing the nut.

3.4 Procedura wzmacniania wsporników stalowymi akcesoriami

Inaczej przebiegał proces wzmacniania elementów za pomocą stalowych akcesoriów. Każdy rodzaj akcesorium wymagał indywidualnego podejścia. Można jednak wyróżnić pewne elementy stałe procedury:

- przygotowanie powierzchni betonu w miejscu klejenia akcesorium,
- odłuszczenie powierzchni klejonej akcesorium,
- przyklejenie akcesorium,
- oczekiwanie na związanie kleju,
- wiercenie otworów na śruby kotwiące poprzez otwory akcesorium,
- oczyszczenie otworów,
- aplikacja kleju w otwory,
- osadzenie śrub kotwiących,
- oczekiwanie na związanie kleju w otworach,
- zakręcenie nakrętek na śrubach.

Niektóre elementy tej procedury pokazano na rys. 3.8 i 3.9.

3.4 Corbels strengthening procedure with steel accessory

The process of strengthening elements with steel accessories was different. Each type of accessory required an individual approach. However, some common stages of the procedure can be distinguished:

- preparation of the concrete surface at the place of the accessory gluing,
- degreasing the surface before gluing the accessory,
- gluing the accessory,
- waiting for the resin to reach full strength,
- drilling holes for anchoring bolts through the holes in the accessory,
- cleaning the holes,
- application of glue in the holes,
- embedment of anchoring rods,
- waiting for the resin to reach full strength,
- screwing the nuts on the rods.

Some elements of this procedure are shown in Figs. 3.8 and 3.9.

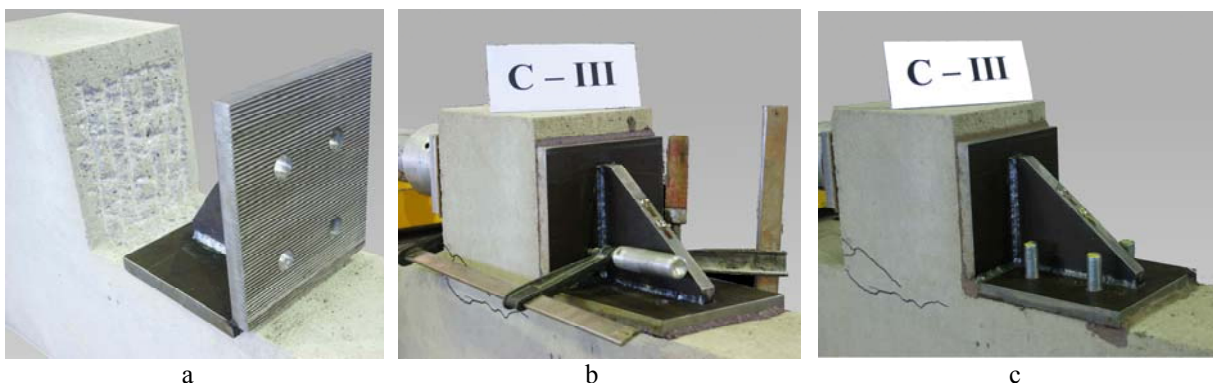

Rys. 3.8. Akcesorium elementu C-III: a) widok powierzchni betonu wspornika i akcesorium od strony klejonej, b) mocowanie na czas wiązania kleju c) po zakończeniu montażu

Fig. 3.8. Element C-III accessory: a) view of the corbel concrete and accessory surface from the gluing side, b) fixing for the curing time c) after assembly



Rys. 3.9. Wzmacnianie elementu D-III – oczekiwanie na związanie warstwy kleju pomiędzy powierzchnią betonu i akcesorium
 Fig. 3.9. Strengthening of element D-III – waiting for the adhesive to reach full strength between surface of the concrete and accessory

3.5 Wyniki badań

3.5.1 Serie A, B i C

Modele serii A były wspornikami trapezowymi, natomiast serii B i C prostokątnymi. Elementy A – 0, B – 0 i C – 0 stanowiły modele – świadki. Jako zbrojenie wzmacniające zastosowano pręty gwintowane M16 klasy 8.8, które wklejono na za pomocą szybkotwardniejącej żywicy. Podstawowe dane elementów próbnych zawarto w Tabelicy 3.1 oraz pokazano na rys. 3.10.

3.5 Test results

3.5.1 Series A, B and C

Elements of the A series were trapezoidal, while the B and C corbels were rectangular. Elements A – 0, B – 0 and C – 0 were reference corbels. As strengthening reinforcement M16 grade 8.8 threaded rods were used. They were embedded through section using a quick hardening resin. The basic data of the test elements is contained in Table 3.1 and is shown in Figure 3.10.

Tablica 3.1. Podstawowe dane wsporników serii A, B i C
 Table 3.1. Basic data on the corbels series A, B and C

Element Element	wymiar dimensions			beton concrete	zbrojenie główne main reinforcement Ø12		strzemiona stirrups Ø6		pręt wklejany embedding rods Ø16		V_{test} [kN]
	h_c [mm]	a_c [mm]	d [mm]	f_{cm} [MPa]	A_s [mm ²]	f_{ym} [MPa]	A_s [mm ²]	f_{ym} [MPa]	A_s [mm ²]	f_{ym} [MPa]	
A – 0	300	150	284	34,8	114,6	628,3	28,1	585,2	-	-	337
A – I			229	23,9					138,9	997,1	465
B – 0	245		225	35,0	227,6	409,7*	113,2	451,4	-	-	187
B – I			226						164,9	843,3	300
C – 0	250		230								310
C – I											
C – II											

* granica wytrzymałości tych prętów to 636,0 MPa
 ultimate strength of these bars is 636,0 MPa

Na rysunku 3.11 dokonano porównania odkształceń zbrojenia głównego modeli A – 0 i A – I w funkcji obciążenia, a na rys. 3.12 szerokości maksymalnego rozwarcia rys. Jak widać wzmocnienie wspornika dodatkowym ukośnym prętem spowodowało opóźnienie osiągnięcia granicy plastyczności w zbrojeniu głównym, jak również ograniczenie szerokości rozwarcia rys.

In Figure 3.11 comparison of the main reinforcement strains of elements A – 0 and A – I as a function of load is shown. In Fig. 3.12 the maximum opening width of the cracks is presented. It can be seen that the corbel strengthening by an additional diagonal rod caused a delay in yielding in the main reinforcement as well limiting the width of cracks.

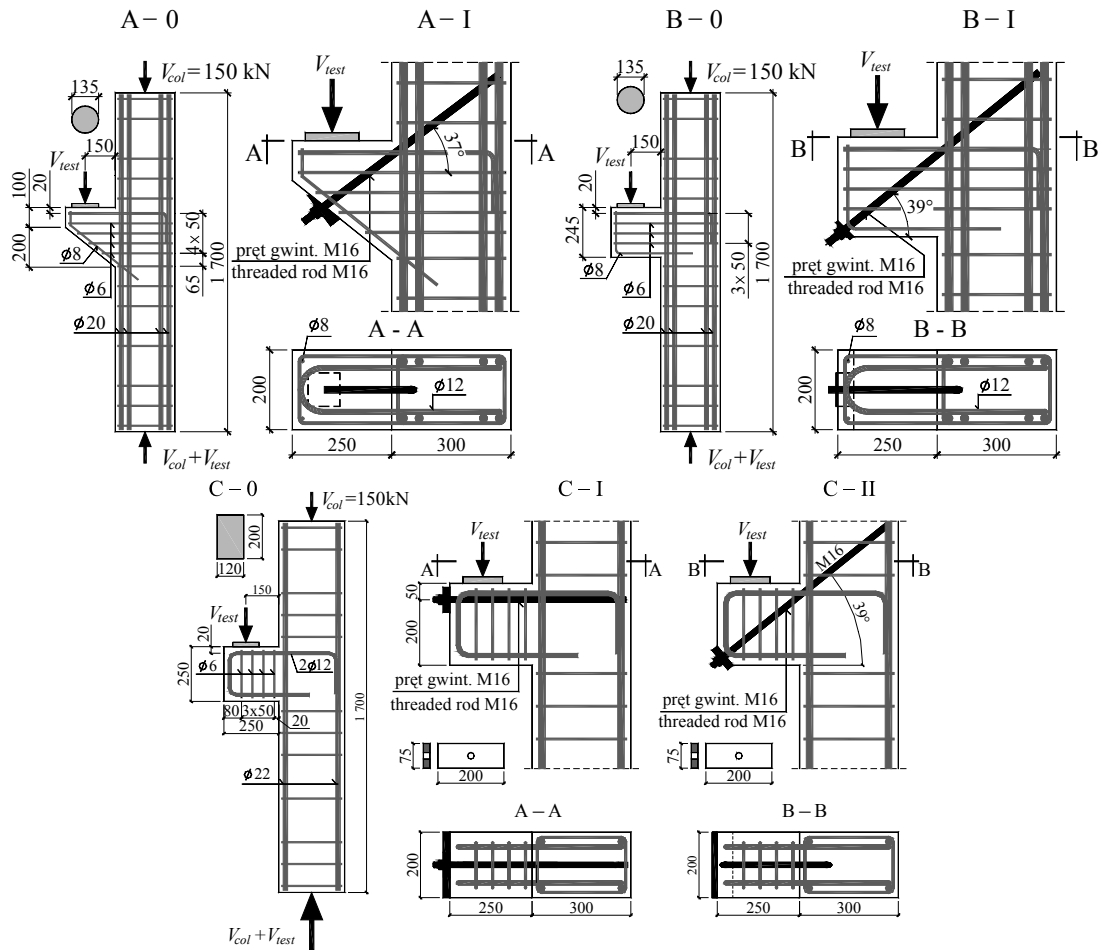

Rys. 3.10. Modele serii A, B i C
 Fig. 3.10. Elements of series A, B and C

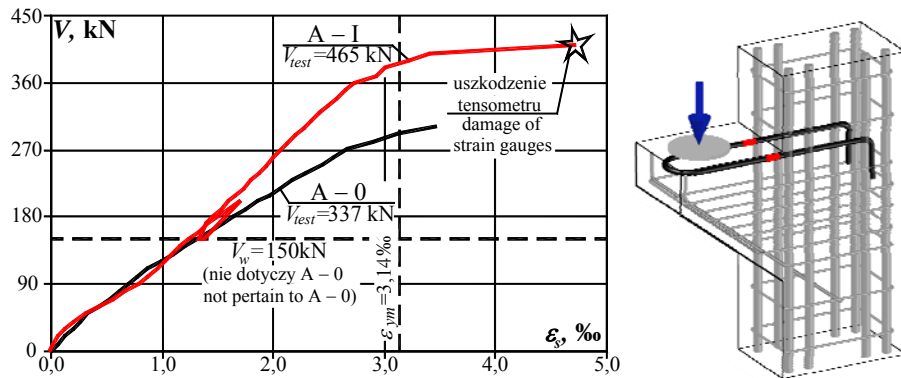

Rys. 3.11. Porównanie odkształceń zbrojenia głównego modeli:
 A – 0 (niewzmocniony) i A – I (wzmocniony)

Fig. 3.11. Comparison of the main reinforcement strains referring to elements:
 A – 0 (unstrengthened) and A – I (strengthened)

Analiza odkształceń zbrojenia głównego modeli serii B (rys. 3.13) wykazała podobną zależność.

The analysis of the main reinforcement strains referring to the B series elements (Figure 3.13) showed a similar relationship.

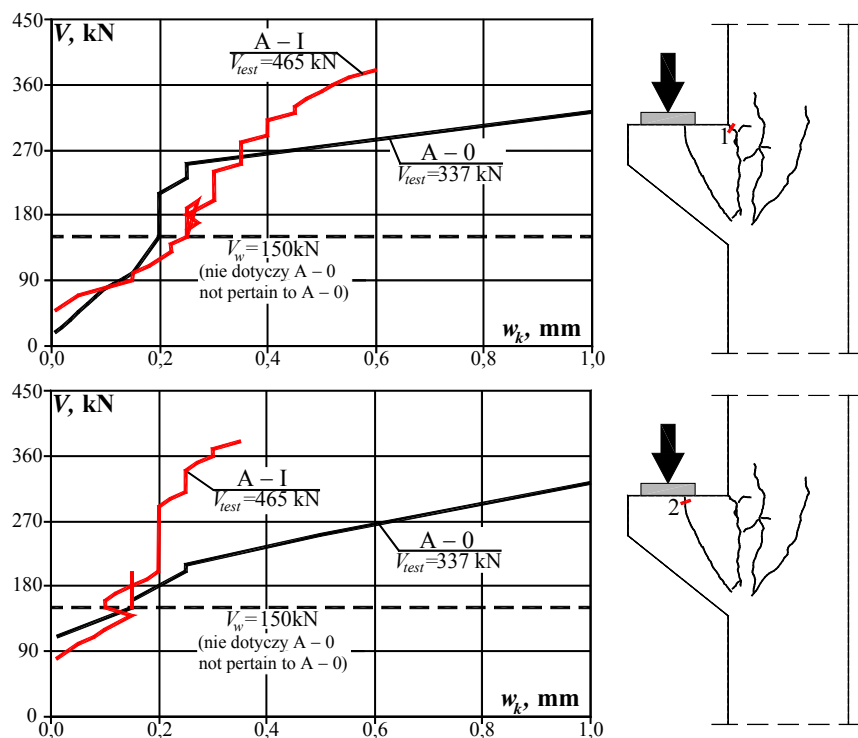

Rys. 3.12. Porównanie maksymalnej szerokości rozwarcia rys modeli: A – 0 (niewzmocniony) i A – I (wzmocniony)

Fig. 3.12. Comparison of the maximum width of cracks referring to elements: A – 0 (unstrengthened) and A – I (strengthened)

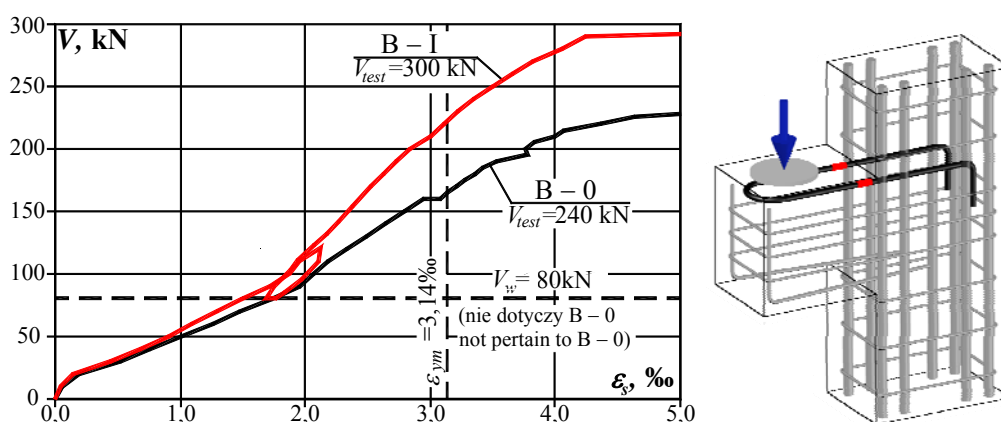

Rys. 3.13. Porównanie odkształceń zbrojenia głównego modeli: B – 0 (niewzmocniony) i B – I (wzmocniony)

Fig. 3.13. Comparison of the main reinforcement strains referring to elements: B – 0 (unstrengthened) and B – I (strengthened)

Na rysunku 3.14 przedstawiono wyniki analizy nośności modelu A – 0 zgodnie z zasadami Eurokodu 2 [8] metodą Struts and Ties. Uwzględniono w niej parametry materiałowe podane w Tabelicy 3.1. Jak widać, nośność eksperymentalna jest znacznie wyższa od teoretycznej $V_{test} / V_{EC2} = 337/231,2 \approx 1,46$. Na kolejnym rysunku (nr 3.15) przedstawiono wyniki zmodyfikowanej analizy S-T, uwzględniającej strzemiona poziome. Uwzględniono w niej strzemiona znajdujące się w górnej strefie wspornika ograniczonej wymiarem $2/3d$. Takie podejście zbliżyło znacznie wynik teoretyczny do eksperymentalnego $V_{test} / V_{ST} = 337/307,3 \approx 1,10$.

In Figure 3.14 the results of A – 0 load carrying capacity analysis according to the principles of Eurocode 2 [8] using the Struts and Ties method are presented. The material parameters given in Table 3.1 are taken into account. It can be seen that the experimental load is much higher than the theoretical $V_{test} / V_{EC2} = 337/231,2 \approx 1,46$. In the next figure (No 3.15), the results of modified strut and tie analysis taking into account stirrups are shown. Only the stirrups located in the upper (tension) $2/3d$ were included. This approach brought the theoretical and experimental results much closer $V_{test} / V_{ST} = 337/307,3 \approx 1,10$.

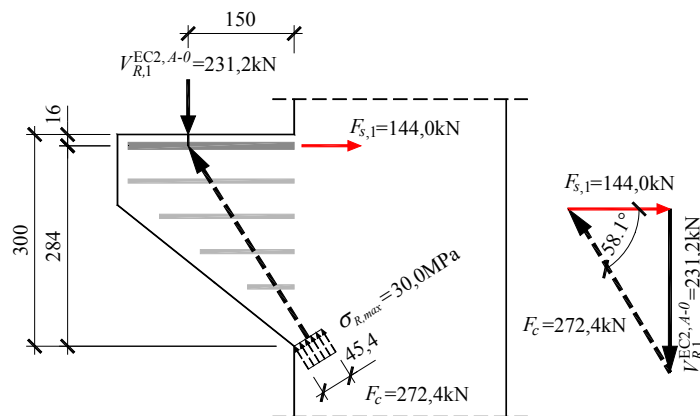

Rys. 3.14. Analiza nośności wspornika A – 0 zgodnie Eurokodem 2

Fig. 3.14. Load carrying capacity analysis of corbel A – 0 according to the Eurocode 2

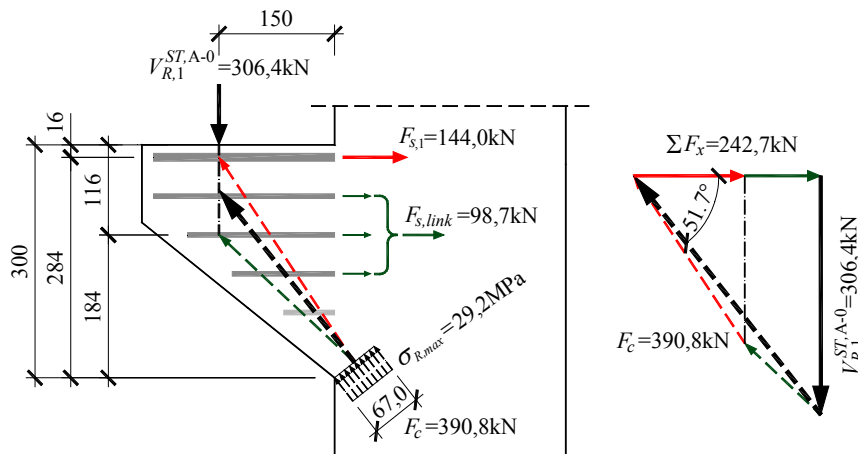

Rys. 3.15. Analiza nośności wspornika A – 0 za pomocą zmodyfikowanego modelu S-T

Fig. 3.15. Load carrying capacity analysis of corbel A – 0 according to modified strut and tie model

Podobną analizę przeprowadzono dla modelu B – 0. Również w tym przypadku, nośność eksperymentalna okazała się znacznie wyższa od nośności obliczonej według zasad [8] ($V_{test} / V_{EC2} = 240/179,1 \approx 1,34$). Dodatkowo należy zauważyć, że stosunek wysięgu wspornika do jego wysokości $a_c/h_c = 150/245 = 0,61 > 0,5$, co kwalifikowało wspornik do zastosowania strzemion pionowych. Zastosowane strzemiona poziome w modelu B – 0 należałyby zatem uznać za błąd konstrukcyjny. Podobnie jak w przypadku modelu A – 0, uwzględnienie dwóch strzemion jako dodatkowego zbrojenia głównego pozwoliło na uzyskanie lepszej zgodności nośności teoretycznej z eksperymentalną $V_{test} / V_{ST} = 240/216,9 \approx 1,11$.

Na kolejnym rys. 3.16 pokazano wyniki analizy wzmocnionego wspornika A – I, w przypadku którego uzyskano bardzo dobrą zgodność nośności teoretycznej z doświadczalną $V_{test} / V_{ST} = 465/445,1 \approx 1,04$. W analizie modelu B – I nośność teoretyczna okazała się natomiast większa od eksperymentalnej - $V_{test} / V_{ST} = 300/316,7 \approx 0,95$. Bezpośrednią przyczyną zniszczenia w tym przypadku był docisk stalowej podkładki kotwiącej wklejony pręt wzmocnienia – patrz rys. 3.17.

A similar analysis was carried out for the B – 0 corbel. Also in this case, the experimental load carrying capacity proved to be much higher than the value calculated according to principles [8] ($V_{test} / V_{EC2} = 240/179,1 \approx 1,34$). In addition, it should be noted that the ratio of the distance between column face and force to corbel height $a_c/h_c = 150/245 = 0,61 > 0,5$, which qualified the corbel for vertical stirrups use. The horizontal stirrups used in the B – 0 corbel should therefore be considered as a construction error. Similarly to the corbel A – 0, the inclusion of two stirrups as an additional main reinforcement allowed for better compatibility of the theoretical and experimental resistance $V_{test} / V_{ST} = 240/216,9 \approx 1,11$.

The results of strengthened corbel A – I analysis are presented in the Figure 3.16. In this case a very good correspondence between the theoretical and the experimental resistance was obtained $V_{test} / V_{ST} = 465/445,1 \approx 1,04$. The theoretical load capacity of the B – I corbel was higher than the experimental one - $V_{test} / V_{ST} = 300/316,7 \approx 0,95$. The direct cause of failure in this case was the local pressure of the steel anchor washer anchoring the strengthening rod – see Fig. 3.17.

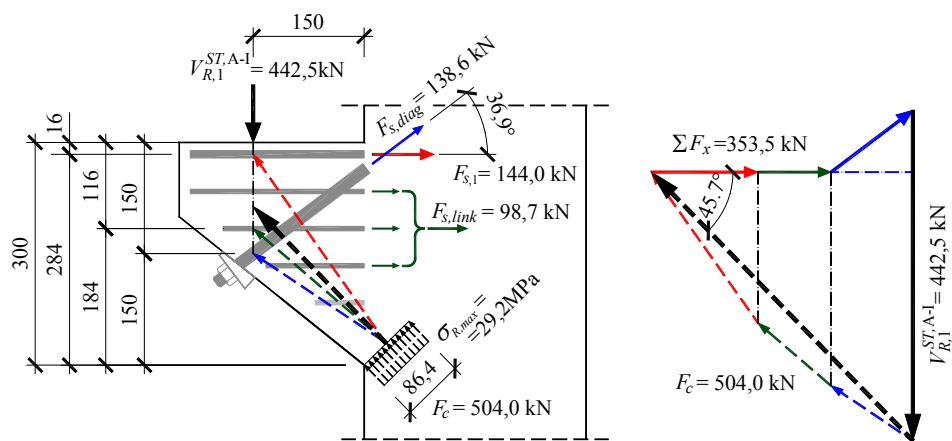

Rys. 3.16. Analiza nośności wspornika A – I za pomocą zmodyfikowanego modelu S-T
 Fig. 3.16. Load carrying capacity analysis of corbel A – I according to modified strut and tie model



Rys. 3.17. Widok wspornika B – I po zniszczeniu: a) z boku, b) płaszczyzna ściskana
 Fig. 3.17. View of corbel B – I after failure a) side, b) compressing surface

Analiza uzyskanych wyników serii A i B pozwoliła zaprojektować kolejną serię C uwzględniając doświadczenie z dwóch pierwszych serii (patrz rys. 3.10). Na rysunku 3.18 porównano odkształcenia zbrojenia głównego wsporników serii C. Na kolejnym rys. 3.19 pokazano widok po zniszczeniu wspornika C – 0 wraz z zerwaniem prętów zbrojenia głównego. W elemencie C – II doszło do zerwania ukośnego pręta wzmacniającego (patrz rys. 3.20).

The analysis of the obtained series A and B results led to the design of the next series (C) taking into account the observations from the first two series (see Figure 3.10). The comparison of main reinforcement strains of corbels series C is shown in Figure 3.18. The next figure 3.19 shows the view of the corbel C – 0 after failure with the rupture of the main reinforcement bars. In the C – II element, the diagonal strengthening rod was ruptured (see Fig. 3.20).

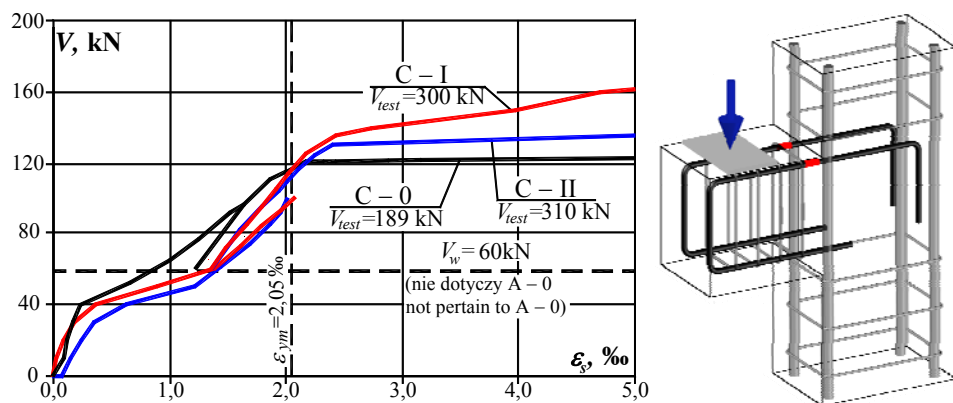

Rys. 3.18. Porównanie odkształceń zbrojenia głównego modeli: C – 0 i C – I i C – II
 Fig. 3.18. Comparison of corbels main reinforcement strains: C – 0, C – I and C – II

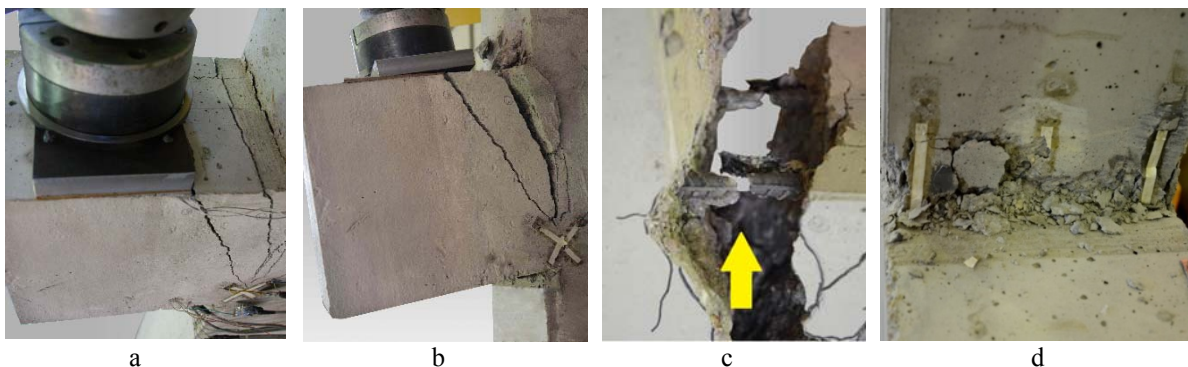

Rys. 3.19. Widok wspornika C-0 po zniszczeniu: a) rysy nad głównym zbrojeniem, b) widok ogólny, c) zerwany pręt zbrojenia głównego, d) zmiądzona krawędź ściskana
 Fig. 3.19. View of corbel C – 0 after failure: a) cracks above main reinforcement, b) general view, c) ruptured main bar, d) crushed compression edge



Rys. 3.20. Widok zerwanego ukośnego pręta wzmacniającego w elemencie C-II
 Fig. 3.20. View of ruptured diagonal strengthening rod in corbel C – II

Przeprowadzone badania wykazały znaczną skuteczność metody wzmacniania krótkich wsporników zbrojeniem wklejanym. Uzyskano następujące wzmocnienia:

- seria A – 38% ($V_{A-I} / V_{A-0} = 465/337 = 1,38$),
- seria B – 25% ($V_{B-I} / V_{B-0} = 300/240 = 1,25$),
- seria C – 60% ($V_{C-I} / V_{C-0} = 300/187 = 1,60$)
i 64% ($V_{C-II} / V_{C-0} = 310/187 = 1,66$).

Pod względem technologicznym, metodę można uznać za łatwą i szybką, umożliwiającą wzmacnianie bez całkowitego odciążenia konstrukcji. Zakotwienie prętów wzmacniających za pomocą kleju żywicznego okazało skuteczne i nie ograniczyło ich nośności. Teoretyczna analiza nośności wsporników wzmocnionych za pomocą zbrojenia wklejanego metodą S-T daje zbieżne wyniki z doświadczeniem. Uzupełnieniem tej metody powinno być sprawdzenie strefy zakotwienia zbrojenia wklejanego z uwagi na docisk do betonu.

Więcej szczegółów na temat uzyskanych wyników wsporników o smukłości $a_c/h_c > 0,3$ wzmacnianych wklejanym zbrojeniem zawiera praca [18, 38].

The tests have shown a significant effectiveness of the strengthening corbels using embedded rods. The following strengthening ratio were obtained:

- A series – 38% ($V_{A-I} / V_{A-0} = 465/337 = 1,38$),
- B series – 25% ($V_{B-I} / V_{B-0} = 300/240 = 1,25$),
- C series – 60% ($V_{C-I} / V_{C-0} = 300/187 = 1,60$)
and 64% ($V_{C-II} / V_{C-0} = 310/187 = 1,66$).

The method, in terms of technology, can be considered as easy and fast, allowing strengthening without completely unloading the structure. The anchoring of reinforcing rods with resin mortar proved effective and did not reduce their load carrying capacity. Theoretical analysis of corbels load carrying capacity strengthening with embedded reinforcement by the S-T method procedure results coincident with experiment. This method should be complemented by checking the local pressure of washer anchoring rods.

More details on the obtained results of the corbels with the slenderness $a_c/h_c > 0,3$ strengthening by embedded rods can be found in [18, 38].

3.5.2 Serie D i E

Serie D i E dotyczą wsporników krępych o stosunku wysięgu do wysokości $a_c/h_c \approx 0,3$. W takim przypadku tangens kąta nachylenia krzyżulca ściskanego θ równy jest około 2,4, co oznacza, że wsporniki były bliskie górnej granicy stosowalności metody Strut-and-Tie, która zgodnie z EN 1992-1-1 [8] jest ograniczona warunkiem: $1,0 \leq \tan\theta \leq 2,5$. Eurokod 2 nie podaje zaleceń, jak należy postępować w przypadku przekroczenia ograniczenia $\tan\theta > 2,5$.

3.5.2 Series D and E

Very short corbels with shear slenderness of $a_c/h_c \approx 0.3$, were investigated in series D and E. In this case, the tangent of the compression strut θ angle is equal to approximately 2.4, which means that the corbels were close to the limit of applicability of the Strut-and-Tie method for which, according to EN 1992-1-1 [8] the condition $1.0 \leq \tan\theta \leq 2.5$ is the limit. Eurokod 2 does not give recommendations on how to proceed if the condition $\tan\theta > 2.5$ is exceeded.

Tablica 3.2. Podstawowe dane wsporników serii D i E
Table 3.2. Basic data on the corbels series D and E

Element	wymiary dimensions			beton concrete f_{cm} [MPa]	zbroj. główne main reinforcement $\varnothing 16$		strzemiona stirrups $\varnothing 6$		pręt wklejany embedding rods $\varnothing 16$		V_{test} [kN]
	h_c [mm]	a_c [mm]	d [mm]		A_s [mm ²]	f_{ym} [MPa]	A_s [mm ²]	f_{ym} [MPa]	A_s [mm ²]	f_{ym} [MPa]	
D-0	450	150	284	45,1	227,6	533,6	28,1	385,6	-	-	990
D-I									141,1	870,1	1150
D-II									-	-	1208
E-0	125	125	225	47,3	227,6	533,6	28,1	385,6	-	-	1146
E-I			226						1510		
E-II			230						1032,0	1353	

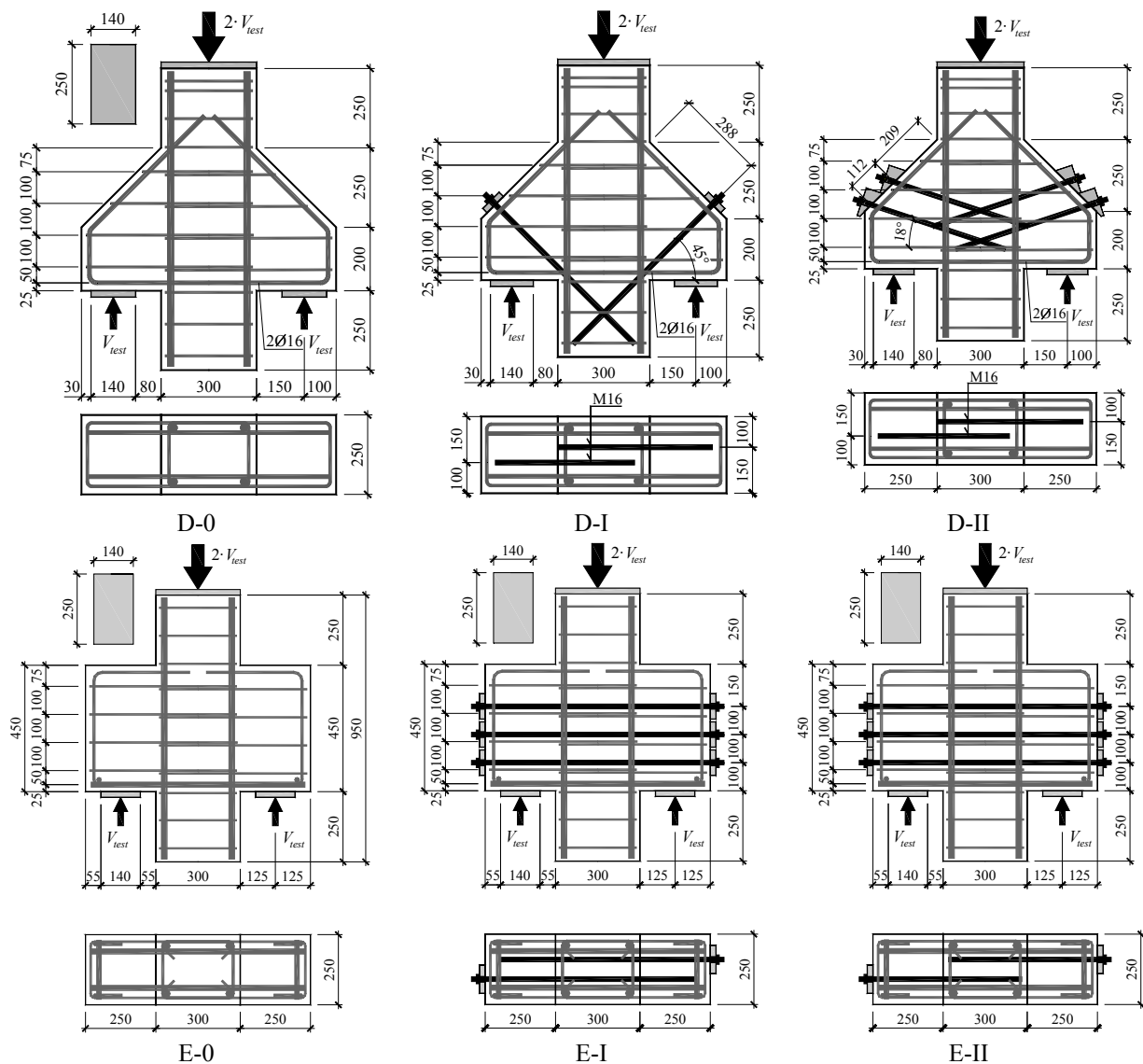

Rys. 3.21. Kształt, wymiary i zbrojenie wsporników serii D i E
Fig. 3.21. Shape, dimensions and reinforcement of the corbels series D and E

Pewną wskazówką może być określenie nośności takich wsporników według normy amerykańskiej ACI 318-14 [1] metodą shear – friction (ściananie – tarcie). Celem tej serii badań było sprawdzenie skuteczności wzmacniania wsporników bardzo krótkich za pomocą zbrojenia wklejanego. W Tabelicy 3.2 zestawiono podstawowe dane ciał próbnych serii D i E, a na rys. 3.21 pokazano ich konstrukcję.

Zniszczenie modeli poprzedzone było uplastycznieniem zbrojenia głównego. W przypadku modeli D-0, D-I i D-II miało to miejsce przy sile równej około 950 kN. Model D-0 uległ zniszczeniu w trakcie zwiększania nacisku tłoka w kolejnym kroku obciążenia. W przypadku modeli D-I i D-II uzyskano kilkunastoprocentowe zwiększenie obciążeń granicznych, równe odpowiednio 16 i 20%. Obserwacja zarysowania modeli D-0 i D-I wskazywała, iż rysa o największej szerokości rozwijała się wzdłuż teoretycznego krzyżulca ściskanego, wynikającego z modelu kratownicowego (patrz rys. 3.22). Można zatem przypuszczać, iż o ich nośności decydowała nośność krzyżulca ściskanego. Uwzględniając obserwacje poczynione w trakcie badania modelu D – I, zmodyfikowano koncepcję wzmocnienia elementu D – II. Z tego względu pręty wzmacniające zaprojektowano pod takim kątem, aby prostopadłe przecinały rysy. Wprowadzono dwa pręty prostopadłe do przebiegu teoretycznego krzyżulca ściskanego. Wymagało to zastosowania odpowiednich bloków kotwiących. Zbrojenie to miało za zadanie „zszyć” rysę ukośną mniej więcej w połowie długości krzyżulca. Mimo dwukrotnego zwiększenia liczby prętów w stosunku do elementu D-I nie uzyskano proporcjonalnego wzrostu nośności. Niszczenie modelu zostało bowiem zapoczątkowane na styku nachylonej powierzchni wspornika i boku słupa – patrz rys. 3.22. Podobne obrazy zniszczenia wsporników zarejestrowano dla serii E (rys. 3.23).

Some indication may be the determination of the load carrying capacity of such corbels according to the American code ACI 318-14 [1] by shear – friction. The purpose of this test series was to verify the effectiveness of strengthening very short corbels using embedded rods. In Table 3.2 the basic data of the specimens of series D and E are presented and their design is shown in Figure 3.21.

The failure of the corbels was preceded by the yielding of the main reinforcement. In the case of corbels D – 0, D – I and D – II, this happened at a force equal to approximately 950 kN. Elements D – 0 registered failure while increasing the pressure of the jack in the next load step. In the case of the D – I and D – II corbels, a more than ten per cent increase of loads was obtained and it was equal to 16 and 20% respectively. Observation of the crack pattern of the D – 0 and D – I models indicated that the crack with the largest width developed along the theoretical compression diagonal resulting from the truss model (see Fig. 3.22). It can therefore be assumed that their load carrying capacity was determined by the resistance of concrete strut. Taking into account the observations made during the investigation of the D – I corbel, the concept of strengthening element D – II was modified. Therefore, strengthening rods were designed to cross the crack perpendicularly. Two rods perpendicular to the theoretical location of the compression diagonal rods were introduced. This required using appropriate anchor blocks. This reinforcement was designed to "stitch" the diagonal crack in the middle of the cross-section length. Despite the double increase in the number of bars in relation to the D – I element, no proportional increase in load capacity was obtained. The failure of the model was initiated at the contact of the slope surface of the bracket and the side of the column – see Fig. 3.22. Similar images of the corbels' failure were registered for the E series (Fig. 3.23).



Rys. 3.22. Widok zniszczonych wsporników serii D
Fig. 3.22. View of corbels series D after failure

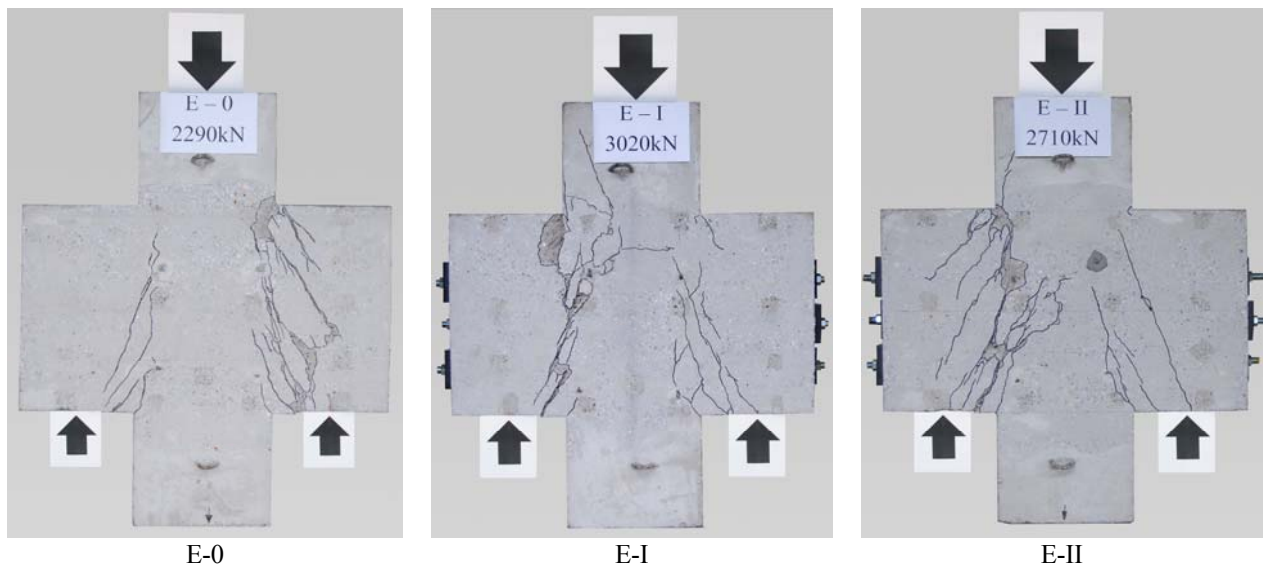

Rys. 3.23. Widok zniszczonych wsporników serii E
Fig. 3.23. View of corbels series E after failure

Należy zaznaczyć, że wedle poczynionych obserwacji zachowanie obu wsporników danego elementu było niemal identyczne (a przynajmniej zbliżone), choć zniszczenie następowało tylko w jednym wsporniku. Wykresy odkształcenia zbrojenia głównego elementów serii E na krawędzi słupa, po stronie wsporników zniszczonych, pokazano na rys. 3.24.

It should be noted that according to the observations, the behavior of both corbels of a given element was almost identical (or at least similar), although only one corbel was damaged. The main reinforcement strains diagrams of the E series elements on the column edge, on the failure corbel side, are shown in Fig. 3.24.

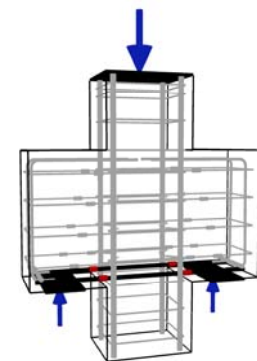
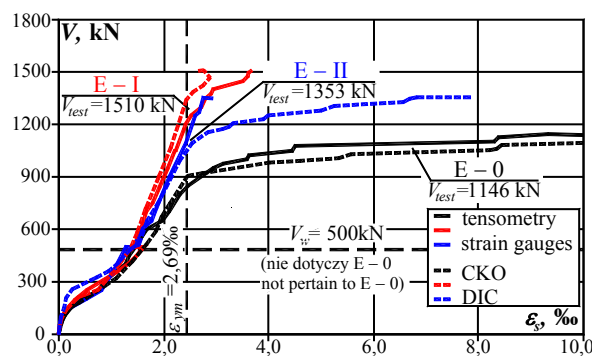

Rys. 3.24. Odkształcenia zbrojenia głównego wsporników serii E
Fig. 3.24. Strains of main reinforcement corbels series E (strain gauges and digital image correlation system)

Przeprowadzone badania wykazały, że wzmacnianie wsporników krępych o smukłości ścinania $a_c/h_c < 0,33$ za pomocą dodatkowego zbrojenia wklejanego może być mało efektywne. O ich nośności decyduje bowiem nośność krzyżulca ściskanego. Wnioski te potwierdzają wyniki opublikowane przez *Nagrodzką-Godycką* [26, 30]. Zastosowanie prętów pełniących rolę zbrojenia poprzecznego „zszywającego” rysę pozwala jedynie nieznacznie zwiększyć nośność wspornika.

The tests have shown that strengthening of very short corbels with shear slenderness of $a_c/h_c < 0,33$ using additional embedding reinforcement can may not be very effective. Their load capacity is determined by the resistance of the diagonal compression strut. These conclusions are confirmed by the results published by *Nagrodzka-Godycka* [26, 30]. The use of rods acting as a transverse reinforcement "stitching" the crack width allows only a slight increase of the load carrying capacity of the very short corbel.

3.5.3 Wsporniki wzmacnianie za pomocą stalowych akcesoriów

Program badań obejmował również wsporniki wzmacniane stalowymi akcesoriami. Były to elementy: C-III (smukłość $a_c/h_c \approx 0,60$), D-III, ($a_c/h_c \approx 0,33$), (E-III i F-I ($a_c/h_c \approx 0,28$)). Na rysunkach 3.25, 3.26, 3.27 i 3.28 pokazano konstrukcję tych elementów. Podstawowe dane pokazano w tablicy 3.3.

3.5.3 Corbels strengthening with steel accessories

The experimental program also included corbels strengthened by steel accessories. These were: C – III (shear slenderness of $a_c/h_c \approx 0.60$), D – III, ($a_c/h_c \approx 0.33$), (E – III and F – I ($a_c/h_c \approx 0.28$)). The design of these elements is shown in Figures 3.25, 3.26, 3.27 and 3.28. Basic data of the specimens is shown in Table 3.3.

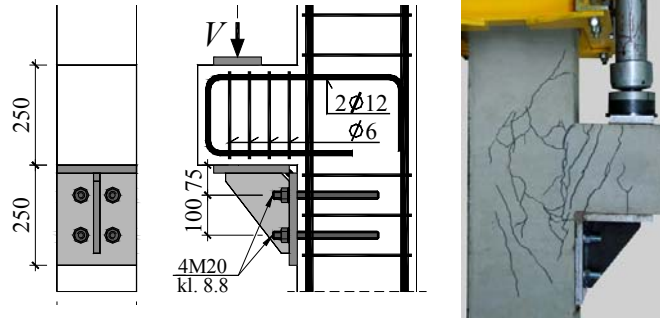

Rys. 3.25. Konstrukcja elementu C-III (szczegóły patrz załącznik) i widok zarysowania przy sile 477 kN
Fig. 3.25. Design of element C – III (see annex for details) and crack pattern by force 477 kN

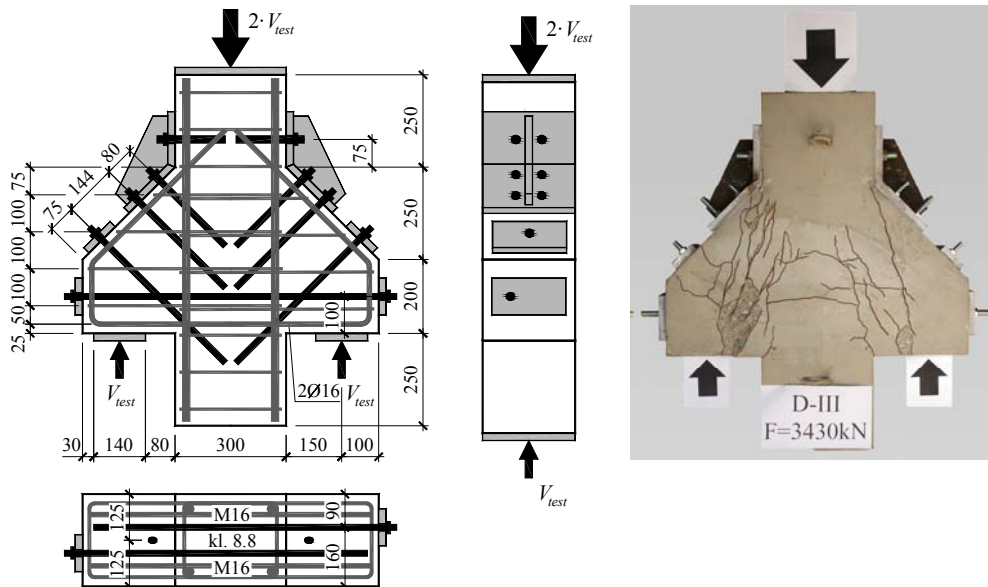

Rys. 3.26. Konstrukcja elementu D-III (szczegóły patrz załącznik) i widok po zniszczeniu
Fig. 3.26. Design of element D – III (see annex for details) and crack pattern after failure

Tablica 3.3. Podstawowe dane wsporników C-III, D-III, E-III i serii F

Table 3.3. Basic data on the corbels C-III, D-III, E-III i series F

Element	wymiary dimensions			beton concrete	zbroj. główne main reinforcement Ø16		strzemiona stirrups Ø6/8		pręt wklejany embedding rod Ø16/20		V_{test} [kN]
	h_c [mm]	a_c [mm]	d [mm]		f_{cm} [MPa]	A_s [mm ²]	f_{ym} [MPa]	A_s [mm ²]	f_{ym} [MPa]	A_s [mm ²]	
C – III	250	150		35,0	113,9	409,9	28,3	449,8	-	-	477*
D – III	450			45,1	200,5	533,6	28,1	385,6	141,1	825,9	1714
E – III				47,3							827,3
F – 0				35,2							2,01
F – I			1390								
F – II	-				-	-	-	228,0	856,4	650	

477* – maksymalna siła, ale nie niszcząca z powodu wyczerpania zakresu siłownika
maximum force, but is not failure loading, because it is ultimate loading of hydraulic jack

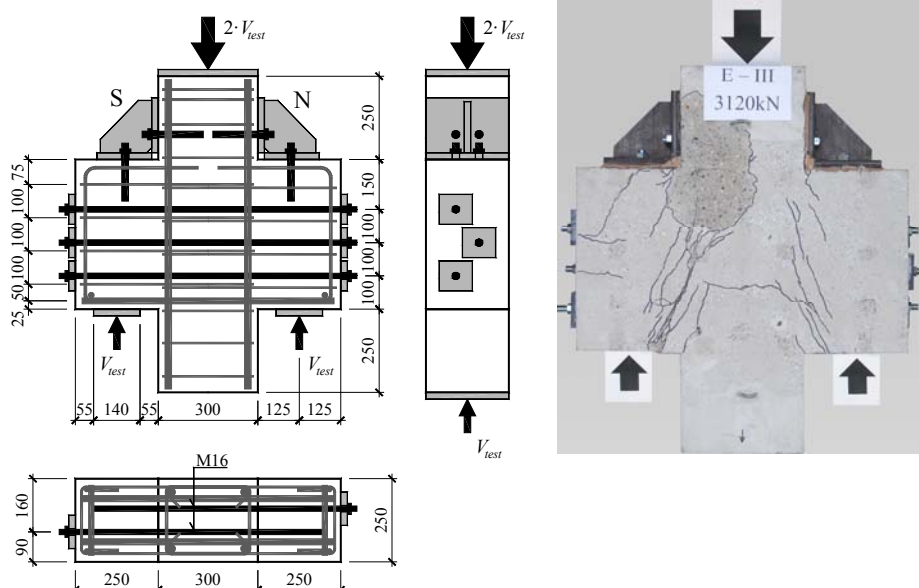

Rys. 3.27. Konstrukcja elementu E – III (szczegóły patrz załącznik)
 Fig. 3.27. Design of element E – III (see annex for details) and crack pattern after failure

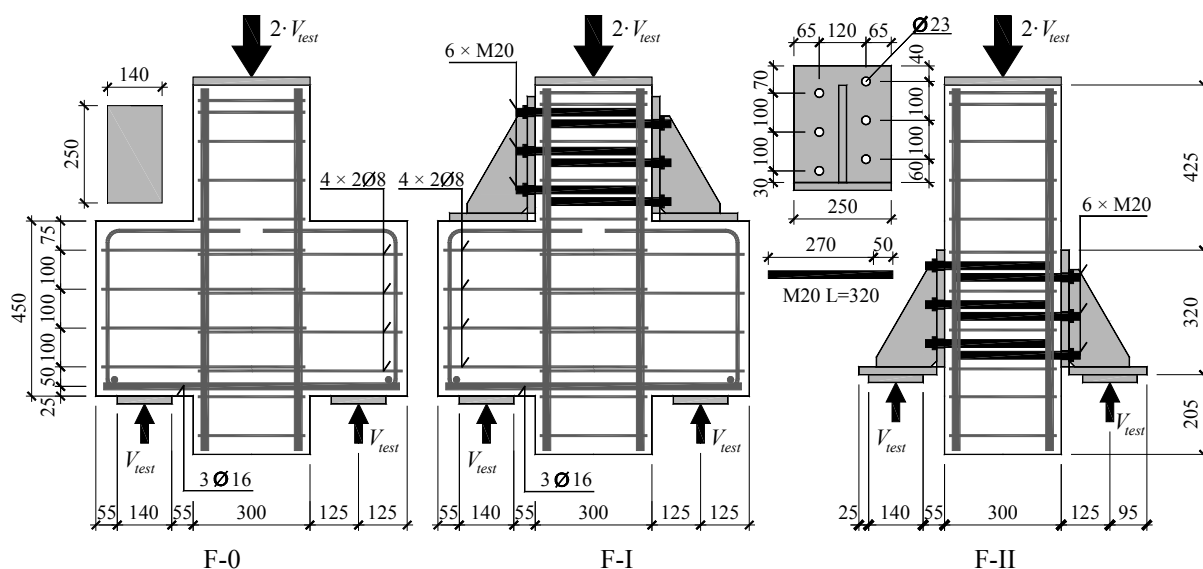

Rys. 3.28. Konstrukcja elementów serii F (szczegóły patrz załącznik)
 Fig. 3.28. Design of element F (see annex for details)

Element C – III nie został zniszczony z powodu wyczerpania możliwości stanowiska. Maksymalna siła przyłożona na wspornik wynosiła 477 kN, co stanowiło zwiększenie obciążenia w stosunku do elementu referencyjnego C – 0 o 152%. Po usunięciu wspornika żelbetowego doprowadzono do zniszczenia samego akcesorium stalowego. Zniszczenie nastąpiło wskutek wyrwania dwóch górnych śrub przy sile równej 253 kN (patrz rys. 3.29). Nośność samego stalowego wspornika okazała się większa od nośności żelbetowego wspornika modelu odniesienia C – 0 o 34%.

Zastosowanie stalowego akcesorium w elemencie D – III spowodowało znaczny wzrost nośności w stosunku do elementu referencyjnego D – 0 i dwóch pozostałych D – I i D – II wzmocnianych tylko prętami wklejonymi (o 73%, 49% i 29% odpowiednio). Na rysunku 3.30 pokazano wykresy odkształceń zbrojenia głównego elementów D – I, D – II i D – III.

Element C – III did not fail due to excessive hydraulic jack pressure relative to its load capacity. The maximum force applied to the corbel was 477 kN, which was an increase by 152% in comparison to the reference element (C – 0). After removing the reinforced concrete corbel, the steel accessory was tested. The failure took place as a result of pulling the two upper bolts at a force equal to 253 kN (see Fig. 3.29). The load carrying capacity of the steel accessory was higher than the reference corbel C – 0 by 34%.

The use of a steel accessory in the D – III element resulted in a significant ratio of load carrying capacity increase to the reference element D – 0 and the other two D – I and D – II strengthened only by embedding rods (by 73%, 49% and 29% respectively). Strains diagrams of the main reinforcement in elements D – I, D – II and D – III are shown in Figure 3.30.

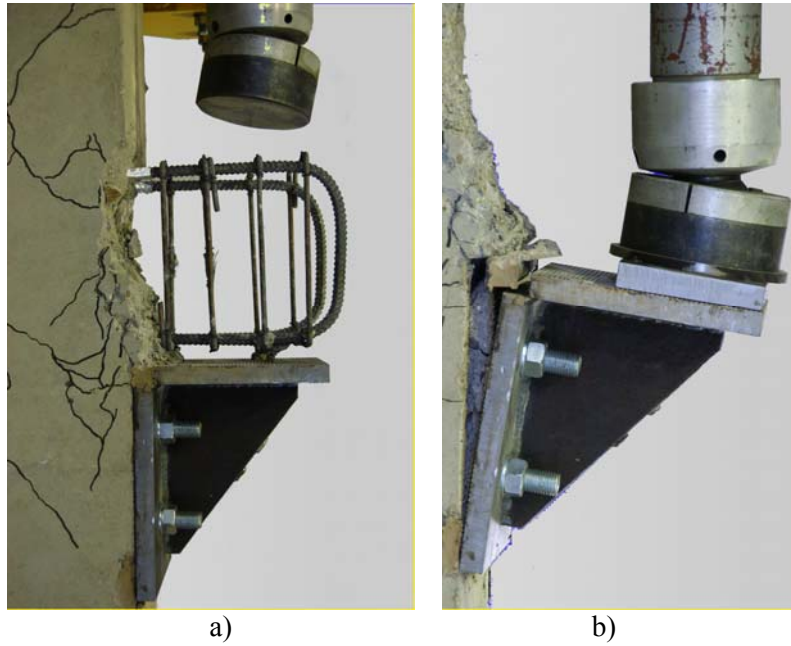

Rys. 3.29. Widok wspornika C – III: a) po usunięciu betonu, b) po zniszczeniu samego stalowego wzmocnienia w wyniku wyrwania śrub kotwiących
 Fig. 3.29. View of the corbel C – III: a) after removing the concrete, b) after failure of the steel reinforcement as a result of pulling the anchoring rods

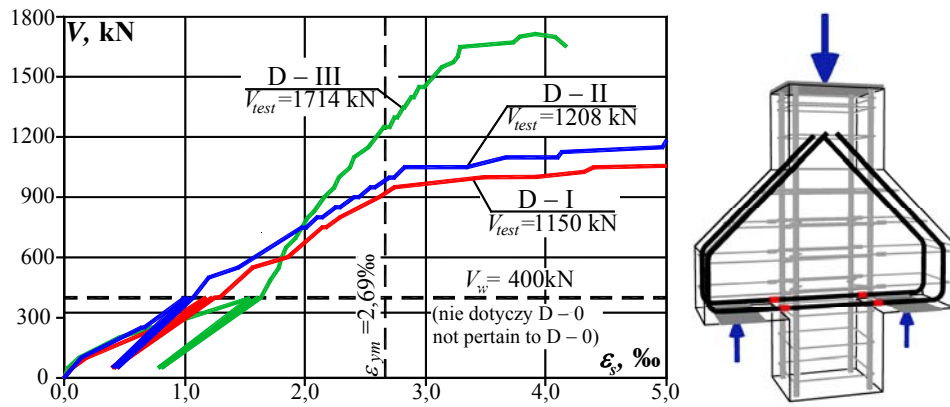

Rys. 3.30. Odształcenia zbrojenia głównego elementów D – I, D – II i D – III.
 Fig. 3.30. Strains of main reinforcement elements D – I, D – II and D – III

Pozytywny wpływ stalowego akcesorium został w tych pomiarach wyraźnie ujawniony. Podobny efekt zaobserwowano w elementach serii F (patrz rys. 3.31).

The positive effect of the steel accessory has been clearly revealed in these measurements. A similar effect was observed in the F series (see Fig. 3.31).

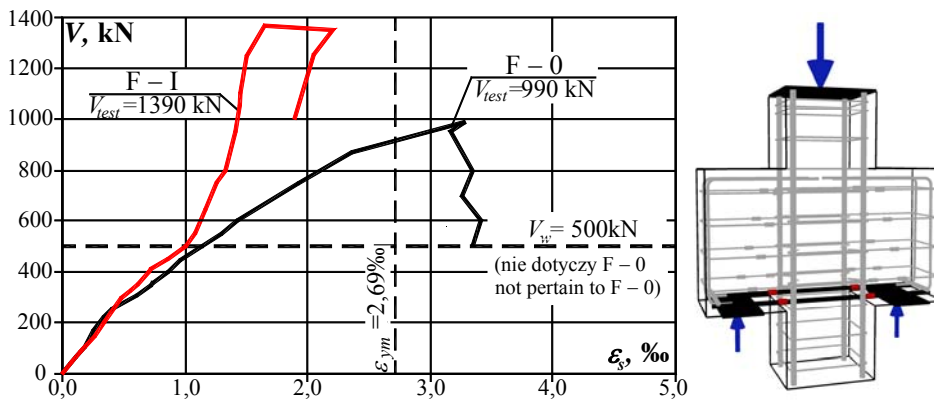

Rys. 3.31. Odształcenia zbrojenia głównego – seria F
 Fig. 3.31. Strains of main reinforcement – series F

3.5.4 Analiza współników bardzo krótkich

Chcąc porównać otrzymane nośności z wartościami oszacowanymi na podstawie różnych zaleceń wykonano obliczenia. Skorzystano z podejścia shear-friction *Masta* [22], które stało się podstawą do opracowania amerykańskich zaleceń normowych [1]. Siły przewidywane jako niszczące oznaczono V^{S-F} . Przeprowadzono również obliczenia zgodne z metodą extended shear friction V^{MC2010} opublikowaną przez *Randla* [33, 34] i umieszczoną w Model Code 2010 [23]. Zastosowano model zaproponowany przez *Nagrodzka-Godycką* [29], wyniki oznaczono jako V^{KNG} . Nośność współników porównano także z wynikami analizy wykonanej zgodnie z hipotezą Mohra [24] $V^{Mohr,zbr}$ zakładając stan czystego przecinania w styku pomiędzy licem słupa a wspornikiem. Dodatek nośności ze względu na występujące zbrojenie uwzględniono stosując zalecenia *Parka* i *Paulaya* [32] przytaczane przez *Godyckiego-Ćwirko* [11]. Siły niszczące V_{test} , jak i poszczególne wartości przewidziane zgodnie z przytoczonymi metodami obliczeniowymi zapisano w tabelicy 3.4. Policzono także stosunki nośności do wartości przewidywanych. Więcej szczegółów powyższych obliczeń można znaleźć w pracy [18].

3.5.4 Analysis of very short corbels

In order to compare the experimental load carrying capacities with the values estimated on the basis of various recommendations, calculations were made. The shear-friction approach *Mast* [22] was used. It was the basis for developing American Code [1] recommendations. The calculated ultimate forces were denoted as V^{S-F} . Calculations were also carried out in accordance with the extended shear friction method V^{MC2010} published by *Randl* [33, 34] and placed in Model Code 2010 [23]. The model proposed by *Nagrodzka-Godycka* [29] was also used, and the results are denoted as V^{KNG} . The load carrying capacity of corbel was also compared with the results of the analysis performed according to the Mohr hypothesis [24] $V^{Mohr,zbr}$ assuming the state of pure shear between the face of the column and the corbel. The load carrying capacity addition due to the reinforcement was taken into account using recommendations of *Park and Paulay* [32] quoted by *Godycki-Ćwirko* [11]. The ultimate experimental forces V_{test} , as well as values predicted in accordance with the calculation methods quoted above, are presented in Table 3.4. The ratio of experimental to predicted forces was also calculated. More details of the above calculations can be found in [18].

Tablica 3.4. Porównanie nośności teoretycznych i eksperymentalnych współników serii D, E i F
Table 3.4. Comparison between theoretical and experimental load carrying capacity of corbels series D, E and F

Element	V_{test}	V^{S-F}	$\frac{V_{test}}{V^{S-F}}$	V^{MC2010}	$\frac{V_{test}}{V^{MC2010}}$	V^{KNG}	$\frac{V_{test}}{V^{KNG}}$	$V^{Mohr,zbr}$	$\frac{V_{test}}{V^{Mohr,zbr}}$
	kN	kN	–	kN	–	kN	–	kN	–
D – 0	990	390,6	2,53	543,2	1,82	586,8	1,69	826,6	1,20
D – I	1150	599,0	1,92	647,2	1,78	766,1	1,50	973,0	1,18
D – II	1208	793,5	1,51	732,3	1,64	836,5	1,43	1051,6	1,15
E – 0	1146	360,6	2,93	450,9	2,54	654,4	1,75	857,2	1,34
E – I	1510	1612,8	0,94	1121,3	1,35	1318,7	1,15	1359,3	1,11
E – II	1353	1001,7	1,35	786,1	1,72	1028,2	1,32	1108,3	1,22
F – 0	990	640,3	1,79	569,6	1,74	865,9	1,50	846,0	1,17
średnia / average			1,85		1,80		1,48		1,20
odch. st. / SD			0,687		0,362		0,206		0,073

Zgodnie z wynikami zamieszczonymi w tabelicy 3.4 najbardziej zachowawcze wyniki otrzymuje się korzystając z metody zaproponowanej przez *Masta* [22], jednocześnie uzyskano znaczne wartości odchylenia standardowego (0,687). Niemal równie wysoką wartość zapasu nośności stwierdzono dla metody *Randla* [33, 34], w tym przypadku otrzymano znacznie niższy rozrzut wyników. Używając metody *Nagrodzkiej-Godyckiej* [29] otrzymano średni zapas nośności wynoszący 48% i odchylenie standardowe 0,206. Dla analizy inspirowanej hipotezą *Mohra* średnia wartość stosunku siły niszczącej do obliczonej wynosi 1,20 przy bardzo niskim rozrzucie wyników.

According to the results in Table 3.4, the most conservative results are obtained using the method proposed by *Mast* [22], while significant standard deviations (0.687) were obtained. Almost equally high value of reserve of load capacity was found for the *Randl* method [33, 34], in this case a much lower spread of results was obtained. Using the *Nagrodzka-Godycka* [29] method, an average reserve of capacity was 48% and a standard deviation of 0.206 was obtained. For the analysis inspired by *Mohr's* hypothesis, the mean value of the ultimate experimental to calculated force ratio is 1.20 with very low spread of results.

4. PODSUMOWANIE

Zaprezentowane badania dotyczą wzmacniania krótkich wsporników żelbetowych o różnej smukłości ścinania i stosunkowo niskim stopniu zbrojenia podłużnego (dla serii F $\rho_l \approx 0,6\%$, dla pozostałych $\rho_l \approx 0,4\%$). Na rysunku 4.1 zaprezentowano procentowy wzrost nośności poszczególnych elementów. Należy stwierdzić, że wklejając pręty łatwiej jest zwiększyć nośność elementów o umiarkowanej smukłości (wzrost do 64%) niż wsporników bardzo krępych (do 32%). Bardzo efektywne okazało się zastosowanie akcesorium stalowego w elemencie C – III (wzrost ponad 154%). Nośność zarówno elementu stalowego jak i wklejenia do słupa w tym przypadku były większe od siły przenoszonej przez wspornik żelbetowy. Stosowanie akcesoriów stalowych i prętów wklejanych spowodowało istotny wzrost nośności dla elementów bardzo krępych (do 73%).

4. CONCLUSIONS

The presented research pertain to the strengthening of short reinforced concrete corbels with different shear slenderness and a relatively low degree of longitudinal reinforcement (for series F $\rho_l \approx 0.6\%$, for the remaining $\rho_l \approx 0.4\%$). The percentage increase in load capacity of individual elements is shown in Figure 4.1. It should be noted that by embedding rods it is easier to increase the load capacity of moderately slender elements (up to 64%) than very compact ones (up to 32%). Using a steel accessory in the C – III element proved very effective (over 154% increase). The load carrying capacity of both the steel element and the embedding to the column in this case was higher than the ultimate force of the reinforced concrete corbel. The use of steel accessories and embedding rods resulted in a significant increase in load carrying capacity for very compact elements (up to 73%).

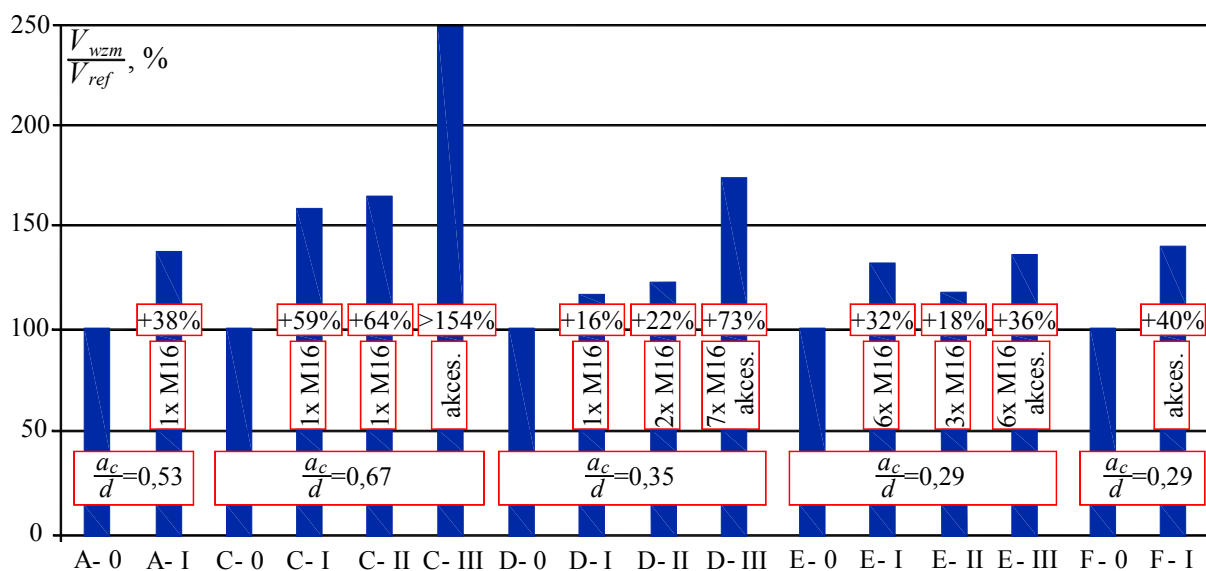

Rys. 4.1. Przyrost nośności poszczególnych wsporników
Fig. 4.1. Increase of load carrying capacity for the individual corbels

Prezentowane badania wykazały, że istnieje możliwość zwiększenia nośności wspornika poprzez wklejanie dodatkowego zbrojenia. Skuteczność wzmocnienia zależy od wielu czynników między innymi smukłości ścinania, liczby i nachylenia prętów wklejonych, zastosowanego zbrojenia pierwotnego. W przypadku wsporników o umiarkowanej smukłości ścinania istnieje możliwość precyzyjnego obliczania nośności elementów modelami kratownicowymi.

The presented investigations have shown that it is possible to increase the load carrying capacity of the corbel by embedding additional reinforcement. The effectiveness of reinforcement depends on many factors: slenderness, number and inclination of embedding rods, initial reinforcement among others. In the case of moderately slender shear corbels, it is possible to precisely calculate the load carrying capacity of the elements using strut and tie models.

LITERATURA / REFERENCES

- [1] ACI 318-14 Building Code Requirements for Structural Concrete and Commentary for Building Code Requirements for Structural Concrete (ACI 318R-14), Farmington Hills, 2014;
- [2] Ahmad, S. et al.: Shear Strengthening of Corbels with Carbon Fibre Reinforced Polymers (CFRP). *Mater. Construcción*. 60, 299, 79–97 (2010);
- [3] Assih, J. et al.: Concrete damaged analysis in strengthened corbel by external bonded carbon fibre fabrics. *Appl. Adhes. Sci.* 3, 1–13 (2015);
- [4] Campione, G. et al.: Flexural behaviour of concrete corbels containing steel fibers or wrapped with FRP sheets. *Mater. Struct.* 38, 6, 617–625 (2005);
- [5] Corry, R.W., Dolan, C.W.: Strengthening and Repair of a Column Bracket Using a Carbon Fiber Reinforced Polymer (CFRP) Fabric. *PCI J.* 46, 1, 54–63 (2001);
- [6] Elgwady, M.A. et al.: Strengthening of Corbels Using CFRP an Experimental Program. (2005);
- [7] El-Maaddawy, T.A., Sherif, E.-S.I.: Response of Concrete Corbels Reinforced with Internal Steel Rebars and External Composite Sheets: Experimental Testing and Finite Element Modeling. *J. Compos. Constr.* 18, 1, (2014);
- [8] EN 1992-1-1: Eurocode 2: Design of Concrete Structures – Part 1: General rules and rules for buildings European Committee For Standardization, 2008;
- [9] Feix J., Worle P. i Gerhard A.: Ein neuer Ansatz zur Steigerung der Durchstantrag-fähigkeit bestehender Stahlbetonbauteile. *Bauingenieur*, April, 2012. s. 149-155;
- [10] Fernández Ruiz, M. et al.: Strengthening of Flat Slabs Against Punching Shear Using Post-Installed Shear Reinforcement. *ACI Struct. J.* 107, 4, 434–442 (2010).
- [11] Godycki-Ćwirko, T.: *Mechanika betonu*. Arkady, Warszawa (1982).
- [12] Hassanzadeh G i Sundqvist H.: Strengthening of Bridge Slabs on Columns. *Nordic Concrete Research* (online, dostep: 21.10.2003, www.itn.is/ncr/publications/pub-21.htm), 1988. str. 12.
- [13] Ivanova, I. et al.: Experimental investigation into strengthened short reinforced concrete corbels by bonding carbon fiber fabrics. *J. Adhes. Sci. Technol.* 29, 20, 2176–2189 (2015);
- [14] Ivanova, I. et al.: Influence of Fabrics Layers on Strengthened Reinforced Concrete Short Corbels. *Int. J. Civ. Eng.* 5, 11, 33–43 (2014);
- [15] Ivanova, I.: Mechanical behavior of short concrete corbels reinforced or repaired by bonding of composite materials (in French). Université De Reims Champagne-Ardenne École, Université De Technologie Chimique Et De Métallurgie (Bulgarie) (2013);
- [16] Ivanova, I., Assih, J.: Experimental study of local behavior of strengthened reinforced concrete short corbels by bonding carbon fiber fabrics. *Int. J. Civ. Struct. Eng. Res.* 4, 1, 148–158 (2015);
- [17] Ivanova, I., Assih, J.: Static and dynamic experimental study of strengthened reinforced short concrete corbel by using carbon fabrics, crack path in shear zone. *Frat. ed Integrità Strutt.* 34, 90–98 (2015);
- [18] Krawczyk, Ł.: Wzmacnianie krótkich wsporników żelbetowych zbrojeniem wklejanym. (Strengthening of short corbels with embedded through-section reinforcement), rozprawa doktorska (PhD thesis) Politechnika Łódzka (2017).
- [19] Kriz, L.B., Rath, C.H.: Connections in Precast Concrete Structures- Strength of Corbels. *PCI J.* 10, 1, 16–61 (1965);
- [20] Kunz J., Ruiz F., Muttoni A.: Enhanced safety with post-installed shear reinforcement. *FIB Symposium Tel Awiw 22-24 April 2013, Engineering a Concrete Future: Technology, Modeling and Construction, Proceedings*;
- [21] Lachowicz, M., Nagrodzka-Godycka, K.: Experimental study of the post tensioned prestressed concrete corbels. *Eng. Struct.* 108, 1–11 (2016);
- [22] Mast, R.F.: Auxiliary Reinforcement in Concrete Connections. *J. Struct. Div.* 94, 6, 1485–1504 (1968).
- [23] Model Code 2010 - Final draft, (2012).
- [24] Mohr, O.: Welche Umstände bedingen die Elastizitätsgrenze und den Bruch eines Materials? *Zeitschrift des Vereins Dtsch. Ingenieure*. 44, 1524–1530 (na podstawie innych prac) (1900).
- [25] Mohammed, A.A., Assi, D.K.: Behavior of reinforced concrete corbels strengthened with ferrocement sheets. *GAU J. Soc. App. Sci.* 6, 10, 93–102 (2014);
- [26] Nagrodzka-Godycka, K.: Badania bardzo krótkich wsporników żelbetowych. *Inżynieria i Bud.* 57, 6, 349–350 (2001);
- [27] Nagrodzka-Godycka, K.: Behavior of Corbels with External Prestressing Bars - Experimental Study. *ACI Struct. J.* 96, 6, 1033–1039 (1999);
- [28] Nagrodzka-Godycka, K.: Efekt wzmocnienia zarysowanych wsporników żelbetowych w świetle badań eksperymentalnych. *Inżynieria i Bud.* 52, 5, 281–285 (1995);
- [29] Nagrodzka-Godycka, K.: *Wsporniki żelbetowe: badania, teoria, projektowanie*. Wydawnictwo Politechniki Gdańskiej (2001);
- [30] Nagrodzka-Godycka, K.: Wzmacnianie wsporników żelbetowych. *Przegląd Bud.* 69, 5, 11–13 (1997).
- [31] Ozden, S., Atalay, H.M.: Strengthening of reinforced concrete corbels with GFRP overlays. *Sci. Eng. Compos. Mater.* 18, 1–2, 69–77 (2011);
- [32] Park, Robert and Paulay, T.: *Reinforced Concrete Structures*. (1975)
- [33] Randl, N.: Design recommendations for interface shear transfer in fib Model Code 2010. *Struct. Concr.* 14, 3, 230–241 (2013).
- [34] Randl, N., Wicke, M.: Schubübertragung zwischen Alt- und Neubeton. *Experimentelle Untersuchungen, theoretischer*

- Hintergrund und Bemessungsansatz. Beton- und Stahlbetonbau. 95, 8, 461–473 (2000)
- [35] Shadhan, K.K., Kadhim, M.M.M.: Use of CFRP Laminates for Strengthening of Reinforced Concrete Corbels. Int. J. Civ. Eng. Technol. 6, 11, 11–20 (2015);
- [36] Urban T.: Badania eksperymentalne stref ścinania wzmocnionych zbrojeniem wklejanym. XLII Konf. Nauk. KILiW PAN i KN PZITB, Krynica 1996, Tom 5, s. 149÷156;
- [37] Urban T.: Wzmacnianie konstrukcji żelbetowych metodami tradycyjnymi. Wydawnictwo Naukowe PWN, Warszawa 2015, ss. 197;
- [38] Urban T., Krawczyk Ł.: Strengthening corbels using post-installed threaded rods. Structural Concrete. 2017;18:303-315;

1. Czkwianianc A., Kamińska M., *Badania monolitycznych węzłów żelbetowych ram portalowych [Tests of RC Portal Frames Corners]*, Ułańska D., *Badania jednoprzęsłowych tarcz ze wspornikami [Research on Single Span Deep Beams with Brackets]*. Badania doświadczalne elementów i konstrukcji żelbetowych, Z. 1, Wydawnictwo Katedry Budownictwa Betonowego Politechniki Łódzkiej, Łódź 1991.
2. Czkwianianc A., Kamińska M., *Badania monolitycznych ram portalowych obciążonych siłami pionowymi lub poziomymi [Tests of RC Portal Frames Subjected to Vertical or Lateral Force]*. Badania doświadczalne elementów i konstrukcji żelbetowych, Z. 2, Wydawnictwo Katedry Budownictwa Betonowego Wydziału Budownictwa i Architektury Politechniki Łódzkiej, Łódź 1993.
3. Urban T., *Nośność na przebicie w aspekcie proporcji boków słupa [Punching Capacity in Aspect of Column Cross Section Ratio]*. Badania doświadczalne elementów i konstrukcji żelbetowych, Z. 3, Wydawnictwo Katedry Budownictwa Betonowego Wydziału Budownictwa, Architektury i Inżynierii Środowiska Politechniki Łódzkiej, Łódź 1994.
4. Ułańska D., *Przenoszenie sił ścinających przez zbrojenie osiowo rozciągane w zarysowanych przekrojach elementów żelbetowych [Transfer of Shear Forces Through the Axially Tension Reinforcement in Cracked Reinforced Concrete Sections Experimental Investigations]*. Badania doświadczalne elementów i konstrukcji żelbetowych, Z. 4, Wydawnictwo Katedry Budownictwa Betonowego Wydziału Budownictwa i Architektury Politechniki Łódzkiej, Łódź 1995.
5. Kozicki J., Urban T., Sitnicki M., *Badania modelu stropu płytowo-słupowego poddanego działaniu obciążeń krótko i długotrwałych [Tests on Model of Slab - Column Structure Subject to Short- and Longlasting Loads]*. Badania doświadczalne elementów i konstrukcji żelbetowych, Z. 5, Wydawnictwo Katedry Budownictwa Betonowego Wydziału Budownictwa i Architektury Politechniki Łódzkiej, Łódź 1995.
6. Czkwianianc A., *Badania doświadczalne płaskich i przestrzennych węzłów monolitycznych ustrojów prętowych [Experimental Investigations of Beam - Column Joints]*, Urban T., Kosińska A., Czkwianianc A., *Badania doświadczalne węzłów płytowo ściennych [Experimental Investigations of Slab - Wall Joints]*, Badania doświadczalne elementów i konstrukcji żelbetowych, Z. 6, Wydawnictwo Katedry Budownictwa Betonowego Wydziału Budownictwa i Architektury Politechniki Łódzkiej, Łódź 1995.
7. Kamińska M.E., *Doświadczalne badania żelbetowych słupów ukośnie mimośrodowo ściskanych [Experimental Investigations of RC Columns under Biaxial Bending]*, Badania doświadczalne elementów i konstrukcji żelbetowych, Z. 7, Wydawnictwo Katedry Budownictwa Betonowego Wydziału Budownictwa i Architektury Politechniki Łódzkiej, Łódź 1995
8. Kamińska M.E., *Doświadczalne badania żelbetowych elementów prętowych z betonu wysokiej wytrzymałości [Experimental research on HSC one-dimensional members]*, Badania doświadczalne elementów i konstrukcji żelbetowych, Z. 8, Wydawnictwo Katedry Budownictwa Betonowego Wydziału Budownictwa i Architektury Politechniki Łódzkiej, Łódź 1999
9. Kamińska M.E., Kotynia R., *Doświadczalne badania żelbetowych belek wzmocnionych taśmami CFRP [Experimental research on RC beams strengthened with CFRP strips]*, Badania doświadczalne elementów i konstrukcji żelbetowych, Z. 9, Wydawnictwo Katedry Budownictwa Betonowego Wydziału Budownictwa i Architektury Politechniki Łódzkiej, Łódź 2000
10. Kosińska A., Nowakowski A.B., *Doświadczalne badania żelbetowych elementów poddanych skręcaniu [Experimental research on RC elements under torsion]*, Badania doświadczalne elementów i konstrukcji żelbetowych, Z. 10, Wydawnictwo Katedry Budownictwa Betonowego Wydziału Budownictwa i Architektury Politechniki Łódzkiej, Łódź 2001
11. Bodzak P., Czkwianianc A., *Doświadczalne badania monolitycznych ram żelbetowych – strefa skrajnego węzła [Experimental research on RC frames – edge joint zone]*, Badania doświadczalne elementów i konstrukcji żelbetowych, Z. 11, Wydawnictwo Katedry Budownictwa Betonowego Wydziału Budownictwa i Architektury Politechniki Łódzkiej, Łódź 2000
12. Czkwianianc A., Pawlica J., Ułańska D., Skurcz i pełzanie betonów samozagęszczalnych *[Shrinkage and creep of self compacting concrete SCC]*, Badania doświadczalne elementów i konstrukcji żelbetowych, Z. 12, Wydawnictwo Katedry Budownictwa Betonowego Wydziału Budownictwa i Architektury Politechniki Łódzkiej, Łódź 2004
13. Kotynia R., Kamińska M.E., *Odkształcalność i sposób zniszczenia żelbetowych belek wzmocnionych na zginanie materiałami kompozytowymi CFRP [Ductility and failure mode of RC beam strengthened for flexure with CFRP]*, Badania doświadczalne elementów i konstrukcji żelbetowych, Z. 13, Wydawnictwo Katedry Budownictwa Betonowego Wydziału Budownictwa i Architektury Politechniki Łódzkiej, Łódź 2000

15. Kotynia R., Kamińska M.E., Ignatowski P., *Badania doświadczalne elementów ściskanych wzmocnionych materiałami kompozytowymi CFRP [Experimental research on CFRP confined RC members]*, Badania doświadczalne elementów i konstrukcji żelbetowych, Z. 15, Wydawnictwo Katedry Budownictwa Betonowego Wydziału Budownictwa i Architektury Politechniki Łódzkiej, Łódź 2000
16. Kotynia R., *Przyczepność zbrojenia kompozytowego do betonu w żelbetowych elementach wzmocnionych za pomocą materiałów kompozytowych CFRP [Bond between composite materials and concrete in reinforced concrete members strengthened with CFRP composites]* Badania doświadczalne elementów i konstrukcji żelbetowych, Z. 16, Wydawnictwo Katedry Budownictwa Betonowego Wydziału Budownictwa i Architektury Politechniki Łódzkiej, Łódź 2008
17. Czkwianianc A., Bodzak P., Pawlica J., Habiera E., *Badania sprężonych elementów betonowych zespolonych z profilem stalowym [Tests of the elements made from prestressed concrete connected with the steel profiles]* Badania doświadczalne elementów i konstrukcji żelbetowych, Z. 17, Wydawnictwo Katedry Budownictwa Betonowego Wydziału Budownictwa i Architektury Politechniki Łódzkiej, Łódź 2010
18. Urban T., Sitnicki M., Tarka J., *Badania połączeń płyta – słup wzmocnianych zewnętrznie na przebiecie [Investigation of slab - column connection externally strengthened on punching]*. Badania doświadczalne elementów i konstrukcji żelbetowych, Z. 18, Wydawnictwo Katedry Budownictwa Betonowego Wydziału Katedry Budownictwa i Architektury Politechniki Łódzkiej, Łódź 2012
19. Urban T., Krakowski J., Gołdyn M., Krawczyk Ł., *Przebiecie żelbetowych płyt krępych [Punching of RC thick plates]*. Badania doświadczalne elementów i konstrukcji żelbetowych, Z. 19, Wydawnictwo Katedry Budownictwa Betonowego Wydziału Katedry Budownictwa i Architektury Politechniki Łódzkiej, Łódź 2013
20. Urban T., Gołdyn M., Krawczyk Ł., *Nośność słupów żelbetowych z betonu o wysokiej wytrzymałości przewartwionych płytą betonu o niższej wytrzymałości [Load carrying capacity of high – strenght reinforced concrete columns intersected by lower – strenght reinforced concrete slabs]*. Badania doświadczalne elementów i konstrukcji żelbetowych, Z. 20, Wydawnictwo Katedry Budownictwa Betonowego Wydziału Katedry Budownictwa i Architektury Politechniki Łódzkiej, Łódź 2016
21. Kotynia R., Lasek K., *Efektywność zastosowania wstępnie naprężonych taśm CFRP do wzmocniania belek żelbetowych na zginanie [Strenthening efficiency of RC beams strengthened for flexure with prestressed CFRP laminates]*. Badania doświadczalne elementów i konstrukcji żelbetowych, Z. 21, Wydawnictwo Katedry Budownictwa Betonowego Wydziału Katedry Budownictwa i Architektury Politechniki Łódzkiej, Łódź 2018

Załącznik

Wyniki pomiarów

Appendix

Results of measurements

Serie A i B
A and B Series

Wykres $\sigma - \varepsilon$ dla: / $\sigma - \varepsilon$ diagram for:

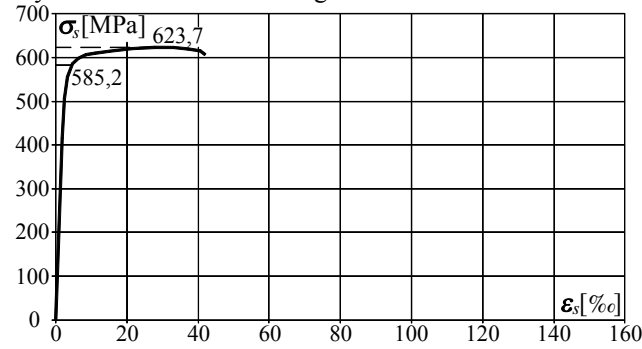

prętów zbrojeniowych Ø6 / reinforcement bars Ø6

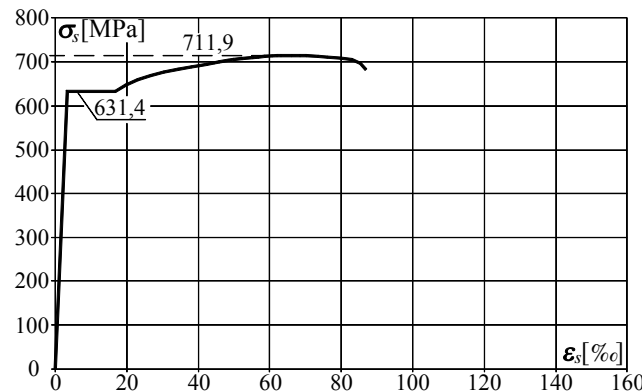

prętów zbrojeniowych Ø12 / reinforcement bars Ø12

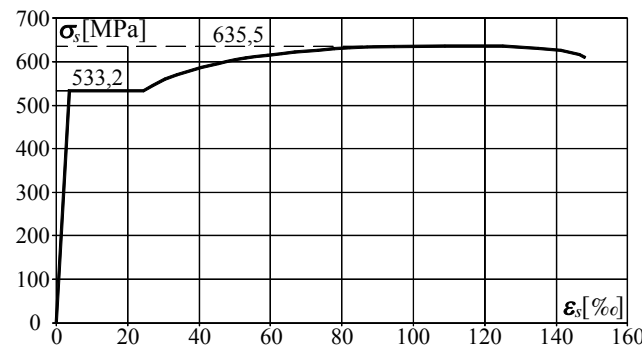

prętów zbrojeniowych Ø20 / reinforcement bars Ø20

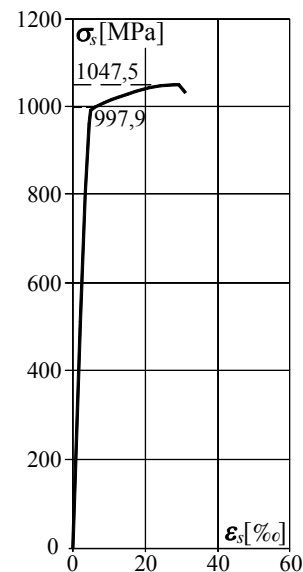

prętów gwintowanych M16 / threaded rods M16

Tabele $\sigma - \varepsilon$ dla: / $\sigma - \varepsilon$ table for:

ε_s	σ_s	ε_s	σ_s
%	MPa	%	MPa
0	0	15,24	614,7
1,76	400	20,0	619,1
2,39	500	27,8	623,7
4,55	585,2	37,1	619,7
6,73	600	41,9	606,9

prętów Ø6 / bars Ø6, $A_s=28,09\text{mm}^2$

ε_s	σ_s	ε_s	σ_s
%	MPa	%	MPa
0	0	50	705,7
3,157	631,4	60	711,9
16,76	631,4	70	711,9
20	648,5	80	708,3
30	676,3	86,7	682,5
40	691,5		

prętów Ø12 / bars Ø12, $A_s=114,60\text{mm}^2$

ε_s	σ_s	ε_s	σ_s
%	MPa	%	MPa
0	0	80	631,0
2,666	533,2	90	634,3
24,35	533,2	100	635,5
30	558,9	120	635,5
40	585,8	130	633,3
50	604,9	140	627,1
60	615,5	147,8	609,5
70	624,2		

prętów Ø20 / bars Ø20, $A_s=316,01\text{mm}^2$

ε_s	σ_s	ε_s	σ_s
%	MPa	%	MPa
0	0	20	1040,6
2,46	600	29,2	1047,5
3,40	800	31,0	1031,5
4,06	900		
6,03	997,9		

prętów gwintowanych M16 / rods M16, $A_s=138,90\text{mm}^2$

Beton – seria A / Concrete – A series

	f_{cm}	E_{cm}	$f_{ct,sp}$	ρ_c
	MPa	GPa	MPa	kg/m ³
średnia / average	33,68	25,90	3,13	2200
odchylenie standardowe / standard deviation	1,066	1,35	0,236	11,7
współczynnik zmienności / coefficient of variation	6,16%	5,23%	7,54%	0,53%
liczba próbek / number of specimens	12	4	9	26
minimalna wartość / minimum value	31,2	24,20	2,90	2181
maksymalna wartość / maximum value	35,1	27,30	3,65	2220

Rozwój wytrzymałości betonu w czasie – seria A / Development of the concrete strength in time – A series

data / date	badany element / tested specimen	wiek / age	f_{cm}
		dni / days	MPa
2014-09-09		70	32,87
2014-09-12		73	35,10
2014-09-15		76	33,45
2014-09-26		87	33,76
2014-11-06	A-0	128	34,80
2014-11-13	A-I	135	
średnia / average			33,68
odchylenie standardowe / standard deviation			1,066
współczynnik zmienności / coefficient of variation			3,16%
liczba próbek / number of specimens			12
minimalna wartość / minimum value			31,2
maksymalna wartość / maximum value			35,1

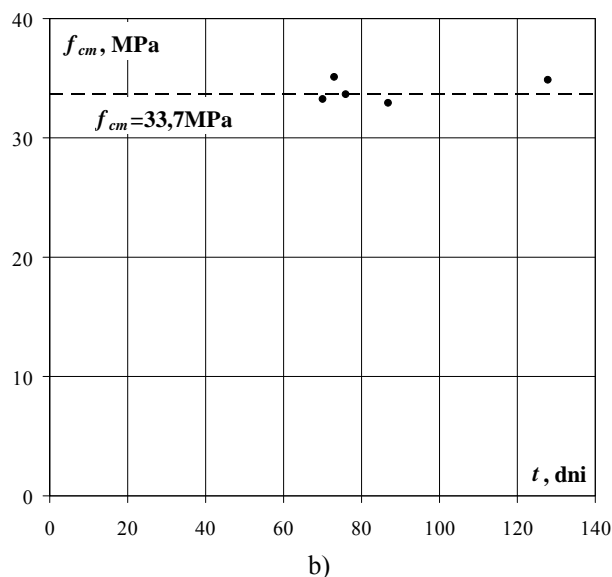
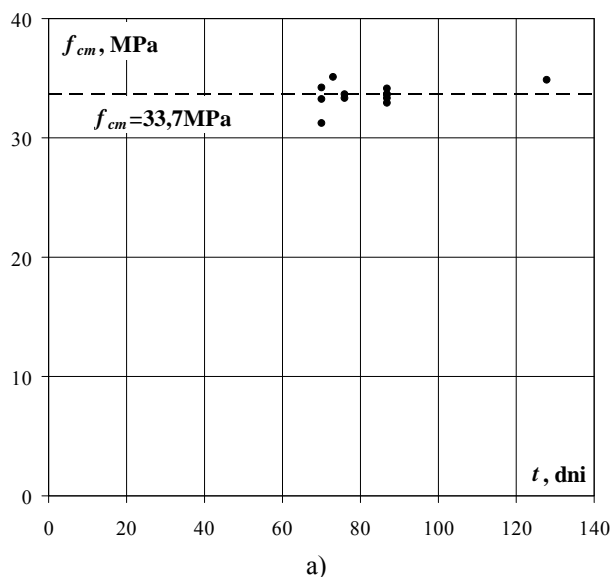

Rozwój wytrzymałości betonu w czasie – seria A: a) wyniki badań, b) średnie dzienne
Development of the concrete strength in time – A series: a) test results, b) daily average

Beton – seria B / Concrete – B series

	f_{cm}	E_{cm}	$f_{ct,sp}$	ρ_c
	MPa	GPa	MPa	kg/m ³
średnia / average	23,91	19,67	2,28	2104
odchylenie standardowe / standard deviation	1,258	4,16	0,029	19,5
współczynnik zmienności / coefficient of variation	5,26%	2,12%	1,26%	0,93%
liczba próbek / number of specimens	9	3	3	15
minimalna wartość / minimum value	22,1	19,20	2,25	2070
maksymalna wartość / maximum value	25,7	20,00	2,30	2140

Rozwój wytrzymałości betonu w czasie – seria B / Development of the concrete strength in time – B series

data / date	badany element / tested specimen	wiek / age	f_{cm}
		dni / days	MPa
2014-12-15	B-0	123	23,77
2014-12-22	B-I	130	24,20
średnia / average			23,91
odchylenie standardowe / standard deviation			1,258
współczynnik zmienności / coefficient of variation			5,26%
liczba próbek / number of specimens			9
minimalna wartość / minimum value			22,1
maksymalna wartość / maximum value			25,7

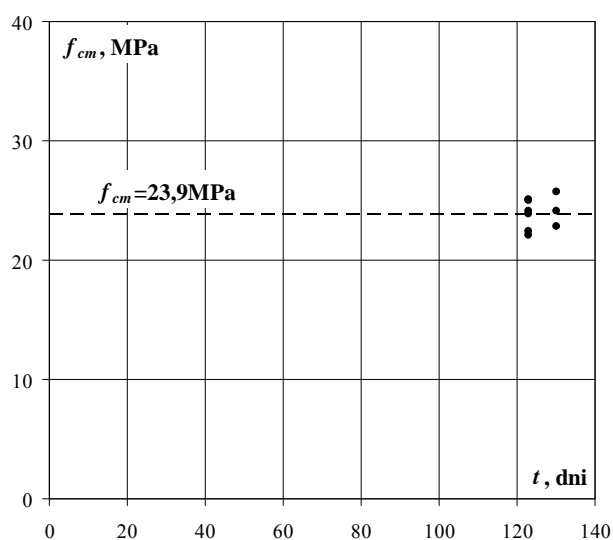

a)

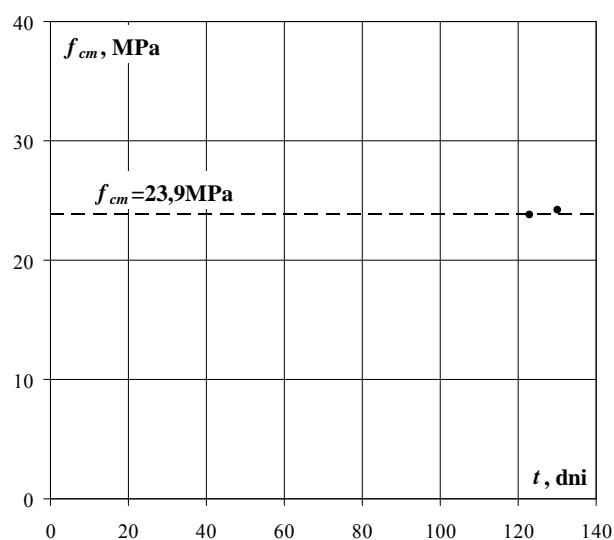

b)

Rozwój wytrzymałości betonu w czasie – seria B: a) wyniki badań, b) średnie dzienne
 Development of the concrete strength in time – B series: a) test results, b) daily average

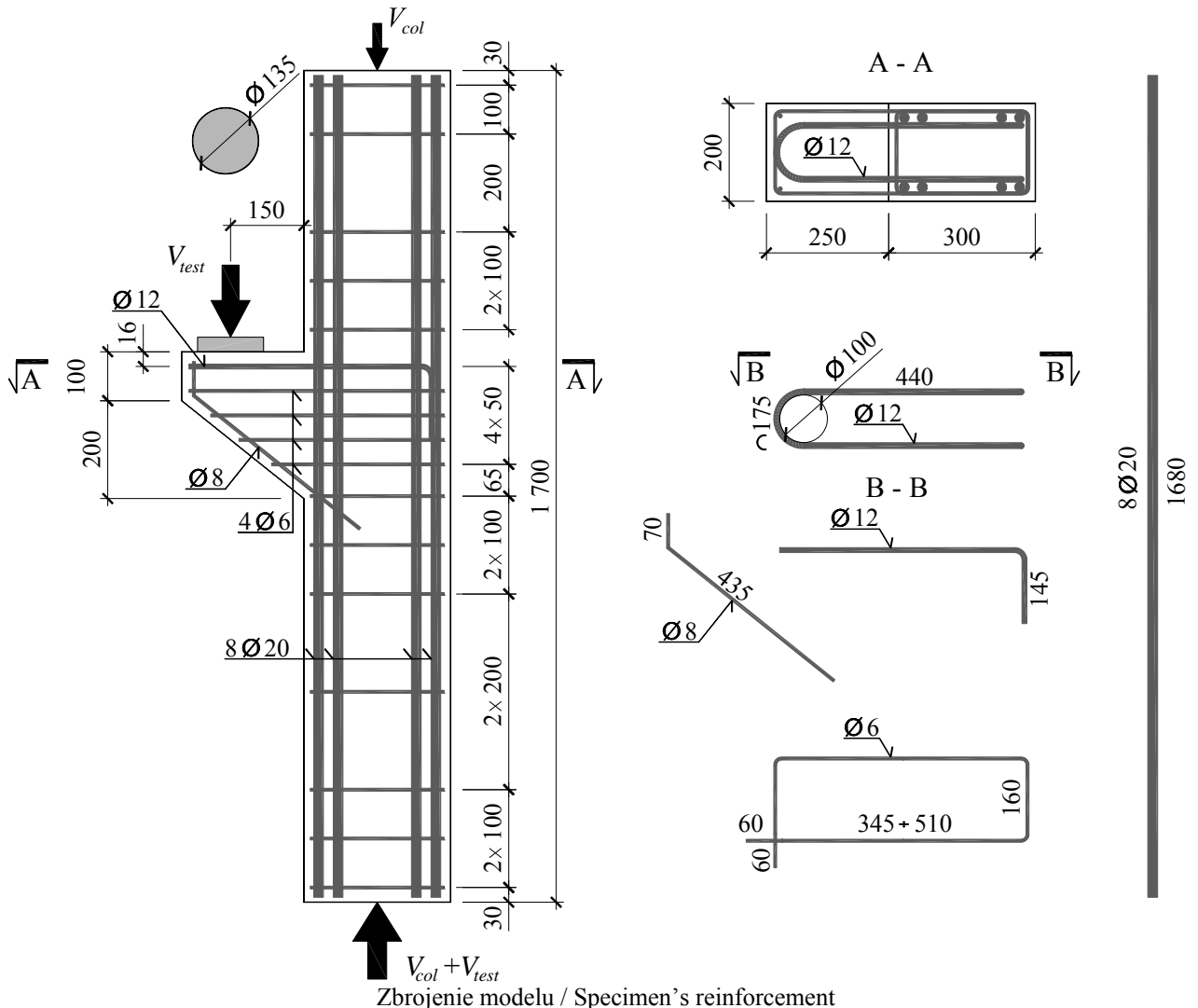

Wytrzymałość betonu na ściskanie / Compressive strength of concrete

$$f_{cm} = 33,7\text{MPa}$$

Wytrzymałość kostkowa betonu na ściskanie / Compressive cube strength of concrete

$$f_{c,cube} = 38,8\text{MPa}$$

Moduł sprężystości podłużnej / Young's modulus

$$E_{cm} = 25,9\text{GPa}$$

Wytrzymałość betonu na rozciąganie przy rozłupywaniu / Tensile splitting strength of concrete

$$f_{ct,sp} = 3,1\text{MPa}$$

Gęstość betonu / Density of concrete

$$\rho = 2200\text{kg/m}^3$$

Charakterystyka zbrojenia / Characteristics of the reinforcement

Ø6

$$A_s = 28,09\text{mm}^2, f_{ym} = 585,2\text{MPa}, f_{tm} = 623,7\text{MPa}$$

Ø12

$$A_s = 114,6\text{mm}^2, f_{ym} = 627,5\text{MPa}, f_{tm} = 711,9\text{MPa}$$

Ø20

$$A_s = 316,01\text{mm}^2, f_{ym} = 533,2\text{MPa}, f_{tm} = 635,5\text{MPa}$$

Siła niszcząca / Failure force

$$V_{test} = 337\text{kN}$$

A-0

Zbrojenie główne – odkształcenia (ϵ_s) / Main reinforcement – strains (ϵ_s)

obciążenie słupa column load	obciążenie wspornika corbel load	odkształcenie strain		
		1	2	średnia/ average
kN	kN	‰	‰	‰
0	0	0,000	0,000	0,000
0	0	0,000	0,000	0,000
50	0	-0,009	-0,012	-0,011
100	0	-0,007	-0,010	-0,009
150	0	-0,006	-0,012	-0,009
150	10	0,067	0,069	0,068
150	20	0,128	0,136	0,132
150	30	0,195	0,206	0,201
150	40	0,258	0,272	0,265
150	50	0,331	0,357	0,344
150	60	0,429	0,485	0,457
150	70	0,523	0,623	0,573
150	80	0,612	0,768	0,690
150	90	0,694	0,890	0,792
150	100	0,767	1,007	0,887
150	110	0,874	1,162	1,018
150	120	0,984	1,241	1,113
150	130	1,100	1,351	1,226
150	140	1,204	1,517	1,361
150	150	1,321	1,614	1,468
150	160	1,420	1,684	1,552
150	170	1,543	1,751	1,647
150	180	1,640	1,794	1,717
150	180	1,635	1,785	1,710
150	190	1,750	1,861	1,806
150	200	1,863	1,924	1,894
150	210	1,960	1,931	1,946
150	220	2,063	1,967	2,015
150	230	2,165	1,967	2,066
150	230	2,168	1,917	2,043
150	240	2,286	2,018	2,152
150	251	2,449	2,042	2,246
150	262	2,541		2,541
150	272	2,669		2,669
150	282	2,900		2,900
150	292	3,120		3,120
150	303	3,471		3,471
150	312	2,462		2,462

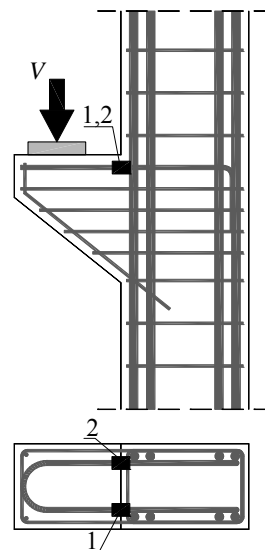
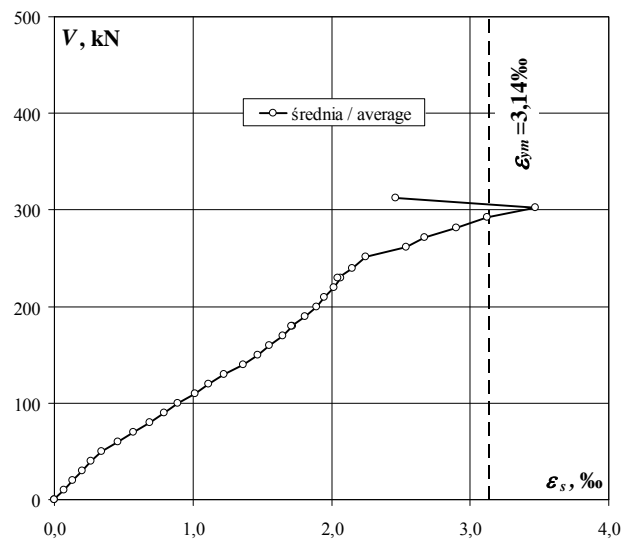
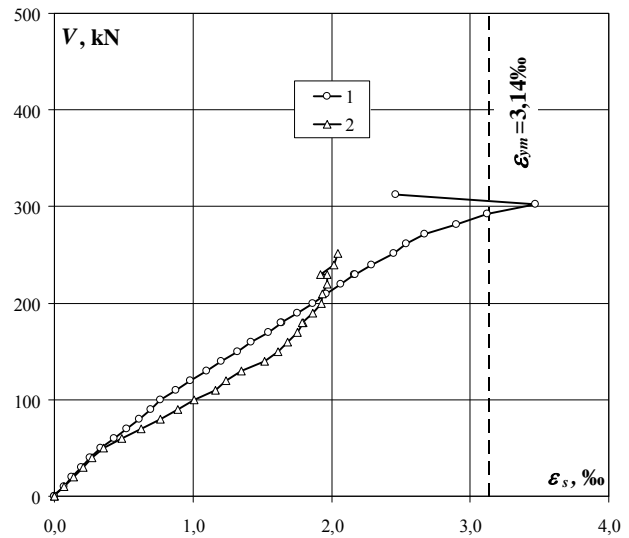

Szerokość rozwarcia rys / Crack width

obciążenie słupa column load	obciążenie wspornika corbel load	Numer rysy Crack number					
		1	2	3	4	5	6
kN	kN	mm	mm	mm	mm	mm	mm
150	20	0,01					
150	80	0,10					
150	100	0,15					
150	110	0,16	0,01				
150	150	0,20	0,15				
150	160	0,20	0,15	0,01			
150	200	0,20	0,25	0,10			
150	210	0,20	0,25	0,10			
150	230	0,25	0,40	0,10			
150	251	0,25	0,50	0,10			
150	322	1,00	1,00				

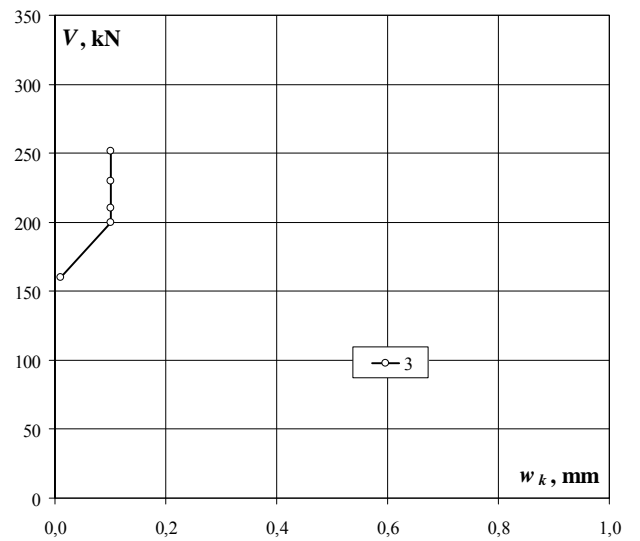
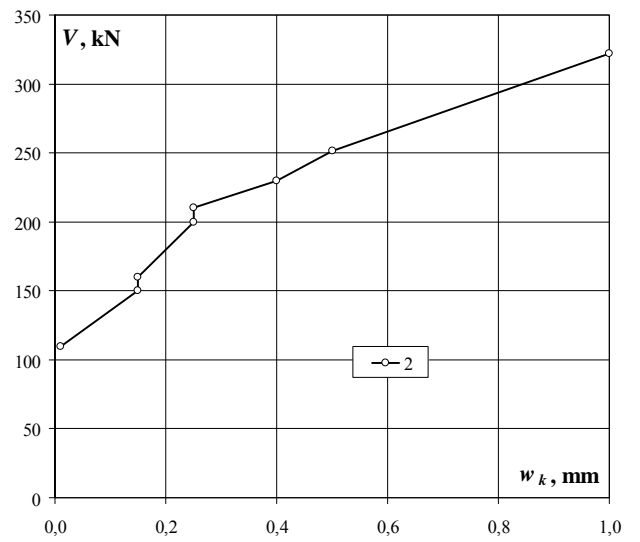
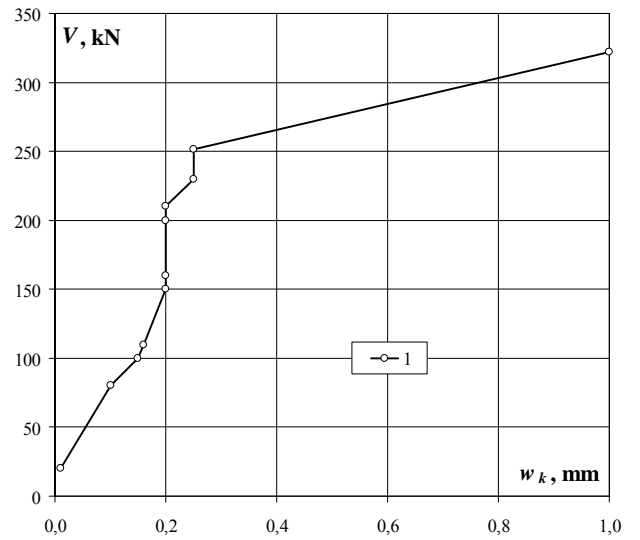

A-0

Układ rys przy sile 337kN / Crack pattern at 337kN

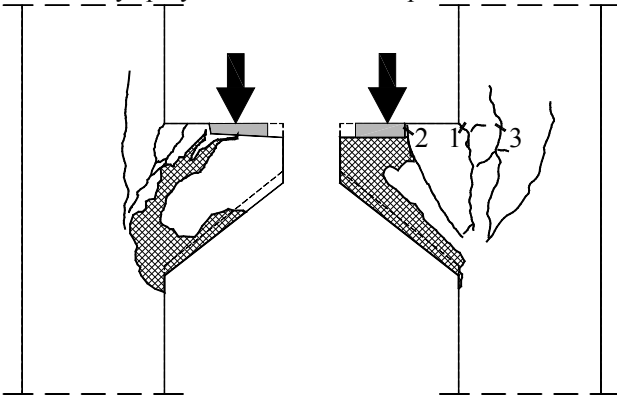

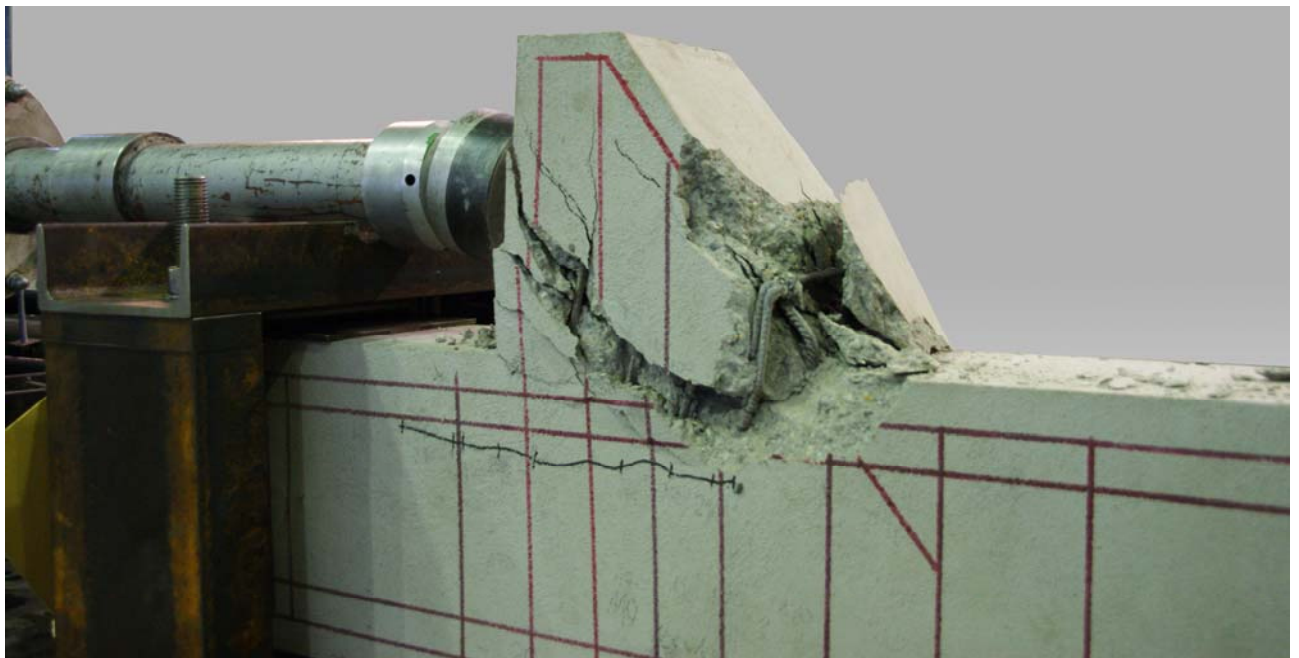
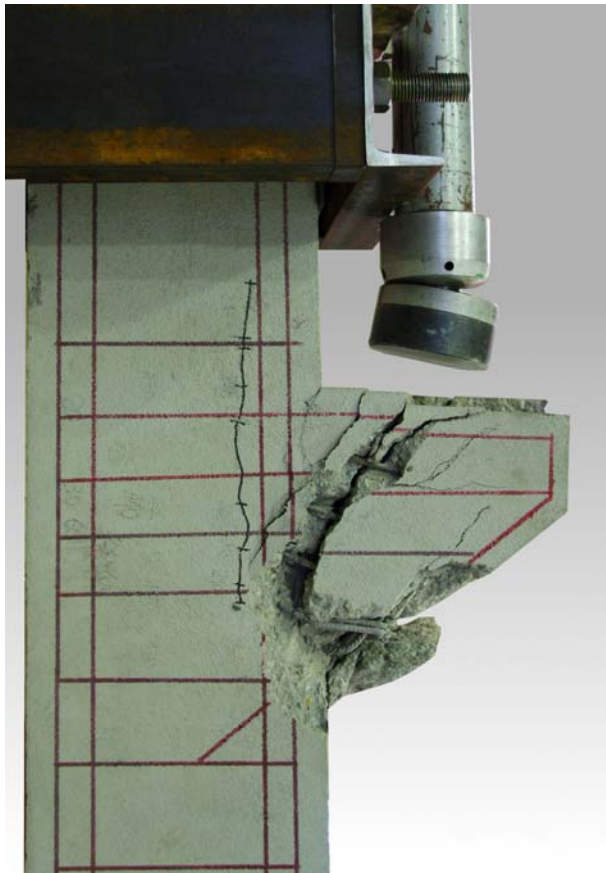

Wspornik po zniszczeniu / Corbel after failure

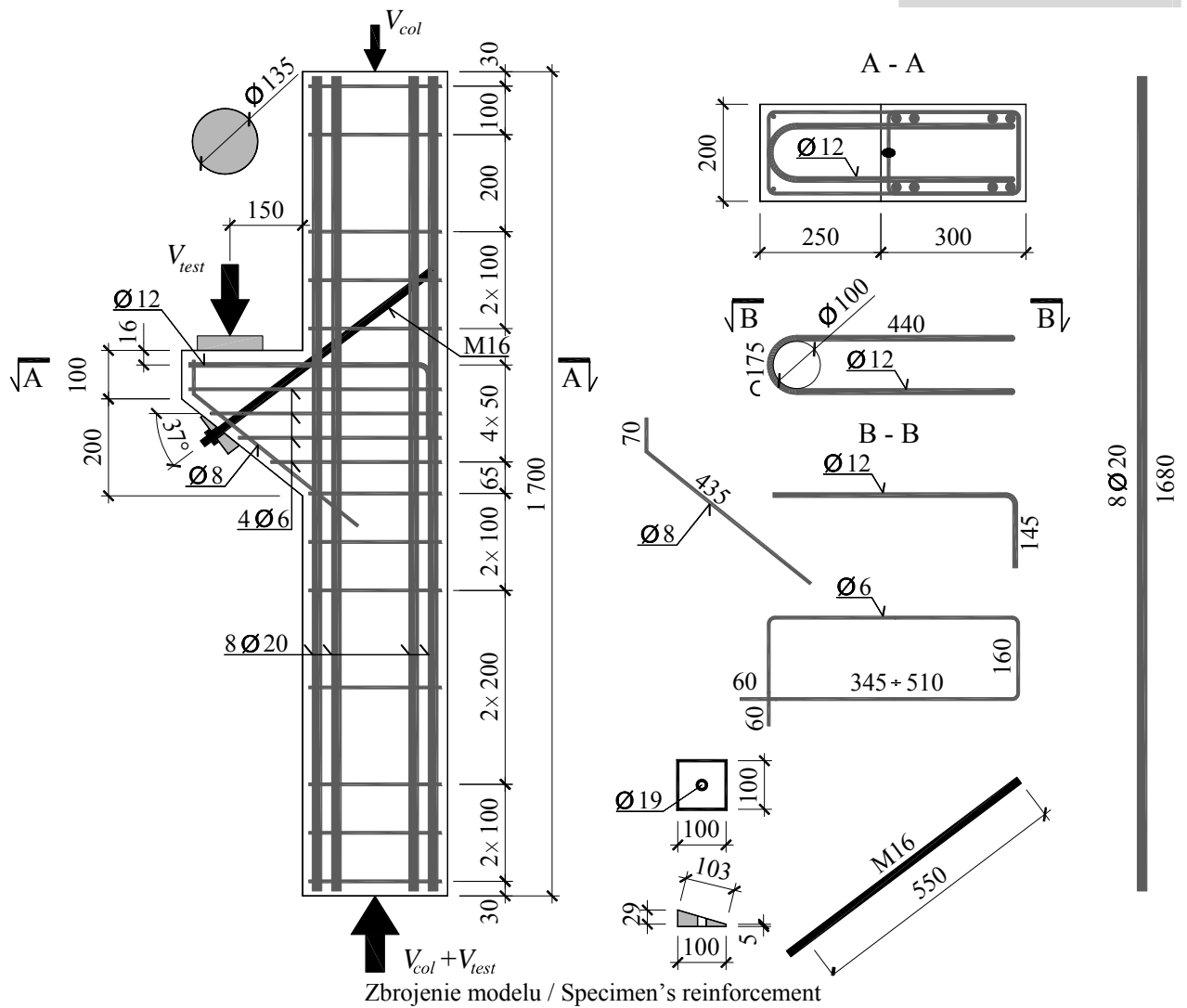

Wytrzymałość betonu na ściskanie / Compressive strength of concrete

$$f_{cm} = 33,7\text{MPa}$$

Wytrzymałość kostkowa betonu na ściskanie / Compressive cube strength of concrete

$$f_{c,cube} = 38,8\text{MPa}$$

Moduł sprężystości podłużnej / Young's modulus

$$E_{cm} = 25,9\text{GPa}$$

Wytrzymałość betonu na rozciąganie przy rozłupywaniu / Tensile splitting strength of concrete

$$f_{ct,sp} = 3,1\text{MPa}$$

Gęstość betonu / Density of concrete

$$\rho = 2200\text{kg/m}^3$$

Charakterystyka zbrojenia / Characteristics of the reinforcement

Ø6

$$A_s = 28,09\text{mm}^2, f_{ym} = 585,2\text{MPa}, f_{tm} = 623,7\text{MPa}$$

Ø12

$$A_s = 114,6\text{mm}^2, f_{ym} = 627,5\text{MPa}, f_{tm} = 711,9\text{MPa}$$

Ø20

$$A_s = 316,01\text{mm}^2, f_{ym} = 533,2\text{MPa}, f_{tm} = 635,5\text{MPa}$$

M16

$$A_s = 138,9\text{mm}^2, f_{ym} = 997,9\text{MPa}, f_{tm} = 1047,5\text{MPa}$$

Siła niszcząca / Failure force

$$V_{test} = 442\text{kN}$$

A-I

Zbrojenie główne – odkształcenia (ϵ_s) / Main reinforcement – strains (ϵ_s)

obciążenie słupa column load	obciążenie wspornika corbel load	odkształcenie strain		
		1	2	średnia/ average
kN	kN	‰	‰	‰
0	0	0,000	0,000	0,000
50	0	-0,011	-0,006	-0,009
100	0	-0,010	-0,011	-0,011
150	0	-0,008	-0,016	-0,012
150	10	0,024	0,017	0,021
150	20	0,084	0,066	0,075
150	30	0,155	0,118	0,137
150	40	0,351	0,203	0,277
150	50	0,554	0,315	0,435
150	60	0,778	0,437	0,608
150	70	0,995	0,564	0,780
150	80	1,167	0,669	0,918
150	90	1,357	0,788	1,073
150	100	1,491	0,867	1,179
150	110	1,650	0,966	1,308
150	120	1,780	1,018	1,399
150	130	1,898	1,079	1,489
150	140	2,016	1,156	1,586
150	150	2,146	1,243	1,695
150	160	2,260	1,329	1,795
150	170	2,378	1,414	1,896
150	180	2,504	1,509	2,007
150	190	2,636	1,601	2,119
150	200	2,766	1,698	2,232
150	150	2,371	1,376	1,874
150	150	2,299	1,333	1,816
150	150	2,301	1,337	1,819
150	150	2,295	1,335	1,815
150	160	2,329	1,365	1,847
150	170	2,459	1,395	1,927
150	180	2,535	1,459	1,997
150	190	2,614	1,527	2,071
150	200	2,692	1,594	2,143
150	210	2,774	1,662	2,218
150	220	2,854	1,732	2,293
150	230	2,933	1,794	2,364
150	240	3,017	1,866	2,442
150	250	3,095	1,932	2,514
150	260	3,180	1,999	2,590
150	270	3,252	2,059	2,656
150	280	3,337	2,125	2,731
150	290	3,439	2,199	2,819
150	300	3,634	2,272	2,953
150	310	3,763	2,336	3,050
150	320	3,904	2,409	3,157
150	330	4,040	2,488	3,264
150	340	4,194	2,567	3,381
150	350	4,457	2,646	3,552
150	360	4,772	2,732	3,752
150	370	5,672	2,927	4,300
150	380	6,138	3,006	4,572
150	390	6,897	3,225	5,061
150	400	7,134	3,399	5,267
150	410	6,787	4,722	5,755
150	420	6,430		4,653
150	430	6,006		3,912
150	440	5,998		3,256
150	442	6,416		3,492
150	441	6,519		3,545

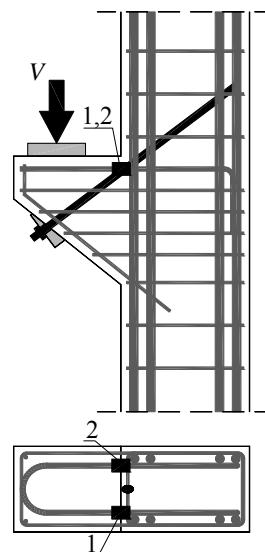
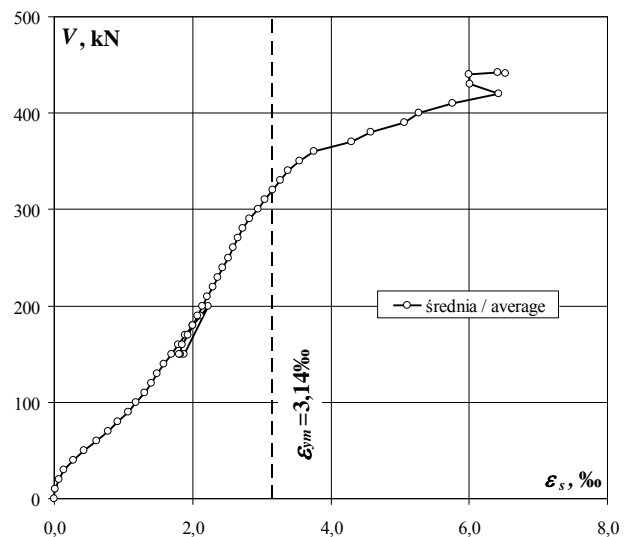
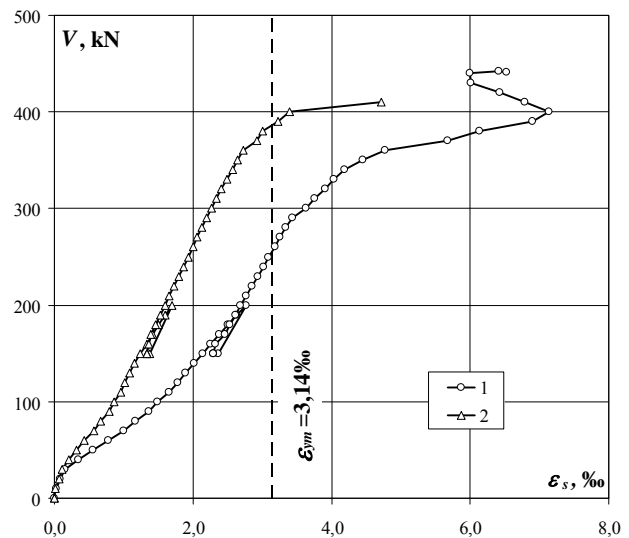

Szerokość rozwarcia rys / Crack width

obciążenie słupa column load	obciążenie wspornika corbel load	Numer rysy Crack number					
		1	2	3	4	5	6
kN	kN	mm	mm	mm	mm	mm	mm
150	50	0,01	0,01	0,01			
150	70	0,05	0,01	0,01			
150	80	0,10	0,01	0,01			
150	90	0,15	0,03	0,01			
150	100	0,15	0,05	0,01			
150	110	0,18	0,08	0,01			
150	120	0,20	0,10	0,01			
150	130	0,22	0,13	0,02			
150	140	0,22	0,15	0,04			
150	150	0,25	0,15	0,07			
150	160	0,25	0,15	0,08			
150	170	0,25	0,15	0,10			
150	180	0,25	0,15	0,10			
150	190	0,25	0,15	0,10			
150	200	0,27	0,15	0,12			
150	150	0,27	0,15	0,12			
150	160	0,27	0,15	0,12			
150	170	0,27	0,15	0,15			
150	180	0,27	0,15	0,15			
150	190	0,27	0,18	0,15			
150	200	0,30	0,20	0,15			
150	210	0,30	0,20	0,17			
150	220	0,30	0,22	0,17			
150	230	0,30	0,20	0,20			
150	240	0,30	0,20	0,20			
150	250	0,35	0,20	0,20			
150	260	0,35	0,20	0,20			
150	270	0,35	0,20	0,20			
150	280	0,35	0,20	0,20			
150	290	0,40	0,20	0,20			
150	300	0,40	0,22	0,23			
150	310	0,40	0,25	0,25			
150	320	0,45	0,25	0,25			
150	330	0,45	0,25	0,30			
150	340	0,47	0,25	0,30			
150	350	0,50	0,27	0,35			
150	360	0,52	0,30	0,35			
150	370	0,55	0,30	0,40			
150	380	0,60	0,35	0,40			

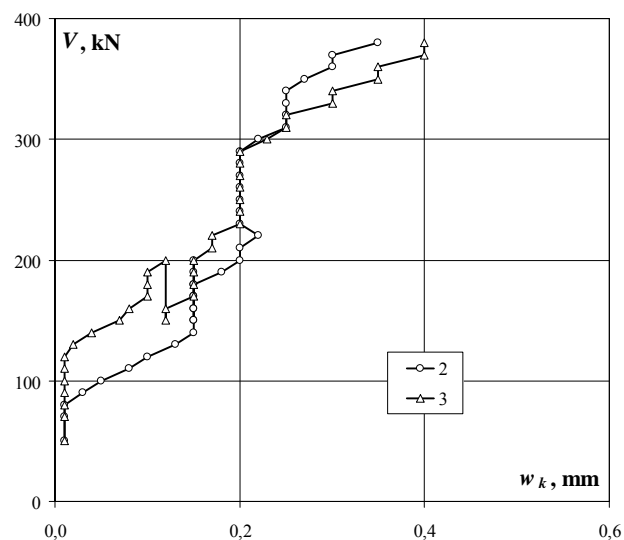
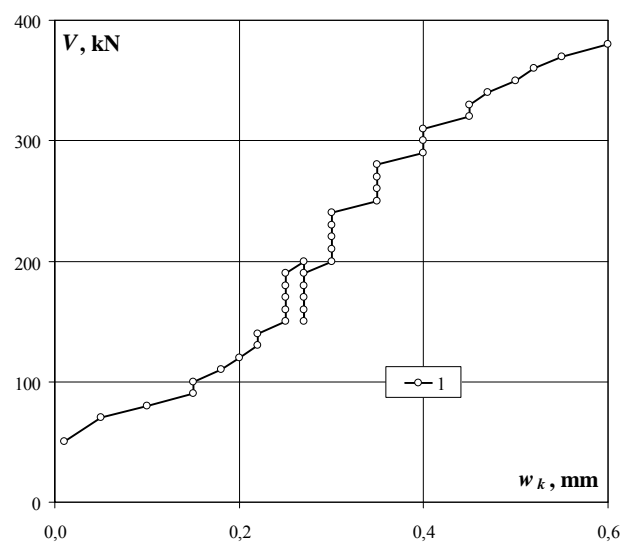

A-I

Układ rys przy sile 100kN / Crack pattern at 100kN

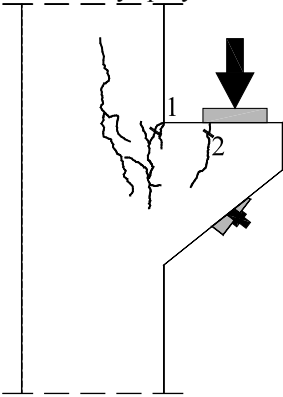

Układ rys przy sile 150kN / Crack pattern at 150kN

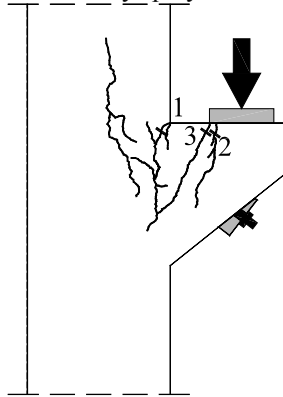

Układ rys przy sile 200kN / Crack pattern at 200kN

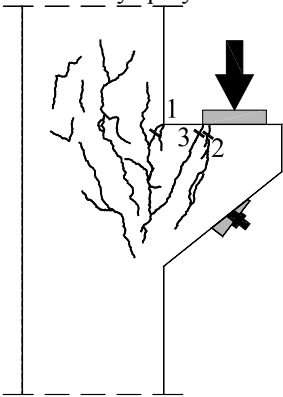

Układ rys przy sile 300kN / Crack pattern at 300kN

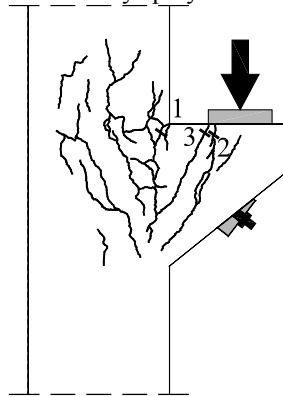

Układ rys przy sile 380kN / Crack pattern at 380kN

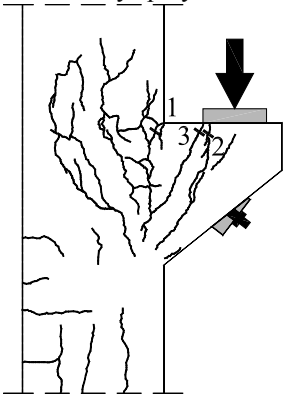

Układ rys przy sile 465kN / Crack pattern at 465kN

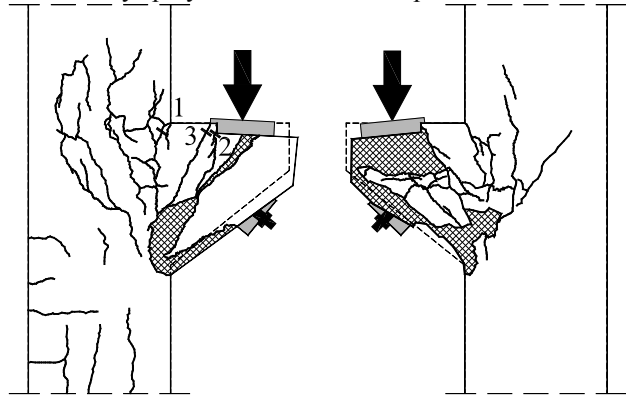

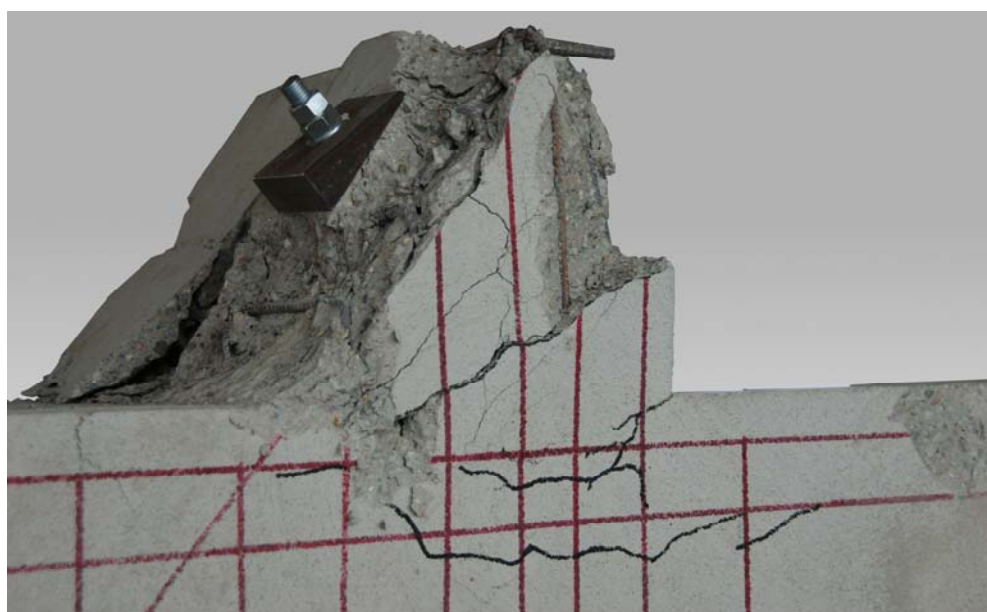

Wspornik po zniszczeniu / Corbel after failure

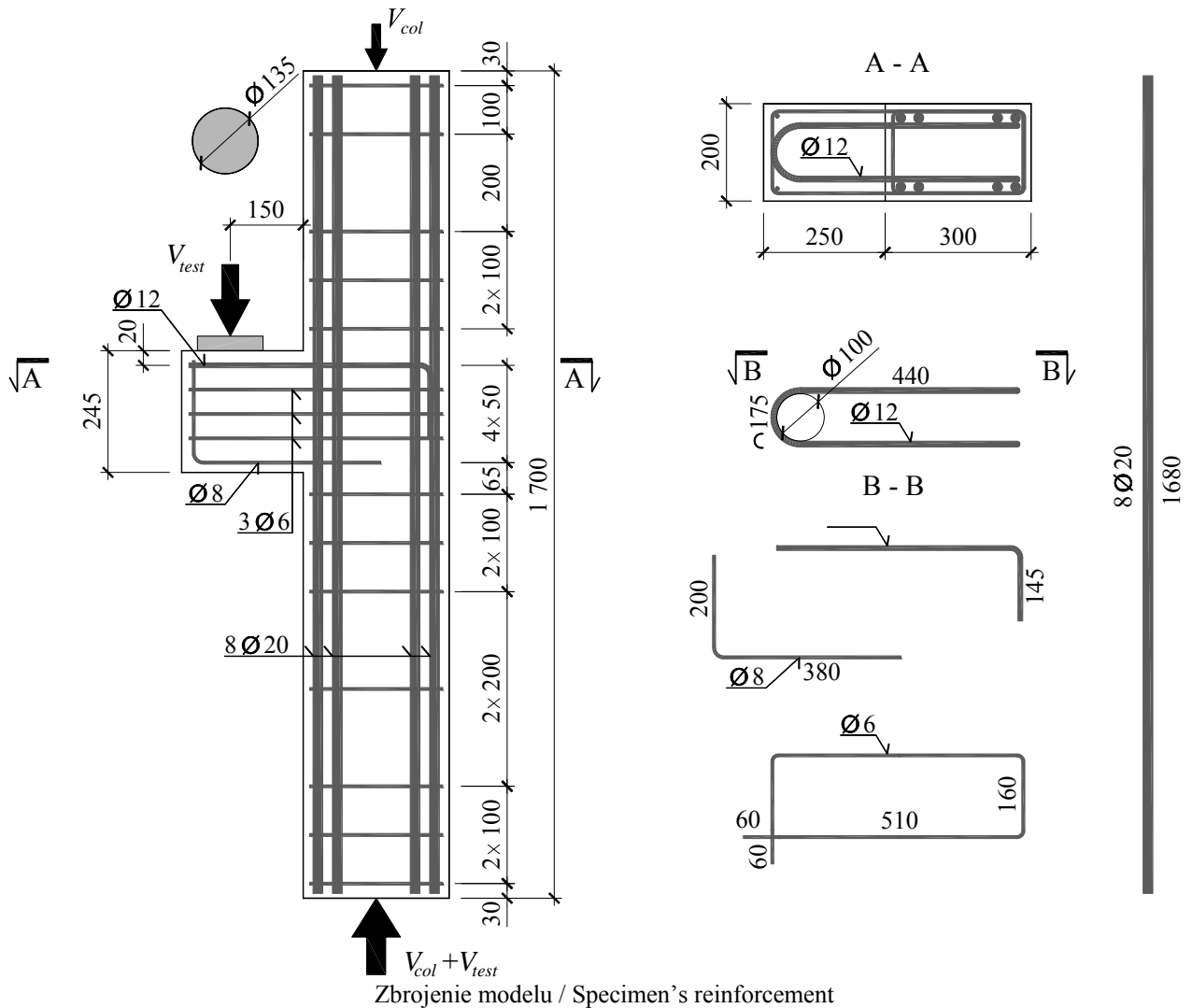

Wytrzymałość betonu na ściskanie / Compressive strength of concrete

$$f_{cm} = 23,9\text{MPa}$$

Wytrzymałość kostkowa betonu na ściskanie / Compressive cube strength of concrete

$$f_{c,cube} = 28,0\text{MPa}$$

Moduł sprężystości podłużnej / Young's modulus

$$E_{cm} = 19,7\text{GPa}$$

Wytrzymałość betonu na rozciąganie przy rozłupywaniu / Tensile splitting strength of concrete

$$f_{ct,sp} = 2,3\text{MPa}$$

Gęstość betonu / Density of concrete

$$\rho = 2100\text{kg/m}^3$$

Charakterystyka zbrojenia / Characteristics of the reinforcement

Ø6

$$A_s = 28,09\text{mm}^2, f_{ym} = 585,2\text{MPa}, f_{tm} = 623,7\text{MPa}$$

Ø12

$$A_s = 114,6\text{mm}^2, f_{ym} = 627,5\text{MPa}, f_{tm} = 711,9\text{MPa}$$

Ø20

$$A_s = 316,01\text{mm}^2, f_{ym} = 533,2\text{MPa}, f_{tm} = 635,5\text{MPa}$$

Siła niszcząca / Failure force

$$V_{test} = 240\text{kN}$$

B-0

Zbrojenie główne – odkształcenia (ϵ_s) / Main reinforcement – strains (ϵ_s)

obciążenie słupa column load	obciążenie wspornika corbel load	odkształcenie strain		
		1	2	średnia/ average
kN	kN	‰	‰	‰
0	0	0,000	0,000	0,000
0	0	-0,004	-0,004	-0,004
50	0	-0,003	-0,003	-0,003
100	0	0,000	-0,004	-0,002
150	10	0,061	0,049	0,055
150	20	0,204	0,176	0,190
150	30	0,501	0,538	0,520
150	40	0,734	0,779	0,757
150	50	0,981	1,036	1,009
150	60	1,258	1,262	1,260
150	70	1,452	1,501	1,477
150	80	1,601	1,862	1,732
150	90	1,700	2,213	1,957
150	100	1,809	2,325	2,067
150	110	1,997	2,365	2,181
150	120	2,187	2,477	2,332
150	130	2,380	2,600	2,490
150	140	2,557	2,718	2,638
150	150	2,751	2,840	2,796
150	160	2,925	2,971	2,948
150	160	3,092	3,072	3,082
150	165	3,148	3,125	3,137
150	170	3,269	3,149	3,209
150	175	3,340	3,220	3,280
150	180	3,437	3,287	3,362
150	185	3,494	3,344	3,419
150	190	3,621	3,437	3,529
150	195	3,913	3,649	3,781
150	201	3,904	3,625	3,765
150	206	3,977	3,694	3,836
150	210	4,157	3,840	3,999
150	215	4,219	3,911	4,065
150	220	4,384	4,345	4,365
150	226	4,604	4,661	4,633
150	230	5,311		5,311
150	235	8,998		8,998
150	240	5,283		5,283
150	238	5,300		5,300

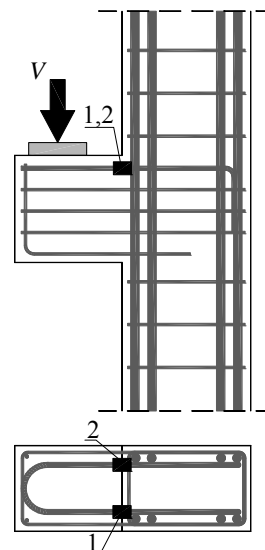
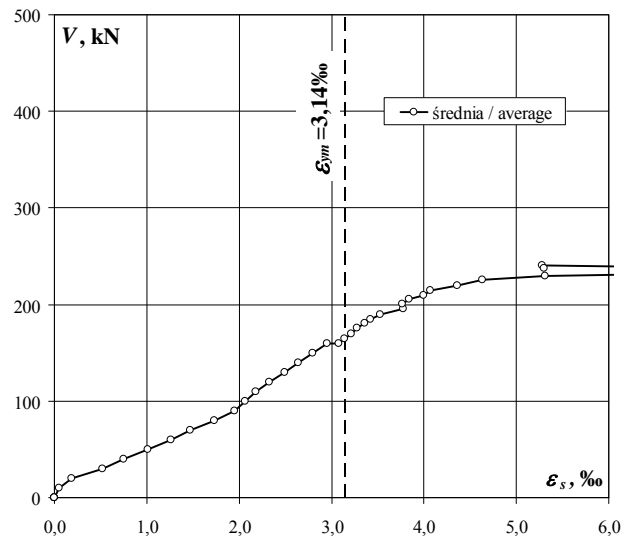
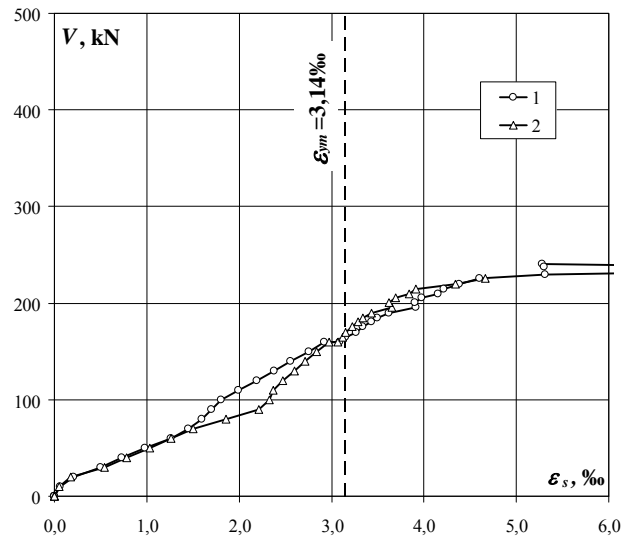

Szerokość rozwarcia rys / Crack width

obciążenie słupa column load	obciążenie wspornika corbel load	Numer rysy Crack number					
		1	2	3	4	5	6
kN	kN	mm	mm	mm	mm	mm	mm
150	30	0,10					
150	50	0,15					
150	60	0,18					
150	70	0,20					
150	80	0,25					
150	90	0,35					
150	110	0,45	0,10				
150	120	0,45	0,18				
150	130	0,45	0,22				
150	140	0,45	0,30				
150	150	0,50	0,40	0,08			
150	160	0,50	0,45	0,12			
150	170	0,50	0,45	0,15	0,02		
150	180	0,55	0,50	0,15	0,02		
150	190	0,60	0,50	0,15	0,03		
150	201	0,65	0,60	0,15	0,03		
150	210	0,75	0,65	0,20	0,05		

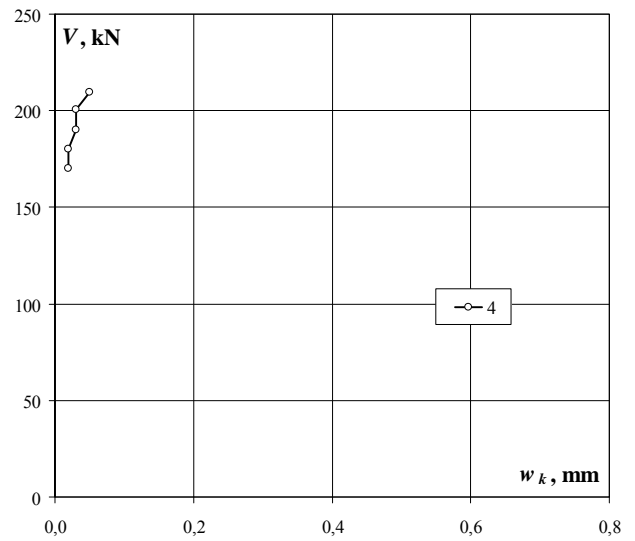
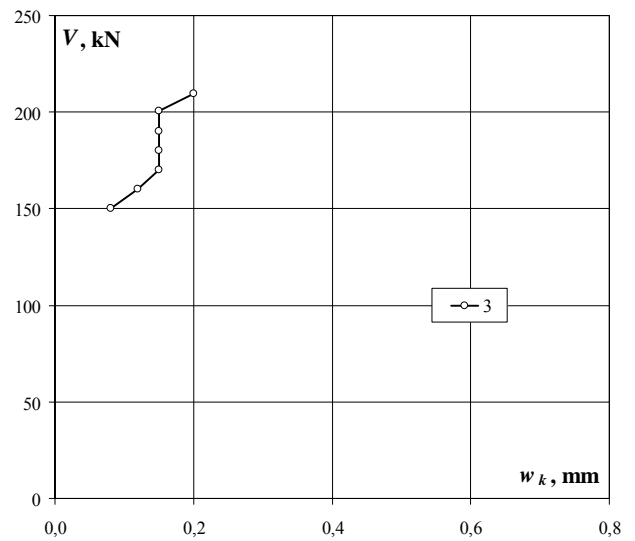
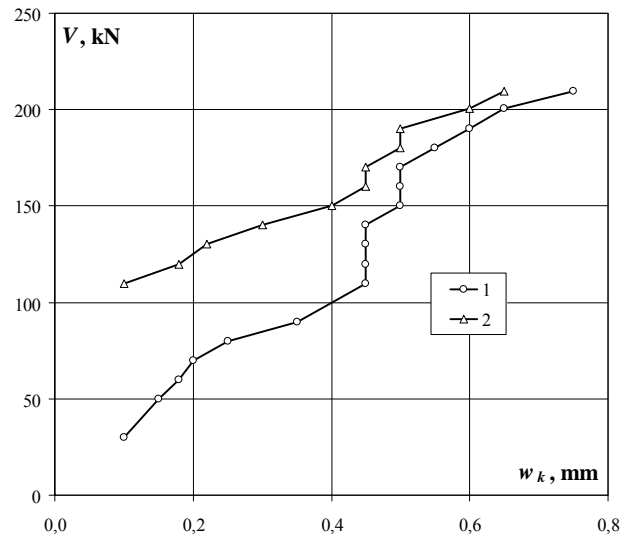

B-0

Układ rys przy sile 100kN / Crack pattern at 100kN

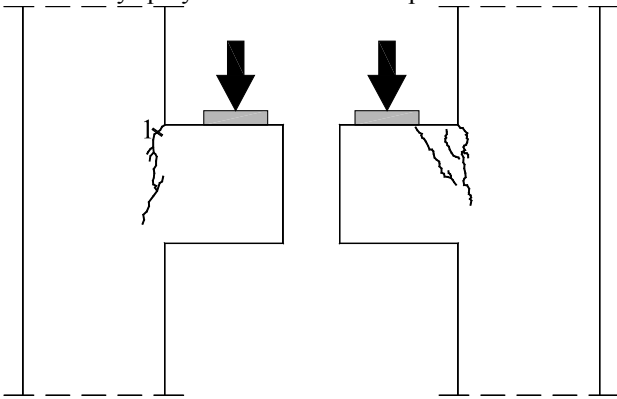

Układ rys przy sile 150kN / Crack pattern at 150kN

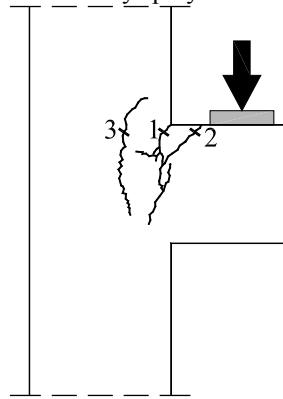

Układ rys przy sile 200kN / Crack pattern at 200kN

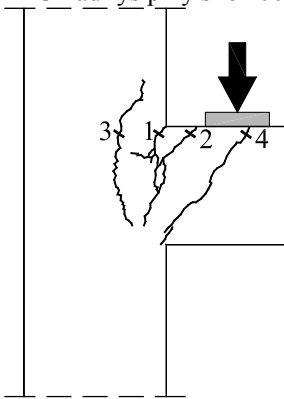

Układ rys przy sile 240kN / Crack pattern at 240kN

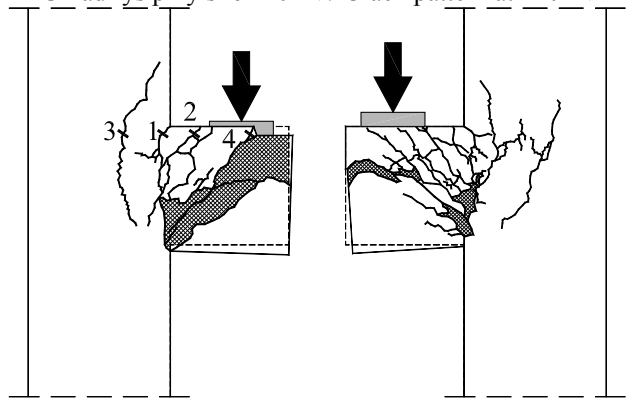

B-0

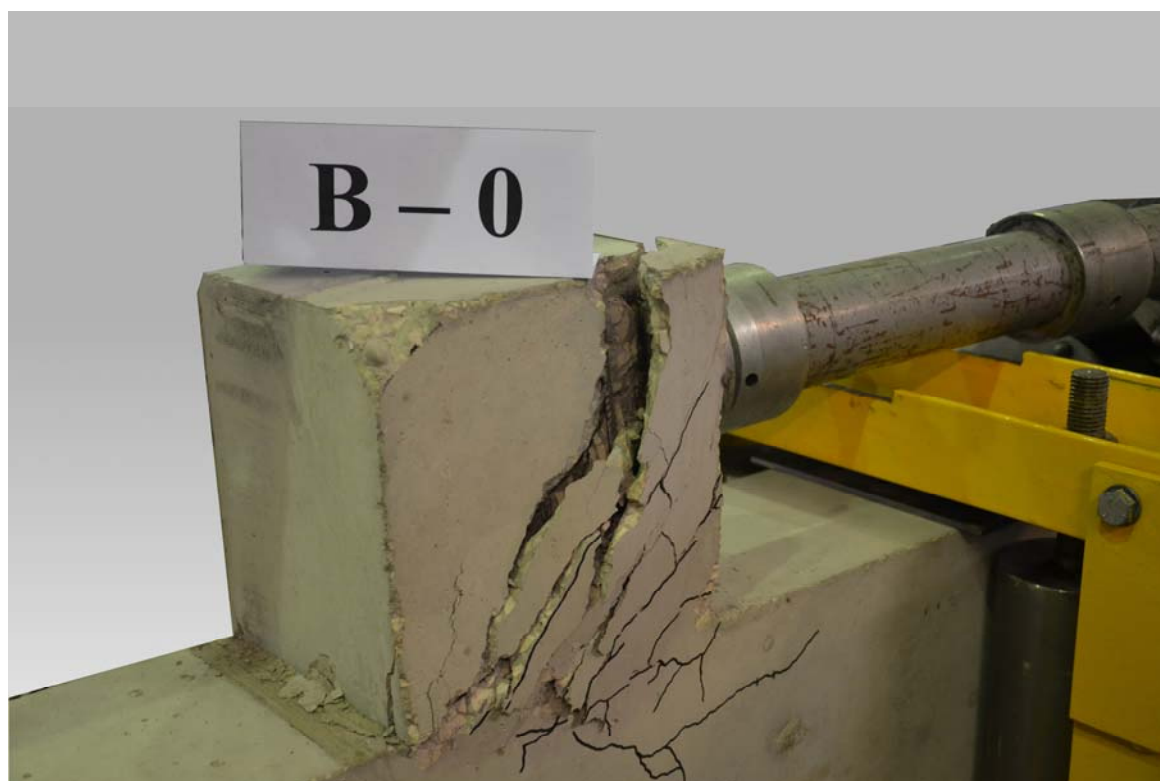

Wspornik po zniszczeniu / Corbel after failure

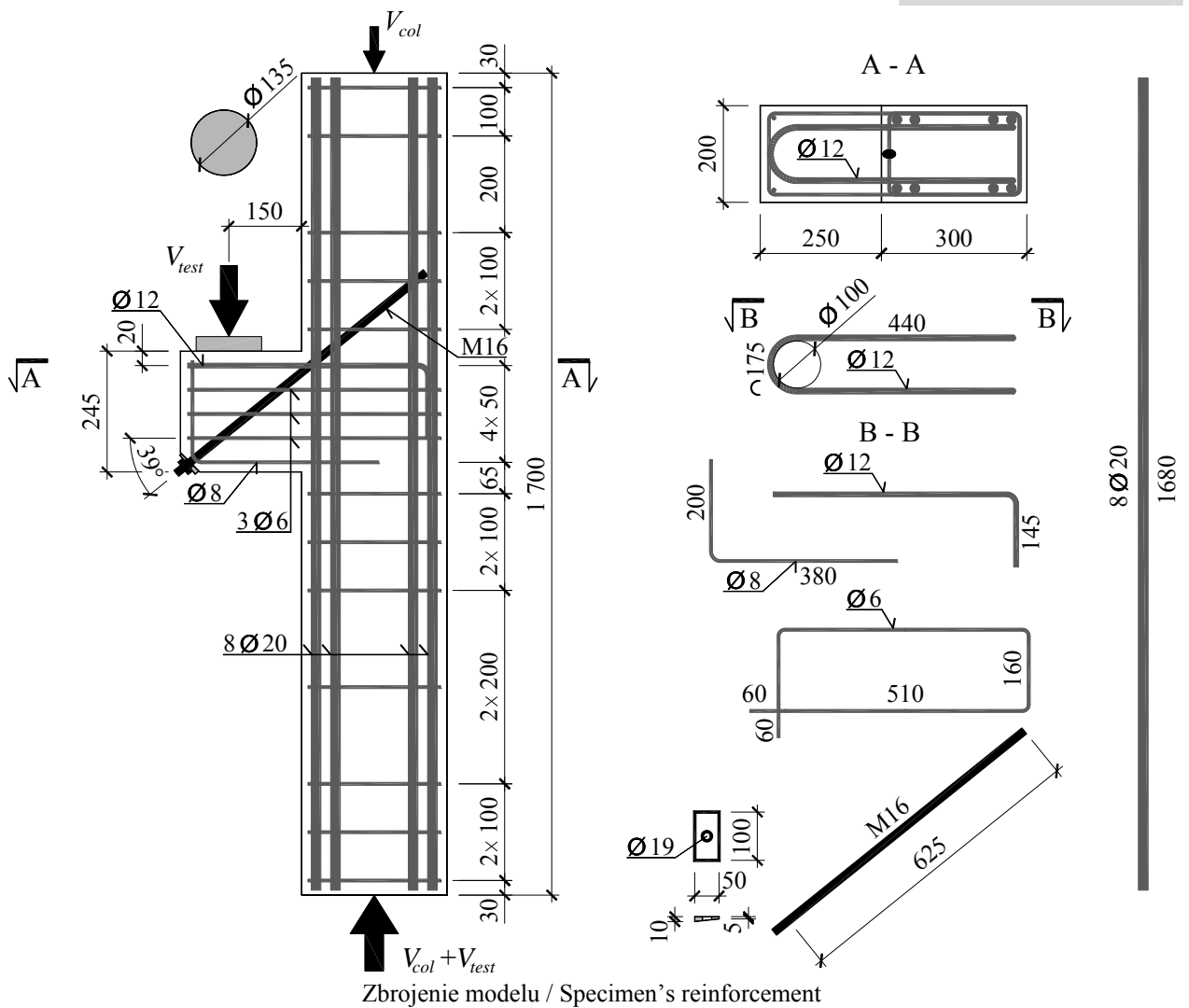

Wytrzymałość betonu na ściskanie / Compressive strength of concrete

$$f_{cm} = 23,9\text{MPa}$$

Wytrzymałość kostkowa betonu na ściskanie / Compressive cube strength of concrete

$$f_{c,cube} = 28,0\text{MPa}$$

Moduł sprężystości podłużnej / Young's modulus

$$E_{cm} = 19,7\text{GPa}$$

Wytrzymałość betonu na rozciąganie przy rozłupywaniu / Tensile splitting strength of concrete

$$f_{ct,sp} = 2,3\text{MPa}$$

Gęstość betonu / Density of concrete

$$\rho = 2100\text{kg/m}^3$$

Charakterystyka zbrojenia / Characteristics of the reinforcement

Ø6

$$A_s = 28,09\text{mm}^2, f_{ym} = 585,2\text{MPa}, f_{tm} = 623,7\text{MPa}$$

Ø12

$$A_s = 114,6\text{mm}^2, f_{ym} = 627,5\text{MPa}, f_{tm} = 711,9\text{MPa}$$

Ø20

$$A_s = 316,01\text{mm}^2, f_{ym} = 533,2\text{MPa}, f_{tm} = 635,5\text{MPa}$$

M16

$$A_s = 138,9\text{mm}^2, f_{ym} = 997,9\text{MPa}, f_{tm} = 1047,5\text{MPa}$$

Siła niszcząca / Failure force

$$V_{test} = 298\text{kN}$$

B-I

Zbrojenie główne – odkształcenia (ϵ_s) / Main reinforcement – strains (ϵ_s)

obciążenie słupa column load	obciążenie wspornika corbel load	odkształcenie strain		
		1	2	średnia/average
kN	kN	‰	‰	‰
0	0	0,000	0,000	0,000
0	0	0,000	0,000	0,000
50	0	0,003	-0,006	-0,002
100	0	0,004	-0,004	0,000
150	0	0,004	-0,004	0,000
150	10	0,056	0,032	0,044
150	20	0,154	0,137	0,146
150	30	0,453	0,425	0,439
150	40	0,699	0,662	0,681
150	50	0,927	0,884	0,906
150	60	1,115	1,071	1,093
150	70	1,305	1,279	1,292
150	80	1,421	1,552	1,487
150	90	1,556	1,871	1,714
150	100	1,724	2,030	1,877
150	110	1,927	1,967	1,947
150	120	2,123	2,017	2,070
150	110	2,111	1,946	2,029
150	100	2,032	1,841	1,937
150	90	1,910	1,687	1,799
150	80	1,762	1,514	1,638
150	80	1,680	1,330	1,505
150	90	1,751	1,412	1,582
150	100	1,856	1,529	1,693
150	110	1,947	1,631	1,789
150	120	2,050	1,735	1,893
150	130	2,158	1,846	2,002
150	140	2,240	1,935	2,088
150	150	2,329	1,999	2,164
150	160	2,435	2,002	2,219
150	170	2,524		2,524
150	180	2,628		2,628
150	190	2,730		2,730
150	200	2,839		2,839
150	210	3,010		3,010
150	220	3,111		3,111
150	230	3,222		3,222
150	240	3,351		3,351
150	250	3,503		3,503
150	260	3,655		3,655
150	270	3,822		3,822
150	280	4,056		4,056
150	290	4,245		4,245
150	298	7,229		7,229
150	275	8,523		8,523

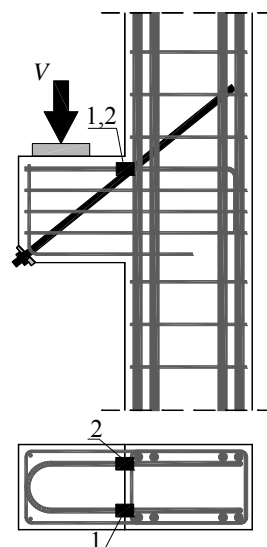
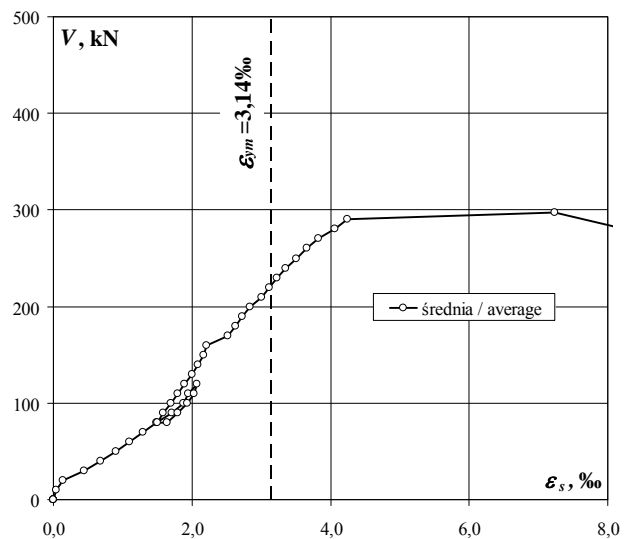
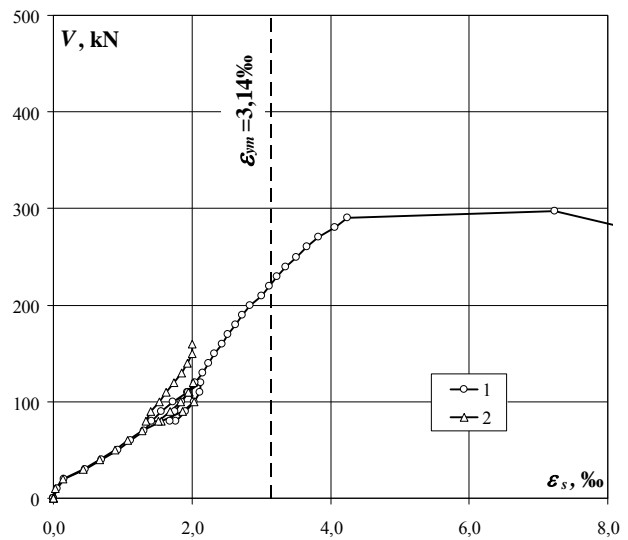

Szerokość rozwarcia rys / Crack width

obciążenie słupa column load	obciążenie wspornika corbel load	Numer rysy Crack number					
		1	2	3	4	5	6
kN	kN	mm	mm	mm	mm	mm	mm
150	30	0,10					
150	40	0,10					
150	50	0,10					
150	60	0,15					
150	70	0,15					
150	80	0,15					
150	90	0,15	0,05				
150	100	0,15	0,10				
150	110	0,15	0,15				
150	120	0,18	0,18	0,05			
150	110	0,18	0,15	0,05			
150	100	0,10	0,10	0,05			
150	90	0,10	0,10	0,05			
150	80	0,10	0,10	0,05			
150	90	0,15	0,15	0,05			
150	100	0,15	0,15	0,05	0,02		
150	110	0,15	0,25	0,05	0,05		
150	120	0,18	0,25	0,05	0,05		
150	130	0,20	0,25	0,05	0,05		
150	140	0,25	0,25	0,05	0,05		
150	150	0,25	0,25	0,05	0,07		
150	160	0,25	0,25	0,05	0,10		
150	170	0,25	0,25	0,05	0,10		
150	180	0,25	0,25	0,05	0,10		
150	190	0,25	0,25	0,05	0,10		
150	200	0,25	0,25	0,05	0,10		
150	210	0,25	0,25	0,05	0,10		
150	220	0,25	0,30	0,05	0,10		
150	230	0,25	0,30	0,05	0,10		
150	240	0,25	0,30	0,05	0,15		
150	250	0,25	0,30	0,05	0,15		
150	260	0,30	0,30	0,05	0,15		
150	270	0,30	0,30	0,05	0,20		
150	280	0,30	0,30	0,05	0,25		
150	290	0,30	0,35	0,05	0,30		

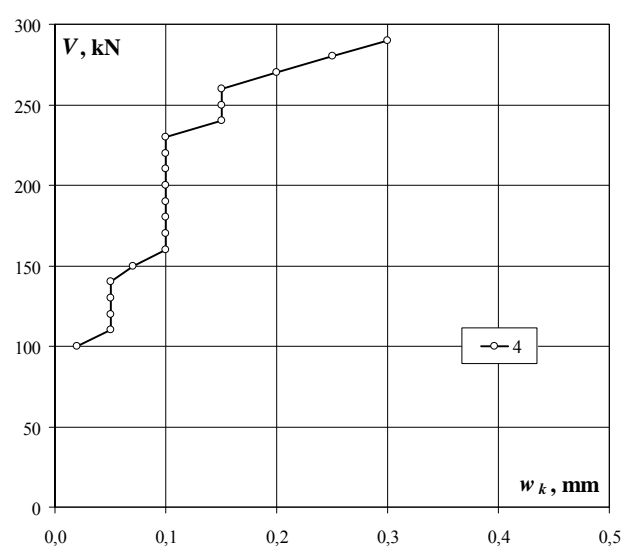
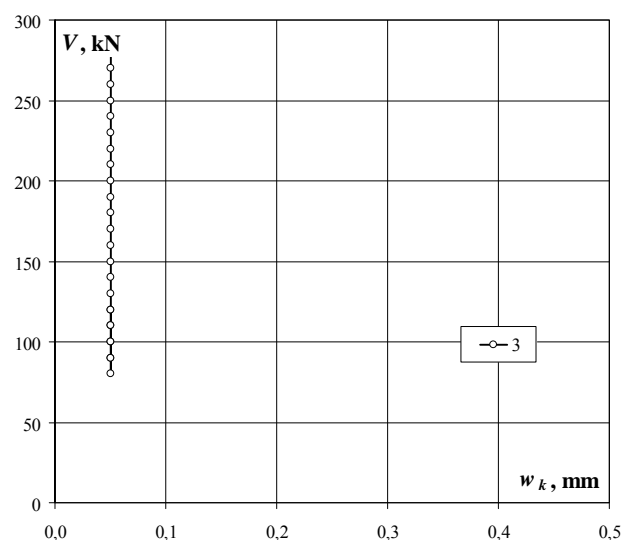
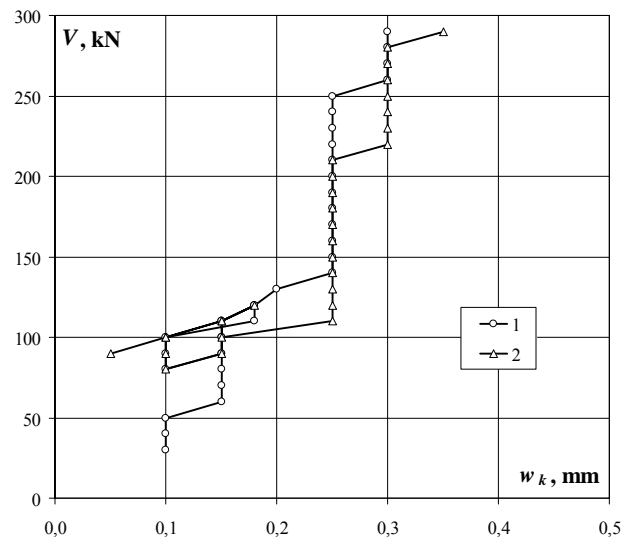

B-I

Układ rys przy sile 100kN / Crack pattern at 100kN

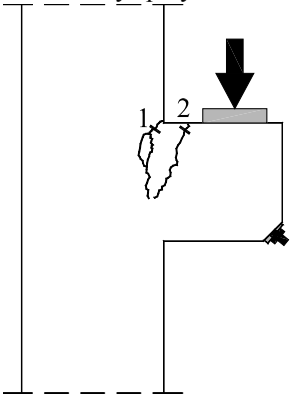

Układ rys przy sile 120kN / Crack pattern at 120kN

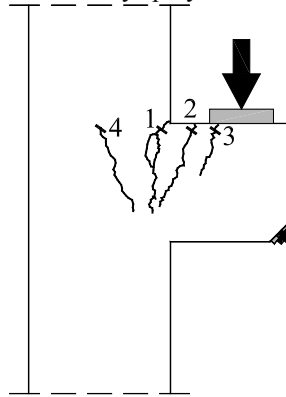

Układ rys przy sile 160kN / Crack pattern at 160kN

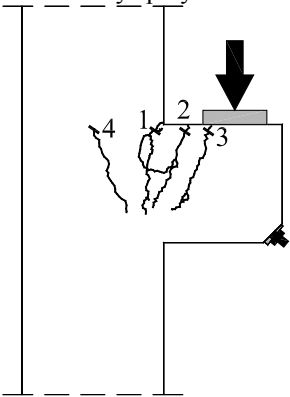

Układ rys przy sile 200kN / Crack pattern at 200kN

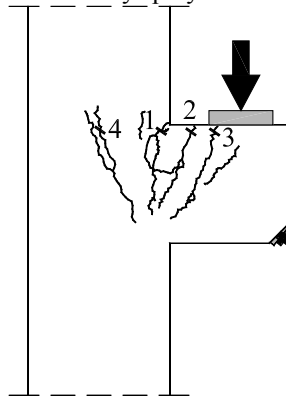

Układ rys przy sile 280kN / Crack pattern at 280kN

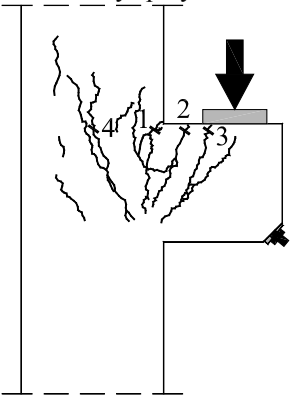

Układ rys przy sile 300kN / Crack pattern at 300kN

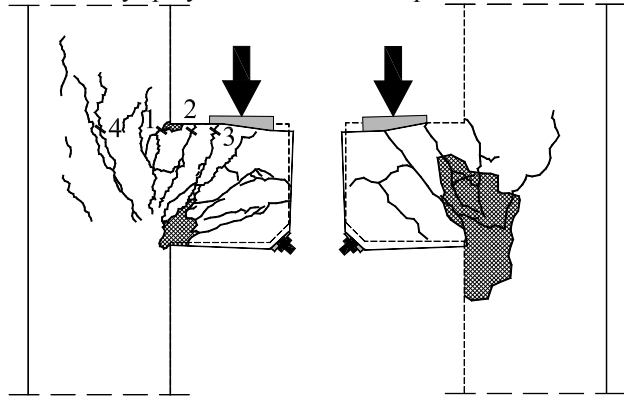



Wspornik po zniszczeniu w stanowisku badawczym / Corbel after failure in test setup



Powierzchnia ściskana z widocznymi rysami / Compression surface with visible cracks

Seria C
C Series

Wykres $\sigma - \varepsilon$ dla: / $\sigma - \varepsilon$ diagram for:

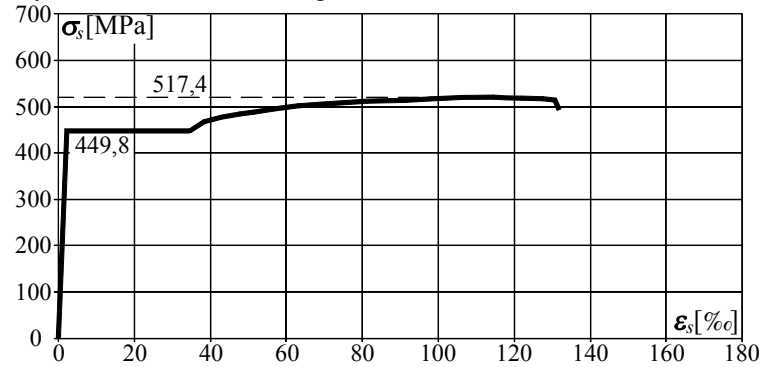

Tabele $\sigma - \varepsilon$ dla: / $\sigma - \varepsilon$ table for:

ε_s	σ_s	ε_s	σ_s
%	MPa	%	MPa
0	0	80	511,9
2,249	449,8	90	514,2
34,49	449,8	100	517,4
40	471,6	120	517,4
50	487,3	130	515,6
60	500,0	131,48	494,3
70	506,5		

prętów Ø6 / bars Ø6, $A_s=28,27\text{mm}^2$



ε_s	σ_s	ε_s	σ_s
%	MPa	%	MPa
0	0	70	626,9
2,05	409,9	80	633,4
10,11	409,9	90	636,0
20	484,0	130	636,0
30	539,1	140	633,7
40	575,0	150	611,6
50	600,6	151,15	595,9
60	616,3		

prętów Ø12 / bars Ø12, $A_s=113,86\text{mm}^2$

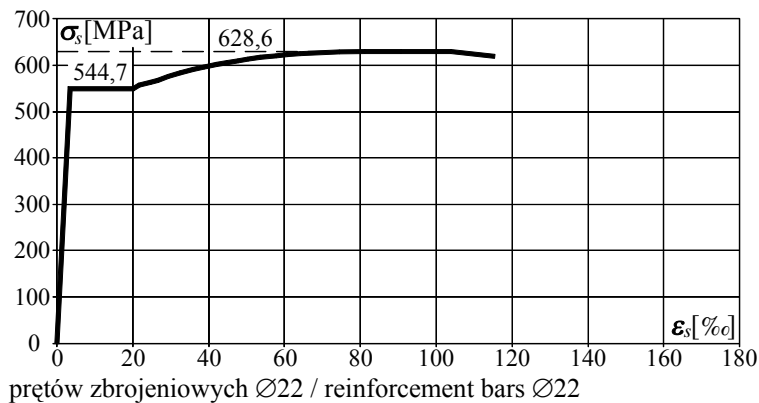

ε_s	σ_s	ε_s	σ_s
%	MPa	%	MPa
0	0	60	622,1
2,724	544,7	70	627,0
20	544,7	80	628,6
30	577,8	103,9	628,6
40	598,4	115,4	619,1
50	612,6		

prętów Ø22 / bars Ø22, $A_s=392,71\text{mm}^2$

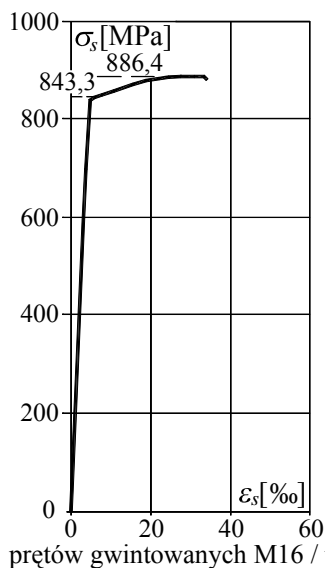

ε_s	σ_s	ε_s	σ_s
%	MPa	%	MPa
0	0	25,92	886,4
3,12	600	33,25	886,4
4,50	800	34,03	880,2
6,38	843,3		
20	879,8		

prętów gwintowanych M16 / rods M16, $A_s=164,99\text{mm}^2$

Beton / Concrete

	f_{cm}	E_{cm}	$f_{ct,sp}$	ρ_c
	MPa	GPa	MPa	kg/m ³
średnia / average	34,99	24,98	3,10	2204
odchylenie standardowe / standard deviation	1,935	1,33	0,142	15,1
współczynnik zmienności / coefficient of variation	5,53%	5,32%	4,58%	0,69%
liczba próbek / number of specimens	25	16	15	39
minimalna wartość / minimum value	31,8	23,40	2,80	2160
maksymalna wartość / maximum value	39,8	27,70	3,35	2230

Rozwój wytrzymałości betonu w czasie / Development of the concrete strength in time

data / date	badany element / tested specimen	wiek / age	f_{cm}
		dni / days	MPa
2015-05-30		78	35,20
2015-06-03	C-0	82	33,83
2015-06-09	C-I	88	35,50
2015-06-12	C-II	91	34,60
2015-06-17	C-III	96	33,85
2015-07-10		119	33,70
2015-07-13		122	34,60
2015-07-16		125	37,10
2015-07-17		126	35,98
średnia / average			34,99
odchylenie standardowe / standard deviation			1,935
współczynnik zmienności / coefficient of variation			5,53%
liczba próbek / number of specimens			25
minimalna wartość / minimum value			31,8
maksymalna wartość / maximum value			39,8

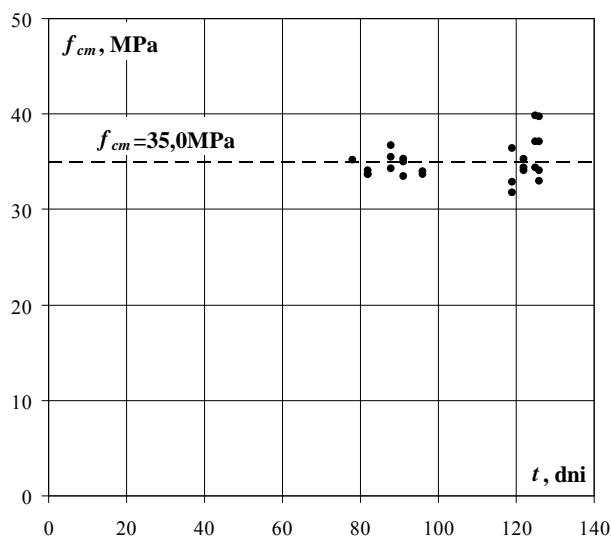

a)

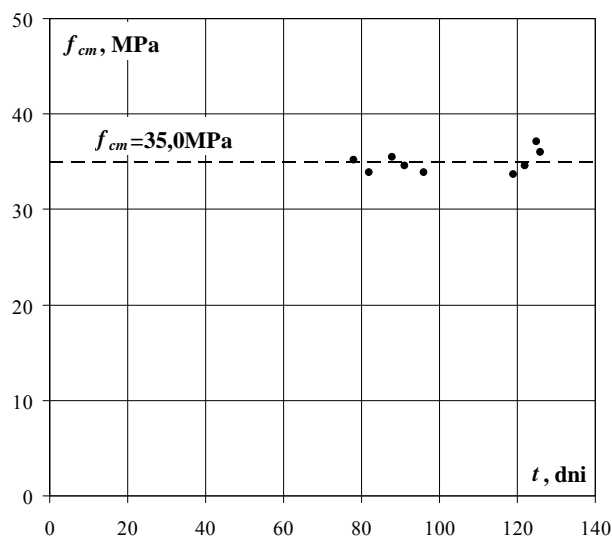

b)

Rozwój wytrzymałości betonu w czasie: a) wyniki badań, b) średnie dzienne
Development of the concrete strength in time: a) test results, b) daily average

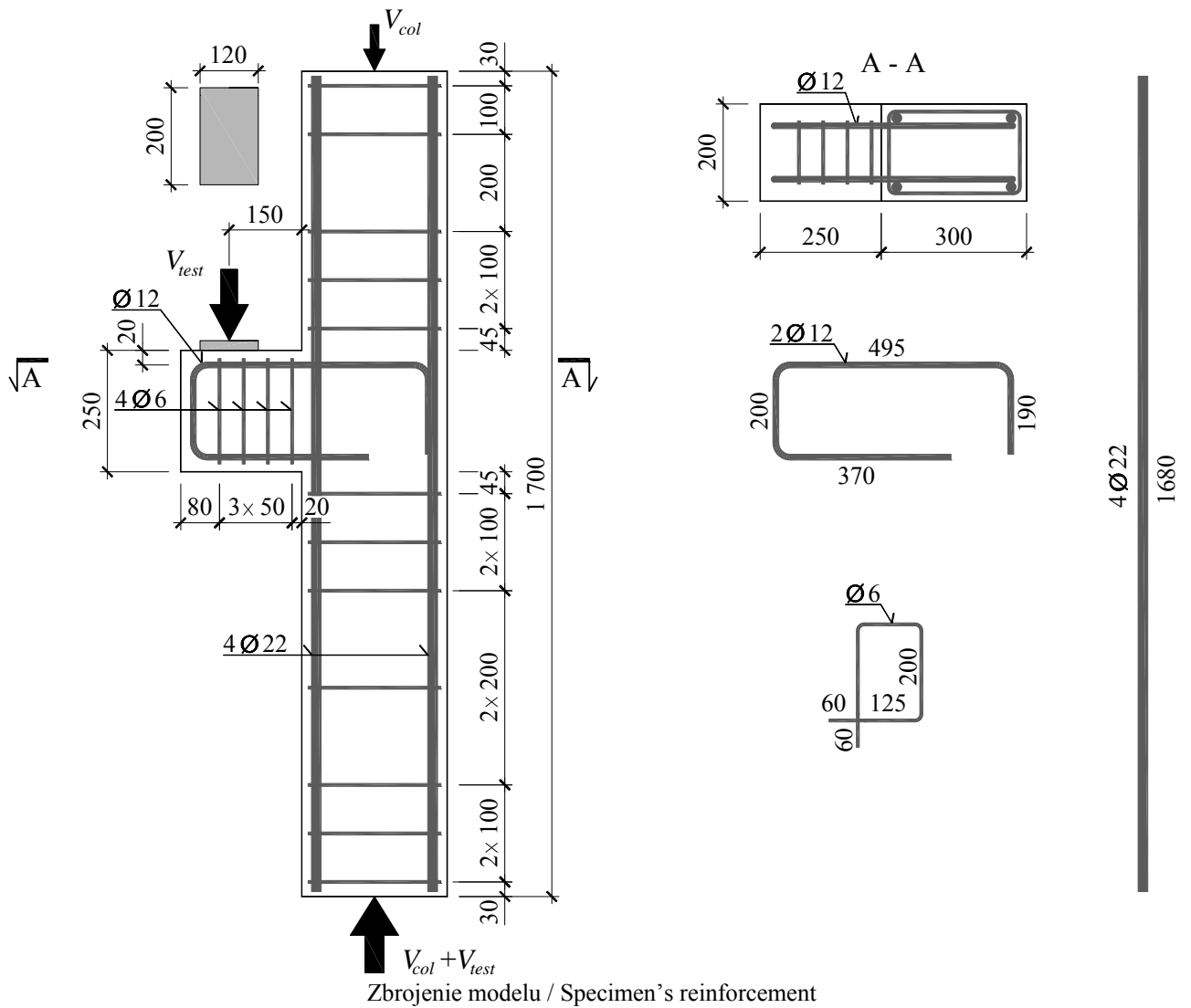

Wytrzymałość betonu na ściskanie / Compressive strength of concrete

$$f_{cm} = 35,0\text{MPa}$$

Moduł sprężystości podłużnej / Young's modulus

$$E_{cm} = 25,0\text{GPa}$$

Wytrzymałość betonu na rozciąganie przy rozłupywaniu / Tensile splitting strength of concrete

$$f_{ct,sp} = 3,1\text{MPa}$$

Gęstość betonu / Density of concrete

$$\rho = 2200\text{kg/m}^3$$

Charakterystyka zbrojenia / Characteristics of the reinforcement

Ø6

$$A_s = 28,27\text{mm}^2, f_{ym} = 449,8\text{MPa}, f_{lm} = 517,4\text{MPa}$$

Ø12

$$A_s = 113,86\text{mm}^2, f_{ym} = 409,9\text{MPa}, f_{lm} = 636,0\text{MPa}$$

Ø22

$$A_s = 392,71\text{mm}^2, f_{ym} = 547,3\text{MPa}, f_{lm} = 628,6\text{MPa}$$

Siła niszcząca / Failure force

$$V_{test} = 187\text{kN}$$

C-0

Zbrojenie główne – odkształcenia (ϵ_s) / Main reinforcement – strains (ϵ_s)

obciążenie słupa column load	obciążenie wspornika corbel load	odkształcenie strain		
		1	2	średnia/ average
kN	kN	‰	‰	‰
0	0	0,000	0,000	0,000
150	10	0,091	0,125	0,108
150	20	0,128	0,185	0,157
150	30	0,155	0,239	0,197
150	40	0,230	0,358	0,294
150	50	0,580	0,774	0,677
150	60	0,882	1,207	1,045
150	70	1,112	1,548	1,330
150	80	1,303	1,845	1,574
150	80	1,317	1,859	1,588
150	90	1,490	2,119	1,805
150	100	1,665	2,408	2,037
150	90	1,568	2,240	1,904
150	80	1,442	2,034	1,738
150	70	1,337	1,859	1,598
150	60	1,211	1,659	1,435
150	70	1,336	1,860	1,598
150	80	1,454	2,052	1,753
150	90	1,577	2,253	1,915
150	100	1,698	2,449	2,074
150	110	1,856	2,757	2,307
150	110	1,868	2,780	2,324
150	120	2,155	3,555	2,855
150	120	2,341	3,951	3,146
150	125	7,089	6,663	6,876
150	130	7,109	9,375	8,242
150	135	7,225	9,367	8,296
150	140	2,061	10,004	6,033
150	145	1,071	7,961	4,516
150	150	1,119	8,462	4,791
150	155		5,232	5,232
150	160		4,692	4,692
150	166		4,397	4,397
150	170		4,603	4,603
150	175			
150	180			
150	185			
150	187			
150	165			

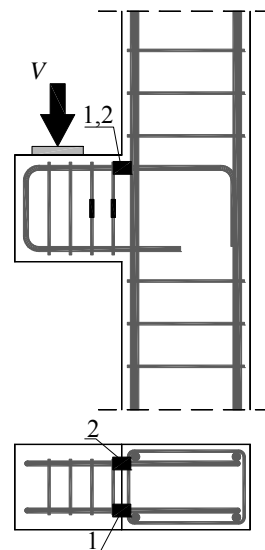
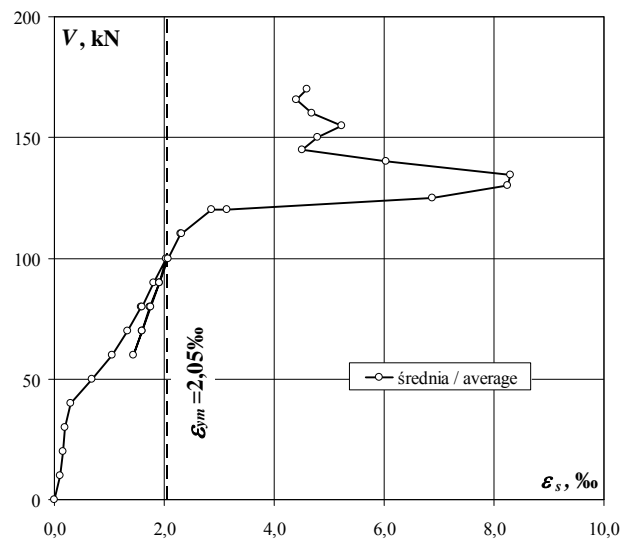
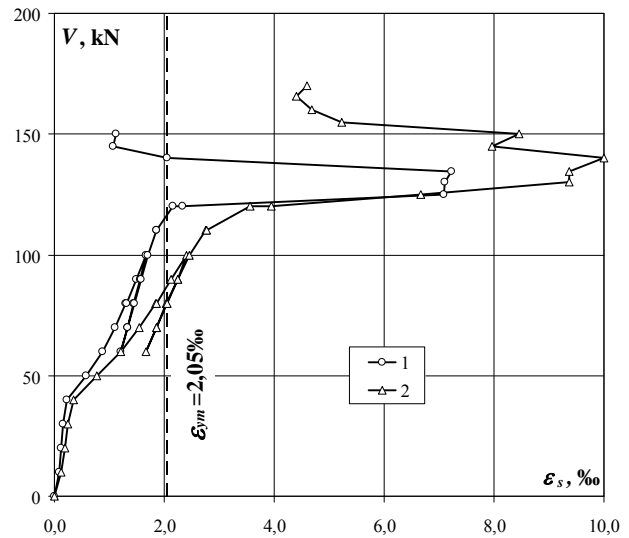

Strzemiona – odkształcenia (ε_s) / Stirrup – strains (ε_s)

obciążenie słupa column load	obciążenie wspornika corbel load	odkształcenie strain		
		3	4	średnia/ average
kN	kN	‰	‰	‰
0	0	0,000	0,000	0,000
150	10	-0,086	-0,010	-0,048
150	20	-0,102	-0,017	-0,060
150	30	-0,128	-0,024	-0,076
150	40	-0,070	-0,032	-0,051
150	50	-0,040	-0,047	-0,044
150	60	-0,109	-0,055	-0,082
150	70	-0,034	-0,063	-0,049
150	80	0,006	-0,074	-0,034
150	80	0,025	-0,074	-0,025
150	90	0,037	-0,083	-0,023
150	100	0,067	-0,090	-0,012
150	90	0,100	-0,083	0,009
150	80	0,085	-0,076	0,005
150	70	0,112	-0,070	0,021
150	60	0,128	-0,063	0,033
150	70	0,104	-0,071	0,017
150	80	0,105	-0,078	0,014
150	90	0,097	-0,085	0,006
150	100	0,078	-0,091	-0,007
150	110	0,109	-0,097	0,006
150	110	0,129	-0,097	0,016
150	120	0,173	-0,089	0,042
150	120	0,188	-0,022	0,083
150	125	0,152	0,049	0,101
150	130	0,176	0,076	0,126
150	135	0,217	0,074	0,146
150	140	0,231	0,089	0,160
150	145	0,511	0,212	0,362
150	150	0,538	0,243	0,391
150	155	0,502	0,299	0,401
150	160	0,522	0,341	0,432
150	166	0,514	0,343	0,429
150	170	0,444	0,353	0,399
150	175	0,528	0,359	0,444
150	180	0,063	0,356	0,210
150	185	-0,065	0,354	0,145
150	187		0,358	0,358
150	165		0,412	0,412

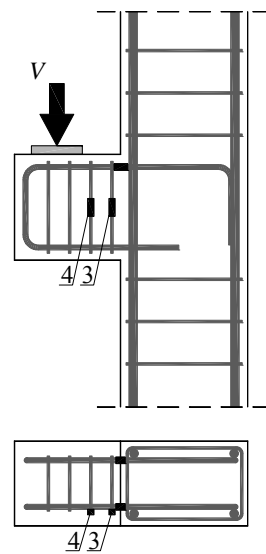
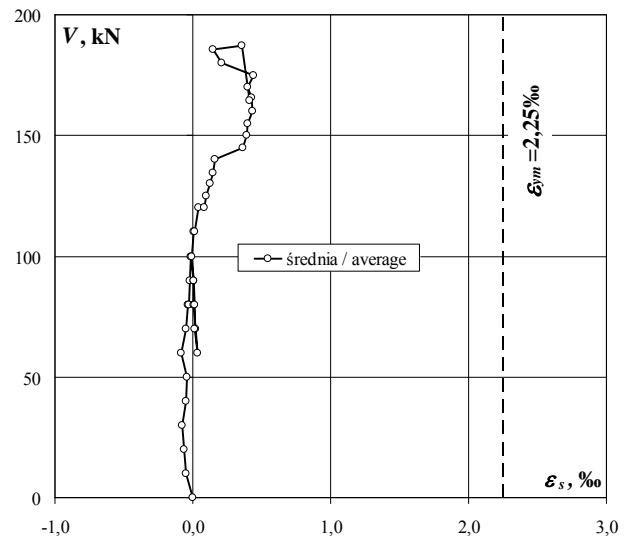
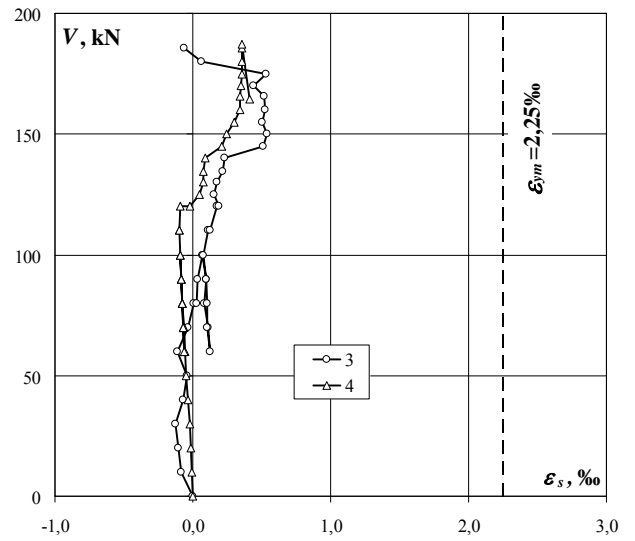

C-0

Na betonie – odkształcenia (ε_c) / On concrete surface – strains (ε_c)

obciążenie słupa column load	obciążenie wspornika corbel load	odkształcenie strain		
		5	6	średnia/ average
kN	kN	‰	‰	‰
0	0	0,000	0,000	0,000
150	10	-0,018	-0,092	-0,055
150	20	-0,050	-0,134	-0,092
150	30	-0,147	-0,167	-0,157
150	40	-0,195	-0,203	-0,199
150	50	-0,219	-0,259	-0,239
150	60	-0,155	-0,285	-0,220
150	70	-0,070	-0,281	-0,176
150	80	-0,084	-0,274	-0,179
150	80	-0,015	-0,270	-0,143
150	90	0,051	-0,255	-0,102
150	100	0,146	-0,235	-0,045
150	90	0,232	-0,215	0,009
150	80	0,239	-0,205	0,017
150	70	0,248	-0,196	0,026
150	60	0,258	-0,187	0,036
150	70	0,263	-0,202	0,031
150	80	0,264	-0,211	0,027
150	90	0,265	-0,220	0,023
150	100	0,271	-0,221	0,025
150	110	0,328	-0,199	0,065
150	110	0,353	-0,190	0,082
150	120	0,435	-0,137	0,149
150	120	0,459	-0,117	0,171
150	125	0,857	0,414	0,636
150	130	0,926	0,529	0,728
150	135	0,944	0,545	0,745
150	140	1,169	1,034	1,102
150	145		2,295	2,295
150	150		2,663	2,663
150	155			
150	160			
150	166			
150	170			
150	175			
150	180			
150	185			
150	187			
150	165			

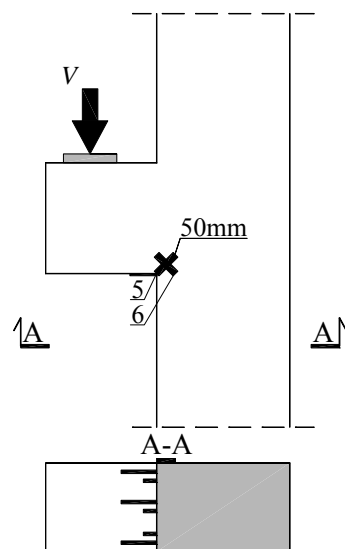
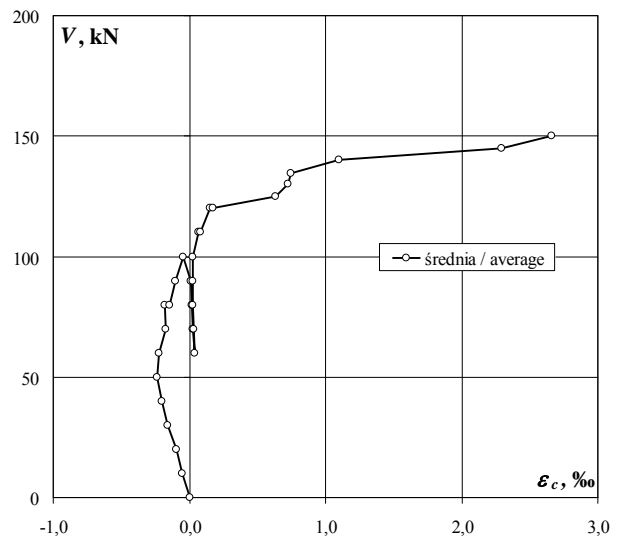
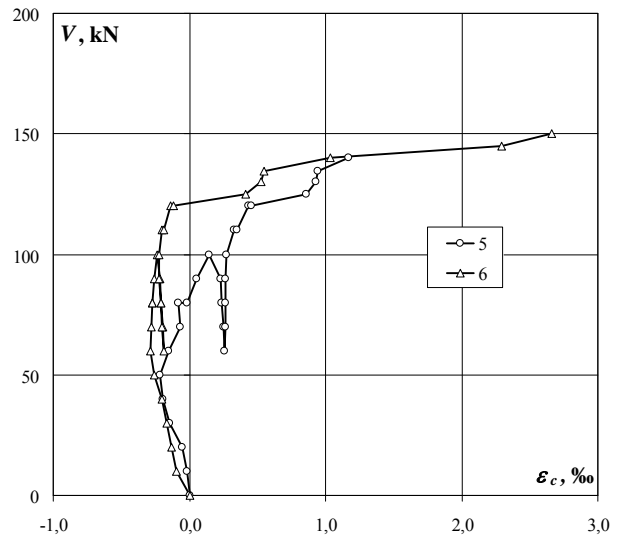

Na betonie – odkształcenia (ϵ_c) / On concrete surface – strains (ϵ_c)

obciążenie słupa column load	obciążenie wspornika corbel load	odkształcenie strain			
		7	8	9	średnia/ average
kN	kN	‰	‰	‰	‰
0	0	0,000	0,000	0,000	0,000
150	10	0,047	-0,003	0,013	0,019
150	20	0,057	-0,029	-0,008	0,007
150	30	0,079	-0,058	-0,040	-0,006
150	40	0,056	-0,115	-0,072	-0,044
150	50	0,083	-0,206	-0,168	-0,097
150	60	0,110	-0,249	-0,227	-0,122
150	70	-0,045	-0,260	-0,247	-0,184
150	80	-0,251	-0,282	-0,276	-0,270
150	80	-0,034	-0,281	-0,267	-0,194
150	90	-0,018	-0,306	-0,289	-0,204
150	100	0,069	-0,328	-0,312	-0,190
150	90	0,169	-0,298	-0,272	-0,134
150	80	0,149	-0,269	-0,242	-0,121
150	70	0,123	-0,241	-0,214	-0,111
150	60	0,163	-0,208	-0,181	-0,075
150	70	0,175	-0,245	-0,218	-0,096
150	80	0,150	-0,275	-0,248	-0,124
150	90	0,121	-0,305	-0,280	-0,155
150	100	0,099	-0,331	-0,306	-0,179
150	110	0,081	-0,367	-0,339	-0,208
150	110	0,117	-0,361	-0,335	-0,193
150	120	0,085	-0,406	-0,365	-0,229
150	120	0,025	-0,408	-0,364	-0,249
150	125	-0,114	-0,578	-0,536	-0,409
150	130	-0,308	-0,617	-0,562	-0,496
150	135	-0,325	-0,632	-0,573	-0,510
150	140	-0,412	-0,742	-0,674	-0,609
150	145	-0,642	-0,990	-0,722	-0,785
150	150	-0,699	-1,061	-0,769	-0,843
150	155	-0,916	-1,269	-0,811	-0,999
150	160	-1,140	-1,568	-0,990	-1,233
150	166	-1,234	-1,640	-1,010	-1,295
150	170	-1,360	-1,750	-1,098	-1,403
150	175	-2,055	-2,137	-1,293	-1,828
150	180	-2,588	-2,601	-1,569	-2,253
150	185	-2,689	-2,688	-1,640	-2,339
150	187	-2,996	-2,811	-1,802	-2,536
150	165	-3,971	-2,939	-2,844	-3,251

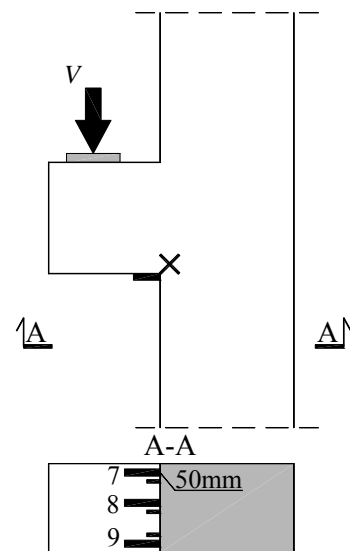
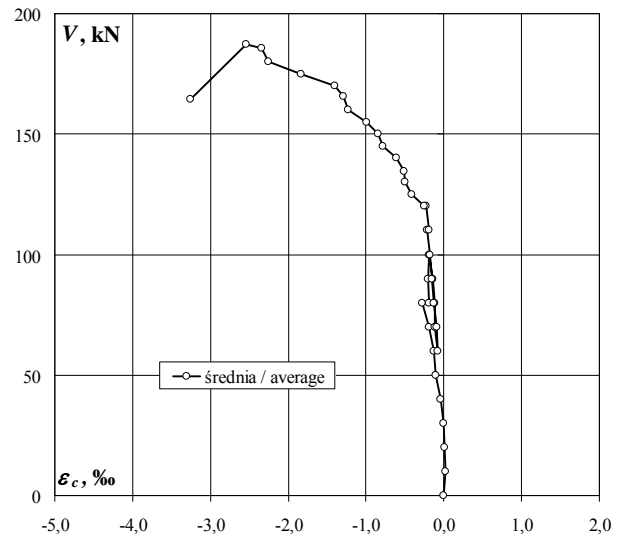
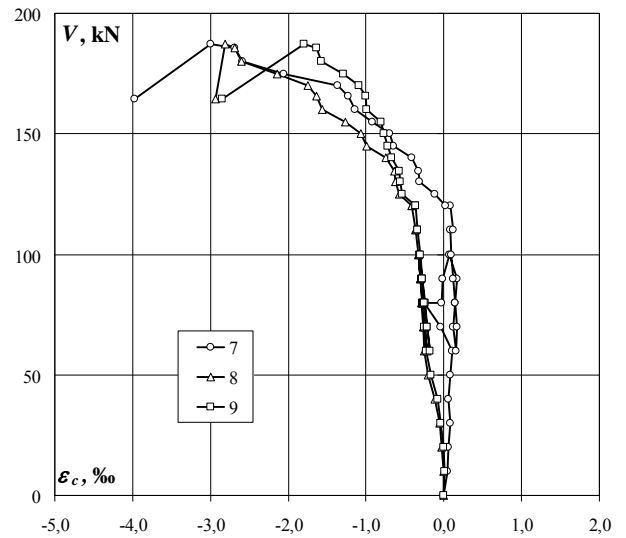

C-0

Na betonie – odkształcenia (ϵ_c) / On concrete surface – strains (ϵ_c)

obciążenie słupa column load	obciążenie wspornika corbel load	odkształcenie strain			
		10	11	12	średnia/average
kN	kN	‰	‰	‰	‰
0	0	0,000	0,000	0,000	0,000
150	10	-0,016	-0,035	0,015	-0,012
150	20	-0,030	-0,065	0,007	-0,029
150	30	-0,042	-0,092	-0,006	-0,047
150	40	-0,047	-0,119	-0,006	-0,057
150	50	-0,094	-0,201	-0,049	-0,115
150	60	-0,134	-0,244	-0,072	-0,150
150	70	-0,164	-0,256	-0,077	-0,166
150	80	-0,215	-0,286	-0,095	-0,199
150	80	-0,214	-0,281	-0,087	-0,194
150	90	-0,275	-0,322	-0,110	-0,236
150	100	-0,341	-0,363	-0,130	-0,278
150	90	-0,282	-0,314	-0,074	-0,223
150	80	-0,223	-0,269	-0,038	-0,177
150	70	-0,175	-0,229	-0,006	-0,137
150	60	-0,122	-0,183	0,026	-0,093
150	70	-0,182	-0,237	-0,018	-0,146
150	80	-0,232	-0,279	-0,052	-0,188
150	90	-0,291	-0,324	-0,089	-0,235
150	100	-0,344	-0,363	-0,122	-0,276
150	110	-0,426	-0,426	-0,161	-0,338
150	110	-0,421	-0,419	-0,145	-0,328
150	120	-0,523	-0,495	-0,183	-0,400
150	120	-0,537	-0,501	-0,168	-0,402
150	125	-0,899	-0,810	-0,345	-0,685
150	130	-1,015	-0,885	-0,393	-0,764
150	135	-1,047	-0,910	-0,414	-0,790
150	140	-1,359	-1,138	-0,563	-1,020
150	145	-2,195	-1,671	-0,858	-1,575
150	150	-2,417	-1,826	-0,952	-1,732
150	155	-3,066	-2,262	-1,188	-2,172
150	160	-3,940	-3,028	-1,509	-2,826
150	166	-4,093	-3,213	-1,601	-2,969
150	170	-4,258	-3,504	-1,734	-3,165
150	175	-3,512	-4,566	-2,141	-3,406
150	180	-2,939	-3,139	-2,080	-2,719
150	185	-2,992	-3,106	-2,097	-2,732
150	187	-2,501	-2,908	-1,890	-2,433
150	165	-2,789	-1,891	-1,453	-2,044

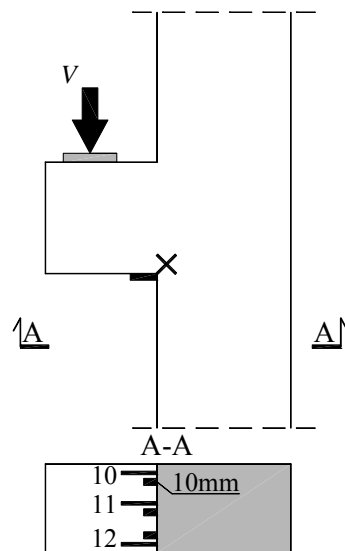
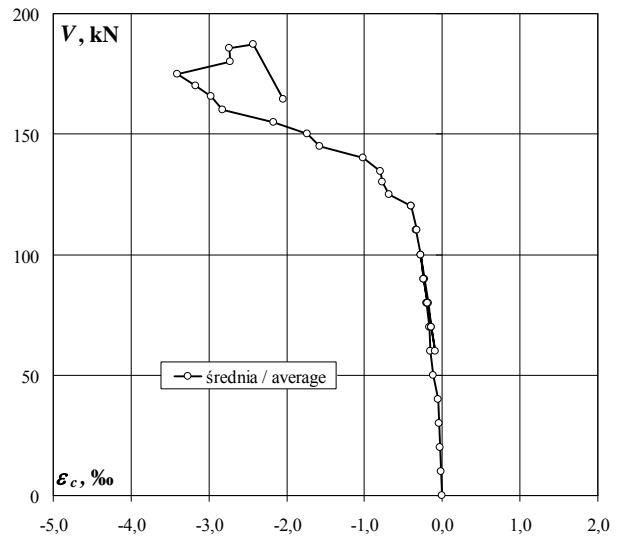
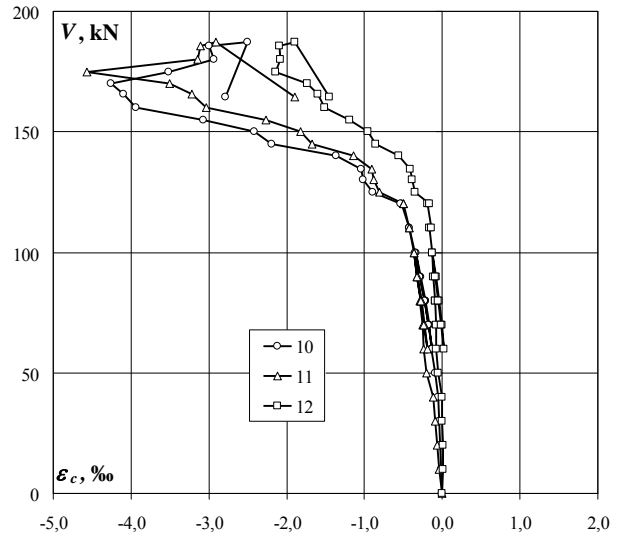



Wspornik po zniszczeniu w stanowisku badawczym / Corbel after failure in test setup



Pręty zbrojenia głównego zerwane podczas badania
Main reinforcement bars were ruptured during test

C-0

Szerokość rozwarcia rys / Crack width

obciążenie słupa column load	obciążenie wspornika corbel load	Numer rysy Crack number					
		1	2	3	4	5	6
kN	kN	mm	mm	mm	mm	mm	mm
150	30	0,10					
150	50	0,10	0,05				
150	50	0,10	0,05				
150	70	0,10	0,10	0,10			
150	90	0,10	0,10	0,15			
150	100	0,10	0,05	0,25			
150	60	0,05	0,05	0,15			
150	110	0,05	0,05	0,25			
150	120	0,05	0,05	0,30	0,07		
150	130	0,05	0,05	0,75	0,05	0,45	
150	140	0,05	0,35	1,20	0,05	0,75	
150	145	0,05	0,35	1,60	0,05	0,90	
150	150	0,05	0,35	2,50	0,05	1,00	
150	155	0,05	0,45	3,00	0,05	0,90	1,00
150	160	0,05	0,60	3,50	0,05	1,40	1,20
150	165	0,05	0,90	4,00	0,05	1,40	1,20
150	170	0,05	0,90	4,50	0,05	1,40	2,00
150	175	0,00	1,60	4,50	0,10	1,40	2,30
150	180	0,00	3,00	5,00	0,10	2,50	3,50
150	185	0,00	3,50	5,00	0,10	3,00	3,50

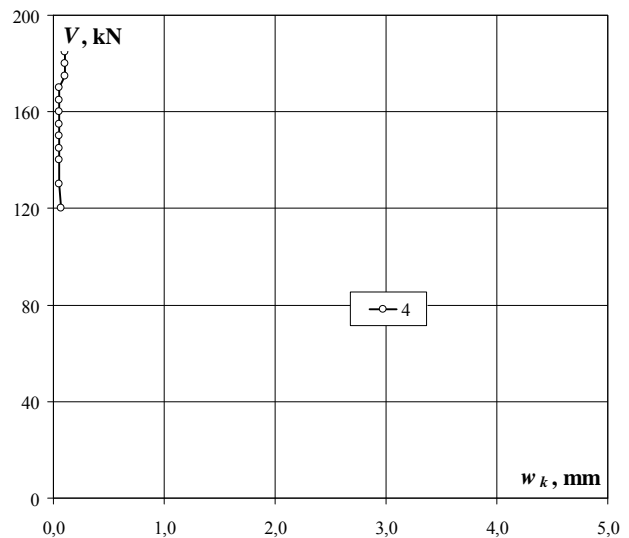
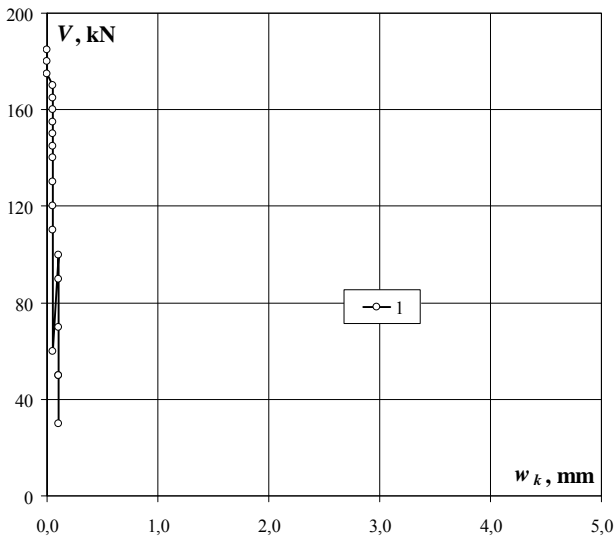
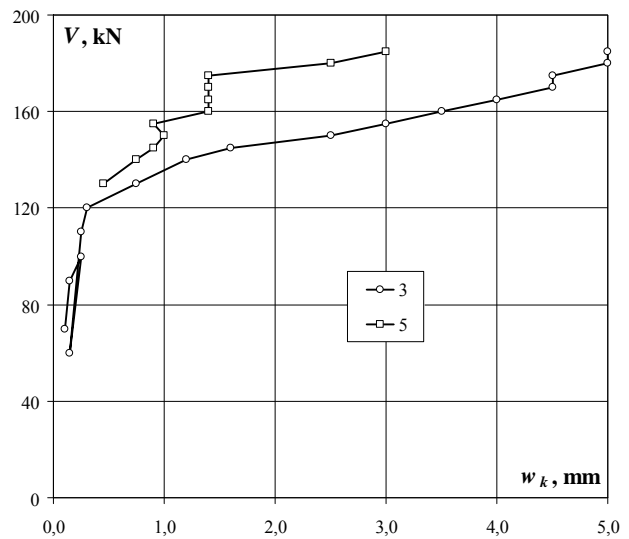
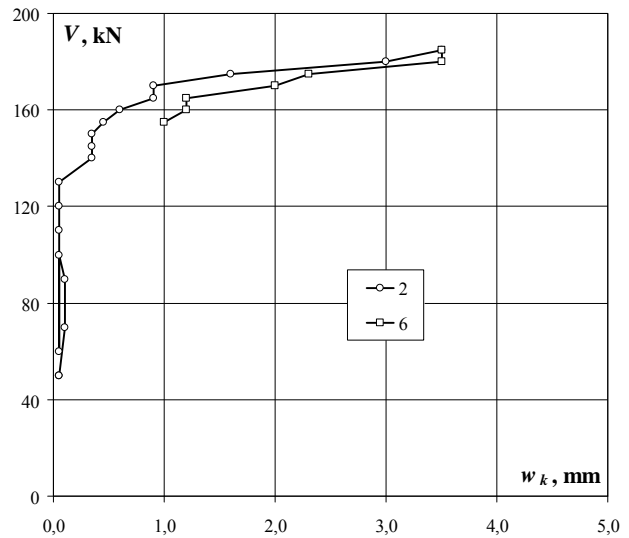

Układ rys przy sile 100kN / Crack pattern at 100kN

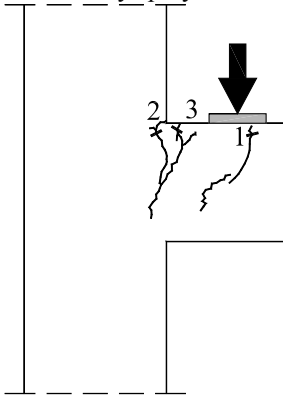

Układ rys przy sile 120kN / Crack pattern at 120kN

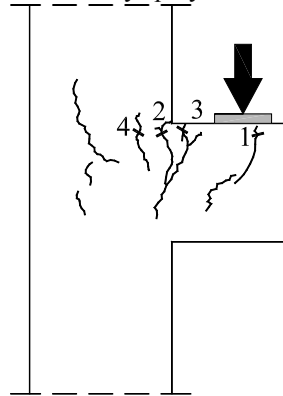

Układ rys przy sile 189kN / Crack pattern at 189kN

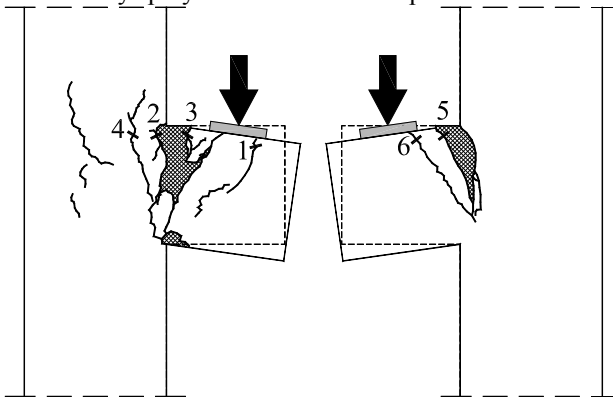

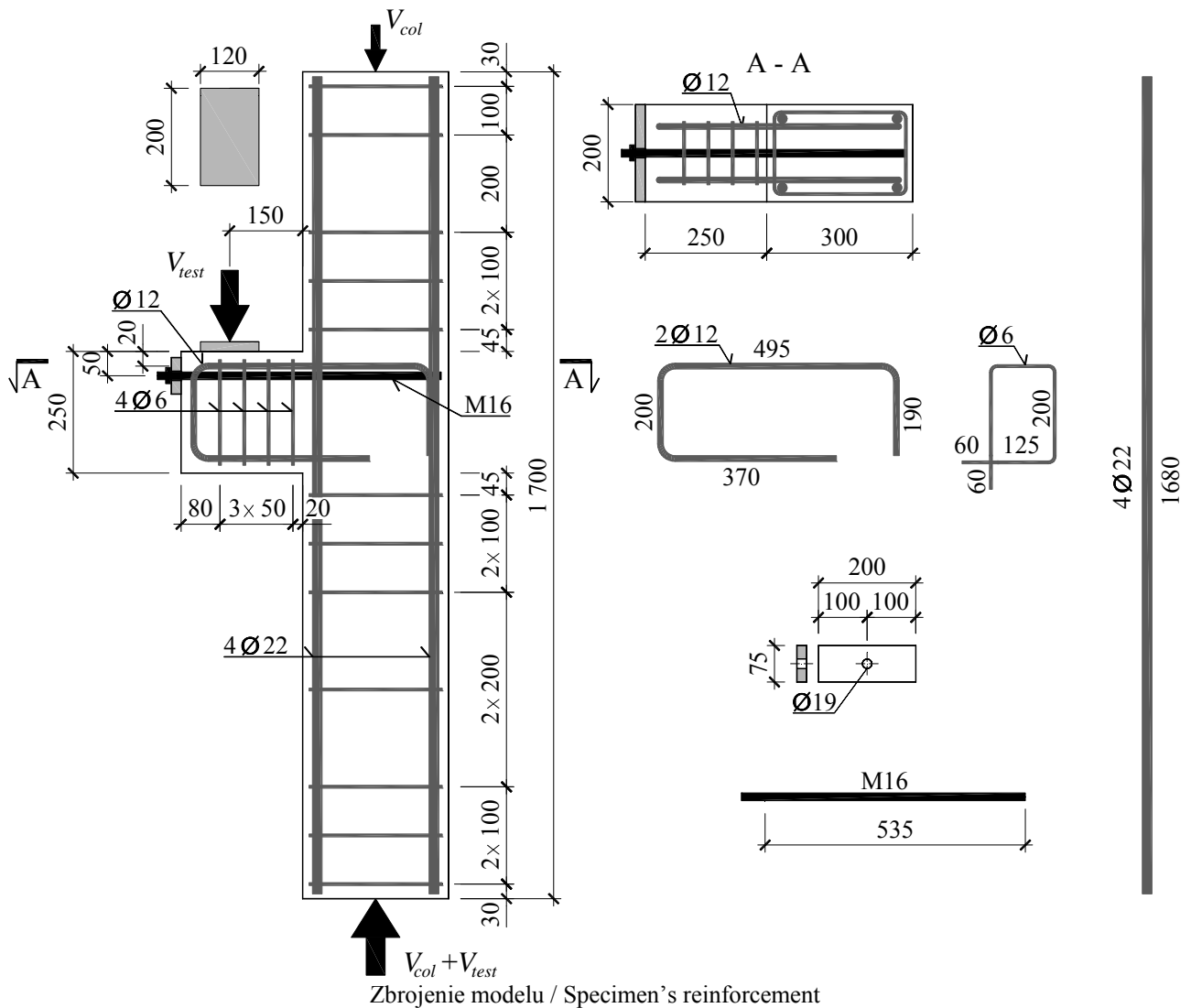

Wytrzymałość betonu na ściskanie / Compressive strength of concrete

$$f_{cm} = 35,0 \text{ MPa}$$

Moduł sprężystości podłużnej / Young's modulus

$$E_{cm} = 25,0 \text{ GPa}$$

Wytrzymałość betonu na rozciąganie przy rozłupywaniu / Tensile splitting strength of concrete

$$f_{ct,sp} = 3,1 \text{ MPa}$$

Gęstość betonu / Density of concrete

$$\rho = 2200 \text{ kg/m}^3$$

Charakterystyka zbrojenia / Characteristics of the reinforcement

Ø6

$$A_s = 28,27 \text{ mm}^2, f_{ym} = 449,8 \text{ MPa}, f_{tm} = 517,4 \text{ MPa}$$

Ø12

$$A_s = 113,86 \text{ mm}^2, f_{ym} = 409,9 \text{ MPa}, f_{tm} = 636,0 \text{ MPa}$$

Ø22

$$A_s = 392,71 \text{ mm}^2, f_{ym} = 547,3 \text{ MPa}, f_{tm} = 628,6 \text{ MPa}$$

M16

$$A_s = 164,99 \text{ mm}^2, f_{ym} = 843,3 \text{ MPa}, f_{tm} = 886,4 \text{ MPa}$$

Siła niszcząca / Failure force

$$V_{test} = 300 \text{ kN}$$

C-I

Zbrojenie główne – odkształcenia (ϵ_s) / Main reinforcement – strains (ϵ_s)

obciążenie słupa column load	obciążenie wspornika corbel load	odkształcenie strain		
		1	2	średnia/ average
kN	kN	‰	‰	‰
0	0	0,000	0,000	0,000
0	0	0,004	0,000	0,002
50	0	-0,009	0,002	-0,004
100	0	-0,006	0,002	-0,002
150	0	-0,002	0,003	0,001
150	10	0,037	0,044	0,041
150	20	0,088	0,097	0,093
150	30	0,192	0,189	0,191
150	40	0,371	0,349	0,360
150	50	0,886	0,706	0,796
150	60	1,382	1,124	1,253
150	70	1,715	1,397	1,556
150	80	1,997	1,631	1,814
150	90	2,313	1,865	2,089
150	100	2,623	2,077	2,350
150	90	2,459	1,901	2,180
150	80	2,269	1,734	2,002
150	70	2,071	1,565	1,818
150	60	1,876	1,399	1,638
150	60	1,420	1,342	1,381
150	70	1,514	1,445	1,480
150	80	1,670	1,600	1,635
150	90	1,813	1,724	1,769
150	100	1,965	1,851	1,908
150	110	2,109	1,975	2,042
150	120	2,254	2,090	2,172
150	130	2,469	2,246	2,358
150	140	2,725	2,582	2,654
150	150	3,961	2,548	3,255
150	160	4,681		4,681
150	170	6,458		6,458
150	180	8,940		8,940
150	190	9,813		9,813
150	200	10,527		10,527
150	210	10,887		10,887
150	220	11,317		11,317
150	230	11,798		11,798
150	240	12,291		12,291
150	250	12,761		12,761
150	260	13,282		13,282
150	270	14,225		14,225
150	275			
150	280			
150	285			
150	290			
150	295			
150	300			
150	259			
150	143			

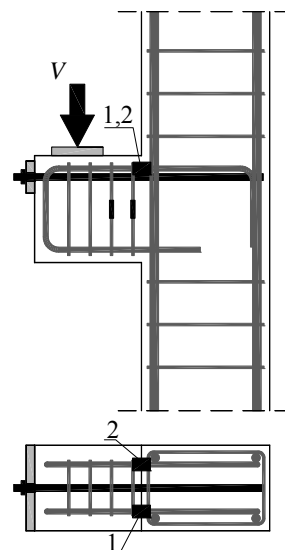
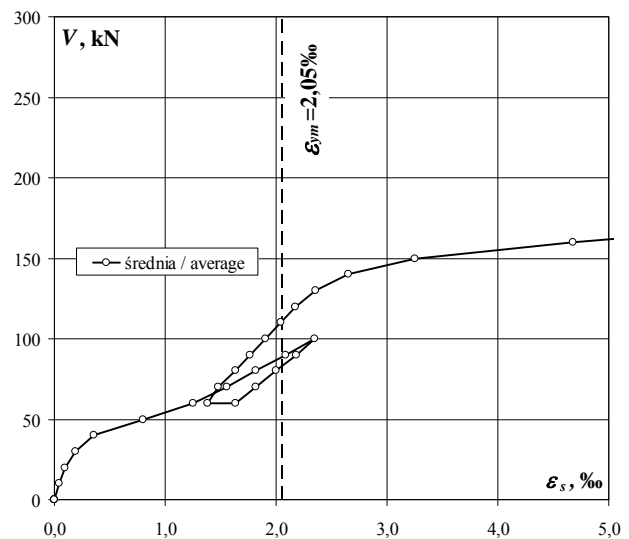
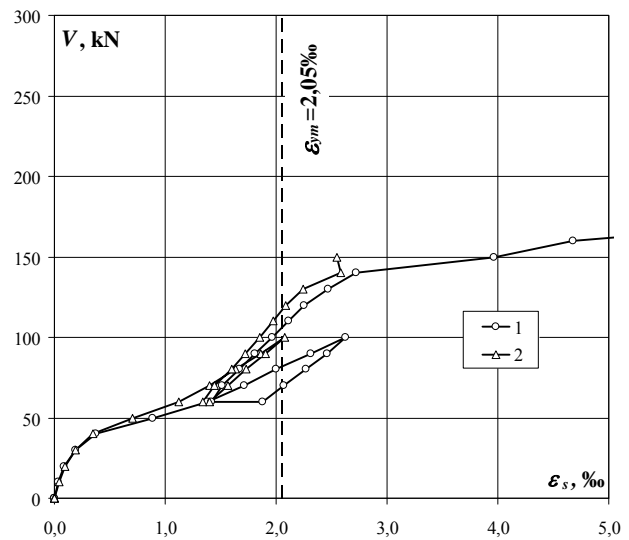

Strzemiona – odkształcenia (ε_s) / Stirrup – strains (ε_s)

obciążenie słupa column load	obciążenie wspornika corbel load	odkształcenie strain		
		3	4	średnia/ average
kN	kN	‰	‰	‰
0	0	0,000	0,000	0,000
0	0	0,000	0,000	0,000
50	0	-0,009	-0,003	-0,006
100	0	-0,014	-0,003	-0,009
150	0	-0,019	-0,003	-0,011
150	10	-0,025	-0,012	-0,019
150	20	-0,028	-0,020	-0,024
150	30	-0,032	-0,028	-0,030
150	40	-0,031	-0,036	-0,034
150	50	-0,038	-0,051	-0,045
150	60	-0,073	-0,063	-0,068
150	70	-0,035	-0,076	-0,056
150	80	0,035	-0,087	-0,026
150	90	0,096	-0,099	-0,002
150	100	0,136	-0,109	0,014
150	90	0,160	-0,100	0,030
150	80	0,171	-0,093	0,039
150	70	0,179	-0,085	0,047
150	60	0,188	-0,076	0,056
150	60	0,184	-0,090	0,047
150	70	0,174	-0,098	0,038
150	80	0,162	-0,108	0,027
150	90	0,155	-0,115	0,020
150	100	0,148	-0,123	0,013
150	110	0,150	-0,132	0,009
150	120	0,162	-0,140	0,011
150	130	0,180	-0,149	0,016
150	140	0,205	-0,157	0,024
150	150	0,226	-0,165	0,031
150	160	0,232	-0,171	0,031
150	170	0,237	-0,177	0,030
150	180	0,232	-0,182	0,025
150	190	0,218	-0,189	0,015
150	200	0,229	-0,194	0,018
150	210	0,237	-0,196	0,021
150	220	0,223	-0,198	0,013
150	230	0,227	-0,192	0,018
150	240	0,246	-0,154	0,046
150	250	0,287	-0,087	0,100
150	260	0,346	-0,064	0,141
150	270	0,493	0,028	0,261
150	275	0,547		0,547
150	280	0,558		0,558
150	285	0,566		0,566
150	290	0,713		0,713
150	295	0,724		0,724
150	300	0,741		0,741
150	259			
150	143			

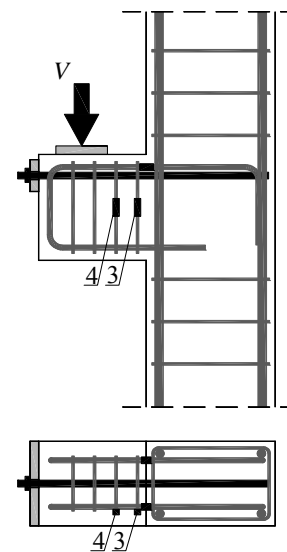
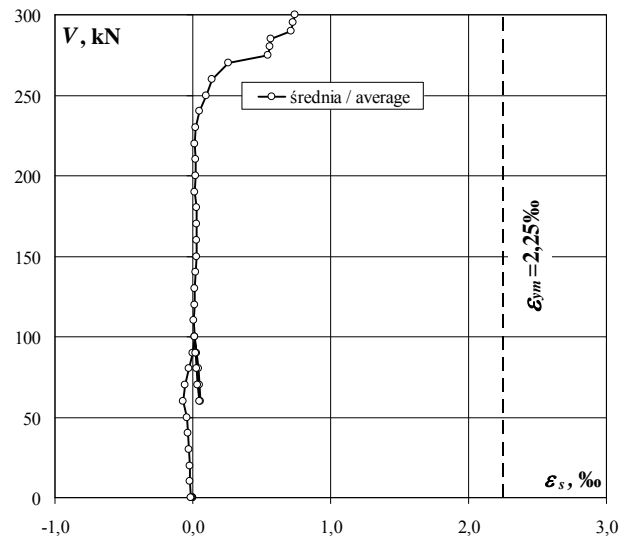
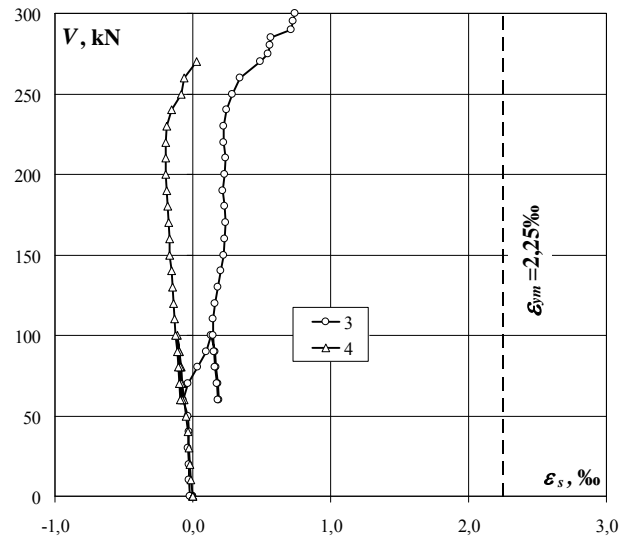

C-I

Na betonie – odkształcenia (ε_c) / On concrete surface – strains (ε_c)

obciążenie słupa column load	obciążenie wspornika corbel load	odkształcenie strain		
		5	6	średnia / average
kN	kN	‰	‰	‰
0	0	0,000	0,000	0,000
0	0	0,000	0,000	0,000
50	0	-0,013	-0,011	-0,012
100	0	-0,028	-0,025	-0,027
150	0	-0,046	-0,039	-0,043
150	10	-0,069	-0,080	-0,075
150	20	-0,090	-0,121	-0,106
150	30	-0,110	-0,163	-0,137
150	40	-0,129	-0,202	-0,166
150	50	-0,142	-0,247	-0,195
150	60	-0,160	-0,288	-0,224
150	70	-0,161	-0,315	-0,238
150	80	-0,149	-0,317	-0,233
150	90	-0,136	-0,315	-0,226
150	100	-0,120	-0,315	-0,218
150	90	-0,097	-0,304	-0,201
150	80	-0,083	-0,295	-0,189
150	70	-0,071	-0,284	-0,178
150	60	-0,061	-0,275	-0,168
150	60	-0,053	-0,261	-0,157
150	70	-0,065	-0,275	-0,170
150	80	-0,080	-0,290	-0,185
150	90	-0,089	-0,299	-0,194
150	100	-0,100	-0,312	-0,206
150	110	-0,108	-0,326	-0,217
150	120	-0,112	-0,340	-0,226
150	130	-0,108	-0,358	-0,233
150	140	-0,093	-0,375	-0,234
150	150	-0,050	-0,376	-0,213
150	160	-0,020	-0,377	-0,199
150	170	0,017	-0,386	-0,185
150	180	0,027	-0,355	-0,164
150	190	-0,015	-0,266	-0,141
150	200	-0,007	-0,201	-0,104
150	210	0,008	-0,163	-0,078
150	220	0,021	-0,105	-0,042
150	230	0,020	-0,073	-0,027
150	240	0,016	0,008	0,012
150	250	0,014	0,057	0,036
150	260	0,012	0,108	0,060
150	270	0,031	0,184	0,108
150	275	-0,020	0,249	0,115
150	280	-0,032	0,288	0,128
150	285	-0,054	0,353	0,150
150	290	-0,248	0,543	0,148
150	295	-0,240	0,497	0,129
150	300	-0,247	0,461	0,107
150	259			
150	143			

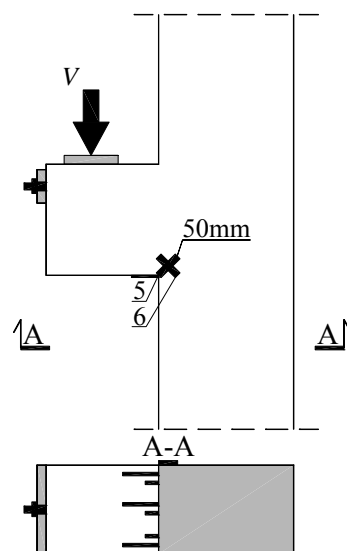
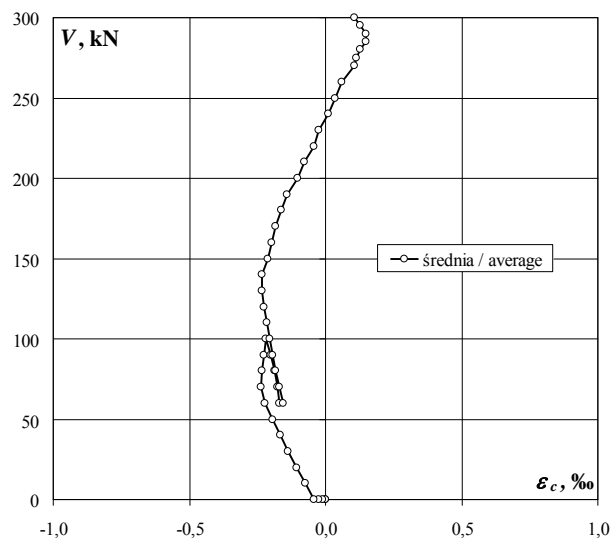
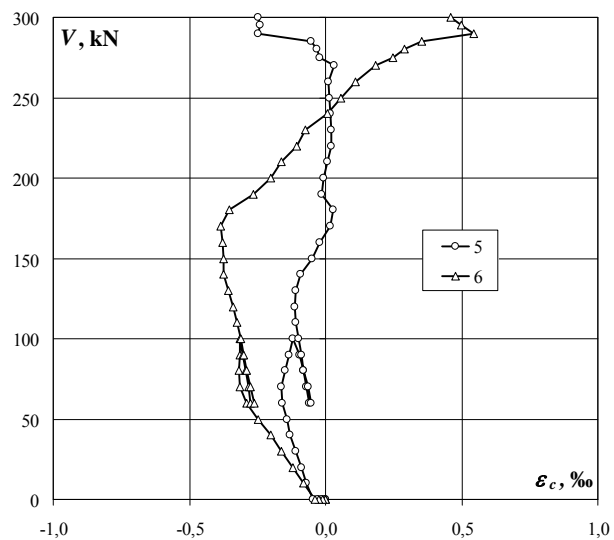

Na betonie – odkształcenia (ϵ_c) / On concrete surface – strains (ϵ_c)

obciążenie słupa column load	obciążenie wspornika corbel load	odkształcenie strain			
		7	8	9	średnia/ average
kN	kN	‰	‰	‰	‰
0	0	0,000	0,000	0,000	0,000
0	0	0,000	0,001	0,000	0,000
50	0	0,005	0,008	0,006	0,006
100	0	0,012	0,018	0,014	0,015
150	0	0,021	0,030	0,022	0,024
150	10	0,014	0,005	0,013	0,011
150	20	0,008	-0,023	0,006	-0,003
150	30	0,002	-0,068	-0,007	-0,024
150	40	-0,024	-0,141	-0,031	-0,065
150	50	-0,093	-0,250	-0,060	-0,134
150	60	-0,095	-0,276	-0,089	-0,153
150	70	-0,102	-0,289	-0,101	-0,164
150	80	-0,099	-0,302	-0,108	-0,170
150	90	-0,084	-0,317	-0,120	-0,174
150	100	-0,062	-0,339	-0,134	-0,178
150	90	-0,017	-0,307	-0,098	-0,141
150	80	-0,002	-0,279	-0,070	-0,117
150	70	0,008	-0,253	-0,046	-0,097
150	60	0,016	-0,228	-0,028	-0,080
150	60	0,024	-0,217	-0,019	-0,071
150	70	0,004	-0,243	-0,037	-0,092
150	80	-0,023	-0,273	-0,066	-0,121
150	90	-0,036	-0,295	-0,086	-0,139
150	100	-0,048	-0,319	-0,109	-0,159
150	110	-0,038	-0,338	-0,128	-0,168
150	120	-0,004	-0,357	-0,144	-0,168
150	130	0,026	-0,379	-0,159	-0,171
150	140	0,009	-0,403	-0,170	-0,188
150	150	-0,010	-0,442	-0,191	-0,214
150	160	-0,029	-0,479	-0,213	-0,240
150	170	-0,039	-0,516	-0,241	-0,265
150	180	-0,058	-0,557	-0,274	-0,296
150	190	-0,098	-0,605	-0,311	-0,338
150	200	-0,143	-0,658	-0,349	-0,383
150	210	-0,157	-0,694	-0,374	-0,408
150	220	-0,176	-0,741	-0,407	-0,441
150	230	-0,197	-0,792	-0,444	-0,478
150	240	-0,210	-0,838	-0,472	-0,507
150	250	-0,213	-0,892	-0,502	-0,536
150	260	-0,207	-0,938	-0,534	-0,560
150	270	-0,017	-0,894	-0,514	-0,475
150	275	0,195	-0,675	-0,331	-0,270
150	280	0,191	-0,661	-0,315	-0,262
150	285	0,144	-0,689	-0,332	-0,292
150	290	-0,093	-0,752	-0,277	-0,374
150	295	-0,126	-0,795	-0,294	-0,405
150	300	-0,166	-0,893	-0,336	-0,465
150	259	-0,104	-1,090	-0,339	-0,511
150	143	-0,091	-0,619	-0,115	-0,275

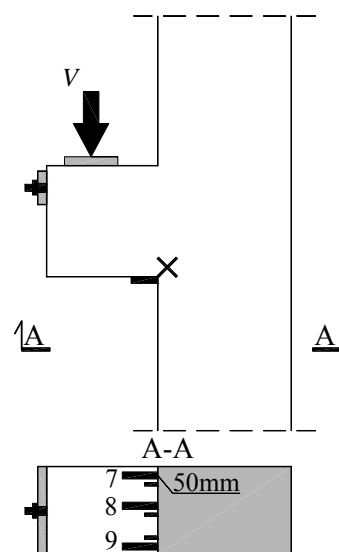
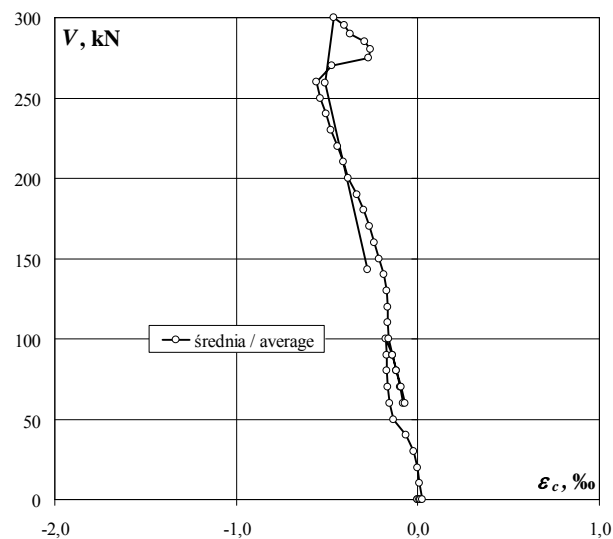
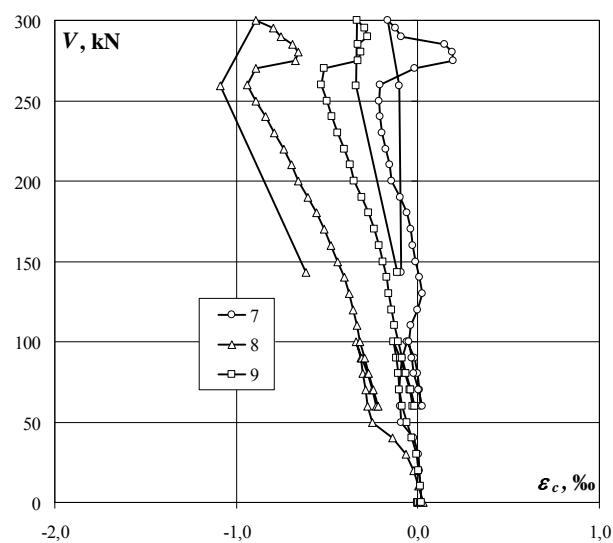

C-I

Na betonie – odkształcenia (ε_c) / On concrete surface – strains (ε_c)

obciążenie słupa column load	obciążenie wspornika corbel load	odkształcenie strain			
		10	11	12	średnia/ average
kN	kN	‰	‰	‰	‰
0	0	0,000	0,000	0,000	0,000
0	0	0,000	0,000	0,001	0,000
50	0	0,000	0,003	0,008	0,004
100	0	0,003	0,006	0,011	0,007
150	0	0,007	0,012	0,016	0,012
150	10	-0,008	0,000	-0,005	-0,004
150	20	-0,025	-0,014	-0,020	-0,020
150	30	-0,046	-0,037	-0,038	-0,040
150	40	-0,074	-0,075	-0,061	-0,070
150	50	-0,107	-0,137	-0,077	-0,107
150	60	-0,111	-0,158	-0,122	-0,130
150	70	-0,114	-0,168	-0,132	-0,138
150	80	-0,122	-0,179	-0,151	-0,151
150	90	-0,130	-0,190	-0,166	-0,162
150	100	-0,141	-0,203	-0,186	-0,177
150	90	-0,120	-0,188	-0,142	-0,150
150	80	-0,104	-0,174	-0,108	-0,129
150	70	-0,089	-0,161	-0,082	-0,111
150	60	-0,076	-0,146	-0,060	-0,094
150	60	-0,065	-0,141	-0,069	-0,092
150	70	-0,077	-0,154	-0,087	-0,106
150	80	-0,093	-0,171	-0,120	-0,128
150	90	-0,104	-0,181	-0,147	-0,144
150	100	-0,117	-0,192	-0,171	-0,160
150	110	-0,129	-0,202	-0,201	-0,177
150	120	-0,140	-0,211	-0,217	-0,189
150	130	-0,153	-0,224	-0,237	-0,205
150	140	-0,169	-0,235	-0,256	-0,220
150	150	-0,192	-0,253	-0,283	-0,243
150	160	-0,210	-0,271	-0,313	-0,265
150	170	-0,228	-0,286	-0,347	-0,287
150	180	-0,249	-0,301	-0,390	-0,313
150	190	-0,264	-0,318	-0,431	-0,338
150	200	-0,288	-0,338	-0,478	-0,368
150	210	-0,310	-0,353	-0,517	-0,393
150	220	-0,340	-0,378	-0,596	-0,438
150	230	-0,370	-0,404	-0,670	-0,481
150	240	-0,400	-0,436	-0,738	-0,525
150	250	-0,431	-0,464	-0,797	-0,564
150	260	-0,456	-0,492	-0,868	-0,605
150	270	-0,420	-0,499	-0,979	-0,633
150	275	-0,295	-0,440	-0,911	-0,549
150	280	-0,303	-0,439	-0,924	-0,555
150	285	-0,315	-0,444	-0,916	-0,558
150	290	-0,301	-0,367	-0,706	-0,458
150	295	-0,308	-0,366	-0,714	-0,463
150	300	-0,316	-0,377	-0,699	-0,464
150	259	-0,231	-0,412	-0,471	-0,371
150	143	-0,208	-0,182	-0,259	-0,216

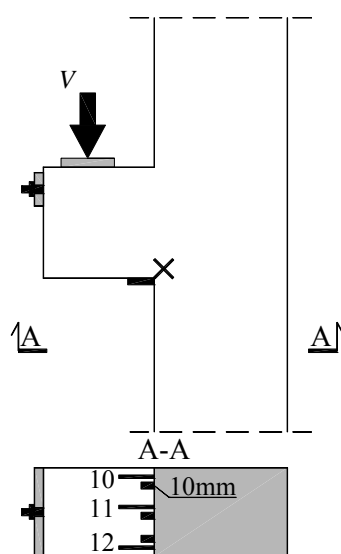
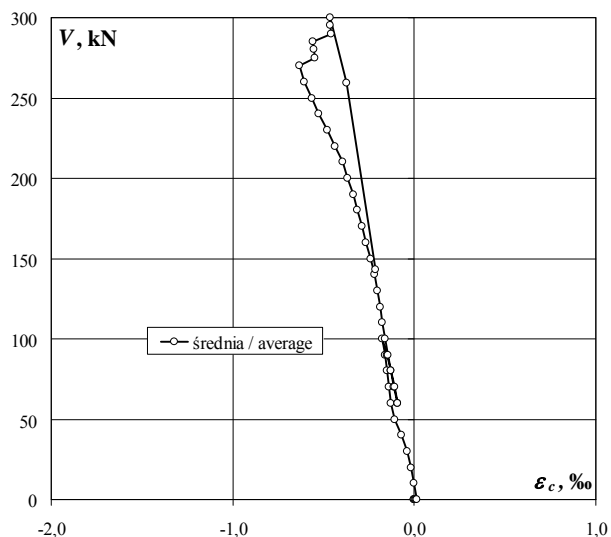
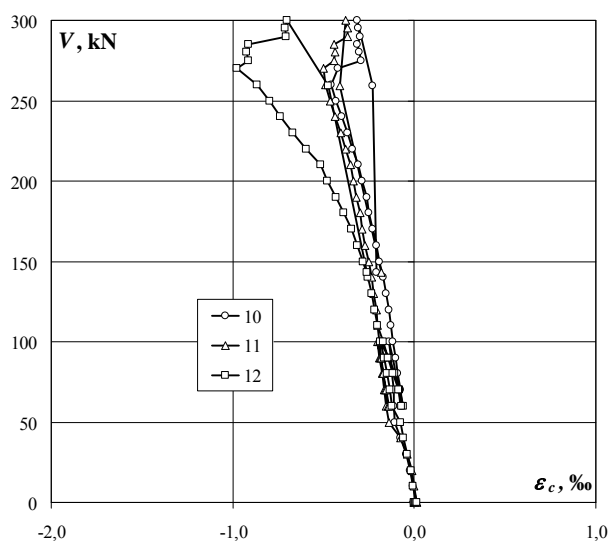



Wspornik po zniszczeniu w stanowisku badawczym / Corbel after failure in test setup



Powierzchnia ściskana po badaniu / Compression surface after test

C-I

Szerokość rozwarcia rys / Crack width

obciążenie słupa column load	obciążenie wspornika corbel load	Numer rysy Crack number					
		1	2	3	4	5	6
kN	kN	mm	mm	mm	mm	mm	mm
150	40	0,05					
150	50	0,07	0,05				
150	60	0,07	0,10	0,07			
150	70	0,07	0,15	0,10			
150	80	0,07	0,20	0,10			
150	90	0,10	0,25	0,20			
150	100	0,10	0,25	0,20			
150	90	0,10	0,25	0,20			
150	80	0,10	0,20	0,20			
150	70	0,07	0,20	0,15			
150	60	0,07	0,20	0,15			
150	80	0,07	0,20	0,15			
150	90	0,10	0,20	0,20			
150	100	0,10	0,23	0,20			
150	110	0,15	0,25	0,25			
150	120	0,15	0,30	0,25			
150	130	0,20	0,33	0,30			
150	140	0,25	0,35	0,35			
150	150	0,35	0,40	0,35			
150	160	0,40	0,45	0,45			
150	170	0,40	0,50	0,45			
150	180	0,45	0,55	0,50			
150	190	0,50	0,60	0,55			
150	200	0,60	0,65	0,65			
150	210	0,65	0,75	0,70	0,35		
150	220	0,75	0,75	0,80	0,40		
150	230	0,80	0,80	0,85	0,45		
150	240	0,90	0,85	0,90	0,50		
150	250	1,10	1,00	1,20	0,55		
150	260	1,20	1,20	1,30	0,70		
150	270	1,40	1,20	1,40	0,90		
150	280	1,60	1,40	1,40	0,90		
150	290	1,80	1,60	1,40	1,00		

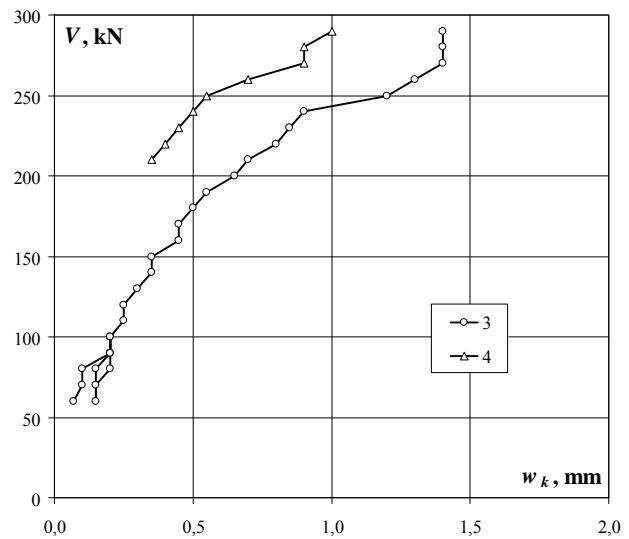
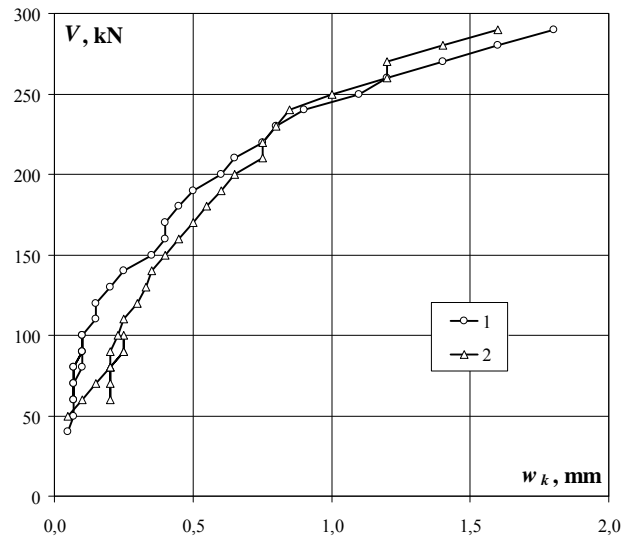

Układ rys przy sile 100kN / Crack pattern at 100kN

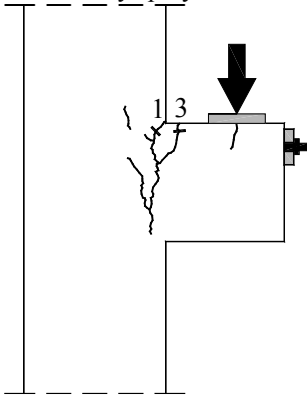

Układ rys przy sile 150kN / Crack pattern at 150kN

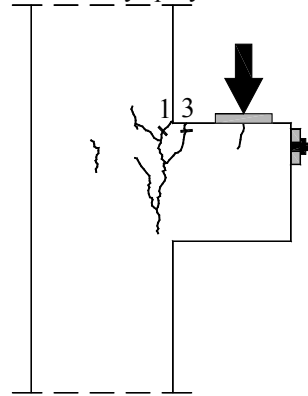

Układ rys przy sile 200kN / Crack pattern at 200kN

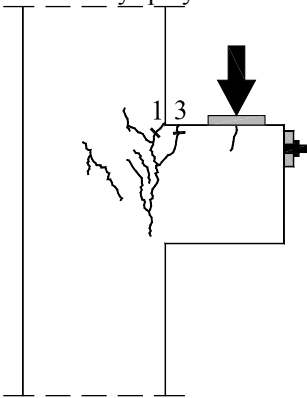

Układ rys przy sile 250kN / Crack pattern at 250kN

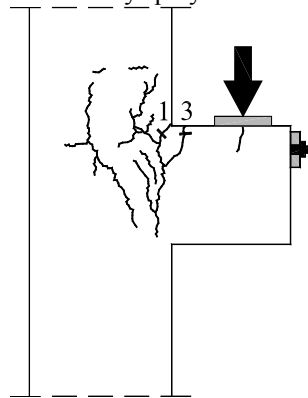

Układ rys przy sile 270kN / Crack pattern at 270kN

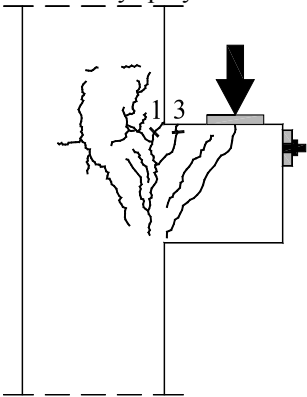

Układ rys przy sile 300kN / Crack pattern at 300kN

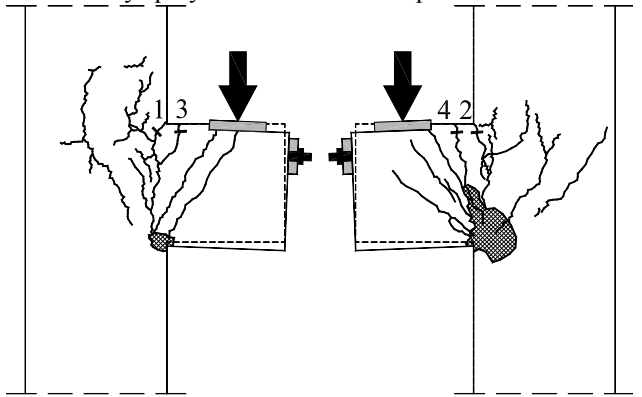

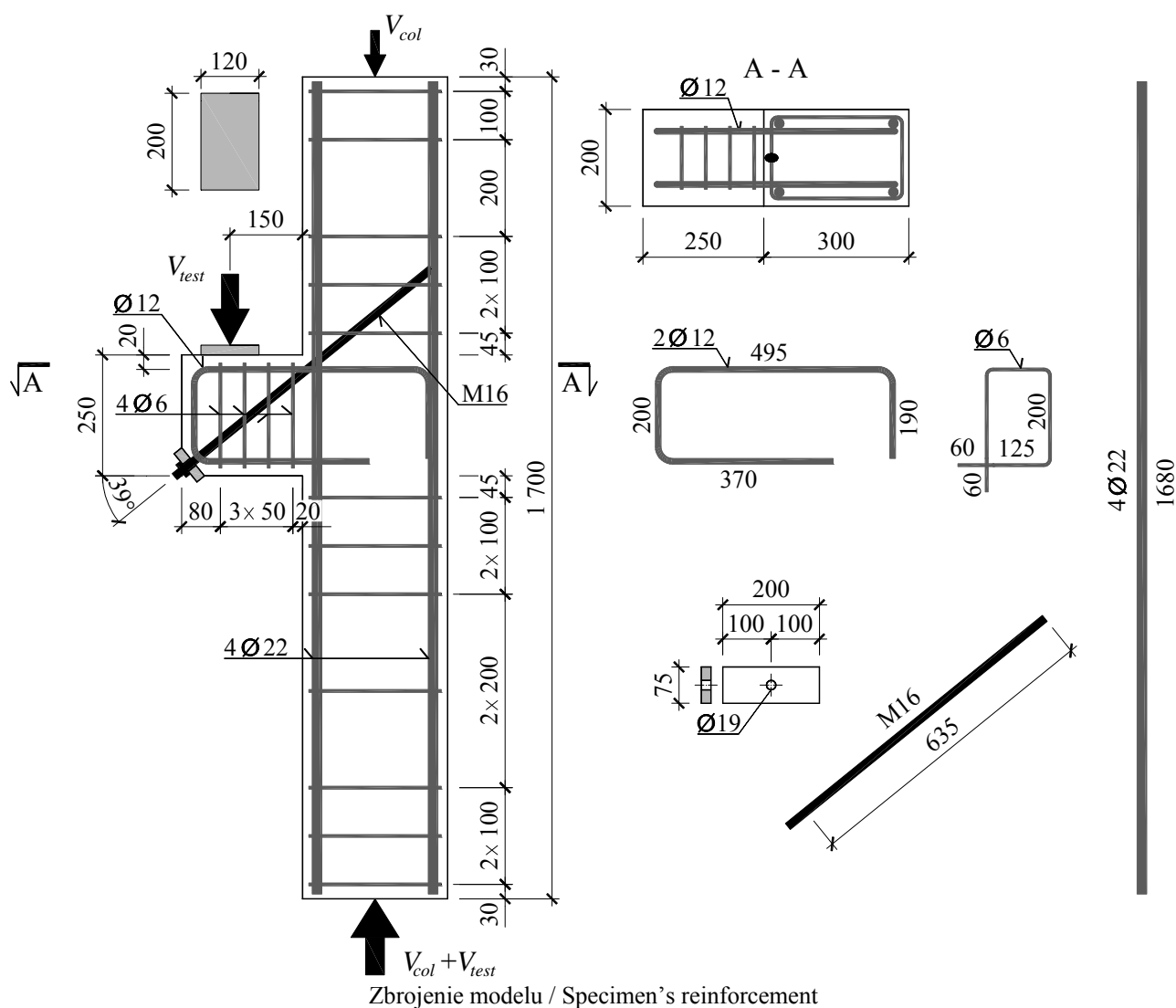

Wytrzymałość betonu na ściskanie / Compressive strength of concrete

$$f_{cm} = 35,0 \text{ MPa}$$

Moduł sprężystości podłużnej / Young's modulus

$$E_{cm} = 25,0 \text{ GPa}$$

Wytrzymałość betonu na rozciąganie przy rozłupywaniu / Tensile splitting strength of concrete

$$f_{ct,sp} = 3,1 \text{ MPa}$$

Gęstość betonu / Density of concrete

$$\rho = 2200 \text{ kg/m}^3$$

Charakterystyka zbrojenia / Characteristics of the reinforcement

Ø6

$$A_s = 28,27 \text{ mm}^2, f_{ym} = 449,8 \text{ MPa}, f_{tm} = 517,4 \text{ MPa}$$

Ø12

$$A_s = 113,86 \text{ mm}^2, f_{ym} = 409,9 \text{ MPa}, f_{tm} = 636,0 \text{ MPa}$$

Ø22

$$A_s = 392,71 \text{ mm}^2, f_{ym} = 547,3 \text{ MPa}, f_{tm} = 628,6 \text{ MPa}$$

M16

$$A_s = 164,99 \text{ mm}^2, f_{ym} = 843,3 \text{ MPa}, f_{tm} = 886,4 \text{ MPa}$$

Siła niszcząca / Failure force

$$V_{test} = 309 \text{ kN}$$

C-II

Zbrojenie główne – odkształcenia (ϵ_s) / Main reinforcement – strains (ϵ_s)

obciążenie słupa column load	obciążenie wspornika corbel load	odkształcenie strain		
		1	2	średnia/average
kN	kN	‰	‰	‰
0	0	0,000	0,000	0,000
50	0	0,000	0,000	0,000
100	0	-0,032	0,000	-0,016
150	0	-0,082	-0,001	-0,042
150	10	0,040	0,048	0,044
150	20	0,135	0,122	0,129
150	30	0,231	0,252	0,242
150	40	0,555	0,486	0,521
150	50	1,249	0,952	1,101
150	60	1,495	1,159	1,327
150	70	1,846	1,394	1,620
150	80	2,110	1,595	1,853
150	90	2,363	1,801	2,082
150	100	2,548	1,998	2,273
150	90	2,485	1,944	2,215
150	80	2,303	1,783	2,043
150	70	2,106	1,614	1,860
150	60	1,817	1,405	1,611
150	60	1,766	1,302	1,534
150	70	1,948	1,458	1,703
150	80	2,047	1,589	1,818
150	90	2,152	1,734	1,943
150	100	2,309	1,873	2,091
150	110	2,408	2,019	2,214
150	120	2,544	2,157	2,351
150	130	2,773	2,389	2,581
150	140	7,181	5,687	6,434
150	150	7,558	4,906	6,232
150	160	9,430		9,430
150	170	8,943		8,943
150	180	8,838		8,838
150	190	8,056		8,056
150	200			
150	210			
150	220			
150	230			
150	230			
150	240			
150	250			
150	260			
150	270			
150	270			
150	280			
150	285			
150	290			
150	296			
150	300			
150	305			
150	309			
150	306			
150	288			
150	245			
150	198			
150	107			

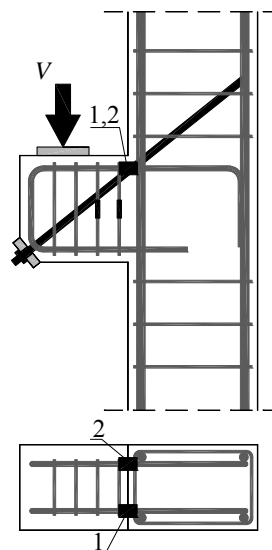
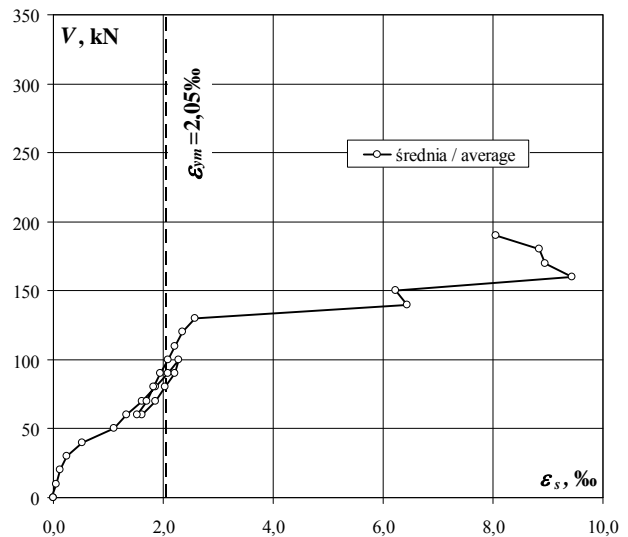
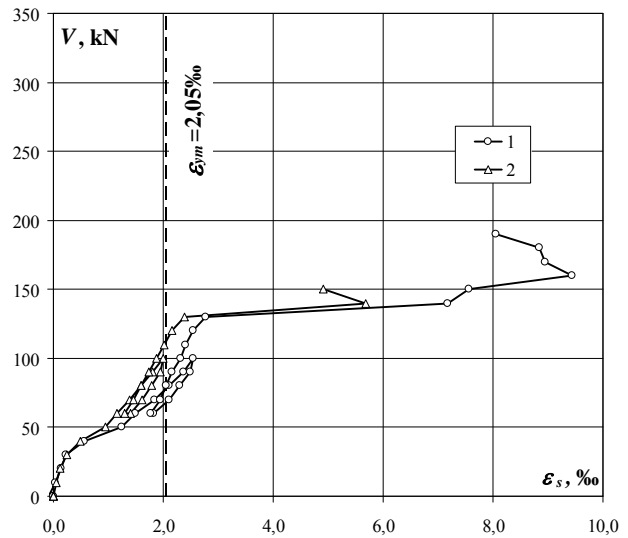

Strzemiona – odkształcenia (ε_s) / Stirrup – strains (ε_s)

obciążenie słupa column load	obciążenie wspornika corbel load	odkształcenie strain		
		3	4	średnia/ average
kN	kN	‰	‰	‰
0	0	0,000	0,000	0,000
50	0	-0,009	0,000	-0,005
100	0	-0,013	-0,002	-0,008
150	0	-0,021	-0,002	-0,012
150	10	-0,024	-0,004	-0,014
150	20	-0,027	-0,005	-0,016
150	30	-0,035	-0,008	-0,022
150	40	-0,040	-0,014	-0,027
150	50	-0,071	-0,018	-0,045
150	60	-0,086	-0,021	-0,054
150	70	-0,107	-0,024	-0,066
150	80	-0,126	-0,028	-0,077
150	90	-0,140	-0,035	-0,088
150	100	-0,150	-0,041	-0,096
150	90	-0,146	-0,040	-0,093
150	80	-0,139	-0,036	-0,088
150	70	-0,129	-0,031	-0,080
150	60	-0,115	-0,026	-0,071
150	60	-0,125	-0,034	-0,080
150	70	-0,137	-0,040	-0,089
150	80	-0,147	-0,044	-0,096
150	90	-0,157	-0,049	-0,103
150	100	-0,167	-0,054	-0,111
150	110	-0,176	-0,058	-0,117
150	120	-0,177	-0,063	-0,120
150	130	-0,184	-0,069	-0,127
150	140	-0,175	-0,073	-0,124
150	150	-0,176	-0,074	-0,125
150	160	-0,019	-0,088	-0,054
150	170	0,133	-0,082	0,026
150	180	0,204	-0,021	0,092
150	190	0,247	0,002	0,125
150	200	0,283	0,011	0,147
150	210	0,357	0,023	0,190
150	220	0,537	0,028	0,283
150	230	0,597	0,127	0,362
150	230	0,606	0,171	0,389
150	240	0,625	0,182	0,404
150	250	0,661	0,234	0,448
150	260	0,696	0,274	0,485
150	270	0,722	0,312	0,517
150	270	0,729	0,336	0,533
150	280	0,763	0,369	0,566
150	285	0,789	0,396	0,593
150	290	0,841	0,417	0,629
150	296	0,806	0,446	0,626
150	300	0,478	0,517	0,498
150	305	0,114	0,544	0,329
150	309	-0,126	0,556	0,215
150	306		0,653	0,653
150	288		0,748	0,748
150	245		0,932	0,932
150	198		1,233	1,233
150	107		1,298	1,298

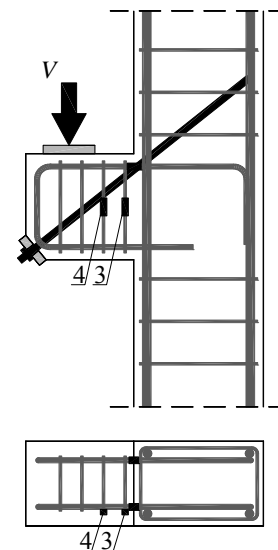
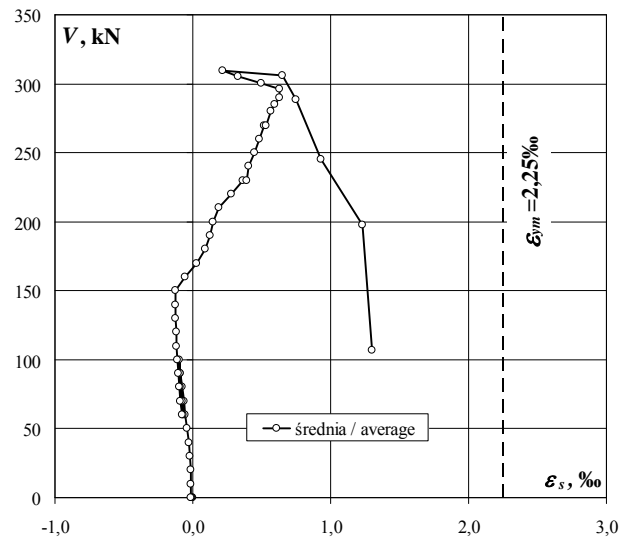
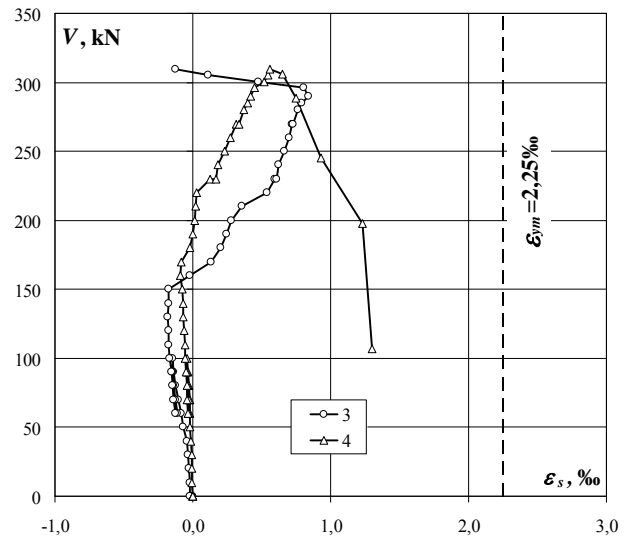

C-II

Na betonie – odkształcenia (ε_c) / On concrete surface – strains (ε_c)

obciążenie słupa column load	obciążenie wspornika corbel load	odkształcenie strain		
		5	6	średnia/ average
kN	kN	‰	‰	‰
0	0	0,000	0,000	0,000
50	0	0,000	-0,010	-0,005
100	0	-0,002	-0,022	-0,012
150	0	-0,002	-0,036	-0,019
150	10	-0,017	-0,081	-0,049
150	20	-0,032	-0,126	-0,079
150	30	-0,046	-0,167	-0,107
150	40	-0,067	-0,224	-0,146
150	50	-0,082	-0,302	-0,192
150	60	-0,084	-0,333	-0,209
150	70	-0,061	-0,349	-0,205
150	80	-0,022	-0,347	-0,185
150	90	0,013	-0,360	-0,174
150	100	0,058	-0,354	-0,148
150	90	0,080	-0,342	-0,131
150	80	0,091	-0,332	-0,121
150	70	0,100	-0,323	-0,112
150	60	0,110	-0,312	-0,101
150	60	0,113	-0,312	-0,100
150	70	0,101	-0,326	-0,113
150	80	0,092	-0,336	-0,122
150	90	0,084	-0,346	-0,131
150	100	0,077	-0,356	-0,140
150	110	0,075	-0,365	-0,145
150	120	0,083	-0,365	-0,141
150	130	0,088	-0,367	-0,140
150	140	0,119	-0,332	-0,107
150	150	0,125	-0,327	-0,101
150	160	0,168	-0,256	-0,044
150	170	0,190	-0,234	-0,022
150	180	0,191	-0,212	-0,011
150	190	0,201	-0,159	0,021
150	200	0,203	-0,082	0,061
150	210	0,194	-0,038	0,078
150	220	0,133	0,019	0,076
150	230	0,067	0,120	0,094
150	230	0,037	0,153	0,095
150	240	0,021	0,167	0,094
150	250	-0,068	0,304	0,118
150	260	-0,189	0,410	0,111
150	270	-0,286	0,523	0,119
150	270	-0,363	0,585	0,111
150	280	-0,426	0,751	0,163
150	285	-0,462	0,877	0,208
150	290	-0,539	1,109	0,285
150	296	-0,751	1,351	0,300
150	300	-1,069	1,887	0,409
150	305	-1,148	2,175	0,514
150	309	-1,165	2,443	0,639
150	306	-1,266	2,041	0,388
150	288			
150	245			
150	198			
150	107			

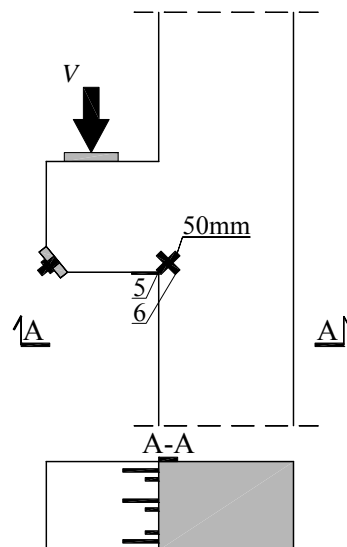
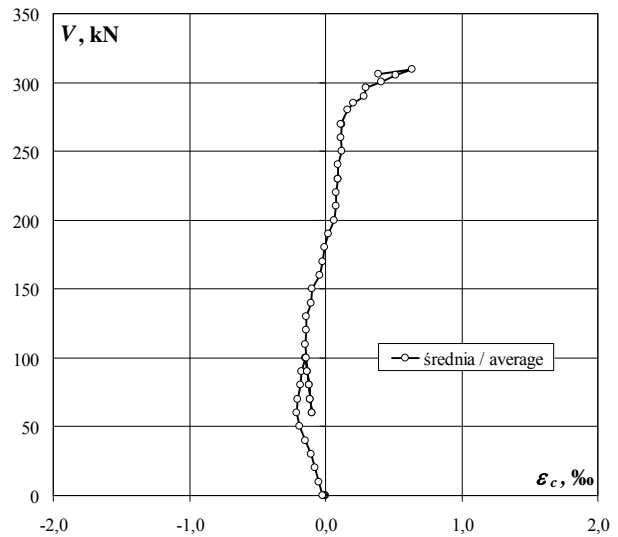
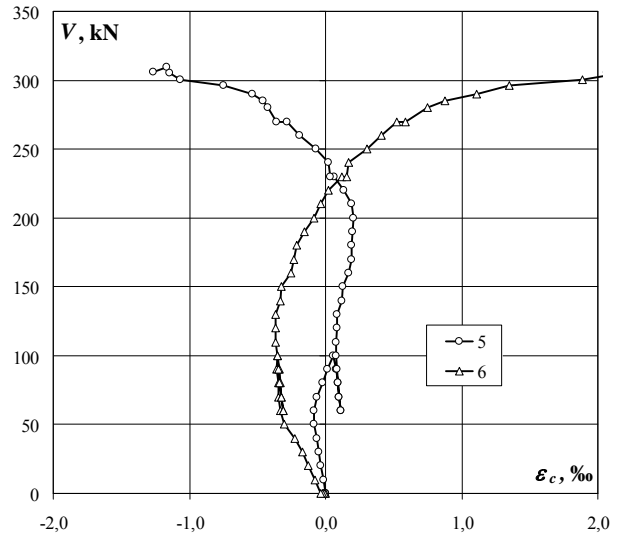

Na betonie – odkształcenia (ϵ_c) / On concrete surface – strains (ϵ_c)

obciążenie słupa column load	obciążenie wspornika corbel load	odkształcenie strain			
		7	8	9	średnia/ average
kN	kN	‰	‰	‰	‰
0	0	0,000	0,000	0,000	0,000
50	0	0,010	0,008	0,008	0,009
100	0	0,020	0,017	0,016	0,018
150	0	0,030	0,026	0,024	0,027
150	10	0,014	-0,005	0,017	0,009
150	20	-0,004	-0,035	0,010	-0,010
150	30	-0,025	-0,069	0,003	-0,030
150	40	-0,066	-0,133	-0,013	-0,071
150	50	-0,101	-0,200	-0,036	-0,112
150	60	-0,117	-0,227	-0,052	-0,132
150	70	-0,143	-0,249	-0,060	-0,151
150	80	-0,170	-0,270	-0,062	-0,167
150	90	-0,205	-0,301	-0,087	-0,198
150	100	-0,239	-0,331	-0,105	-0,225
150	90	-0,232	-0,320	-0,091	-0,214
150	80	-0,203	-0,290	-0,064	-0,186
150	70	-0,175	-0,258	-0,038	-0,157
150	60	-0,141	-0,216	-0,007	-0,121
150	60	-0,128	-0,203	0,005	-0,109
150	70	-0,159	-0,242	-0,026	-0,142
150	80	-0,184	-0,272	-0,050	-0,169
150	90	-0,212	-0,303	-0,076	-0,197
150	100	-0,240	-0,332	-0,102	-0,225
150	110	-0,270	-0,363	-0,126	-0,253
150	120	-0,300	-0,394	-0,150	-0,281
150	130	-0,339	-0,434	-0,181	-0,318
150	140	-0,407	-0,508	-0,245	-0,387
150	150	-0,433	-0,531	-0,259	-0,408
150	160	-0,561	-0,636	-0,363	-0,520
150	170	-0,662	-0,711	-0,422	-0,598
150	180	-0,761	-0,784	-0,480	-0,675
150	190	-0,861	-0,850	-0,521	-0,744
150	200	-0,975	-0,933	-0,599	-0,836
150	210	-1,104	-1,009	-0,658	-0,924
150	220	-1,281	-1,038	-0,718	-1,012
150	230	-1,450	-1,142	-0,836	-1,143
150	230	-1,518	-1,176	-0,879	-1,191
150	240	-1,576	-1,217	-0,922	-1,238
150	250	-1,814	-1,366	-1,068	-1,416
150	260	-2,027	-1,490	-1,212	-1,576
150	270	-2,211	-1,610	-1,342	-1,721
150	270	-2,287	-1,673	-1,398	-1,786
150	280	-2,442	-1,802	-1,513	-1,919
150	285	-2,528	-1,884	-1,581	-1,998
150	290	-2,671	-1,978	-1,719	-2,123
150	296	-2,793	-2,052	-1,825	-2,223
150	300	-3,183	-2,123	-2,039	-2,448
150	305	-3,365	-2,200	-2,141	-2,569
150	309	-3,351	-2,289	-2,223	-2,621
150	306	-2,209		-1,928	-2,069
150	288	-2,136		-1,867	-2,002
150	245	-2,166		-1,615	-1,891
150	198	-2,150		-1,330	-1,740
150	107	-2,140		-1,144	-1,642

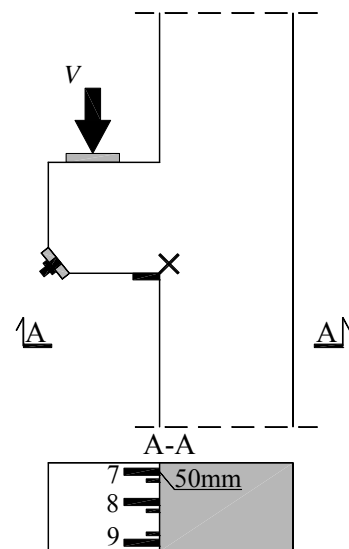
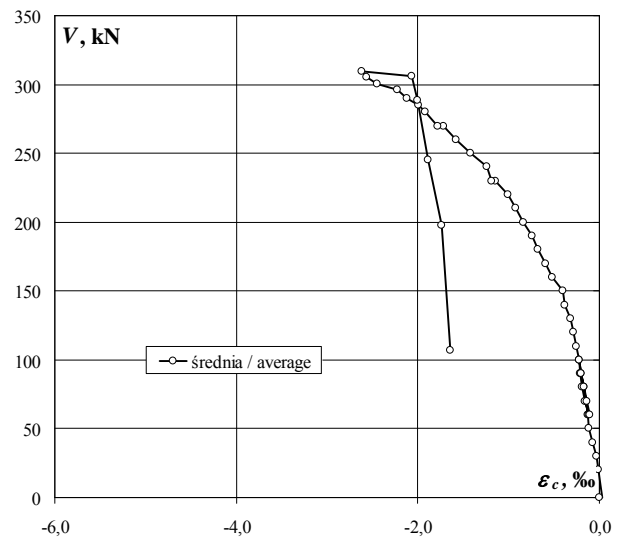
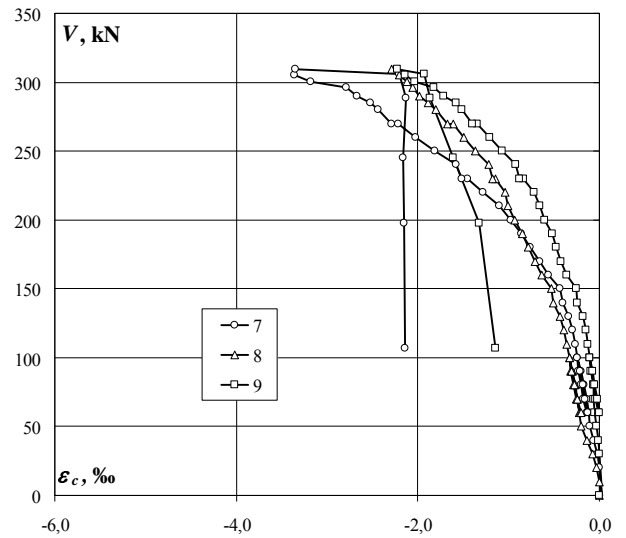

C-II

Na betonie – odkształcenia (ϵ_c) / On concrete surface – strains (ϵ_c)

obciążenie słupa column load	obciążenie wspornika corbel load	odkształcenie strain			
		10	11	12	średnia/ average
kN	kN	‰	‰	‰	‰
0	0	0,000	0,000	0,000	0,000
50	0	0,007	-0,005	-0,008	-0,002
100	0	0,018	-0,004	-0,011	0,001
150	0	0,029	-0,005	-0,009	0,005
150	10	-0,027	-0,121	-0,066	-0,071
150	20	-0,085	-0,215	-0,090	-0,130
150	30	-0,152	-0,307	-0,121	-0,193
150	40	-0,247	-0,421	-0,170	-0,279
150	50	-0,369	-0,589	-0,251	-0,403
150	60	-0,431	-0,665	-0,302	-0,466
150	70	-0,509	-0,742	-0,360	-0,537
150	80	-0,588	-0,827	-0,400	-0,605
150	90	-0,670	-0,879	-0,429	-0,659
150	100	-0,773	-0,954	-0,494	-0,740
150	90	-0,766	-0,926	-0,481	-0,724
150	80	-0,710	-0,863	-0,442	-0,672
150	70	-0,653	-0,798	-0,407	-0,619
150	60	-0,583	-0,719	-0,361	-0,554
150	60	-0,554	-1,231	-0,490	-0,758
150	70	-0,616	-1,298	-0,547	-0,820
150	80	-0,668	-1,353	-0,623	-0,881
150	90	-0,723	-1,408	-0,679	-0,937
150	100	-0,782	-1,458	-0,702	-0,981
150	110	-0,850	-1,512	-0,757	-1,040
150	120	-0,933	-1,570	-0,846	-1,116
150	130	-1,031	-1,719	-0,919	-1,223
150	140	-1,213	-1,818	-1,044	-1,358
150	150	-1,264	-1,843	-1,058	-1,388
150	160	-1,505	-2,052	-1,240	-1,599
150	170	-1,676	-2,156	-1,346	-1,726
150	180	-1,836	-2,264	-1,381	-1,827
150	190	-2,007	-2,339	-1,429	-1,925
150	200	-2,214	-2,484	-1,563	-2,087
150	210	-2,410	-2,616	-1,631	-2,219
150	220	-2,929	-2,845	-1,772	-2,515
150	230	-3,270	-3,024	-1,949	-2,748
150	230	-3,405	-3,059	-1,934	-2,799
150	240	-3,499	-3,125	-1,960	-2,861
150	250	-3,952	-3,369	-2,107	-3,143
150	260	-4,372	-3,505	-2,214	-3,364
150	270	-4,732	-3,517	-2,309	-3,519
150	270	-4,905	-3,302	-2,314	-3,507
150	280	-5,121	-3,237	-2,225	-3,528
150	285	-5,235	-3,057	-2,162	-3,485
150	290	-5,312	-2,974	-2,058	-3,448
150	296	-4,980	-2,588	-1,807	-3,125
150	300		-2,522	-1,342	-1,932
150	305		-2,616	-1,177	-1,897
150	309		-2,833	-1,088	-1,961
150	306		-2,447	-1,131	-1,789
150	288		-1,746	-1,989	-1,868
150	245		-0,557		-0,557
150	198		-1,090		-1,090
150	107		-1,125		-1,125

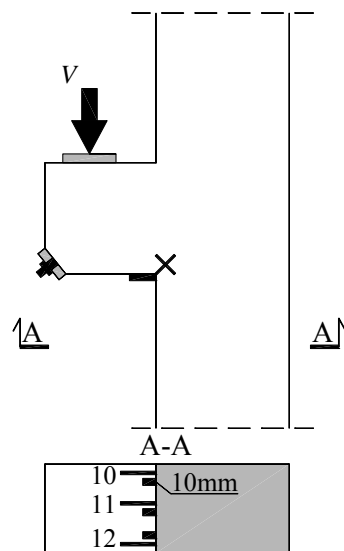
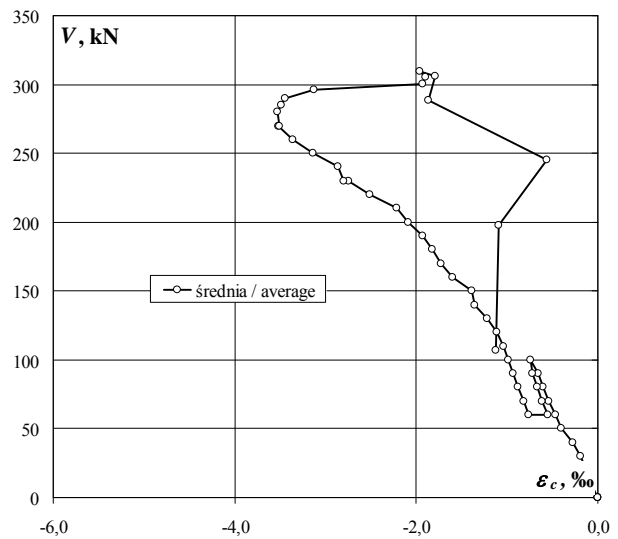
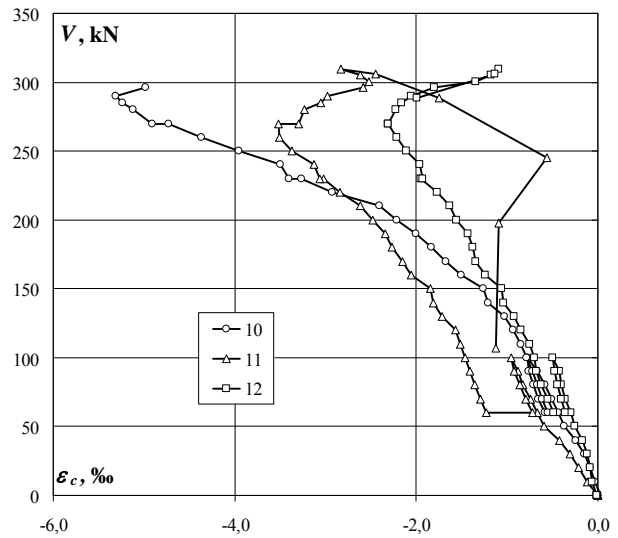



Wspornik po zniszczeniu w stanowisku badawczym / Corbel after failure in test setup

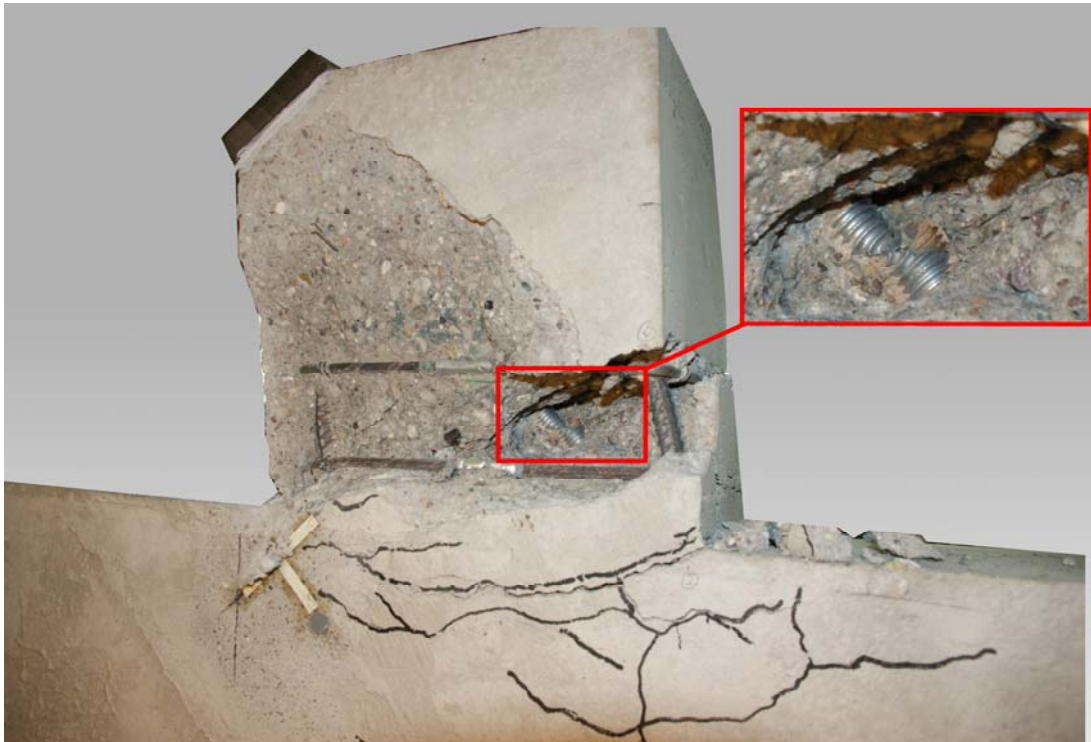

Pręty gwintowany zerwany podczas badania / Threaded rod was ruptured during test

C-II

Szerokość rozwarcia rys / Crack width

obciążenie słupa column load	obciążenie wspornika corbel load	Numer rysy Crack number					
		1	2	3	4	5	6
kN	kN	mm	mm	mm	mm	mm	mm
150	40	0,05					
150	50	0,05					
150	60	0,15	0,10				
150	70	0,15	0,10				
150	80	0,15	0,15				
150	90	0,15	0,15				
150	100	0,20	0,25				
150	90	0,20	0,25				
150	80	0,17	0,22				
150	70	0,17	0,20				
150	60	0,15	0,17				
150	70	0,17	0,20				
150	80	0,20	0,22				
150	90	0,22	0,25				
150	100	0,22	0,25				
150	110	0,25	0,27				
150	120	0,27	0,30				
150	130	0,27	0,30				
150	140	0,35	0,43				
150	150	0,43	0,45				
150	160	0,45	0,47				
150	170	0,52	0,55	0,05			
150	180	0,55	0,57	0,10	0,10		
150	190	0,60	0,57	0,10	0,10		
150	200	0,70	0,70	0,10	0,15		
150	210	0,80	0,80	0,10	0,20		
150	220	0,90	0,80	0,10	0,40		
150	230	1,20	1,10	0,10	0,55		
150	240	1,40	1,20	0,10	0,60		
150	250	1,60	1,40	0,10	0,60		
150	260	1,70	1,60	0,20	0,70		
150	270	1,70	1,80	0,25	0,80		
150	280	1,80	1,60	0,30	0,80		
150	290	2,00	2,00	0,50	1,70		
150	300	2,50	2,50	0,85	2,10		

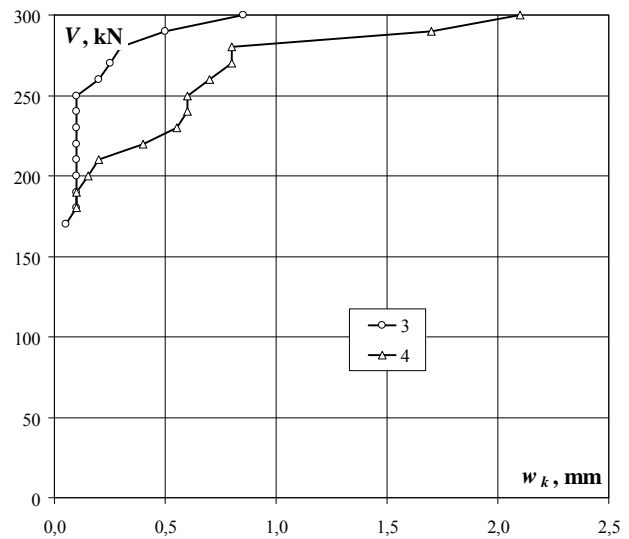
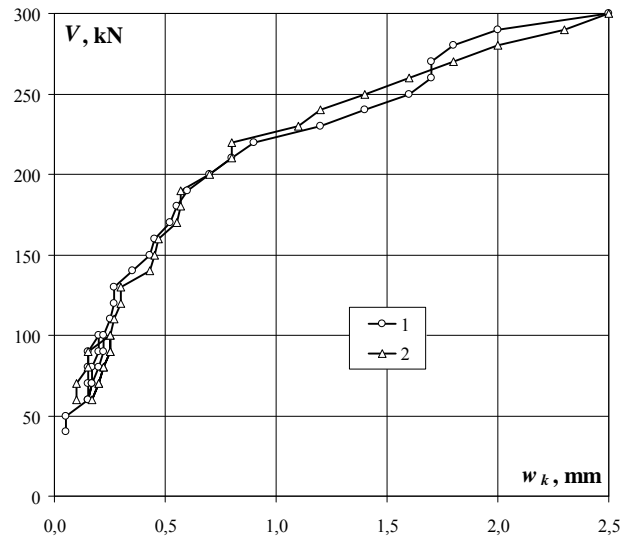

Układ rys przy sile 100kN / Crack pattern at 100kN

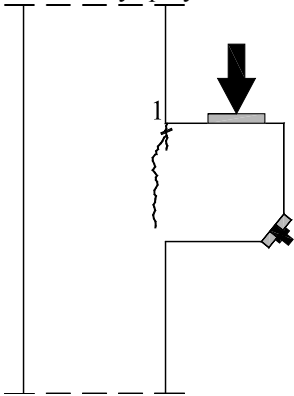

Układ rys przy sile 150kN / Crack pattern at 150kN

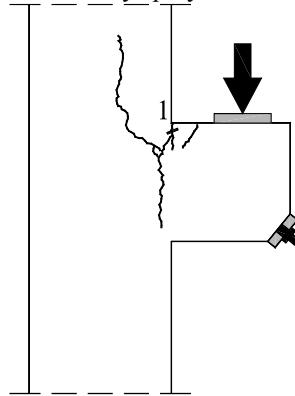

Układ rys przy sile 220kN / Crack pattern at 220kN

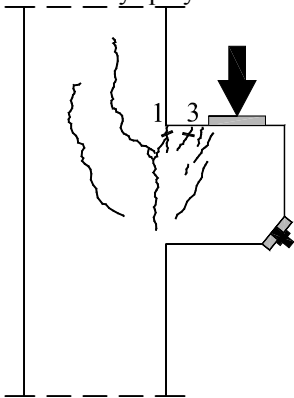

Układ rys przy sile 260kN / Crack pattern at 260kN

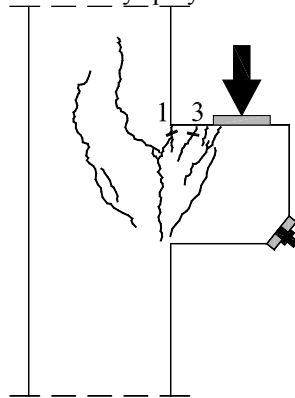

Układ rys przy sile 290kN / Crack pattern at 290kN

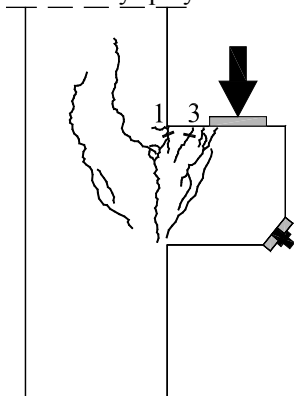

Układ rys przy sile 310kN / Crack pattern at 310kN

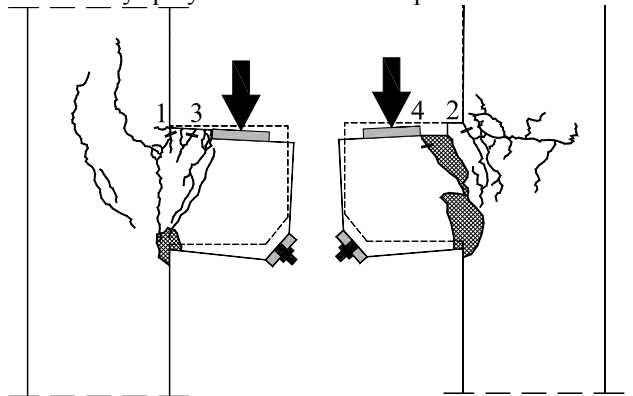

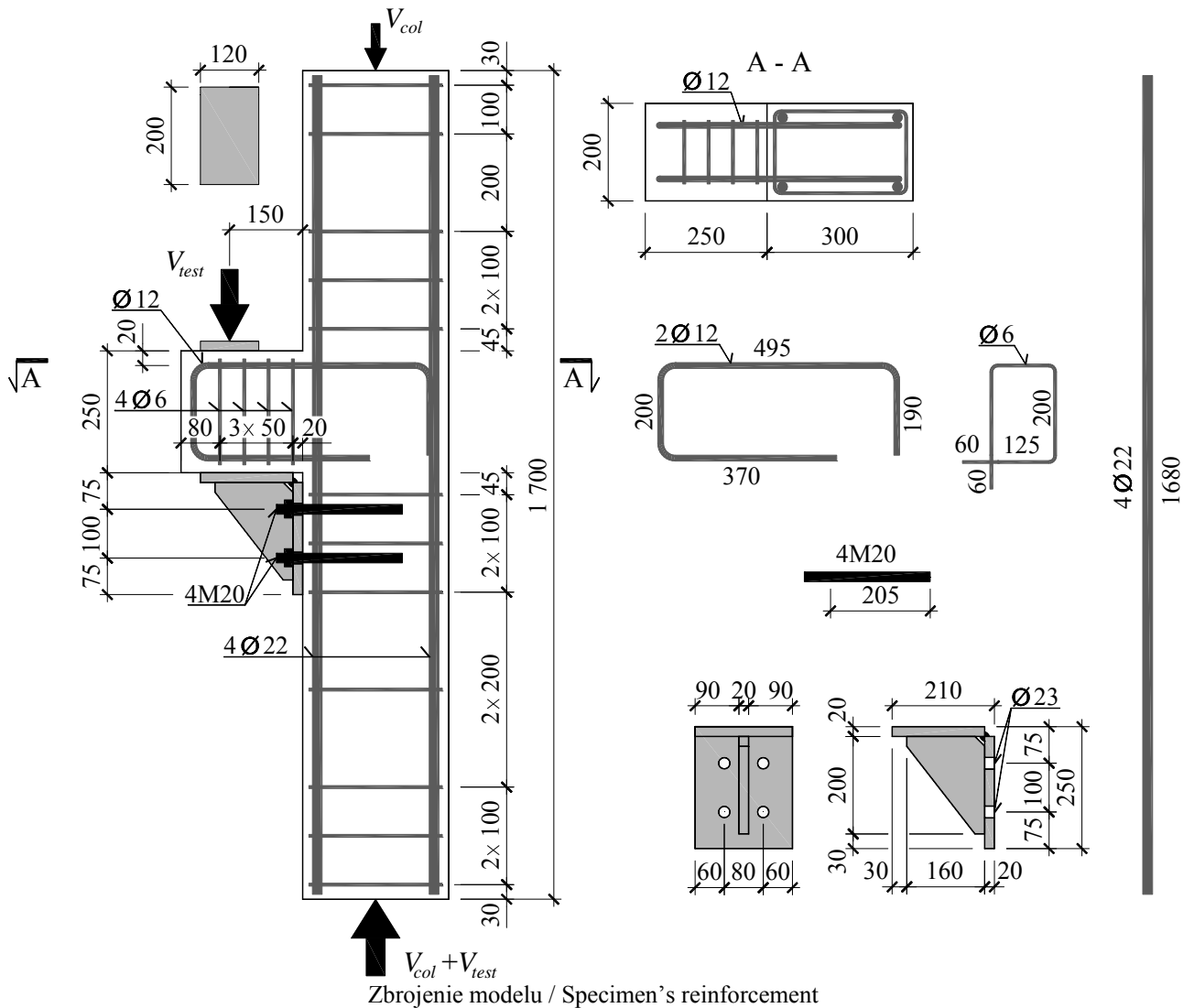

Wytrzymałość betonu na ściskanie / Compressive strength of concrete

$$f_{cm} = 35,0 \text{ MPa}$$

Moduł sprężystości podłużnej / Young's modulus

$$E_{cm} = 25,0 \text{ GPa}$$

Wytrzymałość betonu na rozciąganie przy rozłupywaniu / Tensile splitting strength of concrete

$$f_{ct,sp} = 3,1 \text{ MPa}$$

Gęstość betonu / Density of concrete

$$\rho = 2200 \text{ kg/m}^3$$

Charakterystyka zbrojenia / Characteristics of the reinforcement

Ø6

$$A_s = 28,27 \text{ mm}^2, f_{ym} = 449,8 \text{ MPa}, f_{tm} = 517,4 \text{ MPa}$$

Ø12

$$A_s = 113,86 \text{ mm}^2, f_{ym} = 409,9 \text{ MPa}, f_{tm} = 636,0 \text{ MPa}$$

Ø22

$$A_s = 392,71 \text{ mm}^2, f_{ym} = 547,3 \text{ MPa}, f_{tm} = 628,6 \text{ MPa}$$

M20

$$A_s = - \text{ mm}^2, f_{ym} = - \text{ MPa}, f_{tm} = - \text{ MPa}$$

Siła maksymalna / Maximum force

$$V_{test} = 477 \text{ kN}$$

C-III

Zbrojenie główne – odkształcenia (ε_s) / Main reinforcement – strains (ε_s)

obciążenie słupa column load	obciążenie wspornika corbel load	odkształcenie strain		
		1	2	średnia/ average
kN	kN	‰	‰	‰
0	0	0,000	0,000	0,000
50	0	0,012	0,000	0,006
100	0	0,015	-0,002	0,007
150	0	0,010	-0,002	0,004
150	10	0,038	0,030	0,034
150	20	0,082	0,087	0,085
150	30	0,159	0,265	0,212
150	40	0,526	0,654	0,590
150	50	0,802	0,909	0,856
150	60	1,130	1,199	1,165
150	70	1,389	1,441	1,415
150	80	1,584	1,669	1,627
150	90	1,621	1,956	1,789
150	100	1,613	2,245	1,929
150	90	1,460	2,202	1,831
150	80	1,293	2,000	1,647
150	70	1,158	1,819	1,489
150	60	0,962	1,548	1,255
150	60	0,953	1,535	1,244
150	60	0,954	1,536	1,245
150	60	0,957	1,540	1,249
150	60	0,957	1,545	1,251
150	60	0,963	1,545	1,254
150	60	0,962	1,547	1,255
150	60	0,965	1,547	1,256
150	60	0,957	1,548	1,253
150	60	0,952	1,548	1,250
150	60	0,948	1,544	1,246
150	60	0,934	1,537	1,236
150	60	0,928	1,536	1,232
150	60	0,928	1,536	1,232
150	60	0,932	1,546	1,239
150	70	0,984	1,623	1,304
150	80	1,052	1,724	1,388
150	80	1,038	1,713	1,376
150	90	1,106	1,803	1,455
150	100	1,168	1,896	1,532
150	110	1,231	1,995	1,613
150	110	1,202	2,003	1,603
150	120	1,233	2,050	1,642
150	130	1,299	2,145	1,722
150	130	1,298	2,146	1,722
150	140	1,355	2,241	1,798
150	150	1,415	2,337	1,876
150	160	1,490	2,456	1,973
150	170	1,579	2,606	2,093
150	180	1,615	3,019	2,317
150	190	1,488	8,041	4,765
150	200	1,490	9,032	5,261
150	210	1,479	10,337	5,908
150	220	1,693	10,585	6,139
150	230	2,108	10,906	6,507
150	240	2,062	11,840	6,951
150	250	1,799	11,980	6,890
150	250	1,550	12,930	7,240
150	260	1,335	13,541	7,438
150	270	0,934	14,181	7,558
150	280	0,621	14,586	7,604
150	290	0,489	14,876	7,683
150	300	0,426	15,166	7,796

obciążenie słupa column load	obciążenie wspornika corbel load	odkształcenie strain		
		1	2	średnia/ average
kN	kN	‰	‰	‰
150	310	0,402	15,472	7,937
150	320	0,405	15,842	8,124
150	330	0,410	16,122	8,266
150	340	0,417	16,062	8,240
150	350	0,403	15,859	8,131
150	360	0,410	16,159	8,285
150	370	0,416	14,090	7,253
150	380	0,417		0,417
150	390	0,372		0,372
150	400	0,358		0,358
150	405	0,318		0,318
150	410	0,313		0,313
150	414	0,319		0,319
150	419	0,329		0,329
150	425	0,336		0,336
150	430	0,346		0,346
150	435	0,370		0,370
150	440	0,374		0,374
150	445	0,399		0,399
150	451	0,396		0,396
150	455	0,389		0,389
150	460	0,395		0,395
150	465	0,404		0,404
150	471	0,441		0,441
150	477	0,481		0,481
150	450	0,469		0,469
150	402	0,415		0,415
150	392	0,395		0,395

Zbrojenie główne – odkształcenia (ϵ_s) / Main reinforcement – strains (ϵ_s)

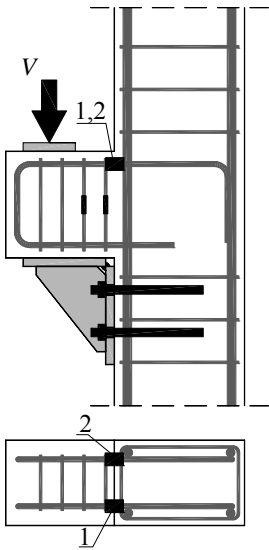
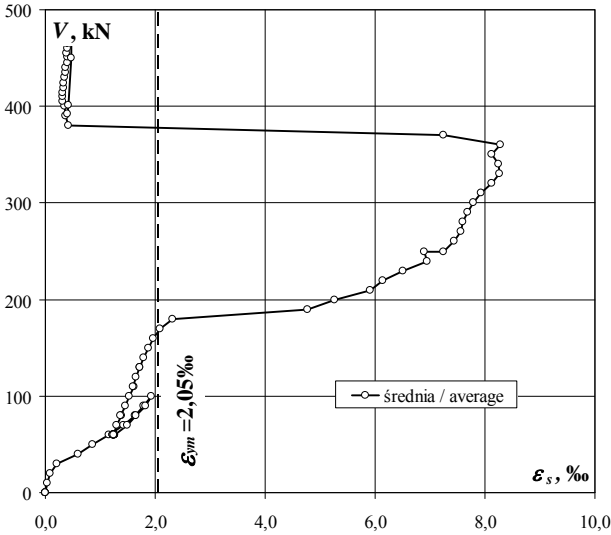
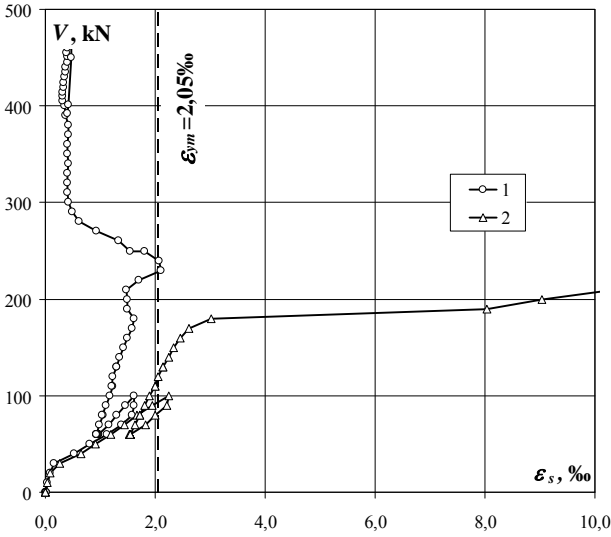

C-III

Strzemiona – odkształcenia (ε_s) / Stirrup – strains (ε_s)

obciążenie słupa column load	obciążenie wspornika corbel load	odkształcenie strain		
		3	4	średnia/ average
kN	kN	‰	‰	‰
0	0	0,000		0,000
50	0	-0,004		-0,004
100	0	-0,011		-0,011
150	0	-0,018		-0,018
150	10	-0,020		-0,020
150	20	-0,021		-0,021
150	30	-0,033		-0,033
150	40	-0,047		-0,047
150	50	-0,057		-0,057
150	60	-0,071		-0,071
150	70	-0,081		-0,081
150	80	-0,086		-0,086
150	90	-0,063		-0,063
150	100	0,028		0,028
150	90	0,038		0,038
150	80	0,048		0,048
150	70	0,059		0,059
150	60	0,076		0,076
150	60	0,074		0,074
150	60	0,072		0,072
150	60	0,072		0,072
150	60	0,072		0,072
150	60	0,070		0,070
150	60	0,070		0,070
150	60	0,068		0,068
150	60	0,069		0,069
150	60	0,069		0,069
150	60	0,070		0,070
150	60	0,068		0,068
150	60	0,069		0,069
150	60	0,069		0,069
150	60	0,067		0,067
150	70	0,064		0,064
150	80	0,059		0,059
150	80	0,059		0,059
150	90	0,054		0,054
150	100	0,048		0,048
150	110	0,044		0,044
150	110	0,034		0,034
150	120	0,032		0,032
150	130	0,028		0,028
150	130	0,028		0,028
150	140	0,032		0,032
150	150	0,030		0,030
150	160	0,051		0,051
150	170	0,058		0,058
150	180	0,088		0,088
150	190	0,099		0,099
150	200	0,097		0,097
150	210	0,101		0,101
150	220	0,101		0,101
150	230	0,105		0,105
150	240	0,108		0,108
150	250	0,109		0,109
150	250	0,116		0,116
150	260	0,121		0,121
150	270	0,139		0,139
150	280	0,141		0,141
150	290	0,138		0,138
150	300	0,133		0,133

obciążenie słupa column load	obciążenie wspornika corbel load	odkształcenie strain		
		3	4	średnia/ average
kN	kN	‰	‰	‰
150	310	0,135		150
150	320	0,150		150
150	330	0,157		150
150	340	0,156		150
150	350	0,155		150
150	360	0,151		150
150	370	0,147		150
150	380	0,148		150
150	390	0,142		150
150	400	0,135		150
150	405	0,126		150
150	410	0,123		150
150	414	0,127		150
150	419	0,126		150
150	425	0,136		150
150	430	0,135		150
150	435	0,174		150
150	440	0,171		150
150	445	0,178		150
150	451	0,119		150
150	455	-0,037		150
150	460	-0,034		150
150	465	-0,064		150
150	471	-1,923		150
150	477	-2,070		150
150	450	-2,187		150
150	402	-2,143		150
150	392	-2,124		150

Strzemiona – odkształcenia (ϵ_s) / Stirrup – strains (ϵ_s)

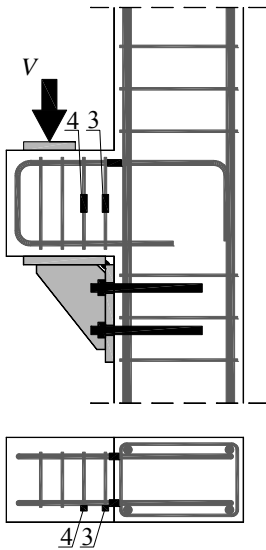
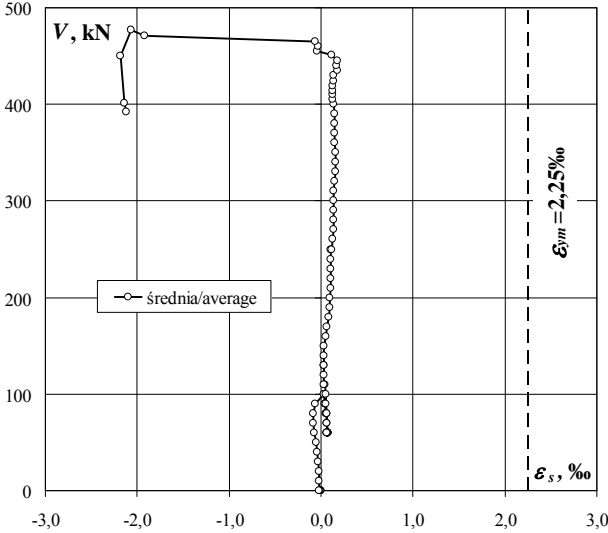
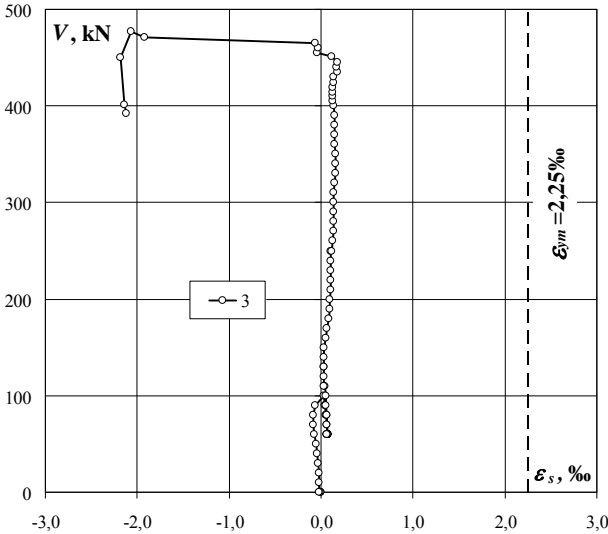

C-III

Na betonie – odkształcenia (ε_c) / On concrete surface – strains (ε_c)

obciążenie słupa column load	obciążenie wspornika corbel load	odkształcenie strain		
		5	6	średnia/ average
kN	kN	‰	‰	‰
0	0	0,000	0,000	0,000
50	0	-0,004	-0,019	-0,012
100	0	-0,022	-0,045	-0,034
150	0	-0,040	-0,067	-0,054
150	10	-0,059	-0,126	-0,093
150	20	-0,078	-0,189	-0,134
150	30	-0,115	-0,213	-0,164
150	40	-0,117	-0,305	-0,211
150	50	-0,126	-0,408	-0,267
150	60	-0,132	-0,410	-0,271
150	70	-0,111	-0,427	-0,269
150	80	-0,019	-0,434	-0,227
150	90	0,004	-0,436	-0,216
150	100	0,031	-0,438	-0,204
150	90	0,111	-0,423	-0,156
150	80	0,119	-0,409	-0,145
150	70	0,124	-0,401	-0,139
150	60	0,126	-0,390	-0,132
150	60	0,135	-0,431	-0,148
150	60	0,153	-0,438	-0,143
150	60	0,199	-0,448	-0,125
150	60	0,212	-0,447	-0,118
150	60	0,224	-0,452	-0,114
150	60	0,236	-0,456	-0,110
150	60	0,241	-0,462	-0,111
150	60	0,249	-0,457	-0,104
150	60	0,250	-0,456	-0,103
150	60	0,254	-0,452	-0,099
150	60	0,253	-0,432	-0,090
150	60	0,253	-0,485	-0,116
150	60	0,260	-0,470	-0,105
150	60	0,277	-0,463	-0,093
150	70	0,290	-0,463	-0,087
150	80	0,302	-0,459	-0,079
150	80	0,292	-0,460	-0,084
150	90	0,313	-0,455	-0,071
150	100	0,330	-0,450	-0,060
150	110	0,361	-0,444	-0,042
150	110	0,398	-0,464	-0,033
150	120	0,421	-0,457	-0,018
150	130	0,441	-0,448	-0,004
150	130	0,458	-0,450	0,004
150	140	0,524	-0,443	0,041
150	150	0,585	-0,433	0,076
150	160	0,715	-0,423	0,146
150	170	0,821	-0,409	0,206
150	180	0,979	-0,381	0,299
150	190	1,299	-0,292	0,504
150	200	1,452	-0,210	0,621
150	210	1,747	-0,091	0,828
150	220	1,929	-0,017	0,956
150	230	2,206	0,097	1,152
150	240	2,455	0,196	1,326
150	250	2,581	0,204	1,393
150	250		0,342	0,342
150	260		0,437	0,437
150	270		0,605	0,605
150	280		0,478	0,478
150	290		0,565	0,565
150	300		0,680	0,680

obciążenie słupa column load	obciążenie wspornika corbel load	odkształcenie strain		
		5	6	średnia/ average
kN	kN	‰	‰	‰
150	310		0,825	0,825
150	320		0,993	0,993
150	330		1,132	1,132
150	340		1,286	1,286
150	350		1,475	1,475
150	360		1,680	1,680
150	370		1,893	1,893
150	380		2,164	2,164
150	390			
150	400			
150	405			
150	410			
150	414			
150	419			
150	425			
150	430			
150	435			
150	440			
150	445			
150	451			
150	455			
150	460			
150	465			
150	471			
150	477			
150	450			
150	402			
150	392			

Na betonie – odkształcenia (ϵ_c) / On concrete surface – strains (ϵ_c)

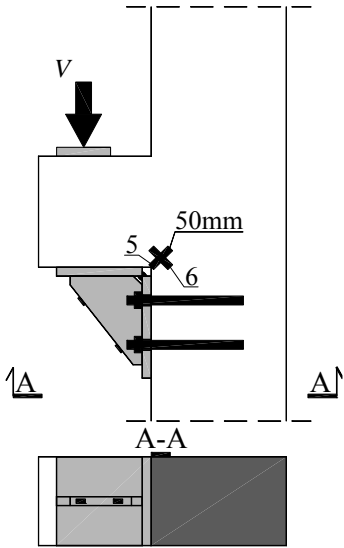
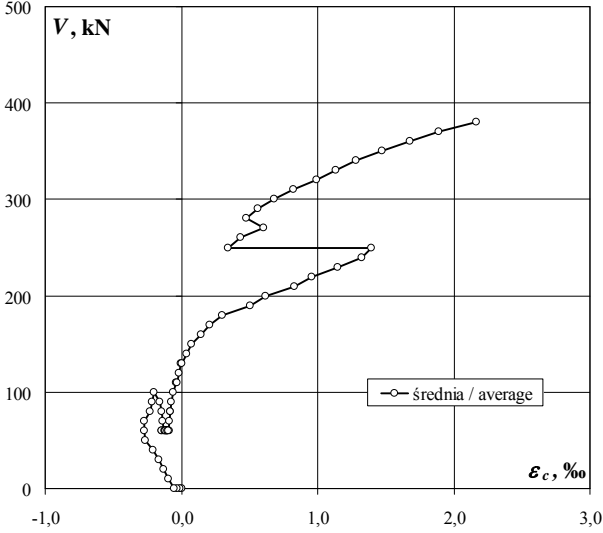
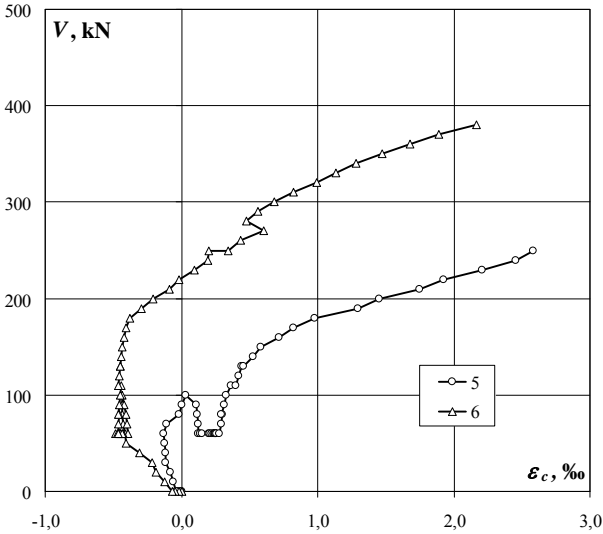

C-III

Na betonie – odkształcenia (ε_c) / On concrete surface – strains (ε_c)

obciążenie słupa column load	obciążenie wspornika corbel load	odkształcenie strain		
		7	8	średnia/ average
kN	kN	‰	‰	‰
0	0	0,000	0,000	0,000
50	0	0,001	0,000	0,001
100	0	0,000	0,004	0,002
150	0	-0,001	0,005	0,002
150	10	0,000	0,001	0,001
150	20	0,000	0,000	0,000
150	30	0,000	0,000	0,000
150	40	0,001	0,000	0,001
150	50	0,000	-0,001	-0,001
150	60	0,000	0,002	0,001
150	70	-0,001	0,001	0,000
150	80	-0,004	0,004	0,000
150	90	-0,003	0,000	-0,002
150	100	-0,004	0,000	-0,002
150	90	-0,004	0,000	-0,002
150	80	-0,005	-0,001	-0,003
150	70	-0,005	-0,002	-0,004
150	60	-0,005	0,000	-0,003
150	60	-0,159	-0,160	-0,160
150	60	-0,180	-0,184	-0,182
150	60	-0,176	-0,191	-0,184
150	60	-0,157	-0,177	-0,167
150	60	-0,136	-0,153	-0,145
150	60	-0,126	-0,129	-0,128
150	60	-0,111	-0,090	-0,101
150	60	-0,100	-0,085	-0,093
150	60	-0,092	-0,078	-0,085
150	60	-0,084	-0,068	-0,076
150	60	-0,090	0,082	-0,004
150	60	-0,086	0,163	0,039
150	60	-0,086	0,202	0,058
150	60	-0,075	0,360	0,143
150	70	-0,093	0,166	0,037
150	80	-0,112	0,119	0,004
150	80	-0,109	0,122	0,007
150	90	-0,126	0,105	-0,011
150	100	-0,145	0,090	-0,028
150	110	-0,161	0,080	-0,041
150	110	-0,163	0,092	-0,036
150	120	-0,172	0,088	-0,042
150	130	-0,192	0,075	-0,059
150	130	-0,191	0,072	-0,060
150	140	-0,211	0,040	-0,086
150	150	-0,232	0,022	-0,105
150	160	-0,251	-0,031	-0,141
150	170	-0,277	-0,069	-0,173
150	180	-0,308	-0,098	-0,203
150	190	-0,345	-0,147	-0,246
150	200	-0,376	-0,177	-0,277
150	210	-0,415	-0,220	-0,318
150	220	-0,447	-0,251	-0,349
150	230	-0,486	-0,287	-0,387
150	240	-0,514	-0,320	-0,417
150	250	-0,520	-0,320	-0,420
150	250	-0,554	-0,358	-0,456
150	260	-0,583	-0,391	-0,487
150	270	-0,620	-0,435	-0,528
150	280	-0,656	-0,482	-0,569
150	290	-0,695	-0,518	-0,607
150	300	-0,735	-0,557	-0,646

obciążenie słupa column load	obciążenie wspornika corbel load	odkształcenie strain		
		7	8	średnia/ average
kN	kN	‰	‰	‰
150	310	-0,777	-0,597	-0,687
150	320	-0,821	-0,634	-0,728
150	330	-0,865	-0,673	-0,769
150	340	-0,905	-0,707	-0,806
150	350	-0,948	-0,755	-0,852
150	360	-0,991	-0,798	-0,895
150	370	-1,033	-0,850	-0,942
150	380	-1,085	-0,904	-0,995
150	390	-1,098	-0,951	-1,025
150	400	-1,139	-0,972	-1,056
150	405	-1,186	-1,005	-1,096
150	410	-1,197	-1,012	-1,105
150	414	-1,225	-1,014	-1,120
150	419	-1,239	-1,028	-1,134
150	425	-1,264	-1,018	-1,141
150	430	-1,277	-1,031	-1,154
150	435	-1,296	-1,036	-1,166
150	440	-1,306	-1,047	-1,177
150	445	-1,329	-1,070	-1,200
150	451	-1,333	-1,207	-1,270
150	455	-1,364	-1,211	-1,288
150	460	-1,374	-1,222	-1,298
150	465	-1,392	-1,242	-1,317
150	471	-1,393	-1,246	-1,320
150	477	-1,435	-1,274	-1,355
150	450	-1,444	-1,225	-1,335
150	402	-1,344	-1,120	-1,232
150	392	-1,318	-1,124	-1,221

Na betonie – odkształcenia (ϵ_c) / On concrete surface – strains (ϵ_c)

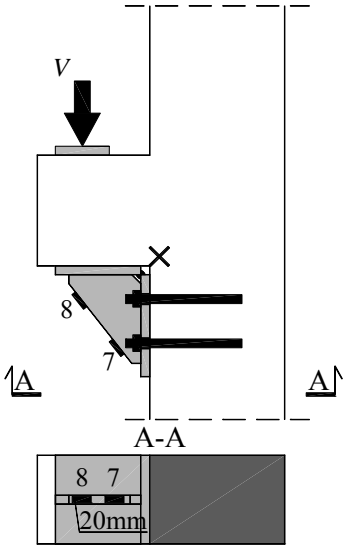
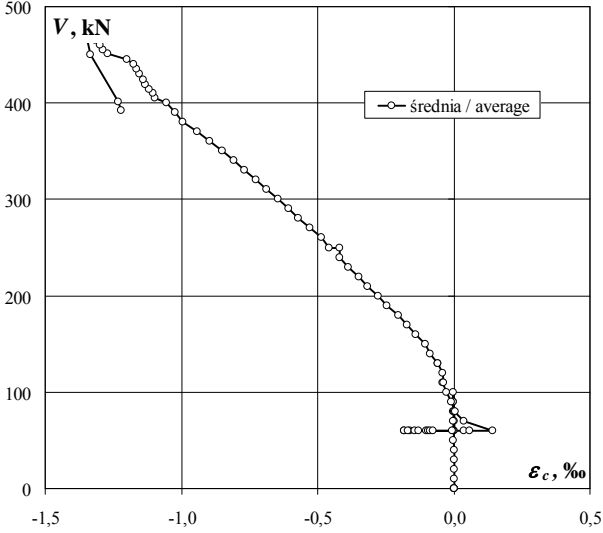
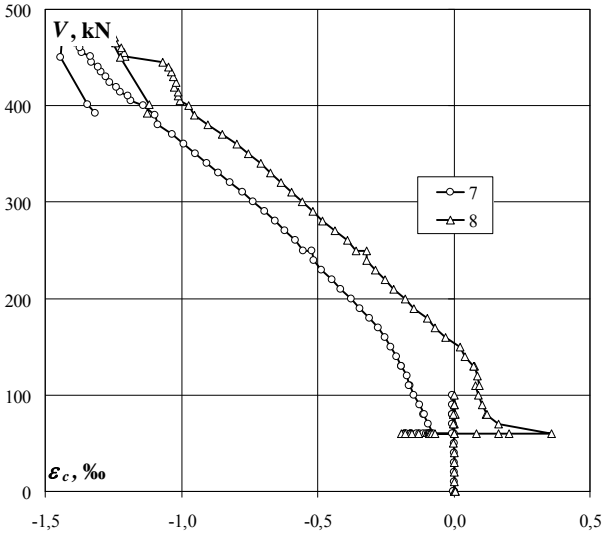

C-III

Szerokość rozwarcia rys / Crack width

obciążenie słupa column load	obciążenie wspornika corbel load	Numer rysy Crack number					
		1	2	3	4	5	6
kN	kN	mm	mm	mm	mm	mm	mm
150	50	0,07	0,10				
150	60	0,10	0,10				
150	70	0,12	0,15				
150	80	0,15	0,20				
150	90	0,20	0,25	0,02			
150	100	0,25	0,25	0,01			
150	90	0,20	0,25	0,10			
150	80	0,17	0,20	0,05			
150	70	0,15	0,20	0,05			
150	60	0,10	0,15	0,02			
150	70	0,15	0,20	0,05			
150	80	0,15	0,25	0,10			
150	90	0,15	0,25	0,15			
150	100	0,20	0,25	0,15	0,05		
150	110	0,22	0,25	0,15	0,05		
150	120	0,25	0,30	0,15	0,10		
150	130	0,25	0,30	0,15	0,10		
150	140	0,30	0,27	0,20	0,10		
150	150	0,30	0,30	0,20	0,10		
150	160	0,30	0,30	0,20	0,10		
150	170	0,30	0,33	0,20	0,10		
150	180	0,33	0,35	0,22	0,10		
150	190	0,35	0,38	0,22	0,10	0,20	
150	200	0,38	0,40	0,22	0,10	0,20	
150	210	0,40	0,43	0,22	0,10	0,20	
150	220	0,43	0,43	0,22	0,10	0,20	
150	230	0,45	0,45	0,22	0,10	0,20	
150	240	0,52	0,55	0,25	0,10	0,25	
150	250	0,55	0,60	0,25	0,10	0,25	
150	260	0,60	0,60	0,25	0,10	0,25	
150	270	0,63	0,65	0,25	0,10	0,25	
150	280	0,65	0,72	0,25	0,10	0,25	
150	290	0,70	0,75	0,25	0,10	0,30	
150	300	0,72	0,80	0,25	0,10	0,30	
150	310	0,75	0,80	0,25	0,10	0,30	
150	320	0,80	0,95	0,30	0,10	0,40	0,25
150	330	0,90	1,10	0,35	0,10	0,45	0,30
150	340	1,00	1,10	0,40	0,07	0,45	0,33
150	350	1,10	1,15	0,45	0,05	0,50	0,35
150	360	1,20	1,20	0,40	0,10	0,45	0,30
150	370	1,30	1,25	0,45	0,10	0,50	0,40
150	380	1,40	1,40	0,50	0,10	0,65	0,40
150	390	1,50		0,55	0,10		0,40
150	400	1,60		0,55	0,10		0,45

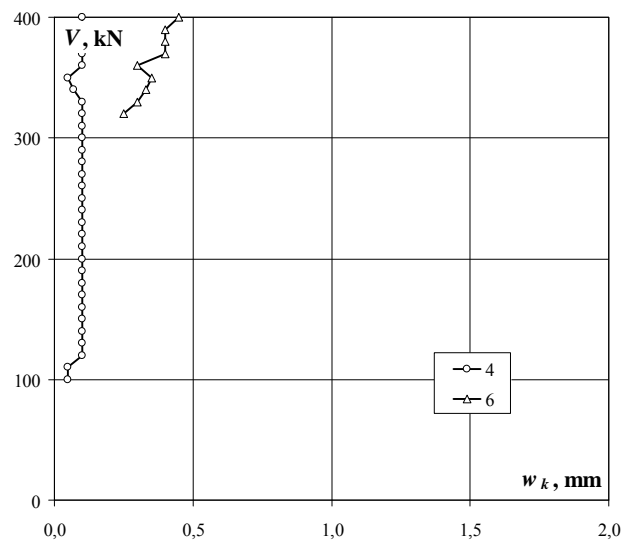
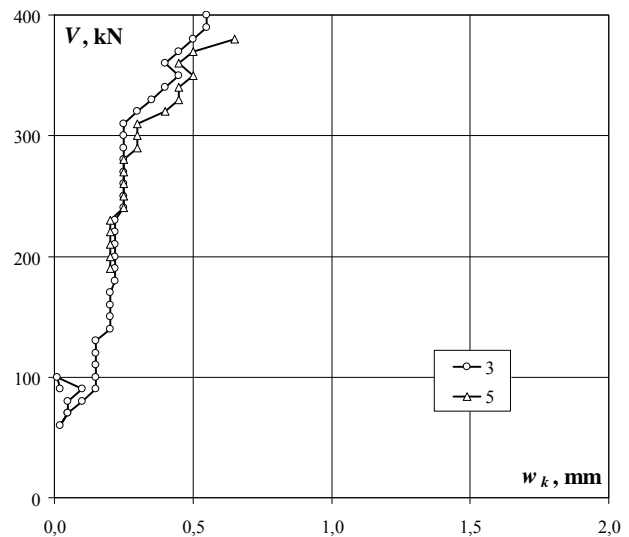
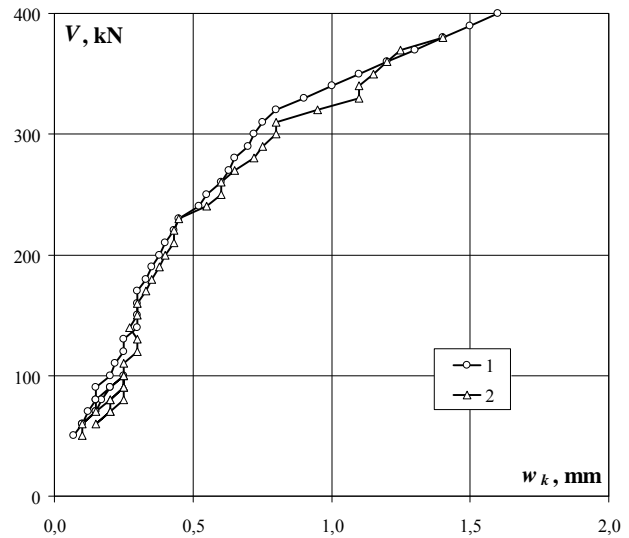

Układ rys przy sile 100kN / Crack pattern at 100kN

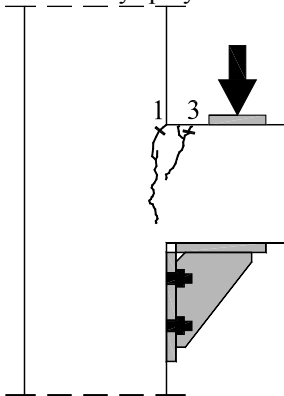

Układ rys przy sile 200kN / Crack pattern at 200kN

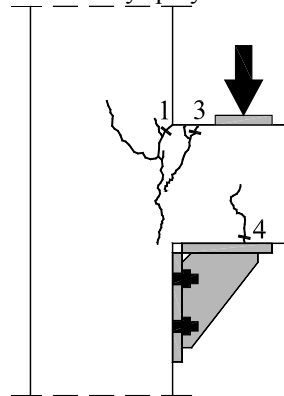

Układ rys przy sile 300kN / Crack pattern at 300kN

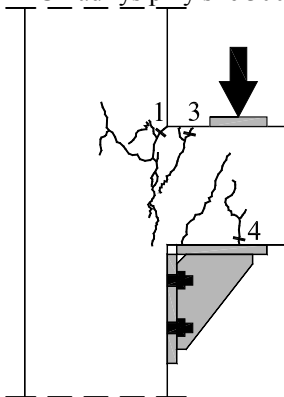

Układ rys przy sile 350kN / Crack pattern at 350kN

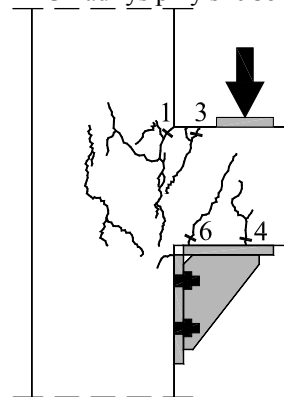

Układ rys przy sile 400kN / Crack pattern at 400kN

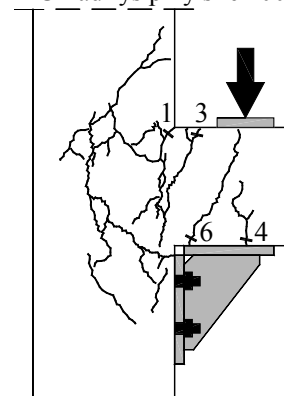

Układ rys przy sile 480kN / Crack pattern at 480kN

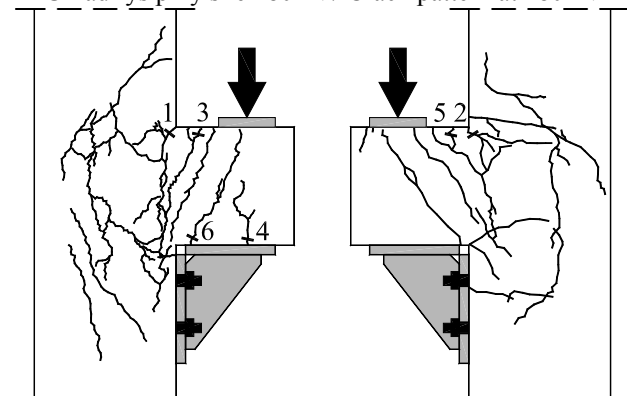

C-III



Wspornik po zniszczeniu w stanowisku badawczym / Corbel after failure in test setup



Poślizg pomiędzy stalowym akcesorium a powierzchnią betonu
Slip between steel accessory and concrete surface

Seria D
D Series

Wykres $\sigma - \varepsilon$ dla: / $\sigma - \varepsilon$ diagram for:

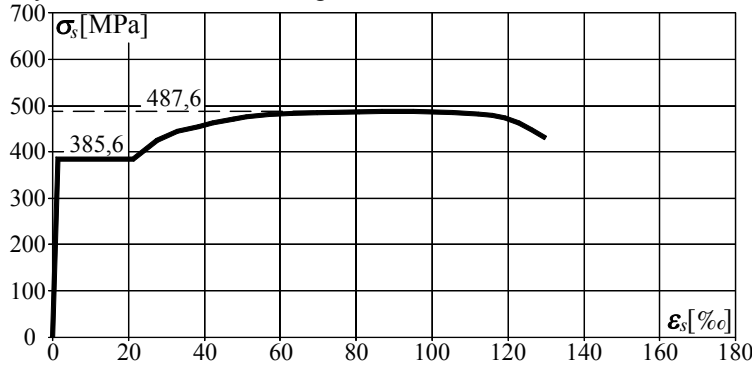

prętów zbrojeniowych Ø6 / reinforcement bars Ø6

Tabele $\sigma - \varepsilon$ dla: / $\sigma - \varepsilon$ table for:

ε_s	σ_s	ε_s	σ_s
%	MPa	%	MPa
0	0	70	487,6
1,928	385,6	80	487,6
21,2	385,6	90	458,4
30	434,9	100	476,9
40	458,4	110	482,6
50	474,6	120	471,4
60	482,6	130	430,2

prętów Ø6 / bars Ø6, $A_s=28,07\text{mm}^2$

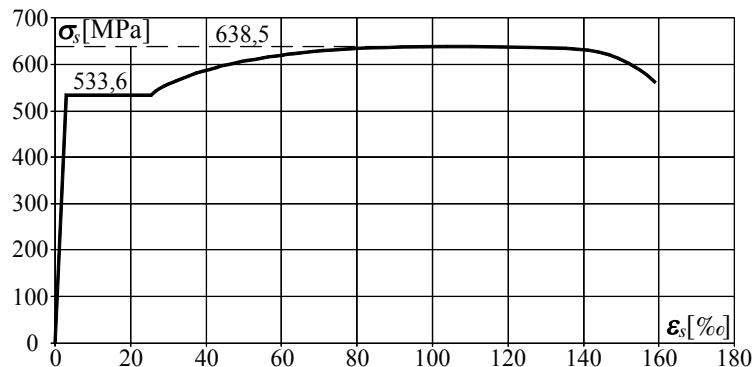

prętów zbrojeniowych Ø16 / reinforcement bars Ø16

ε_s	σ_s	ε_s	σ_s
%	MPa	%	MPa
0	0	80	634,5
2,668	533,6	90	638,5
25,4	533,6	120	638,5
30	585,2	130	635,7
40	587,5	140	631,5
50	607,2	150	610,7
60	620,2	159,1	561,5
70	628,9		

prętów Ø16 / bars Ø16, $A_s=200,53\text{mm}^2$

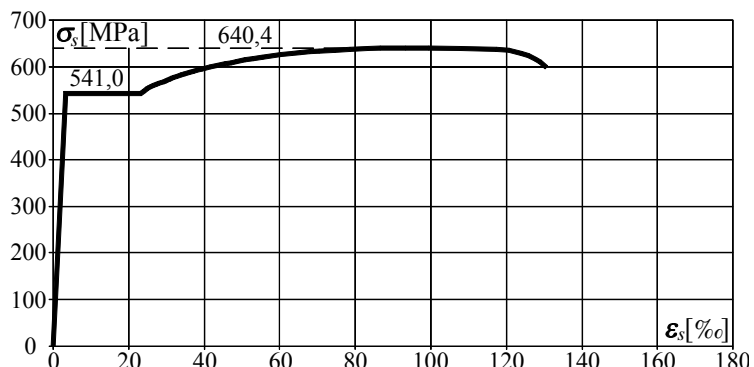

prętów zbrojeniowych Ø20 / reinforcement bars Ø20

ε_s	σ_s	ε_s	σ_s
%	MPa	%	MPa
0	0	70	633,4
2,705	541,0	80	638,0
23,1	541,0	90	640,4
30	571,2	100	640,4
40	596,9	110	639,0
50	613,4	120	634,7
60	626,1	130	600

prętów Ø20 / bars Ø20, $A_s=310,67\text{mm}^2$

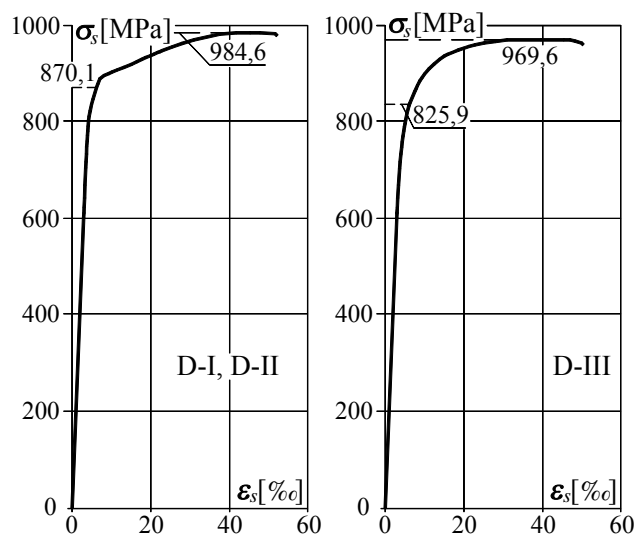

prętów gwintowanych M16 / threaded rods M16

ε_s	σ_s	ε_s	σ_s
%	MPa	%	MPa
0	0	9,963	900
2,958	600	23,41	950
3,426	700	41,65	984,6
4,197	800	51,48	982,7
6,250	870,1		

prętów M16 / rods M16 (D-I, D-II),
 $A_s=141,07\text{mm}^2$

ε_s	σ_s	ε_s	σ_s
%	MPa	%	MPa
0	0	10,38	900
2,958	600	19,42	950
3,664	700	30,92	969,6
5,166	800	49,84	963,1
6,162	825,9		

prętów M16 / rods M16 (D-III),
 $A_s=141,07\text{mm}^2$

Beton / Concrete

	f_{cm}	E_{cm}	$f_{ct,sp}$	ρ_c
	MPa	GPa	MPa	kg/m ³
średnia / average	45,14	27,21	3,73	2224
odchylenie standardowe / standard deviation	2,074	0,95	0,249	14,5
współczynnik zmienności / coefficient of variation	4,59%	3,49%	6,68%	0,65%
liczba próbek / number of specimens	15	14	15	30
minimalna wartość / minimum value	41,5	25,40	3,40	2200
maksymalna wartość / maximum value	48,3	29,00	4,20	2270

Rozwój wytrzymałości betonu w czasie / Development of the concrete strength in time

data / date	badany element / tested specimen	wiek / age	f_{cm}
		dni / days	MPa
2016-01-07	D-0	62	44,53
2016-01-11	D-I	66	42,57
2016-01-19	D-II	74	45,73
2016-01-26	D-III	81	45,83
2016-01-28	D-III	83	47,10
średnia / average			45,14
odchylenie standardowe / standard deviation			2,074
współczynnik zmienności / coefficient of variation			4,59%
liczba próbek / number of specimens			15
minimalna wartość / minimum value			41,5
maksymalna wartość / maximum value			48,3

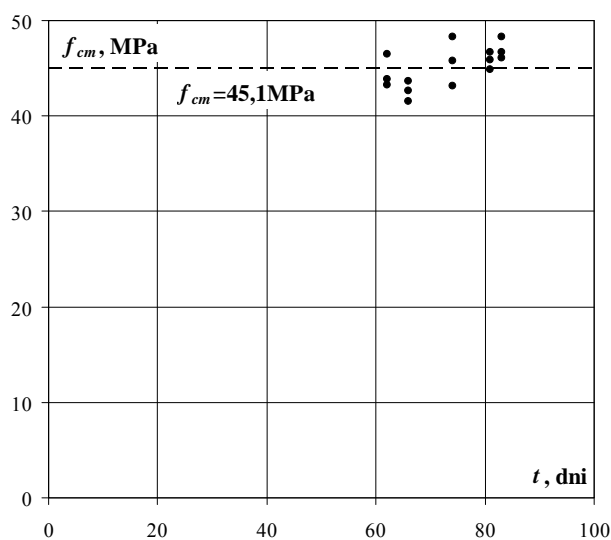

a)

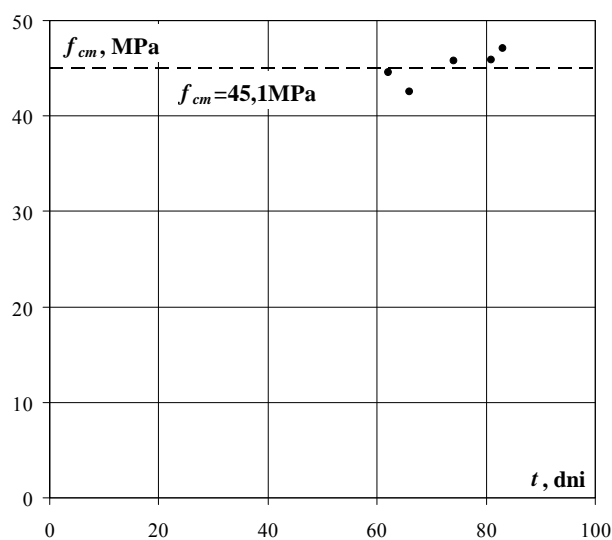

b)

Rozwój wytrzymałości betonu w czasie: a) wyniki badań, b) średnie dzienne
Development of the concrete strength in time: a) test results, b) daily average

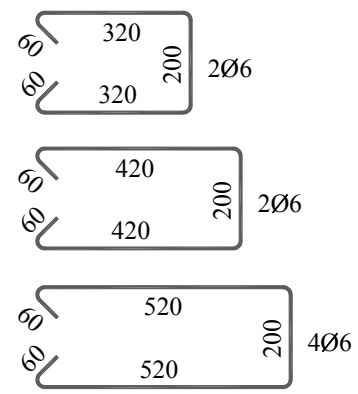
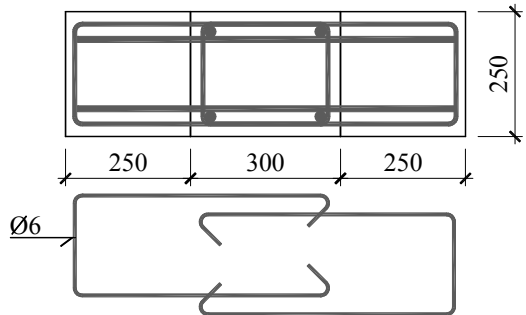
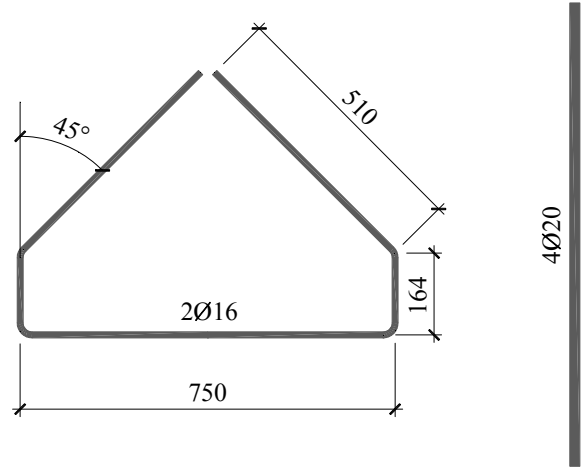
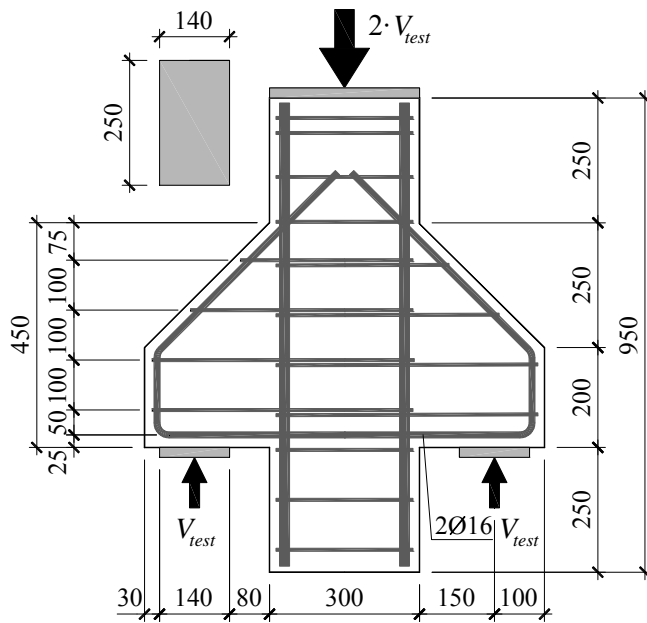

Zbrojenie modelu / Specimen's reinforcement

Wytrzymałość betonu na ściskanie / Compressive strength of concrete
 $f_{cm} = 45,1\text{MPa}$
 Moduł sprężystości podłużnej / Young's modulus
 $E_{cm} = 27,2\text{GPa}$
 Wytrzymałość betonu na rozciąganie przy rozłupywaniu / Tensile splitting strength of concrete
 $f_{ct,sp} = 3,7\text{MPa}$
 Gęstość betonu / Density of concrete
 $\rho = 2220\text{kg/m}^3$
 Charakterystyka zbrojenia / Characteristics of the reinforcement
 Ø6
 $A_s = 28,07\text{mm}^2, f_{ym} = 385,6\text{MPa}, f_{tm} = 487,6\text{MPa}$
 Ø16
 $A_s = 200,53\text{mm}^2, f_{ym} = 533,6\text{MPa}, f_{tm} = 638,5\text{MPa}$
 Ø20
 $A_s = 310,67\text{mm}^2, f_{ym} = 541,0\text{MPa}, f_{tm} = 640,4\text{MPa}$
 Siła niszcząca / Failure force
 $V_{test} = 990\text{kN}$

D-0

Beton – odkształcenia po stronie S i N (długie tensometry) (ε_c) / Concrete – strains on S and N side (long gauges) (ε_c)

obciążenie wspornika corbel load	odkształcenie S S strain				odkształcenie N N strain			
	1	2	3	średnia/ average	4	5	6	średnia/ average
kN	‰	‰	‰	‰	‰	‰	‰	‰
0	0,000	0,000	0,000	0,000	0,000	0,000	0,000	0,000
0	0,000	0,000	0,000	0,000	0,000	0,000	0,000	0,000
50	-0,006	-0,012	-0,011	-0,010	-0,010	-0,018	-0,015	-0,014
100	-0,018	-0,025	-0,025	-0,023	-0,024	-0,052	-0,028	-0,035
150	-0,049	-0,044	-0,053	-0,049	-0,038	-0,078	-0,049	-0,055
200	-0,085	-0,098	-0,085	-0,089	-0,071	-0,136	-0,104	-0,104
250	-0,146	-0,167	-0,145	-0,153	-0,100	-0,191	-0,160	-0,150
300	-0,222	-0,208	-0,214	-0,215	-0,142	-0,267	-0,238	-0,216
350	-0,301	-0,261	-0,258	-0,273	-0,194	-0,349	-0,328	-0,290
400	-0,386	-0,332	-0,337	-0,352	-0,256	-0,432	-0,423	-0,370
50	-0,069	-0,062	-0,062	-0,064	-0,050	-0,134	-0,100	-0,095
50	-0,067	-0,059	-0,061	-0,062	-0,047	-0,130	-0,096	-0,091
100	-0,077	-0,082	-0,081	-0,080	-0,071	-0,152	-0,113	-0,112
150	-0,101	-0,121	-0,111	-0,111	-0,091	-0,186	-0,143	-0,140
200	-0,153	-0,165	-0,162	-0,160	-0,109	-0,234	-0,198	-0,180
250	-0,219	-0,201	-0,205	-0,208	-0,137	-0,288	-0,256	-0,227
300	-0,271	-0,229	-0,234	-0,245	-0,178	-0,336	-0,304	-0,273
350	-0,336	-0,278	-0,281	-0,298	-0,215	-0,399	-0,373	-0,329
400	-0,408	-0,339	-0,349	-0,365	-0,271	-0,465	-0,446	-0,394
50	-0,073	-0,064	-0,064	-0,067	-0,048	-0,138	-0,102	-0,096
100	-0,081	-0,087	-0,086	-0,085	-0,070	-0,159	-0,118	-0,116
150	-0,108	-0,130	-0,117	-0,118	-0,091	-0,198	-0,150	-0,146
200	-0,166	-0,171	-0,173	-0,170	-0,113	-0,245	-0,207	-0,188
250	-0,230	-0,204	-0,216	-0,217	-0,146	-0,305	-0,272	-0,241
300	-0,298	-0,236	-0,246	-0,260	-0,185	-0,353	-0,326	-0,288
350	-0,353	-0,285	-0,293	-0,310	-0,230	-0,412	-0,389	-0,344
400	-0,418	-0,344	-0,354	-0,372	-0,279	-0,477	-0,454	-0,403
50	-0,073	-0,065	-0,066	-0,068	-0,047	-0,139	-0,104	-0,097
100	-0,081	-0,087	-0,085	-0,084	-0,067	-0,161	-0,118	-0,115
150	-0,117	-0,134	-0,118	-0,123	-0,091	-0,205	-0,153	-0,150
200	-0,171	-0,173	-0,175	-0,173	-0,112	-0,250	-0,211	-0,191
250	-0,236	-0,205	-0,218	-0,220	-0,148	-0,310	-0,276	-0,245
300	-0,304	-0,237	-0,247	-0,263	-0,187	-0,363	-0,336	-0,295
350	-0,358	-0,286	-0,294	-0,313	-0,233	-0,417	-0,392	-0,347
400	-0,423	-0,345	-0,355	-0,374	-0,284	-0,482	-0,457	-0,408
450	-0,494	-0,379	-0,398	-0,424	-0,346	-0,542	-0,529	-0,472
450	-0,505	-0,388	-0,402	-0,432	-0,354	-0,557	-0,538	-0,483
500	-0,575	-0,438	-0,443	-0,485	-0,409	-0,610	-0,609	-0,543
500	-0,574	-0,438	-0,451	-0,488	-0,386	-0,676	-0,715	-0,592
500	-0,583	-0,449	-0,464	-0,499	-0,393	-0,687	-0,729	-0,603
550	-0,656	-0,522	-0,554	-0,577	-0,441	-0,747	-0,798	-0,662
550	-0,611	-0,445	-0,520	-0,525	-0,441	-0,745	-0,790	-0,659
604	-0,699	-0,525	-0,568	-0,597	-0,523	-0,838	-0,885	-0,749
660	-0,750	-0,551	-0,600	-0,634	-0,587	-0,910	-0,952	-0,816
711	-0,826	-0,626	-0,678	-0,710	-0,673	-1,005	-1,046	-0,908
771	-0,866	-0,703	-0,732	-0,767	-0,773	-1,117	-1,142	-1,011
788	-0,888	-0,712	-0,739	-0,780	-0,784	-1,143	-1,160	-1,029
814	-0,861	-0,741	-0,770	-0,791	-0,849	-1,203	-1,218	-1,090
840	-0,889	-0,771	-0,793	-0,818	-0,874	-1,243	-1,250	-1,122
867	-0,845	-0,790	-0,851	-0,829	-0,958	-1,337	-1,312	-1,202
882	-0,725	-0,706	-0,857	-0,763	-1,033	-1,420	-1,348	-1,267
918	-0,733	-0,712	-0,867	-0,771	-1,041	-1,431	-1,366	-1,279
944	-0,735	-0,717	-0,883	-0,778	-1,074	-1,472	-1,392	-1,313
968	-0,263	-0,265	-0,460	-0,329	-1,220	-1,628	-1,159	-1,336
984	-0,274	-0,266	-0,452	-0,331	-1,239	-1,655	-1,173	-1,356
989	-0,279	-0,255	-0,436	-0,323	-1,245	-1,664	-1,172	-1,360
990	-0,287	-0,214	-0,392	-0,298	-1,244	-1,671	-1,160	-1,358
989	-0,264	-0,174	-0,324	-0,254	-1,227	-1,665	-1,150	-1,347
902	-0,185	-0,072	-0,108	-0,122	-1,116	-1,519	-1,020	-1,218

Beton – odkształcenia po stronie S i N (długie tensometry) (ϵ_c) / Concrete – strains on S and N side (long gauges) (ϵ_c)

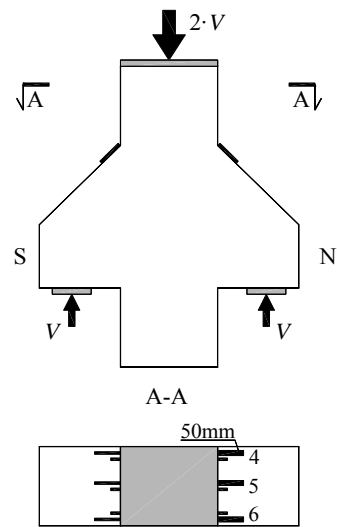
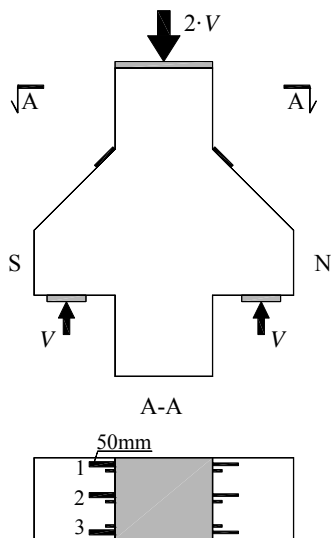
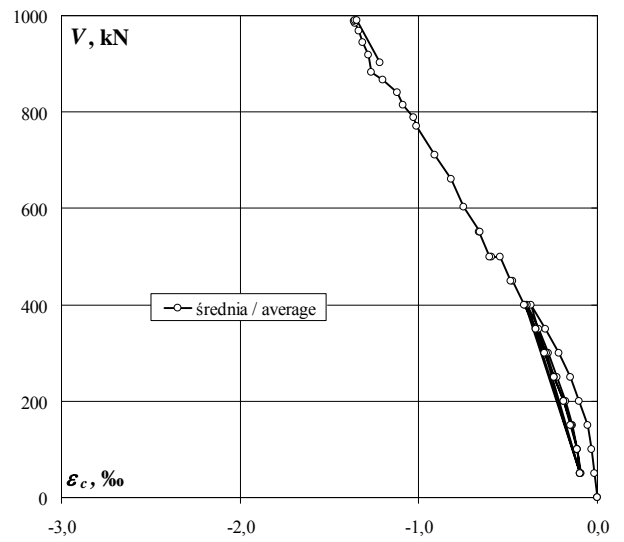
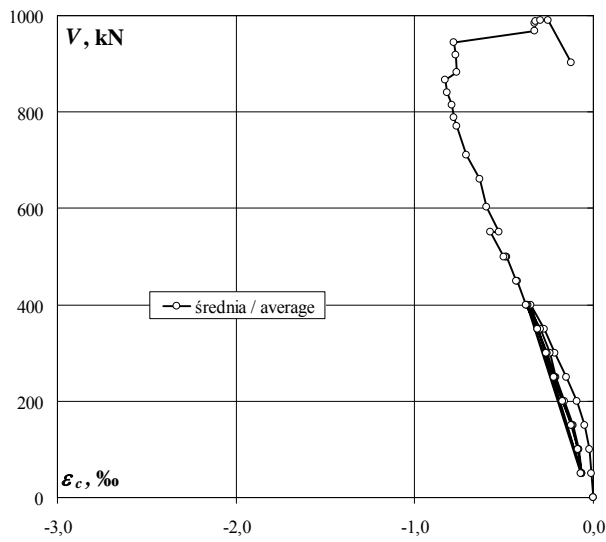
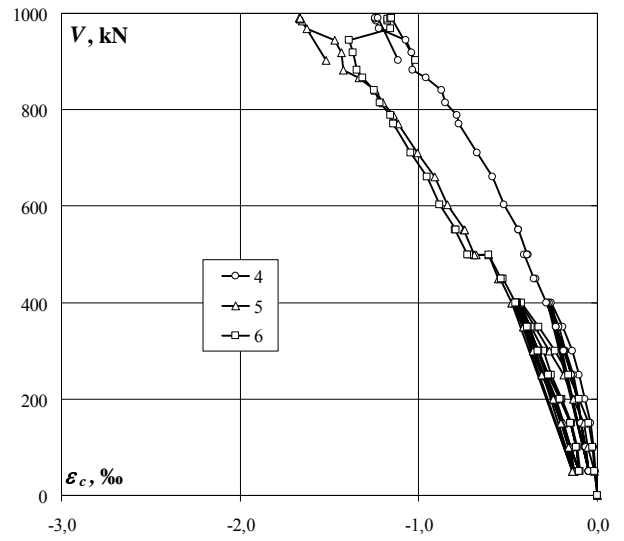
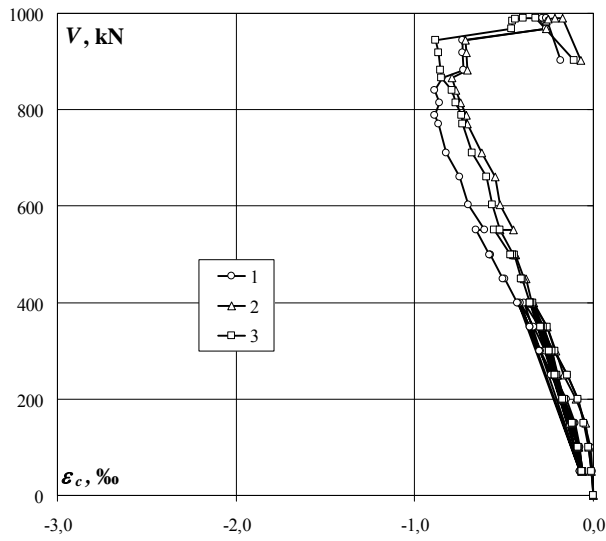

D-0

Beton – odkształcenia po stronie S i N (krótkie tensometry) (ε_c) / Concrete – strains on S and N side (short gauges) (ε_c)

obciążenie wspornika corbel load	odkształcenie S S strain				odkształcenie N N strain			
	7	8	9	średnia/ average	10	11	12	średnia/ average
kN	‰	‰	‰	‰	‰	‰	‰	‰
0	0,000	0,000	0,000	0,000	0,000	0,000	0,000	0,000
0	0,000	0,000	0,000	0,000	0,000	0,000	0,000	0,000
50	-0,006	0,002	-0,001	-0,002	-0,013	-0,006	-0,002	-0,007
100	-0,005	0,004	-0,007	-0,003	-0,033	-0,023	-0,010	-0,022
150	-0,016	0,000	-0,029	-0,015	-0,053	-0,051	-0,028	-0,044
200	-0,055	-0,019	-0,080	-0,051	-0,074	-0,109	-0,064	-0,082
250	-0,134	-0,043	-0,123	-0,100	-0,097	-0,162	-0,107	-0,122
300	-0,243	-0,063	-0,170	-0,159	-0,150	-0,265	-0,206	-0,207
350	-0,370	-0,084	-0,244	-0,233	-0,224	-0,357	-0,295	-0,292
400	-0,489	-0,096	-0,288	-0,291	-0,282	-0,464	-0,399	-0,382
50	-0,090	-0,016	-0,071	-0,059	-0,075	-0,119	-0,075	-0,090
50	-0,086	-0,015	-0,068	-0,056	-0,073	-0,116	-0,071	-0,087
100	-0,086	-0,010	-0,085	-0,060	-0,088	-0,138	-0,082	-0,103
150	-0,114	-0,015	-0,111	-0,080	-0,098	-0,158	-0,096	-0,117
200	-0,183	-0,027	-0,134	-0,115	-0,125	-0,211	-0,145	-0,160
250	-0,268	-0,045	-0,178	-0,164	-0,167	-0,288	-0,227	-0,227
300	-0,358	-0,060	-0,232	-0,217	-0,217	-0,342	-0,281	-0,280
350	-0,452	-0,083	-0,274	-0,270	-0,257	-0,433	-0,371	-0,354
400	-0,544	-0,098	-0,308	-0,317	-0,317	-0,526	-0,436	-0,426
50	-0,101	-0,019	-0,083	-0,068	-0,084	-0,132	-0,086	-0,101
100	-0,097	-0,013	-0,095	-0,068	-0,095	-0,147	-0,089	-0,110
150	-0,135	-0,018	-0,120	-0,091	-0,103	-0,170	-0,106	-0,126
200	-0,214	-0,032	-0,143	-0,130	-0,135	-0,237	-0,166	-0,179
250	-0,305	-0,048	-0,182	-0,178	-0,187	-0,295	-0,238	-0,240
300	-0,390	-0,062	-0,241	-0,231	-0,235	-0,371	-0,305	-0,304
350	-0,478	-0,085	-0,274	-0,279	-0,272	-0,443	-0,384	-0,366
400	-0,568	-0,099	-0,315	-0,327	-0,342	-0,543	-0,452	-0,446
50	-0,109	-0,022	-0,086	-0,072	-0,086	-0,137	-0,089	-0,104
100	-0,105	-0,017	-0,101	-0,074	-0,096	-0,148	-0,093	-0,112
150	-0,154	-0,021	-0,124	-0,100	-0,109	-0,179	-0,113	-0,134
200	-0,234	-0,033	-0,149	-0,139	-0,145	-0,252	-0,184	-0,194
250	-0,319	-0,049	-0,197	-0,188	-0,198	-0,305	-0,244	-0,249
300	-0,410	-0,064	-0,249	-0,241	-0,243	-0,393	-0,327	-0,321
350	-0,497	-0,085	-0,278	-0,287	-0,281	-0,453	-0,390	-0,375
400	-0,593	-0,100	-0,321	-0,338	-0,352	-0,552	-0,471	-0,458
450	-0,686	-0,127	-0,378	-0,397	-0,398	-0,631	-0,540	-0,523
450	-0,708	-0,130	-0,386	-0,408	-0,412	-0,649	-0,556	-0,539
500	-0,813	-0,172	-0,420	-0,468	-0,489	-0,732	-0,649	-0,623
500	-0,824	-0,168	-0,419	-0,470	-0,668	-1,005	-0,933	-0,869
500	-0,843	-0,174	-0,425	-0,481	-0,702	-1,049	-0,967	-0,906
550	-0,935	-0,199	-0,483	-0,539	-0,780	-1,141	-1,068	-0,996
550	-1,364	-0,304	-0,634	-0,767	-0,790	-1,150	-1,072	-1,004
604	-1,588	-0,364	-0,707	-0,886	-0,930	-1,324	-1,222	-1,159
660	-1,756	-0,414	-0,753	-0,974	-1,037	-1,454	-1,321	-1,271
711	-1,977	-0,487	-0,843	-1,102	-1,186	-1,642	-1,475	-1,434
771	-2,212	-0,575	-0,912	-1,233	-1,370	-1,863	-1,638	-1,624
788	-2,246	-0,589	-0,929	-1,255	-1,391	-1,891	-1,668	-1,650
814	-2,364	-0,646	-0,985	-1,332	-1,509	-2,018	-1,757	-1,761
840	-2,429	-0,679	-1,002	-1,370	-1,560	-2,080	-1,817	-1,819
867	-2,558	-0,767	-1,080	-1,468	-1,742	-2,272	-1,951	-1,988
882	-2,635	-0,737	-1,144	-1,505	-1,925	-2,446	-2,058	-2,143
918	-2,652	-0,752	-1,150	-1,518	-1,947	-2,464	-2,081	-2,164
944	-2,709	-0,769	-1,172	-1,550	-1,998	-2,522	-2,121	-2,214
968	-1,606	-0,293	-1,169	-1,023	-2,496	-3,208	-2,503	-2,736
984	-1,595	-0,300	-1,177	-1,024	-2,541	-3,252	-2,538	-2,777
989	-1,555	-0,285	-1,179	-1,006	-2,571	-3,286	-2,552	-2,803
990	-1,489	-0,228	-1,165	-0,961	-2,634	-3,338	-2,579	-2,850
989	-1,436	-0,146	-1,134	-0,905	-2,658	-3,354	-2,584	-2,865
902	-1,043	-0,045	-0,712	-0,600	-2,485	-3,164	-2,408	-2,686

Beton – odkształcenia po stronie S i N (krótkie tensometry) (ϵ_c) / Concrete – strains on S and N side (short gauges) (ϵ_c)

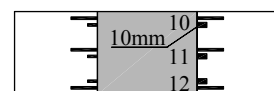
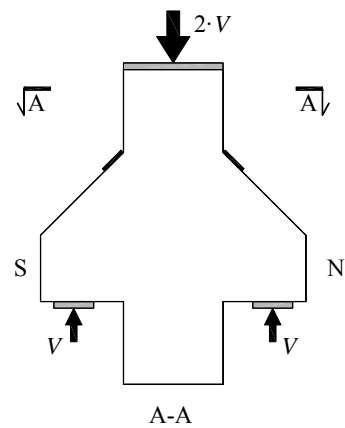
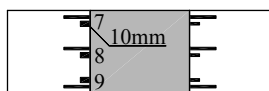
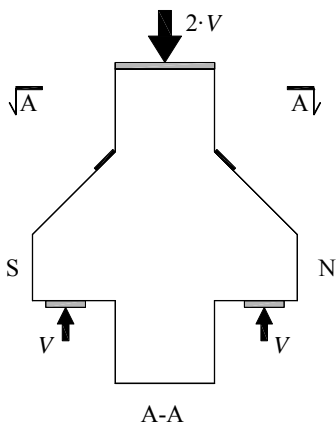
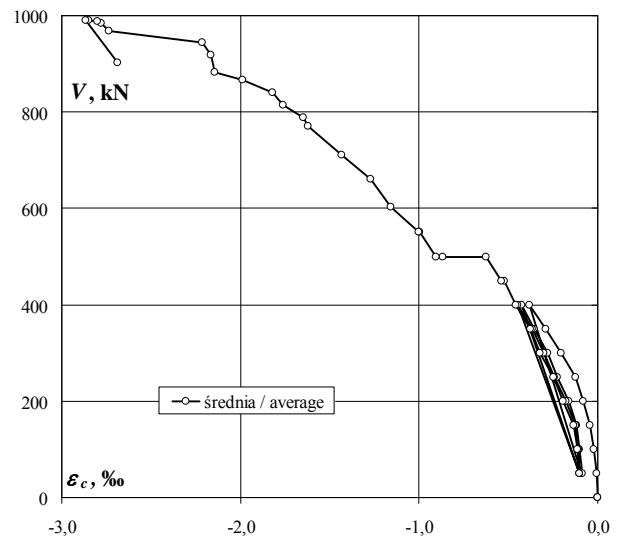
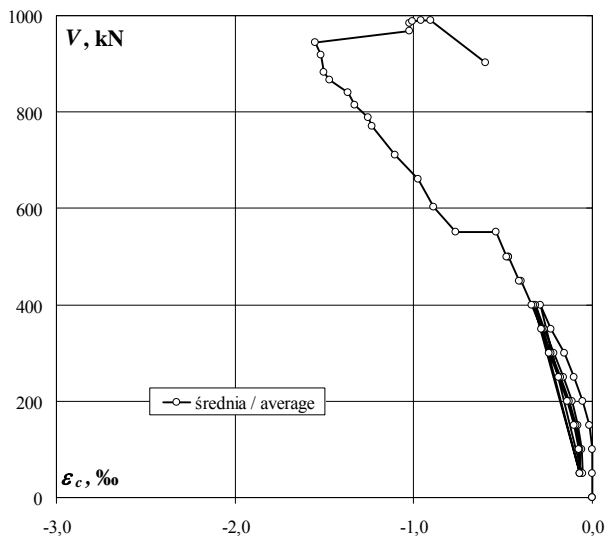
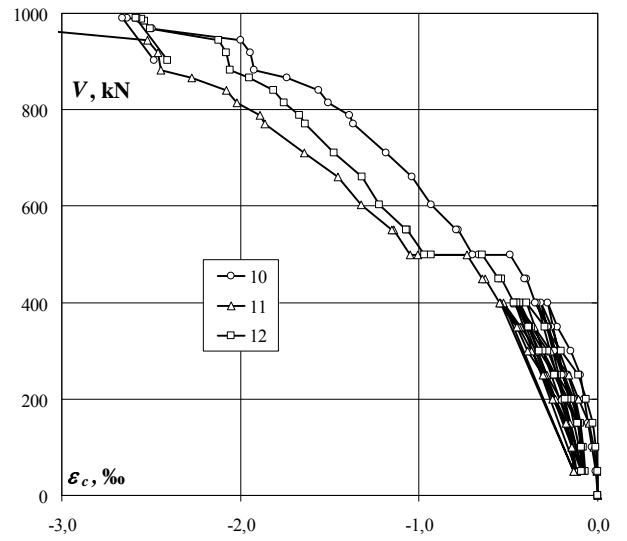
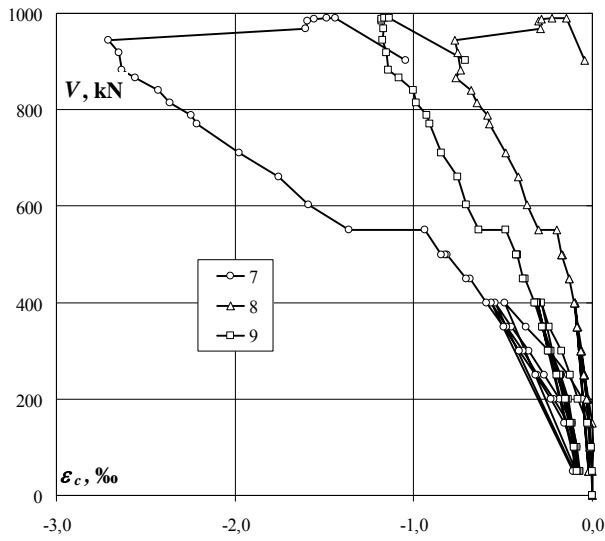

D-0

Strzeżenie 1 – odkształcenia po stronie S i N (ϵ_s) / Stirrup 1 – strains on S and N side (ϵ_s)

obciążenie wspornika corbel load	odkształcenie S S strain			odkształcenie N N strain		
	5	6	średnia/ average	7	8	średnia/ average
	%	%	%	%	%	%
kN						
0	0,000	0,000	0,000	0,000	0,000	0,000
0	0,001	0,000	0,001	0,000	0,000	0,000
50	0,016	0,020	0,018	0,021	0,024	0,023
100	0,109	0,148	0,129	0,110	0,103	0,107
150	0,376	0,521	0,449	0,197	0,205	0,201
200	0,581	0,641	0,611	0,338	0,366	0,352
250	0,702	0,378	0,540	0,501	0,583	0,542
300	0,798	0,536	0,667	0,864	0,804	0,834
350	0,865	0,595	0,730		1,131	1,131
400	0,917	0,670	0,794		1,527	1,527
50	0,201	0,201	0,201		0,734	0,734
50	0,195	0,193	0,194		0,722	0,722
100	0,271	0,296	0,284		0,824	0,824
150	0,346	0,383	0,365		0,972	0,972
200	0,416	0,432	0,424		1,105	1,105
250	0,502	0,490	0,496		1,238	1,238
300	0,579	0,548	0,564		1,361	1,361
350	0,666	0,623	0,645		1,488	1,488
400	0,736	0,706	0,721		1,617	1,617
50	0,164	0,239	0,202		0,742	0,742
100	0,238	0,342	0,290		0,868	0,868
150	0,298	0,408	0,353		1,018	1,018
200	0,373	0,456	0,415		1,159	1,159
250	0,447	0,509	0,478		1,287	1,287
300	0,531	0,563	0,547		1,416	1,416
350	0,603	0,631	0,617		1,538	1,538
400	0,670	0,708	0,689		1,672	1,672
50	0,134	0,251	0,193		0,747	0,747
100	0,207	0,356	0,282		0,886	0,886
150	0,250	0,416	0,333		1,050	1,050
200	0,299	0,464	0,382		1,199	1,199
250	0,371	0,514	0,443		1,333	1,333
300	0,439	0,567	0,503		1,466	1,466
350	0,515	0,635	0,575		1,576	1,576
400	0,578	0,713	0,646		1,705	1,705
450	0,619	0,796	0,708		1,851	1,851
450	0,609	0,792	0,701		1,879	1,879
500	0,639	0,842	0,741		1,976	1,976
500	0,565	0,794	0,680		2,044	2,044
500	0,590	0,809	0,700		2,052	2,052
550	0,657	0,873	0,765		2,116	2,116
550	0,696	0,956	0,826		2,090	2,090
604	0,823	1,041	0,932		2,189	2,189
660	0,868	1,103	0,986		2,251	2,251
711	0,949	1,184	1,067		2,333	2,333
771	1,014	1,269	1,142		2,288	2,288
788	1,029	1,285	1,157		2,303	2,303
814	1,069	1,296	1,183		2,273	2,273
840	1,085	1,319	1,202		2,287	2,287
867	1,148	1,332	1,240		2,254	2,254
882	1,214	1,392	1,303		2,216	2,216
918	1,227	1,403	1,315		2,234	2,234
944	1,243	1,430	1,337		2,264	2,264
968	1,587		1,587		2,357	2,357
984	1,600		1,600		2,381	2,381
989	1,626		1,626		2,407	2,407
990	1,641		1,641		2,441	2,441
989	1,641		1,641		2,438	2,438
902	1,217		1,217		2,235	2,235

Strzemię 1 – odkształcenia po stronie S i N (ϵ_s) / Stirrup 1 – strains on S and N side (ϵ_s)

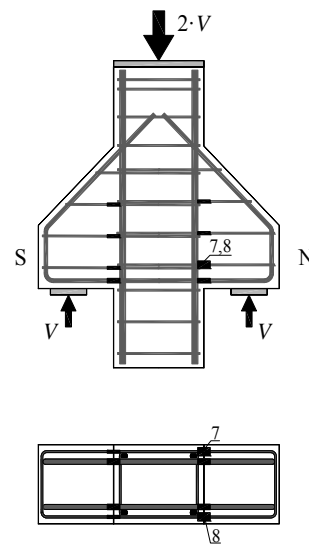
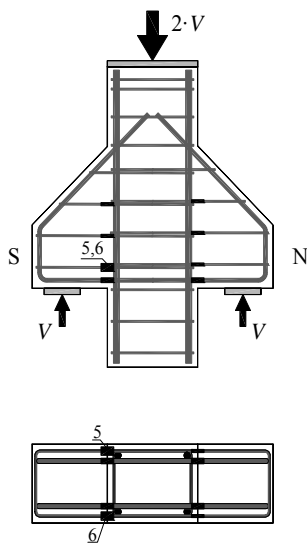
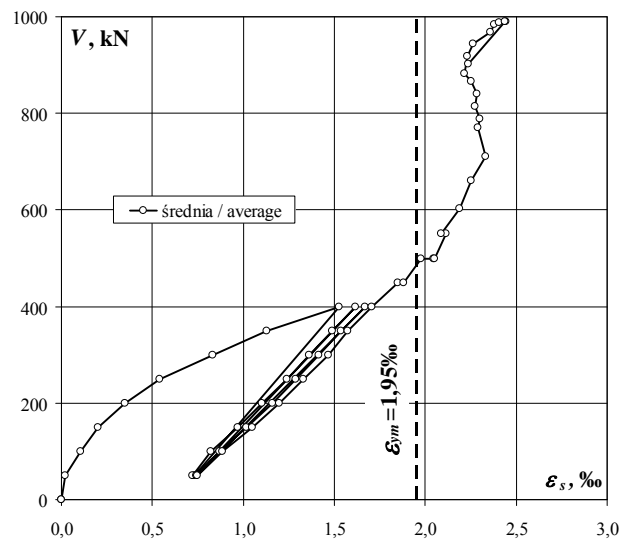
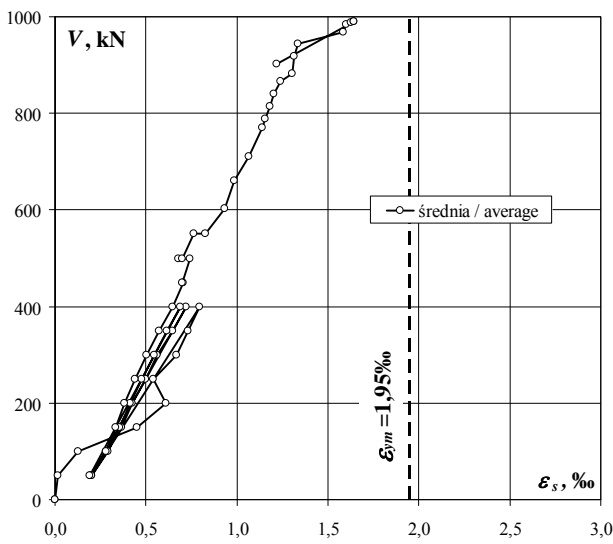
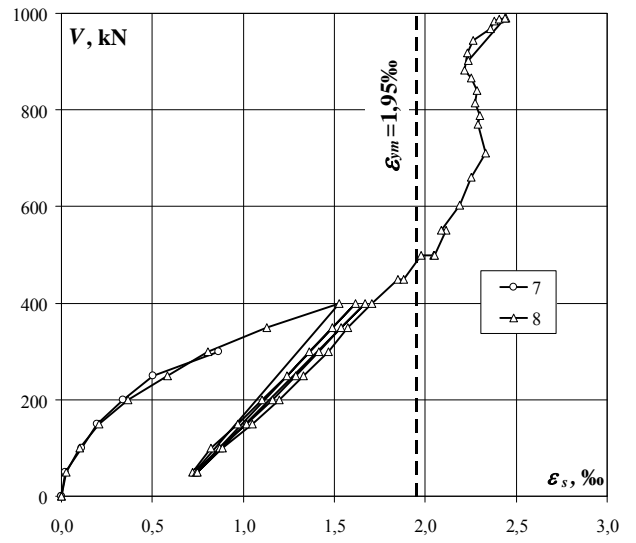
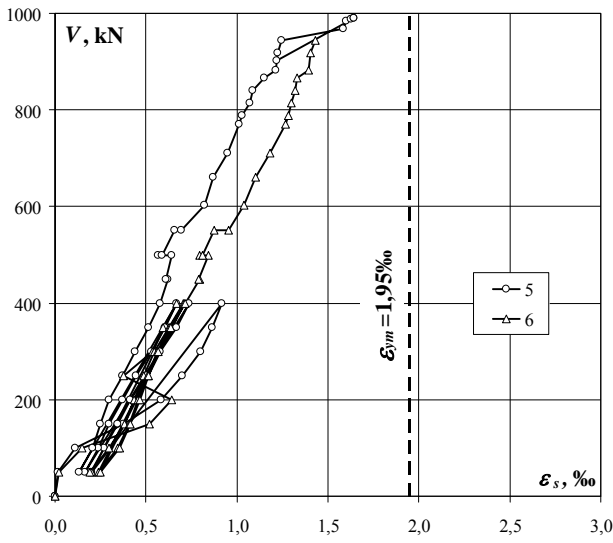

D-0

Strzemię 2 – odkształcenia po stronie S i N (ϵ_s) / Stirrup 2 – strains on S and N side (ϵ_s)

obciążenie wspornika corbel load	odkształcenie S S strain			odkształcenie N N strain		
	9	10	średnia/ average	11	12	średnia/ average
kN	‰	‰	‰	‰	‰	‰
0	0,000	0,000	0,000	0,000	0,000	0,000
0	0,000	-0,002	-0,001	0,000	0,000	0,000
50	0,006	0,004	0,005	0,006	0,007	0,007
100	0,033	0,023	0,028	0,046	0,031	0,039
150	0,088	0,053	0,071	0,133	0,074	0,104
200	0,148	0,163	0,156	0,280	0,164	0,222
250	0,208	0,231	0,220	0,443	0,296	0,370
300	0,302	0,362	0,332	0,558	0,480	0,519
350	0,437	0,333	0,385	0,629	0,665	0,647
400	0,518	0,595	0,557	0,728	0,859	0,794
50	0,276	0,046	0,161	0,268	0,496	0,382
50	0,268	0,040	0,154	0,265	0,483	0,374
100	0,299	0,182	0,241	0,318	0,529	0,424
150	0,344	0,320	0,332	0,398	0,600	0,499
200	0,393	0,467	0,430	0,464	0,672	0,568
250	0,437	0,289	0,363	0,540	0,741	0,641
300	0,475	0,407	0,441	0,603	0,800	0,702
350	0,516	0,521	0,519	0,678	0,877	0,778
400	0,554	0,655	0,605	0,740	0,965	0,853
50	0,266	0,009	0,138	0,271	0,518	0,395
100	0,298	0,144	0,221	0,332	0,573	0,453
150	0,347	0,304	0,326	0,408	0,653	0,531
200	0,401	0,447	0,424	0,472	0,734	0,603
250	0,439	0,273	0,356	0,545	0,806	0,676
300	0,481	0,384	0,433	0,607	0,886	0,747
350	0,513	0,469	0,491	0,679	0,949	0,814
400	0,552	0,594	0,573	0,741	1,031	0,886
50	0,257	-0,025	0,116	0,271	0,535	0,403
100	0,292	0,116	0,204	0,334	0,596	0,465
150	0,345	0,282	0,314	0,411	0,685	0,548
200	0,401	0,439	0,420	0,476	0,769	0,623
250	0,443	0,568	0,506	0,549	0,850	0,700
300	0,483	0,344	0,414	0,611	0,926	0,769
350	0,517	0,459	0,488	0,679	0,986	0,833
400	0,554	0,568	0,561	0,741	1,056	0,899
450	0,598	0,747	0,673	0,813	1,149	0,981
450	0,621	0,840	0,731	0,831	1,178	1,005
500	0,682	1,001	0,842	0,894	1,241	1,068
500	0,694	1,048	0,871	0,977	1,317	1,147
500	0,706	1,050	0,878	1,000	1,322	1,161
550	0,759	1,128	0,944	1,072	1,330	1,201
550	0,909	1,007	0,958	1,058	1,306	1,182
604	0,994	1,371	1,183	1,154	1,318	1,236
660	1,061	1,468	1,265	1,183	1,326	1,255
711	1,159	1,580	1,370	1,229	1,342	1,286
771	1,276	1,708	1,492	1,238	1,374	1,306
788	1,291	1,723	1,507	1,254	1,375	1,315
814	1,356	1,819	1,588	1,223	1,399	1,311
840	1,394	1,852	1,623	1,208	1,407	1,308
867	1,485	2,012	1,749	1,152	1,444	1,298
882	1,560	2,139	1,850	0,914	1,490	1,202
918	1,569	2,147	1,858	0,921	1,494	1,208
944	1,597	2,164	1,881	0,902	1,499	1,201
968	1,862	2,903	2,383	0,744	1,681	1,213
984	1,882	2,933	2,408	0,745	1,689	1,217
989	1,901	2,942	2,422	0,746	1,713	1,230
990	1,938	2,951	2,445	0,776	1,799	1,288
989	1,945	2,955	2,450	0,790	1,837	1,314
902	1,610	2,662	2,136	0,632	1,737	1,185

Strzemię 2 – odkształcenia po stronie S i N (ϵ_s) / Stirrup 2 – strains on S and N side (ϵ_s)

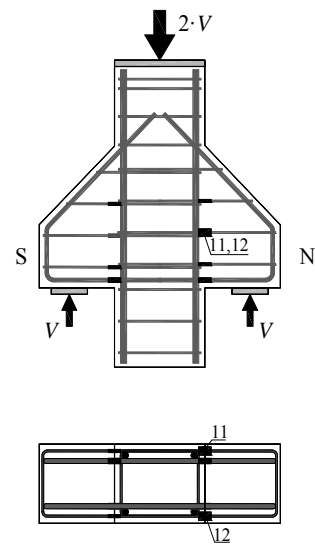
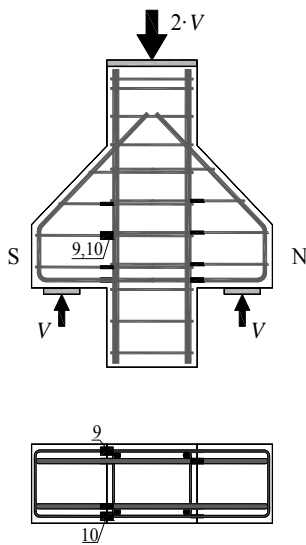
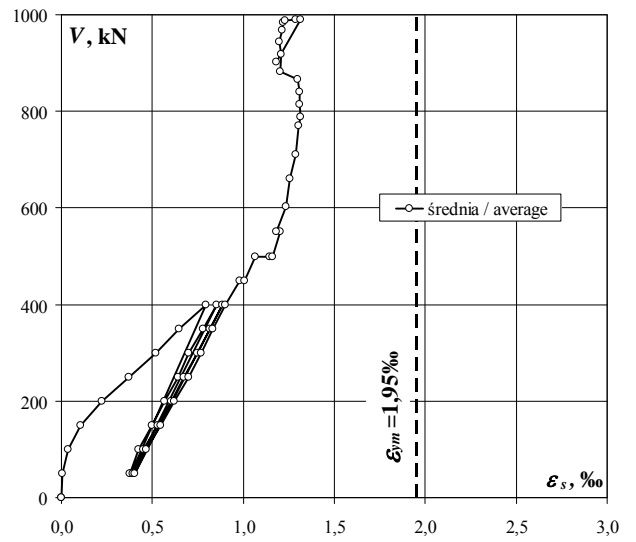
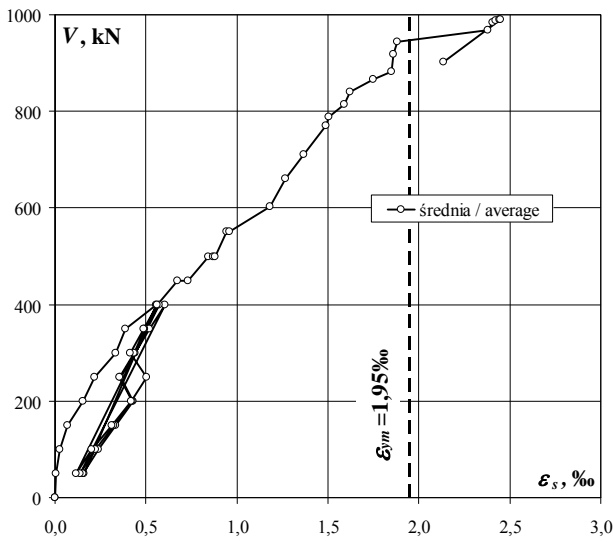
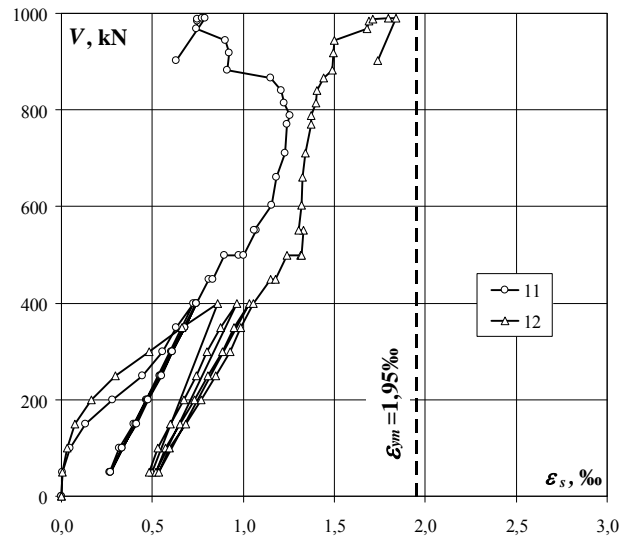
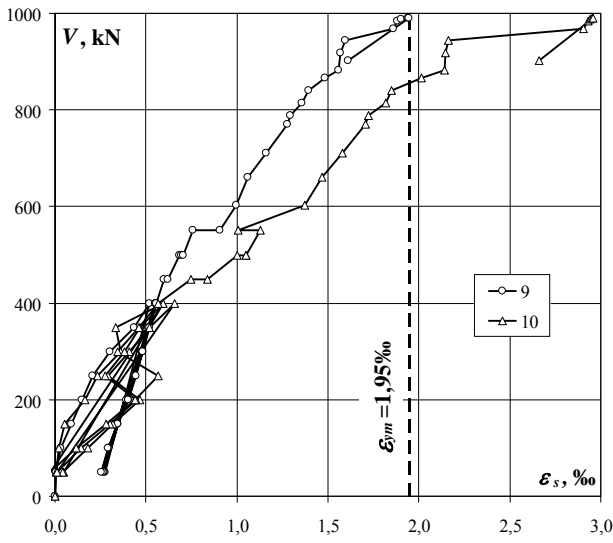

D-0

Strzemie 3 – odkształcenia po stronie S i N (ϵ_s) / Stirrup 3 – strains on S and N side (ϵ_s)

obciążenie wspornika corbel load	odkształcenie S S strain			odkształcenie N N strain		
	13	14	średnia/ average	15	16	średnia/ average
	kN	‰	‰	‰	‰	‰
0	0,000	0,000	0,000	0,000		
0	0,000	-0,001	-0,001	-0,002		
50	-0,002	-0,003	-0,003	-0,008		
100	0,003	-0,003	0,000	-0,004		
150	0,025	0,025	0,025	0,014		
200	0,046	0,098	0,072	0,061		
250	0,059	0,180	0,120	0,136		
300	0,063	0,236	0,150	0,265		
350	0,069	0,283	0,176	0,413		
400	0,084	0,314	0,199	0,546		
50	0,051	0,146	0,099	0,462		
50	0,049	0,146	0,098	0,471		
100	0,055	0,158	0,107	0,478		
150	0,060	0,185	0,123	0,512		
200	0,065	0,211	0,138	0,548		
250	0,075	0,232	0,154	0,580		
300	0,081	0,254	0,168	0,607		
350	0,089	0,270	0,180	0,634		
400	0,099	0,292	0,196	0,666		
50	0,060	0,105	0,083	0,532		
100	0,066	0,120	0,093	0,548		
150	0,071	0,142	0,107	0,578		
200	0,075	0,161	0,118	0,611		
250	0,082	0,183	0,133	0,645		
300	0,089	0,195	0,142	0,670		
350	0,095	0,205	0,150	0,695		
400	0,106	0,202	0,154	0,717		
50	0,063	0,074	0,069	0,570		
100	0,070	0,087	0,079	0,584		
150	0,075	0,105	0,090	0,617		
200	0,081	0,119	0,100	0,650		
250	0,088	0,136	0,112	0,680		
300	0,094	0,147	0,121	0,706		
350	0,101	0,158	0,130	0,724		
400	0,112	0,163	0,138	0,741		
450	0,129	0,153	0,141	0,755		
450	0,142	0,114	0,128	0,715		
500	0,167	0,084	0,126	0,695		
500	0,195	0,025	0,110	0,888		
500	0,206	0,024	0,115	0,904		
550	0,230	0,051	0,141	0,947		
550	0,616	0,403	0,510	0,908		
604	0,517	0,290	0,404	0,933		
660		0,234	0,234	0,461		
711		0,241	0,241			
771		0,205	0,205			
788		0,200	0,200			
814		0,181	0,181			
840		0,176	0,176			
867		0,143	0,143			
882		0,116	0,116			
918		0,141	0,141			
944		0,161	0,161			
968		0,215	0,215			
984		0,218	0,218			
989		0,257	0,257			
990		0,262	0,262			
989		0,268	0,268			
902		0,278	0,278			

Strzemię 3 – odkształcenia po stronie S i N (ϵ_s) / Stirrup 3 – strains on S and N side (ϵ_s)

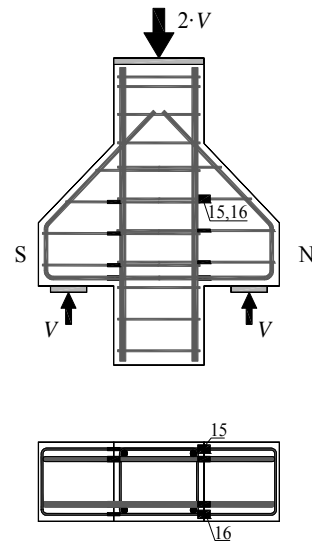
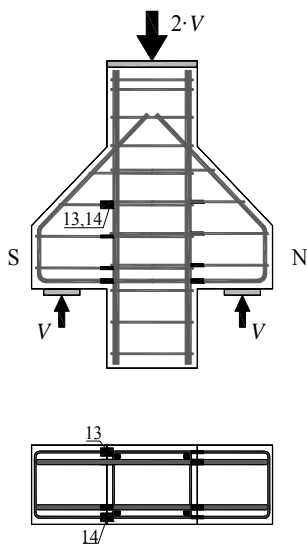
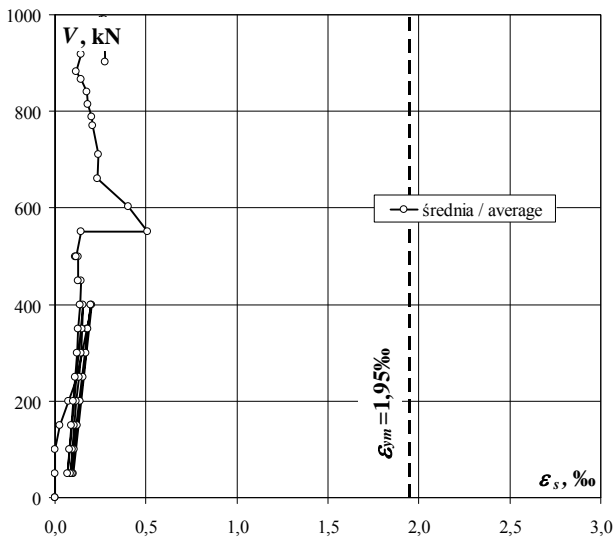
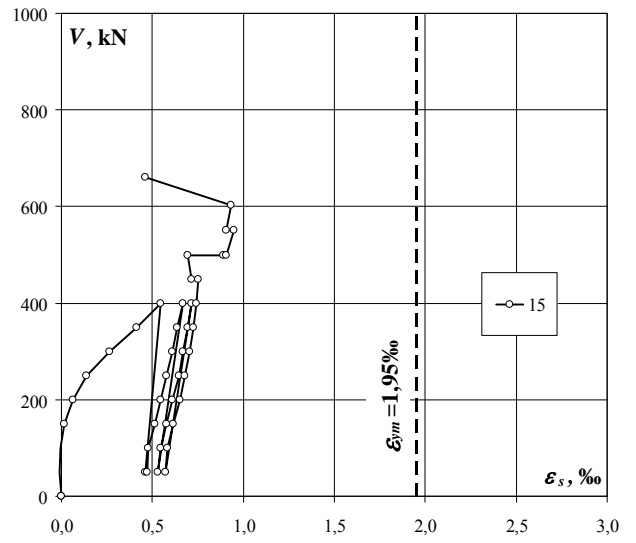
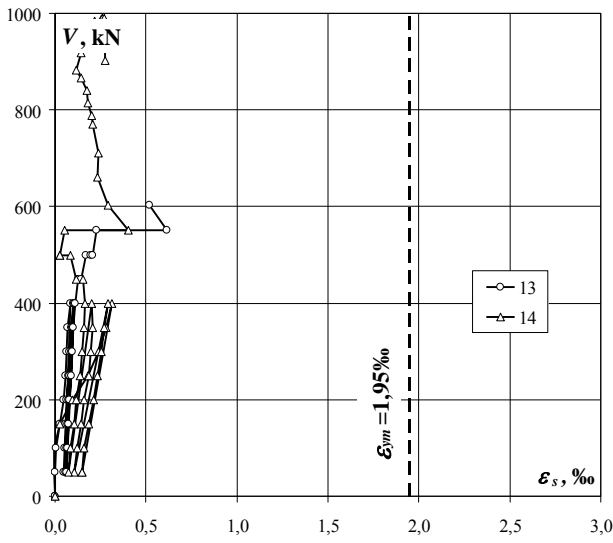

D-0

Szerokość rozwarcia rys / Crack width

obciążenie wspornika corbel load	Numer rysy / Crack number							
	1	2	3	4	5	6	7	8
	mm	mm	mm	mm	mm	mm	mm	mm
250	0,15	0,10	0,10					
300	0,15	0,12	0,12	0,15				
350	0,17	0,15	0,10	0,20				
400	0,20	0,15	0,15	0,20				
50	0,05	0,05	0,05	0,05				
100	0,07	0,07	0,07	0,07				
150	0,10	0,10	0,07	0,12				
200	0,12	0,10	0,10	0,15				
250	0,12	0,10	0,10	0,15				
300	0,15	0,12	0,10	0,17				
350	0,20	0,12	0,10	0,17				
400	0,20	0,15	0,15	0,20				
100	0,07	0,05	0,05	0,07				
150	0,10	0,10	0,07	0,10				
200	0,15	0,12	0,10	0,15				
250	0,15	0,12	0,12	0,17				
300	0,17	0,12	0,12	0,17				
350	0,20	0,15	0,15	0,17				
400	0,20	0,15	0,15	0,20				
50	0,07	0,05	0,07	0,10				
100	0,10	0,10	0,10	0,10				
150	0,12	0,12	0,12	0,12				
200	0,12	0,15	0,15	0,15				
250	0,15	0,15	0,15	0,15				
300	0,17	0,15	0,15	0,15				
350	0,20	0,15	0,20	0,20				
400	0,22	0,17	0,20	0,20				
450	0,25	0,20	0,22	0,22				
500	0,25	0,22	0,22	0,22	0,20	0,27		
550	0,27	0,25	0,20	0,20	0,25	0,30	0,25	0,25
600	0,25	0,27	0,20	0,20	0,25	0,35	0,35	0,25
650	0,25	0,30	0,25	0,25	0,30	0,35	0,40	0,30
700	0,25	0,30	0,20	0,20	0,35	0,45	0,45	0,35
750	0,30	0,35	0,20	0,20	0,45	0,40	0,50	0,40
800	0,30	0,35	0,20	0,20	0,50	0,50	0,50	0,45
850	0,30	0,35	0,20	0,20	0,50	0,65	0,55	0,50
900	0,35	0,35	0,25	0,25	0,65	0,70	0,70	0,55
950							1,00	

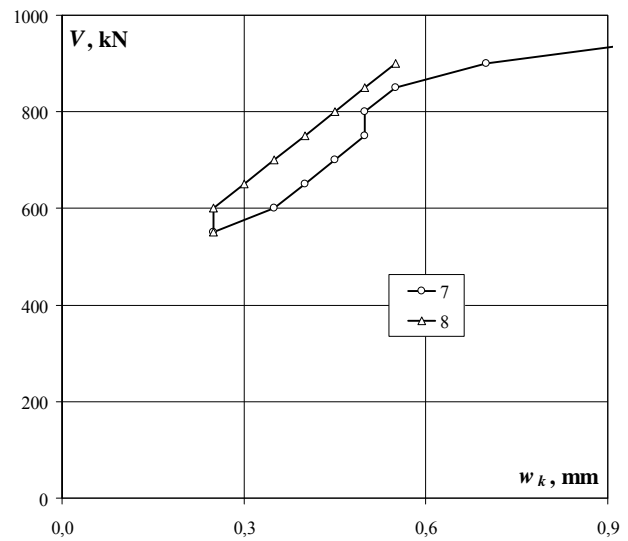
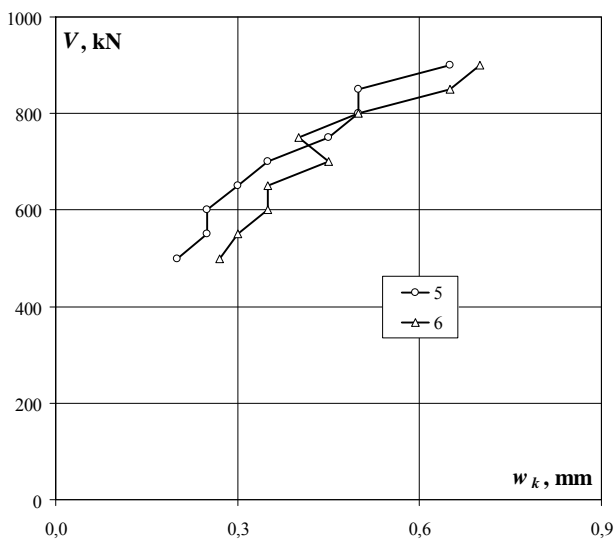
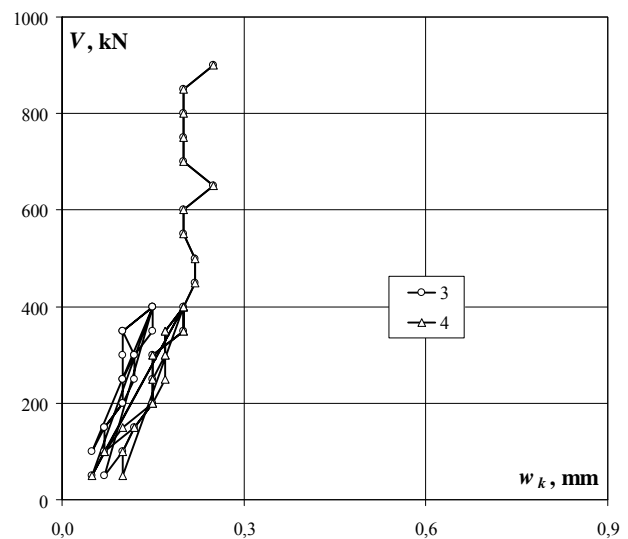
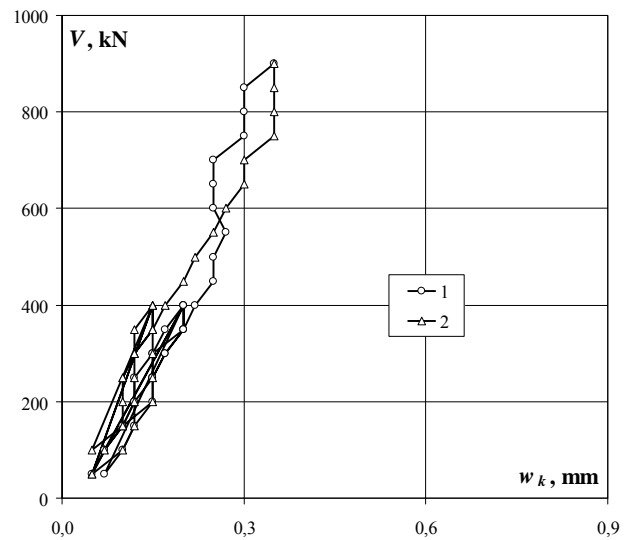

Układ rys przy sile 800kN / Crack pattern at 800kN

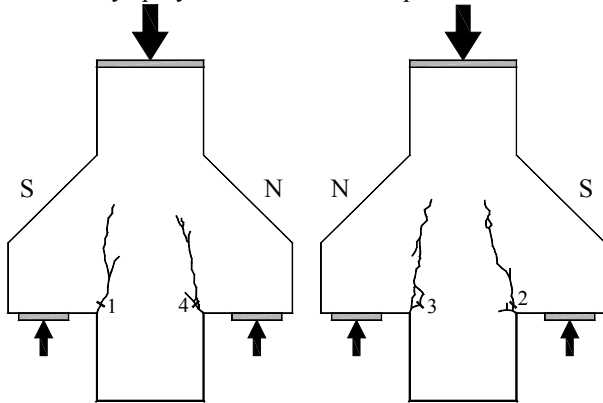

Układ rys przy sile 1100kN / Crack pattern at 1100kN

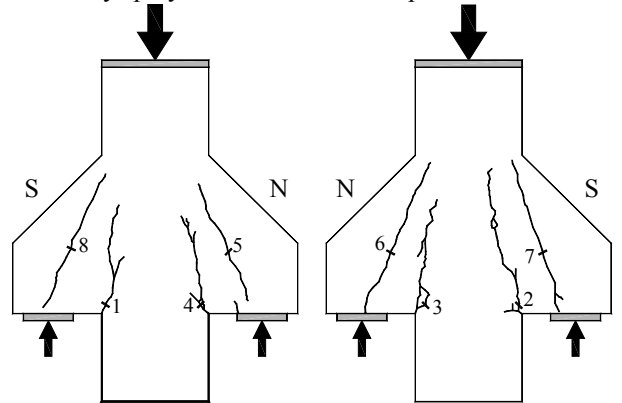

Układ rys przy sile 1800kN / Crack pattern at 1800kN

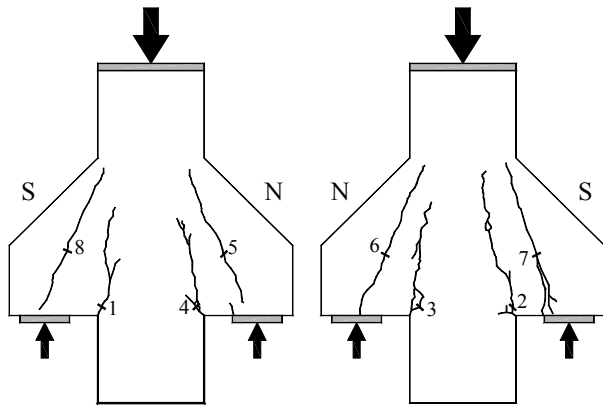

Układ rys przy zniszczeniu 1980kN / Crack pattern at failure 1980kN

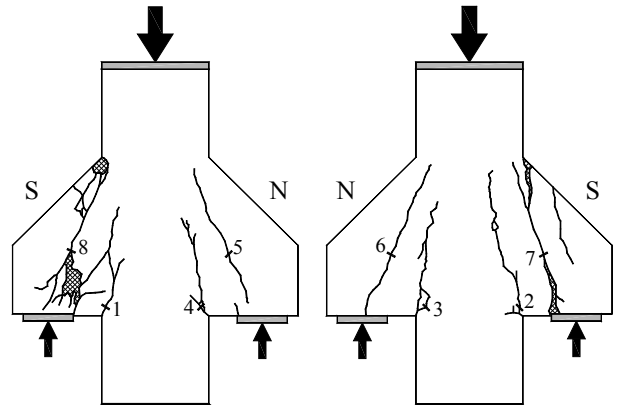

D-0

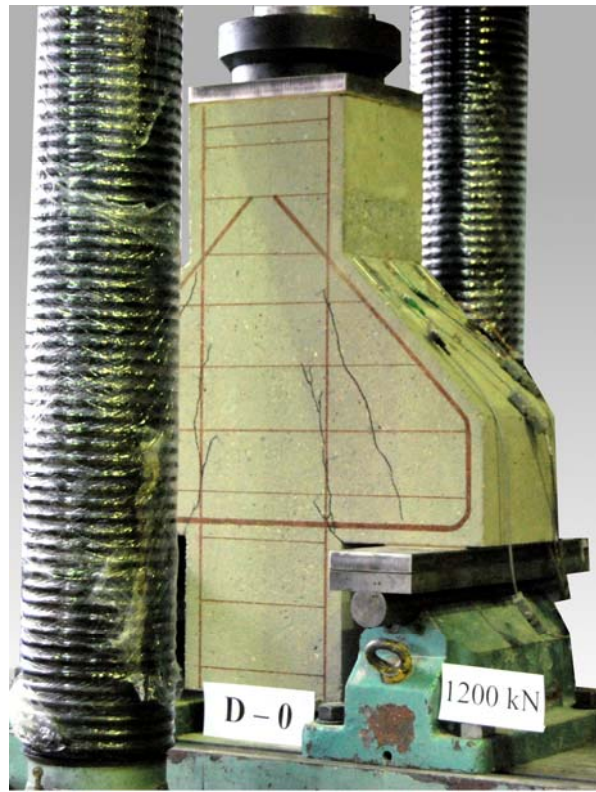
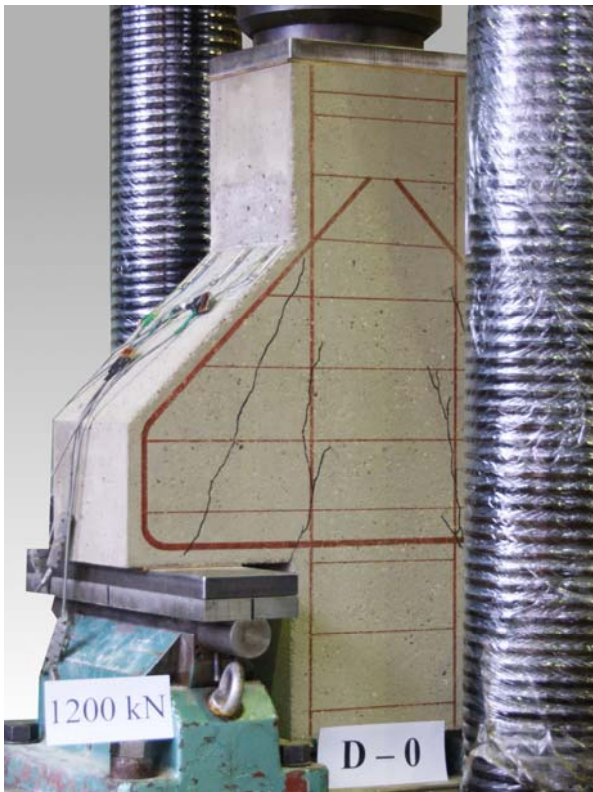

Wspornik podczas badania / Corbel during test

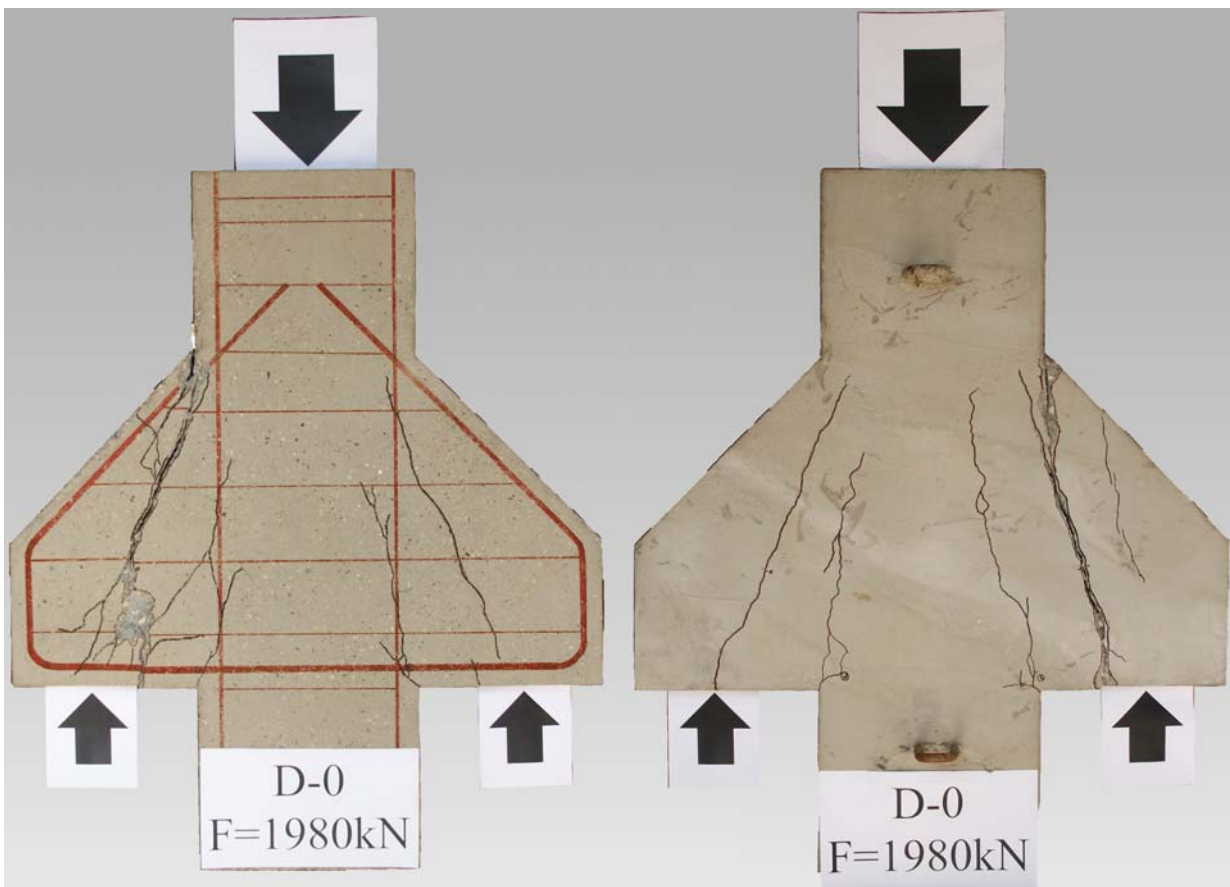

Wspornik po zniszczeniu / Corbel after failure

Przemieszczenie słupa względem wsporników / The relative displacement between the column and the corbels

obciążenie wspornika corbel load	Przemieszczenie / Displacement
	mm
0	0,00
50	0,01
100	0,03
150	0,07
200	0,10
250	0,14
300	0,18
350	0,22
400	0,26
50	0,11
100	0,12
150	0,14
200	0,17
250	0,19
300	0,22
350	0,25
400	0,28
50	0,12
100	0,13
150	0,15
200	0,18
250	0,21
300	0,24
350	0,26
400	0,29
50	0,12
100	0,13
150	0,16
200	0,19
250	0,21
300	0,24
350	0,27
400	0,29
450	0,32
500	0,36
500	0,45
550	0,53
550	0,56
600	0,59
600	0,61
650	0,64
650	0,66
700	0,70
700	0,73
750	0,77
750	0,81
800	0,84
800	0,87
850	0,93
850	0,96
900	1,00
900	1,05
950	1,10
950	1,32

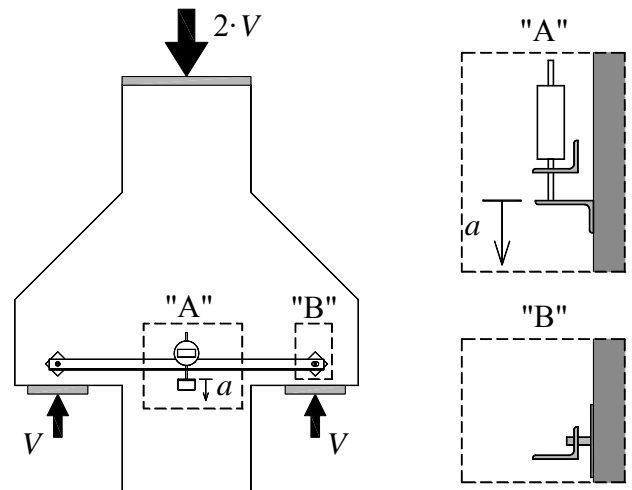
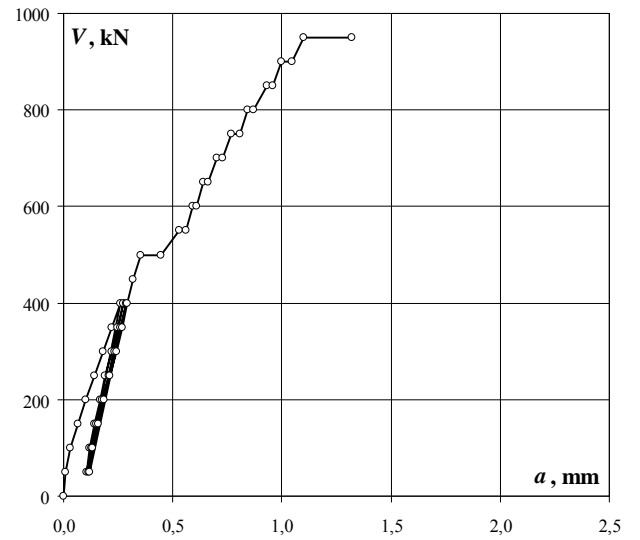

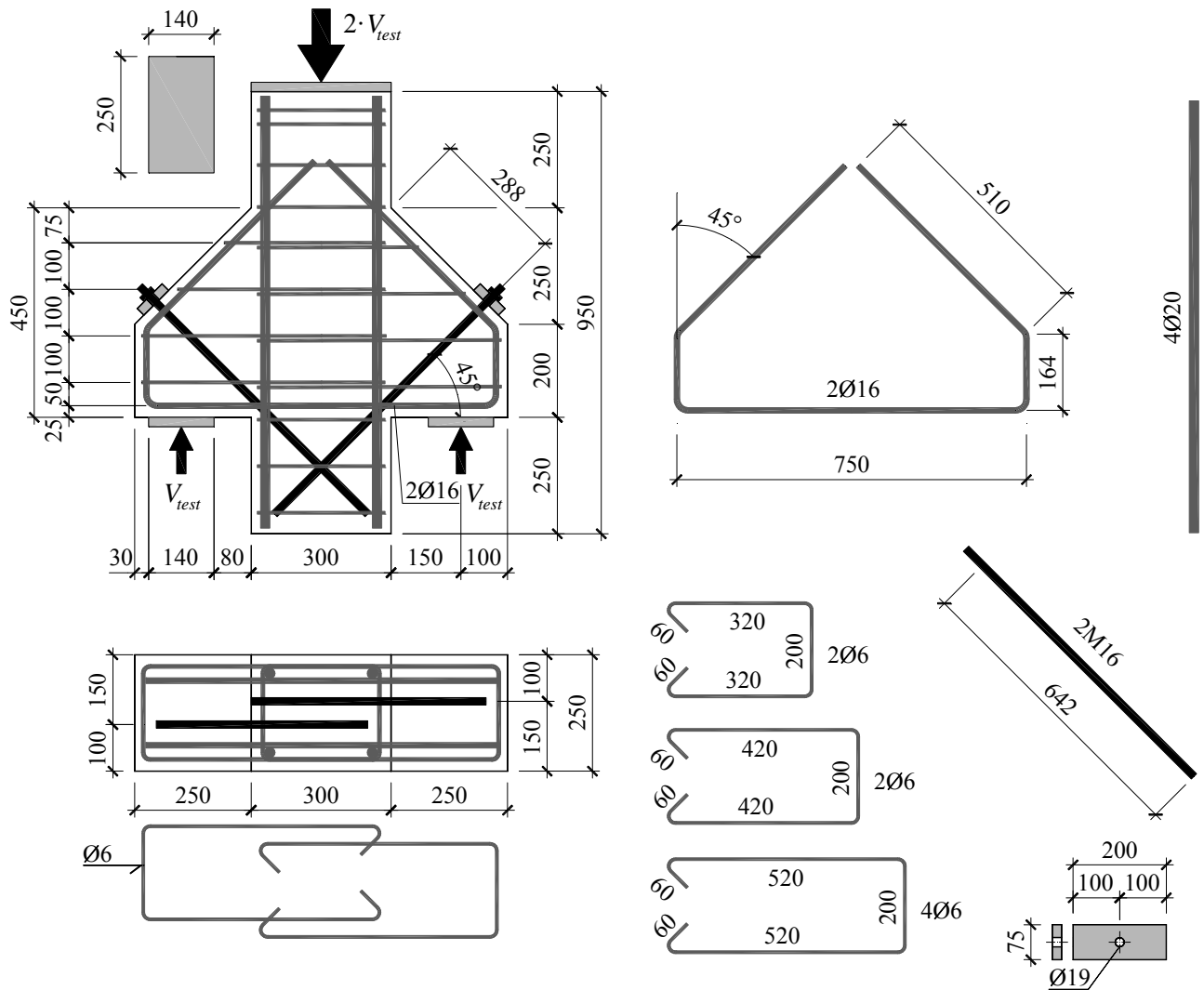

Zbrojenie modelu / Specimen's reinforcement

Wytrzymałość betonu na ściskanie / Compressive strength of concrete

$$f_{cm} = 45,1 \text{ MPa}$$

Moduł sprężystości podłużnej / Young's modulus

$$E_{cm} = 27,2 \text{ GPa}$$

Wytrzymałość betonu na rozciąganie przy rozłupywaniu / Tensile splitting strength of concrete

$$f_{ct,sp} = 3,7 \text{ MPa}$$

Gęstość betonu / Density of concrete

$$\rho = 2220 \text{ kg/m}^3$$

Charakterystyka zbrojenia / Characteristics of the reinforcement

Ø6

$$A_s = 28,07 \text{ mm}^2, f_{ym} = 385,6 \text{ MPa}, f_{tm} = 487,6 \text{ MPa}$$

Ø16

$$A_s = 200,53 \text{ mm}^2, f_{ym} = 533,6 \text{ MPa}, f_{tm} = 638,5 \text{ MPa}$$

Ø20

$$A_s = 310,67 \text{ mm}^2, f_{ym} = 541,0 \text{ MPa}, f_{tm} = 640,4 \text{ MPa}$$

M16

$$A_s = 141,07 \text{ mm}^2, f_{ym} = 870,1 \text{ MPa}, f_{tm} = 984,6 \text{ MPa}$$

Siła niszcząca / Failure force

$$V_{test} = 1150 \text{ kN}$$

D-I

Beton – odkształcenia po stronie S i N (długie tensometry) (ε_c) / Concrete – strains on S and N side (long gauges) (ε_c)

obciążenie wspornika corbel load	odkształcenie S S strain				odkształcenie N N strain			
	1	2	3	średnia/ average	4	5	6	średnia/ average
kN	‰	‰	‰	‰	‰	‰	‰	‰
0	0,000	0,000	0,000	0,000	0,000	0,000	0,000	0,000
0	0,000	0,000	0,000	0,000	-0,001	-0,002	-0,002	-0,002
50	-0,006	-0,010	-0,009	-0,008	-0,014	-0,017	-0,012	-0,014
100	-0,026	-0,050	-0,039	-0,038	-0,038	-0,051	-0,026	-0,038
150	-0,046	-0,082	-0,066	-0,065	-0,051	-0,089	-0,051	-0,064
200	-0,075	-0,141	-0,111	-0,109	-0,073	-0,149	-0,104	-0,109
250	-0,158	-0,215	-0,171	-0,181	-0,119	-0,222	-0,180	-0,174
300	-0,242	-0,281	-0,237	-0,253	-0,150	-0,291	-0,259	-0,233
350	-0,325	-0,357	-0,312	-0,331	-0,205	-0,372	-0,342	-0,306
400	-0,408	-0,431	-0,379	-0,406	-0,249	-0,448	-0,424	-0,374
50	-0,006	-0,124	-0,085	-0,072	-0,053	-0,116	-0,098	-0,089
300	-0,242	-0,345	-0,300	-0,296	-0,171	-0,354	-0,319	-0,281
400	-0,408	-0,473	-0,402	-0,428	-0,275	-0,483	-0,446	-0,401
50	-0,006	-0,134	-0,090	-0,077	-0,054	-0,126	-0,099	-0,093
300	-0,242	-0,372	-0,313	-0,309	-0,183	-0,372	-0,343	-0,299
400	-0,408	-0,483	-0,407	-0,433	-0,286	-0,499	-0,458	-0,414
50	-0,006	-0,137	-0,093	-0,079	-0,053	-0,133	-0,101	-0,096
300	-0,242	-0,380	-0,316	-0,313	-0,190	-0,381	-0,350	-0,307
400	-0,408	-0,488	-0,412	-0,436	-0,290	-0,504	-0,463	-0,419
400	-0,408	-0,495	-0,419	-0,441	-0,297	-0,511	-0,470	-0,426
400	-0,408	-0,523	-0,444	-0,458	-0,319	-0,541	-0,492	-0,451
400	-0,408	-0,525	-0,446	-0,460	-0,319	-0,542	-0,496	-0,452
400	-0,408	-0,528	-0,450	-0,462	-0,319	-0,544	-0,500	-0,454
400	-0,408	-0,527	-0,450	-0,462	-0,319	-0,544	-0,500	-0,454
450	-0,492	-0,578	-0,493	-0,521	-0,371	-0,597	-0,551	-0,506
500	-0,575	-0,634	-0,542	-0,584	-0,419	-0,659	-0,613	-0,564
500	-0,658	-0,688	-0,589	-0,645	-0,481	-0,720	-0,684	-0,628
600	-0,742	-0,782	-0,657	-0,727	-0,551	-0,782	-0,734	-0,689
650	-0,825	-0,839	-0,706	-0,790	-0,629	-0,858	-0,815	-0,767
700	-0,906	-0,907	-0,752	-0,855	-0,712	-0,942	-0,896	-0,850
750	-0,992	-0,970	-0,809	-0,924	-0,795	-1,025	-0,978	-0,933
750	-1,019	-0,986	-0,814	-0,940	-0,817	-1,052	-1,005	-0,958
800	-1,094	-1,036	-0,854	-0,995	-0,887	-1,119	-1,067	-1,024
850	-1,223	-1,109	-0,914	-1,082	-0,983	-1,220	-1,169	-1,124
900	-1,387	-1,190	-0,976	-1,184	-1,106	-1,346	-1,290	-1,247
950	-1,516	-1,259	-1,023	-1,266	-1,216	-1,446	-1,385	-1,349
1000	-1,652	-1,306	-1,052	-1,337	-1,064	-1,474	-1,567	-1,368
1000	-1,668	-1,324	-1,069	-1,354	-1,064	-1,477	-1,584	-1,375
1000	-1,682	-1,327	-1,074	-1,361	-1,064	-1,482	-1,595	-1,380
1000	-1,692	-1,329	-1,074	-1,365	-1,065	-1,483	-1,604	-1,384
1027	-1,815	-1,371	-1,110	-1,432	-1,119	-1,544	-1,691	-1,451
1050	-1,833	-1,381	-1,118	-1,444	-1,133	-1,555	-1,709	-1,466
1076	-1,921	-1,424	-1,146	-1,497	-1,149	-1,607	-1,760	-1,505
1100	-1,949	-1,445	-1,167	-1,520	-1,173	-1,632	-1,796	-1,534
1126	-1,937	-1,492	-1,071	-1,500	-1,203	-1,707	-1,872	-1,594
1150	-1,922	-1,513	-1,065	-1,500	-1,222	-1,746	-1,907	-1,625
1140	-0,664	-0,891	-0,515	-0,690	-1,101	-1,699	-1,832	-1,544
746		-0,597		-0,597	-0,747	-1,326	-1,467	-1,180

Beton – odkształcenia po stronie S i N (długie tensometry) (ϵ_c) / Concrete – strains on S and N side (long gauges) (ϵ_c)

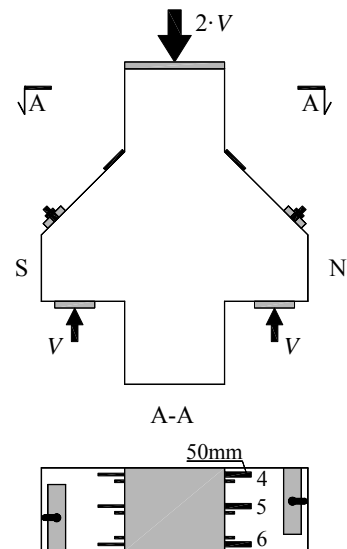
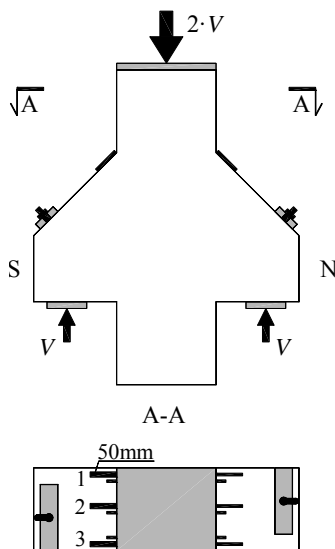
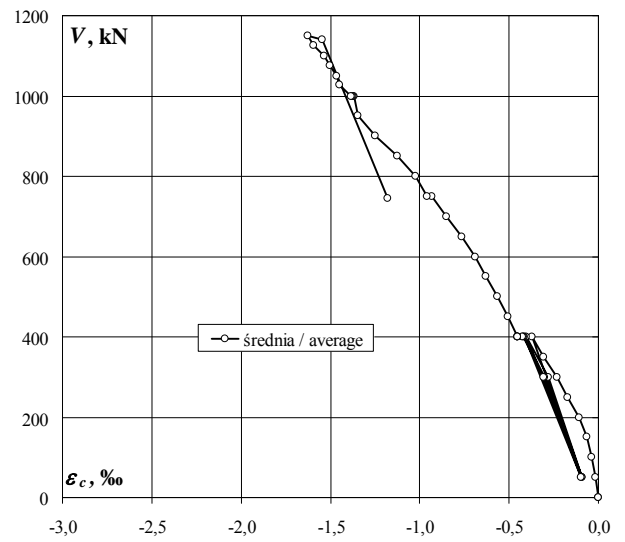
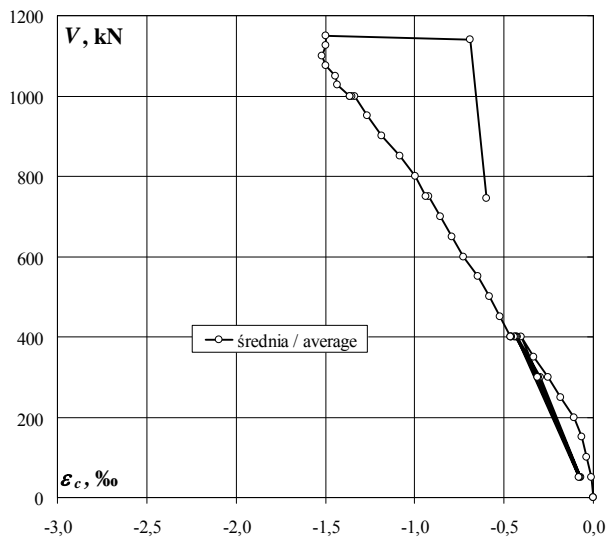
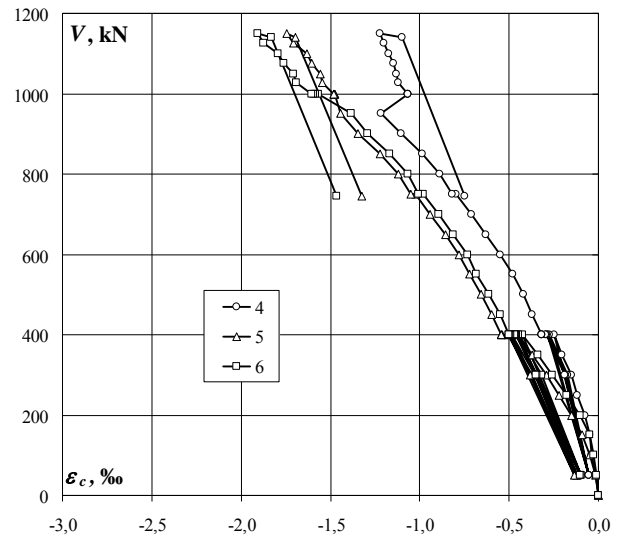
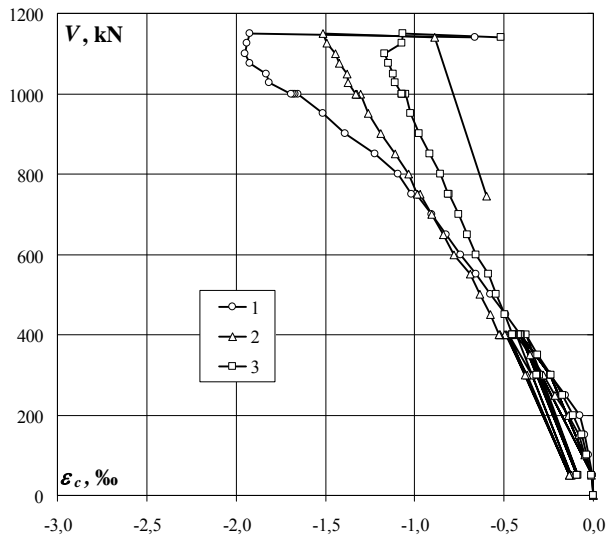

D-I

Beton – odkształcenia po stronie S i N (krótkie tensometry) (ε_c) / Concrete – strains on S and N side (short gauges) (ε_c)

obciążenie wspornika corbel load	odkształcenie S S strain				odkształcenie N N strain			
	7	8	9	średnia/ average	10	11	12	średnia/ average
kN	‰	‰	‰	‰	‰	‰	‰	‰
0	0,000	0,000	0,000	0,000	0,000	0,000	0,000	0,000
0	-0,001	-0,002	0,000	-0,001	0,000	0,000	-0,002	-0,001
50	0,002	-0,007	0,003	-0,001	-0,009	-0,019	-0,006	-0,011
100	0,000	-0,019	-0,005	-0,008	-0,022	-0,034	-0,016	-0,024
150	-0,016	-0,029	-0,030	-0,025	-0,033	-0,054	-0,033	-0,040
200	-0,051	-0,061	-0,090	-0,067	-0,059	-0,096	-0,052	-0,069
250	-0,121	-0,134	-0,166	-0,140	-0,108	-0,149	-0,109	-0,122
300	-0,219	-0,183	-0,266	-0,223	-0,146	-0,207	-0,186	-0,180
350	-0,339	-0,264	-0,365	-0,323	-0,189	-0,283	-0,248	-0,240
400	-0,436	-0,322	-0,463	-0,407	-0,259	-0,363	-0,337	-0,320
50	-0,056	-0,056	-0,089	-0,067	-0,037	-0,088	-0,052	-0,059
300	-0,329	-0,237	-0,359	-0,308	-0,160	-0,266	-0,226	-0,217
400	-0,490	-0,343	-0,507	-0,447	-0,282	-0,395	-0,356	-0,344
50	-0,063	-0,065	-0,102	-0,077	-0,043	-0,100	-0,062	-0,068
300	-0,355	-0,266	-0,381	-0,334	-0,174	-0,292	-0,252	-0,239
400	-0,502	-0,356	-0,520	-0,459	-0,291	-0,412	-0,369	-0,357
50	-0,063	-0,068	-0,106	-0,079	-0,045	-0,102	-0,067	-0,071
300	-0,360	-0,271	-0,386	-0,339	-0,178	-0,304	-0,258	-0,247
400	-0,506	-0,361	-0,527	-0,465	-0,294	-0,418	-0,375	-0,362
400	-0,516	-0,369	-0,536	-0,474	-0,293	-0,425	-0,384	-0,367
400	-0,605	-0,426	-0,604	-0,545	-0,341	-0,471	-0,457	-0,423
400	-0,606	-0,427	-0,604	-0,546	-0,339	-0,471	-0,452	-0,421
400	-0,605	-0,429	-0,604	-0,546	-0,338	-0,471	-0,450	-0,420
400	-0,606	-0,429	-0,604	-0,546	-0,338	-0,472	-0,450	-0,420
450	-0,660	-0,467	-0,665	-0,597	-0,394	-0,529	-0,494	-0,472
500	-0,736	-0,508	-0,734	-0,659	-0,441	-0,583	-0,550	-0,525
550	-0,813	-0,569	-0,812	-0,731	-0,498	-0,649	-0,621	-0,589
600	-1,180	-0,836	-1,217	-1,078	-0,570	-0,715	-0,674	-0,653
650	-1,338	-0,930	-1,365	-1,211	-0,636	-0,792	-0,762	-0,730
700	-1,468	-1,032	-1,500	-1,333	-0,727	-0,878	-0,835	-0,813
750	-1,594	-1,125	-1,638	-1,452	-0,815	-0,971	-0,927	-0,904
750	-1,636	-1,161	-1,692	-1,496	-0,847	-0,995	-0,952	-0,931
800	-1,734	-1,223	-1,794	-1,584	-0,909	-1,067	-1,027	-1,001
850	-1,873	-1,327	-1,962	-1,721	-1,028	-1,184	-1,126	-1,113
900	-2,037	-1,447	-2,153	-1,879	-1,175	-1,322	-1,255	-1,251
950	-2,177	-1,546	-2,318	-2,014	-1,330	-1,457	-1,376	-1,388
1000	-2,263	-1,625	-2,421	-2,103	-1,762	-1,970	-1,947	-1,893
1000	-2,284	-1,647	-2,443	-2,125	-1,813	-2,025	-2,023	-1,954
1000	-2,290	-1,660	-2,460	-2,137	-1,853	-2,067	-2,086	-2,002
1000	-2,291	-1,665	-2,465	-2,140	-1,870	-2,084	-2,110	-2,021
1027	-2,356	-1,765	-2,561	-2,227	-2,071	-2,275	-2,362	-2,236
1050	-2,368	-1,781	-2,572	-2,240	-2,091	-2,301	-2,392	-2,261
1076	-2,364	-1,867	-2,602	-2,278	-2,231	-2,448	-2,582	-2,420
1100	-2,385	-1,898	-2,635	-2,306	-2,279	-2,500	-2,640	-2,473
1126	-1,585	-2,048	-2,664	-2,099	-2,494	-2,773	-3,010	-2,759
1150	-1,388	-2,101	-2,660	-2,050	-2,567	-2,883	-3,107	-2,852
1140	-0,259	-0,922	-1,667	-0,949	-2,650	-3,157	-3,034	-2,947
746	-0,328	-0,766	-1,172	-0,755	-2,103	-2,663	-2,569	-2,445

Beton – odkształcenia po stronie S i N (krótkie tensometry) (ϵ_c) / Concrete – strains on S and N side (short gauges) (ϵ_c)

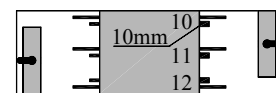
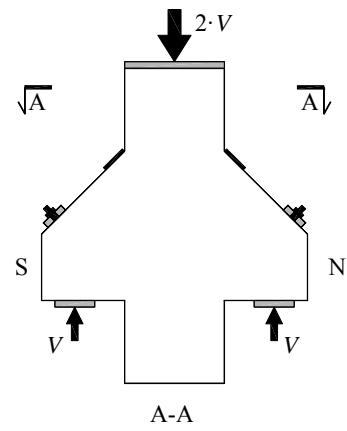
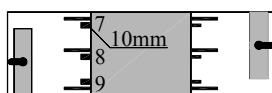
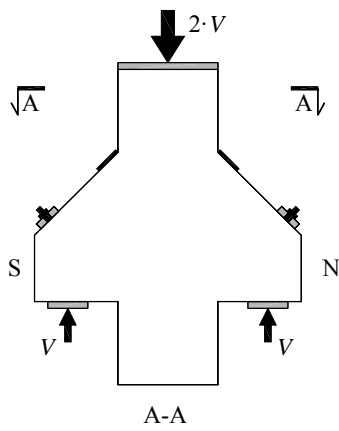
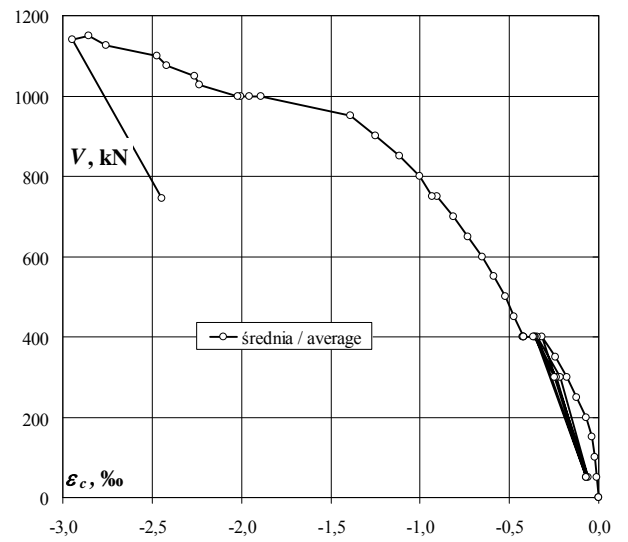
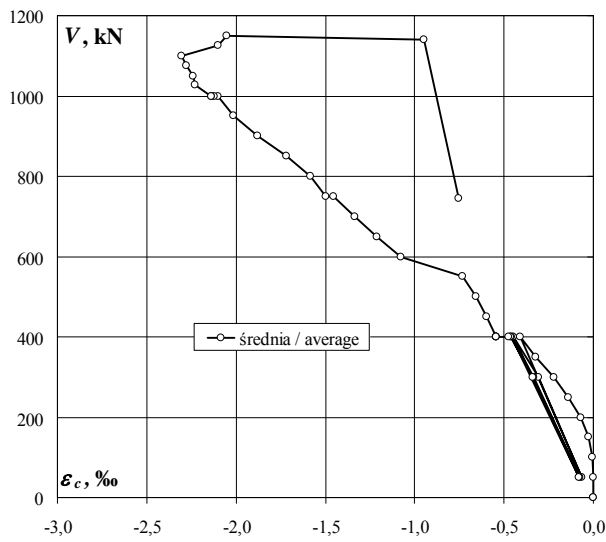
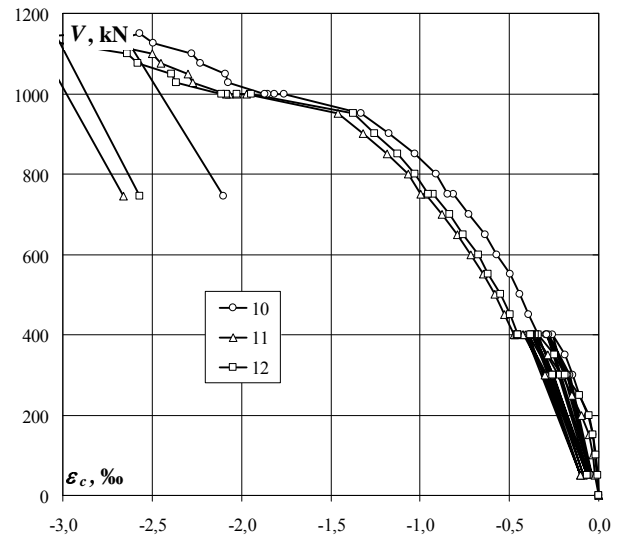
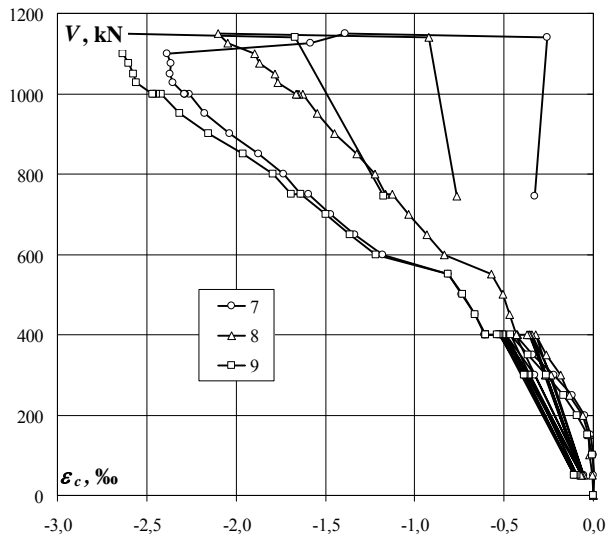

D-I

Zbrojenie główne – odkształcenia po stronie S i N (ε_s) / Main reinforcement – strains on S and N side (ε_s)

obciążenie wspornika corbel load	odkształcenie S S strain			odkształcenie N N strain		
	1	2	średnia/ average	3	4	średnia/ average
kN	‰	‰	‰	‰	‰	‰
0	0,000	0,000	0,000	0,000	0,000	0,000
0	0,002	0,002	0,002	-0,001	0,003	0,001
50	0,065	0,075	0,070	0,064	0,093	0,079
100	0,176	0,193	0,185	0,160	0,227	0,194
150	0,370	0,388	0,379	0,303	0,461	0,382
200	0,575	0,603	0,589	0,496	0,698	0,597
250	0,765	0,788	0,777	0,785	0,946	0,866
300	0,919	0,933	0,926	1,012	1,124	1,068
350	1,064	1,064	1,064	1,171	1,291	1,231
400	1,175	1,182	1,179	1,287	1,441	1,364
50	0,407	0,397	0,402	0,409	0,519	0,464
300	1,017	1,028	1,023	1,111	1,239	1,175
400	1,225	1,235	1,230	1,330	1,481	1,406
50	0,418	0,413	0,416	0,416	0,526	0,471
300	1,045	1,063	1,054	1,131	1,269	1,200
400	1,245	1,259	1,252	1,348	1,503	1,426
50	0,425	0,425	0,425	0,426	0,535	0,481
300	1,056	1,078	1,067	1,145	1,281	1,213
400	1,253	1,272	1,263	1,364	1,521	1,443
400	1,257	1,278	1,268	1,365	1,528	1,447
400		1,291	1,291	1,327	1,459	1,393
400		1,291	1,291	1,328	1,460	1,394
400		1,292	1,292	1,327	1,460	1,394
400		1,292	1,292	1,327	1,460	1,394
450		1,379	1,379	1,417	1,564	1,491
500		1,473	1,473	1,507	1,664	1,586
550		1,567	1,567	1,583	1,766	1,675
600		1,857	1,857	1,669	1,864	1,767
650		1,950	1,950	1,788	1,961	1,875
700		2,040	2,040	1,927	2,068	1,998
750		2,144	2,144	2,058	2,180	2,119
750		2,177	2,177	2,112	2,217	2,165
800		2,289	2,289	2,226	2,328	2,277
850		2,439	2,439	2,379	2,481	2,430
900		2,608	2,608	2,563	2,644	2,604
950		2,744	2,744	2,712	2,770	2,741
1000		3,487	3,487	3,090	3,303	3,197
1000		3,667	3,667	3,141	3,434	3,288
1000		3,852	3,852	3,152	3,458	3,305
1000		3,919	3,919	3,160	3,464	3,312
1027		4,321	4,321	3,622	3,522	3,572
1050		4,395	4,395	3,650	3,541	3,596
1076		6,749	6,749	4,441	3,880	4,161
1100		6,976	6,976	4,564	3,933	4,249
1126		13,518	13,518		4,443	4,443
1150		15,772	15,772		4,684	4,684
1140					5,428	5,428
746					4,823	4,823

Zbrojenie główne – odkształcenia po stronie S i N (ϵ_s) / Main reinforcement – strains on S and N side (ϵ_s)

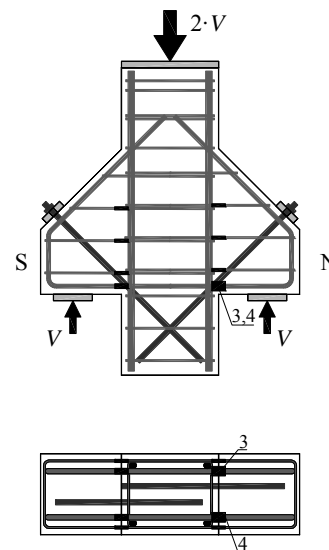
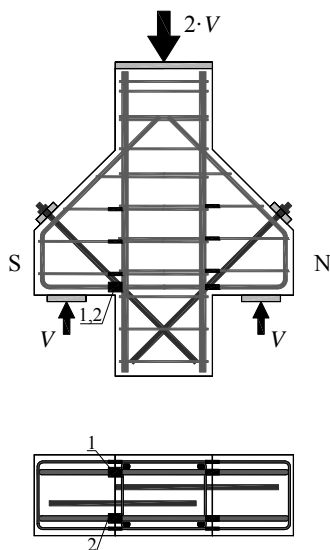
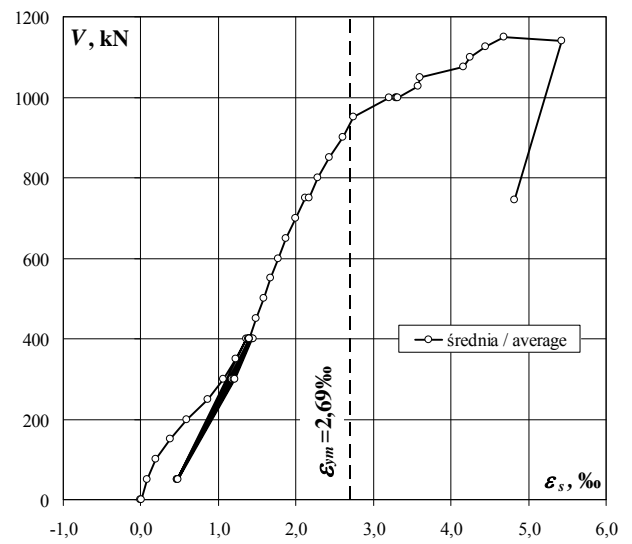
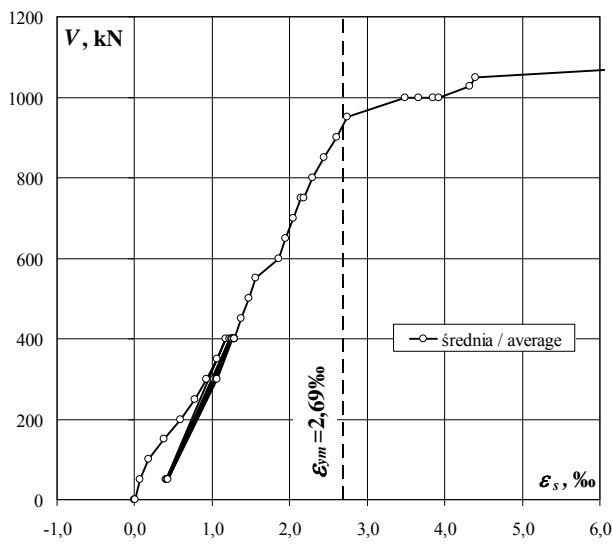
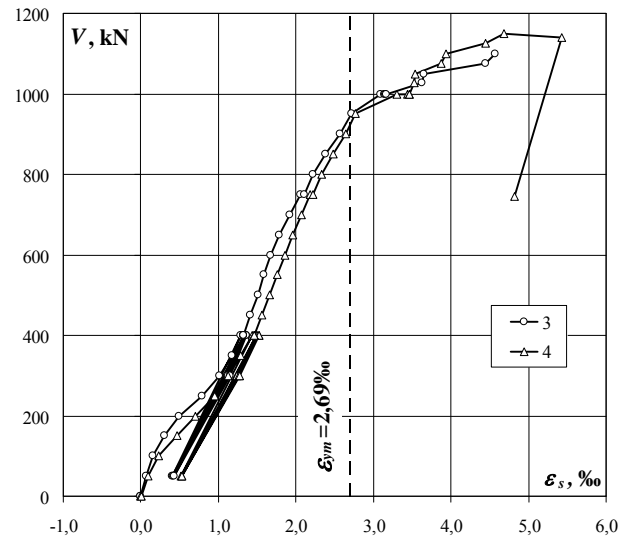
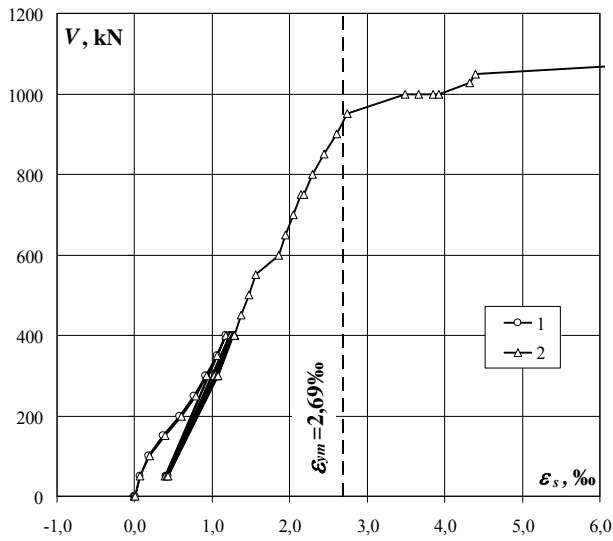

D-I

Strzeżenie 1 – odkształcenia po stronie S i N (ϵ_s) / Stirrup 1 – strains on S and N side (ϵ_s)

obciążenie wspornika corbel load	odkształcenie S S strain			odkształcenie N N strain		
	5	6	średnia/ average	7	8	średnia/ average
kN	‰	‰	‰	‰	‰	‰
0	0,000	0,000	0,000	0,000	0,000	0,000
0	0,002	0,002	0,002	0,005	0,003	0,004
50	0,037	0,029	0,033	0,053	0,022	0,038
100	0,129	0,082	0,106	0,168	0,064	0,116
150	0,302	0,301	0,302	0,330	0,182	0,256
200	0,474	0,400	0,437	0,260	0,353	0,307
250	0,593	0,639	0,616		0,463	0,463
300	0,701	0,567	0,634		0,588	0,588
350	0,808	0,846	0,827		0,730	0,730
400	0,866	0,865	0,866		0,834	0,834
50	0,271	0,165	0,218		0,430	0,430
300	0,723	0,679	0,701		0,755	0,755
400	0,871	1,093	0,982		0,898	0,898
50	0,220	0,186	0,203		0,456	0,456
300	0,686	0,640	0,663		0,800	0,800
400	0,840	0,911	0,876		0,924	0,924
50	0,203	0,274	0,239		0,465	0,465
300	0,674	0,738	0,706		0,823	0,823
400	0,831	0,929	0,880		0,943	0,943
400	0,838	0,929	0,884		0,959	0,959
400	0,861	0,956	0,909		0,981	0,981
400	0,857	0,955	0,906		0,981	0,981
400	0,858	0,957	0,908		0,981	0,981
400	0,858	0,958	0,908		0,982	0,982
450	0,918	1,053	0,986		1,018	1,018
500	0,988	1,119	1,054		1,058	1,058
550	1,038	1,158	1,098		1,108	1,108
600	0,852	1,282	1,067		1,149	1,149
650	0,867	1,308	1,088		1,195	1,195
700	0,892	1,348	1,120		1,238	1,238
750	0,944	1,395	1,170		1,293	1,293
750	0,958	1,389	1,174		1,322	1,322
800	1,016	1,430	1,223		1,364	1,364
850	1,109	1,402	1,256		1,437	1,437
900	1,221	1,412	1,317		1,522	1,522
950	1,258	1,404	1,331		1,580	1,580
1000	1,336	1,400	1,368		1,768	1,768
1000	1,341	1,404	1,373		1,806	1,806
1000	1,341	1,403	1,372		1,804	1,804
1000	1,342	1,390	1,366		1,804	1,804
1027	1,365	1,358	1,362		1,794	1,794
1050	1,382	1,363	1,373		1,795	1,795
1076	1,452	1,400	1,426		1,819	1,819
1100	1,474	1,409	1,442		1,831	1,831
1126	1,596	1,470	1,533		1,819	1,819
1150	1,642	1,489	1,566		1,838	1,838
1140	1,655	1,549	1,602		1,727	1,727
746	1,425	0,839	1,132		1,243	1,243

Strzemię 1 – odkształcenia po stronie S i N (ϵ_s) / Stirrup 1 – strains on S and N side (ϵ_s)

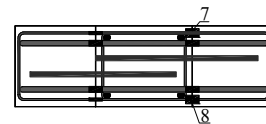
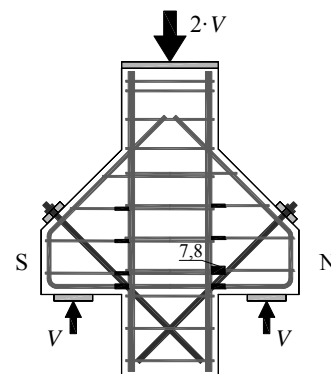
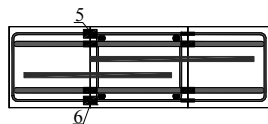
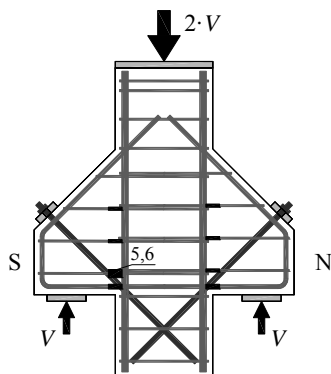
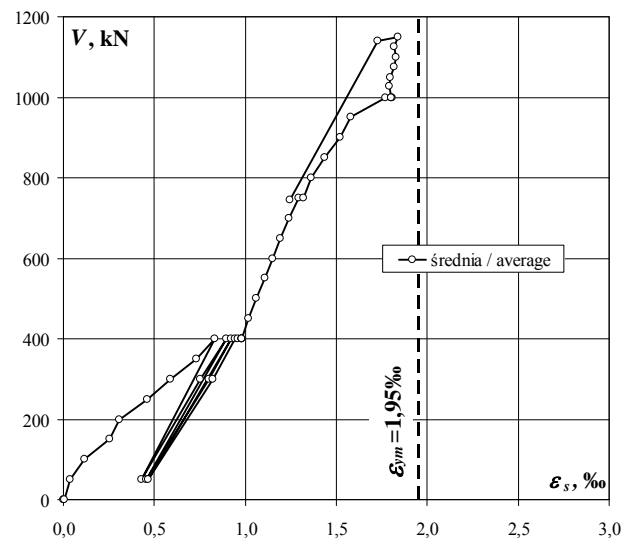
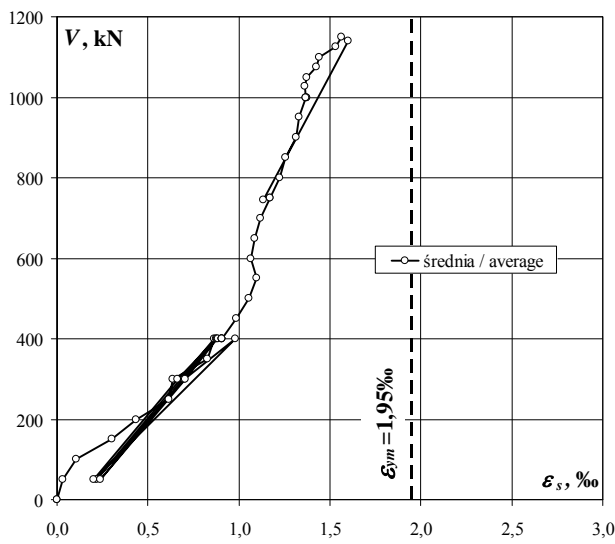
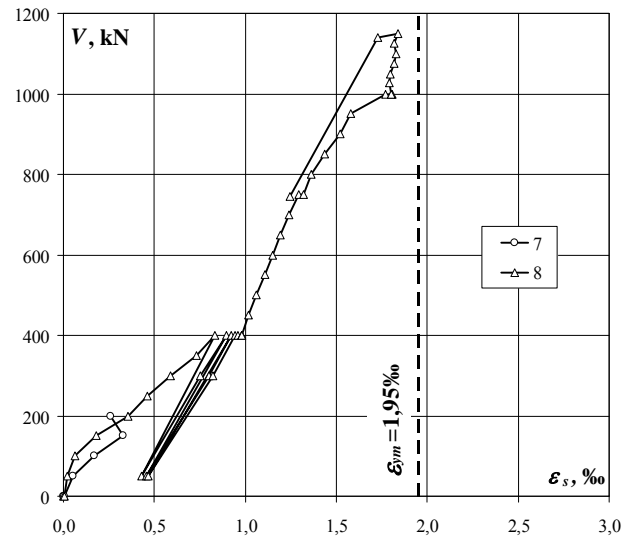
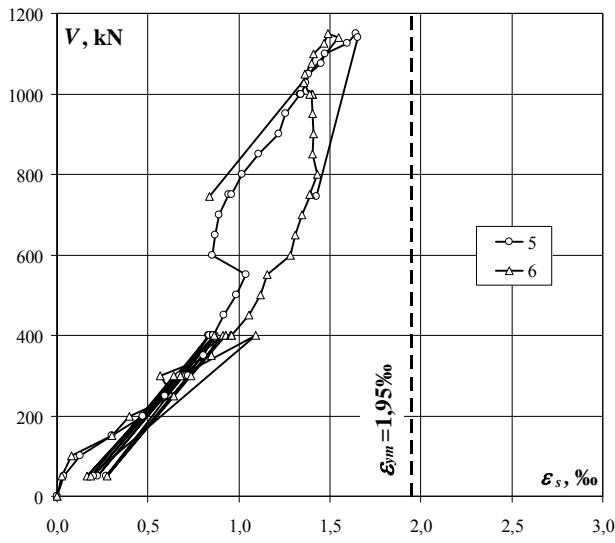

D-I

Strzeżenie 2 – odkształcenia po stronie S i N (ϵ_s) / Stirrup 2 – strains on S and N side (ϵ_s)

obciążenie wspornika corbel load	odkształcenie S S strain			odkształcenie N N strain		
	9	10	średnia/ average	11	12	średnia/ average
kN	‰	‰	‰	‰	‰	‰
0	0,000	0,000	0,000	0,000	0,000	0,000
0	0,000	0,000	0,000	0,000	0,000	0,000
50	0,015	0,011	0,013	0,009	0,010	0,010
100	0,041	0,024	0,033	0,039	0,029	0,034
150	0,147	0,059	0,103	0,109	0,099	0,104
200	0,287	0,123	0,205	0,279	0,226	0,253
250	0,441	0,213	0,327	0,415	0,467	0,441
300	0,530	0,312	0,421	0,435	0,654	0,545
350	0,564	0,416	0,490	0,427		0,427
400	0,612	0,557	0,585	0,360		0,360
50	0,231	0,356	0,294	0,070		0,070
300	0,494	0,574	0,534	0,230		0,230
400	0,604	0,681	0,643	0,249		0,249
50	0,220	0,380	0,300			
300	0,492	0,622	0,557			
400	0,599	0,704	0,652			
50	0,213	0,376	0,295			
300	0,485	0,636	0,561			
400	0,592	0,712	0,652			
400	0,599	0,708	0,654			
400	0,591	0,654	0,623			
400	0,589	0,650	0,620			
400	0,589	0,650	0,620			
400	0,588	0,647	0,618			
450	0,626	0,693	0,660			
500	0,677	0,741	0,709			
550	0,711	0,800	0,756			
600	0,834	0,569	0,702			
650	0,906	0,561	0,734			
700	0,971	0,568	0,770			
750	1,035	0,587	0,811			
750	1,050	0,607	0,829			
800	1,086	0,626	0,856			
850	1,154	0,670	0,912			
900	1,217	0,745	0,981			
950	1,279	0,783	1,031			
1000	1,329	0,924	1,127			
1000	1,366	1,004	1,185			
1000	1,386	1,087	1,237			
1000	1,393	1,147	1,270			
1027	1,447	1,537	1,492			
1050	1,459	1,566	1,513			
1076	1,508	2,686	2,097			
1100	1,531	2,725	2,128			
1126	1,639	3,114	2,377			
1150	1,670	3,197	2,434			
1140	1,571	5,518	3,545			
746		5,125	5,125			

Strzemię 2 – odkształcenia po stronie S i N (ϵ_s) / Stirrup 2 – strains on S and N side (ϵ_s)

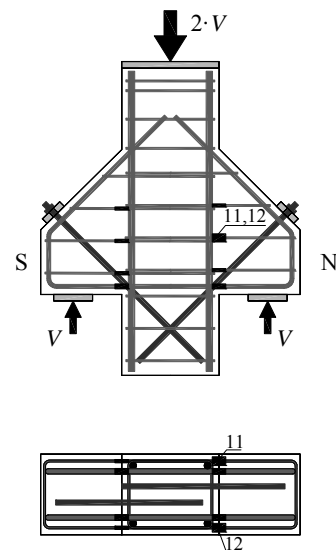
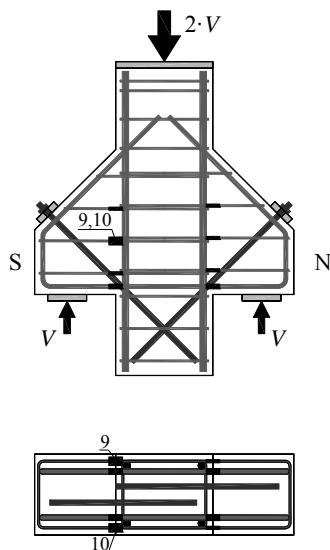
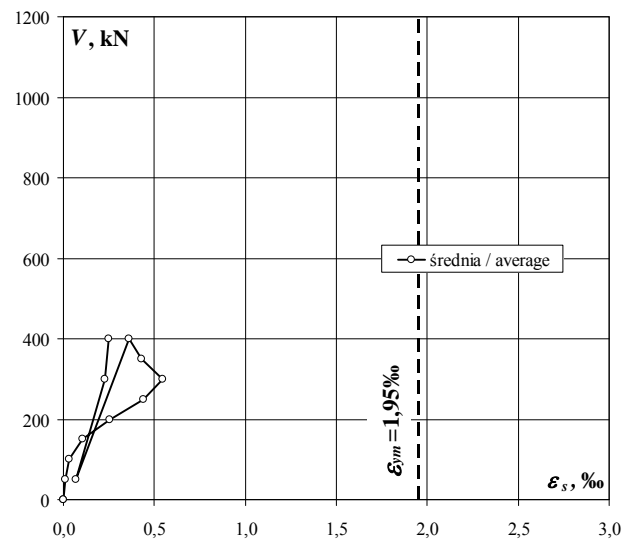
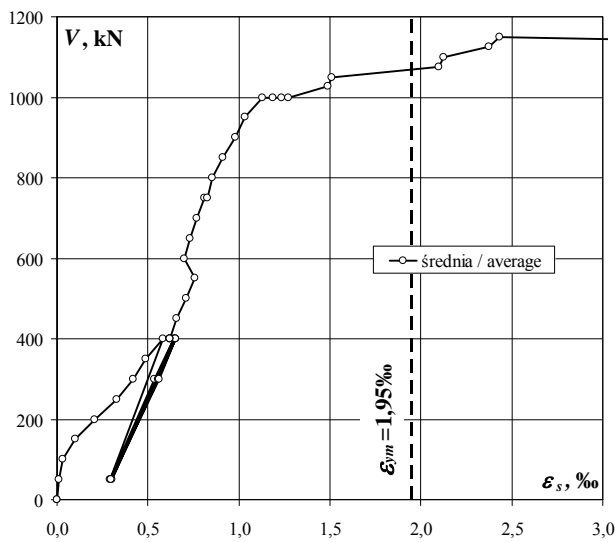
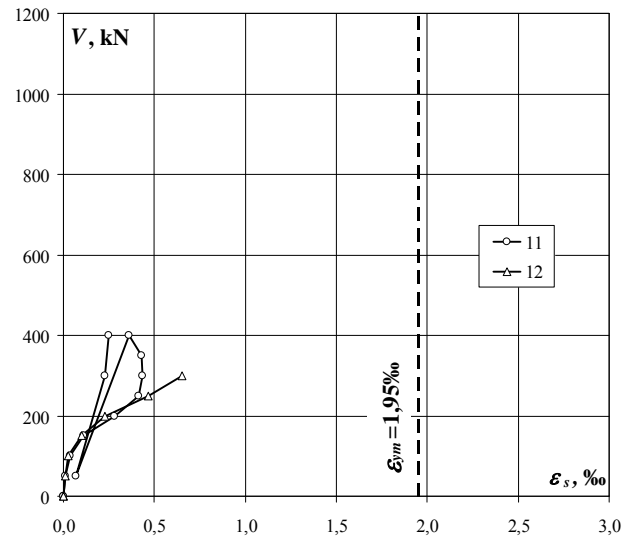
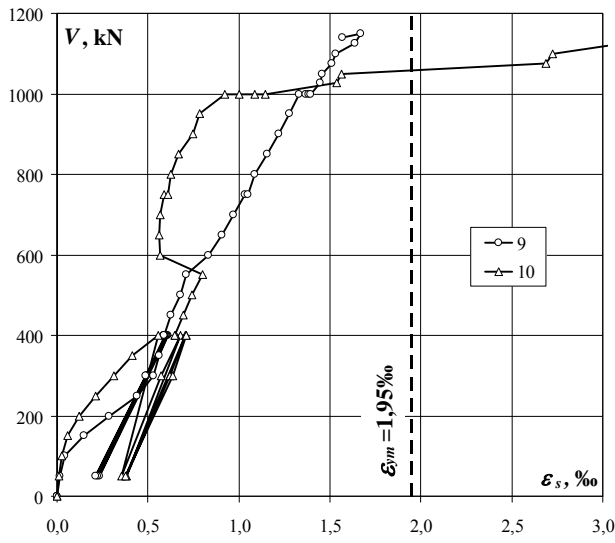

D-I

Strzemię 3 – odkształcenia po stronie S i N (ε_s) / Stirrup 3 – strains on S and N side (ε_s)

obciążenie wspornika corbel load	odkształcenie S S strain			odkształcenie N N strain		
	13	14	średnia/ average	15	16	średnia/ average
	%	%	%	%	%	%
0	0,000	0,000	0,000	0,000	0,000	0,000
0	0,000	-0,003	-0,002	0,000	0,000	0,000
50	0,000	-0,008	-0,004	-0,007	-0,008	-0,008
100	-0,003	-0,018	-0,011	-0,011	-0,017	-0,014
150	0,005	-0,016	-0,006	-0,004	-0,019	-0,012
200	0,022	0,007	0,015	0,021	-0,004	0,009
250	0,043	0,035	0,039	0,081	0,063	0,072
300	0,071	0,133	0,102	0,145	0,088	0,117
350	0,102	0,195	0,149	0,200	0,126	0,163
400	0,132	0,258	0,195	0,233	0,218	0,226
50	0,147	0,161	0,154	0,183	0,154	0,169
300	0,239	0,267	0,253	0,237	0,228	0,233
400	0,296	0,306	0,301	0,271	0,280	0,276
50	0,172	0,179	0,176	0,199	0,196	0,198
300	0,291	0,304	0,298	0,265	0,270	0,268
400	0,328	0,324	0,326	0,292	0,330	0,311
50	0,187	0,193	0,190	0,207	0,207	0,207
300	0,302	0,310	0,306	0,277	0,294	0,286
400	0,346	0,338	0,342	0,313	0,351	0,332
400	0,366	0,351	0,359	0,322	0,367	0,345
400	0,429	0,391	0,410	0,333	0,408	0,371
400	0,430	0,391	0,411	0,333	0,407	0,370
400	0,429	0,412	0,421	0,332	0,408	0,370
400	0,428	0,401	0,415	0,332	0,408	0,370
450	0,444	0,408	0,426	0,342	0,430	0,386
500	0,479	0,425	0,452	0,358	0,485	0,422
550	0,574	0,470	0,522	0,396	0,598	0,497
600	0,678	0,510	0,594	0,424	0,703	0,564
650	0,768		0,768	0,486	0,837	0,662
700	0,862		0,862	0,577	1,005	0,791
750	0,940		0,940	0,628	1,185	0,907
750	0,983		0,983	0,643	1,288	0,966
800	1,037		1,037	0,687	1,404	1,046
850	1,145		1,145	0,747	1,626	1,187
900	1,253		1,253	0,800	1,866	1,333
950	1,318		1,318	0,854	2,305	1,580
1000	1,353		1,353	1,164	1,990	1,577
1000	1,358		1,358	1,211	1,964	1,588
1000	1,354		1,354	1,235	1,949	1,592
1000	1,352		1,352	1,247	1,943	1,595
1027	1,274		1,274	1,330	1,879	1,605
1050	1,259		1,259	1,341	1,881	1,611
1076				1,394	1,866	1,630
1100				1,409	1,873	1,641
1126				1,510	1,875	1,693
1150				1,554	1,888	1,721
1140				1,603	1,876	1,740
746				1,261	1,578	1,420

Strzemię 3 – odkształcenia po stronie S i N (ϵ_s) / Stirrup 3 – strains on S and N side (ϵ_s)

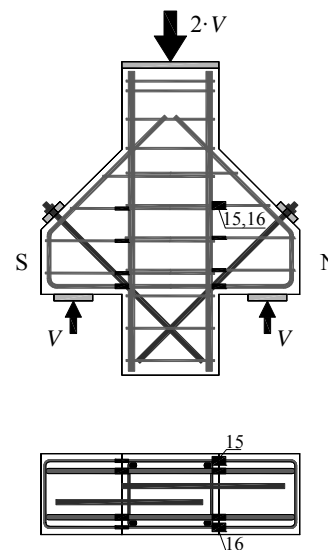
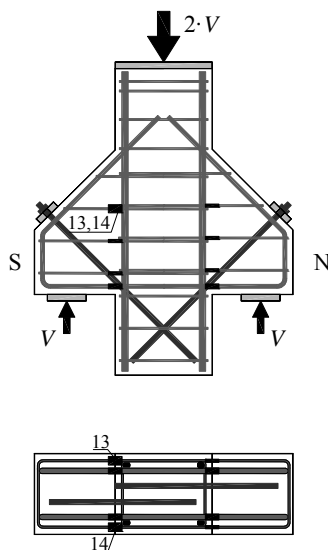
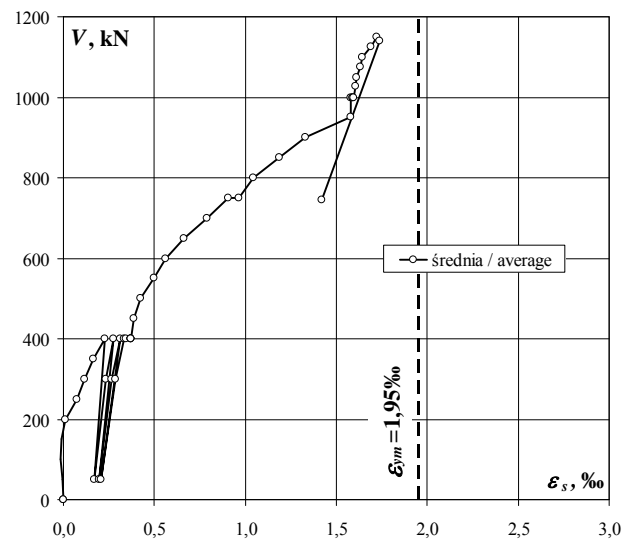
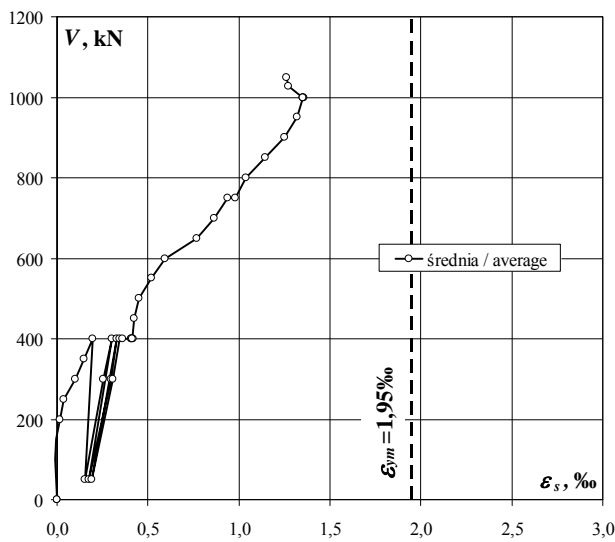
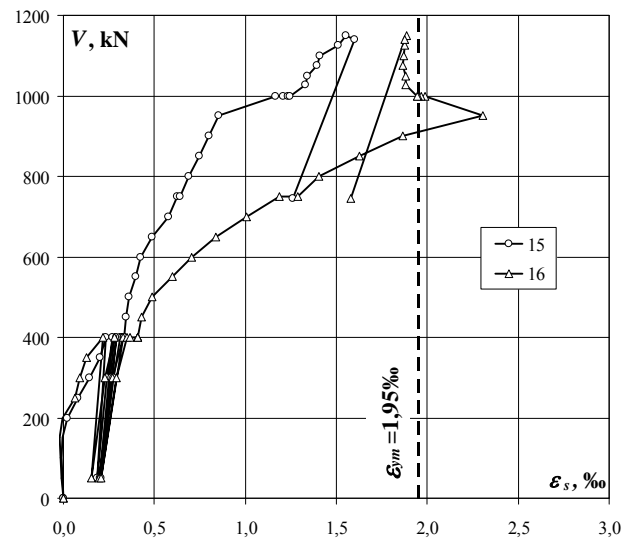
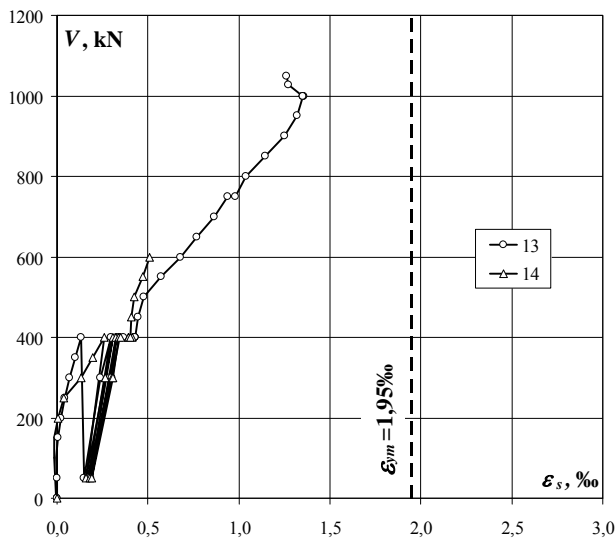

D-I

Szerokość rozwarcia rys / Crack width

obciążenie wspornika corbel load	Numer rysy / Crack number									
	1	2	3	4	5	6	7	8	9	10
	mm	mm	mm	mm	mm	mm	mm	mm	mm	mm
250	0,07	0,10	0,10	0,15						
300	0,10	0,15	0,10	0,20	0,10					
350	0,10	0,17	0,12	0,25	0,15					
400	0,10	0,20	0,17	0,30	0,15					
50	0,00	0,10	0,05	0,15	0,05					
300	0,10	0,15	0,15	0,30	0,15					
400	0,10	0,20	0,20	0,35	0,20					
50	0,00	0,10	0,10	0,15	0,05					
300	0,10	0,20	0,20	0,30	0,17					
400	0,10	0,20	0,20	0,35	0,20					
50	0,05	0,10	0,15	0,20	0,05					
300	0,20	0,20	0,20	0,30	0,10					
450	0,15	0,20	0,20	0,35	0,20					
500	0,15	0,25	0,25	0,35	0,25					
550	0,15	0,30	0,30	0,40	0,25					
600	0,15	0,30	0,30	0,40	0,30	0,10		0,15		
650	0,15	0,35	0,35	0,40	0,30	0,15		0,20		
700	0,15	0,35	0,35	0,40	0,30	0,17	0,30	0,25		
750	0,15	0,35	0,35	0,40	0,40	0,20	0,30	0,25		
800	0,15	0,40	0,40	0,40	0,37	0,20	0,35	0,25		
850	0,17	0,40	0,40	0,35	0,40	0,25	0,40	0,30	0,45	
900	0,20	0,40	0,40	0,35	0,40	0,30	0,45	0,30	0,50	
950	0,20	0,40	0,40	0,35	0,45	0,30	0,40	0,30	0,55	
1000	0,25	0,55	0,40	0,40	0,50	0,30	0,50	0,30	0,60	0,40
1050	0,25	0,55	0,45	0,45	0,60	0,35	0,60	0,25	0,70	0,50
1100	0,25	0,60	0,45	0,45	0,65	0,35	0,65	0,20	0,75	0,60
1150			0,45	0,50			0,70	0,15		0,70

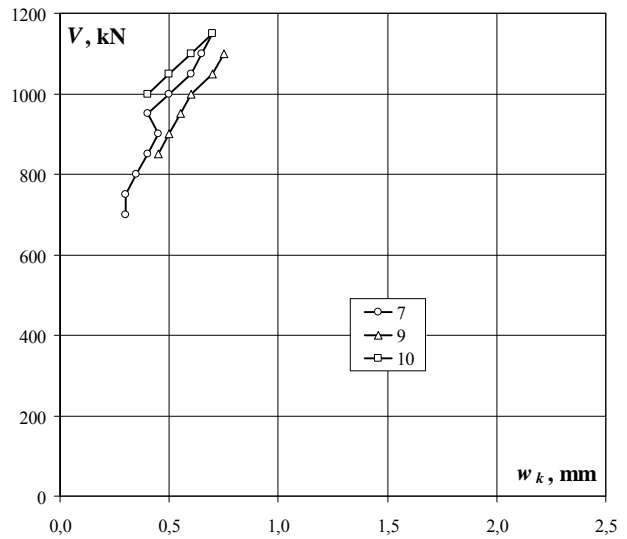
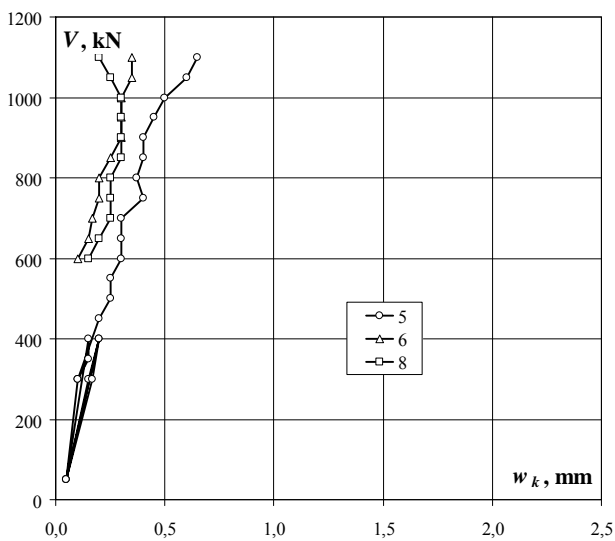
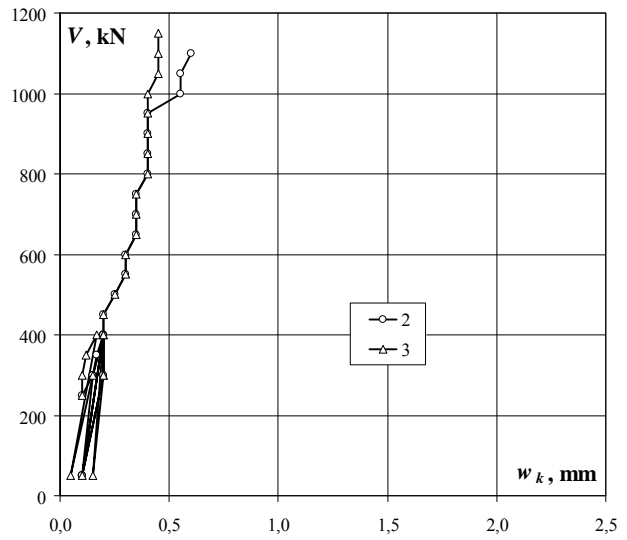
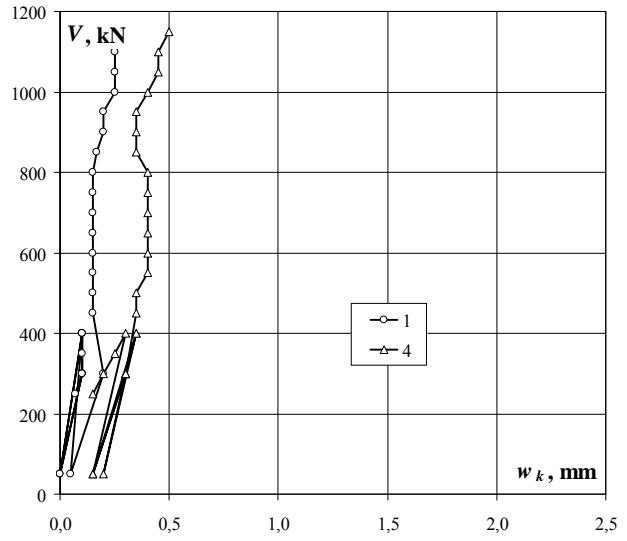

Układ rys przy sile 600kN / Crack pattern at 600kN

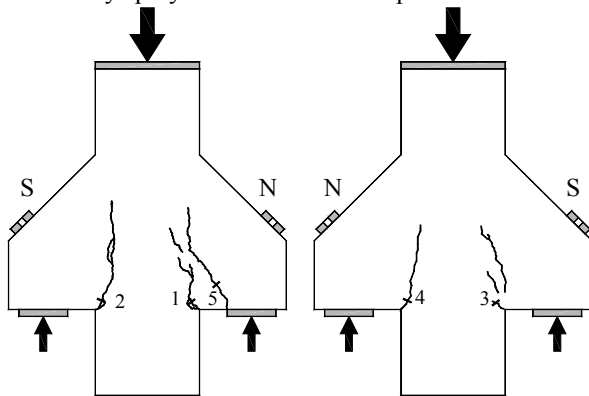

Układ rys przy sile 800kN / Crack pattern at 800kN

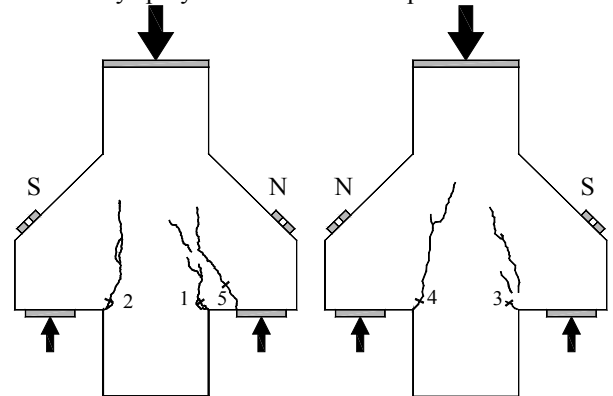

Układ rys przy sile 1200kN / Crack pattern at 1200kN

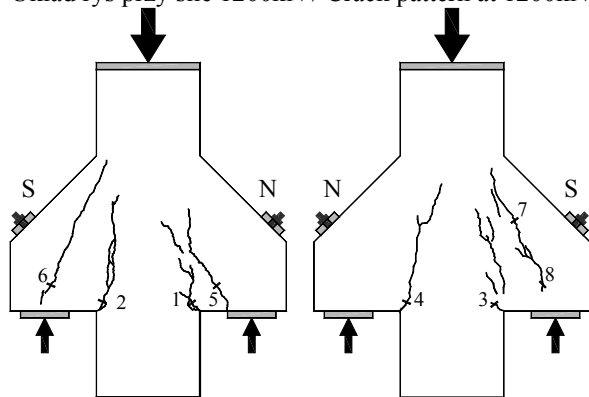

Układ rys przy sile 1400kN / Crack pattern at 1400kN

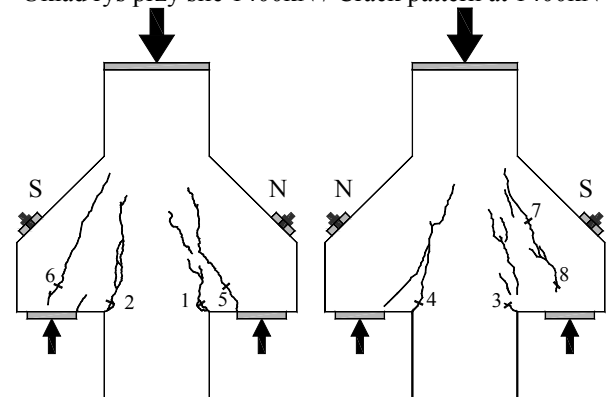

Układ rys przy sile 1600kN / Crack pattern at 1600kN

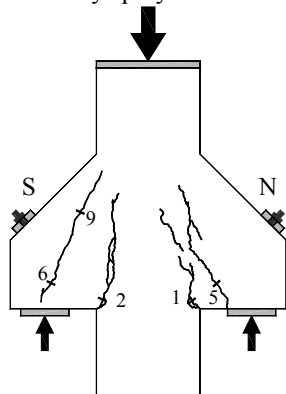

Układ rys przy sile 1900kN / Crack pattern at 1900kN

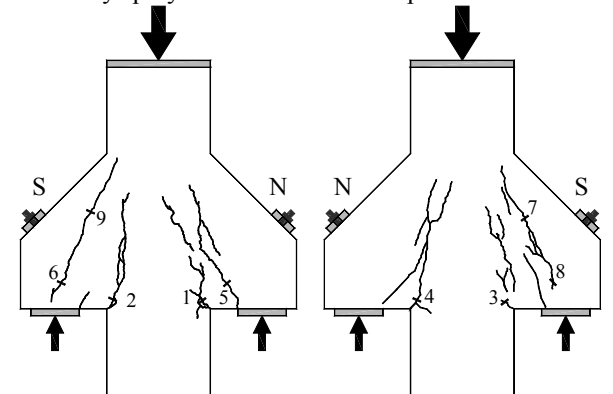

Układ rys przy sile 2000kN / Crack pattern at 2000kN

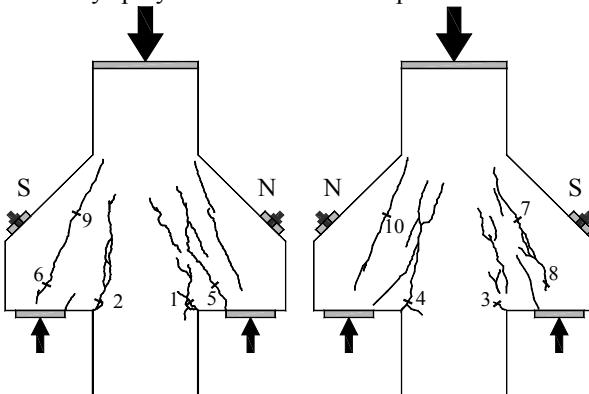

Układ rys przy sile 2300kN / Crack pattern at 2300kN

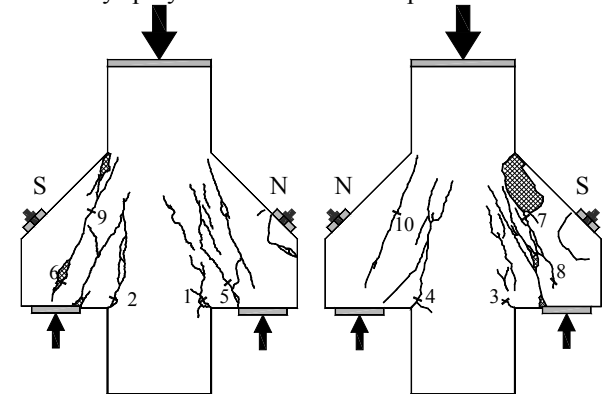

D-I

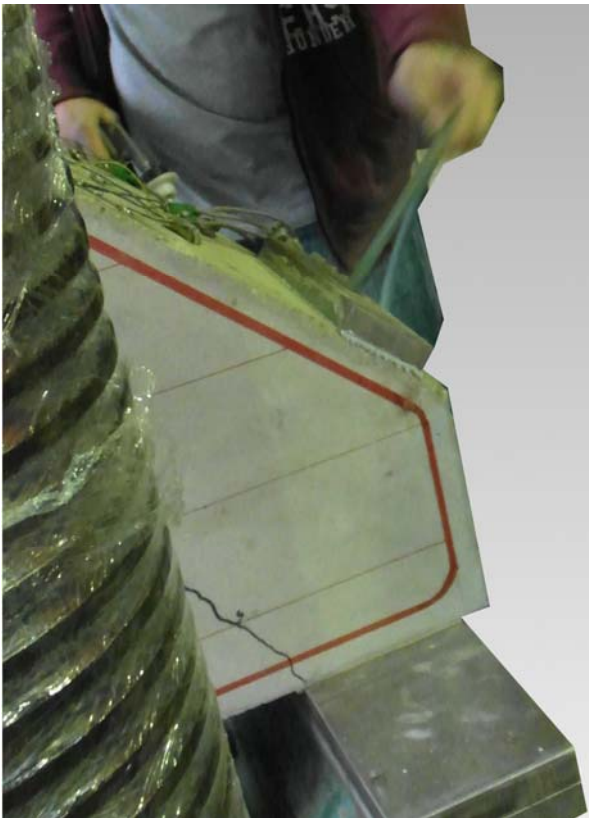

Czyszczenie otworu sprężonym powietrzem
Cleaning the hole by compressed air



Wkręcanie pręta
Screwing the rod

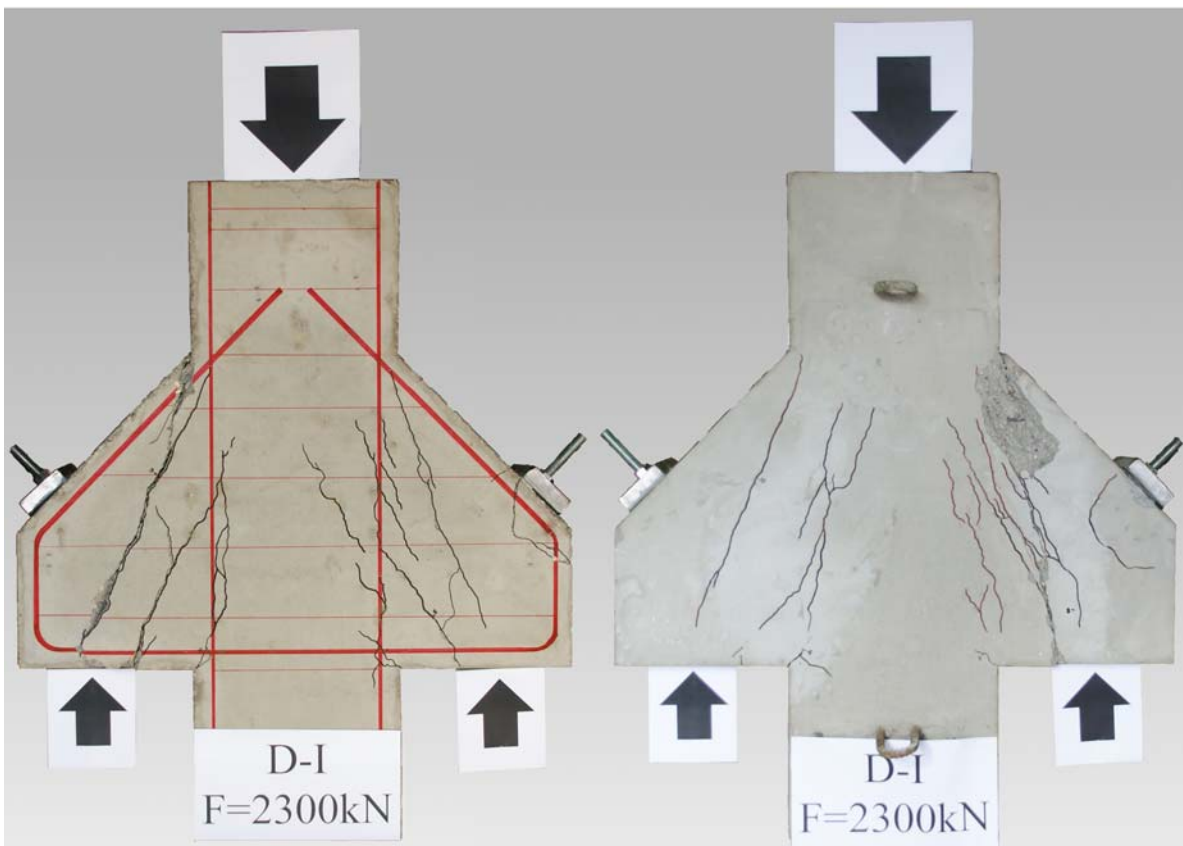

Wspornik po zniszczeniu / Corbel after failure

Przemieszczenie słupa względem wsporników / The relative displacement between the column and the corbels

obciążenie wspornika corbel load	Przemieszczenie / Przemieszczenie	
	mm	
0	0,00	
50	0,02	
100	0,03	
150	0,06	
200	0,10	
250	0,14	
300	0,18	
350	0,22	
400	0,26	
50	0,11	
300	0,23	
400	0,28	
50	0,12	
300	0,24	
400	0,29	
50	0,12	
300	0,25	
400	0,30	
400	wzmocnienie / strengthening 0,33	
450	0,35	
500	0,37	
550	0,41	
600	0,49	
650	0,53	
700	0,58	
750	0,63	
750	0,65	
800	0,68	
850	0,73	
850	0,76	
900	0,80	
950	0,86	
1000	1,01	
1000	1,11	
1050	1,16	
1050	1,20	
1100	1,28	
1100	1,33	
1150	1,37	

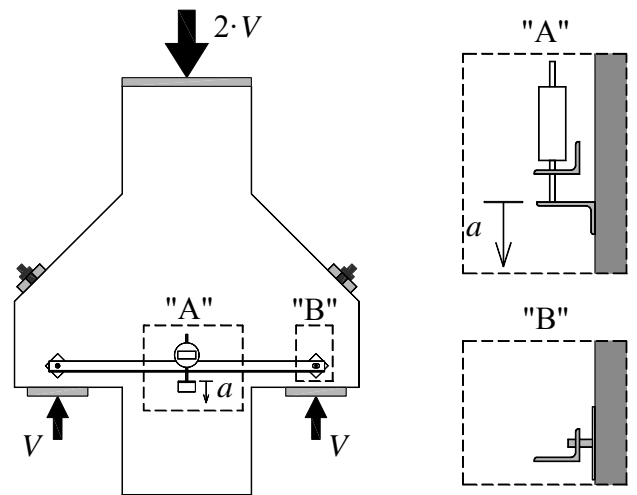
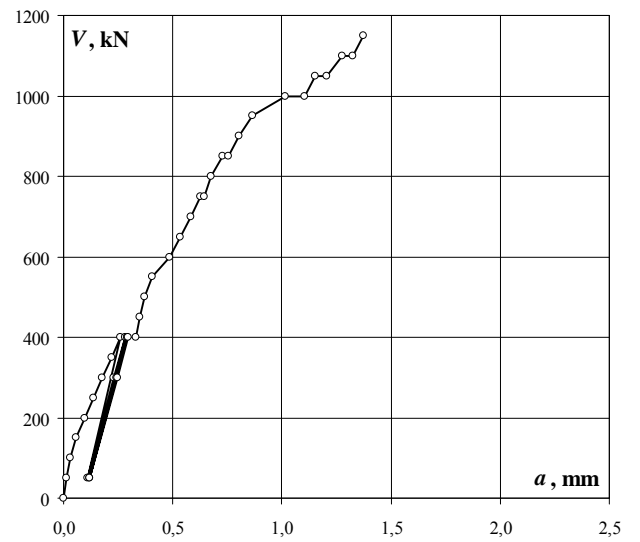

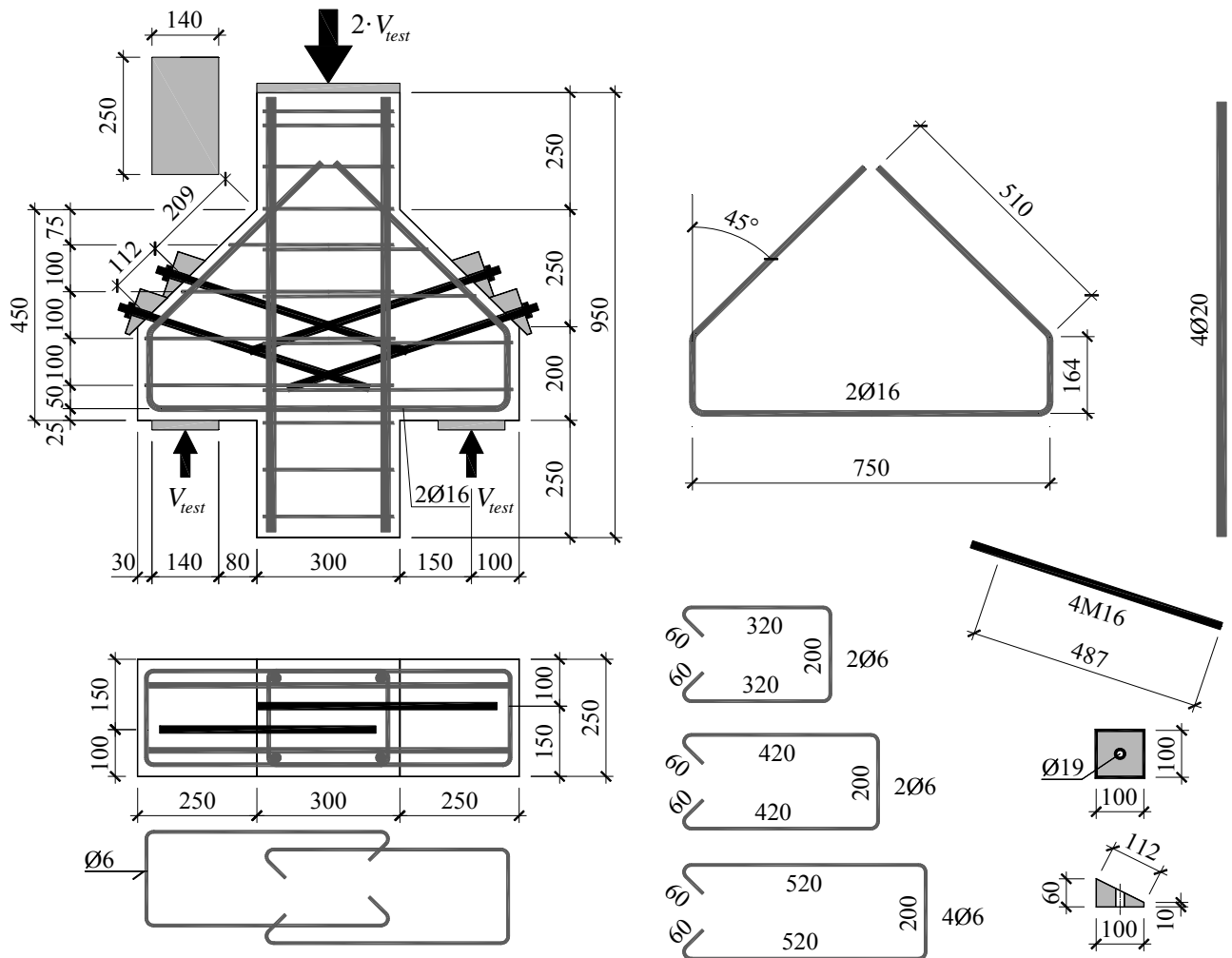

Zbrojenie modelu / Specimen's reinforcement

Wytrzymałość betonu na ściskanie / Compressive strength of concrete

$$f_{cm} = 45,1\text{MPa}$$

Moduł sprężystości podłużnej / Young's modulus

$$E_{cm} = 27,2\text{GPa}$$

Wytrzymałość betonu na rozciąganie przy rozłupywaniu / Tensile splitting strength of concrete

$$f_{ct,sp} = 3,7\text{MPa}$$

Gęstość betonu / Density of concrete

$$\rho = 2220\text{kg/m}^3$$

Charakterystyka zbrojenia / Characteristics of the reinforcement

Ø6

$$A_s = 28,07\text{mm}^2, f_{ym} = 385,6\text{MPa}, f_{tm} = 487,6\text{MPa}$$

Ø16

$$A_s = 200,53\text{mm}^2, f_{ym} = 533,6\text{MPa}, f_{tm} = 638,5\text{MPa}$$

Ø20

$$A_s = 310,67\text{mm}^2, f_{ym} = 541,0\text{MPa}, f_{tm} = 640,4\text{MPa}$$

M16

$$A_s = 141,07\text{mm}^2, f_{ym} = 870,1\text{MPa}, f_{tm} = 984,6\text{MPa}$$

Siła niszcząca / Failure force

$$V_{test} = 1208\text{kN}$$

D-II

Beton – odkształcenia po stronie S i N (długie tensometry) (ε_c) / Concrete – strains on S and N side (long gauges) (ε_c)

obciążenie wspornika corbel load	odkształcenie S S strain				odkształcenie N N strain			
	1	2	3	średnia/ average	4	5	6	średnia/ average
kN	‰	‰	‰	‰	‰	‰	‰	‰
0	0,000	0,000	0,000	0,000	0,000	0,000	0,000	0,000
0	0,000	-0,002	-0,002	-0,001	0,000	0,000	0,000	0,000
100	-0,027	-0,031	-0,014	-0,024	-0,014	-0,033	-0,013	-0,020
50	-0,016	-0,018	-0,006	-0,013	-0,008	-0,017	-0,006	-0,010
100	-0,028	-0,033	-0,014	-0,025	-0,015	-0,033	-0,013	-0,020
150	-0,048	-0,064	-0,032	-0,048	-0,025	-0,053	-0,020	-0,033
200	-0,076	-0,109	-0,055	-0,080	-0,050	-0,088	-0,048	-0,062
250	-0,123	-0,162	-0,104	-0,130	-0,089	-0,117	-0,101	-0,102
250	-0,131	-0,172	-0,113	-0,139	-0,096	-0,146	-0,108	-0,117
250	-0,132	-0,174	-0,116	-0,141	-0,098	-0,151	-0,112	-0,120
300	-0,173	-0,231	-0,172	-0,192	-0,145	-0,206	-0,171	-0,174
350	-0,235	-0,311	-0,236	-0,261	-0,207	-0,276	-0,257	-0,247
350	-0,249	-0,325	-0,252	-0,275	-0,226	-0,296	-0,290	-0,271
400	-0,294	-0,369	-0,301	-0,321	-0,294	-0,387	-0,466	-0,382
50	-0,055	-0,095	-0,049	-0,066	0,033	-0,040	-0,043	-0,017
300	-0,206	-0,285	-0,216	-0,236	-0,151	-0,267	-0,346	-0,255
400	-0,312	-0,392	-0,319	-0,341	-0,259	-0,378	-0,504	-0,380
50	-0,055	-0,099	-0,052	-0,069	0,048	-0,034	-0,044	-0,010
50	-0,055	-0,099	-0,052	-0,069	0,048	-0,034	-0,044	-0,010
300	-0,218	-0,299	-0,224	-0,247	-0,127	-0,258	-0,372	-0,252
400	-0,319	-0,400	-0,327	-0,349	-0,248	-0,376	-0,512	-0,379
50	-0,054	-0,098	-0,052	-0,068	0,050	-0,033	-0,044	-0,009
300	-0,220	-0,301	-0,224	-0,248	-0,118	-0,255	-0,376	-0,250
400	-0,324	-0,407	-0,331	-0,354	-0,247	-0,376	-0,519	-0,381
400	-0,359	-0,444	-0,359	-0,387	-0,277	-0,404	-0,576	-0,419
450	-0,406	-0,491	-0,404	-0,434	-0,330	-0,455	-0,636	-0,474
500	-0,460	-0,538	-0,454	-0,484	-0,386	-0,505	-0,708	-0,533
550	-0,599	-0,677	-0,595	-0,624	-0,445	-0,563	-0,786	-0,598
600	-0,693	-0,773	-0,686	-0,717	-0,518	-0,625	-0,868	-0,670
650	-0,785	-0,859	-0,767	-0,804	-0,601	-0,698	-0,969	-0,756
700	-0,880	-0,954	-0,857	-0,897	-0,689	-0,777	-1,075	-0,847
750	-0,988	-1,053	-0,947	-0,996	-0,785	-0,865	-1,193	-0,948
750	-1,024	-1,090	-0,979	-1,031	-0,818	-0,893	-1,240	-0,984
800	-1,095	-1,162	-1,044	-1,100	-0,882	-0,953	-1,315	-1,050
800	-1,136	-1,199	-1,076	-1,137	-0,919	-0,982	-1,364	-1,088
850	-1,215	-1,277	-1,144	-1,212	-0,994	-1,053	-1,452	-1,166
850	-1,260	-1,322	-1,177	-1,253	-1,031	-1,086	-1,510	-1,209
900	-1,340	-1,397	-1,244	-1,327	-1,106	-1,155	-1,596	-1,286
900	-1,399	-1,462	-1,284	-1,382	-1,146	-1,200	-1,665	-1,337
950	-1,476	-1,532	-1,348	-1,452	-1,212	-1,268	-1,744	-1,408
950	-1,513	-1,564	-1,372	-1,483	-1,229	-1,294	-1,786	-1,436
1000	-1,611	-1,663	-1,443	-1,572	-1,288	-1,372	-1,897	-1,519
1000	-1,662	-1,710	-1,468	-1,613	-1,300	-1,404	-1,950	-1,551
1050	-1,748	-1,795	-1,536	-1,693	-1,366	-1,474	-2,026	-1,622
1050	-1,818	-1,868	-1,575	-1,754	-1,398	-1,522	-2,078	-1,666
1100	-1,925	-1,977	-1,645	-1,849	-1,489	-1,612	-2,156	-1,752
1100	-2,158	-2,209	-1,756	-2,041	-1,624	-1,759	-2,255	-1,879
1127	-2,199	-2,249	-1,786	-2,078	-1,661	-1,795	-2,284	-1,913
1150	-2,347	-2,473	-1,860	-2,227	-1,763	-1,920	-2,339	-2,007
1173	-2,375	-2,511	-1,884	-2,257	-1,795	-1,950	-2,363	-2,036
1201	-2,390	-2,549	-1,899	-2,279	-1,820	-1,979	-2,381	-2,060
1208	-2,383	-2,591	-1,899	-2,291	-1,839	-2,008	-2,397	-2,081
701	-0,778	-0,891		-0,835	-1,110	-1,539	-1,758	-1,469

Beton – odkształcenia po stronie S i N (długie tensometry) (ϵ_c) / Concrete – strains on S and N side (long gauges) (ϵ_c)

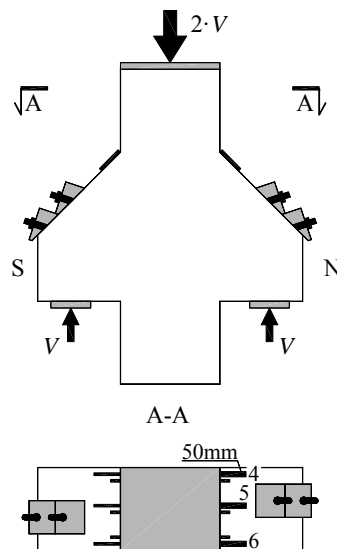
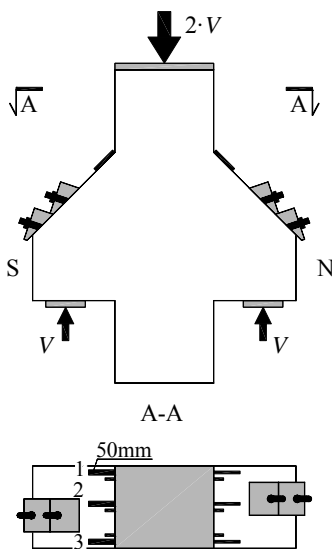
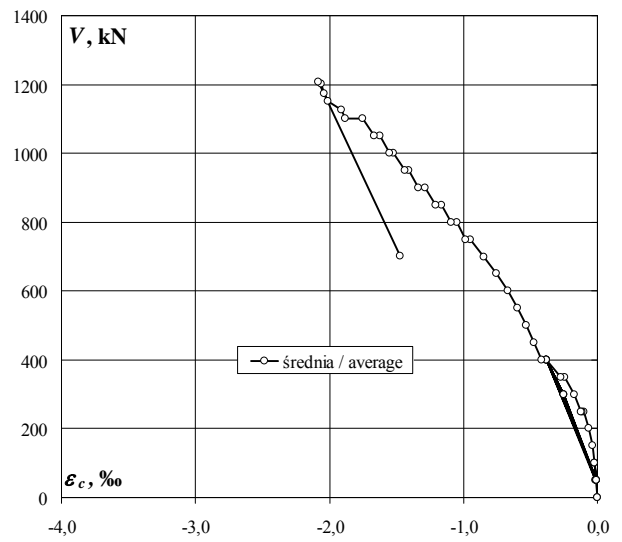
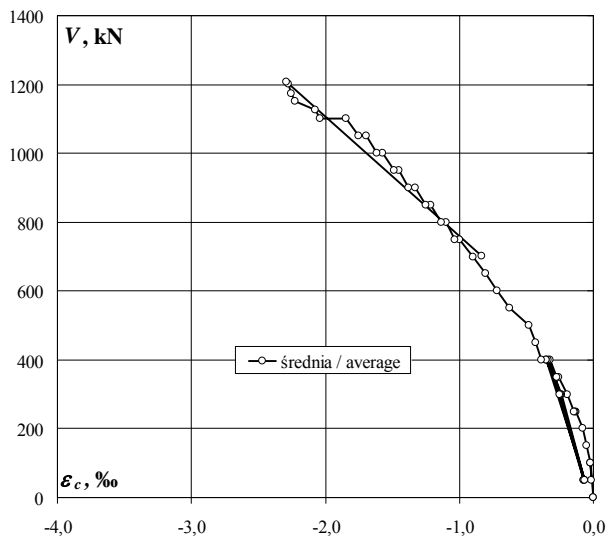
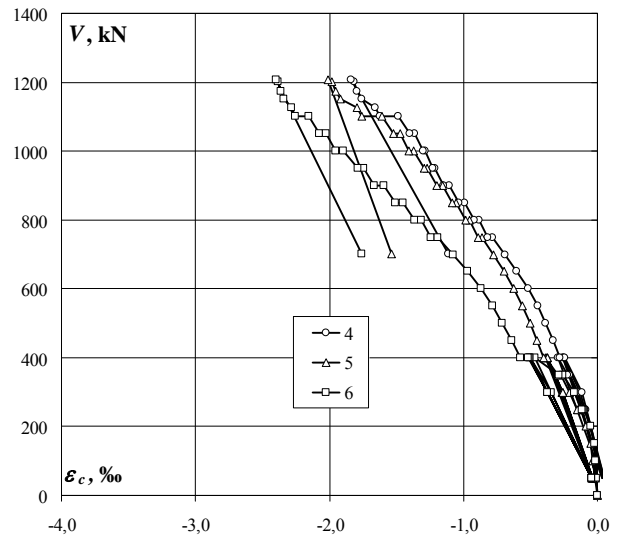
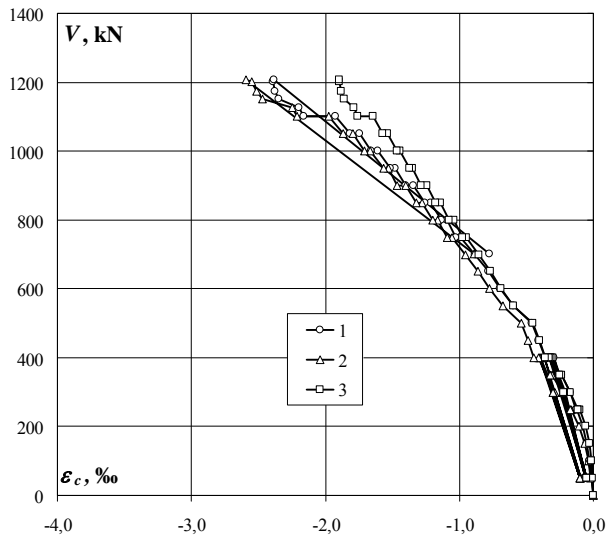

D-II

Beton – odkształcenia po stronie S i N (krótkie tensometry) (ε_c) / Concrete – strains on S and N side (short gauges) (ε_c)

obciążenie wspornika corbel load	odkształcenie S S strain				odkształcenie N N strain			
	7	8	9	średnia/ average	10	11	12	średnia/ average
kN	‰	‰	‰	‰	‰	‰	‰	‰
0	0,000	0,000	0,000	0,000	0,000	0,000	0,000	0,000
0	0,000	0,002	0,000	0,001	0,000	0,000	0,000	0,000
100	-0,005	-0,009	0,000	-0,005	-0,009	-0,016	0,000	-0,008
50	0,000	0,000	0,002	0,001	-0,005	-0,008	0,002	-0,004
100	-0,004	-0,007	0,000	-0,004	-0,008	-0,016	0,000	-0,008
150	-0,016	-0,021	-0,009	-0,015	-0,016	-0,033	-0,007	-0,019
200	-0,045	-0,046	-0,040	-0,044	-0,035	-0,061	-0,029	-0,042
250	-0,086	-0,063	-0,099	-0,083	-0,063	-0,101	-0,077	-0,080
250	-0,094	-0,069	-0,109	-0,091	-0,073	-0,110	-0,085	-0,089
250	-0,099	-0,074	-0,113	-0,095	-0,073	-0,111	-0,087	-0,090
300	-0,147	-0,119	-0,175	-0,147	-0,114	-0,158	-0,150	-0,141
350	-0,223	-0,187	-0,276	-0,229	-0,172	-0,223	-0,235	-0,210
350	-0,253	-0,209	-0,306	-0,256	-0,191	-0,240	-0,268	-0,233
400	-0,305	-0,253	-0,381	-0,313	-0,317	-0,416	-0,510	-0,414
50	-0,042	-0,024	-0,063	-0,043	-0,021	-0,084	-0,083	-0,063
300	-0,198	-0,163	-0,259	-0,207	-0,203	-0,318	-0,402	-0,308
400	-0,327	-0,270	-0,411	-0,336	-0,315	-0,446	-0,567	-0,443
50	-0,048	-0,032	-0,070	-0,050	-0,015	-0,083	-0,089	-0,062
50	-0,048	-0,032	-0,070	-0,050	-0,015	-0,083	-0,089	-0,062
300	-0,216	-0,171	-0,277	-0,221	-0,203	-0,327	-0,430	-0,320
400	-0,340	-0,278	-0,424	-0,347	-0,317	-0,454	-0,586	-0,452
50	-0,053	-0,035	-0,075	-0,054	-0,014	-0,082	-0,092	-0,063
300	-0,224	-0,179	-0,284	-0,229	-0,203	-0,331	-0,440	-0,325
400	-0,351	-0,287	-0,433	-0,357	-0,319	-0,459	-0,595	-0,458
400	-0,433	-0,585	-0,510	-0,509	-0,378	-0,527	-0,674	-0,526
450	-0,486	-0,629	-0,577	-0,564	-0,423	-0,574	-0,734	-0,577
500	-0,553	-0,677	-0,652	-0,627	-0,470	-0,628	-0,799	-0,632
550	-0,760	-0,824	-0,913	-0,832	-0,527	-0,690	-0,883	-0,700
600	-0,887	-0,918	-1,084	-0,963	-0,592	-0,757	-0,967	-0,772
650	-1,005	-1,007	-1,240	-1,084	-0,657	-0,836	-1,063	-0,852
700	-1,128	-1,097	-1,388	-1,204	-0,731	-0,938	-1,167	-0,945
750	-1,262	-1,201	-1,558	-1,340	-0,816	-1,037	-1,281	-1,045
750	-1,319	-1,248	-1,627	-1,398	-0,854	-1,080	-1,329	-1,088
800	-1,402	-1,315	-1,721	-1,479	-0,904	-1,141	-1,396	-1,147
800	-1,458	-1,362	-1,792	-1,537	-0,941	-1,185	-1,445	-1,190
850	-1,550	-1,440	-1,904	-1,631	-1,001	-1,253	-1,524	-1,259
850	-1,614	-1,501	-1,981	-1,699	-1,043	-1,306	-1,581	-1,310
900	-1,704	-1,578	-2,093	-1,792	-1,100	-1,372	-1,660	-1,377
900	-1,780	-1,659	-2,191	-1,877	-1,148	-1,440	-1,734	-1,441
950	-1,869	-1,733	-2,297	-1,966	-1,198	-1,495	-1,808	-1,500
950	-1,909	-1,778	-2,350	-2,012	-1,224	-1,529	-1,850	-1,534
1000	-2,019	-1,883	-2,483	-2,128	-1,282	-1,607	-1,963	-1,617
1000	-2,080	-1,956	-2,560	-2,199	-1,311	-1,650	-2,034	-1,665
1050	-2,182	-2,047	-2,677	-2,302	-1,366	-1,708	-2,124	-1,733
1050	-2,273	-2,156	-2,788	-2,406	-1,411	-1,757	-2,226	-1,798
1100	-2,407	-2,284	-2,930	-2,540	-1,485	-1,813	-2,350	-1,883
1100	-2,692	-2,653	-3,246	-2,864	-1,631	-1,711	-2,657	-2,000
1127	-2,745	-2,711	-3,296	-2,917	-1,661	-1,729	-2,708	-2,033
1150	-3,101	-3,097	-3,665	-3,288	-1,800	-1,676	-3,003	-2,160
1173	-3,148	-3,144	-3,718	-3,337	-1,824	-1,691	-3,042	-2,186
1201	-3,201	-3,192	-3,777	-3,390	-1,849	-1,694	-3,085	-2,209
1208	-3,273	-3,278	-3,867	-3,473	-1,878	-1,699	-3,133	-2,237
701	-0,474	-1,290	-1,103	-0,956	-1,595	-1,242	-3,194	-2,010

Beton – odkształcenia po stronie S i N (krótkie tensometry) (ϵ_c) / Concrete – strains on S and N side (short gauges) (ϵ_c)

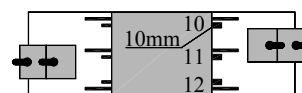
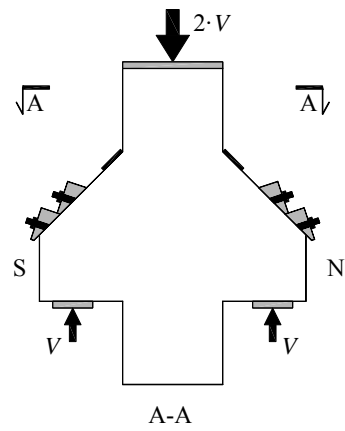
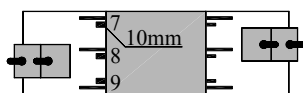
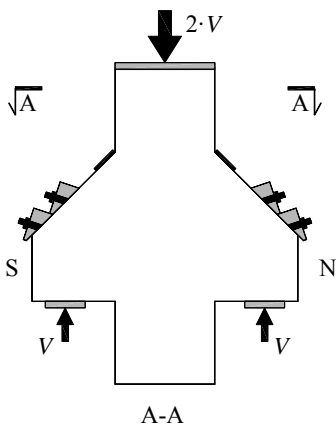
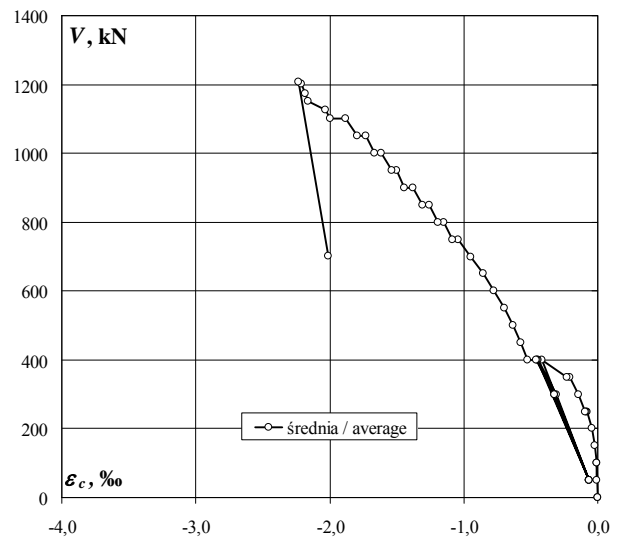
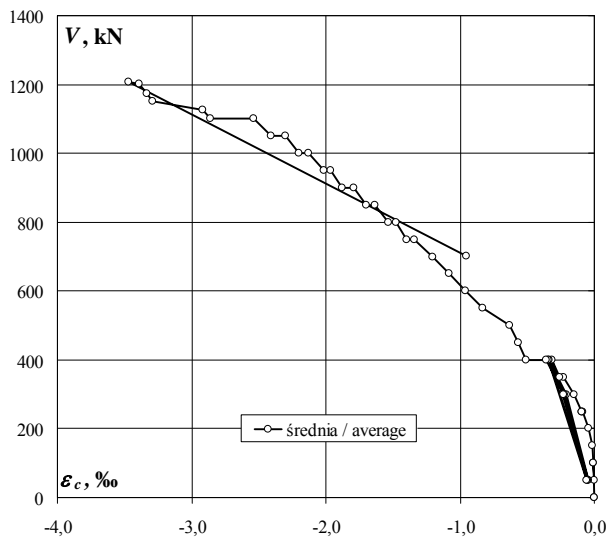
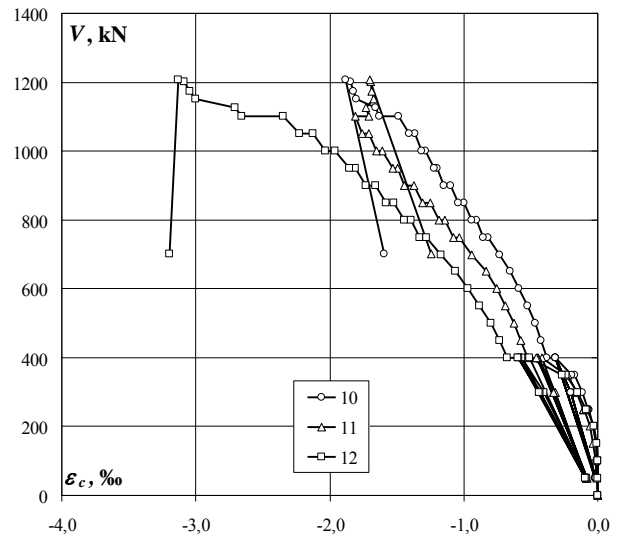
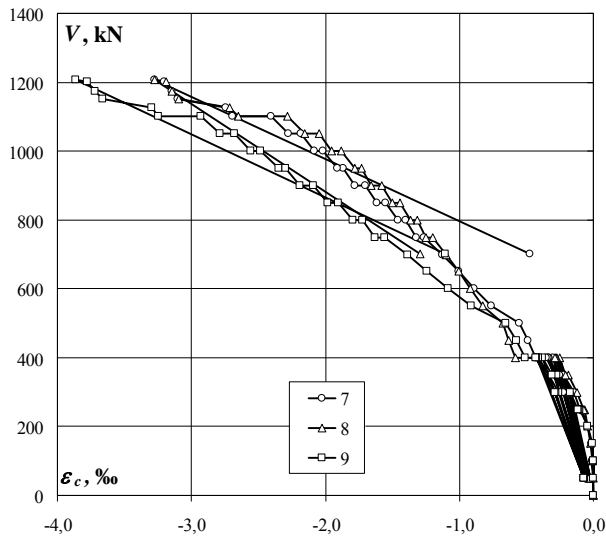

D-II

Zbrojenie główne – odkształcenia po stronie S i N (ε_s) / Main reinforcement – strains on S and N side (ε_s)

obciążenie wspornika corbel load	odkształcenie S S strain			odkształcenie N N strain		
	1	2	średnia/ average	3	4	średnia/ average
	%	%	%	%	%	%
0	0,000	0,000	0,000	0,000	0,000	0,000
0	0,002	0,000	0,001	0,000	0,000	0,000
100	0,117	0,144	0,131	0,087	0,069	0,078
50	0,092	0,110	0,101	0,067	0,049	0,058
100	0,127	0,154	0,141	0,093	0,075	0,084
150	0,297	0,316	0,307	0,176	0,133	0,155
200	0,460	0,500	0,480	0,316	0,226	0,271
250	0,627	0,660	0,644	0,445	0,353	0,399
250	0,644	0,679	0,662	0,471	0,385	0,428
250	0,648	0,684	0,666	0,477	0,392	0,435
300	0,752	0,763	0,758	0,638	0,574	0,606
350	0,951	0,870	0,911	0,784	0,757	0,771
350	1,022	0,898	0,960	0,807	0,814	0,811
400	1,168	0,951	1,060	1,050	1,103	1,077
50		0,412	0,412	0,441	0,446	0,444
300		0,845	0,845	0,923	0,964	0,944
400		1,004	1,004	1,138	1,171	1,155
50		0,428	0,428	0,449	0,454	0,452
50		0,428	0,428	0,449	0,454	0,452
300		0,884	0,884	0,975	1,005	0,990
400		1,032	1,032	1,165	1,202	1,184
50		0,444	0,444	0,456	0,462	0,459
300		0,903	0,903	0,998	1,028	1,013
400		1,054	1,054	1,184	1,224	1,204
400		1,071	1,071	1,199	1,253	1,226
450		1,130	1,130	1,262	1,324	1,293
500		1,201	1,201	1,345	1,412	1,379
550		1,447	1,447	1,391	1,469	1,430
600		1,581	1,581	1,490	1,607	1,549
650		1,707	1,707	1,600	1,930	1,765
700		1,837	1,837	1,719	2,106	1,913
750		1,975	1,975	1,851	2,272	2,062
750		2,012	2,012	1,883	2,313	2,098
800		2,102	2,102	1,967	2,414	2,191
800		2,144	2,144	2,006	2,457	2,232
850		2,256	2,256	2,108	2,569	2,339
850		2,294	2,294	2,141	2,598	2,370
900		2,407	2,407	2,243	2,716	2,480
900		2,447	2,447	2,282	2,763	2,523
950		2,548	2,548	2,369	2,867	2,618
950		2,581	2,581	2,408	2,915	2,662
1000		2,705	2,705	2,548	3,048	2,798
1000		2,737	2,737	2,586	3,069	2,828
1050		2,828	2,828	2,687	3,167	2,927
1050		3,339	3,339	2,759	3,178	2,969
1100		3,668	3,668	3,184	3,254	3,219
1100		4,098	4,098	3,425	4,328	3,877
1127		4,132	4,132	3,459	4,371	3,915
1150		4,972	4,972	4,411	4,827	4,619
1173		4,999	4,999	4,440	4,859	4,650
1201		5,022	5,022	4,491	4,899	4,695
1208		4,996	4,996	4,626	4,911	4,769
701		4,346	4,346	4,329	3,639	3,984

Zbrojenie główne – odkształcenia po stronie S i N (ϵ_s) / Main reinforcement – strains on S and N side (ϵ_s)

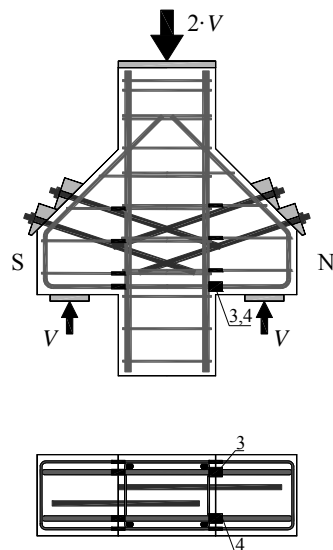
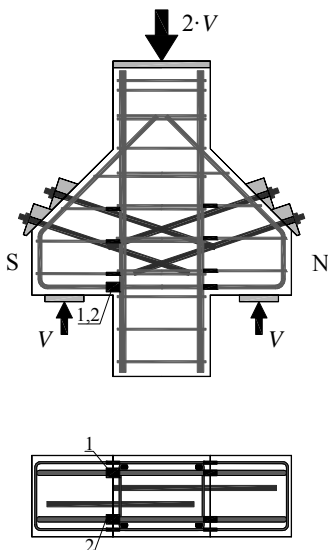
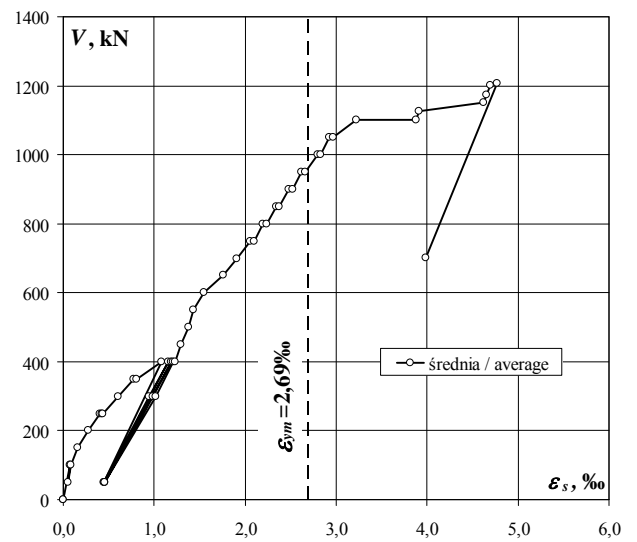
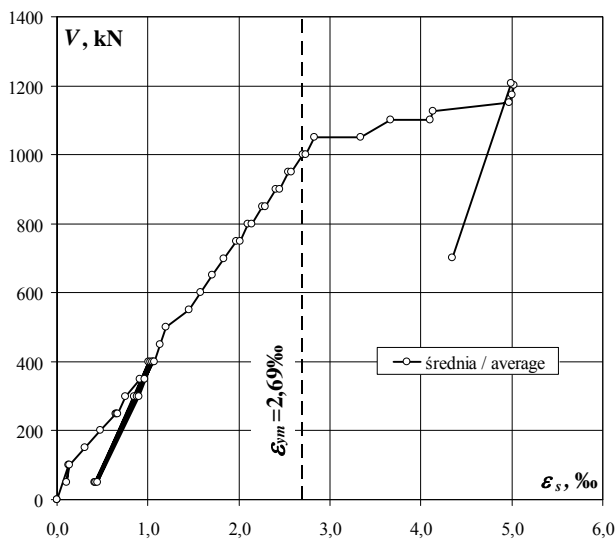
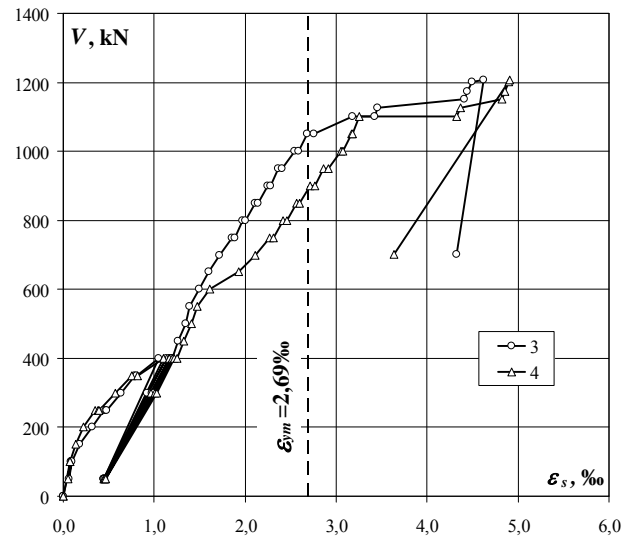
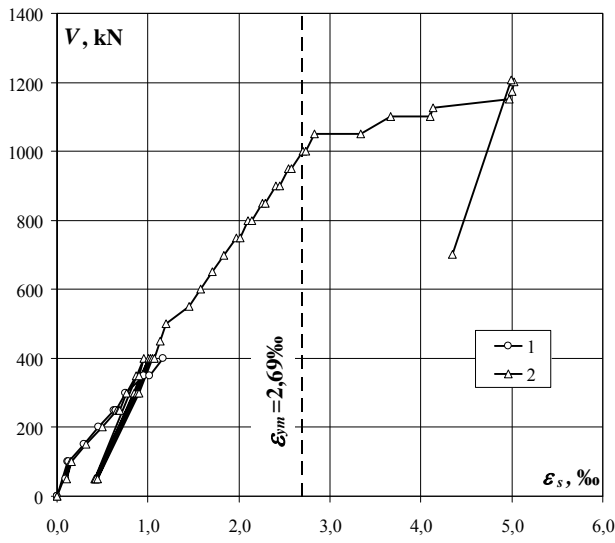

D-II

Strzemień 2 – odkształcenia po stronie S i N (ϵ_s) / Stirrup 2 – strains on S and N side (ϵ_s)

obciążenie wspornika corbel load	odkształcenie S S strain			odkształcenie N N strain		
	9	10	średnia/ average	11	12	średnia/ average
	‰	‰	‰	‰	‰	‰
0	0,000	0,000	0,000	0,000	0,000	0,000
0	0,000	-0,001	-0,001	0,000	0,000	0,000
100	0,035	0,009	0,022	0,016	0,021	0,019
50	0,027	0,009	0,018	0,012	0,015	0,014
100	0,039	0,012	0,026	0,022	0,023	0,023
150	0,117	0,042	0,080	0,046	0,049	0,048
200	0,259	0,120	0,190	0,132	0,090	0,111
250	0,379	0,174	0,277	0,245	0,155	0,200
250	0,400	0,191	0,296	0,278	0,164	0,221
250	0,404	0,197	0,301	0,285	0,167	0,226
300	0,469	0,232	0,351	0,415	0,231	0,323
350	0,691	0,308	0,500	0,530	0,287	0,409
350	0,809	0,354	0,582	0,544	0,308	0,426
400	0,903	0,383	0,643	0,523	0,457	0,490
50	0,444	0,258	0,351	0,295	0,421	0,358
300	0,763	0,369	0,566	0,487	0,525	0,506
400	0,907	0,428	0,668	0,570	0,623	0,597
50	0,465	0,283	0,374	0,305	0,491	0,398
50	0,465	0,283	0,374	0,305	0,491	0,398
300	0,809	0,409	0,609	0,523	0,617	0,570
400	0,941	0,457	0,699	0,590	0,683	0,637
50	0,470	0,295	0,383	0,310	0,524	0,417
300	0,831	0,430	0,631	0,535	0,657	0,596
400	0,965	0,481	0,723	0,603	0,720	0,662
400	1,120	0,530	0,825	0,618	0,773	0,696
450	1,181	0,546	0,864	0,635	0,790	0,713
500	1,276	0,582	0,929	0,676	0,804	0,740
550		1,373	1,373	0,703	0,813	0,758
600		1,611	1,611	0,762	0,839	0,801
650		1,807	1,807	0,824	0,862	0,843
700		2,085	2,085	0,898	0,888	0,893
750		2,825	2,825	0,958	0,920	0,939
750		3,016	3,016	0,982	0,937	0,960
800		3,156	3,156	1,024	0,952	0,988
800		3,217	3,217	1,056	0,965	1,011
850		3,330	3,330	1,107	0,994	1,051
850		3,378	3,378	1,133	1,020	1,077
900		3,567	3,567	1,183	1,048	1,116
900		4,058	4,058	1,213	1,093	1,153
950		4,883	4,883	1,258	1,132	1,195
950		5,379	5,379	1,282	1,261	1,272
1000		5,887	5,887	1,341	1,521	1,431
1000		5,983	5,983	1,362	1,632	1,497
1050		6,169	6,169	1,412	1,733	1,573
1050		6,747	6,747	1,443	1,863	1,653
1100		7,761	7,761	1,492	2,004	1,748
1100		9,670	9,670	1,546	2,464	2,005
1127		9,786	9,786	1,560	2,490	2,025
1150		11,098	11,098	1,610	3,197	2,404
1173		11,173	11,173	1,617	3,243	2,430
1201		11,305	11,305	1,625	3,309	2,467
1208		11,267	11,267	1,625	3,549	2,587
701				1,085	6,832	3,959

Strzemię 2 – odkształcenia po stronie S i N (ϵ_s) / Stirrup 2 – strains on S and N side (ϵ_s)

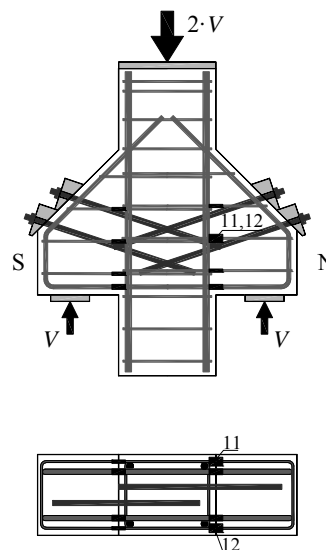
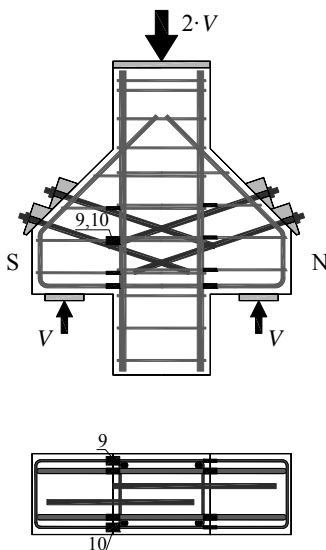
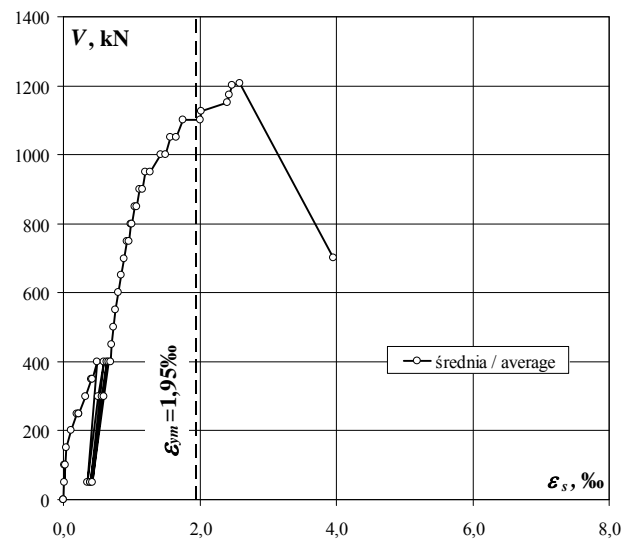
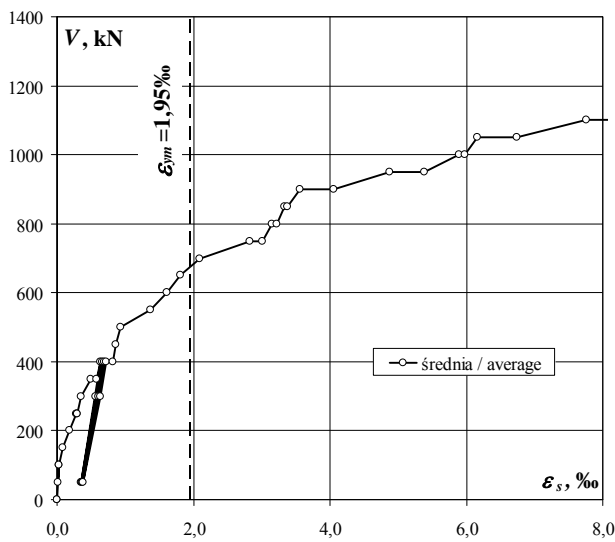
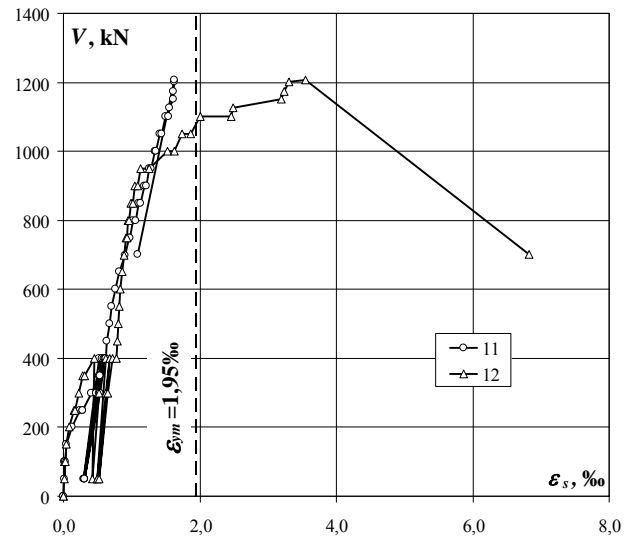
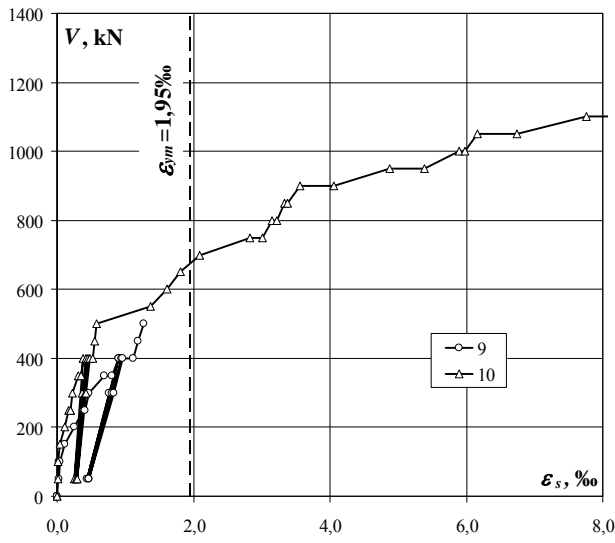

D-II

Strzemię 3 – odkształcenia po stronie S i N (ϵ_s) / Stirrup 3 – strains on S and N side (ϵ_s)

obciążenie wspornika corbel load	odkształcenie S S strain			odkształcenie N N strain		
	13	14	średnia/ average	15	16	średnia/ average
kN	‰	‰	‰	‰	‰	‰
0	0,000					
0	0,000					
100	-0,008					
50	-0,003					
100	-0,008					
150	-0,004					
200	0,012					
250	0,042					
250	0,056					
250	0,061					
300	0,078					
350	0,140					
350	0,190					
400	0,213					
50	0,163					
300	0,209					
400	0,240					
50	0,180					
50	0,180					
300	0,236					
400	0,263					
50	0,188					
300	0,250					
400	0,276					
400	0,302					
450	0,315					
500	0,326					
550	0,687					
600	0,768					
650	0,827					
700	0,882					
750	0,941					
750	0,953					
800	0,992					
800	0,990					
850	1,037					
850	1,034					
900	1,077					
900	1,081					
950	1,125					
950	1,133					
1000	1,177					
1000	1,188					
1050	1,199					
1050	0,879					
1100	0,870					
1100	0,897					
1127	0,924					
1150	1,154					
1173	1,176					
1201	1,211					
1208	1,263					
701	0,583					

Strzemię 3 – odkształcenia po stronie S i N (ϵ_s) / Stirrup 3 – strains on S and N side (ϵ_s)

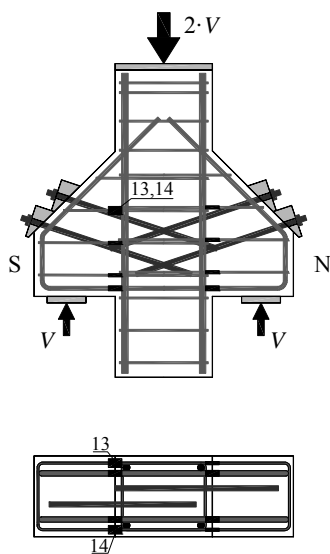
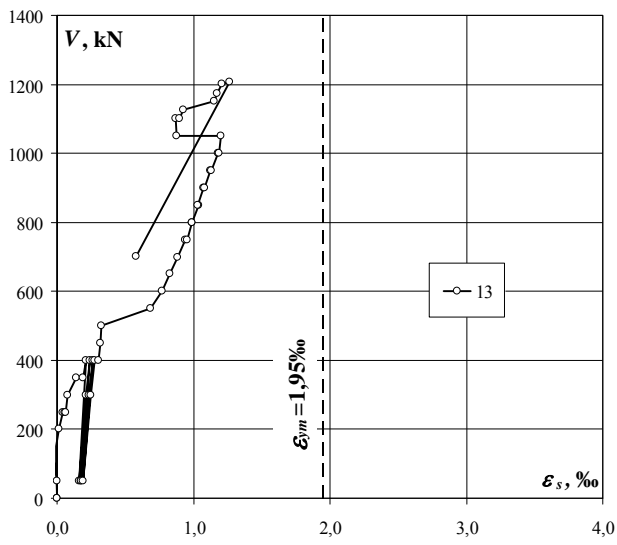

D-II

Szerokość rozwarcia rys / Crack width

obciążenie wspornika corbel load	Numer rysy / Crack number							
	1	2	3	4	5	6	7	8
	mm	mm	mm	mm	mm	mm	mm	mm
250	0,07							
300	0,12	0,12						
350	0,15	0,15	0,12					
400	0,20	0,15	0,15	0,15	0,17			
50	0,10	0,05	0,05	0,05	0,07			
300	0,17	0,15	0,12	0,12	0,17			
400	0,20	0,15	0,17	0,15	0,20			
50	0,10	0,07	0,05	0,05	0,10			
300	0,20	0,15	0,15	0,15	0,20			
400	0,20	0,17	0,17	0,17	0,22			
50	0,12	0,10	0,07	0,07	0,12			
300	0,20	0,15	0,15	0,15	0,20			
400	0,20	0,20	0,17	0,17	0,22			
400	0,20	0,20	0,17	0,17	0,27			
450	0,20	0,20	0,17	0,20	0,25			
500	0,25	0,22	0,20	0,20	0,30			
550	0,25	0,22	0,20	0,20	0,30	0,22		
600	0,25	0,22	0,20	0,20	0,33	0,22		
650	0,25	0,25	0,20	0,25	0,35	0,25		
700	0,27	0,25	0,20	0,25	0,38	0,25		
750	0,30	0,25	0,20	0,25	0,43	0,30	0,20	0,25
800	0,35	0,25	0,25	0,27	0,45	0,33	0,25	0,27
850	0,35	0,25	0,25	0,30	0,50	0,35	0,30	0,32
900	0,40	0,25	0,25	0,32	0,55	0,35	0,35	0,35
950	0,40	0,25	0,25	0,35	0,55	0,40	0,40	0,35
1000	0,45	0,30	0,25	0,33	0,60	0,40	0,45	0,40
1050	0,45	0,30	0,27	0,35	0,65	0,43	0,50	0,40
1100	0,45	0,35	0,30	0,35	0,75	0,50	0,65	0,50
1150	0,50	0,40	0,30	0,40	0,80	0,55	0,80	0,60
1200						0,60	1,10	0,65

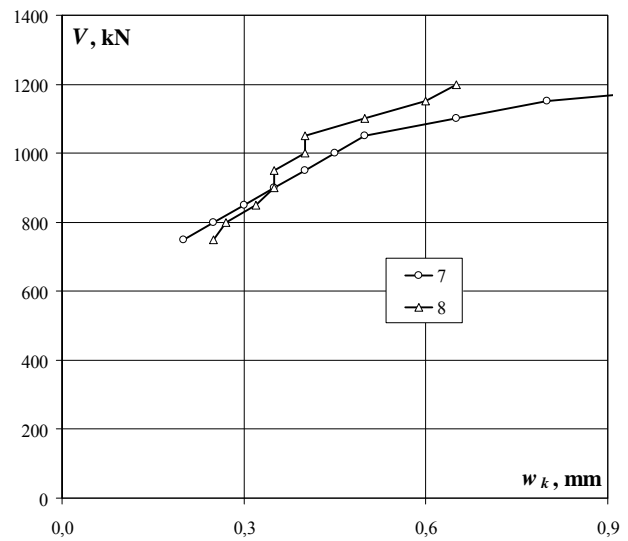
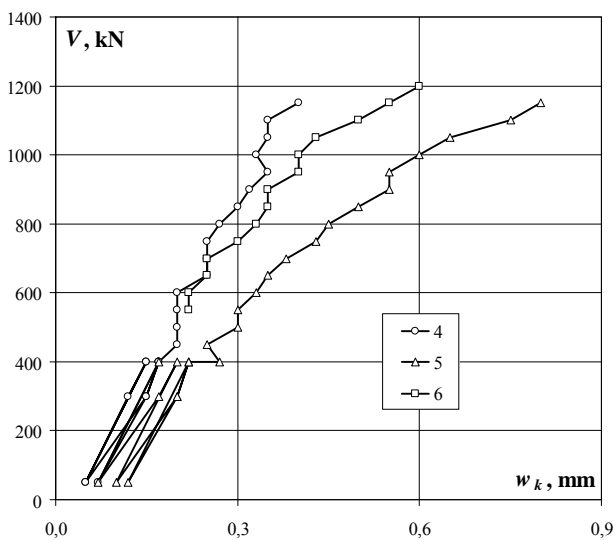
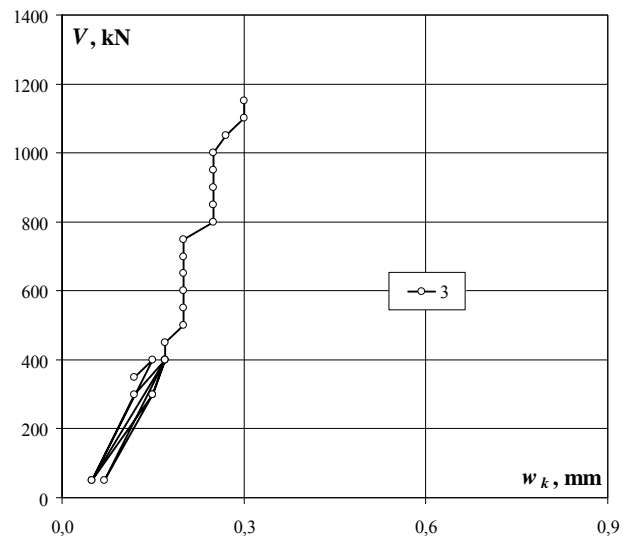
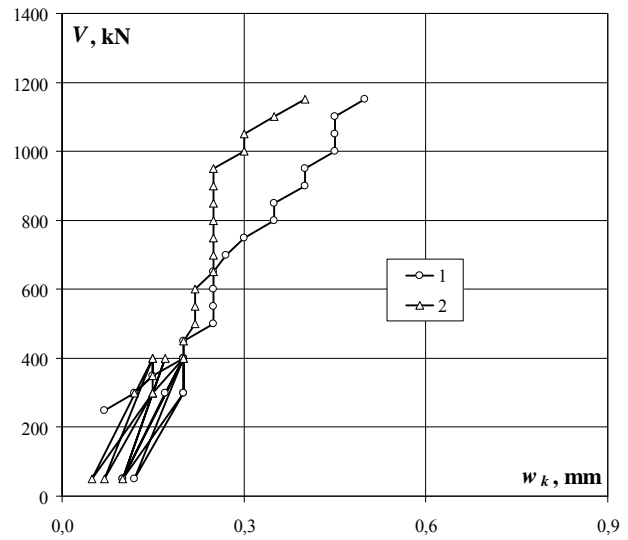

Układ rys przy sile 600kN / Crack pattern at 600kN

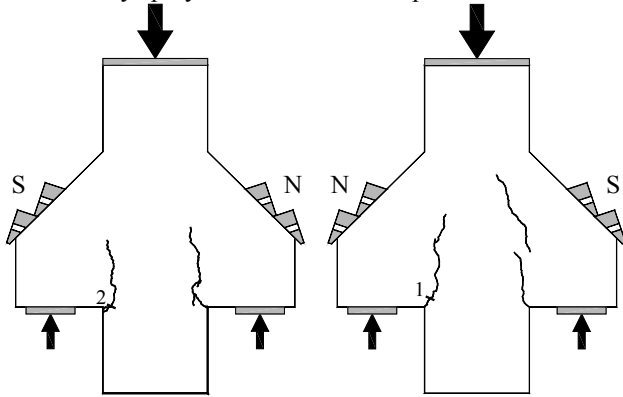

Układ rys przy sile 800kN / Crack pattern at 800kN

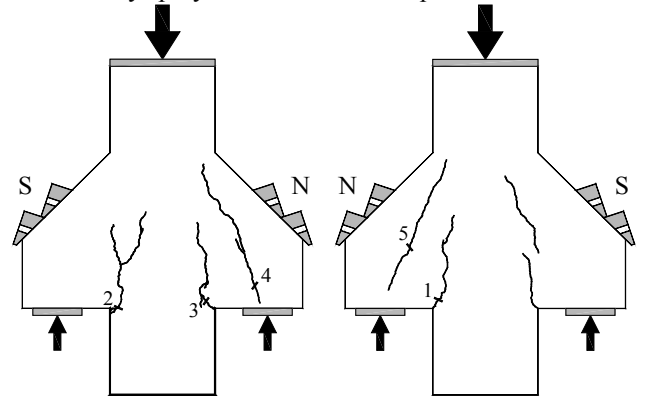

Układ rys przy sile 1100kN / Crack pattern at 1100kN

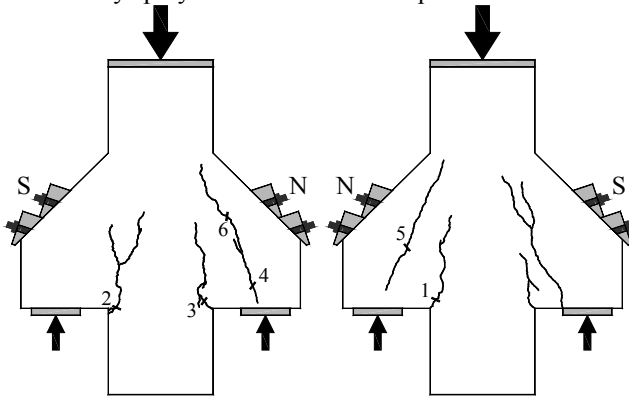

Układ rys przy sile 1200kN / Crack pattern at 1200kN

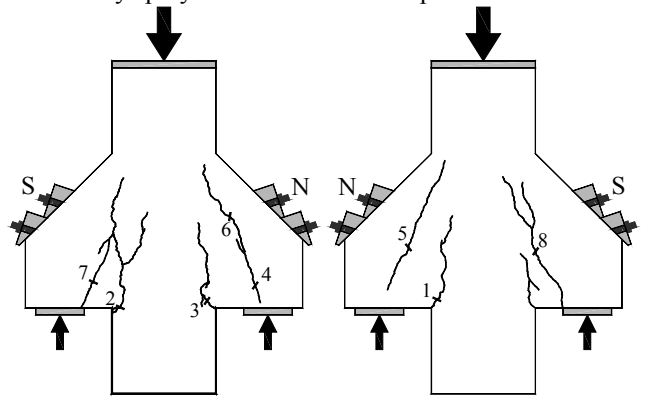

Układ rys przy sile 1600kN / Crack pattern at 1600kN

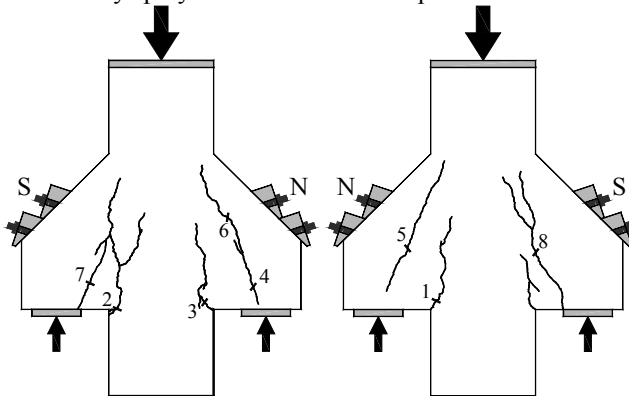

Układ rys przy sile 1800kN / Crack pattern at 1800kN

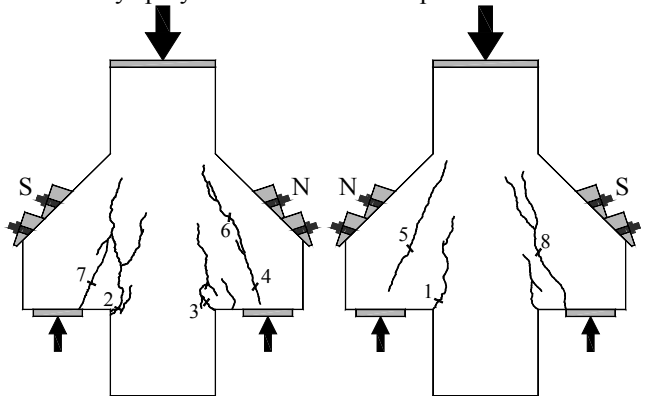

Układ rys przy sile 2200kN / Crack pattern at 2200kN

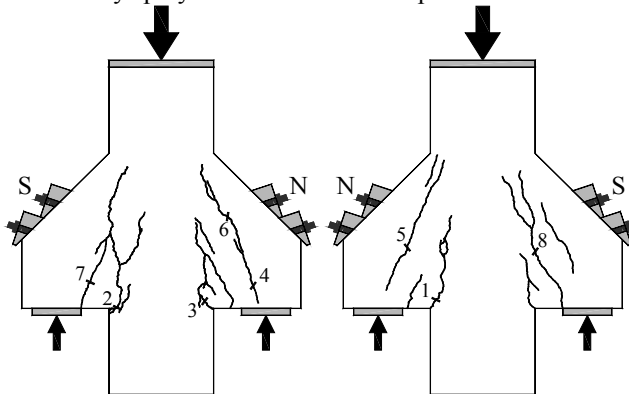

Układ rys przy sile 2420kN / Crack pattern at 2420kN

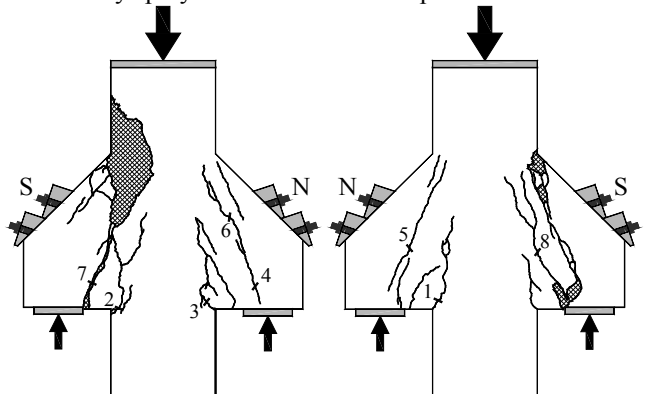

D-II

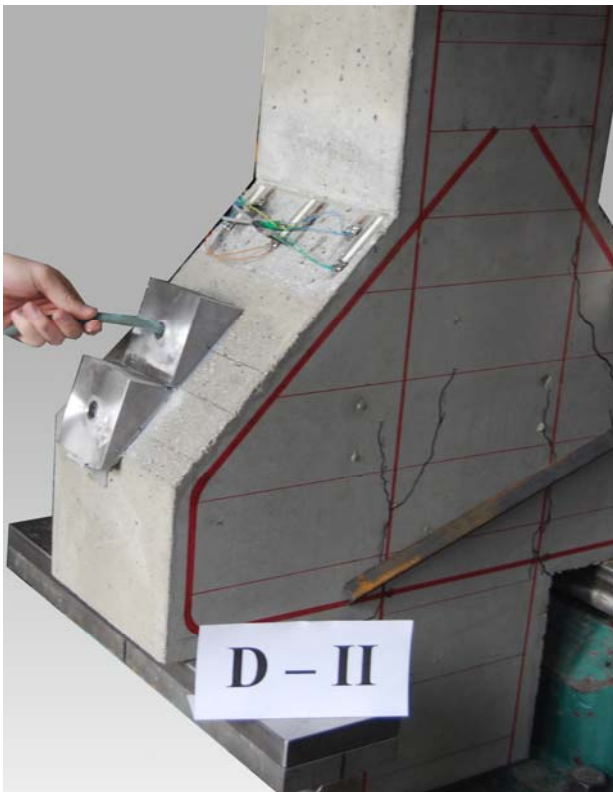

Czyszczenie otworu sprężonym powietrzem
Cleaning the hole by compressed air



Wiercenie otworu
Drilling of the hole



Wspornik po zniszczeniu / Corbel after failure

Przemieszczenie słupa względem wsporników / The relative displacement between the column and the corbels

obciążenie wspornika corbel load	Przemieszczenie / Przemieszczenie
	mm
0	0,000
50	0,015
100	0,026
150	0,053
200	0,087
250	0,125
300	0,178
350	0,225
400	0,317
50	0,144
300	0,286
400	0,353
50	0,158
300	0,306
400	0,372
50	0,165
300	0,317
400	0,389
400	wzmocnienie / strengthening
400	0,426
450	0,450
450	0,454
500	0,486
550	0,578
550	0,595
600	0,638
600	0,664
650	0,718
650	0,743
700	0,806
750	0,929
800	0,978
800	1,004
850	1,086
900	1,166
950	1,203
950	1,229
1000	1,280
1000	1,321
1050	1,369
1050	1,434
1100	1,492
1100	1,663
1150	1,753
1150	1,903
1200	2,046

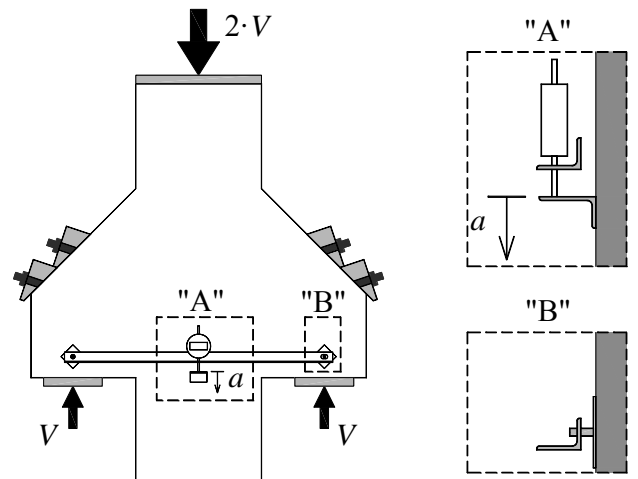
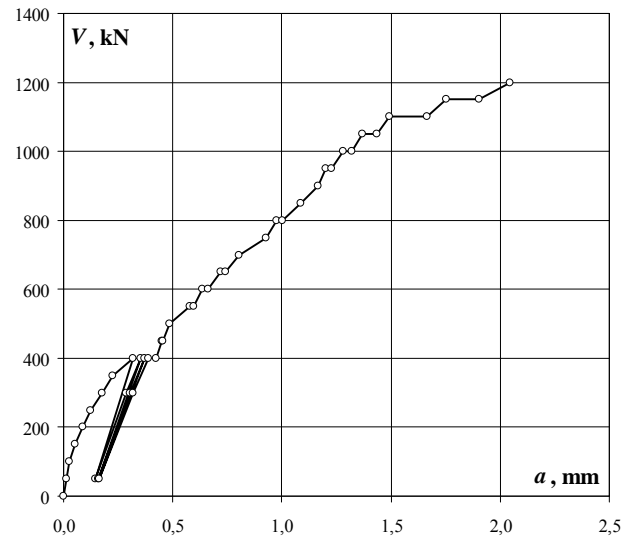

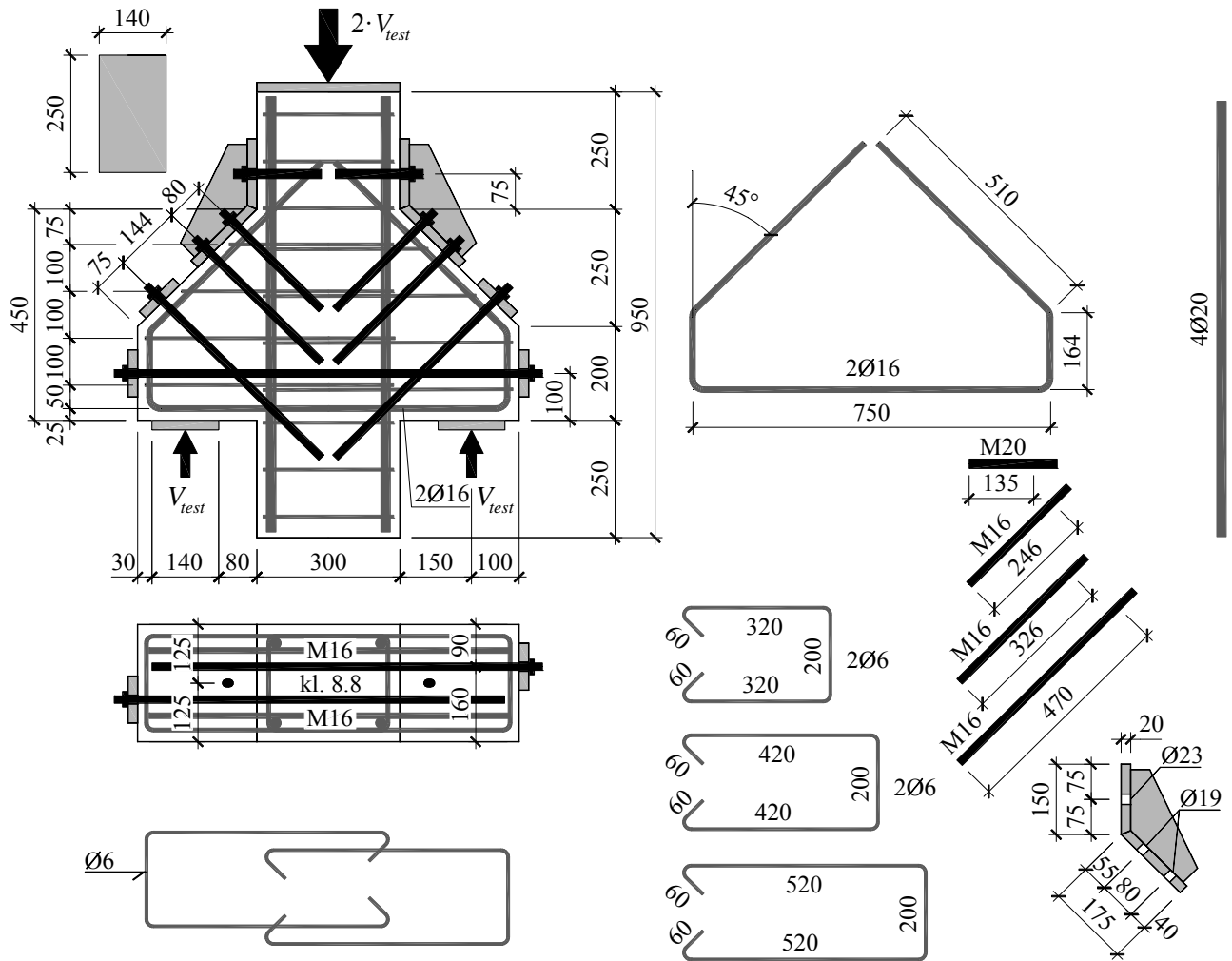

Zbrojenie modelu / Specimen's reinforcement

Wytrzymałość betonu na ściskanie / Compressive strength of concrete

$$f_{cm} = 45,1\text{MPa}$$

Moduł sprężystości podłużnej / Young's modulus

$$E_{cm} = 27,2\text{GPa}$$

Wytrzymałość betonu na rozciąganie przy rozłupywaniu / Tensile splitting strength of concrete

$$f_{ct,sp} = 3,7\text{MPa}$$

Gęstość betonu / Density of concrete

$$\rho = 2220\text{kg/m}^3$$

Charakterystyka zbrojenia / Characteristics of the reinforcement

Ø6

$$A_s = 28,07\text{mm}^2, f_{ym} = 385,6\text{MPa}, f_{tm} = 487,6\text{MPa}$$

Ø16

$$A_s = 200,53\text{mm}^2, f_{ym} = 533,6\text{MPa}, f_{tm} = 638,5\text{MPa}$$

Ø20

$$A_s = 310,67\text{mm}^2, f_{ym} = 541,0\text{MPa}, f_{tm} = 640,4\text{MPa}$$

M16

$$A_s = 141,07\text{mm}^2, f_{ym} = 825,9\text{MPa}, f_{tm} = 969,6\text{MPa}$$

Siła niszcząca / Failure force

$$V_{test} = 1714\text{kN}$$

D-III

Beton – odkształcenia po stronie S i N (długie tensometry) (ϵ_c) / Concrete – strains on S and N side (long gauges) (ϵ_c)

obciążenie wspornika corbel load	odkształcenie S S strain				odkształcenie N N strain			
	1	2	3	średnia/ average	4	5	6	średnia/ average
kN	‰	‰	‰	‰	‰	‰	‰	‰
0	0,000	0,000	0,000	0,000	0,000	0,000	0,000	0,000
0	-0,001	0,002	0,001	0,001	-0,001	0,000	0,000	0,000
50	-0,011	-0,011	-0,016	-0,013	-0,010	-0,010	-0,019	-0,013
100	-0,019	-0,024	-0,044	-0,029	-0,023	-0,023	-0,044	-0,030
150	-0,035	-0,052	-0,081	-0,056	-0,036	-0,040	-0,071	-0,049
200	-0,066	-0,095	-0,133	-0,098	-0,064	-0,074	-0,112	-0,083
250	-0,107	-0,147	-0,191	-0,148	-0,109	-0,125	-0,171	-0,135
250	-0,112	-0,155	-0,201	-0,156	-0,119	-0,133	-0,180	-0,144
300	-0,169	-0,218	-0,260	-0,216	-0,169	-0,186	-0,234	-0,196
350	-0,234	-0,294	-0,327	-0,285	-0,243	-0,254	-0,302	-0,266
400	-0,310	-0,376	-0,406	-0,364	-0,317	-0,329	-0,376	-0,341
50	-0,052	-0,078	-0,100	-0,077	-0,073	-0,076	-0,097	-0,082
300	-0,216	-0,280	-0,313	-0,270	-0,230	-0,243	-0,291	-0,255
400	-0,334	-0,402	-0,429	-0,388	-0,346	-0,357	-0,403	-0,369
50	-0,052	-0,083	-0,105	-0,080	-0,073	-0,082	-0,102	-0,086
300	-0,226	-0,293	-0,322	-0,280	-0,247	-0,261	-0,307	-0,272
400	-0,348	-0,411	-0,436	-0,398	-0,365	-0,372	-0,415	-0,384
50	-0,052	-0,086	-0,106	-0,081	-0,077	-0,085	-0,105	-0,089
300	-0,232	-0,302	-0,328	-0,287	-0,255	-0,270	-0,315	-0,280
400	-0,355	-0,420	-0,441	-0,405	-0,375	-0,379	-0,425	-0,393
400	-0,384	-0,435	-0,449	-0,423	-0,412	-0,440	-0,460	-0,437
400	-0,384	-0,436	-0,456	-0,425	-0,415	-0,441	-0,462	-0,439
400	-0,399	-0,454	-0,473	-0,442	-0,405	-0,428	-0,451	-0,428
400	-0,401	-0,456	-0,485	-0,447	-0,408	-0,422	-0,459	-0,430
400	-0,410	-0,459	-0,487	-0,452	-0,409	-0,420	-0,464	-0,431
400	-0,422	-0,479	-0,482	-0,461	-0,407	-0,400	-0,452	-0,420
400	-0,423	-0,482	-0,481	-0,462	-0,407	-0,399	-0,451	-0,419
400	-0,425	-0,483	-0,482	-0,463	-0,408	-0,400	-0,452	-0,420
400	-0,429	-0,502	-0,484	-0,472	-0,418	-0,401	-0,453	-0,424
400	-0,428	-0,510	-0,484	-0,474	-0,417	-0,401	-0,453	-0,424
400	-0,447	-0,530	-0,493	-0,490	-0,406	-0,439	-0,450	-0,432
400	-0,440	-0,533	-0,489	-0,487	-0,404	-0,412	-0,457	-0,424
400	-0,437	-0,532	-0,485	-0,485	-0,404	-0,391	-0,451	-0,415
400	-0,453	-0,629	-0,494	-0,525	-0,408	-0,409	-0,463	-0,427
400	-0,448	-0,722	-0,493	-0,554	-0,409	-0,408	-0,457	-0,425
450	-0,469	-0,737	-0,514	-0,573	-0,427	-0,425	-0,476	-0,443
500	-0,486	-0,748	-0,530	-0,588	-0,447	-0,440	-0,486	-0,458
550	-0,508	-0,760	-0,548	-0,605	-0,468	-0,460	-0,504	-0,477
600	-0,526	-0,771	-0,571	-0,623	-0,493	-0,477	-0,526	-0,499
650	-0,540	-0,784	-0,605	-0,643	-0,514	-0,494	-0,538	-0,515
700	-0,559	-0,791	-0,631	-0,660	-0,536	-0,510	-0,562	-0,536
750	-0,578	-0,804	-0,652	-0,678	-0,556	-0,524	-0,573	-0,551
800	-0,594	-0,810	-0,671	-0,692	-0,581	-0,544	-0,592	-0,572
850	-0,613	-0,829	-0,695	-0,712	-0,601	-0,565	-0,610	-0,592
900	-0,628	-0,835	-0,713	-0,725	-0,617	-0,579	-0,620	-0,605
950	-0,644	-0,842	-0,731	-0,739	-0,637	-0,601	-0,654	-0,631
1000	-0,659	-0,852	-0,750	-0,754	-0,660	-0,619	-0,690	-0,656
1050	-0,685	-0,863	-0,773	-0,774	-0,680	-0,641	-0,727	-0,683
1050	-0,688	-0,868	-0,773	-0,776	-0,690	-0,649	-0,777	-0,705
1100	-0,706	-0,877	-0,790	-0,791	-0,713	-0,672	-0,818	-0,734
1100	-0,716	-0,882	-0,791	-0,796	-0,722	-0,684	-0,904	-0,770
1150	-0,731	-0,888	-0,795	-0,805	-1,586	-1,100	-1,326	-1,337
1150	-0,737	-0,892	-0,801	-0,810	-1,919	-1,312	-1,590	-1,607
1200	-0,763	-0,903	-0,821	-0,829	-2,311	-1,536	-1,891	-1,913
1250	-0,789	-0,917	-0,839	-0,848	-2,874	-1,920	-2,399	-2,398
1250	-0,809	-0,921	-0,845	-0,858	-4,089	-2,932	-2,839	-3,287
1274	-0,819	-0,927	-0,856	-0,867	-4,146	-2,955	-2,871	-3,324
1300	-0,827	-0,932	-0,863	-0,874	-4,241	-2,999	-2,924	-3,388
1300	-0,842	-0,934	-0,866	-0,881	-4,180	-3,104	-3,055	-3,446
1326	-0,852	-0,940	-0,875	-0,889	-4,215	-3,130	-3,084	-3,476

obciążenie wspornika corbel load	odkształcenie S S strain				odkształcenie N N strain			
	1	2	3	średnia/ average	4	5	6	średnia/ average
kN	‰	‰	‰	‰	‰	‰	‰	‰
1350	-0,861	-0,943	-0,883	-0,896	-4,271	-3,183	-3,147	-3,534
1350	-0,868	-0,945	-0,886	-0,900	-4,332	-3,217	-3,192	-3,580
1375	-0,893	-0,955	-0,904	-0,917	-4,470	-3,293	-3,283	-3,682
1400	-0,903	-0,960	-0,913	-0,925	-4,517	-3,325	-3,324	-3,722
1400	-0,937	-0,967	-0,934	-0,946	-4,696	-3,412	-3,411	-3,840
1426	-0,947	-0,973	-0,947	-0,956	-4,728	-3,433	-3,437	-3,866
1450	-0,954	-0,976	-0,955	-0,962	-4,771	-3,468	-3,476	-3,905
1450	-1,013	-0,958	-1,168	-1,046	-4,911	-3,543	-3,546	-4,000
1475	-1,187	-0,882	-1,504	-1,191	-5,019	-3,608	-3,624	-4,084
1500	-1,227	-0,871	-1,555	-1,218	-5,063	-3,642	-3,661	-4,122
1525	-1,698	-0,692	-2,139	-1,510	-5,276	-3,761	-3,802	-4,280
1550	-1,728	-0,691	-2,065	-1,495	-5,315	-3,784	-3,836	-4,312
1576	-2,069	-1,182	1,635	-0,539	-5,608	-3,944	-4,014	-4,522
1600	-2,102	-1,220		-1,661	-5,655	-3,980	-4,055	-4,563
1625	-2,301	-1,591		-1,946	-6,047	-4,191	-4,199	-4,812
1650	-3,231	-2,056		-2,644	-6,121	-4,223	-4,213	-4,852
1674		-2,848		-2,848	-7,101	-4,672		-5,887
1701		-2,883		-2,883	-7,186	-4,724		-5,955
1714		-2,980		-2,980	-7,500	-4,859		-6,180
1700		-3,247		-3,247	-8,635	-5,195		-6,915
1654		-3,402		-3,402	-9,818	-5,203		-7,511
1512		-3,368		-3,368	-10,191	-4,406		-7,299

Beton – odkształcenia po stronie S i N (długie tensometry) (ϵ_c) / Concrete – strains on S and N side (long gauges) (ϵ_c)

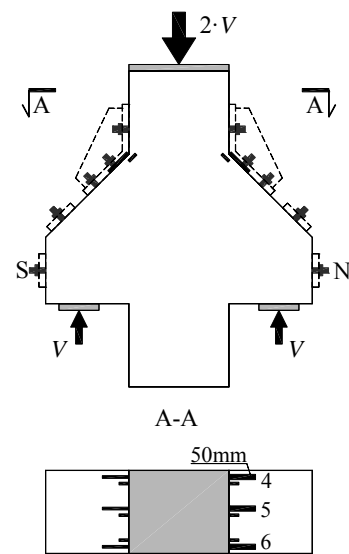
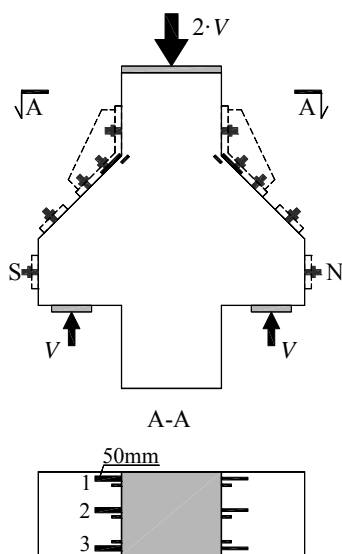
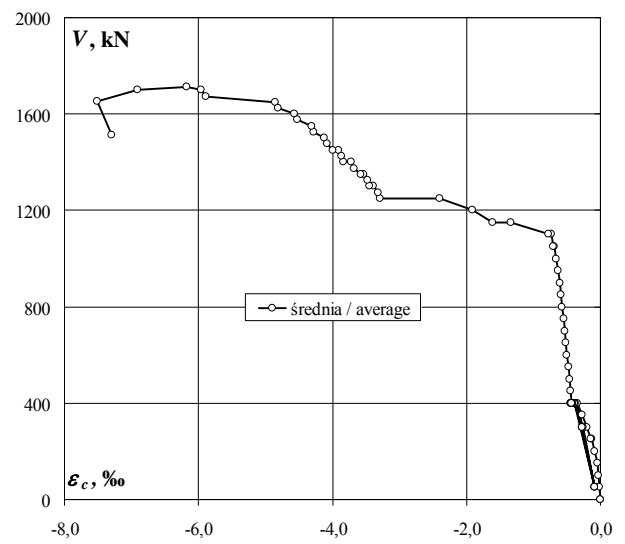
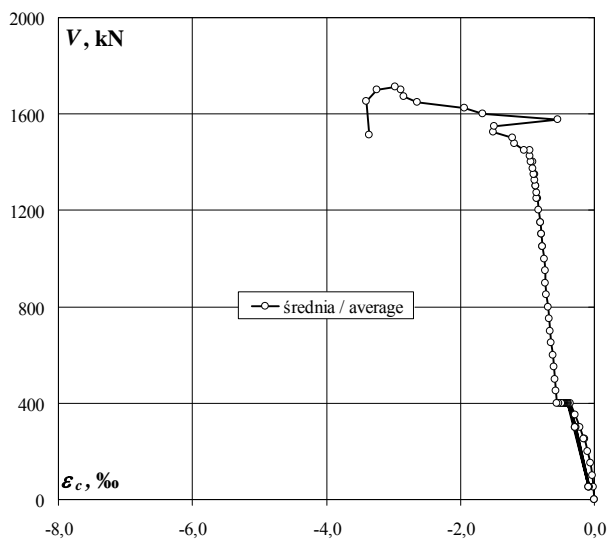
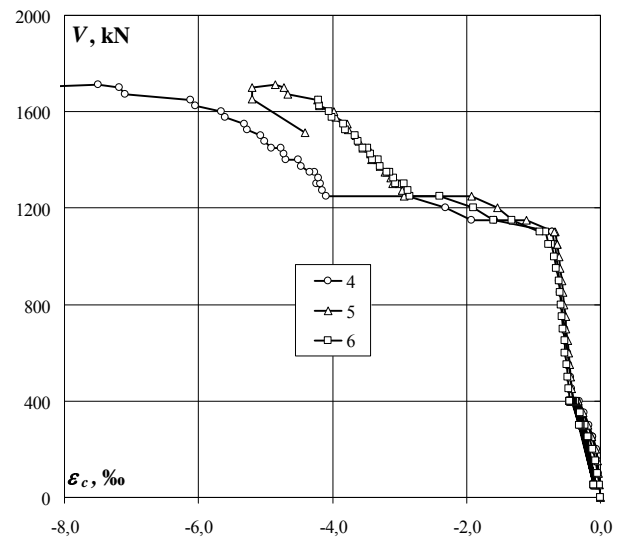
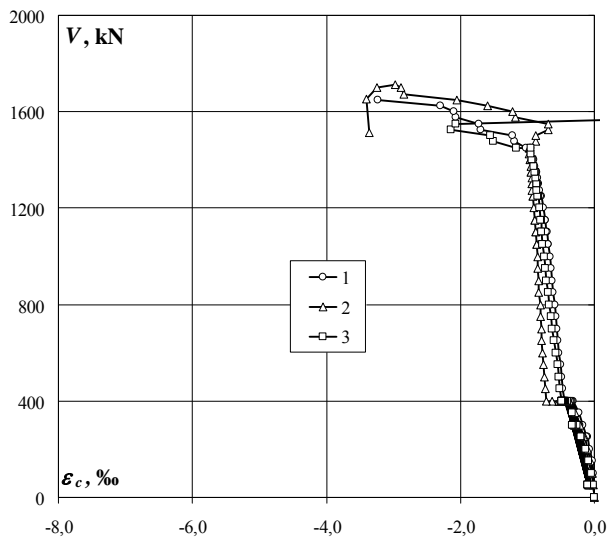

D-III

Beton – odkształcenia po stronie S i N (krótkie tensometry) (ε_c) / Concrete – strains on S and N side (short gauges) (ε_c)

obciążenie wspornika corbel load	odkształcenie S S strain				odkształcenie N N strain			
	7	8	9	średnia/ average	10	11	12	średnia/ average
kN	‰	‰	‰	‰	‰	‰	‰	‰
0	0,000	0,000	0,000	0,000	0,000	0,000	0,000	0,000
0	0,000	0,000	0,000	0,000	0,000	0,000	0,000	0,000
50	-0,009	-0,005	-0,009	-0,008	0,000	-0,006	-0,011	-0,006
100	-0,035	-0,018	-0,025	-0,026	-0,001	-0,011	-0,026	-0,013
150	-0,061	-0,037	-0,060	-0,053	-0,012	-0,021	-0,041	-0,025
200	-0,094	-0,069	-0,118	-0,094	-0,032	-0,039	-0,068	-0,046
250	-0,139	-0,119	-0,191	-0,150	-0,072	-0,072	-0,111	-0,085
250	-0,143	-0,127	-0,203	-0,158	-0,077	-0,079	-0,119	-0,092
300	-0,204	-0,199	-0,282	-0,228	-0,127	-0,123	-0,166	-0,139
350	-0,300	-0,301	-0,379	-0,327	-0,200	-0,184	-0,230	-0,205
400	-0,399	-0,416	-0,484	-0,433	-0,279	-0,249	-0,303	-0,277
50	-0,054	-0,069	-0,105	-0,076	-0,033	-0,048	-0,067	-0,049
300	-0,261	-0,284	-0,362	-0,302	-0,175	-0,167	-0,218	-0,187
400	-0,425	-0,453	-0,516	-0,465	-0,307	-0,274	-0,329	-0,303
50	-0,059	-0,076	-0,114	-0,083	-0,038	-0,051	-0,072	-0,054
300	-0,277	-0,304	-0,380	-0,320	-0,191	-0,182	-0,232	-0,202
400	-0,436	-0,469	-0,528	-0,478	-0,320	-0,286	-0,341	-0,316
50	-0,062	-0,081	-0,120	-0,088	-0,040	-0,054	-0,074	-0,056
300	-0,290	-0,316	-0,388	-0,331	-0,202	-0,190	-0,242	-0,211
400	-0,445	-0,480	-0,538	-0,488	-0,332	-0,296	-0,351	-0,326
400	-0,485	-0,522	-0,578	-0,528	-0,524	-0,476	-0,518	-0,506
400	-0,486	-0,523	-0,580	-0,530	-0,516	-0,472	-0,515	-0,501
400	-0,570	-0,624	-0,656	-0,617	-0,460	-0,419	-0,473	-0,451
400	-0,536	-0,584	-0,636	-0,585	-0,422	-0,384	-0,439	-0,415
400	-0,541	-0,587	-0,649	-0,592	-0,415	-0,380	-0,435	-0,410
400	-0,566	-0,594	-0,667	-0,609	-0,390	-0,370	-0,410	-0,390
400	-0,569	-0,594	-0,666	-0,610	-0,391	-0,370	-0,412	-0,391
400	-0,570	-0,599	-0,669	-0,613	-0,392	-0,372	-0,414	-0,393
400	-0,577	-0,607	-0,687	-0,624	-0,392	-0,375	-0,417	-0,395
400	-0,578	-0,607	-0,681	-0,622	-0,393	-0,374	-0,416	-0,394
400	-0,621	-0,668	-0,737	-0,675	-0,459	-0,446	-0,488	-0,464
400	-0,616	-0,647	-0,717	-0,660	-0,441	-0,416	-0,480	-0,446
400	-0,619	-0,647	-0,707	-0,658	-0,435	-0,406	-0,483	-0,441
400	-0,606	-0,637	-0,698	-0,647	-0,425	-0,400	-0,466	-0,430
400	-0,604	-0,639	-0,694	-0,646	-0,419	-0,395	-0,463	-0,426
450	-0,617	-0,660	-0,723	-0,667	-0,431	-0,411	-0,487	-0,443
500	-0,630	-0,685	-0,753	-0,689	-0,443	-0,429	-0,516	-0,463
550	-0,644	-0,709	-0,784	-0,712	-0,455	-0,449	-0,546	-0,483
600	-0,660	-0,733	-0,821	-0,738	-0,466	-0,471	-0,579	-0,505
650	-0,653	-0,747	-0,864	-0,755	-0,473	-0,491	-0,617	-0,527
700	-0,648	-0,783	-0,909	-0,780	-0,479	-0,508	-0,663	-0,550
750	-0,646	-0,817	-0,952	-0,805	-0,483	-0,528	-0,708	-0,573
800	-0,642	-0,851	-0,992	-0,828	-0,493	-0,552	-0,744	-0,596
850	-0,631	-0,891	-1,045	-0,856	-0,498	-0,589	-0,804	-0,630
900	-0,630	-0,921	-1,094	-0,882	-0,508	-0,613	-0,849	-0,657
950	-0,629	-0,950	-1,145	-0,908	-0,523	-0,647	-0,947	-0,706
1000	-0,624	-0,978	-1,189	-0,930	-0,537	-0,706	-0,996	-0,746
1050	-0,621	-1,008	-1,218	-0,949	-0,548	-0,736	-1,074	-0,786
1050	-0,627	-1,006	-1,225	-0,953	-0,548	-0,640	-1,188	-0,792
1100	-0,639	-1,024	-1,256	-0,973	-0,559	-0,650	-1,261	-0,823
1100	-0,640	-1,023	-1,264	-0,976	-0,559	-0,649	-1,375	-0,861
1150	-0,645	-1,029	-1,277	-0,984	-1,513	-1,096	-1,596	-1,402
1150	-0,647	-1,024	-1,279	-0,983	-1,758	-1,140	-1,742	-1,547
1200	-0,659	-1,045	-1,313	-1,006	-2,094	-1,170	-1,935	-1,733
1250	-0,672	-1,058	-1,346	-1,025	-2,513	-1,334	-2,297	-2,048
1250	-0,681	-1,040	-1,354	-1,025	-3,429	-1,865	-2,973	-2,756
1274	-0,688	-1,050	-1,371	-1,036	-3,469	-1,897	-3,008	-2,791
1300	-0,694	-1,060	-1,385	-1,046	-3,536	-1,948	-3,064	-2,849
1300	-0,700	-1,056	-1,397	-1,051	-3,765	-2,111	-3,240	-3,039
1326	-0,706	-1,065	-1,411	-1,061	-3,813	-2,141	-3,270	-3,075

obciążenie wspornika corbel load	odkształcenie S S strain				odkształcenie N N strain			
	7	8	9	średnia/ average	10	11	12	średnia/ average
kN	‰	‰	‰	‰	‰	‰	‰	‰
1350	-0,712	-1,073	-1,428	-1,071	-3,901	-2,191	-3,332	-3,141
1350	-0,718	-1,075	-1,436	-1,076	-3,998	-2,220	-3,393	-3,204
1375	-0,747	-1,083	-1,467	-1,099	-4,203	-2,287	-3,518	-3,336
1400	-0,757	-1,092	-1,485	-1,111	-4,266	-2,322	-3,564	-3,384
1400	-0,600	-1,101	-1,527	-1,076	-4,524	-2,368	-3,711	-3,534
1426	-0,591	-1,145	-1,546	-1,094	-4,563	-2,394	-3,737	-3,565
1450	-0,592	-1,164	-1,562	-1,106	-4,616	-2,427	-3,780	-3,608
1450	-0,545	-1,479	-1,793	-1,272	-4,807	-2,474	-3,923	-3,735
1475	-1,108	-1,709	-1,990	-1,602	-4,956	-2,529	-4,043	-3,843
1500	-1,162	-1,755	-2,033	-1,650	-5,006	-2,561	-4,086	-3,884
1525	-1,904	-1,118	-2,341	-1,788	-5,314	-2,646	-4,307	-4,089
1550	-1,944	-1,096	-2,398	-1,813	-5,360	-2,674	-4,346	-4,127
1576	-2,531	-1,432	-2,912	-2,292	-5,776	-2,805	-4,633	-4,405
1600	-2,589	-1,553	-2,977	-2,373	-5,849	-2,843	-4,687	-4,460
1625	-3,127	-3,027	-3,427	-3,194	-6,398	-3,048	-5,129	-4,858
1650	-3,935	-3,484	-3,624	-3,681	-6,495	-3,078	-5,178	-4,917
1674	-5,462	-4,880	-4,542	-4,961	-7,663	-3,566	-6,109	-5,779
1701	-5,520	-4,934	-4,606	-5,020	-7,772	-3,619	-6,190	-5,860
1714	-5,700	-5,110	-4,790	-5,200	-8,189	-3,779	-6,492	-6,153
1700	-6,333	-5,562	-5,199	-5,698	-9,394	-4,214	-7,282	-6,963
1654	-6,771	-5,852	-5,408	-6,010	-9,660	-4,113	-7,726	-7,166
1512	-6,774	-5,861	-5,405	-6,013	-8,783	-3,073	-6,483	-6,113

Beton – odkształcenia po stronie S i N (krótkie tensometry) (ϵ_c) / Concrete – strains on S and N side (short gauges) (ϵ_c)

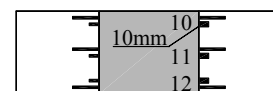
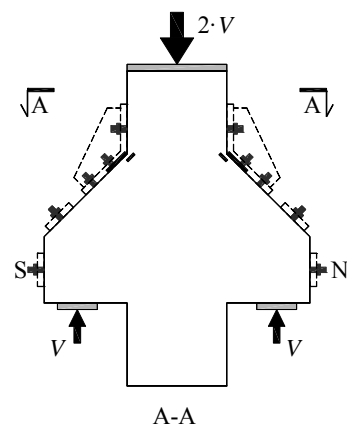
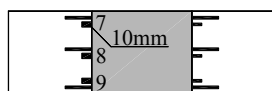
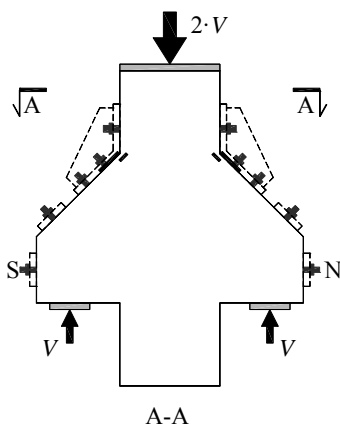
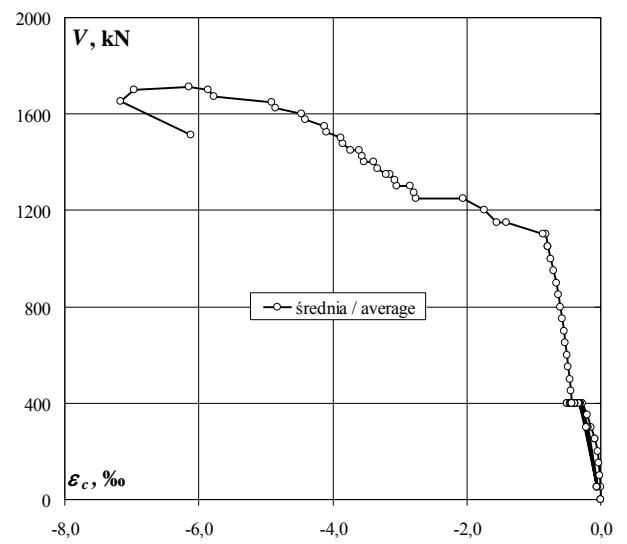
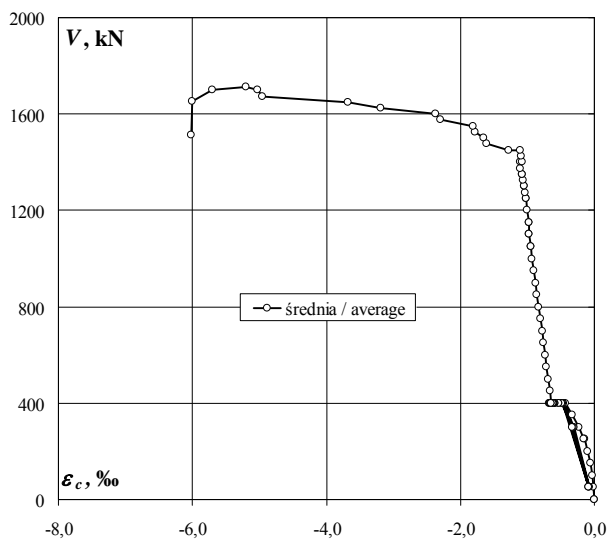
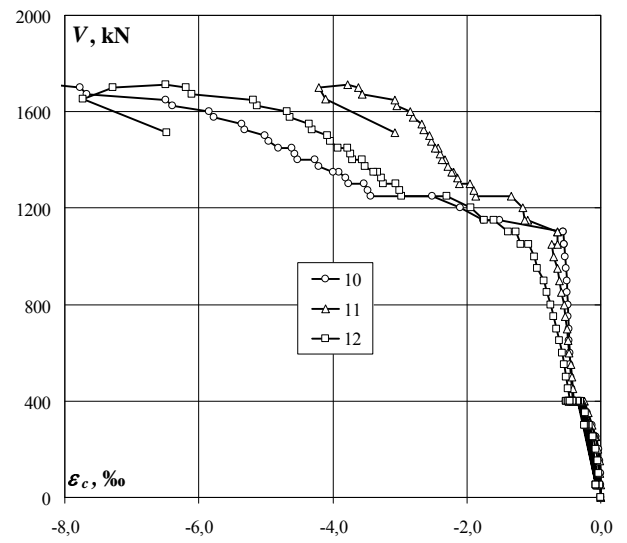
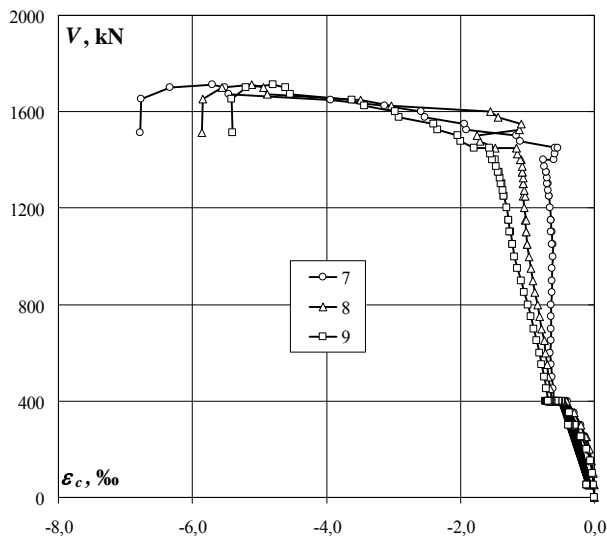

D-III

Beton – odkształcenia na licu po stronie S i N (ϵ_c) / Concrete – strains on face S and N side (ϵ_c)

obciążenie wspornika corbel load	odkształcenie na licu S S face strains			odkształcenie na licu N N face strains		
	13	14	średnia/ average	15	16	średnia/ average
	‰	‰	‰	‰	‰	‰
0	0,000	0,000	0,000	0,000	0,000	0,000
0	-0,085	0,001	-0,042	0,000	0,000	0,000
50	0,002	-0,042	-0,020	-0,007	-0,026	-0,017
100	-0,003	-0,087	-0,045	-0,013	-0,061	-0,037
150	-0,005	-0,141	-0,073	-0,022	-0,108	-0,065
200	-0,014	-0,210	-0,112	-0,034	-0,164	-0,099
250	-0,050	-0,272	-0,161	-0,061	-0,227	-0,144
250	-0,152	-0,281	-0,217	-0,063	-0,234	-0,149
300	-0,209	-0,357	-0,283	-0,098	-0,296	-0,197
350	-0,273	-0,444	-0,359	-0,148	-0,371	-0,260
400	-0,381	-0,544	-0,463	-0,213	-0,455	-0,334
50	-0,115	-0,135	-0,125	-0,007	-0,131	-0,069
300	-0,262	-0,428	-0,345	-0,108	-0,362	-0,235
400	-0,402	-0,571	-0,487	-0,236	-0,481	-0,359
50	-0,106	-0,144	-0,125	-0,008	-0,140	-0,074
300	-0,268	-0,440	-0,354	-0,118	-0,375	-0,247
400	-0,408	-0,580	-0,494	-0,249	-0,491	-0,370
50	0,060	-0,145	-0,043	-0,010	-0,144	-0,077
300	-0,108	-0,445	-0,277	-0,126	-0,382	-0,254
400	-0,248	-0,586	-0,417	-0,260	-0,502	-0,381
400	-0,381	-0,606	-0,494	-0,398	-0,596	-0,497
400	-0,381	-0,607	-0,494	-0,397	-0,596	-0,497
400	-0,400	-0,631	-0,516	-0,360	-0,585	-0,473
400	-0,358	-0,644	-0,501	-0,336	-0,550	-0,443
400	-0,339	-0,653	-0,496	-0,337	-0,545	-0,441
400	-0,323	-0,663	-0,493	-0,361	-0,533	-0,447
400	-0,344	-0,660	-0,502	-0,362	-0,536	-0,449
400	-0,341	-0,660	-0,501	-0,363	-0,537	-0,450
400	-0,347	-0,667	-0,507	-0,366	-0,513	-0,440
400	-0,343	-0,663	-0,503	-0,366	-0,503	-0,435
400	-0,520	-0,709	-0,615	-0,394	-0,596	-0,495
400	-0,534	-0,701	-0,618	-0,410	-0,603	-0,507
400	-0,549	-0,698	-0,624	-0,408	-0,604	-0,506
400	-0,468	-0,702	-0,585	-0,396	-0,587	-0,492
400	-0,420	-0,697	-0,559	-0,392	-0,597	-0,495
450	-0,433	-0,714	-0,574	-0,402	-0,616	-0,509
500	-0,447	-0,728	-0,588	-0,410	-0,634	-0,522
550	-0,459	-0,740	-0,600	-0,422	-0,642	-0,532
600	-0,473	-0,765	-0,619	-0,433	-0,661	-0,547
650	-0,475	-0,784	-0,630	-0,442	-0,681	-0,562
700	-0,484	-0,815	-0,650	-0,458	-0,704	-0,581
750	-0,536	-0,826	-0,681	-0,467	-0,729	-0,598
800	-0,546	-0,846	-0,696	-0,458	-0,752	-0,605
850	-0,558	-0,861	-0,710	-0,490	-0,783	-0,637
900	-0,570	-0,879	-0,725	-0,509	-0,798	-0,654
950	-0,579	-0,889	-0,734	-0,543	-0,841	-0,692
1000	-0,577	-0,911	-0,744	-0,573	-0,889	-0,731
1050	-0,593	-0,946	-0,770	-0,605	-0,930	-0,768
1050	-0,611	-0,955	-0,783	-0,626	-0,962	-0,794
1100	-0,628	-0,973	-0,801	-0,648	-0,995	-0,822
1100	-0,636	-0,976	-0,806	-0,672	-1,016	-0,844
1150	-0,654	-0,977	-0,816	-0,786	-1,148	-0,967
1150	-0,667	-0,992	-0,830	-0,948	-1,191	-1,070
1200	-0,693	-1,019	-0,856	-1,351	-1,262	-1,307
1250	-0,726	-1,037	-0,882	-1,789	-1,434	-1,612
1250	-0,705	-1,055	-0,880	-2,393	-1,689	-2,041
1274	-0,711	-1,032	-0,872	-2,434	-1,706	-2,070
1300	-0,721	-1,070	-0,896	-2,487	-1,737	-2,112
1300	-0,758	-1,076	-0,917	-2,691	-1,815	-2,253
1326	-0,768	-1,087	-0,928	-2,726	-1,831	-2,279

obciążenie wspornika corbel load	odkształcenie na licu S S face strains			odkształcenie na licu N N face strains		
	13	14	średnia/ average	15	16	średnia/ average
	‰	‰	‰	‰	‰	‰
1350	-0,781	-1,096	-0,939	-2,781	-1,863	-2,322
1350	-0,808	-1,100	-0,954	-2,845	-1,897	-2,371
1375	-0,862	-1,112	-0,987	-2,988	-1,932	-2,460
1400	-0,878	-1,122	-1,000	-3,033	-1,954	-2,494
1400	-1,003	-1,140	-1,072	-3,198	-2,029	-2,614
1426	-1,015	-1,147	-1,081	-3,235	-2,044	-2,640
1450	-1,030	-1,158	-1,094	-3,274	-2,066	-2,670
1450	-1,226	-1,244	-1,235	-3,402	-2,143	-2,773
1475	-1,544	-1,360	-1,452	-3,509	-2,201	-2,855
1500	-1,594	-1,380	-1,487	-3,547	-2,224	-2,886
1525	-1,977	-1,823	-1,900	-3,750	-2,345	-3,048
1550	-1,997	-1,861	-1,929	-3,782	-2,365	-3,074
1576	-2,250	-2,178	-2,214	-4,086	-2,545	-3,316
1600	-2,267	-2,209	-2,238	-4,135	-2,581	-3,358
1625	-2,154	-2,400	-2,277	-4,947	-2,914	-3,931
1650	-1,313	-2,505	-1,909	-5,038	-2,963	-4,001
1674	-1,127	-2,752	-1,940	-4,509	-3,753	-4,131
1701	-1,119	-2,770	-1,945	-4,494	-3,832	-4,163
1714	-0,790	-2,782	-1,786	-4,318	-4,144	-4,231
1700	-0,515	-2,767	-1,641	-4,552	-4,552	-4,552
1654	-0,471	-2,680	-1,576	-4,354	-4,354	-4,354
1512	-0,471	-2,654	-1,563	-3,680	-3,680	-3,680

Beton – odkształcenia na licu po stronie S i N (ε_c) / Concrete – strains on face S and N side (ε_c)

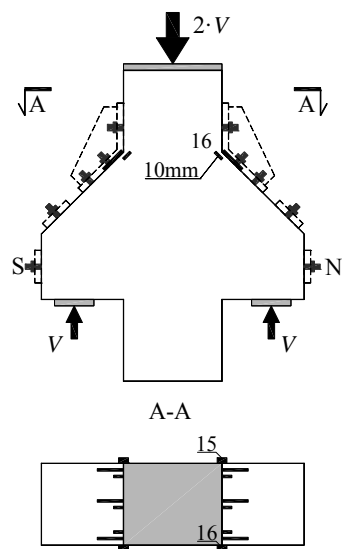
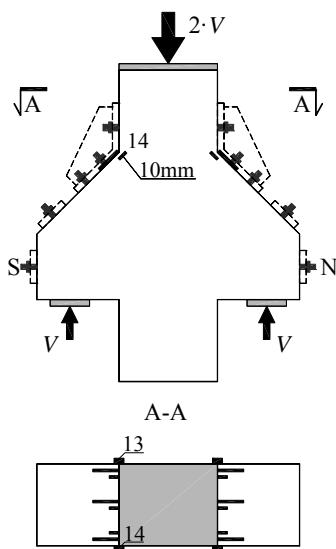
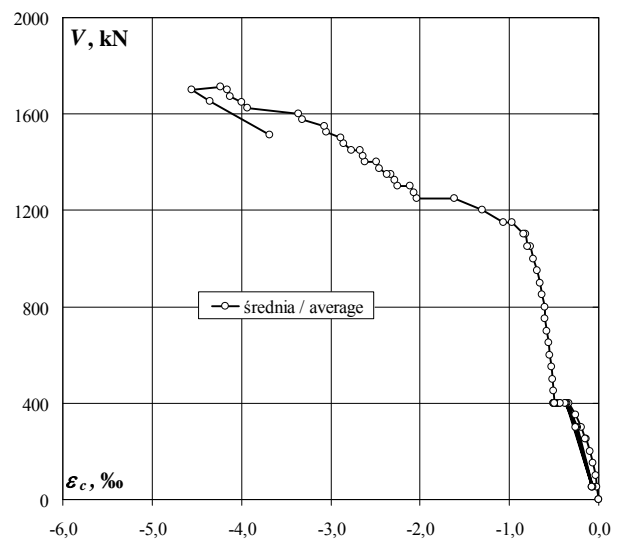
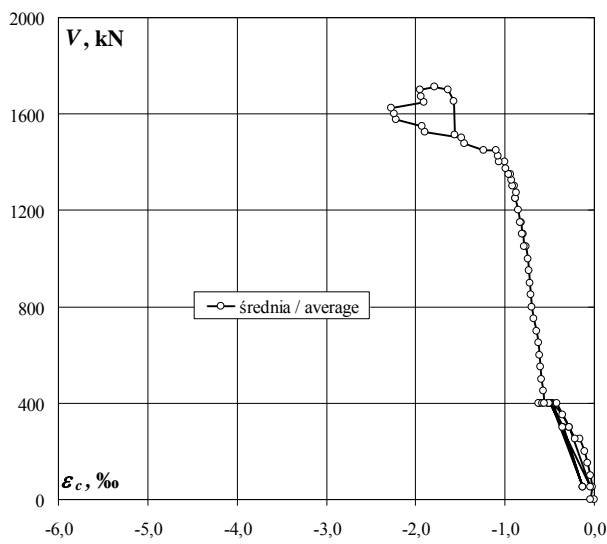
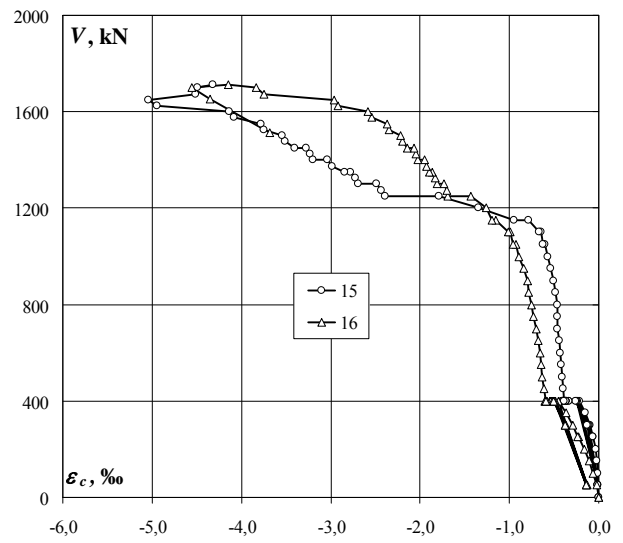
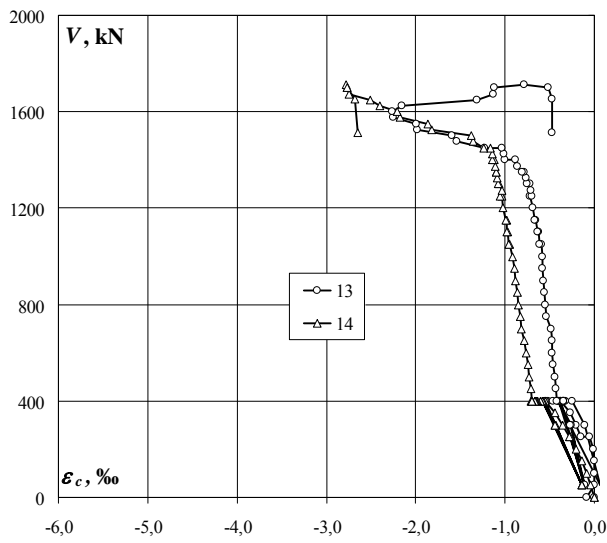

D-III

Zbrojenie główne – odkształcenia po stronie S i N (ϵ_s) / Main reinforcement – strains on S and N side (ϵ_s)

obciążenie wspornika corbel load	odkształcenie S S strain			odkształcenie N N strain		
	1	2	średnia/ average	3	4	średnia/ average
kN	‰	‰	‰	‰	‰	‰
0	0,000	0,000	0,000	0,000	0,000	0,000
0	0,002	0,000	0,001	0,002	0,003	0,003
50	0,046	0,021	0,034	0,027	0,043	0,035
100	0,081	0,079	0,080	0,104	0,148	0,126
150	0,101	0,259	0,180	0,246	0,311	0,279
200	0,109	0,505	0,307	0,414	0,510	0,462
250	0,111	0,690	0,401	0,699	0,763	0,731
250	0,160	0,687	0,424	0,757	0,807	0,782
300	0,512	0,834	0,673	0,974	1,780	1,377
350	0,935	1,046	0,991	1,281		1,281
400	1,300	1,238	1,269	1,540		1,540
50	0,239		0,239	0,785		0,785
300	1,307		1,307	1,364		1,364
400	1,633		1,633	1,609		1,609
50	0,454		0,454	0,811		0,811
300	1,547		1,547	1,420		1,420
400	1,819		1,819	1,635		1,635
50	0,567		0,567	0,803		0,803
300	1,674		1,674	1,442		1,442
400	1,915		1,915	1,649		1,649
400	1,886		1,886	1,744		1,744
400	1,886		1,886	1,714		1,714
400	1,864		1,864	1,794		1,794
400	1,833		1,833	1,819		1,819
400	1,796		1,796	1,788		1,788
400	1,696		1,696	1,460		1,460
400	1,694		1,694	1,379		1,379
400	1,694		1,694	1,404		1,404
400	1,703		1,703	1,359		1,359
400	1,705		1,705	1,407		1,407
400	1,800		1,800	1,438		1,438
400	1,718		1,718	1,483		1,483
400	1,511		1,511	1,461		1,461
400	1,794		1,794	1,570		1,570
400	1,869		1,869	1,585		1,585
450	1,907		1,907	1,619		1,619
500	1,885		1,885	1,726		1,726
550	1,907		1,907	1,786		1,786
600	1,947		1,947	1,807		1,807
650	2,055		2,055	1,844		1,844
700	2,097		2,097	1,925		1,925
750	2,165		2,165	1,974		1,974
800	2,213		2,213	2,027		2,027
850	2,271		2,271	2,102		2,102
900	2,307		2,307	2,156		2,156
950	2,368		2,368	2,248		2,248
1000	2,418		2,418	2,284		2,284
1050	2,467		2,467	2,375		2,375
1050	2,475		2,475	2,385		2,385
1100	2,526		2,526	2,405		2,405
1100	2,557		2,557	2,413		2,413
1150	2,612		2,612	2,518		2,518
1150	2,690		2,690	2,533		2,533
1200	2,794		2,794	2,601		2,601
1250	2,927		2,927	2,653		2,653
1250	3,046		3,046	2,705		2,705
1274	3,070		3,070	2,719		2,719
1300	3,114		3,114	2,743		2,743
1300	3,151		3,151	2,769		2,769
1326	3,179		3,179	2,783		2,783

obciążenie wspornika corbel load	odkształcenie S S strain			odkształcenie N N strain		
	1	2	średnia/ average	3	4	średnia/ average
kN	‰	‰	‰	‰	‰	‰
1350	3,217		3,217	2,816		2,816
1350	3,258		3,258	2,829		2,829
1375	3,328		3,328	2,851		2,851
1400	3,360		3,360	2,882		2,882
1400	3,441		3,441	2,906		2,906
1426	3,473		3,473	2,923		2,923
1450	3,505		3,505	2,946		2,946
1450	3,565		3,565	2,992		2,992
1475	3,636		3,636	3,024		3,024
1500	3,662		3,662	3,060		3,060
1525	3,824		3,824	3,105		3,105
1550	3,847		3,847	3,134		3,134
1576	4,025		4,025	3,237		3,237
1600	4,113		4,113	3,269		3,269
1625	4,386		4,386	3,252		3,252
1650	4,493		4,493	3,287		3,287
1674	4,843		4,843	3,731		3,731
1701	4,894		4,894	3,782		3,782
1714	4,945		4,945	3,913		3,913
1700	4,918		4,918	4,076		4,076
1654	4,869		4,869	4,168		4,168
1512	4,783		4,783	4,166		4,166

Zbrojenie główne – odkształcenia po stronie S i N (ϵ_s) / Main reinforcement – strains on S and N side (ϵ_s)

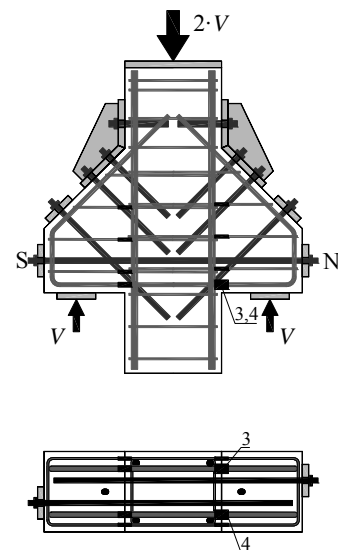
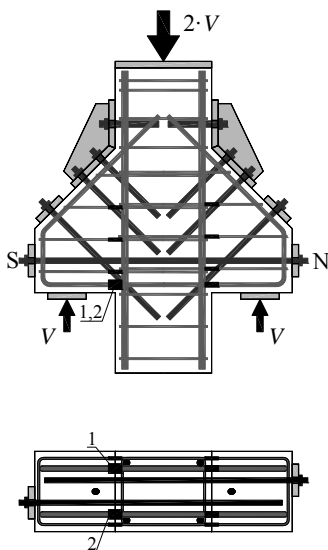
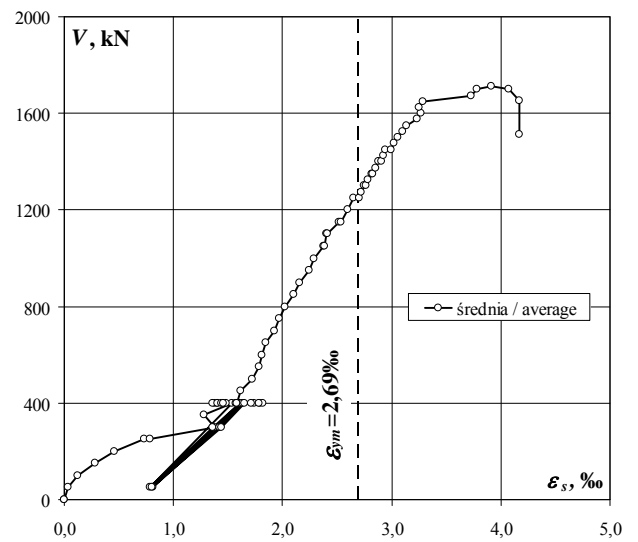
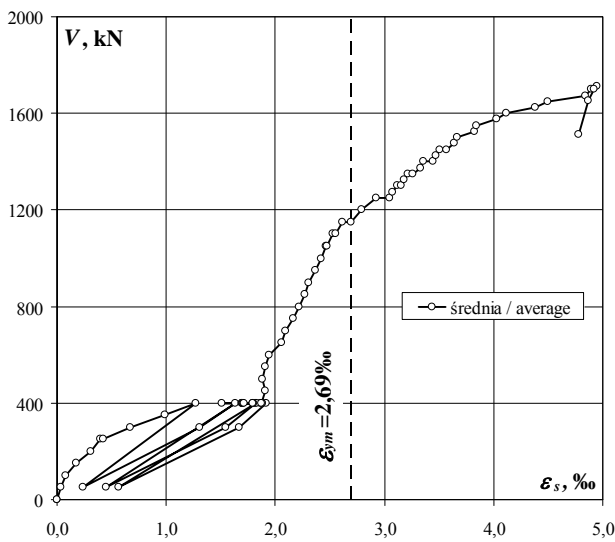
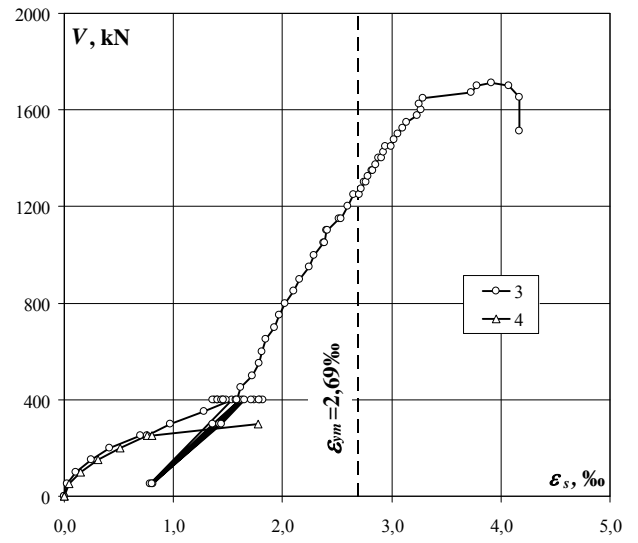
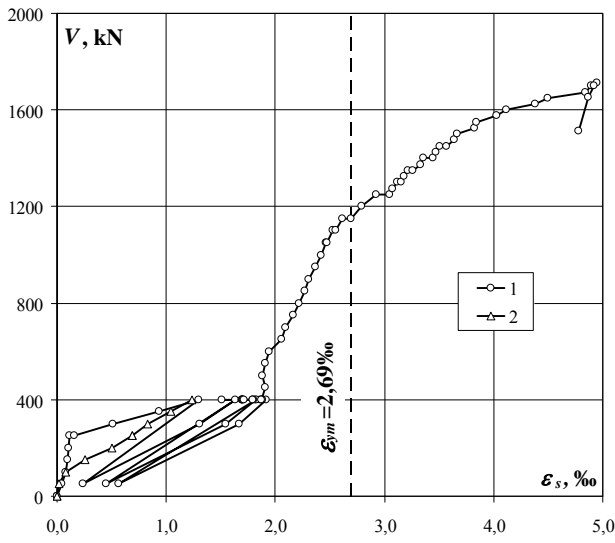

D-III

Strzemię 1 – odkształcenia po stronie S i N (ϵ_s) / Stirrup 1 – strains on S and N side (ϵ_s)

obciążenie wspornika corbel load	odkształcenie S S strain			odkształcenie N N strain		
	5	6	średnia/ average	7	8	średnia/ average
	%	%	%	%	%	%
0	0,000	0,000	0,000	0,000	0,000	0,000
0	0,000	0,144	0,072	0,000	0,077	0,039
50	0,026	0,466	0,246	0,011	-0,185	-0,087
100	0,122	0,386	0,254	0,045	-0,226	-0,091
150	0,297	0,563	0,430	0,145	-0,124	0,011
200	0,550	0,825	0,688	0,303	0,027	0,165
250	0,639	0,890	0,765	0,489	0,203	0,346
250	0,649	0,893	0,771	0,556	0,266	0,411
300	0,733	1,074	0,904	0,802	0,552	0,677
350	0,817	1,066	0,942	1,177	0,868	1,023
400	0,900	1,347	1,124	1,177	0,868	1,023
50	0,301	0,541	0,421	0,635	0,305	0,470
300	0,732	1,127	0,930	1,272	0,988	1,130
400	0,879	1,324	1,102	1,278	0,994	1,136
50	0,249	0,535	0,392	0,585	0,275	0,430
300	0,672	0,964	0,818	0,758	0,461	0,610
400	0,804	1,124	0,964	1,223	0,934	1,079
50	0,223	0,499	0,361	0,532	0,240	0,386
300	0,633	0,931	0,782	0,725	0,427	0,576
400	0,778	1,055	0,917	1,177	0,868	1,023
400	0,794	1,104	0,949	1,112	0,752	0,932
400	0,793	1,281	1,037	1,111	0,837	0,974
400	0,789	1,134	0,962	1,103	0,759	0,931
400	0,795	1,188	0,992	1,091	0,740	0,916
400	0,786	1,209	0,998	1,079	0,722	0,901
400	0,786	1,179	0,983	1,177	0,868	1,023
400	0,788	1,149	0,969	1,172	0,851	1,012
400	0,792	1,149	0,971	1,173	0,945	1,059
400	0,792	1,167	0,980	1,135	0,803	0,969
400	0,796	1,132	0,964	1,124	0,791	0,958
400	0,808	1,091	0,950	1,142	0,801	0,972
400	0,784	1,077	0,931	1,118	0,783	0,951
400	0,684	0,762	0,723	1,180	0,829	1,005
400	0,761	1,094	0,928	1,150	0,822	0,986
400	0,774	0,920	0,847	1,133	0,778	0,956
450	0,808	0,979	0,894	1,146	0,816	0,981
500	0,841	0,888	0,865	1,185	0,832	1,009
550	0,857	0,932	0,895	1,208	0,857	1,033
600	0,878	0,968	0,923	1,206	0,857	1,032
650	0,751	0,872	0,812	1,206	0,857	1,032
700	0,764	0,854	0,809	1,194	0,843	1,019
750	0,783	0,892	0,838	1,191	0,835	1,013
800	0,800	0,880	0,840	1,197	0,847	1,022
850	0,832	1,016	0,924	1,218	0,867	1,043
900	0,863	0,991	0,927	1,222	0,863	1,043
950	0,894	0,950	0,922	1,220	0,870	1,045
1000	0,923	1,051	0,987	1,213	0,862	1,038
1050	0,953	1,052	1,003	1,216	0,865	1,041
1050	0,957	0,992	0,975	1,212	0,854	1,033
1100	0,980	1,114	1,047	1,222	0,913	1,068
1100	0,979	1,012	0,996	1,218	0,862	1,040
1150	0,990	1,173	1,082	1,230	0,927	1,079
1150	0,988	1,171	1,080	1,223	0,825	1,024
1200	1,014	1,172	1,093	1,232	0,914	1,073
1250	1,035	1,150	1,093	1,236	1,312	1,274
1250	1,032	1,150	1,091	1,232	1,370	1,301
1274	1,043	1,156	1,100	1,240	1,369	1,305
1300	1,056	1,172	1,114	1,245	1,379	1,312
1300	1,052	1,175	1,114	1,215	1,339	1,277
1326	1,064	1,172	1,118	1,225	1,350	1,288

obciążenie wspornika corbel load	odkształcenie S S strain			odkształcenie N N strain		
	5	6	średnia/ average	7	8	średnia/ average
	%	%	%	%	%	%
1350	1,073	1,186	1,130	1,234	1,361	1,298
1350	1,076	1,187	1,132	1,241	1,368	1,305
1375	1,083	1,191	1,137	1,262	1,385	1,324
1400	1,093	1,204	1,149	1,273	1,401	1,337
1400	1,094	1,203	1,149	1,292	1,410	1,351
1426	1,107	1,218	1,163	1,302	1,422	1,362
1450	1,118	1,238	1,178	1,314	1,437	1,376
1450	1,119	1,223	1,171	1,324	1,454	1,389
1475	1,148	1,232	1,190	1,338	1,449	1,394
1500	1,157	1,252	1,205	1,346	1,458	1,402
1525	1,194	1,288	1,241	1,354	1,479	1,417
1550	1,202	1,312	1,257	1,364	1,488	1,426
1576	1,293	1,387	1,340	1,369	1,486	1,428
1600	1,315	1,410	1,363	1,380	1,505	1,443
1625	1,454	1,540	1,497	1,341	1,460	1,401
1650	1,484	1,582	1,533	1,339	1,456	1,398
1674	1,784	1,869	1,827	0,890	1,024	0,957
1701	1,812	1,914	1,863	0,872	0,995	0,934
1714	1,862	1,954	1,908	0,747	0,879	0,813
1700	2,052	2,144	2,098	0,689	0,819	0,754
1654	2,045	2,128	2,087	0,773	0,905	0,839
1512	2,021	2,113	2,067	0,725	0,853	0,789

Strzemię 1 – odkształcenia po stronie S i N (ϵ_s) / Stirrup 1 – strains on S and N side (ϵ_s)

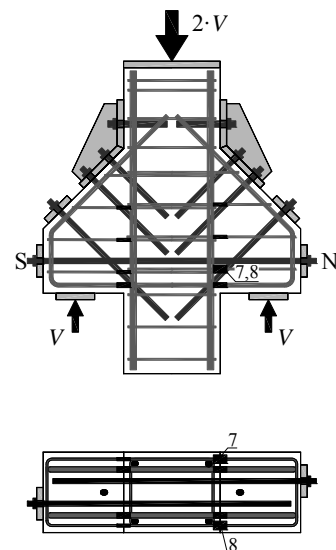
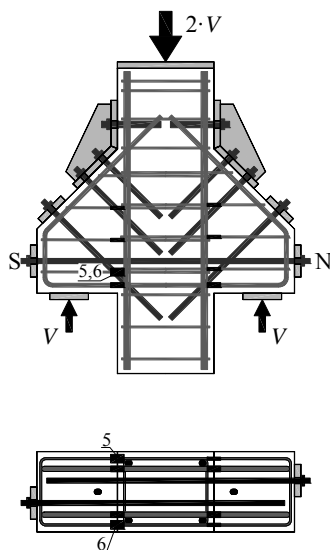
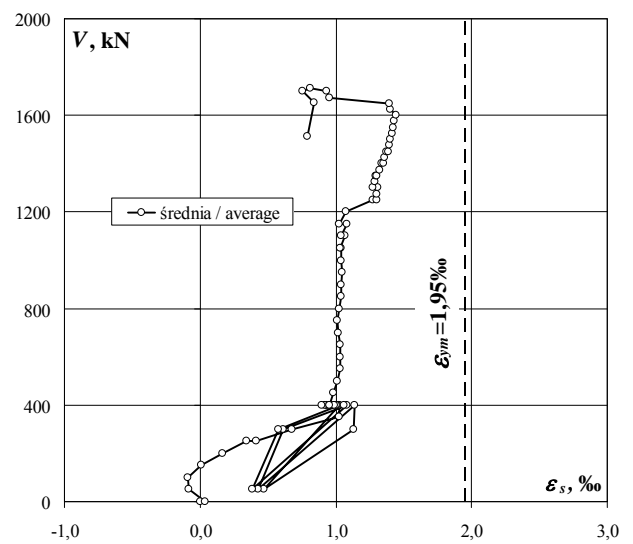
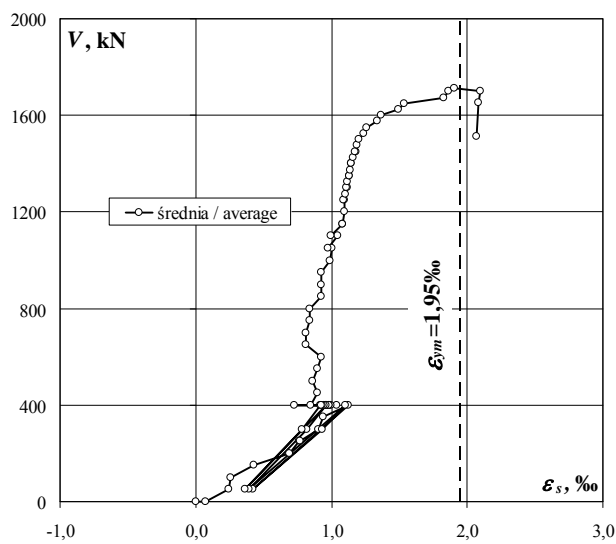
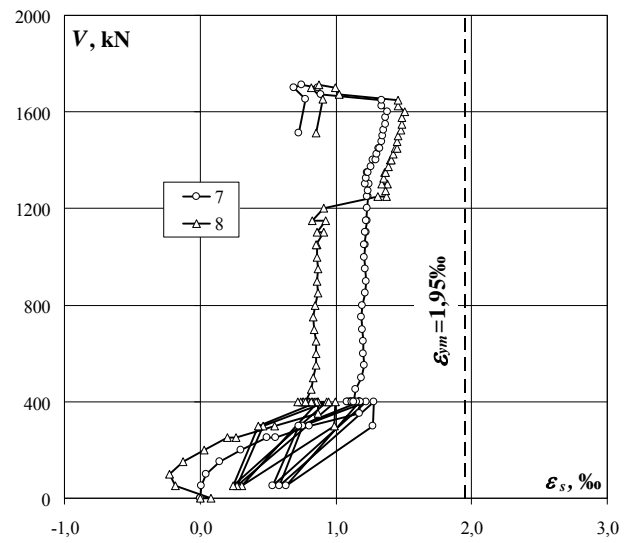
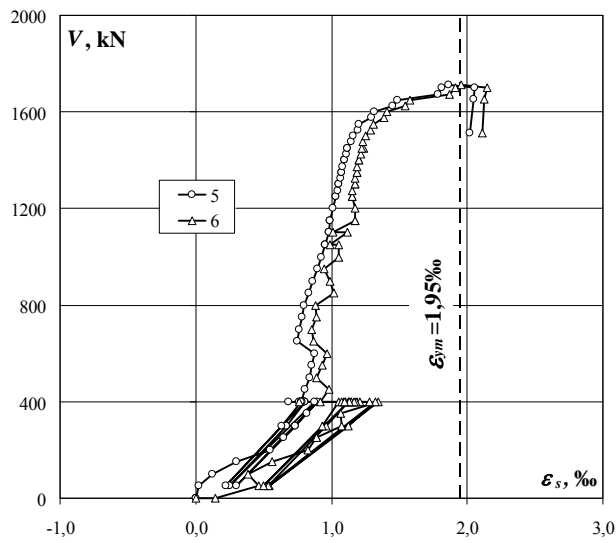

D-III

Strzemię 2 – odkształcenia po stronie S i N (ϵ_s) / Stirrup 2 – strains on S and N side (ϵ_s)

obciążenie wspornika corbel load	odkształcenie S S strain			odkształcenie N N strain		
	9	10	średnia/ average	11	12	średnia/ average
kN	‰	‰	‰	‰	‰	‰
0	0,000			0,000	0,000	0,000
0	-0,002			0,000	0,003	0,002
50	-0,004			0,004	0,005	0,005
100	0,026			0,022	0,014	0,018
150	0,129			0,051	0,040	0,046
200	0,278			0,128	0,100	0,114
250	0,459			0,399	0,250	0,325
250	0,479			0,453	0,292	0,373
300	0,649			0,596	0,388	0,492
350	0,700			0,774	0,523	0,649
400	0,754			0,895	0,685	0,790
50	0,186			0,439	0,447	0,443
300	0,783			0,785	0,669	0,727
400	0,977			0,949	0,794	0,872
50	0,314			0,460	0,482	0,471
300	0,919			0,836	0,733	0,785
400	1,075			0,989	0,843	0,916
50	0,362			0,474	0,494	0,484
300	0,976			0,872	0,768	0,820
400	1,113			1,019	0,880	0,950
400	1,149			1,055	0,934	0,995
400	1,149			1,058	0,934	0,996
400	1,148			1,063	0,941	1,002
400	1,145			1,065	0,951	1,008
400	1,132			1,065	0,959	1,012
400	1,133			1,060	0,985	1,023
400	1,128			1,062	0,993	1,028
400	1,129			1,062	0,992	1,027
400	1,129			1,060	0,992	1,026
400	1,130			1,064	0,997	1,031
400	1,293			1,098	1,055	1,077
400	1,252			1,077	1,047	1,062
400	1,022			1,050	0,998	1,024
400	1,181			1,103	1,038	1,071
400	1,227			1,118	1,047	1,083
450	1,247			1,140	1,063	1,102
500	1,272			1,175	1,088	1,132
550	1,313			1,215	1,111	1,163
600	1,276			1,257	1,110	1,184
650	1,164			1,287	1,133	1,210
700	1,156			1,315	1,264	1,290
750	1,158			1,376	1,353	1,365
800	1,158			1,292	1,423	1,358
850	1,175			1,262	1,491	1,377
900	1,192			1,264	1,524	1,394
950	1,212			1,274	1,549	1,412
1000	1,245			1,292	1,566	1,429
1050	1,273			1,310	1,571	1,441
1050	1,290			1,318	1,568	1,443
1100	1,310			1,331	1,581	1,456
1100	1,324			1,343	1,580	1,462
1150	1,330			1,358	1,592	1,475
1150	1,337			1,371	1,603	1,487
1200	1,360			1,399	1,614	1,507
1250	1,380			1,437	1,637	1,537
1250	1,398			1,479	1,654	1,567
1274	1,402			1,489	1,664	1,577
1300	1,413			1,500	1,668	1,584
1300	1,425			1,523	1,671	1,597
1326	1,432			1,534	1,675	1,605

obciążenie wspornika corbel load	odkształcenie S S strain			odkształcenie N N strain		
	9	10	średnia/ average	11	12	średnia/ average
kN	‰	‰	‰	‰	‰	‰
1350	1,439			1,544	1,679	1,612
1350	1,443			1,547	1,673	1,610
1375	1,460			1,572	1,676	1,624
1400	1,465			1,582	1,680	1,631
1400	1,474			1,585	1,669	1,627
1426	1,484			1,597	1,677	1,637
1450	1,492			1,606	1,677	1,642
1450	1,546			1,596	1,690	1,643
1475	1,541			1,599	1,674	1,637
1500	1,555			1,607	1,677	1,642
1525	1,603			1,585	1,682	1,634
1550	1,617			1,590	1,687	1,639
1576	1,688			1,552	1,697	1,625
1600	1,704			1,556	1,699	1,628
1625	1,789			1,469	1,769	1,619
1650	1,828			1,457	1,788	1,623
1674				1,145	1,980	1,563
1701				1,142	1,990	1,566
1714					2,023	2,023
1700					2,040	2,040
1654					2,029	2,029
1512					1,995	1,995

Strzemię 2 – odkształcenia po stronie S i N (ϵ_s) / Stirrup 2 – strains on S and N side (ϵ_s)

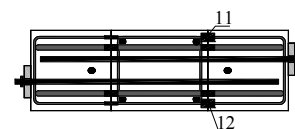
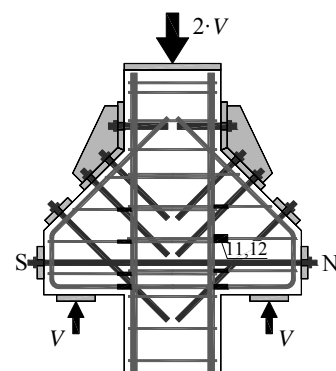
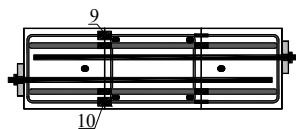
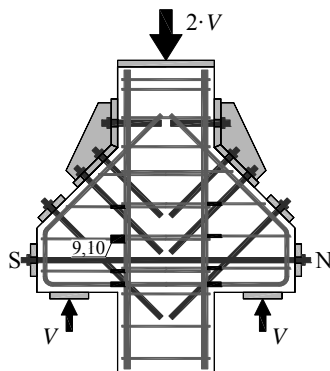
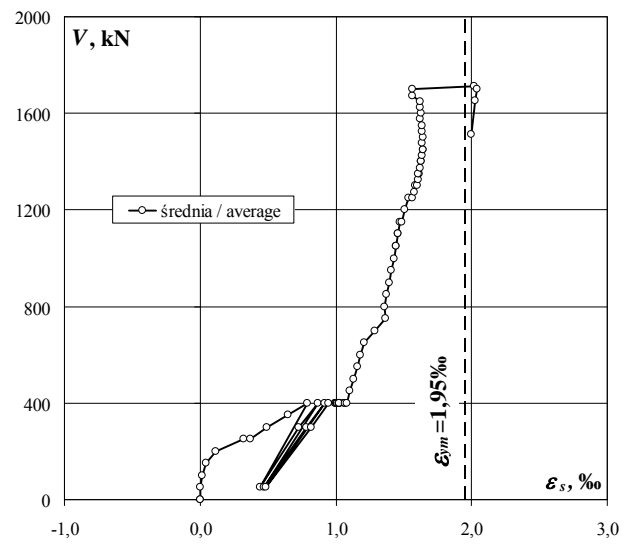
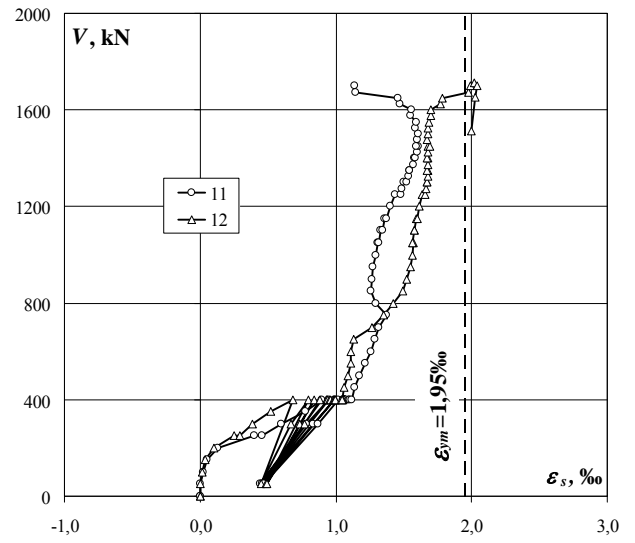
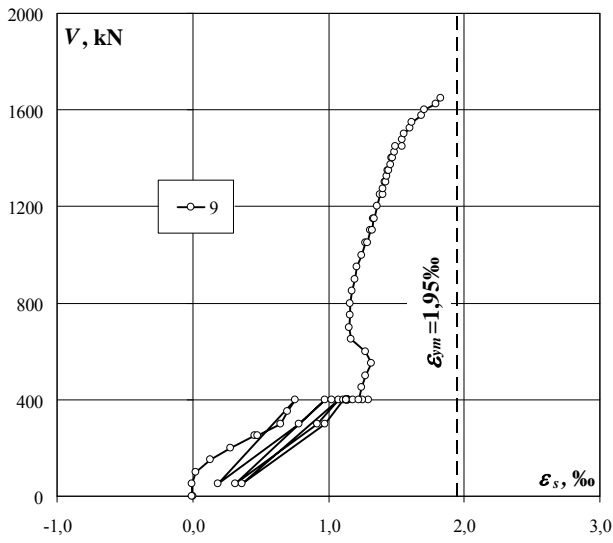

D-III

Strzemię 3 – odkształcenia po stronie S i N (ϵ_s) / Stirrup 3 – strains on S and N side (ϵ_s)

obciążenie wspornika corbel load	odkształcenie S S strain			odkształcenie N N strain		
	13	14	średnia/ average	15	16	średnia/ average
kN	‰	‰	‰	‰	‰	‰
0	0,000	0,000	0,000	0,000	0,000	0,000
0	0,000	0,001	0,001	-0,001	0,000	-0,001
50	-0,003	-0,013	-0,008	-0,010	-0,003	-0,007
100	-0,007	-0,023	-0,015	-0,004	-0,004	-0,004
150	-0,002	0,239	0,119	0,024	0,001	0,013
200	0,139	0,709	0,424	0,073	0,019	0,046
250	0,448	0,866	0,657	0,115	0,056	0,086
250	0,549	0,821	0,685	0,126	0,058	0,092
300	0,727	0,848	0,788	0,179	0,067	0,123
350	0,917	0,874	0,896	0,366	0,080	0,223
400	0,972	0,968	0,970	0,505	0,100	0,303
50	0,692	0,839	0,766	0,414	0,047	0,231
300	0,930	0,995	0,963	0,561	0,095	0,328
400	1,007	1,025	1,016	0,632	0,119	0,376
50	0,722	0,860	0,791	0,497	0,056	0,277
300	0,971	1,008	0,990	0,642	0,102	0,372
400	1,036	1,020	1,028	0,699	0,125	0,412
50	0,742	0,863	0,803	0,537	0,057	0,297
300	0,994	1,023	1,009	0,699	0,110	0,405
400	1,054	1,033	1,044	0,735	0,128	0,432
400	1,057	1,102	1,080	0,761	0,141	0,451
400	1,057	1,097	1,077	0,760	0,139	0,450
400	1,057	1,065	1,061	0,699	0,136	0,418
400	1,048	1,044	1,046	0,651	0,136	0,394
400	1,042	1,023	1,033	0,656	0,139	0,398
400	1,062	1,104	1,083	0,721	0,142	0,432
400	1,060	1,112	1,086	0,723	0,148	0,436
400	1,060	1,116	1,088	0,723	0,146	0,435
400	1,062	1,128	1,095	0,730	0,146	0,438
400	1,064	1,140	1,102	0,746	0,148	0,447
400	1,105	1,085	1,095	0,493	0,165	0,329
400	1,107	1,098	1,103	0,609	0,164	0,387
400	1,119	0,965	1,042	0,557	0,192	0,375
400	1,135	1,180	1,158	0,843	0,215	0,529
400	1,148	1,272	1,210	0,959	0,221	0,590
450	1,157	1,281	1,219	0,966	0,227	0,597
500	1,174	1,289	1,232	0,980	0,230	0,605
550	1,196	1,297	1,247	0,997	0,244	0,621
600	1,227	1,320	1,274	1,030	0,375	0,703
650	1,263		1,263	1,044	0,485	0,765
700	1,292		1,292	1,177	0,744	0,961
750	1,355		1,355	1,678	0,891	1,285
800	1,414		1,414		1,022	1,022
850	1,508		1,508		1,150	1,150
900	1,573		1,573		1,226	1,226
950	1,637		1,637		1,318	1,318
1000	1,644		1,644		1,432	1,432
1050	1,667		1,667		1,538	1,538
1050	1,679		1,679		1,575	1,575
1100	1,702		1,702		1,649	1,649
1100	1,709		1,709		1,685	1,685
1150	1,724		1,724		1,803	1,803
1150	1,749		1,749		1,875	1,875
1200	1,794		1,794		2,133	2,133
1250	1,855		1,855		2,730	2,730
1250	1,934		1,934		2,814	2,814
1274	1,942		1,942		2,686	2,686
1300	1,958		1,958		2,709	2,709
1300	2,000		2,000		2,369	2,369
1326	2,006		2,006		2,348	2,348

obciążenie wspornika corbel load	odkształcenie S S strain			odkształcenie N N strain		
	13	14	średnia/ average	15	16	średnia/ average
kN	‰	‰	‰	‰	‰	‰
1350	2,034		2,034		2,375	2,375
1350	2,059		2,059			
1375	2,112		2,112			
1400	2,138		2,138			
1400						
1426						
1450						
1450						
1475						
1500						
1525						
1550						
1576						
1600						
1625						
1650						
1674						
1701						
1714						
1700						
1654						
1512						

Strzemię 3 – odkształcenia po stronie S i N (ϵ_s) / Stirrup 3 – strains on S and N side (ϵ_s)

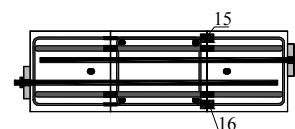
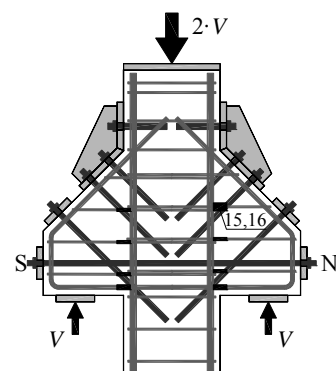
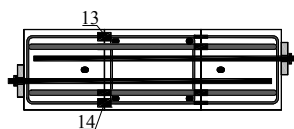
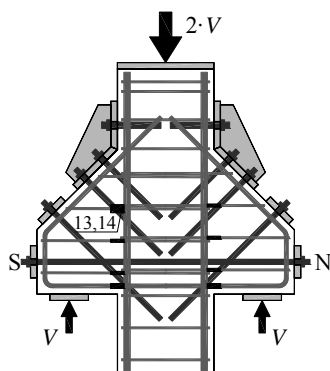
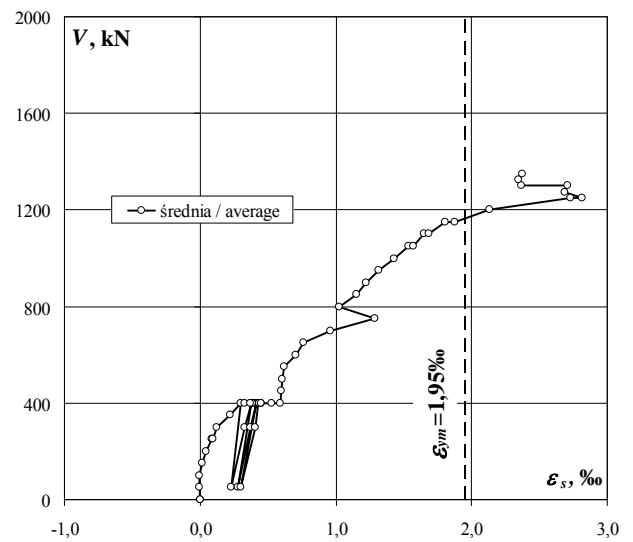
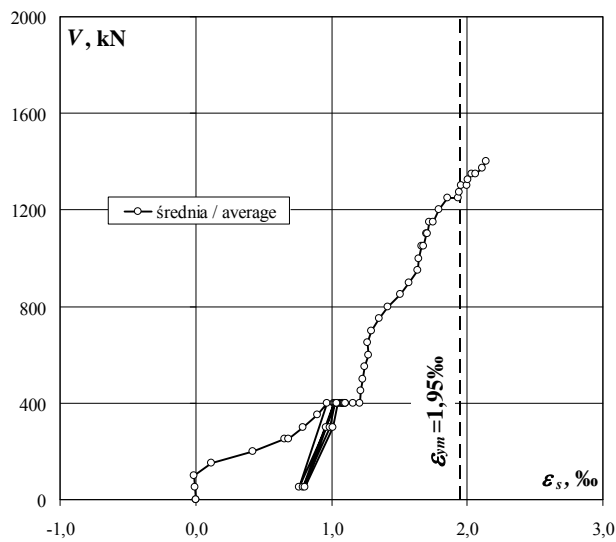
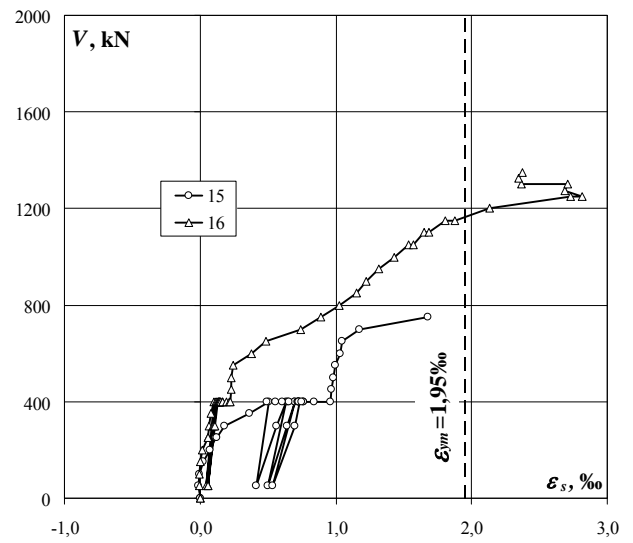
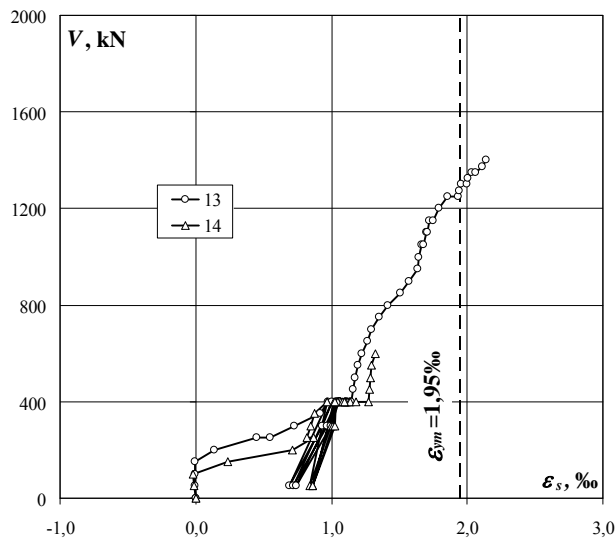

D-III

Szerokość rozwarcia rys / Crack width

obciążenie wspornika corbel load	Numer rysy / Crack number						
	1	2	3	4	5	6	7
	mm	mm	mm	mm	mm	mm	mm
250	0,15	0,10	0,08	0,10			
300	0,20	0,13	0,13	0,10			
350	0,22	0,20	0,15	0,12			
400	0,25	0,20	0,18	0,15			
50	0,12	0,10	0,08	0,05			
300	0,22	0,18	0,15	0,10			
400	0,25	0,25	0,20	0,17			
50	0,15	0,15	0,10	0,05			
300	0,25	0,20	0,17	0,10			
400	0,30	0,25	0,20	0,15			
50	0,15	0,12	0,10	0,05			
300	0,25	0,20	0,20	0,15			
400	0,33	0,25	0,22	0,15			
400	0,35	0,20	0,23	0,17			
450	0,35	0,25	0,25	0,17			
500	0,38	0,25	0,27	0,20			
550	0,40	0,25	0,30	0,20			
600	0,35	0,25	0,25	0,20			
650	0,40	0,27	0,25	0,20			
700	0,40	0,27	0,25	0,20			
750	0,40	0,27	0,27	0,20			
800	0,45	0,30	0,30	0,20	0,10		
850	0,45	0,32	0,32	0,20	0,15	0,17	
900	0,47	0,32	0,35	0,20	0,17	0,20	
950	0,47	0,32	0,35	0,20	0,17	0,20	
1000	0,47	0,35	0,35	0,20	0,20	0,23	
1050	0,50	0,35	0,35	0,20	0,20	0,25	
1100	0,50	0,35	0,35	0,20	0,20	0,25	
1150	0,53	0,37	0,35	0,20	0,22	0,27	
1200	0,53	0,35	0,35	0,22	0,25	0,30	0,20
1250	0,55	0,35	0,40	0,22	0,30	0,35	0,30
1300	0,60	0,40	0,40	0,22	0,40	0,40	0,35
1350	0,60	0,40	0,40	0,22	0,45	0,40	0,40
1400	0,60	0,45	0,40	0,22	0,50	0,45	0,45
1450	0,60	0,45	0,40	0,22	0,60	0,50	0,50
1500	0,60	0,45				0,60	0,65
1550	0,60	0,45				0,65	0,70
1600	0,60	0,45				0,65	0,75

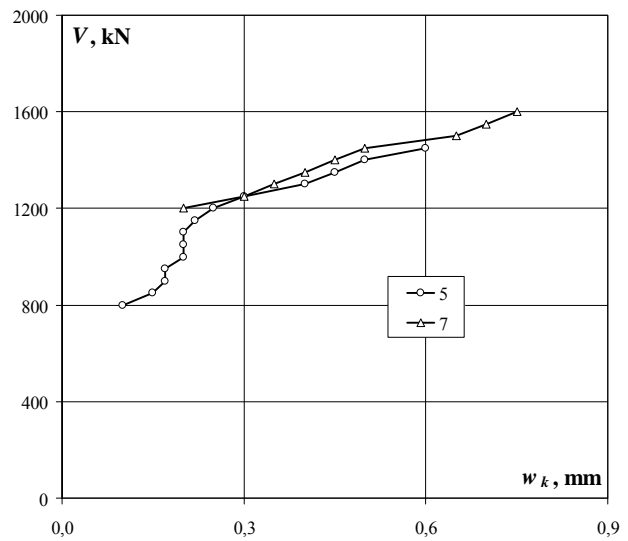
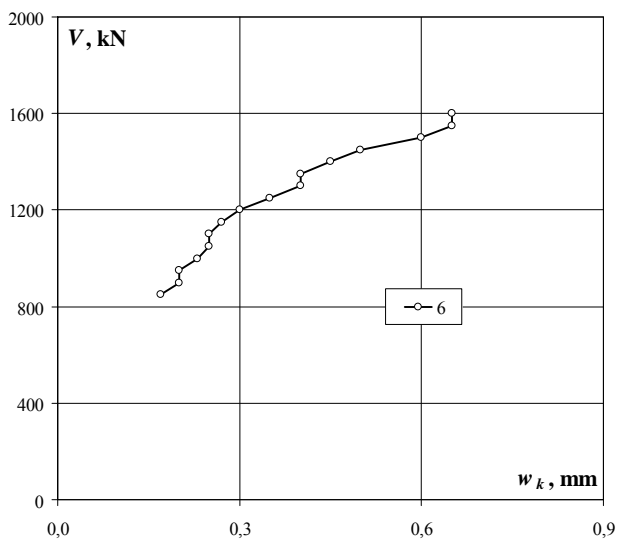
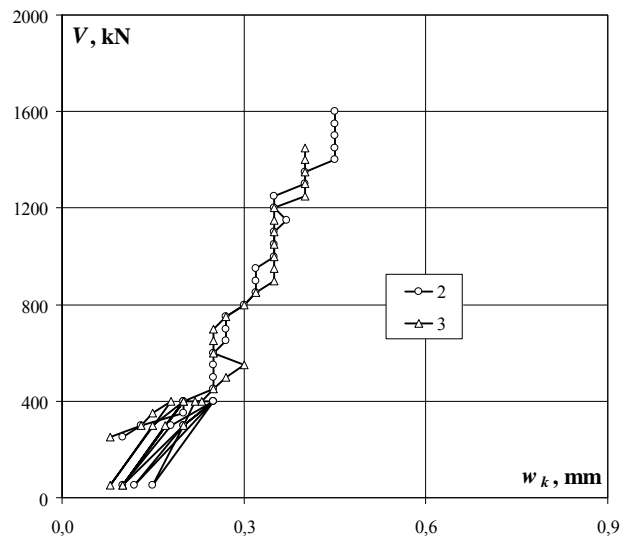
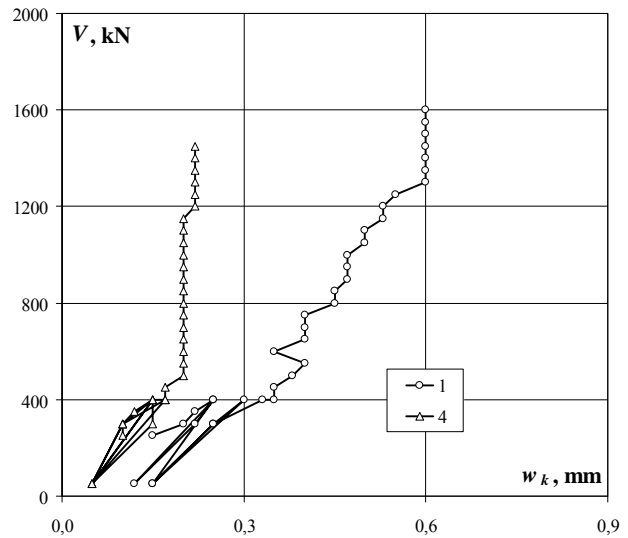

Układ rys przy sile 800kN / Crack pattern at 800kN

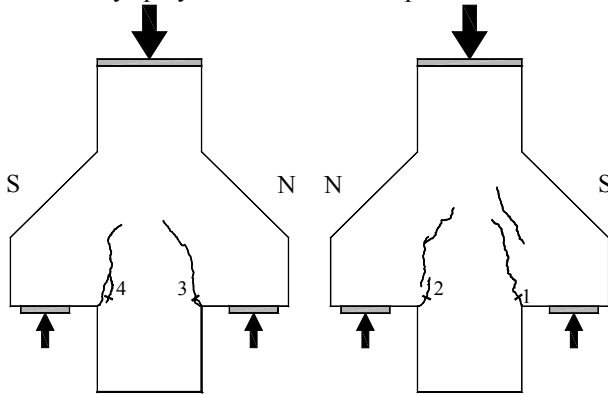

Układ rys przy sile 1400kN / Crack pattern at 1400kN

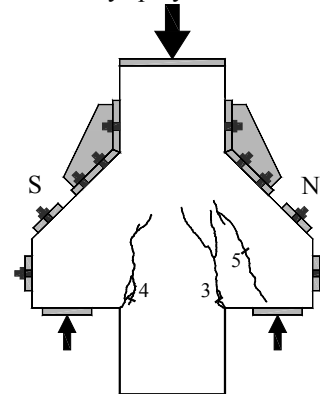

Układ rys przy sile 1600kN / Crack pattern at 1600kN

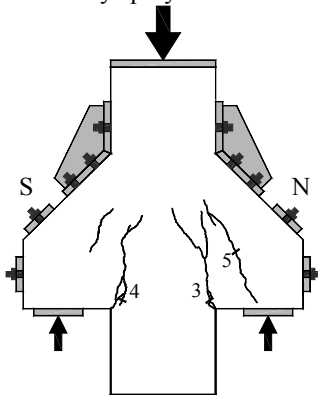

Układ rys przy sile 1800kN / Crack pattern at 1800kN

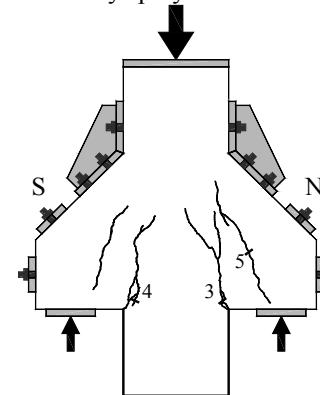

Układ rys przy sile 2000kN / Crack pattern at 2000kN

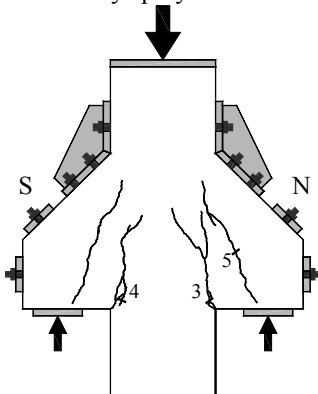

Układ rys przy sile 2500kN / Crack pattern at 2500kN

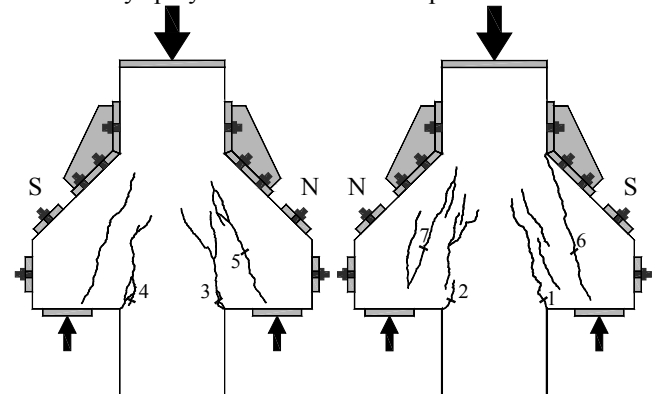

Układ rys przy sile 3300kN / Crack pattern at 3300kN

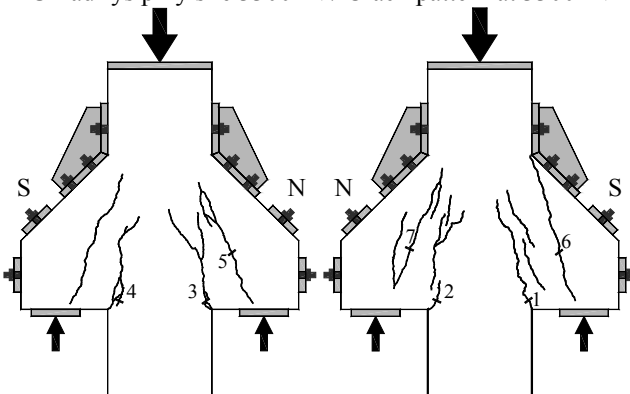

Układ rys przy sile 3430kN / Crack pattern at 3430kN

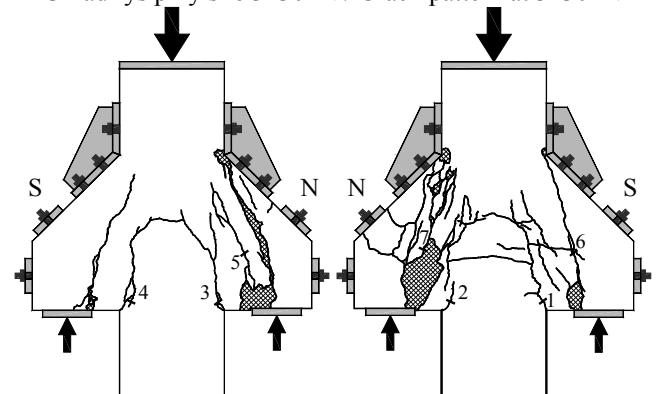

D-III



Klejenie blach
Gluing the steel plates



Wiązanie kleju
Curing the glue

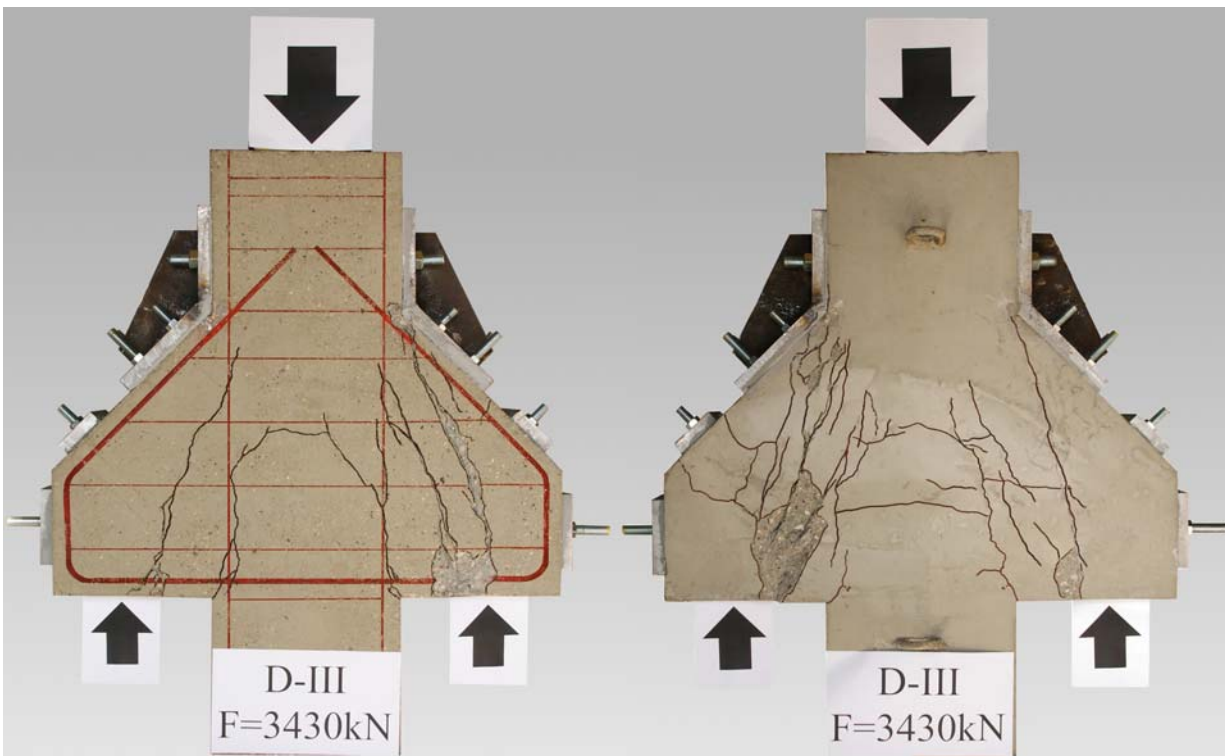

Wspornik po zniszczeniu / Corbel after failure

Przemieszczenie słupa względem wsporników / The relative displacement between the column and the corbels

obciążenie wspornika corbel load	Przemieszczenie Displacement	obciążenie wspornika corbel load	Przemieszczenie Displacement
	mm		mm
0	0,000	800	0,629
50	0,011	800	0,649
100	0,035	850	0,669
100	0,036	850	0,675
150	0,065	900	0,697
150	0,070	900	0,705
200	0,104	950	0,723
200	0,110	950	0,738
250	0,144	1000	0,763
250	0,152	1000	0,775
300	0,189	1050	0,798
300	0,197	1050	0,815
350	0,231	1100	0,836
350	0,252	1100	0,853
400	0,289	1150	0,894
400	0,304	1150	0,917
50	0,126	1200	0,951
50	0,124	1200	0,974
300	0,251	1250	1,004
300	0,255	1250	1,044
400	0,315	1300	1,076
400	0,324	1300	1,100
50	0,138	1350	1,136
50	0,136	1350	1,161
300	0,269	1400	1,189
300	0,273	1400	1,210
400	0,328	1450	1,266
400	0,335	1450	1,310
50	0,144	1500	1,356
50	0,141	1500	1,411
300	0,281	1550	1,461
300	0,283	1550	1,521
400	0,338	1600	1,562
	wzmocnienie strengthening	1600	1,639
		1650	1,750
400	0,425	1700	2,085
450	0,431	1700	2,200
450	0,432		
500	0,447		
500	0,447		
550	0,464		
550	0,468		
600	0,487		
600	0,501		
650	0,522		
650	0,531		
700	0,561		
700	0,570		
750	0,592		
750	0,599		

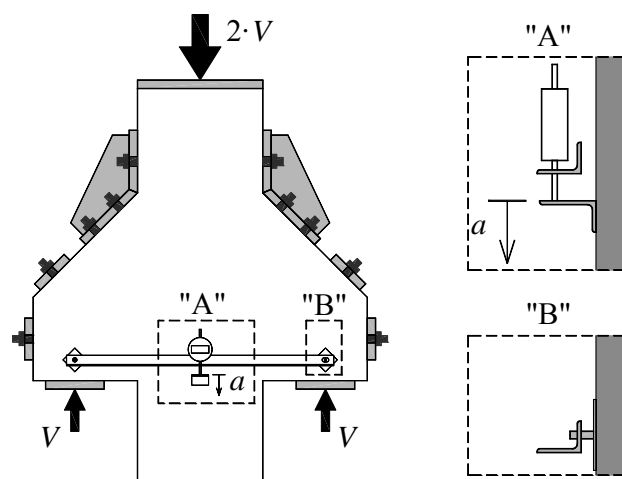
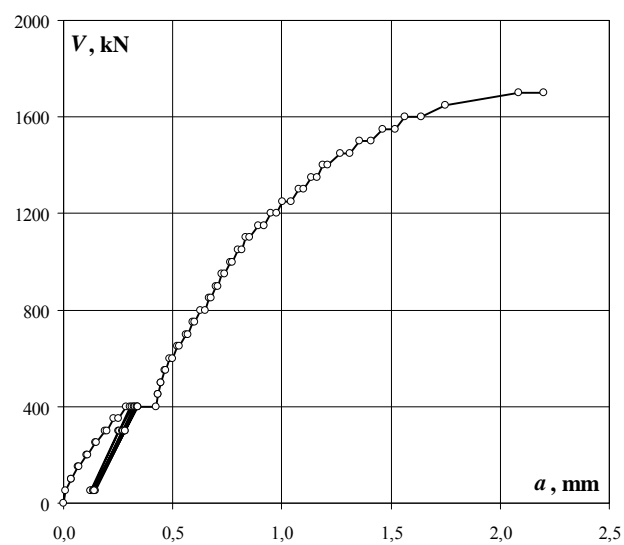

Seria E
E Series

Wykres $\sigma - \varepsilon$ dla: / $\sigma - \varepsilon$ diagram for:

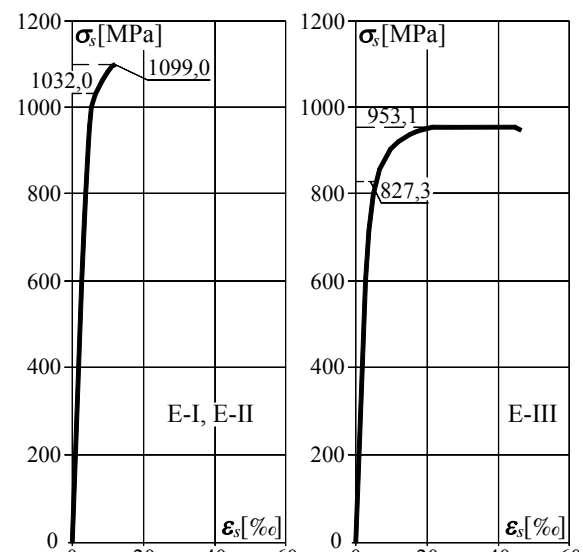
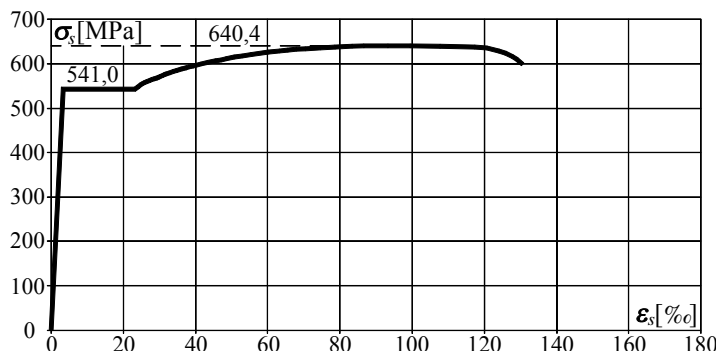
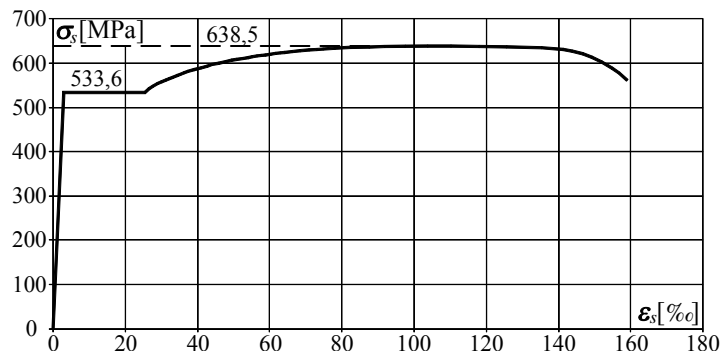
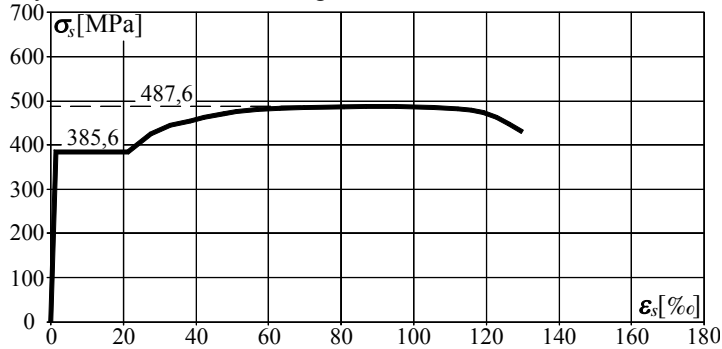

Tabele $\sigma - \varepsilon$ dla: / $\sigma - \varepsilon$ table for:

ε_s	σ_s	ε_s	σ_s
%	MPa	%	MPa
0	0	70	487,6
1,928	385,6	80	487,6
21,2	385,6	90	458,4
30	434,9	100	476,9
40	458,4	110	482,6
50	474,6	120	471,4
60	482,6	130	430,2

prętów Ø6 / bars Ø6, $A_s=28,07\text{mm}^2$

ε_s	σ_s	ε_s	σ_s
%	MPa	%	MPa
0	0	80	634,5
2,668	533,6	90	638,5
25,4	533,6	120	638,5
30	585,2	130	635,7
40	587,5	140	631,5
50	607,2	150	610,7
60	620,2	159,1	561,5
70	628,9		

prętów Ø16 / bars Ø16, $A_s=200,53\text{mm}^2$

ε_s	σ_s	ε_s	σ_s
%	MPa	%	MPa
0	0	70	633,4
2,705	541,0	80	638,0
23,1	541,0	90	640,4
30	571,2	100	640,4
40	596,9	110	639,0
50	613,4	120	634,7
60	626,1	130	600

prętów Ø20 / bars Ø20, $A_s=310,67\text{mm}^2$

ε_s	σ_s	ε_s	σ_s
%	MPa	%	MPa
0	0	5,353	1000
2,658	600	6,564	1032,0
3,191	700	10,00	1083,0
3,760	800	12,011	1099,0
4,412	900		

prętów M16 / rods M16 (E-I, E-II),
 $A_s=141,03\text{mm}^2$

ε_s	σ_s	ε_s	σ_s
%	MPa	%	MPa
0	0	9,665	900
2,746	600	21,47	953,1
3,530	700	44,57	953,1
4,918	800	46,30	946,4
5,791	827,3		

prętów M16 / rods M16 (E-III),
 $A_s=141,05\text{mm}^2$

Beton / Concrete

	f_{cm}	E_{cm}	$f_{ct,sp}$	ρ_c
	MPa	GPa	MPa	kg/m ³
średnia / average	47,28	28,18	3,90	2249
odchylenie standardowe / standard deviation	2,071	1,95	0,353	33,7
współczynnik zmienności / coefficient of variation	5,72%	6,92%	9,05%	1,50%
liczba próbek / number of specimens	15	16	16	28
minimalna wartość / minimum value	43,1	22,90	2,95	2220
maksymalna wartość / maximum value	51,3	31,10	4,60	2400

Rozwój wytrzymałości betonu w czasie / Development of the concrete strength in time

data / date	badany element / tested specimen	wiek / age	f_{cm}
		dni / days	MPa
2016-07-01	E-0	79	44,25
2016-07-06	E-I	84	49,30
2016-07-14	E-II	92	49,28
2016-07-28	E-III	106	45,35
średnia / average			47,28
odchylenie standardowe / standard deviation			2,071
współczynnik zmienności / coefficient of variation			5,72%
liczba próbek / number of specimens			15
minimalna wartość / minimum value			43,1
maksymalna wartość / maximum value			51,3

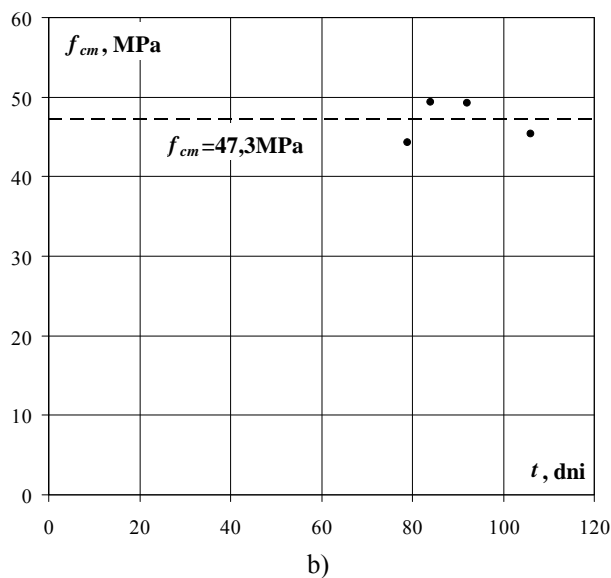
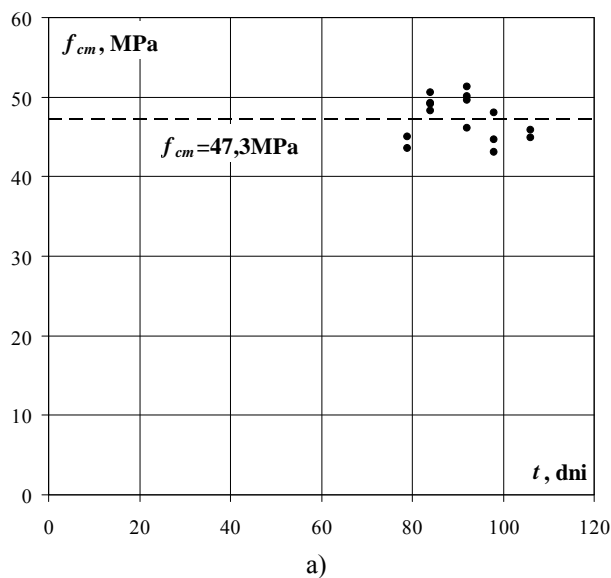

Rozwój wytrzymałości betonu w czasie: a) wyniki badań, b) średnie dzienne
Development of the concrete strength in time: a) test results, b) daily average

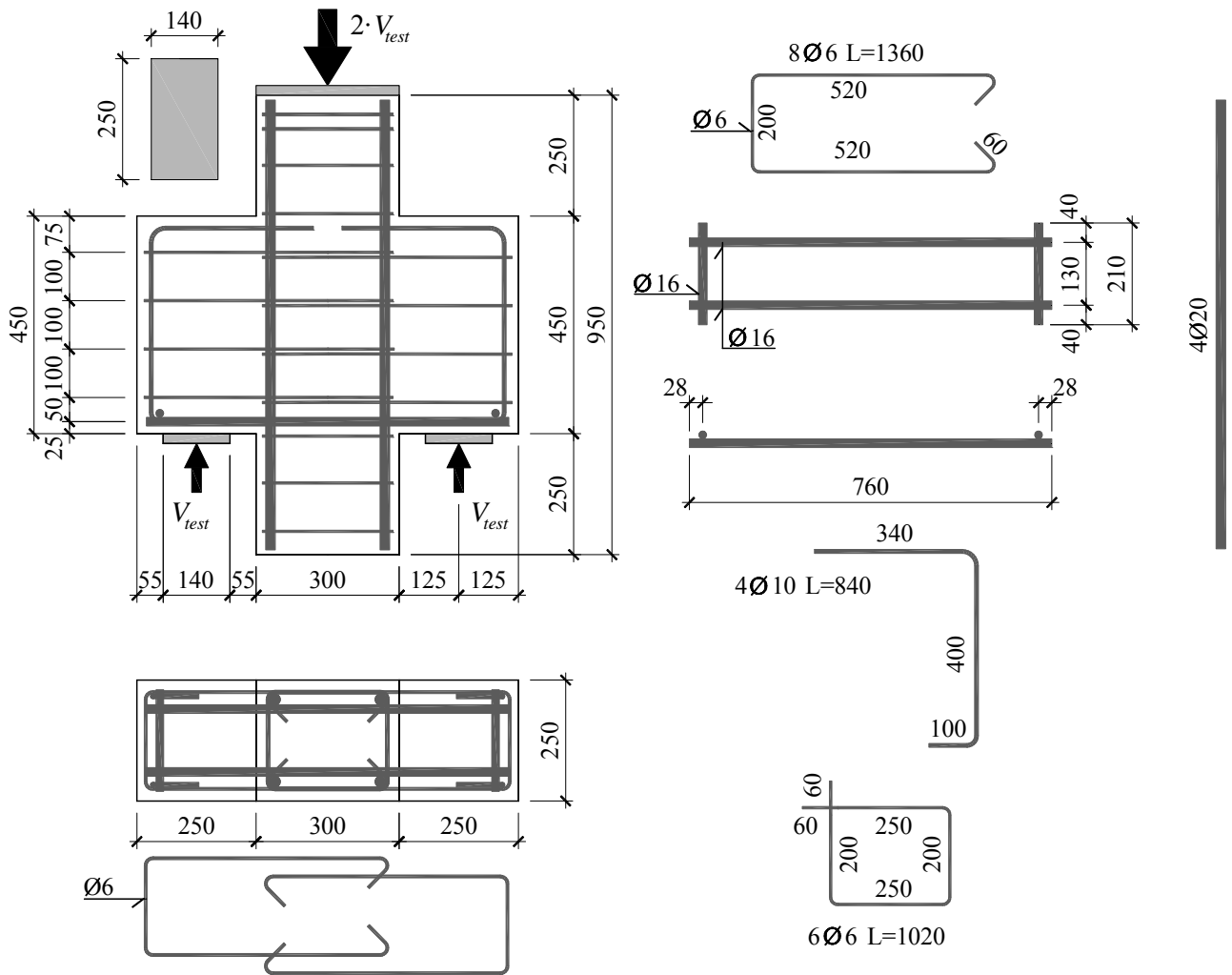

Zbrojenie modelu / Specimen's reinforcement

Wytrzymałość betonu na ściskanie / Compressive strength of concrete

$$f_{cm} = 47,3\text{MPa}$$

Moduł sprężystości podłużnej / Young's modulus

$$E_{cm} = 28,2\text{GPa}$$

Wytrzymałość betonu na rozciąganie przy rozłupywaniu / Tensile splitting strength of concrete

$$f_{ct,sp} = 3,9\text{MPa}$$

Gęstość betonu / Density of concrete

$$\rho = 2250\text{kg/m}^3$$

Charakterystyka zbrojenia / Characteristics of the reinforcement

Ø6

$$A_s = 28,07\text{mm}^2, f_{ym} = 385,6\text{MPa}, f_{tm} = 487,6\text{MPa}$$

Ø16

$$A_s = 200,53\text{mm}^2, f_{ym} = 533,6\text{MPa}, f_{tm} = 638,5\text{MPa}$$

Ø20

$$A_s = 310,67\text{mm}^2, f_{ym} = 541,0\text{MPa}, f_{tm} = 640,4\text{MPa}$$

Siła niszcząca / Failure force

$$V_{test} = 1146\text{kN}$$

E-0

Beton – odkształcenia po stronie S i N (na wsporniku) (ϵ_c) / Concrete – strains on S and N side (on the corbel) (ϵ_c)

obciążenie wspornika corbel load	odkształcenie S S strain				odkształcenie N N strain			
	1	2	3	średnia/ average	4	5	6	średnia/ average
kN	‰	‰	‰	‰	‰	‰	‰	‰
0	0,000	0,000	0,000	0,000	0,000	0,000	0,000	0,000
50	0,027	0,002	0,011	0,013	0,000	-0,011	-0,010	-0,007
100	0,038	-0,005	0,040	0,024	-0,002	-0,033	-0,032	-0,022
150	-0,002	-0,036	0,010	-0,009	-0,012	-0,072	-0,076	-0,053
200	-0,051	-0,074	-0,054	-0,060	-0,043	-0,132	-0,152	-0,109
250	-0,084	-0,097	-0,064	-0,082	-0,063	-0,182	-0,208	-0,151
300	-0,108	-0,110	-0,077	-0,098	-0,066	-0,208	-0,242	-0,172
350	-0,085	-0,110	-0,041	-0,079	-0,068	-0,234	-0,265	-0,189
400	-0,081	-0,113	-0,016	-0,070	-0,067	-0,255	-0,293	-0,205
450	-0,074	-0,114	0,011	-0,059	-0,077	-0,283	-0,315	-0,225
500	-0,080	-0,121	0,038	-0,054	-0,091	-0,307	-0,334	-0,244
550	-0,049	-0,129	0,066	-0,037	-0,095	-0,332	-0,349	-0,259
600	-0,043	-0,137	0,119	-0,020	-0,096	-0,360	-0,364	-0,273
650	0,160	-0,037	0,379	0,167	-0,091	-0,378	-0,355	-0,275
700	0,225	-0,023	0,488	0,230	-0,102	-0,409	-0,366	-0,292
750	0,267	-0,015	0,552	0,268	-0,111	-0,441	-0,371	-0,308
800	0,280	-0,012	0,620	0,296	-0,112	-0,477	-0,367	-0,319
850	0,305	-0,005	0,668	0,323	-0,106	-0,508	-0,350	-0,321
900	0,339	0,002	0,755	0,365	-0,060	-0,521	-0,310	-0,297
950	0,389	0,021	0,837	0,416	0,303	-0,416	0,025	-0,029
975	0,401	0,033	0,892	0,442	0,346	-0,429	0,061	-0,007
1003	0,462	0,044	0,973	0,493	0,410	-0,459	0,129	0,027
1024	0,461	0,040	0,972	0,491	0,402	-0,471	0,123	0,018
1049	0,437	0,060	1,058	0,518	0,492	-0,506	0,209	0,065
1078	0,444	0,054	1,063	0,520	0,486	-0,523	0,200	0,054
1102	0,574	0,099	1,268	0,647	0,636	-0,577	0,250	0,103
1127	0,569	0,096	1,261	0,642	0,630	-0,594	0,235	0,090
1146	0,582	0,108	1,279	0,656	0,648	-0,639	0,221	0,077
1133	0,366	0,368	1,103	0,612	0,854	-0,514	0,192	0,177
1087	0,216	0,239	0,974	0,476	0,875	-0,466	0,194	0,201
559	-0,065	0,033	-0,653	-0,228	1,129	0,233	0,080	0,481

Beton – odkształcenia po stronie S i N (na wsporniku) (ϵ_c) / Concrete – strains on S and N side (on the corbel) (ϵ_c)

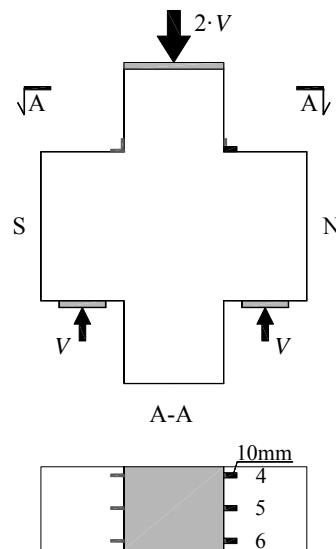
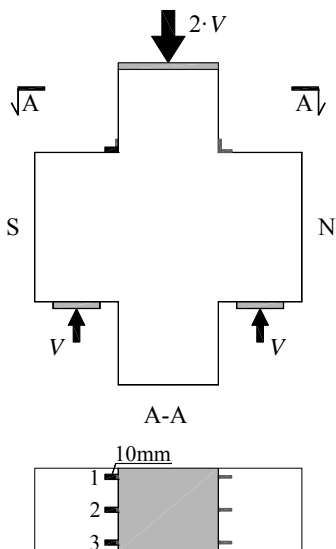
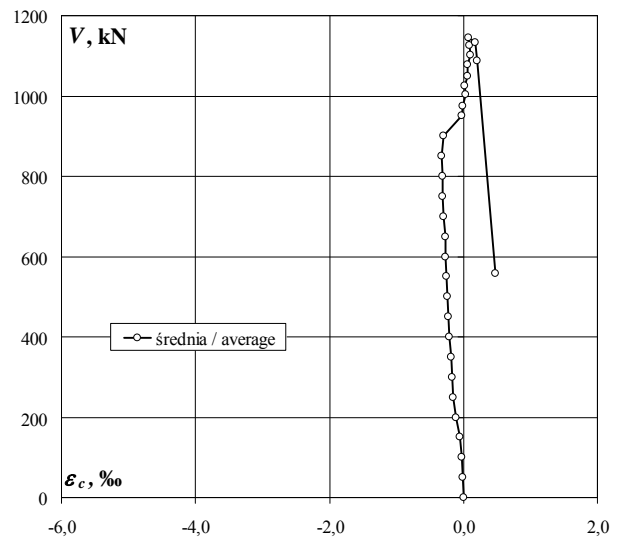
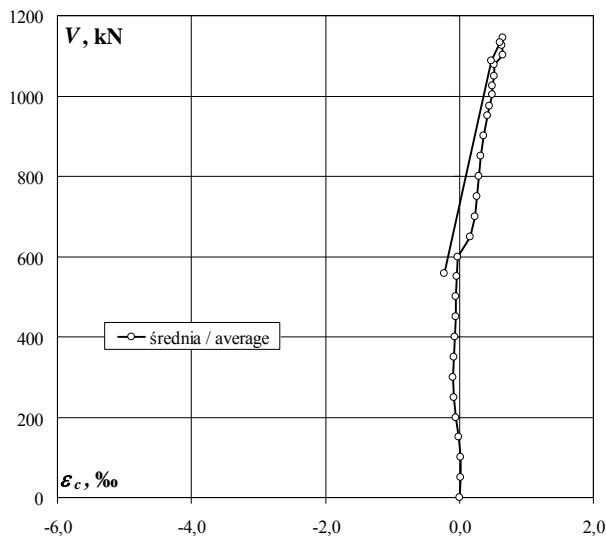
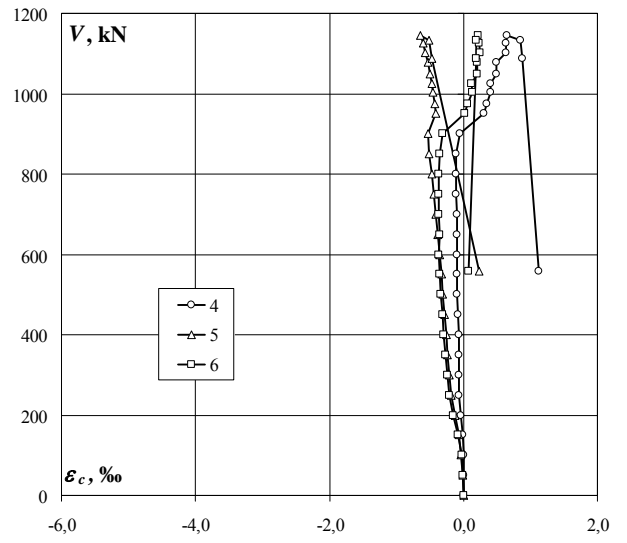
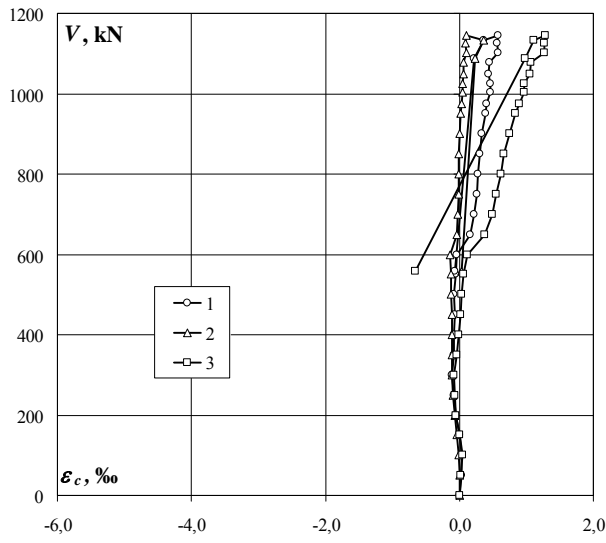

E-0

Beton – odkształcenia po stronie S i N (na słupie) (ϵ_c) / Concrete – strains on S and N side (on the column) (ϵ_c)

obciążenie wspornika corbel load	odkształcenie S S strain				odkształcenie N N strain			
	7	8	9	średnia/ average	10	11	12	średnia/ average
kN	‰	‰	‰	‰	‰	‰	‰	‰
0	0,000	0,000	0,000	0,000	0,000	0,000	0,000	0,000
50	-0,003	-0,021	0,000	-0,008	0,002	-0,011	-0,005	-0,005
100	-0,009	-0,048	-0,012	-0,023	0,009	-0,031	-0,013	-0,012
150	-0,015	-0,092	-0,038	-0,048	0,010	-0,067	-0,026	-0,028
200	-0,034	-0,160	-0,085	-0,093	-0,007	-0,108	-0,066	-0,060
250	-0,100	-0,234	-0,150	-0,161	-0,051	-0,153	-0,129	-0,111
300	-0,184	-0,304	-0,215	-0,234	-0,115	-0,203	-0,207	-0,175
350	-0,281	-0,381	-0,294	-0,319	-0,178	-0,253	-0,286	-0,239
400	-0,369	-0,473	-0,385	-0,409	-0,245	-0,304	-0,368	-0,306
450	-0,460	-0,554	-0,478	-0,497	-0,308	-0,354	-0,459	-0,374
500	-0,546	-0,633	-0,572	-0,584	-0,370	-0,397	-0,552	-0,440
550	-0,629	-0,717	-0,674	-0,673	-0,440	-0,434	-0,658	-0,511
600	-0,692	-0,800	-0,782	-0,758	-0,509	-0,472	-0,771	-0,584
650	-0,931	-1,053	-1,120	-1,035	-0,585	-0,517	-0,921	-0,674
700	-1,055	-1,211	-1,290	-1,185	-0,575	-0,558	-1,044	-0,726
750	-1,171	-1,337	-1,450	-1,319	-0,614	-0,599	-1,179	-0,797
800	-1,301	-1,474	-1,631	-1,469	-0,691	-0,647	-1,336	-0,891
850	-1,450	-1,619	-1,826	-1,632	-0,781	-0,703	-1,513	-0,999
900	-1,543	-1,772	-2,035	-1,783	-0,899	-0,773	-1,727	-1,133
950	-1,724	-1,961	-2,259	-1,981	-1,346	-1,091	-2,565	-1,667
975	-1,859	-2,088	-2,401	-2,116	-1,429	-1,192	-2,724	-1,782
1003	-2,045	-2,245	-2,592	-2,294	-1,566	-1,319	-2,877	-1,921
1024	-2,069	-2,275	-2,625	-2,323	-1,583	-1,336	-2,898	-1,939
1049	-2,345	-2,473	-2,859	-2,559	-1,798	-1,567	-2,923	-2,096
1078	-2,374	-2,513	-2,900	-2,596	-1,820	-1,591	-2,951	-2,121
1102	-2,753	-2,815	-3,209	-2,926	-2,048	-1,945	-3,065	-2,353
1127	-2,783	-2,853	-3,250	-2,962	-2,069	-1,968	-3,089	-2,375
1146	-2,869	-2,925	-3,342	-3,045	-2,141	-2,010	-3,123	-2,425
1133	-1,461	-3,211	-4,782	-3,151	-2,193	-2,264	-3,313	-2,590
1087	-1,334	-3,016	-4,713	-3,021	-2,167	-2,242	-3,287	-2,565
559	-1,152	-1,561	-4,117	-2,277	-1,812	-1,763	-2,721	-2,099

Beton – odkształcenia po stronie S i N (na słupie) (ϵ_c) / Concrete – strains on S and N side (on the column) (ϵ_c)

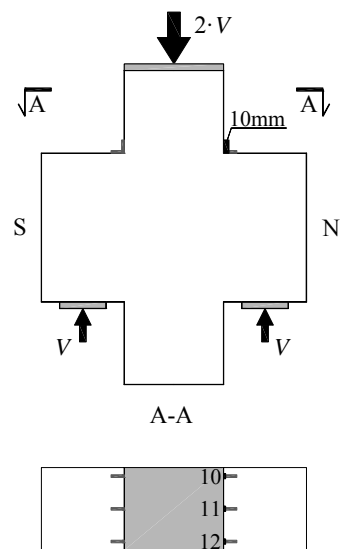
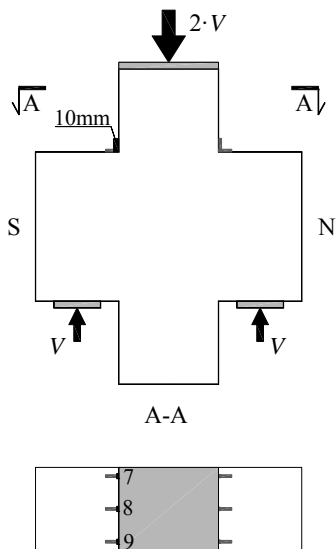
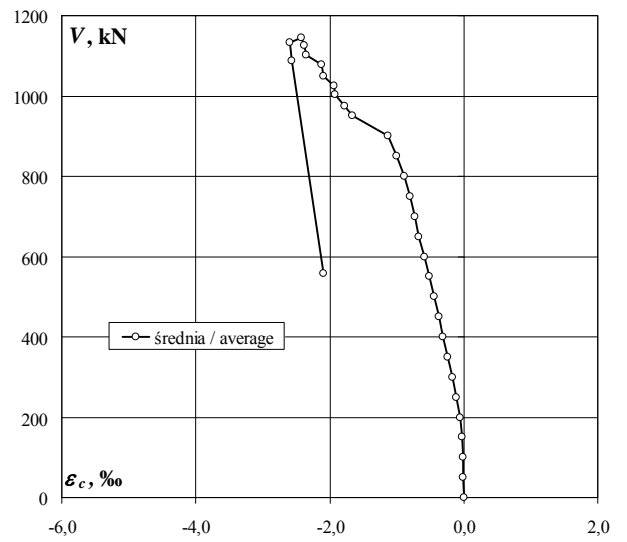
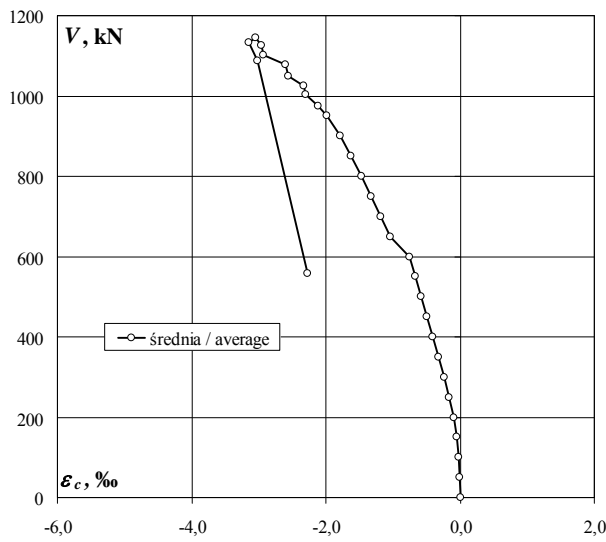
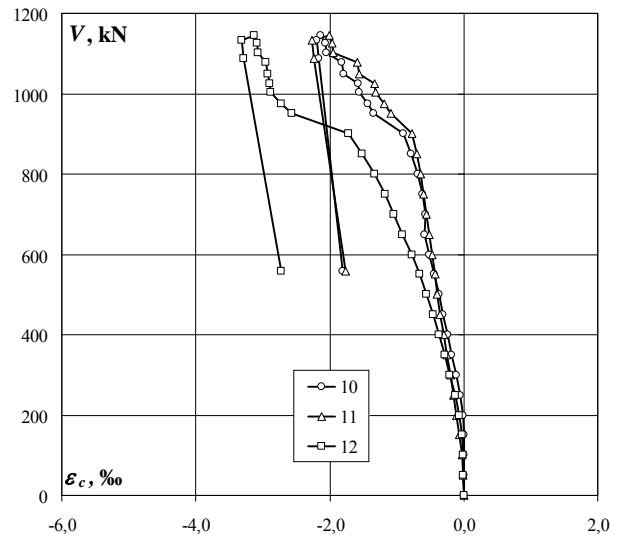
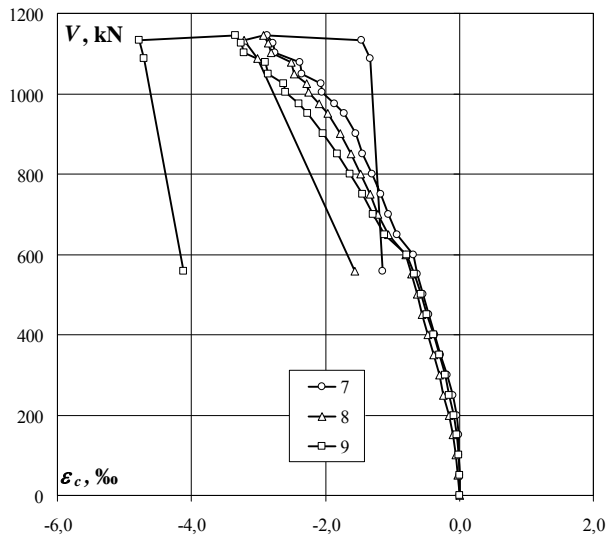

E-0

Zbrojenie główne – odkształcenia po stronie S i N (ε_s) / Main reinforcement – strains on S and N side (ε_s)

obciążenie wspornika corbel load	odkształcenie S S strain			odkształcenie N N strain		
	1	2	średnia/ average	3	4	średnia/ average
kN	‰	‰	‰	‰	‰	‰
0	0,000	0,000	0,000	0,000	0,000	0,000
50	0,031	0,029	0,030	0,032	0,034	0,033
100	0,090	0,070	0,080	0,094	0,089	0,092
150	0,250	0,212	0,231	0,234	0,235	0,235
200	0,465	0,425	0,445	0,495	0,573	0,534
250	0,852	0,711	0,782	0,703	0,797	0,750
300		0,851	0,851	0,962	1,104	1,033
350		1,073	1,073	1,125	1,277	1,201
400		1,273	1,273	1,292	1,447	1,370
450		1,344	1,344	1,427	1,600	1,514
500		1,460	1,460	1,555	1,735	1,645
550		1,566	1,566	1,680	1,858	1,769
600		1,674	1,674	1,791	1,975	1,883
650		1,971	1,971	1,833	2,010	1,922
700		2,095	2,095	1,959	2,108	2,034
750		2,195	2,195	2,067	2,193	2,130
800		2,302	2,302	2,153	2,293	2,223
850		2,463	2,463	2,255	2,415	2,335
900		2,689	2,689	2,358	2,560	2,459
950		2,937	2,937	2,627	4,092	3,360
975		3,119	3,119	2,720	5,074	3,897
1003		3,602	3,602	3,340	7,474	5,407
1024		3,631	3,631	3,373	7,567	5,470
1049		4,449	4,449	4,061	12,589	8,325
1078		4,507	4,507	4,100	12,798	8,449
1102		8,306	8,306	5,944	17,591	11,768
1127		8,383	8,383	6,222	18,256	12,239
1146		9,294	9,294	7,240		7,240
1133		11,485	11,485	11,803		11,803
1087		11,010	11,010	11,759		11,759
559				10,626		10,626

Zbrojenie główne – odkształcenia po stronie S i N (ϵ_s) / Main reinforcement – strains on S and N side (ϵ_s)

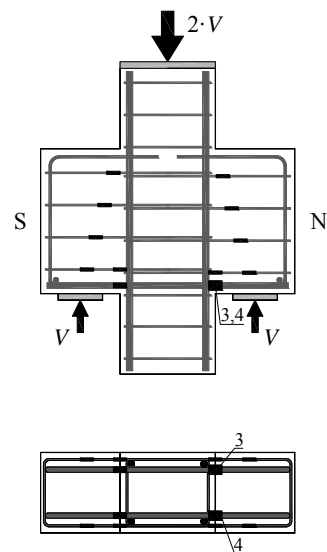
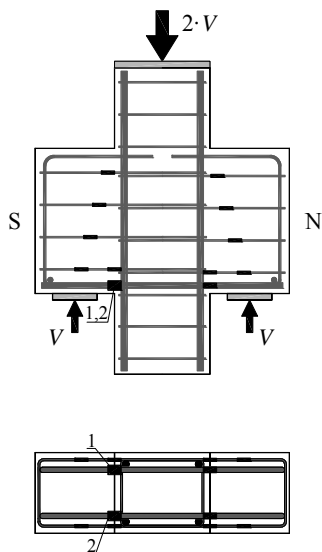
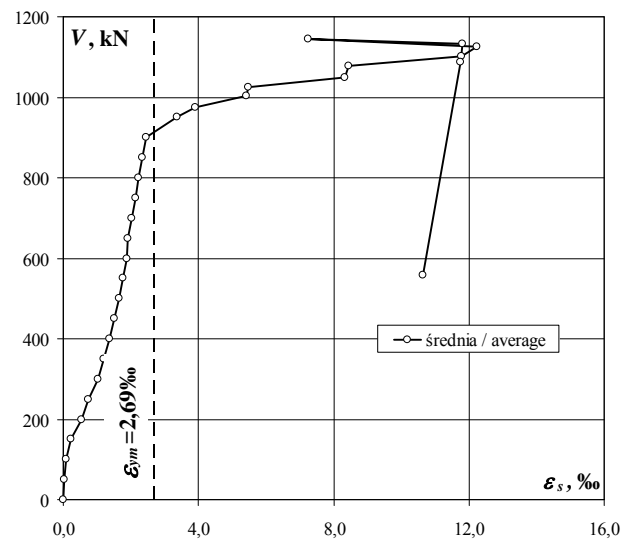
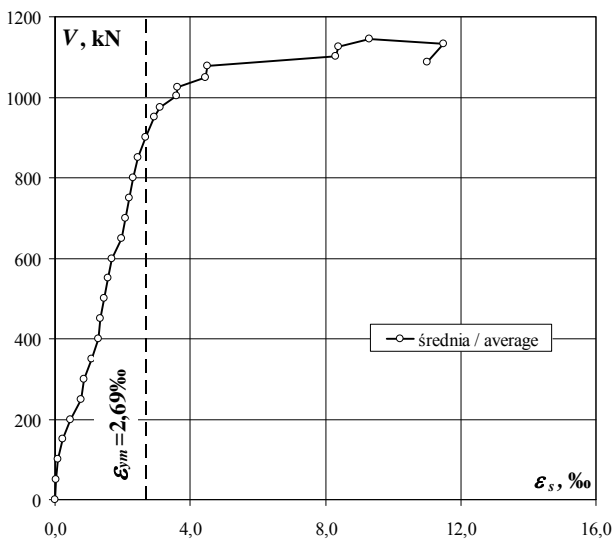
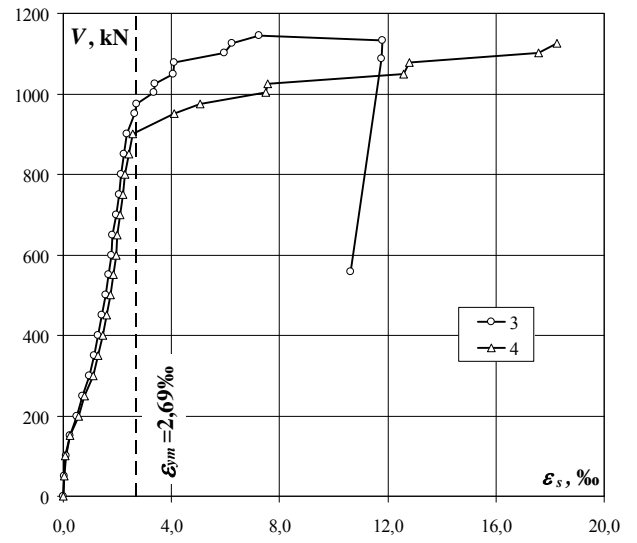
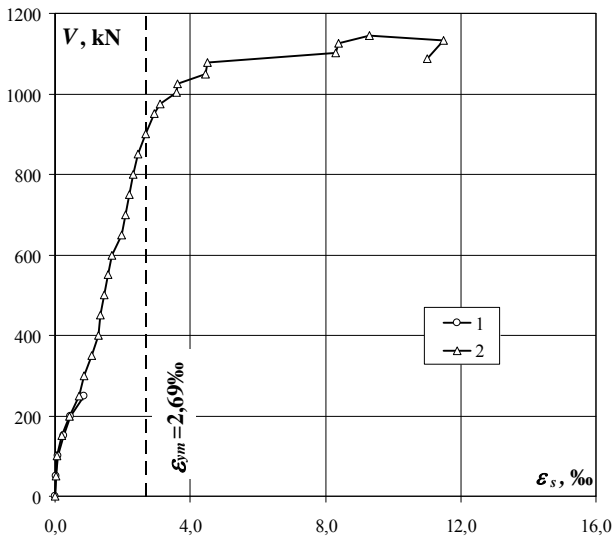

E-0

Strzeżnię 1a – odkształcenia po stronie S i N (ϵ_s) / Stirrup 1a – strains on S and N side (ϵ_s)

obciążenie wspornika corbel load	odkształcenie S S strain			odkształcenie N N strain		
	5	6	średnia/ average	7	8	średnia/ average
	%	%	%	%	%	%
kN						
0	0,000	0,000	0,000	0,000	0,000	0,000
50	0,015	0,129	0,072	0,285	0,016	0,151
100	0,033	0,064	0,049	-0,357	0,025	-0,166
150	0,148	0,072	0,110	-0,395	0,067	-0,164
200	0,397	0,093	0,245	-0,353	0,321	-0,016
250	0,610	0,425	0,518	-0,094	0,525	0,216
300	0,663	0,687	0,675	0,144	0,889	0,517
350	0,740	1,249	0,995	0,753	1,100	0,927
400	0,799	1,555	1,177	1,040	1,276	1,158
450	0,893	1,835	1,364	1,355	1,484	1,420
500	0,991	2,088	1,540	1,578	1,704	1,641
550	1,082	2,457	1,770	1,888	1,975	1,932
600	1,160	2,916	2,038	2,330	2,420	2,375
650	1,244	3,427	2,336	2,884	2,901	2,893
700	1,338	3,473	2,406	2,863	3,611	3,237
750	1,418	3,510	2,464	2,944	4,616	3,780
800	1,497	3,576	2,537	2,989	5,677	4,333
850	1,573	3,697	2,635	3,112	4,278	3,695
900	1,646	3,804	2,725	3,255	5,621	4,438
950	1,723	3,950	2,837	3,341	6,008	4,675
975	1,802	4,184	2,993	4,820	5,966	5,393
1003	1,877	4,442	3,160	5,138	5,991	5,565
1024	1,904	4,482	3,193	5,194	6,012	5,603
1049	1,998	4,826	3,412	5,488	6,272	5,880
1078	2,035	4,870	3,453	5,571	6,296	5,934
1102	2,093	5,109	3,601	5,778	6,839	6,309
1127	2,127	5,121	3,624	5,805	6,877	6,341
1146	2,204	5,098	3,651	5,865	6,944	6,405
1133	2,287	4,946	3,617	5,706	7,182	6,444
1087	2,284	4,944	3,614	5,659	7,129	6,394
559	1,890	4,783	3,337	5,270	5,774	5,522

Strzemię 1a – odkształcenia po stronie S i N (ϵ_s) / Stirrup 1a – strains on S and N side (ϵ_s)

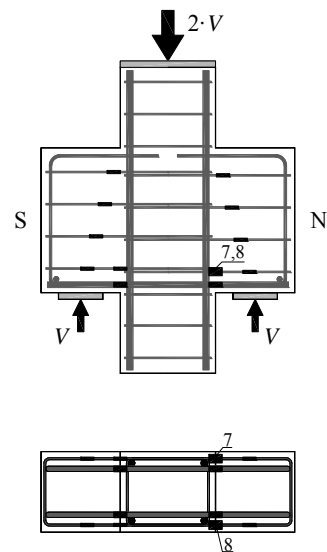
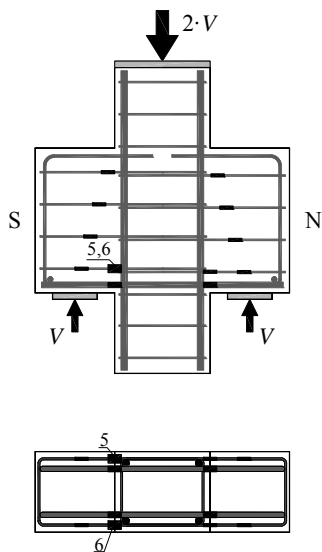
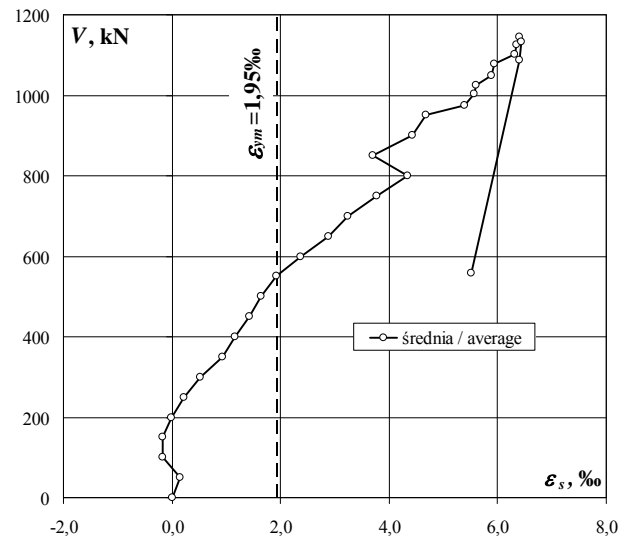
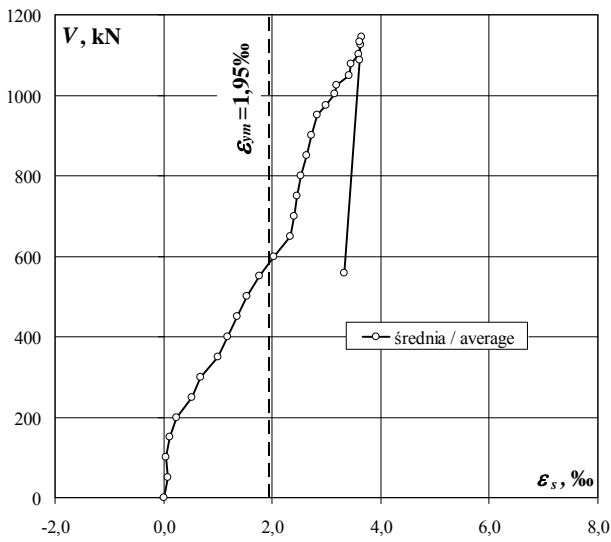
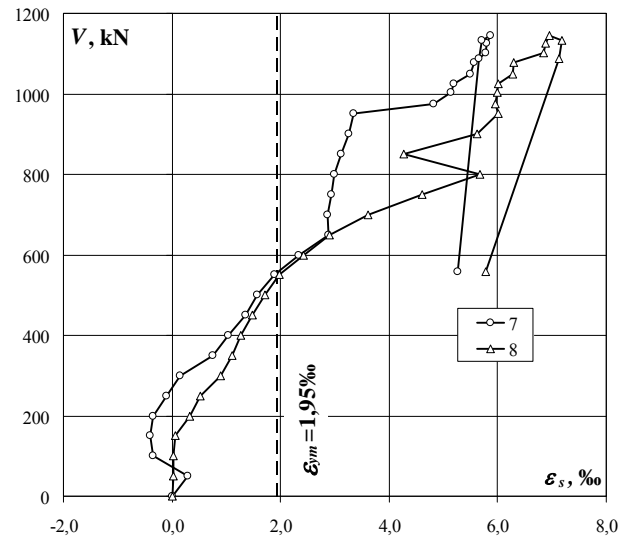
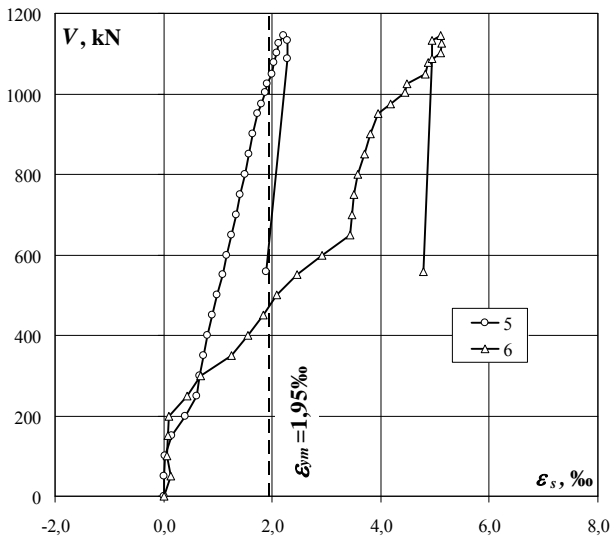

E-0

Strzeżenie 1b – odkształcenia po stronie S i N (ε_s) / Stirrup 1b – strains on S and N side (ε_s)

obciążenie wspornika corbel load	odkształcenie S S strain			odkształcenie N N strain		
	9	10	średnia/ average	11	12	średnia/ average
	%	%	%	%	%	%
kN						
0	0,000	0,000	0,000	0,000	0,000	0,000
50	-0,030	0,016	-0,007	0,012	0,013	0,013
100	0,011	0,032	0,022	0,026	0,022	0,024
150	0,020	0,045	0,033	0,041	0,038	0,040
200	0,288	0,058	0,173	0,043	0,042	0,043
250	0,521	0,074	0,298	0,186	0,052	0,119
300	0,873	0,089	0,481	0,422	0,058	0,240
350	1,098	0,094	0,596	0,555	0,066	0,311
400	1,285	0,099	0,692	0,658	0,073	0,366
450	1,493	0,119	0,806	0,758	0,080	0,419
500	1,786	0,129	0,958	0,842	0,081	0,462
550	2,102	0,144	1,123	0,947	0,083	0,515
600	2,490	0,163	1,327	1,047	0,081	0,564
650	3,253	0,852	2,053	1,099	0,084	0,592
700	3,602	0,895	2,249	1,155	0,087	0,621
750	4,120	0,901	2,511	1,221	0,090	0,656
800	4,710	0,919	2,815	1,284	0,095	0,690
850	3,971	0,941	2,456	1,327	0,100	0,714
900	4,427	0,958	2,693	1,175	0,101	0,638
950	4,484	0,982	2,733	0,140	0,323	0,232
975	4,915	1,000	2,958	0,253	0,352	0,303
1003	3,762	1,026	2,394	0,366	0,394	0,380
1024	4,880	1,024	2,952	0,385	0,396	0,391
1049	3,923	1,036	2,480	0,261	0,424	0,343
1078	3,923	1,069	2,496	0,285	0,409	0,347
1102	2,888	1,078	1,983	0,440	0,768	0,604
1127	4,092	1,080	2,586	0,300	0,756	0,528
1146	1,715	1,088	1,402	0,375	0,797	0,586
1133	3,111	1,207	2,159	0,282	0,939	0,611
1087	5,446	1,190	3,318	0,257	0,926	0,592
559	3,522	0,354	1,938		0,703	0,703

Strzeżnię 1b – odkształcenia po stronie S i N (ϵ_s) / Stirrup 1b – strains on S and N side (ϵ_s)

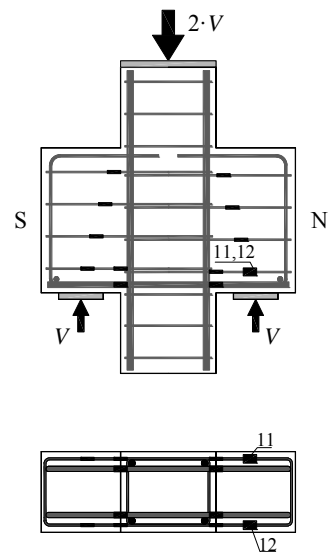
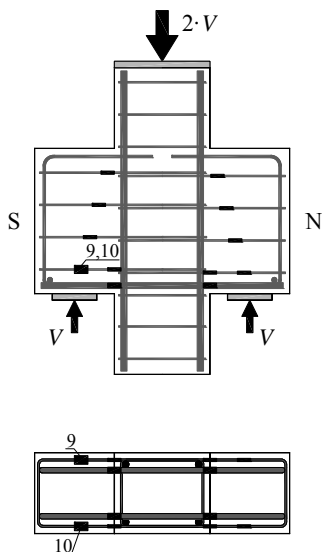
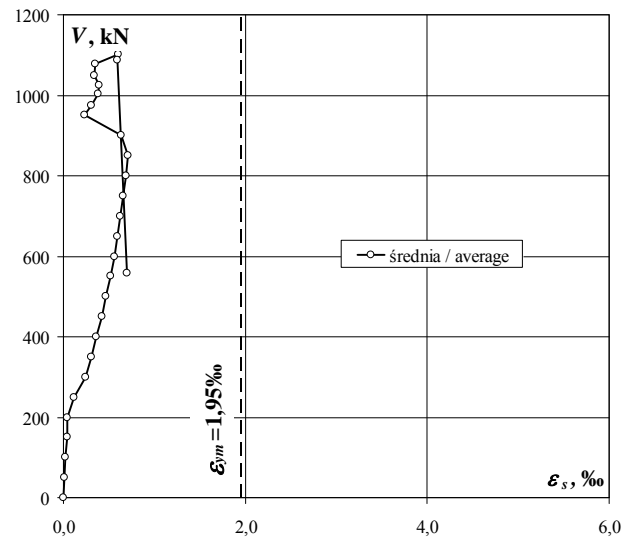
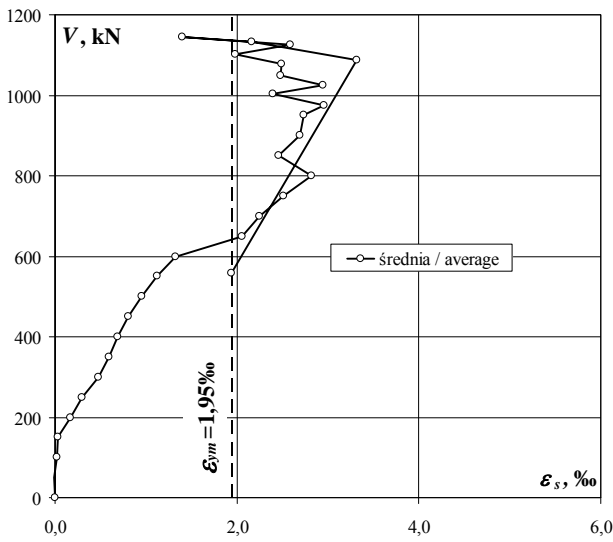
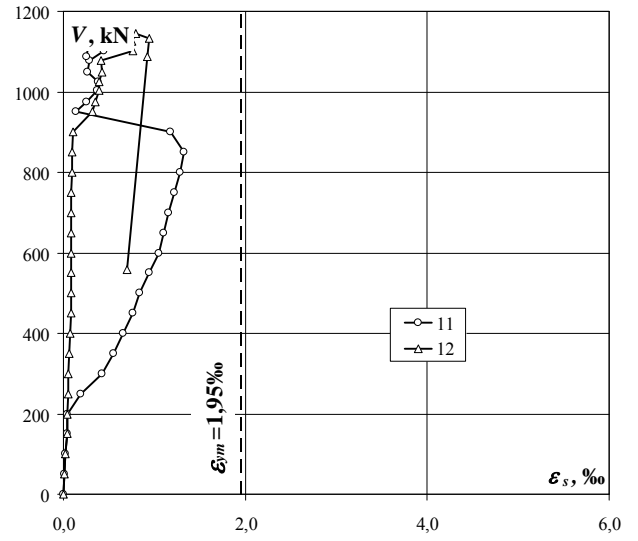
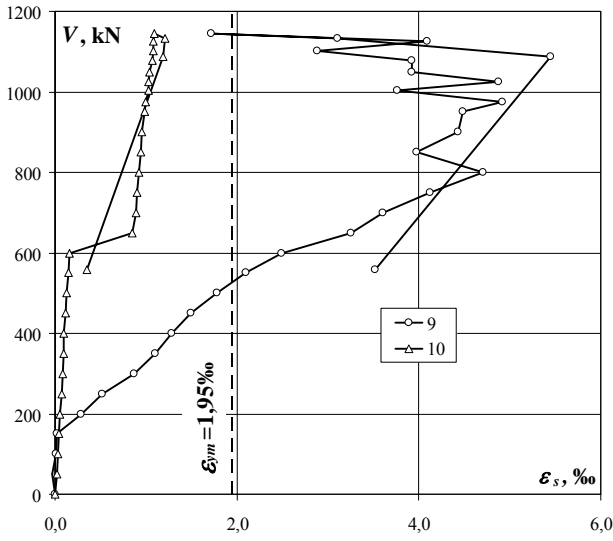

E-0

Strzemię 2 – odkształcenia po stronie S i N (ε_s) / Stirrup 2 – strains on S and N side (ε_s)

obciążenie wspornika corbel load	odkształcenie S S strain			odkształcenie N N strain		
	13	14	średnia/ average	15	16	średnia/ average
kN	‰	‰	‰	‰	‰	‰
0	0,000	0,000	0,000	0,000	0,000	0,000
50	0,020	0,007	0,014	0,006	0,003	0,005
100	0,030	0,016	0,023	0,012	-0,003	0,005
150	0,049	0,030	0,040	0,029	0,008	0,019
200	0,038	0,043	0,041	0,041	0,019	0,030
250	0,040	0,046	0,043	0,050	0,022	0,036
300	0,045	0,057	0,051	0,177	0,020	0,099
350	0,075	0,067	0,071	0,290	0,013	0,152
400	0,076	0,087	0,082	0,364	0,012	0,188
450	0,088	0,107	0,098	0,444	0,020	0,232
500	0,100	0,137	0,119	0,521	0,020	0,271
550	0,129	0,181	0,155	0,613	0,019	0,316
600	0,158	0,249	0,204	0,694	0,021	0,358
650	1,006	0,801	0,904	0,736	0,027	0,382
700	1,031	0,910	0,971	0,757	0,041	0,399
750	1,073	0,968	1,021	0,807	0,055	0,431
800	1,138	0,992	1,065	0,869	0,082	0,476
850	1,213	1,010	1,112	0,924	0,115	0,520
900	1,283	1,028	1,156	0,976	0,129	0,553
950	1,266	1,037	1,152	1,305	0,215	0,760
975	1,299	1,052	1,176	1,355	0,271	0,813
1003	1,329	1,067	1,198	1,394	0,342	0,868
1024	1,347	1,077	1,212	1,403	0,345	0,874
1049	1,391	1,090	1,241	1,441	0,440	0,941
1078	1,385	1,100	1,243	1,447	0,437	0,942
1102	1,461	1,119	1,290	1,519	0,487	1,003
1127	1,472	1,118	1,295	1,532	0,492	1,012
1146	1,504	1,110	1,307	1,548	0,503	1,026
1133	1,679	1,196	1,438	1,611	0,569	1,090
1087	0,987		0,987	1,585	0,552	1,069
559				1,062	0,350	0,706

Strzemię 2 – odkształcenia po stronie S i N (ϵ_s) / Stirrup 2 – strains on S and N side (ϵ_s)

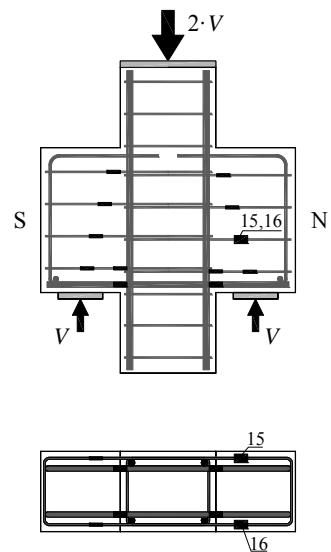
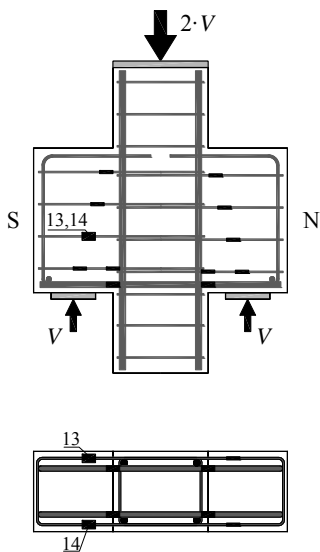
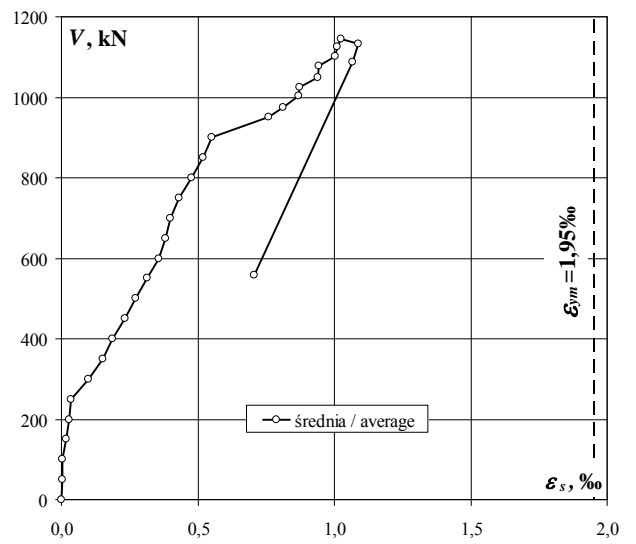
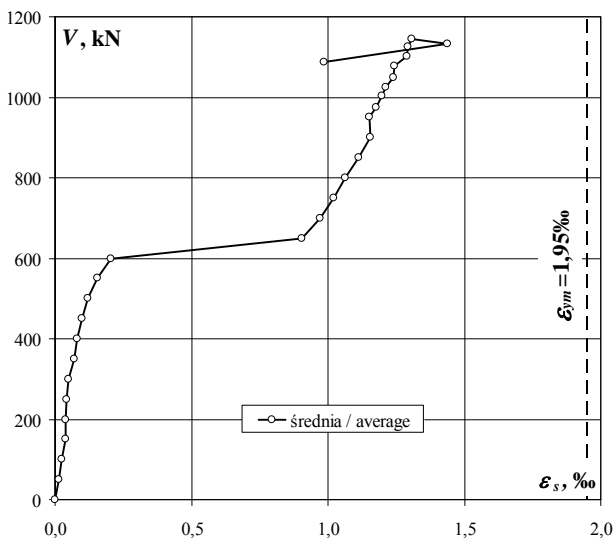
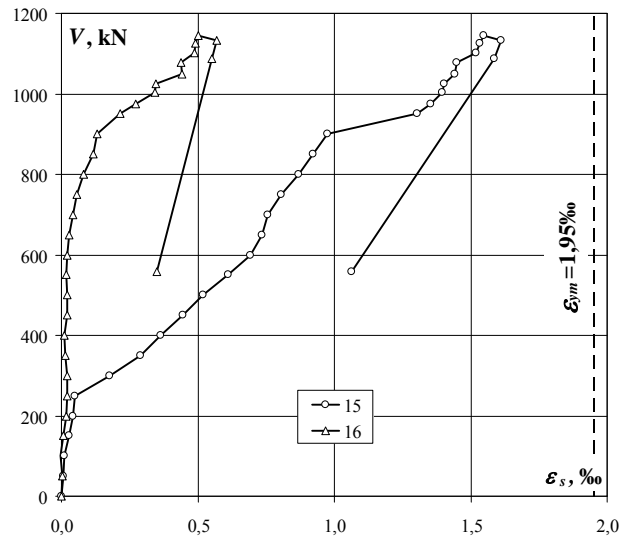
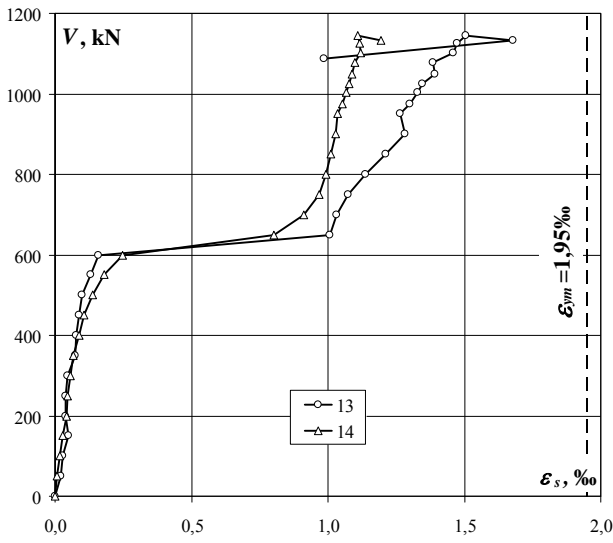

E-0

Strzeżnię 3 – odkształcenia po stronie S i N (ϵ_s) / Stirrup 3 – strains on S and N side (ϵ_s)

obciążenie wspornika corbel load	odkształcenie S S strain			odkształcenie N N strain		
	17	18	średnia/ average	19	20	średnia/ average
	‰	‰	‰	‰	‰	‰
0	0,000	0,000	0,000	0,000	0,000	0,000
50	-0,002	0,011	0,005	-0,003	0,000	-0,002
100	-0,017	0,038	0,011	-0,006	-0,003	-0,005
150	-0,012	0,058	0,023	-0,001	0,000	-0,001
200	0,011	0,068	0,040	0,016	0,015	0,016
250	0,023	0,092	0,058	0,025	0,024	0,025
300	0,032	0,103	0,068	0,033	0,023	0,028
350	0,030	0,153	0,092	0,040	0,036	0,038
400	0,036	0,168	0,102	0,047	0,041	0,044
450	0,036	0,176	0,106	0,051	0,049	0,050
500	0,039	0,186	0,113	0,063	0,059	0,061
550	0,045	0,216	0,131	0,103	0,080	0,092
600	0,049	0,219	0,134	0,260	0,086	0,173
650	0,495	0,441	0,468	0,312	0,091	0,202
700	0,585	0,693	0,639	0,344	0,102	0,223
750	0,663	0,906	0,785	0,392	0,113	0,253
800	0,765	1,088	0,927	0,433	0,124	0,279
850	0,814	1,170	0,992	0,486	0,139	0,313
900	0,863	1,192	1,028	0,562	0,175	0,369
950	0,902	1,205	1,054	0,465	0,401	0,433
975	0,943	1,207	1,075		0,416	0,416
1003	0,984	1,209	1,097		0,426	0,426
1024	1,000	1,215	1,108		0,432	0,432
1049	1,034	1,242	1,138		0,458	0,458
1078	1,057	1,260	1,159		0,460	0,460
1102	1,102	1,275	1,189		0,489	0,489
1127	1,126	1,275	1,201		0,503	0,503
1146	1,190	1,278	1,234		0,492	0,492
1133	1,318	1,426	1,372		0,519	0,519
1087	1,308	0,899	1,104		0,515	0,515
559	1,256		1,256		0,405	0,405

Strzemię 3 – odkształcenia po stronie S i N (ϵ_s) / Stirrup 3 – strains on S and N side (ϵ_s)

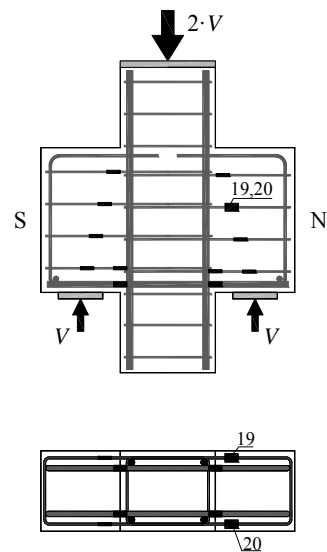
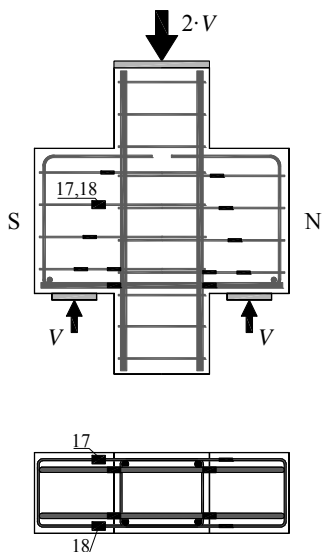
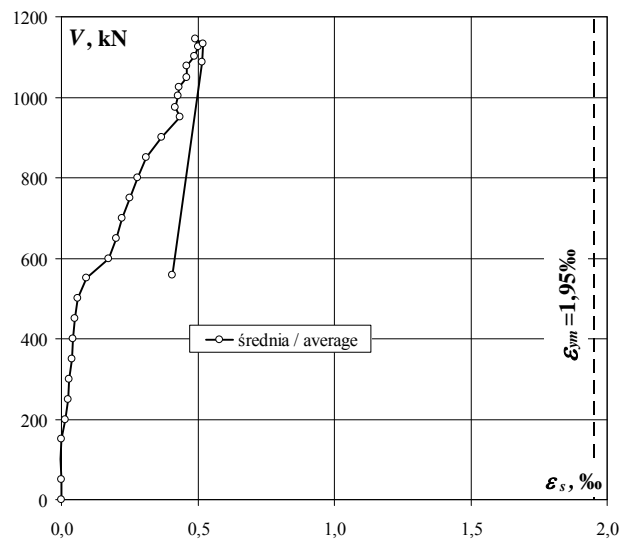
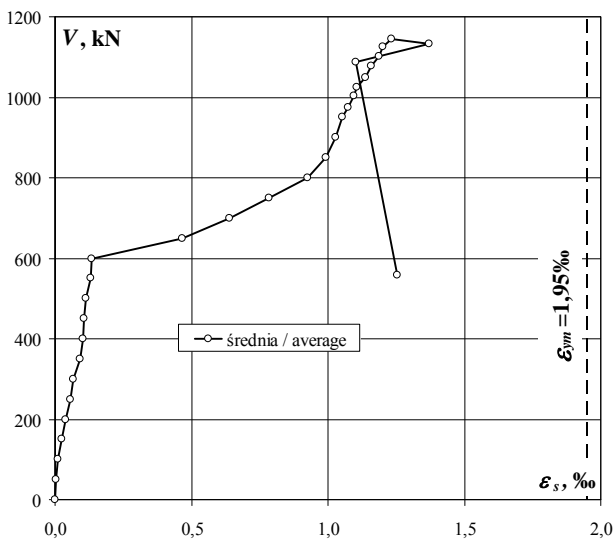
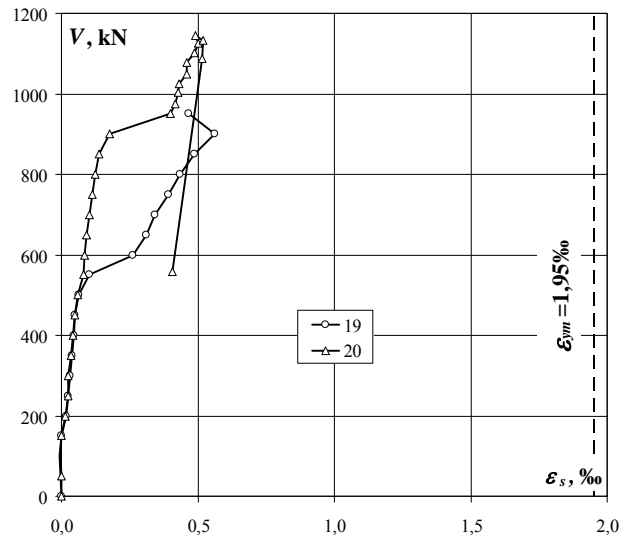
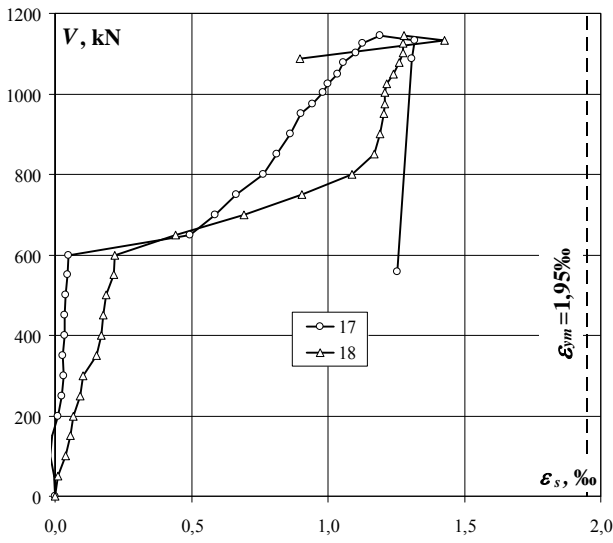

E-0

Strzeżenie 4 – odkształcenia po stronie S i N (ϵ_s) / Stirrup 4 – strains on S and N side (ϵ_s)

obciążenie wspornika corbel load	odkształcenie S S strain			odkształcenie N N strain		
	21	22	średnia/ average	23	24	średnia/ average
kN	‰	‰	‰	‰	‰	‰
0	0,000	0,000	0,000	0,000	0,000	0,000
50	-0,008	-0,012	-0,010	-0,013	0,000	-0,007
100	-0,018	-0,031	-0,025	-0,029	0,000	-0,015
150	-0,028	-0,055	-0,042	-0,049	0,000	-0,025
200	-0,030	-0,054	-0,042	-0,063	0,000	-0,032
250	-0,020	-0,050	-0,035	-0,064	0,000	-0,032
300	-0,015	-0,046	-0,031	-0,054	0,000	-0,027
350	-0,007	-0,071	-0,039	-0,053	0,000	-0,027
400	-0,002	-0,067	-0,035	-0,055	0,000	-0,028
450	0,003	-0,076	-0,037	-0,050	0,000	-0,025
500	0,003	-0,062	-0,030	-0,054	0,000	-0,027
550	0,008	-0,070	-0,031	-0,049	0,000	-0,025
600	0,012	-0,054	-0,021	-0,032	0,000	-0,016
650	0,184	0,063	0,124	-0,024	0,000	-0,012
700	0,267	0,132	0,200	-0,015	0,000	-0,008
750	0,340	0,190	0,265	-0,006	0,000	-0,003
800	0,413	0,280	0,347	0,009	0,000	0,005
850	0,476	0,369	0,423	0,026	0,000	0,013
900	0,523	0,467	0,495	0,087	0,000	0,044
950	0,559	0,561	0,560	0,628	0,003	0,316
975	0,565	0,645	0,605	0,671	0,003	0,337
1003	0,596	0,757	0,677	0,691	0,004	0,348
1024	0,604	0,758	0,681	0,691	0,004	0,348
1049	0,609	0,876	0,743	0,740	0,005	0,373
1078	0,614	0,880	0,747	0,743	0,005	0,374
1102	0,621	1,032	0,827	0,826	0,007	0,417
1127	0,646	1,072	0,859	0,847	0,007	0,427
1146	0,658	1,094	0,876	0,865	0,008	0,437
1133	1,211	1,633	1,422	0,995	0,010	0,503
1087	1,764	1,063	1,414	0,993	0,009	0,501
559	2,317		2,317	0,821	0,008	0,415

Strzemię 4 – odkształcenia po stronie S i N (ϵ_s) / Stirrup 4 – strains on S and N side (ϵ_s)

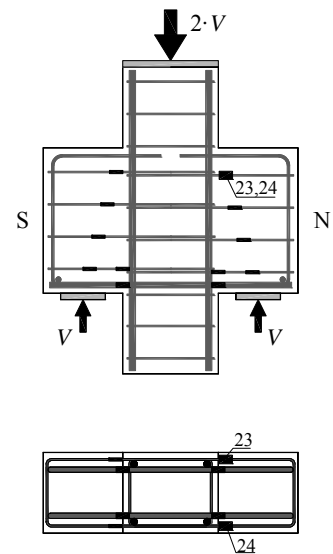
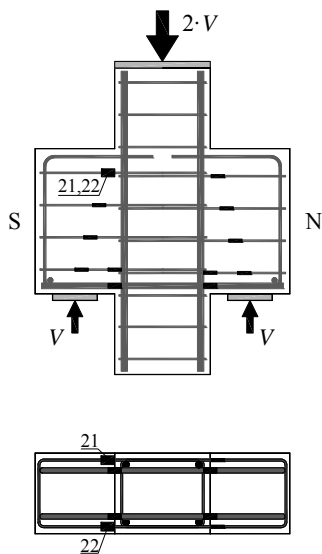
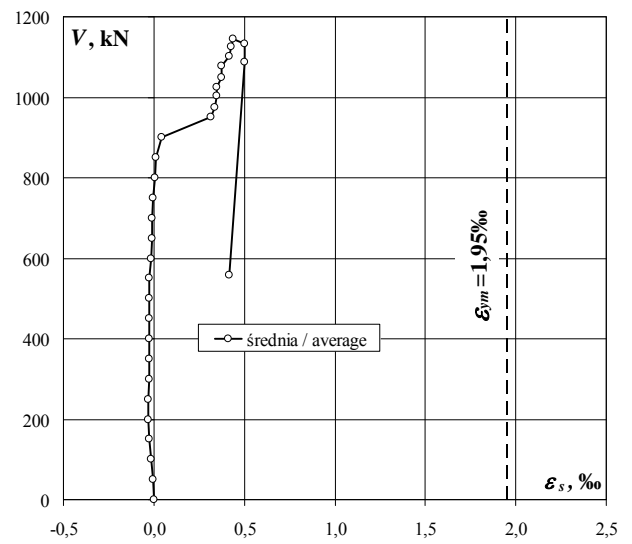
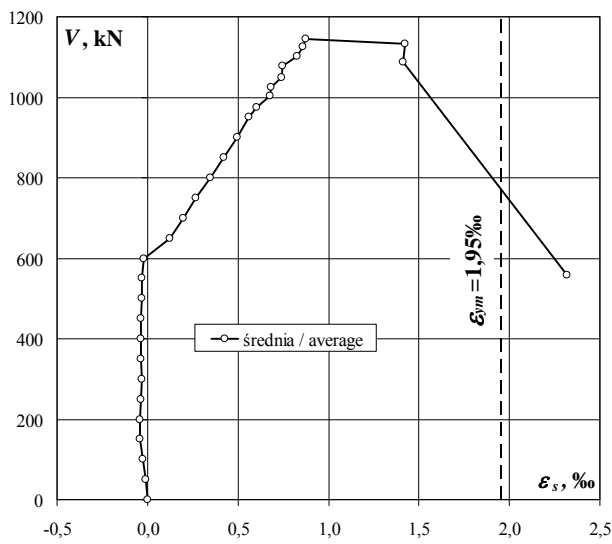
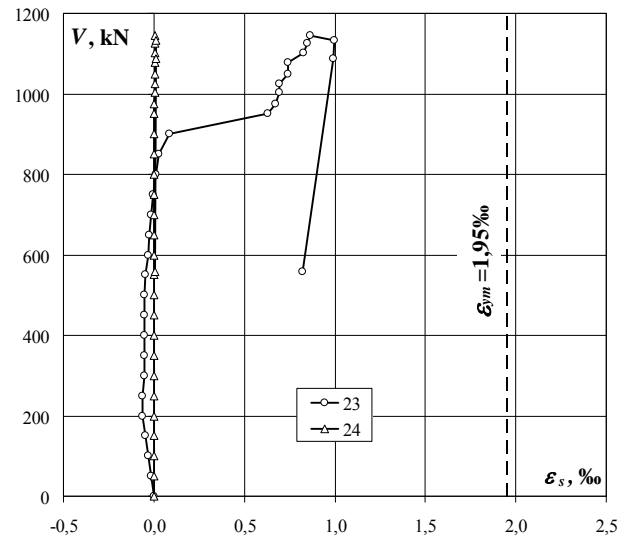
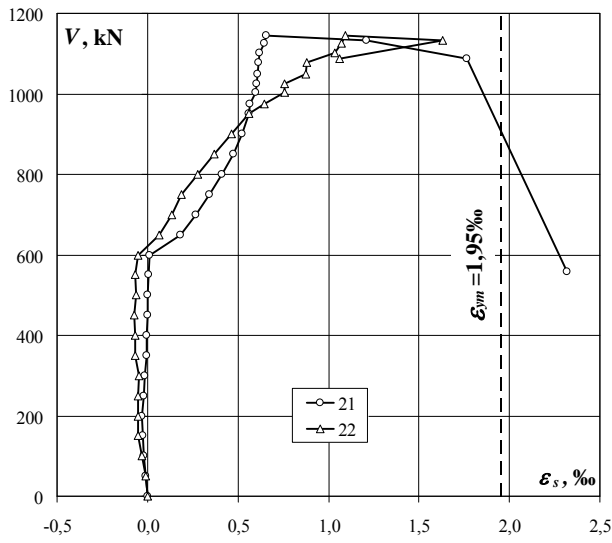

E-0

Odształcenia na pierwszym poziomie / Strains at the 1st level

obciążenie wspornika corbel load	przeszyczenia wg ekstensometrów displacement acc to extensometers			obciążenie wspornika corbel load	przeszyczenia wg systemu Aramis displacement acc to Aramis System		
	1	2	3		1'	2'	3'
kN	‰	‰	‰	kN	‰	‰	‰
0	0,000	0,000	0,000	0	0,00	0,00	0,00
50	0,025	0,005	0,000	50	0,09	-0,11	0,08
100	0,035	0,010	0,005	100	0,16	-0,46	-0,14
150	0,170	0,000	0,010	150	0,14	-0,16	0,21
200	0,375	-0,015	0,010	200	0,35	-0,08	0,46
250	0,585	0,125	0,200	250	0,47	-0,21	0,53
300	0,850	0,230	0,335	300	0,91	-0,26	0,96
350	1,060	0,270	0,530	350	0,99	-0,37	0,90
400	1,280	0,275	0,700	400	0,98	-0,28	1,20
450	1,455	0,275	0,885	450	1,04	-0,15	1,29
500	1,625	0,275	1,040	500	1,28	-0,07	1,65
550	1,825	0,275	1,200	550	1,50	-0,23	1,65
600	2,005	0,275	1,355	600	1,34	-0,42	2,12
650	2,100	0,275	2,000	650	1,78	-0,25	2,63
700	2,250	0,275	2,280	700	1,69	-0,12	2,75
750	2,410	0,280	2,480	750	1,87	0,03	2,94
800	2,590	0,275	2,700	800	2,20	0,03	3,21
850	2,780	0,270	2,935	850	2,36	-0,06	3,29
900	3,010	0,280	3,160	900	3,21	0,10	3,45
950	3,925	0,270	3,340	950	3,62	-0,04	3,55
975	4,105	0,265	3,525	1000	4,09	0,15	4,30
1003	4,350	0,270	3,760	1050	4,92	0,05	4,88
1024	4,385	0,625	3,410	1100	5,03	-0,01	5,03
1049	4,745	0,265	4,100	1150	5,65	-0,13	6,23
1078	4,785	0,265	4,135				
1102	5,390	0,265	4,585				
1127	5,435	0,265	4,630				
1146	5,540	0,270	4,770				
1133	6,020	0,270	6,615				
1087	5,955	0,275	6,790				
559	4,690	0,335	8,785				

Według ekstensometrów / According to extensometers

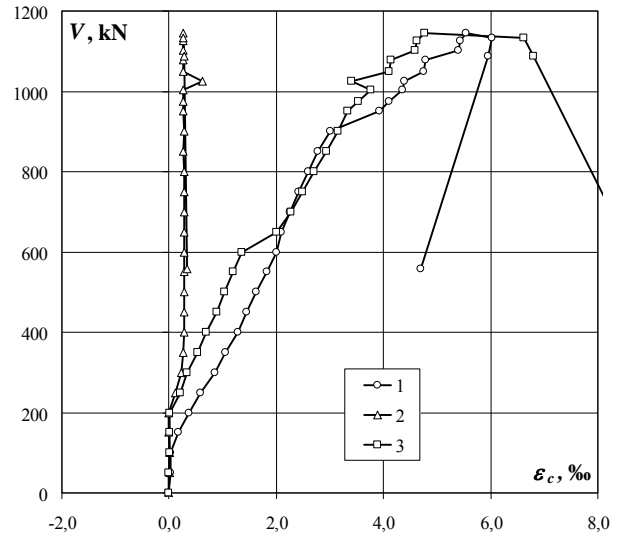

Według systemu Aramis / According to Aramis System

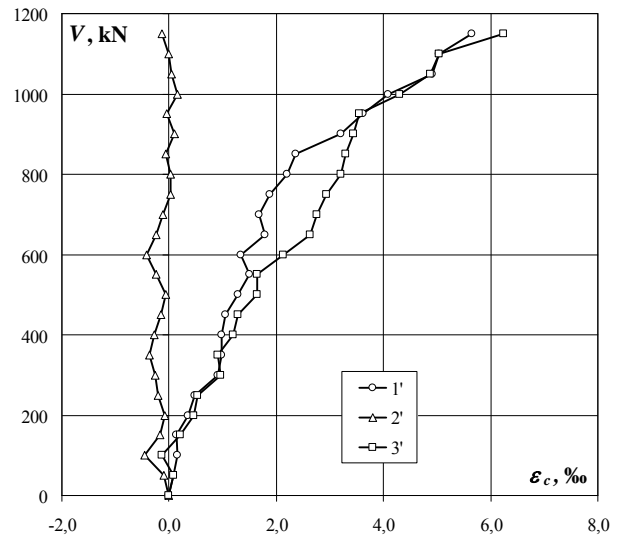

ekstensometry
Extensometers

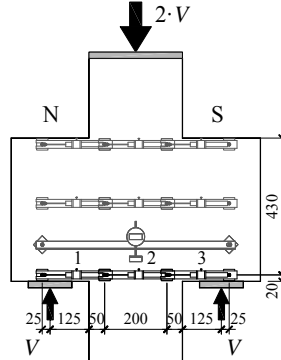

system Aramis
Aramis System

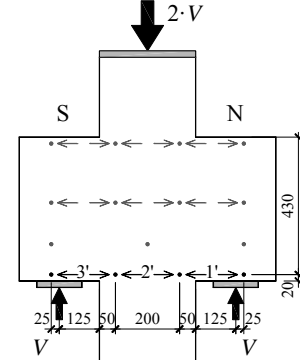

Odształcenia na drugim poziomie / Strains at the 2nd level

obciążenie wspornika corbel load	przesunięcia wg ekstensometrów displacement acc to extensometers			obciążenie wspornika corbel load	przesunięcia wg systemu Aramis displacement acc to Aramis System		
	4	5	6		4'	5'	6'
kN	‰	‰	‰	kN	‰	‰	‰
0	0,000	0,000	0,000	0	0,00	0,00	0,00
50	0,000	0,000	0,000	50	-0,12	0,21	-0,22
100	0,005	0,000	0,005	100	-0,28	0,15	-0,28
150	0,025	0,000	0,005	150	-0,17	0,04	0,19
200	0,085	0,000	0,020	200	-0,06	0,13	0,09
250	0,115	-0,005	0,000	250	-0,05	0,23	-0,01
300	0,195	-0,010	0,000	300	-0,08	0,50	0,08
350	0,260	-0,020	-0,005	350	-0,14	0,50	-0,01
400	0,260	0,030	-0,010	400	-0,21	0,44	0,24
450	0,265	0,160	-0,010	450	-0,10	0,48	0,33
500	0,295	0,245	-0,010	500	-0,08	0,86	0,12
550	0,355	0,325	-0,010	550	-0,06	0,84	0,07
600	0,420	0,345	-0,010	600	-0,18	0,49	0,64
650	0,455	0,350	0,025	650	0,06	0,75	1,03
700	0,475	0,350	0,060	700	-0,13	0,53	1,23
750	0,505	0,350	0,070	750	0,00	0,42	1,43
800	0,555	0,345	0,075	800	0,22	0,45	1,83
850	0,615	0,335	0,080	850	0,31	0,63	1,85
900	0,720	0,305	0,085	900	0,93	0,70	1,90
950	1,655	0,250	0,085	950	1,14	0,59	1,96
975	1,790	0,250	0,085	1000	1,62	0,55	2,73
1003	1,995	0,250	0,085	1050	1,89	0,58	3,01
1024	2,015	0,250	0,085	1100	1,83	0,34	3,08
1049	2,250	0,230	0,090	1150	2,30	0,67	4,25
1078	2,280	0,225	0,090				
1102	2,665	0,190	0,090				
1127	2,700	0,190	0,090				
1146	2,775	0,190	0,090				
1133	3,385	0,190	0,095				
1087	3,370	0,155	0,100				
559	3,020	-0,315	0,190				

Według ekstensometrów / According to extensometers

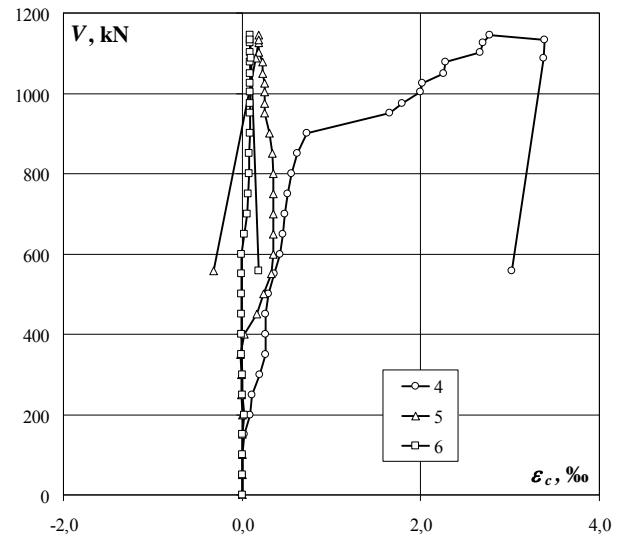

Według systemu Aramis / According to Aramis System

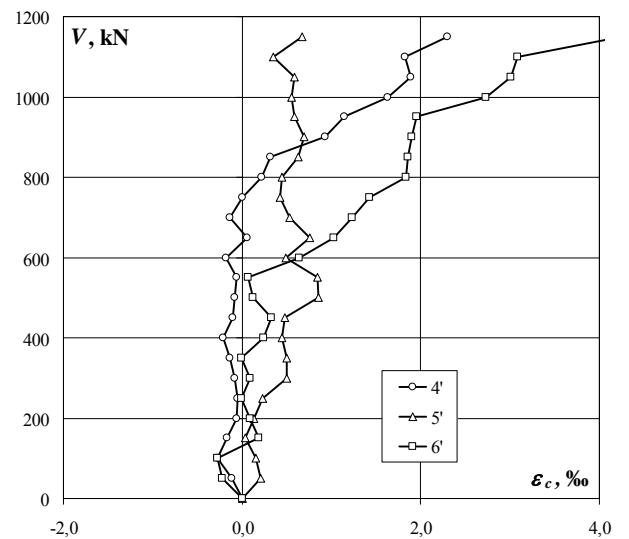

Ekstensometr
Extensometers

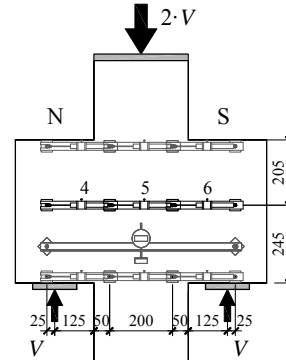

System Aramis
Aramis System

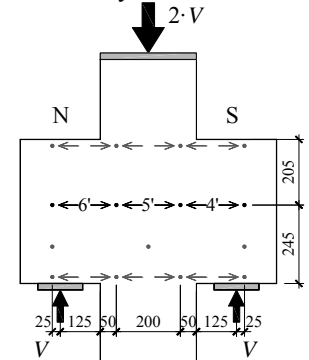

E-0

Odształcenia na trzecim poziomie / Strains at the 3rd level

obciążenie wspornika corbel load	przesunięcia wg ekstensometrów displacement acc to extensometers			obciążenie wspornika corbel load	przesunięcia wg systemu Aramis displacement acc to Aramis System		
	7	8	9		7'	8'	9'
kN	%	%	%	kN	%	%	%
0	0,000	0,000	0,000	0	0,00	0,00	0,00
50	0,000	-0,010	0,000	50	0,11	-0,16	-0,10
100	-0,005	-0,020	0,000	100	-0,01	-0,45	-0,17
150	-0,015	-0,040	0,000	150	0,10	-0,40	0,16
200	-0,020	-0,055	-0,015	200	0,02	-0,27	-0,13
250	-0,030	-0,075	-0,030	250	-0,23	-0,17	-0,22
300	-0,035	-0,090	-0,040	300	-0,08	-0,35	0,05
350	-0,040	-0,100	-0,045	350	-0,02	-0,39	-0,11
400	-0,040	-0,105	-0,045	400	-0,31	-0,54	-0,03
450	-0,045	-0,100	-0,050	450	-0,31	-0,41	-0,13
500	-0,050	-0,110	-0,060	500	-0,16	-0,19	-0,27
550	-0,055	-0,120	-0,070	550	-0,11	-0,29	-0,30
600	-0,055	-0,135	-0,080	600	-0,32	-0,40	-0,39
650	-0,060	-0,135	-0,105	650	-0,25	-0,26	-0,07
700	-0,065	-0,145	-0,105	700	-0,29	-0,61	-0,05
750	-0,070	-0,165	-0,100	750	-0,37	-0,55	0,00
800	-0,075	-0,185	-0,095	800	-0,39	-0,41	-0,19
850	-0,075	-0,215	-0,090	850	-0,20	-0,37	-0,20
900	-0,065	-0,245	-0,080	900	-0,10	-0,17	-0,15
950	0,070	-0,280	-0,075	950	-0,10	-0,34	-0,25
975	0,080	-0,310	-0,070	1000	0,37	-0,53	0,00
1003	0,095	-0,350	-0,060	1050	0,39	-0,52	0,20
1024	0,100	-0,355	-0,060	1100	0,30	-0,52	0,19
1049	0,115	-0,395	-0,050	1150	0,49	-0,62	0,69
1078	0,120	-0,405	-0,045				
1102	0,155	-0,465	-0,030				
1127	0,160	-0,475	-0,030				
1146	0,165	-0,475	-0,025				
1133	0,220	-0,395	1,045				
1087	0,175	-0,445	1,490				
559	-0,490	0,430	4,245				

Według ekstensometrów / According to extensometers

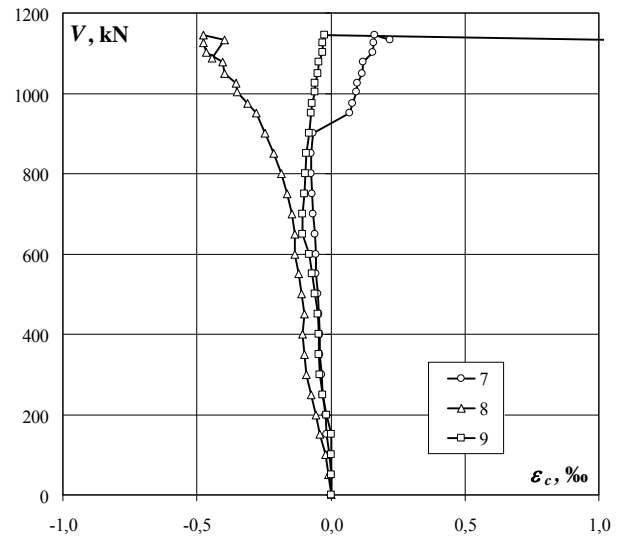

Według systemu Aramis / According to Aramis System

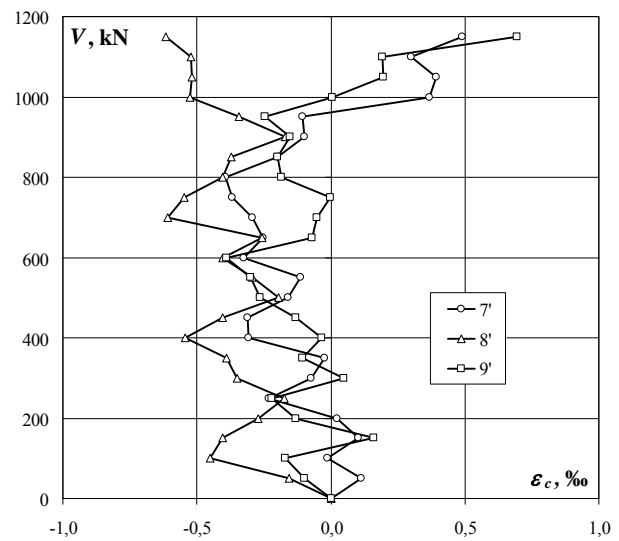

Ekstensometr
Extensometers

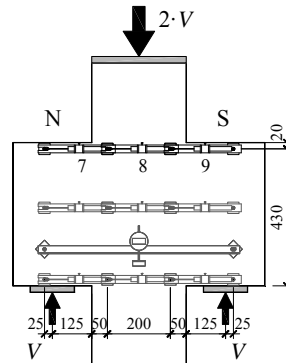

System Aramis
Aramis System

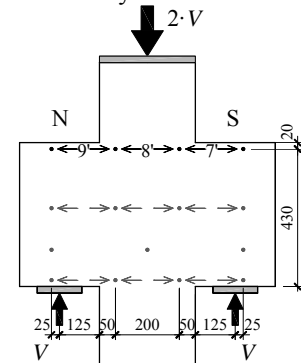

Przesunięcie słupa względem wsporników / The relative displacement between the column and the corbels

obciążenie wspornika corbel load	Przesunięcie wg czujnika Displacement acc to gauges	obciążenie wspornika corbel load	Przesunięcie wg systemu Aramis Displacement acc. to Aramis System
kN	mm	kN	mm
0	0,00	0	0,00
50	0,01	50	0,02
100	0,02	100	0,03
150	0,03	150	0,06
200	0,06	200	0,10
250	0,10	250	0,14
250	0,11	300	0,19
300	0,14	350	0,21
350	0,17	400	0,27
350	0,18	450	0,30
400	0,21	500	0,35
450	0,24	550	0,39
500	0,27	600	0,45
500	0,29	650	0,49
550	0,31	700	0,54
550	0,32	750	0,58
600	0,34	800	0,65
600	0,35	850	0,68
650	0,41	900	0,80
650	0,43	950	0,86
700	0,46	1000	1,00
700	0,47	1050	1,14
750	0,49	1100	1,17
750	0,51	1150	1,43
800	0,54		
850	0,58		
850	0,60		
900	0,63		
950	0,76		
950	0,80		
1000	0,83		
1000	0,86		
1050	0,89		
1100	0,99		
1100	1,08		
1150	1,13		

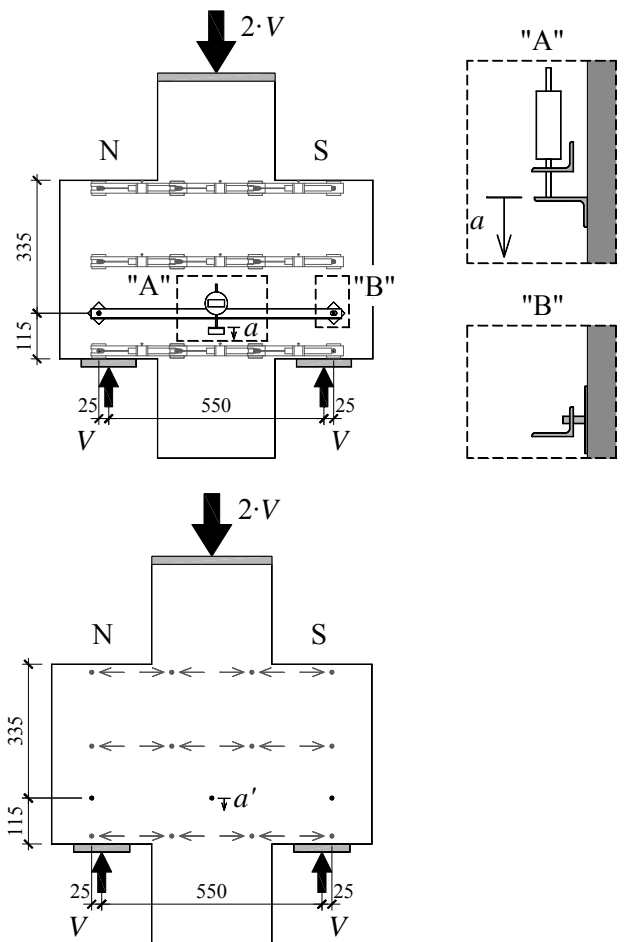
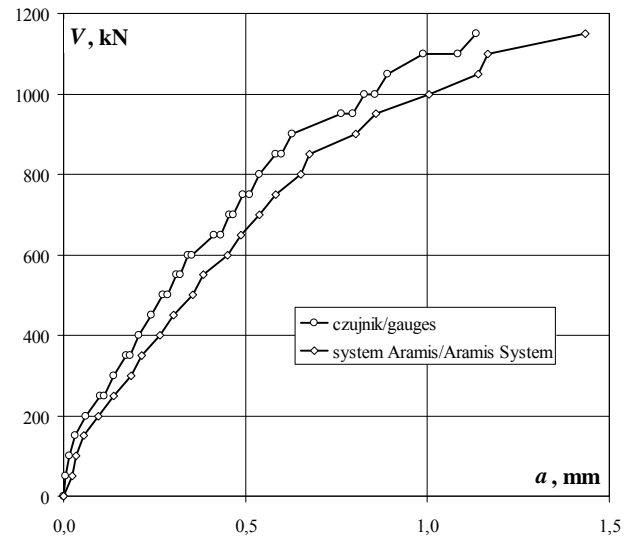

E-0

Szerokość rozwarcia rys / Crack width

obciążenie wspornika corbel load	Numer rysy / Crack number							
	1	2	3	4	5	6	7	8
	mm	mm	mm	mm	mm	mm	mm	mm
350								
400	0,20	0,20						
450	0,20	0,22						
500	0,22	0,25						
550	0,20	0,25	0,15					
600	0,20	0,27	0,20					
650	0,20	0,25	0,25	0,25				
700	0,20	0,30	0,30	0,30				
750	0,22	0,33	0,30	0,35				
800	0,27	0,35	0,30	0,40				
850	0,30	0,30	0,30	0,42				
900	0,30	0,35	0,30	0,45				
950	0,30	0,35	0,35	0,45				
1000	0,30	0,30	0,35	0,45	0,35			
1050	0,30	0,35	0,35	0,45	0,40			
1100	0,35	0,35	0,30	0,45	0,40			
1150	0,32		0,45		0,40			

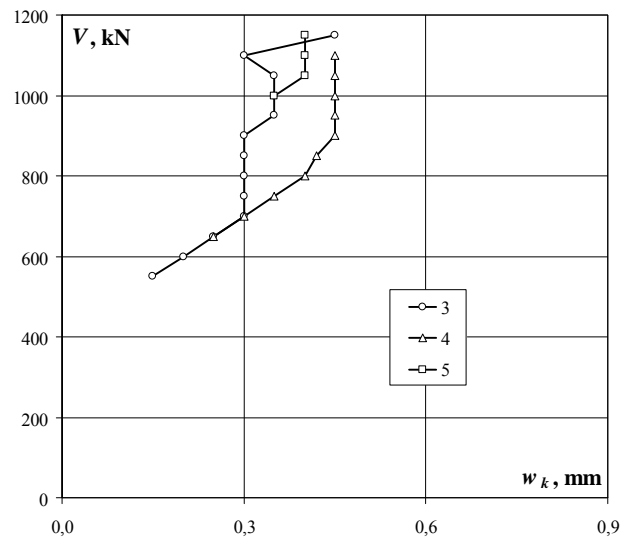
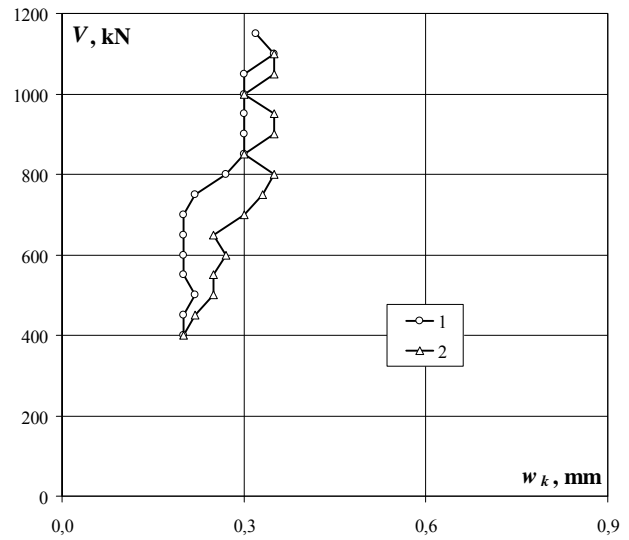

Układ rys przy sile 250kN / Crack pattern at 250kN

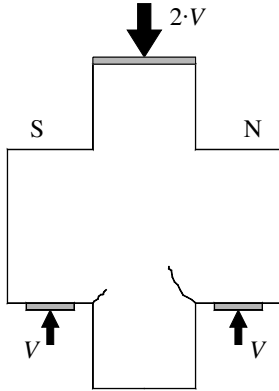

Układ rys przy sile 500kN / Crack pattern at 500kN

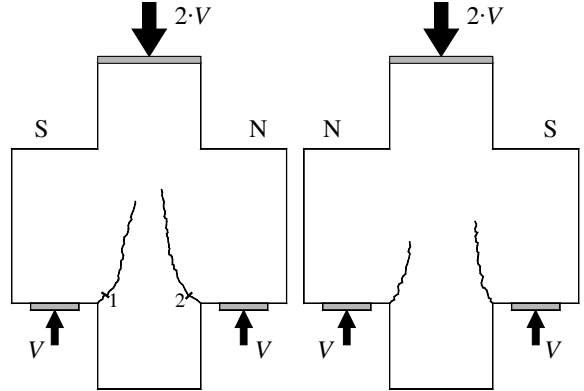

Układ rys przy sile 650kN / Crack pattern at 650kN

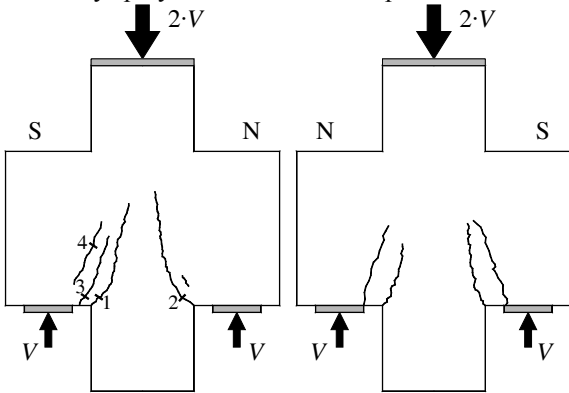

Układ rys przy sile 800kN / Crack pattern at 800kN

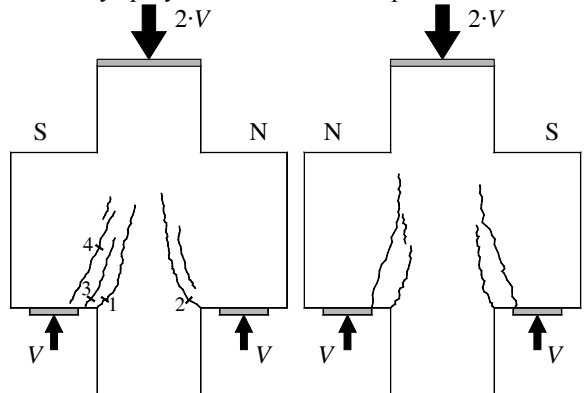

Układ rys przy sile 900kN / Crack pattern at 900kN

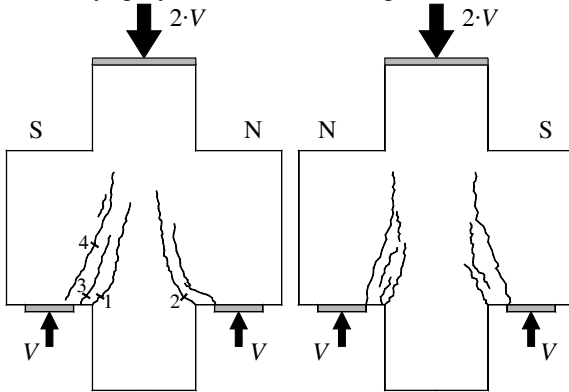

Układ rys przy sile 1100kN / Crack pattern at 1100kN

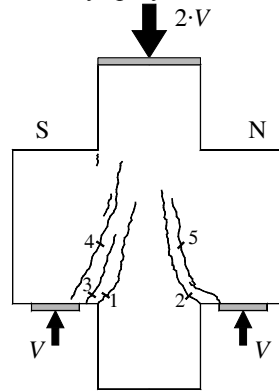

Układ rys przy sile 1146kN / Crack pattern at 1146kN

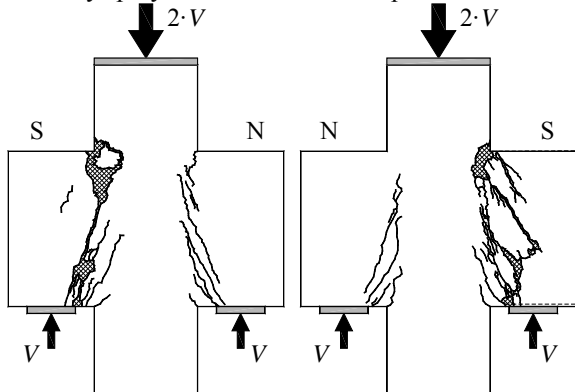

E-0

Szerokość rozwarcia rys według systemu Aramis / Crack width according to Aramis System

obciążenie wspornika corbel load	Numer rysy / Crack number							
	1	2	3	4	5	6	7	8
	mm	mm	mm	mm	mm	mm	mm	mm
0	0,00	0,00	0,00	0,00	0,00			
50	0,06	0,03	0,00	-0,03	-0,01			
100	0,08	0,03	0,04	-0,02	-0,02			
150	0,08	0,07	0,04	0,00	0,00			
200	0,10	0,14	0,02	-0,02	0,01			
250	0,15	0,17	0,02	-0,03	0,02			
300	0,19	0,21	0,03	0,01	0,02			
350	0,21	0,23	0,04	0,01	-0,01			
400	0,19	0,28	0,10	-0,03	0,02			
450	0,20	0,33	0,15	-0,04	0,04			
500	0,19	0,35	0,16	-0,02	0,09			
550	0,17	0,36	0,19	0,02	0,09			
600	0,18	0,36	0,22	0,26	0,10			
650	0,20	0,37	0,25	0,30	0,11			
700	0,20	0,35	0,28	0,35	0,14			
750	0,21	0,35	0,29	0,42	0,18			
800	0,21	0,39	0,28	0,51	0,25			
850	0,23	0,38	0,29	0,53	0,27			
900	0,23	0,41	0,31	0,58	0,50			
950	0,22	0,42	0,34	0,64	0,52			
1000	0,22	0,43	0,41	0,71	0,56			
1050	0,23	0,47	0,51	0,79	0,47			
1100	0,23	0,47	0,54	0,73	0,47			
1150	0,18	0,47	0,62	0,76	0,43			

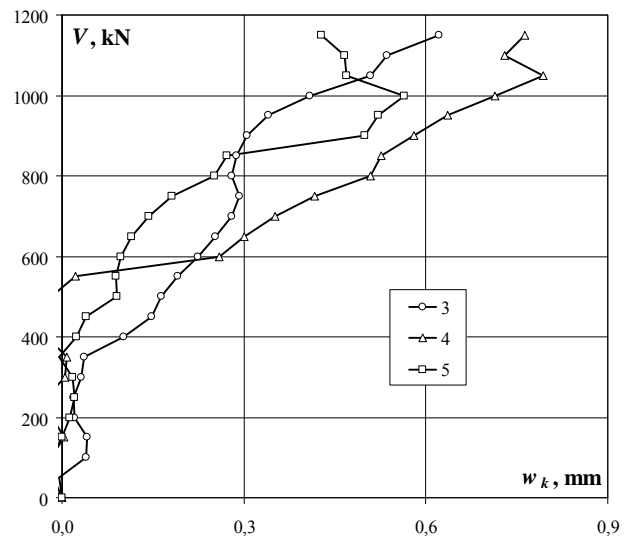
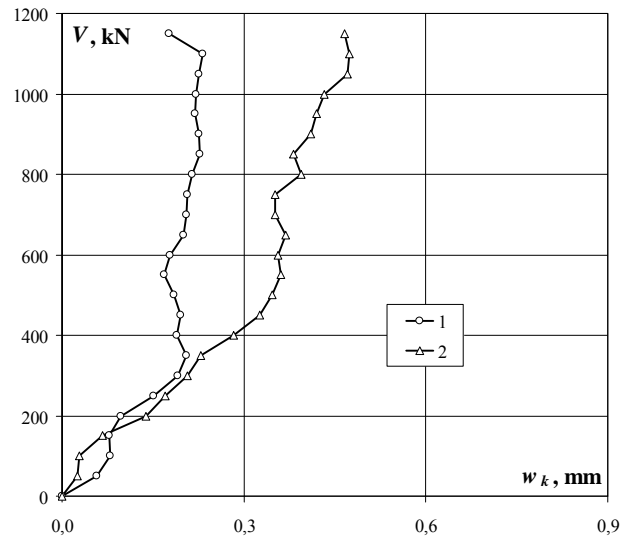

Układ rys przy sile 650kN / Crack pattern at 650kN

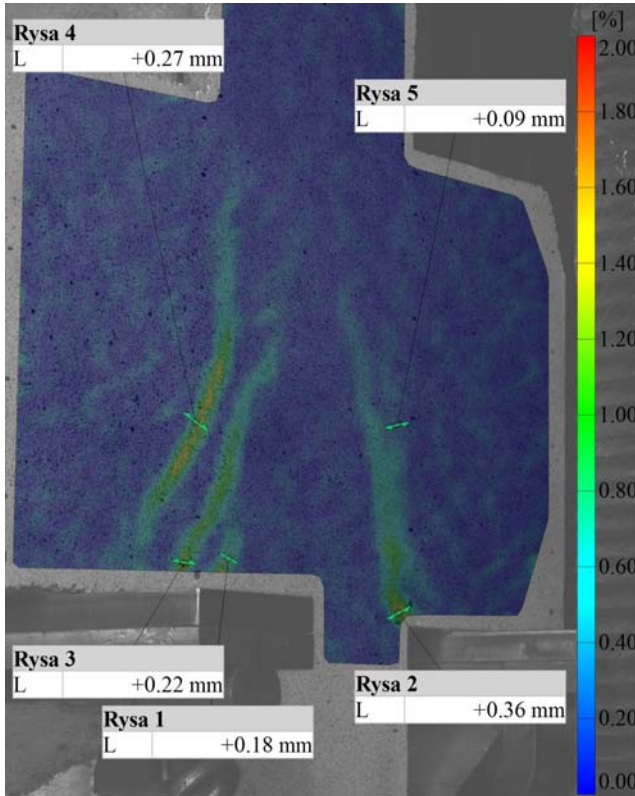

Układ rys przy sile 900kN / Crack pattern at 900kN

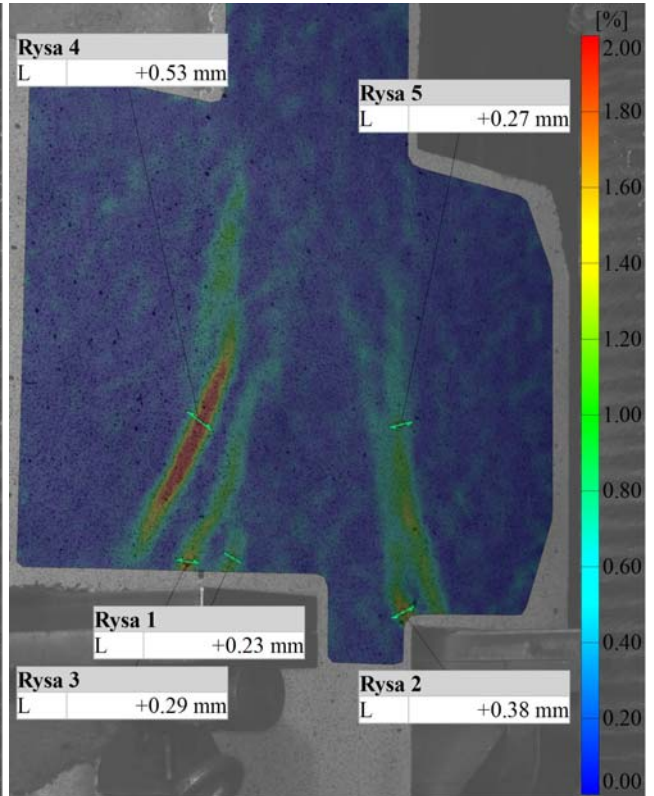

Układ rys przy sile 1150kN / Crack pattern at 1150kN

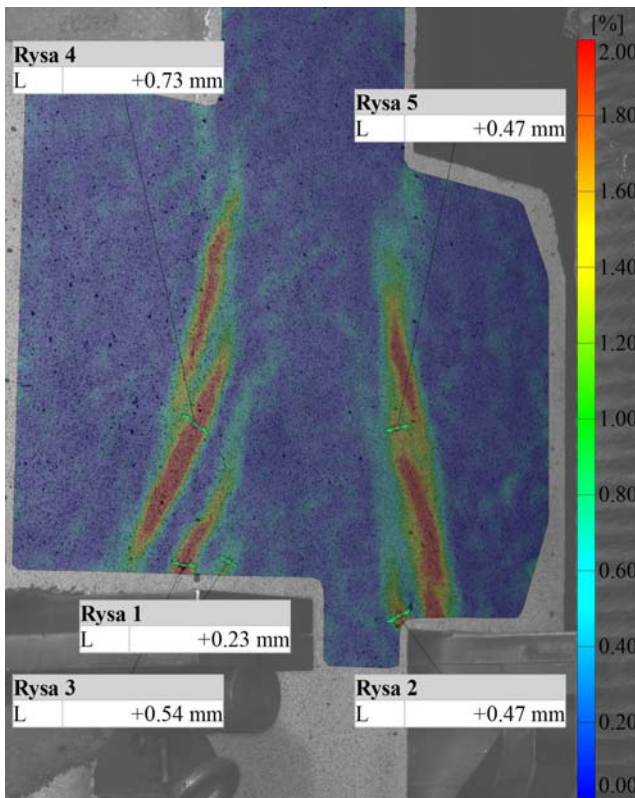

Układ rys przy sile 1150kN / Crack pattern at 1150kN

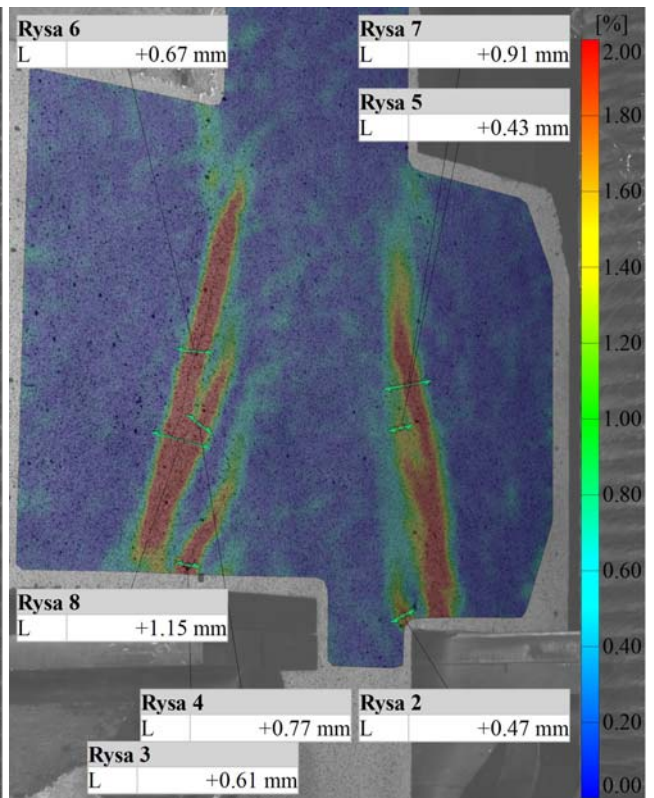

E-0



Wspornik po zniszczeniu w stanowisku / Corbel after failure in the test setup



Wspornik po zniszczeniu / Corbel after failure

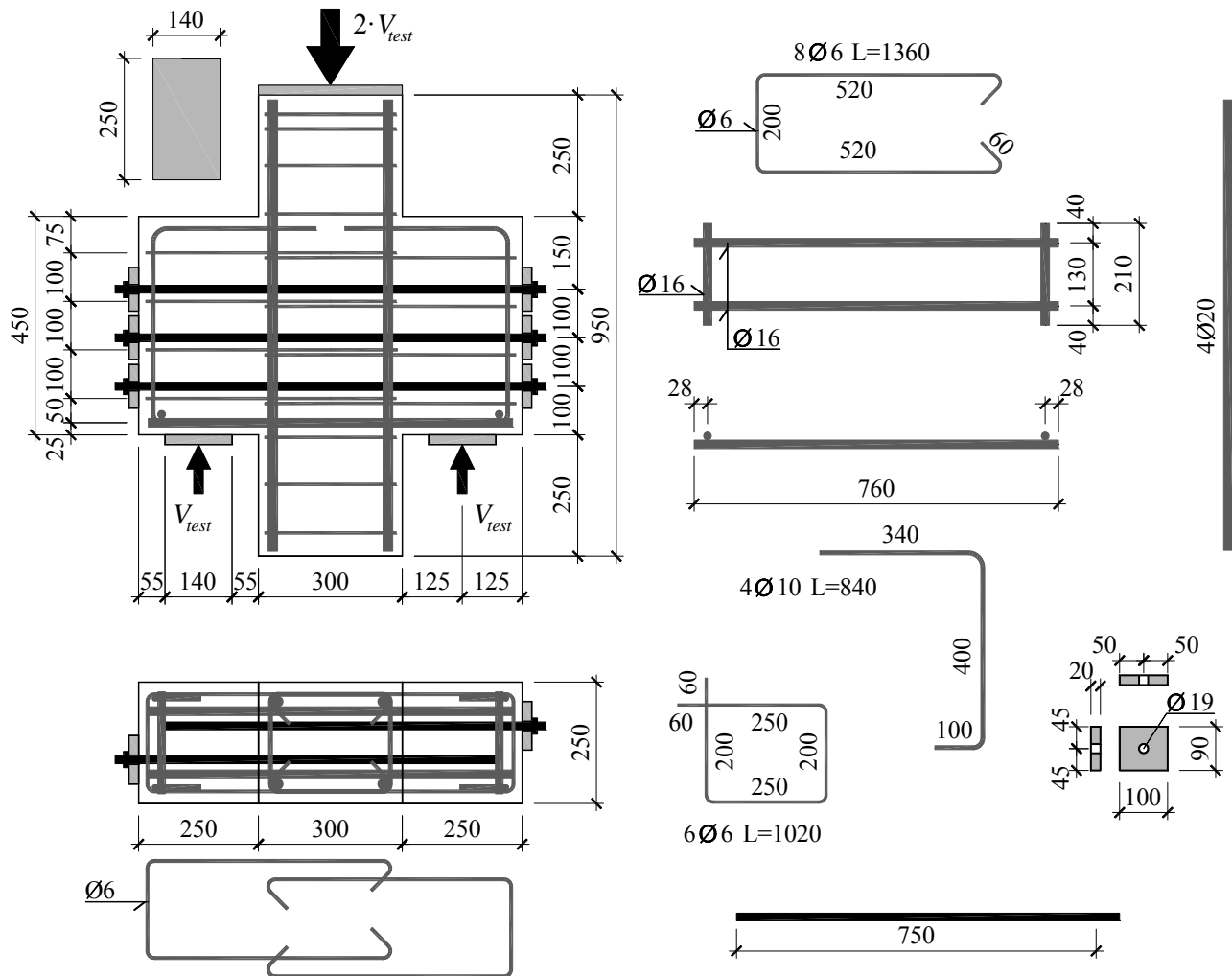

Zbrojenie modelu / Specimen's reinforcement

Wytrzymałość betonu na ściskanie / Compressive strength of concrete

$$f_{cm} = 47,3 \text{ MPa}$$

Moduł sprężystości podłużnej / Young's modulus

$$E_{cm} = 28,2 \text{ GPa}$$

Wytrzymałość betonu na rozciąganie przy rozłupywaniu / Tensile splitting strength of concrete

$$f_{ct,sp} = 3,9 \text{ MPa}$$

Gęstość betonu / Density of concrete

$$\rho = 2250 \text{ kg/m}^3$$

Charakterystyka zbrojenia / Characteristics of the reinforcement

Ø6

$$A_s = 28,07 \text{ mm}^2, f_{ym} = 385,6 \text{ MPa}, f_{tm} = 487,6 \text{ MPa}$$

Ø16

$$A_s = 200,53 \text{ mm}^2, f_{ym} = 533,6 \text{ MPa}, f_{tm} = 638,5 \text{ MPa}$$

Ø20

$$A_s = 310,67 \text{ mm}^2, f_{ym} = 541,0 \text{ MPa}, f_{tm} = 640,4 \text{ MPa}$$

M16

$$A_s = 141,03 \text{ mm}^2, f_{ym} = 1032,0 \text{ MPa}, f_{tm} = 1099,0 \text{ MPa}$$

Siła niszcząca / Failure force

$$V_{test} = 1510 \text{ kN}$$

E-I

Beton – odkształcenia po stronie S i N (na wsporniku) (ε_c) / Concrete – strains on S and N side (on the corbel) (ε_c)

obciążenie wspornika corbel load	odkształcenie S S strain				odkształcenie N N strain			
	1	2	3	średnia/ average	4	5	6	średnia/ average
kN	‰	‰	‰	‰	‰	‰	‰	‰
0	0,000	0,000	0,000	0,000	0,000	0,000	0,000	0,000
0	0,000	0,000	-0,001	0,000	-0,002	0,005	0,000	0,001
0	0,000	-0,008	0,000	-0,003	-0,008	0,001	0,000	-0,002
50	-0,004	0,016	-0,001	0,004	-0,051	0,031	-0,003	-0,008
100	-0,002	0,010	-0,010	-0,001	-0,054	-0,011	-0,013	-0,026
150	-0,005	0,008	-0,010	-0,002	-0,058	-0,005	-0,027	-0,030
200	-0,015	-0,004	-0,025	-0,015	-0,114	-0,001	-0,053	-0,056
250	-0,039	-0,026	-0,053	-0,039	-0,158	-0,156	-0,082	-0,132
300	-0,050	-0,034	-0,080	-0,055	-0,191	-0,172	-0,095	-0,153
350	-0,054	-0,037	-0,091	-0,061	-0,241	-0,279	-0,107	-0,209
400	-0,053	-0,041	-0,106	-0,067	-0,263	-0,434	-0,125	-0,274
450	-0,055	-0,041	-0,112	-0,069	-0,278	-0,428	-0,132	-0,279
500	-0,057	-0,036	-0,115	-0,069	-0,307	-0,506	-0,138	-0,317
500	-0,033	-0,010	-0,078	-0,040	-0,344	-0,405	-0,130	-0,293
500	-0,025	0,006	-0,088	-0,036	-0,651	-0,653	-0,116	-0,473
500	-0,025	-0,071	-0,099	-0,065	-0,376		-0,101	-0,239
500	-0,061	-0,031	-0,142	-0,078	-0,219		-0,083	-0,151
500	-0,057	0,018	-0,170	-0,070	-0,275		-0,074	-0,175
550	-0,069	0,007	-0,178	-0,080	-0,315		-0,092	-0,204
600	-0,085	-0,007	-0,186	-0,093	-0,331		-0,104	-0,218
650	-0,092	-0,039	-0,183	-0,105	-0,347		-0,113	-0,230
700	-0,109	-0,050	-0,190	-0,116	-0,355		-0,103	-0,229
750	-0,081	-0,018	-0,146	-0,082	-0,369		-0,062	-0,216
800	-0,061	-0,024	-0,132	-0,072	-0,393		-0,056	-0,225
850	-0,056	-0,029	-0,128	-0,071	-0,414		-0,053	-0,234
900	-0,048	-0,036	-0,113	-0,066	-0,407		-0,061	-0,234
950	-0,047	-0,034	-0,099	-0,060	-0,428		-0,061	-0,245
1000	-0,038	-0,037	-0,076	-0,050	-0,432		-0,053	-0,243
1050	-0,029	-0,054	-0,062	-0,048	-0,437		-0,031	-0,234
1050	-0,008	-0,058	-0,033	-0,033	-0,432		-0,003	-0,218
1100	-0,017	-0,075	-0,035	-0,042	-0,439		-0,002	-0,221
1125	-0,004	-0,102	-0,018	-0,041	-0,422		0,032	-0,195
1150	-0,012	-0,072	-0,025	-0,036	-0,427		0,028	-0,200
1177	0,008	-0,130	-0,007	-0,043	-0,386		0,090	-0,148
1201	0,002	-0,133	-0,008	-0,046	-0,388		0,088	-0,150
1224	0,019	-0,102	0,038	-0,015	-0,351		0,161	-0,095
1250	0,017	-0,106	0,037	-0,017	-0,355		0,162	-0,097
1276	0,135	0,002	0,126	0,088	-0,328		0,246	-0,041
1300	0,300	0,044	0,190	0,178	-0,289		0,311	0,011
1322	0,294	0,040	0,188	0,174	-0,297		0,308	0,006
1351	0,297	0,035	0,185	0,172	-0,302		0,308	0,003
1376	0,386	0,056	0,247	0,230	-0,274		0,353	0,040
1401	0,383	0,049	0,241	0,224	-0,279		0,353	0,037
1427	0,493	0,076	0,308	0,292	-0,265		0,436	0,086
1450	0,571	0,089	0,374	0,345	-0,265		0,540	0,138
1475	0,607	0,117	0,417	0,380	-0,359		0,648	0,145
1499	0,606	0,101	0,411	0,373	-0,373		0,648	0,138
1510	0,683	0,107	0,426	0,405	-0,390		1,188	0,399
1497	0,704	0,113	0,442	0,420	-0,448		1,705	0,629
1045	0,784	0,194	0,588	0,522	-0,588		0,408	-0,090
875	0,761	0,170	0,586	0,506	-0,605		0,359	-0,123
750	0,740	0,143	0,573	0,485	-0,602		0,341	-0,131
627	0,693	0,125	0,549	0,456	-0,589		0,335	-0,127

Beton – odkształcenia po stronie S i N (na wsporniku) (ϵ_c) / Concrete – strains on S and N side (on the corbel) (ϵ_c)

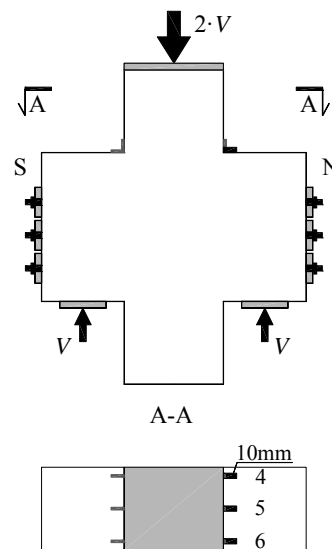
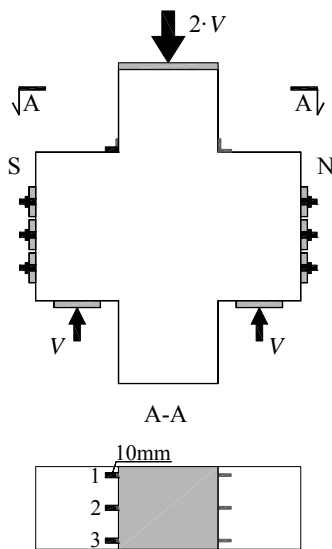
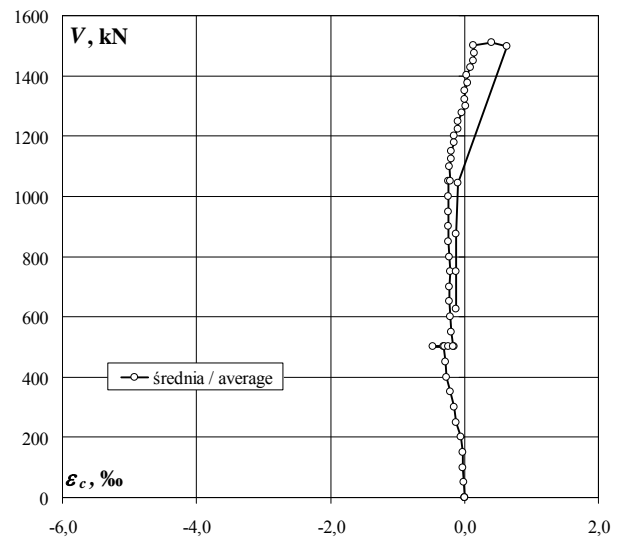
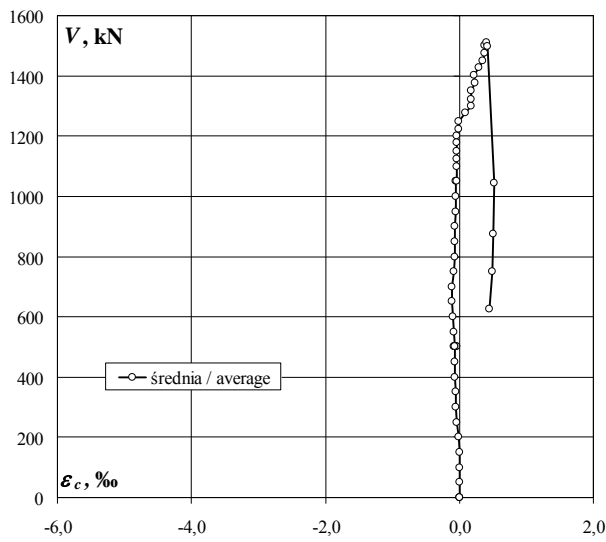
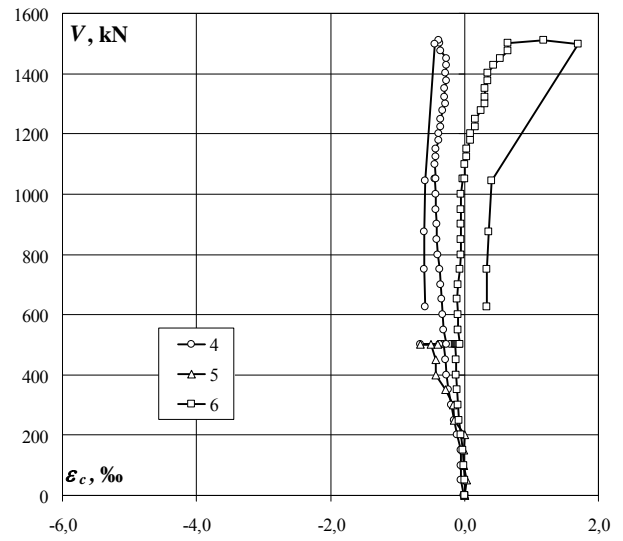
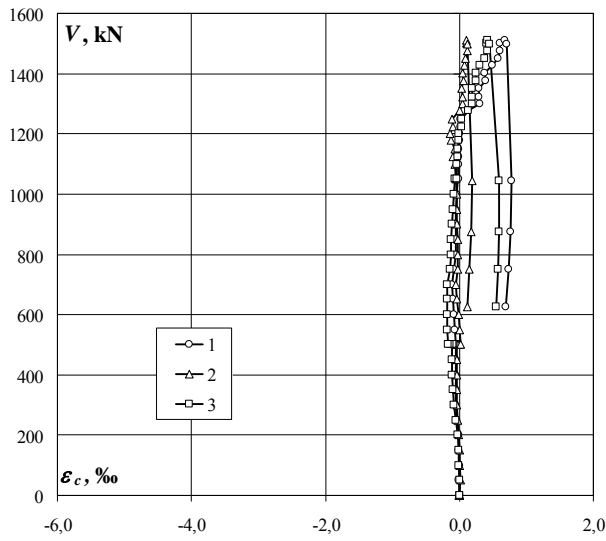

E-I

Beton – odkształcenia po stronie S i N (na słupie) (ε_c) / Concrete – strains on S and N side (on the column) (ε_c)

obciążenie wspornika corbel load	odkształcenie S S strain				odkształcenie N N strain			
	7	8	9	średnia/ average	10	11	12	średnia/ average
kN	‰	‰	‰	‰	‰	‰	‰	‰
0	0,000	0,000	0,000	0,000	0,000	0,000	0,000	0,000
0	0,000	0,000	-0,008	-0,003	0,000	0,000	0,000	0,000
0	0,001	0,000	0,005	0,002	0,000	0,000	0,000	0,000
50	-0,011	-0,002	0,059	0,015	-0,027	-0,045	-0,121	-0,064
100	-0,050	-0,009	0,039	-0,007	-0,061	-0,122	-0,276	-0,153
150	-0,097	-0,018	0,001	-0,038	-0,102	-0,208	-0,397	-0,236
200	-0,143	-0,034	-0,047	-0,075	-0,156	-0,295	-0,480	-0,310
250	-0,206	-0,074	-0,103	-0,128	-0,246	-0,430	-0,562	-0,413
300	-0,268	-0,119	-0,099	-0,162	-0,340	-0,563	-0,632	-0,512
350	-0,343	-0,170	-0,137	-0,217	-0,448	-0,709	-0,704	-0,620
400	-0,412	-0,217	-0,170	-0,266	-0,562	-0,852	-0,766	-0,727
450	-0,484	-0,261	-0,227	-0,324	-0,685	-0,998	-0,838	-0,840
500	-0,559	-0,309	-0,263	-0,377	-0,823	-1,136	-0,916	-0,958
500	-0,607	-0,342	-0,263	-0,404	-0,891	-1,166	-0,947	-1,001
500	-0,625	-0,339	-0,263	-0,409	-0,922	-1,175	-0,963	-1,020
500	-0,635	-0,366	-0,263	-0,421	-0,968	-1,190	-0,983	-1,047
500	-0,623	-0,357	-0,263	-0,414	-0,996	-1,196	-0,988	-1,060
500	-0,620	-0,383	-0,276	-0,426	-1,007	-1,196	-0,994	-1,066
550	-0,667	-0,413	-0,345	-0,475	-1,091	-1,257	-1,048	-1,132
600	-0,718	-0,440	-0,422	-0,527	-1,216	-1,331	-1,115	-1,221
650	-0,782	-0,477	-0,532	-0,597	-1,431	-1,431	-1,203	-1,355
700	-0,853	-0,514	-0,699	-0,689	-1,669	-1,537	-1,317	-1,508
750	-1,017	-0,611	-1,042	-0,890	-1,950	-1,663	-1,511	-1,708
800	-1,131	-0,678	-1,233	-1,014	-2,216	-1,765	-1,648	-1,876
850	-1,242	-0,738	-1,403	-1,128	-2,500	-1,877	-1,791	-2,056
900	-1,354	-0,807	-1,617	-1,259	-2,904	-2,019	-1,918	-2,280
950	-1,474	-0,876	-1,843	-1,398	-3,296	-2,165	-2,088	-2,516
1000	-1,588	-0,944	-2,040	-1,524	-3,664	-2,302	-2,282	-2,749
1050	-1,719	-1,013	-2,255	-1,662	-4,070	-2,445	-2,514	-3,010
1050	-1,781	-1,041	-2,382	-1,735	-4,275	-2,504	-2,631	-3,137
1100	-1,852	-1,083	-2,480	-1,805	-4,497	-2,592	-2,764	-3,284
1125	-1,971	-1,127	-2,623	-1,907	-4,853	-2,694	-2,944	-3,497
1150	-2,000	-1,143	-2,660	-1,934	-4,945	-2,726	-2,996	-3,556
1177	-2,132	-1,189	-2,879	-2,067	-5,308	-2,850	-3,262	-3,807
1201	-2,164	-1,205	-2,913	-2,094	-5,379	-2,878	-3,316	-3,858
1224	-2,263	-1,251	-3,087	-2,200	-5,634	-2,996	-3,574	-4,068
1250	-2,291	-1,268	-3,129	-2,229	-5,706	-3,028	-3,626	-4,120
1276	-2,455	-1,334	-3,376	-2,388	-6,018	-3,195	-3,979	-4,397
1300	-2,578	-1,391	-3,586	-2,518	-6,263	-3,321	-4,308	-4,631
1322	-2,601	-1,402	-3,611	-2,538	-6,297	-3,346	-4,341	-4,661
1351	-2,635	-1,421	-3,650	-2,569	-6,370	-3,373	-4,414	-4,719
1376	-2,750	-1,452	-3,819	-2,674	-6,487	-3,472	-4,718	-4,892
1401	-2,779	-1,467	-3,854	-2,700	-6,507	-3,489	-4,770	-4,922
1427	-2,937	-1,529	-4,096	-2,854	-5,888	-3,628	-5,195	-4,904
1450	-3,101	-1,586	-4,329	-3,005	-5,318	-3,762	-5,654	-4,911
1475	-3,221	-1,638	-4,481	-3,113	-4,901	-3,838	-5,998	-4,912
1499	-3,253	-1,649	-4,510	-3,137	-4,894	-3,864	-6,070	-4,943
1510	-3,415	-1,690	-4,669	-3,258	-3,436	-4,004	-7,278	-4,906
1497	-3,420	-1,686	-4,674	-3,260	-1,358	-2,646	-8,392	-4,132
1045	-3,079	-1,491	-4,248	-2,939	-0,144	-2,267	-3,204	-1,872
875	-2,951	-1,399	-4,081	-2,810	0,152	-1,454	-2,548	-1,283
750	-2,788	-1,321	-3,854	-2,654	0,160	-1,325	-2,324	-1,163
627	-2,606	-1,231	-3,591	-2,476	0,133	-1,272	-2,215	-1,118

Beton – odkształcenia po stronie S i N (na słupie) (ϵ_c) / Concrete – strains on S and N side (on the column) (ϵ_c)

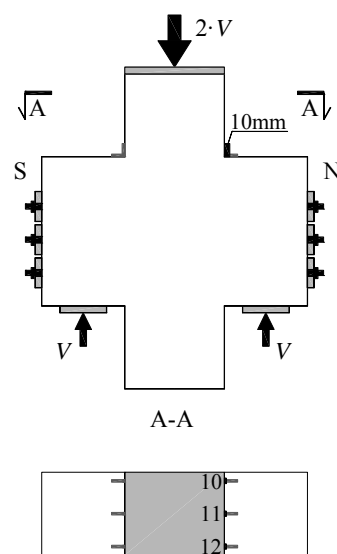
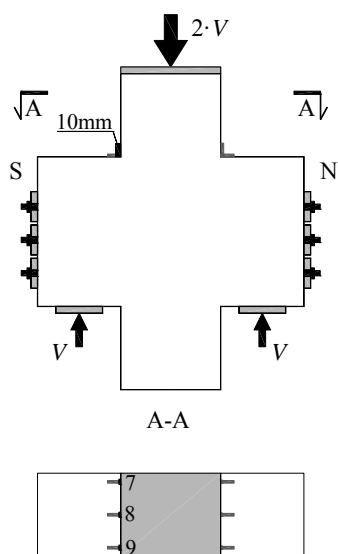
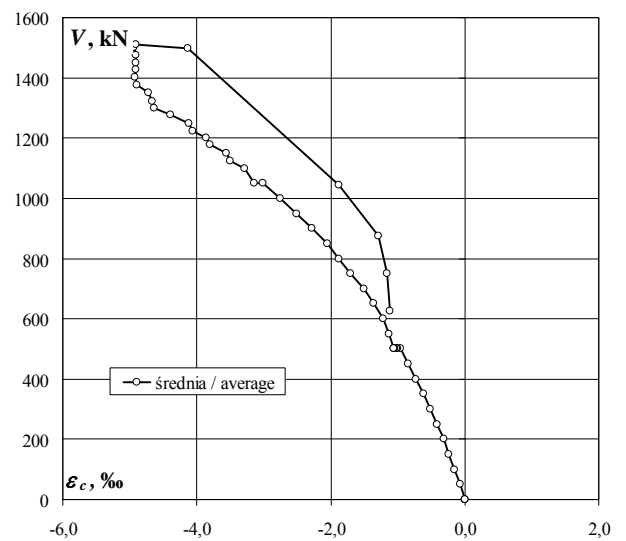
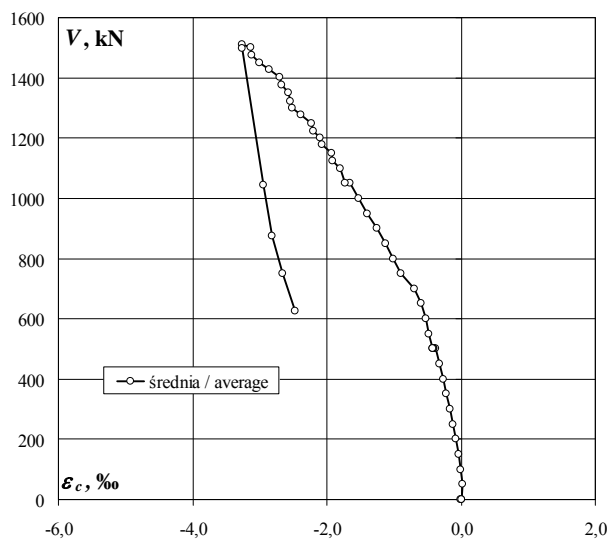
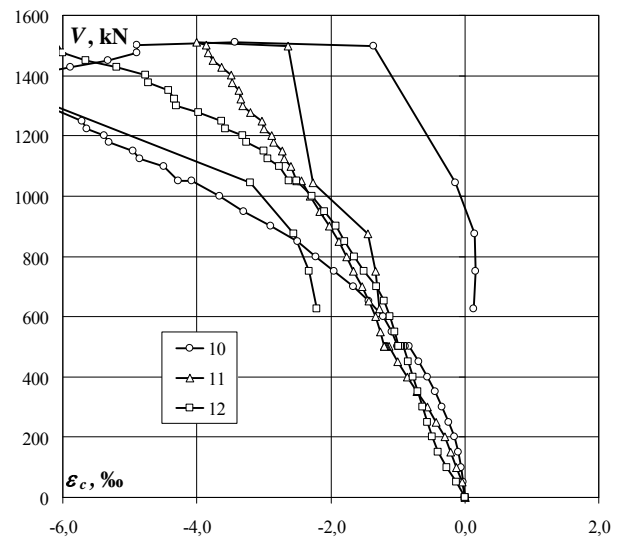
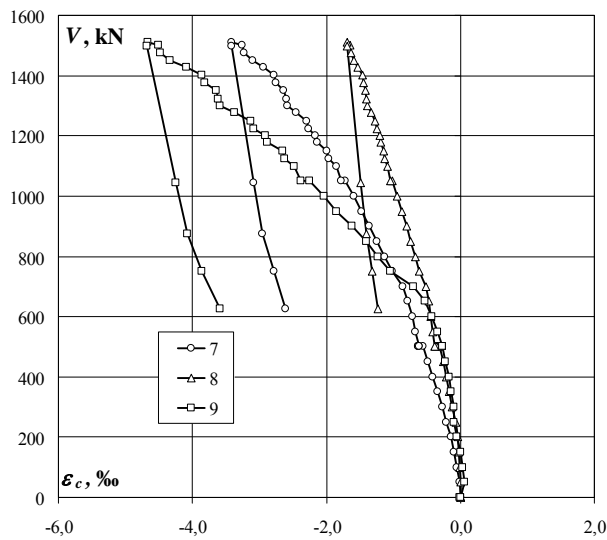

E-I

Zbrojenie główne – odkształcenia po stronie S i N (ϵ_s) / Main reinforcement – strains on S and N side (ϵ_s)

obciążenie wspornika corbel load	odkształcenie S S strain			odkształcenie N N strain		
	1	2	średnia/ average	3	4	średnia/ average
	%	%	%	%	%	%
0	0,000	0,000	0,000	0,000	0,000	0,000
0	0,001	-0,002	-0,001	-0,005	-0,005	-0,005
0	-0,001	0,001	0,000	-0,004	-0,007	-0,006
50	0,018	0,019	0,019	0,031	0,020	0,026
100	0,056	0,071	0,064	0,081	0,050	0,066
150	0,129	0,177	0,153	0,186	0,145	0,166
200	0,271	0,350	0,311	0,339	0,333	0,336
250	0,497	0,543	0,520	0,697	0,808	0,753
300	0,809	0,770	0,790	0,830	0,969	0,900
350	1,084	1,049	1,067	0,972	1,118	1,045
400	1,386	1,248	1,317	1,095	1,233	1,164
450	1,579	1,395	1,487	1,229	1,346	1,288
500	1,711	1,511	1,611	1,356	1,445	1,401
500	1,573	1,546	1,560	1,407	1,468	1,438
500	1,463	1,568	1,516	1,421	1,472	1,447
500	1,465	1,604	1,535	1,286	1,445	1,366
500	1,354	1,565	1,460	1,388		1,388
500	1,322	1,549	1,436	1,371		1,371
550	1,383	1,610	1,497	1,446		1,446
600	1,440	1,680	1,560	1,524		1,524
650	1,475	1,732	1,604	1,561		1,561
700	1,521	1,800	1,661	1,634		1,634
750	1,626	1,936	1,781	1,709		1,709
800	1,699	2,009	1,854	1,773		1,773
850	1,770	2,086	1,928	1,841		1,841
900	1,834	2,158	1,996	1,915		1,915
950	1,898	2,247	2,073	1,975		1,975
1000	1,955	2,319	2,137	2,037		2,037
1050	2,020	2,402	2,211	2,105		2,105
1050	2,029	2,419	2,224	2,116		2,116
1100	2,080	2,481	2,281	2,167		2,167
1125	2,106	2,518	2,312	2,197		2,197
1150	2,136	2,561	2,349	2,220		2,220
1177	2,170	2,611	2,391	2,242		2,242
1201	2,188	2,634	2,411	2,262		2,262
1224	2,215	2,686	2,451	2,296		2,296
1250	2,240	2,789	2,515	2,319		2,319
1276	2,291	2,938	2,615	2,361		2,361
1300	2,312	3,128	2,720	2,398		2,398
1322	2,329	3,146	2,738	2,414		2,414
1351	2,352	3,218	2,785	2,438		2,438
1376	2,380	3,428	2,904	2,556		2,556
1401	2,401	3,461	2,931	2,578		2,578
1427	2,521	4,040	3,281	2,826		2,826
1450	2,633	4,382	3,508	2,883		2,883
1475	2,701	4,500	3,601	2,881		2,881
1499	2,715	4,535	3,625	2,901		2,901
1510	2,774	4,586	3,680	2,691		2,691
1497	2,743	4,511	3,627	2,647		2,647
1045	2,159	3,851	3,005	1,039		1,039
875	1,988	3,674	2,831	0,809		0,809
750	1,854	3,518	2,686	0,886		0,886
627	1,719	3,349	2,534	0,883		0,883

Zbrojenie główne – odkształcenia po stronie S i N (ϵ_s) / Main reinforcement – strains on S and N side (ϵ_s)

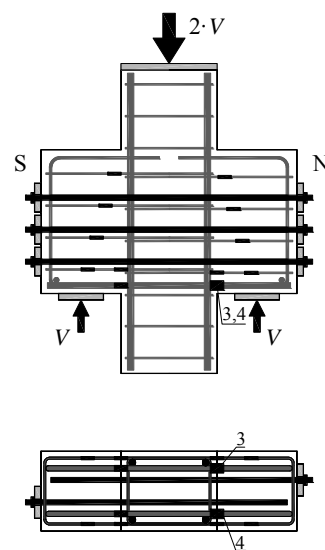
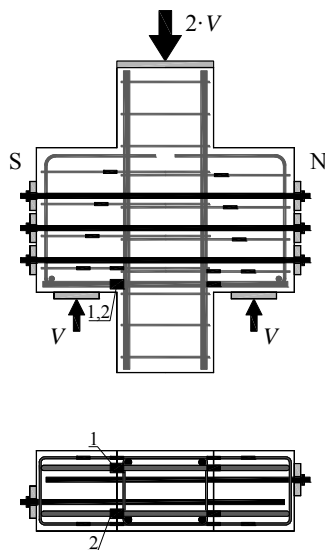
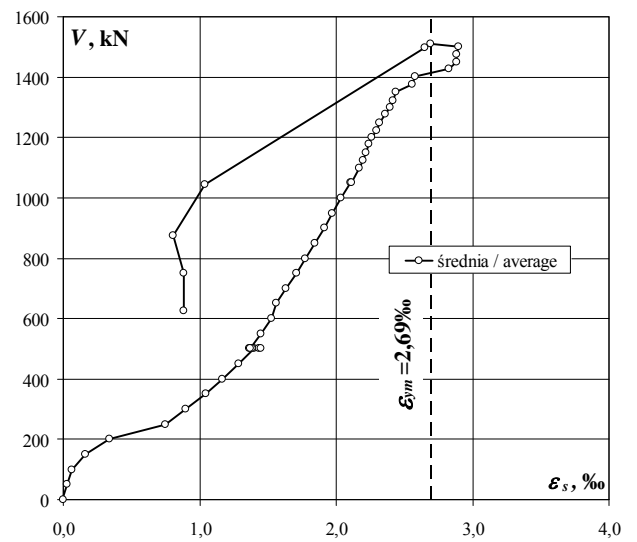
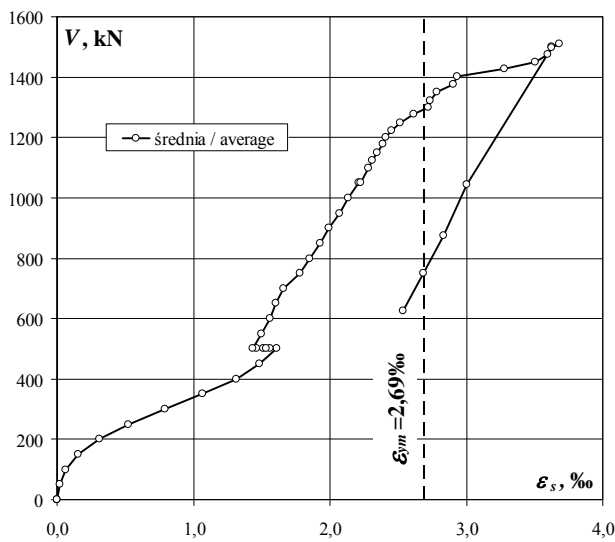
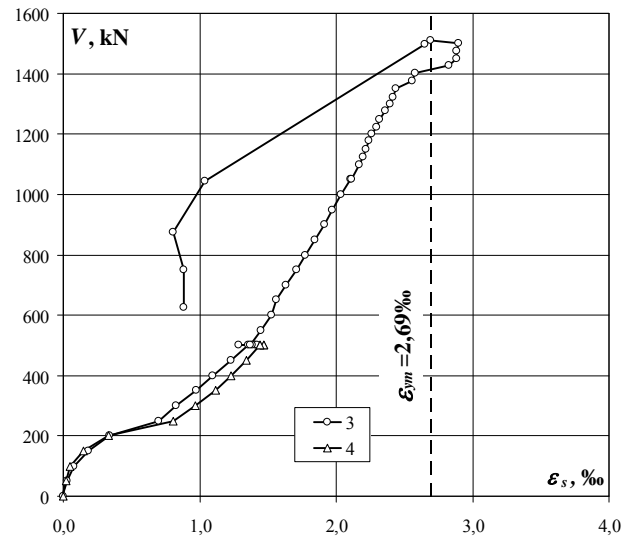
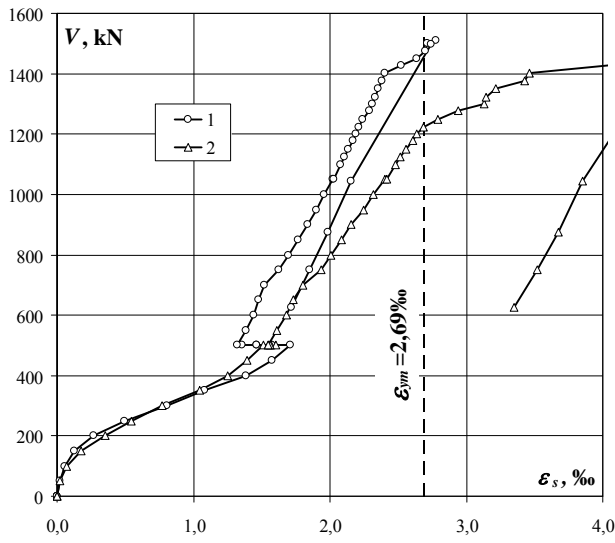

E-I

Strzemię 1a – odkształcenia po stronie S i N (ϵ_s) / Stirrup 1a – strains on S and N side (ϵ_s)

obciążenie wspornika corbel load	odkształcenie S S strain			odkształcenie N N strain		
	5	6	średnia/ average	7	8	średnia/ average
	%	%	%	%	%	%
kN						
0	0,000	0,000	0,000	0,000	0,000	0,000
0	-0,001	0,006	0,003	-0,002	0,002	0,000
0	0,005	0,006	0,006	0,000	0,001	0,001
50	0,003	0,007	0,005	0,009	0,009	0,009
100	0,020	0,033	0,027	0,032	0,027	0,030
150	0,049	0,051	0,050	0,079	0,049	0,064
200	0,101	0,237	0,169	0,168	0,131	0,150
250	0,303	0,472	0,388	0,444	0,576	0,510
300	0,529	0,772	0,651	0,511	0,745	0,628
350	0,644	1,014	0,829	0,599	0,911	0,755
400	0,768	1,228	0,998	0,640	1,066	0,853
450	0,908	1,473	1,191	0,736	1,252	0,994
500	1,031	1,740	1,386	0,840	1,427	1,134
500	1,038	1,919	1,479	0,906	1,530	1,218
500	1,044	1,962	1,503	0,950	1,595	1,273
500	0,924	2,161	1,543	0,919	1,602	1,261
500	0,885	2,100	1,493	0,828		0,828
500	0,646	2,102	1,374	0,822		0,822
550	0,700	2,186	1,443	0,872		0,872
600	0,766	2,491	1,629	0,944		0,944
650	0,803	2,871	1,837	1,057		1,057
700	0,865	3,404	2,135	1,144		1,144
750	0,568	3,086	1,827	1,184		1,184
800	0,550	3,135	1,843	1,236		1,236
850	0,587	3,196	1,892	1,286		1,286
900	0,611	3,267	1,939	1,227		1,227
950	0,652	3,354	2,003	1,264		1,264
1000	0,688	3,453	2,071	1,308		1,308
1050	0,722	3,747	2,235	1,362		1,362
1050	0,724	3,968	2,346	1,376		1,376
1100	0,758	4,186	2,472	1,410		1,410
1125	0,780	4,552	2,666	1,445		1,445
1150	0,801	4,626	2,714	1,460		1,460
1177	0,819	5,109	2,964	1,491		1,491
1201	0,832	5,185	3,009	1,505		1,505
1224	0,883	5,677	3,280	1,533		1,533
1250	0,894	5,744	3,319	1,551		1,551
1276	0,881	6,369	3,625	1,576		1,576
1300	0,896	7,078	3,987	1,603		1,603
1322	0,908	7,105	4,007	1,622		1,622
1351	0,910	7,210	4,060	1,636		1,636
1376	0,955	7,912	4,434	1,659		1,659
1401	0,967	7,977	4,472	1,676		1,676
1427	1,011	8,869	4,940	1,679		1,679
1450	1,031	9,283	5,157	1,633		1,633
1475	1,037	9,222	5,130	1,633		1,633
1499	1,049	9,238	5,144	1,637		1,637
1510	1,029	9,041	5,035	1,717		1,717
1497	1,028	8,996	5,012	1,695		1,695
1045	0,716	8,587	4,652	1,020		1,020
875	0,578	8,432	4,505	1,082		1,082
750	0,480	8,300	4,390	0,974		0,974
627	0,378	8,156	4,267	0,837		0,837

Strzemię 1a – odkształcenia po stronie S i N (ϵ_s) / Stirrup 1a – strains on S and N side (ϵ_s)

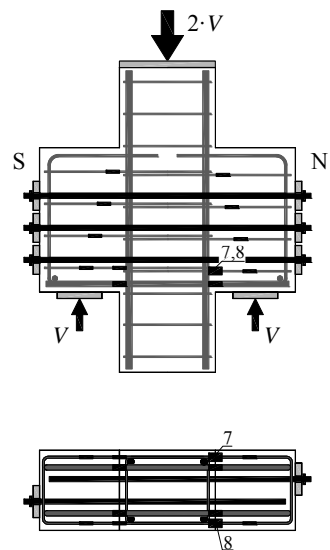
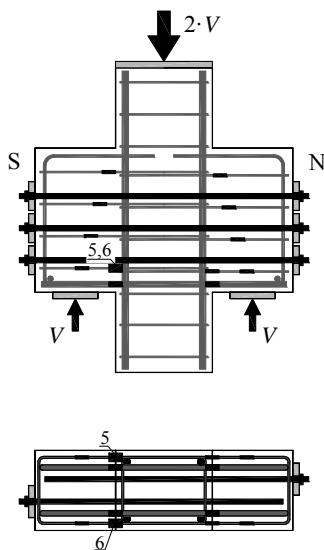
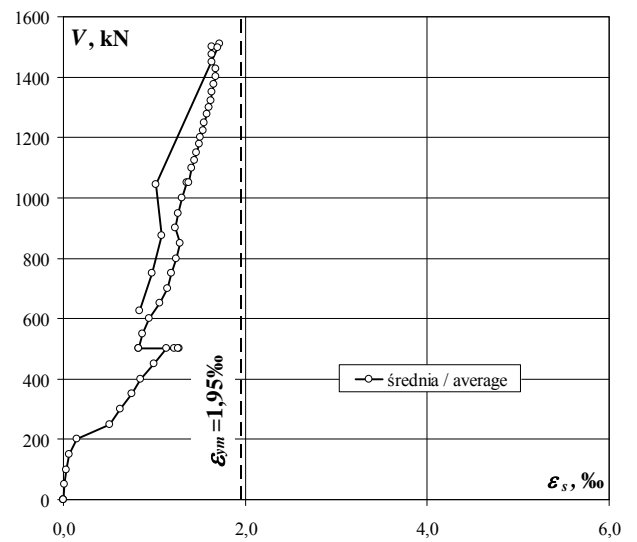
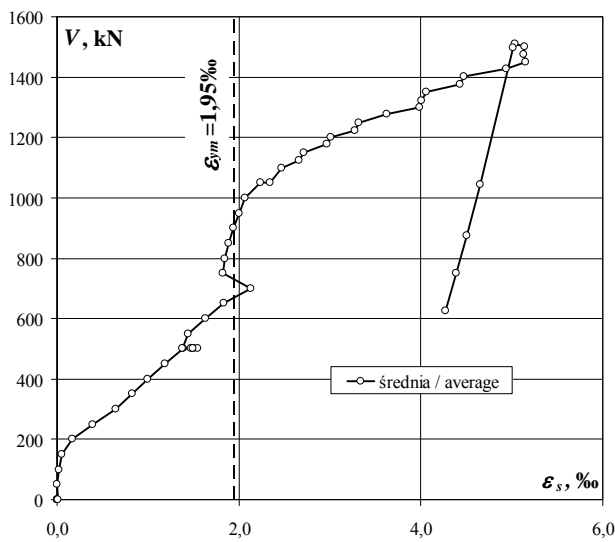
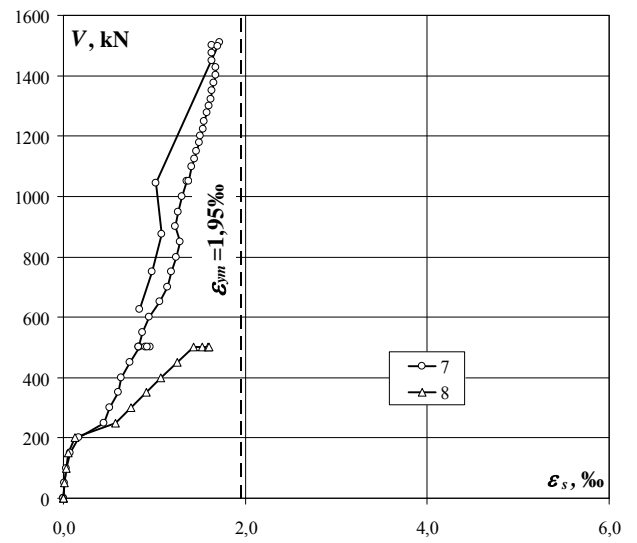
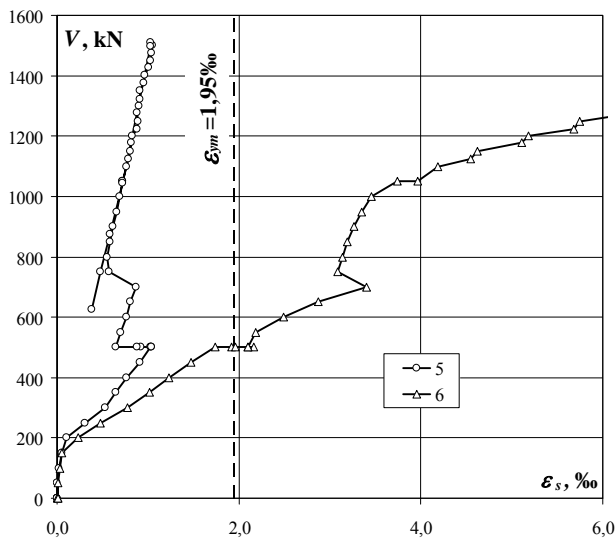

E-I

Strzemię 1b – odkształcenia po stronie S i N (ε_s) / Stirrup 1b – strains on S and N side (ε_s)

obciążenie wspornika corbel load	odkształcenie S S strain			odkształcenie N N strain		
	9	10	średnia/ average	11	12	średnia/ average
	%	%	%	%	%	%
0	0,000	0,000	0,000	0,000	0,000	0,000
0	-0,009	-0,003	-0,006	0,000	0,002	0,001
0	0,000	0,002	0,001	0,002	0,000	0,001
50	0,006	0,018	0,012	0,009	0,011	0,010
100	0,012	0,031	0,022	0,021	0,026	0,024
150	0,017	0,048	0,033	0,031	0,043	0,037
200	-0,020	0,051	0,016	0,038	0,051	0,045
250	-0,028	0,057	0,015	0,044	0,058	0,051
300	-0,011	0,067	0,028	0,060	0,063	0,062
350	0,022	0,072	0,047	0,105	0,073	0,089
400	0,280	0,088	0,184	0,299	0,076	0,188
450	0,424	0,102	0,263	0,417	0,088	0,253
500	0,553	0,119	0,336	0,510	0,101	0,306
500	0,623	0,129	0,376	0,609	0,118	0,364
500	0,776	0,158	0,467	0,655	0,124	0,390
500	0,592	0,133	0,363	0,664	0,121	0,393
500	0,794		0,794	0,603	0,127	0,365
500	0,411		0,411	0,621	0,124	0,373
550	0,405		0,405	0,635	0,124	0,380
600	0,419		0,419	0,669	0,134	0,402
650	0,420		0,420	0,795	0,152	0,474
700	0,448		0,448	0,867	0,185	0,526
750	0,525		0,525	0,910	0,923	0,917
800	0,544		0,544	0,954	1,072	1,013
850	0,602		0,602	0,999	1,176	1,088
900	0,631		0,631	1,114	1,262	1,188
950	0,653		0,653	1,184	1,273	1,229
1000	0,655		0,655	1,231	1,204	1,218
1050	0,694		0,694	1,276	1,254	1,265
1050	0,713		0,713	1,291	1,258	1,275
1100	0,743		0,743	1,317	1,256	1,287
1125	0,787		0,787	1,336	1,292	1,314
1150	0,808		0,808	1,357	1,325	1,341
1177	0,842		0,842	1,365	1,349	1,357
1201	0,862		0,862	1,380	1,331	1,356
1224	0,518		0,518	1,397	1,305	1,351
1250	0,508		0,508	1,412	1,289	1,351
1276	0,176		0,176	1,428	1,309	1,369
1300	0,068		0,068	1,470	1,388	1,429
1322	0,079		0,079	1,475	1,389	1,432
1351	0,081		0,081	1,487	1,405	1,446
1376	0,053		0,053	1,501	1,421	1,461
1401	0,066		0,066	1,510	1,432	1,471
1427	0,058		0,058	1,510	1,454	1,482
1450	0,053		0,053	1,502	1,506	1,504
1475	0,042		0,042	1,521	1,596	1,559
1499	0,057		0,057	1,509	1,622	1,566
1510	0,042		0,042	1,477	1,765	1,621
1497	0,045		0,045	1,450	2,011	1,731
1045	-0,149		-0,149	1,380	0,757	1,069
875	-0,213		-0,213	1,358	0,990	1,174
750	-0,219		-0,219	1,312	1,081	1,197
627	-0,188		-0,188	1,244	1,075	1,160

Strzemię 1b – odkształcenia po stronie S i N (ϵ_s) / Stirrup 1b – strains on S and N side (ϵ_s)

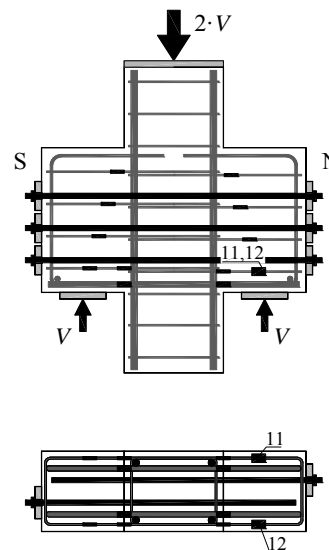
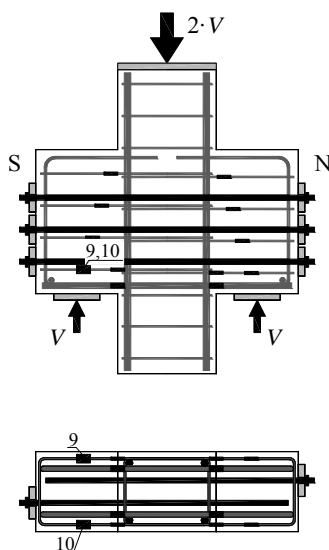
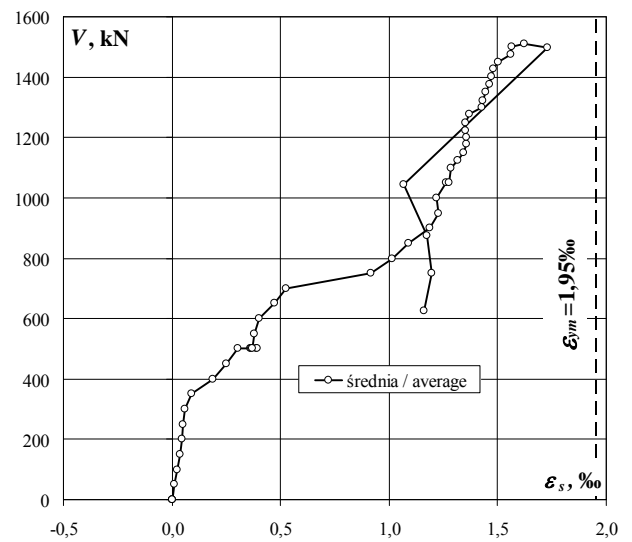
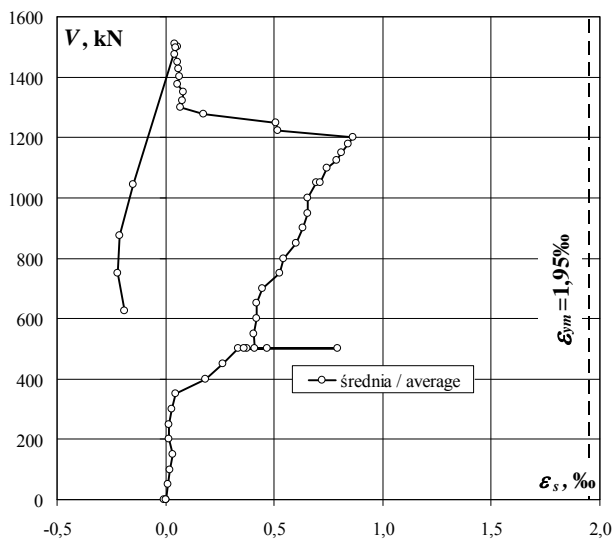
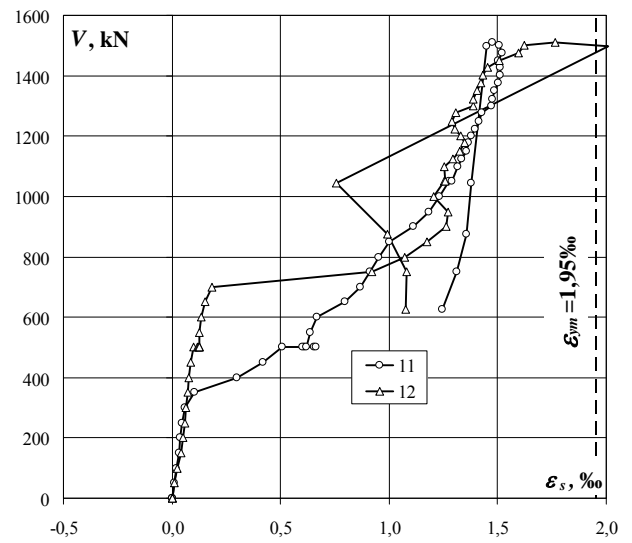
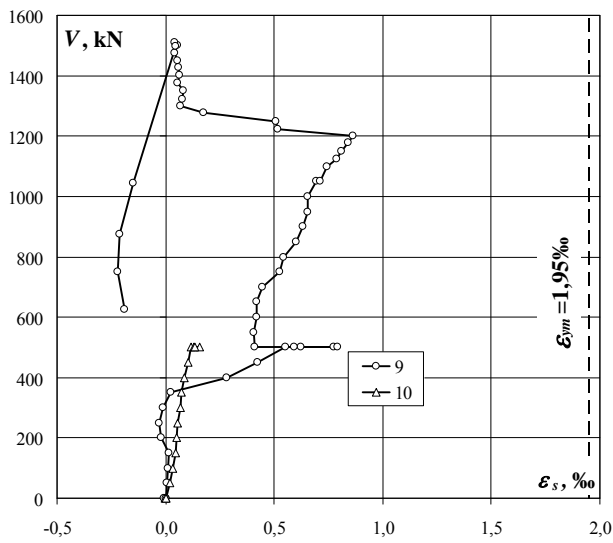

E-I

Strzemień 2 – odkształcenia po stronie S i N (ε_s) / Stirrup 2 – strains on S and N side (ε_s)

obciążenie wspornika corbel load	odkształcenie S S strain			odkształcenie N N strain		
	13	14	średnia/ average	15	16	średnia/ average
	%	%	%	%	%	%
0	0,000	0,000	0,000	0,000	0,000	0,000
0	0,000	-0,002	-0,001	0,000	0,008	0,004
0	0,000	0,000	0,000	0,004	0,047	0,026
50	0,010	0,003	0,007	0,010	0,033	0,022
100	0,011	0,012	0,012	0,022	0,056	0,039
150	0,023	0,025	0,024	0,039	0,085	0,062
200	0,032	0,046	0,039	0,059	0,066	0,063
250	0,047	0,057	0,052	0,047	0,062	0,055
300	0,052	0,060	0,056	0,051	0,075	0,063
350	0,121	0,061	0,091	0,058	0,066	0,062
400	0,310	0,070	0,190	0,072	0,112	0,092
450	0,413	0,082	0,248	0,081	0,112	0,097
500	0,505	0,086	0,296	0,091	0,133	0,112
500	0,381	0,089	0,235	0,080	0,322	0,201
500	0,367	0,100	0,234	0,081	0,322	0,202
500	0,296		0,296	-0,004	0,322	0,159
500	0,645		0,645	0,014	0,322	0,168
500	0,631		0,631	-0,012	0,322	0,155
550	0,642		0,642	-0,001	0,374	0,187
600	0,666		0,666	0,004	0,404	0,204
650	0,684		0,684	0,142	0,336	0,239
700	0,714		0,714	0,314	0,353	0,334
750	0,818		0,818	0,418	0,290	0,354
800	0,697		0,697	0,471	0,322	0,397
850	0,698		0,698	0,570	0,336	0,453
900	0,716		0,716	0,715	0,389	0,552
950	0,717		0,717	0,813	0,315	0,564
1000	0,728		0,728	0,881	0,299	0,590
1050	0,737		0,737	0,889	0,260	0,575
1050	0,742		0,742	0,907	0,353	0,630
1100	0,767		0,767	0,939	0,400	0,670
1125	0,767		0,767	0,967	0,487	0,727
1150	0,784		0,784	0,993	0,514	0,754
1177	0,883		0,883	1,031	0,636	0,834
1201	0,908		0,908	1,050	0,649	0,850
1224	0,968		0,968	1,087	0,965	1,026
1250	0,980		0,980	1,106	0,996	1,051
1276	1,144		1,144	1,138	1,492	1,315
1300	1,267		1,267	1,142	1,820	1,481
1322	1,277		1,277	1,152	1,837	1,495
1351	1,294		1,294	1,170	1,877	1,524
1376	1,377		1,377	1,171	2,037	1,604
1401	1,390		1,390	1,181	2,050	1,616
1427	1,486		1,486	1,183	1,831	1,507
1450	1,567		1,567	1,195	1,802	1,499
1475	1,609		1,609	1,218	1,762	1,490
1499	1,642		1,642	1,217	1,770	1,494
1510	1,703		1,703	1,222	1,758	1,490
1497	1,699		1,699	1,198	1,783	1,491
1045	1,399		1,399			
875	1,253		1,253			
750	1,168		1,168			
627	1,087		1,087			

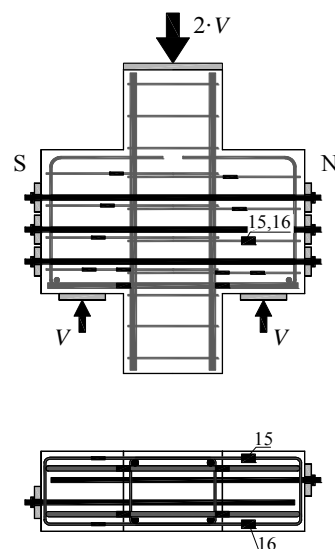
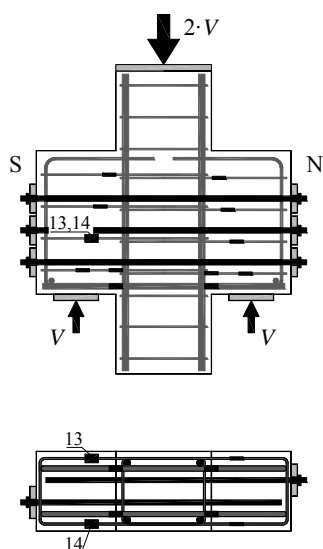
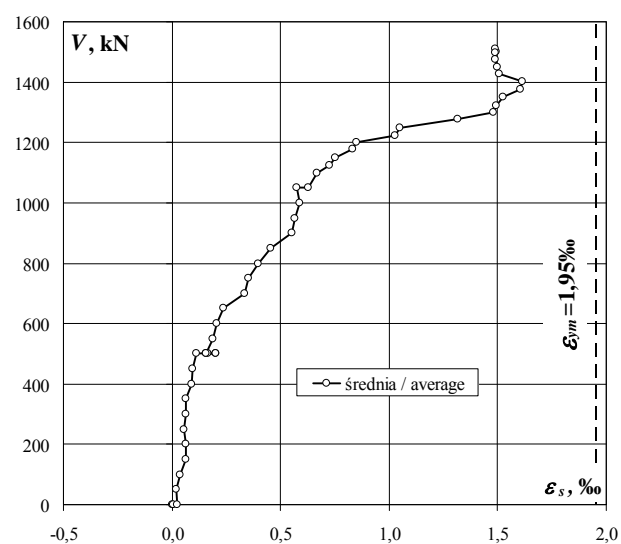
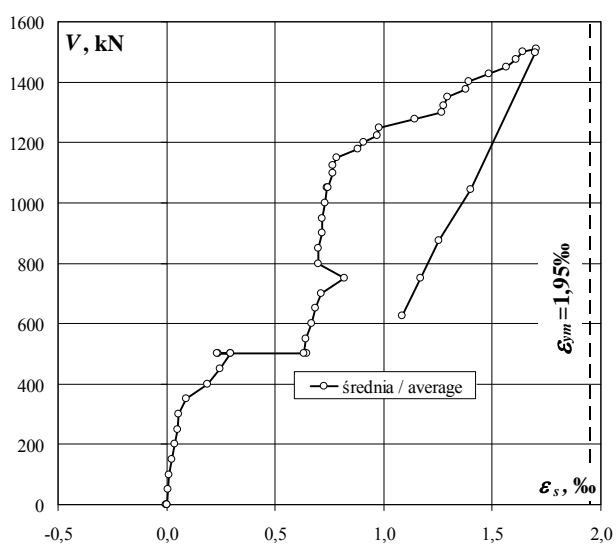
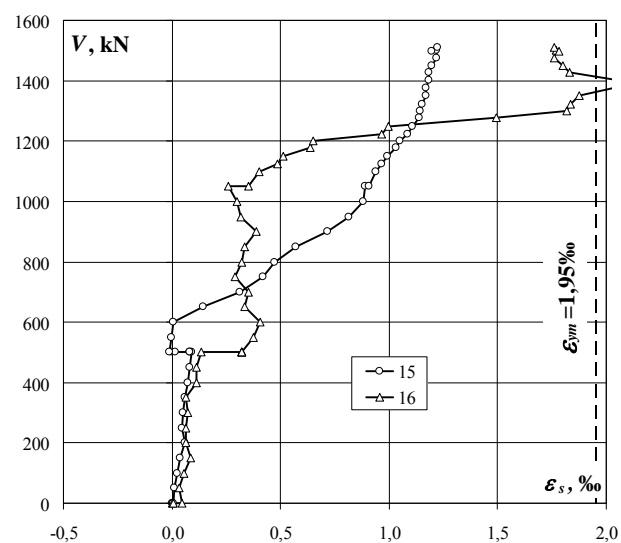
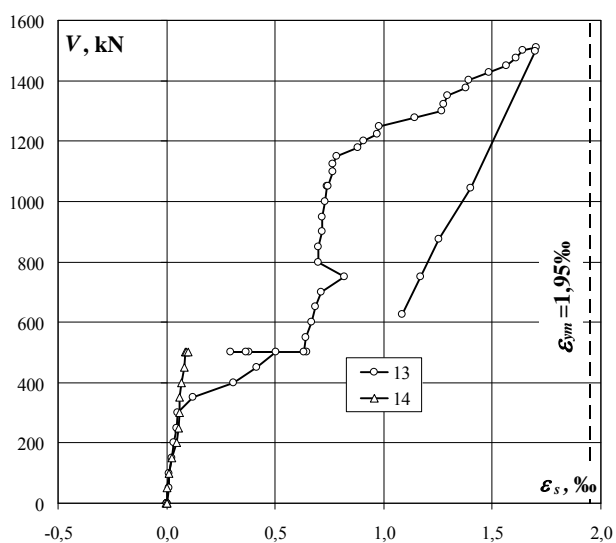
Strzemię 2 – odkształcenia po stronie S i N (ε_s) / Stirrup 2 – strains on S and N side (ε_s)

E-I

Strzemię 3 – odkształcenia po stronie S i N (ε_s) / Stirrup 3 – strains on S and N side (ε_s)

obciążenie wspornika corbel load	odkształcenie S S strain			odkształcenie N N strain		
	17	18	średnia/ average	19	20	średnia/ average
kN	‰	‰	‰	‰	‰	‰
0	0,000	0,000	0,000	0,000	0,000	0,000
0	-0,001	0,000	-0,001	0,000	-0,017	-0,009
0	0,001	0,002	0,002	-0,003	0,005	0,001
50	0,000	0,000	0,000	0,000	0,023	0,012
100	-0,004	-0,002	-0,003	-0,001	0,015	0,007
150	-0,006	-0,005	-0,006	0,000	0,000	0,000
200	-0,002	-0,002	-0,002	0,016	-0,039	-0,012
250	0,025	0,019	0,022	0,035	-0,019	0,008
300	0,048	0,023	0,036	0,046	-0,016	0,015
350	0,064	0,025	0,045	0,058	-0,031	0,014
400	0,087	0,029	0,058	0,062	-0,036	0,013
450	0,115	0,032	0,074	0,069	-0,051	0,009
500	0,261	0,034	0,148	0,074	-0,052	0,011
500	0,370	0,029	0,200	0,081	-0,126	-0,023
500	0,403		0,403	0,133		0,133
500	0,352		0,352	0,010		0,010
500	0,395		0,395	0,030		0,030
500	0,400		0,400	0,002		0,002
550	0,413		0,413	0,011		0,011
600	0,422		0,422	0,016		0,016
650	0,443		0,443	0,052		0,052
700	0,463		0,463	0,205		0,205
750	0,690		0,690	0,329		0,329
800	0,772		0,772	0,414		0,414
850	0,827		0,827	0,490		0,490
900	0,873		0,873	0,640		0,640
950	0,917		0,917	0,706		0,706
1000	0,957		0,957	0,750		0,750
1050	1,000		1,000	0,809		0,809
1050	1,017		1,017	0,839		0,839
1100	1,046		1,046	0,863		0,863
1125	1,063		1,063	0,885		0,885
1150	1,078		1,078	0,892		0,892
1177	1,110		1,110	0,900		0,900
1201	1,122		1,122	0,910		0,910
1224	1,157		1,157	0,941		0,941
1250	1,173		1,173	0,946		0,946
1276	1,229		1,229	0,963		0,963
1300	1,293		1,293	1,004		1,004
1322	1,301		1,301	1,007		1,007
1351	1,328		1,328	1,020		1,020
1376	1,377		1,377	1,046		1,046
1401	1,395		1,395	1,053		1,053
1427	1,432		1,432	1,101		1,101
1450	1,477		1,477	1,154		1,154
1475	1,514		1,514	1,192		1,192
1499	1,533		1,533	1,203		1,203
1510	1,595		1,595	1,218		1,218
1497	1,597		1,597	1,229		1,229
1045	1,355		1,355	0,820		0,820
875	1,238		1,238	0,827		0,827
750	1,134		1,134	0,840		0,840
627	1,032		1,032	0,822		0,822

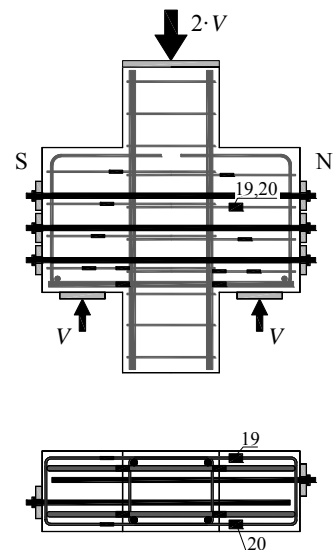
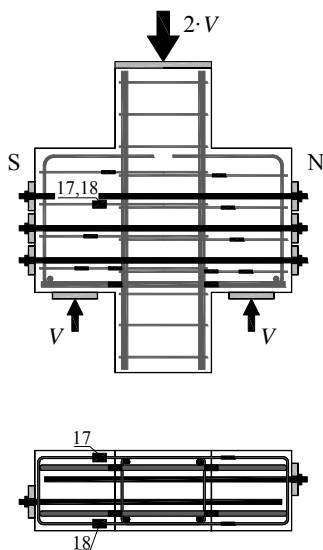
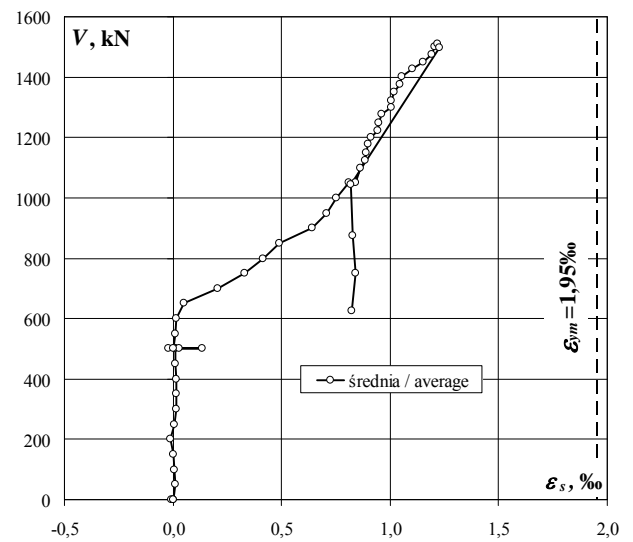
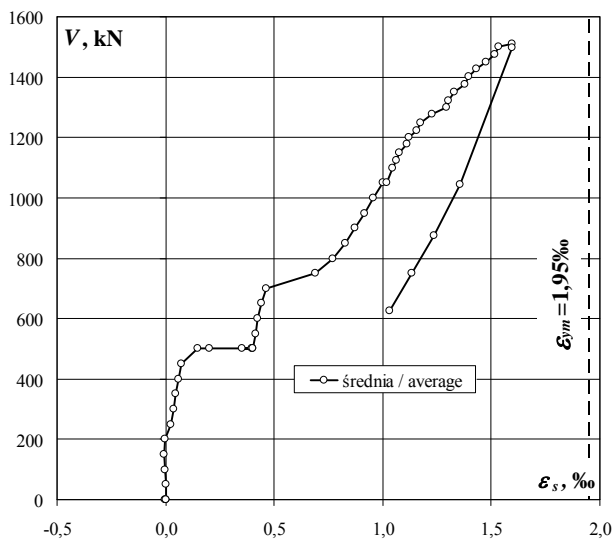
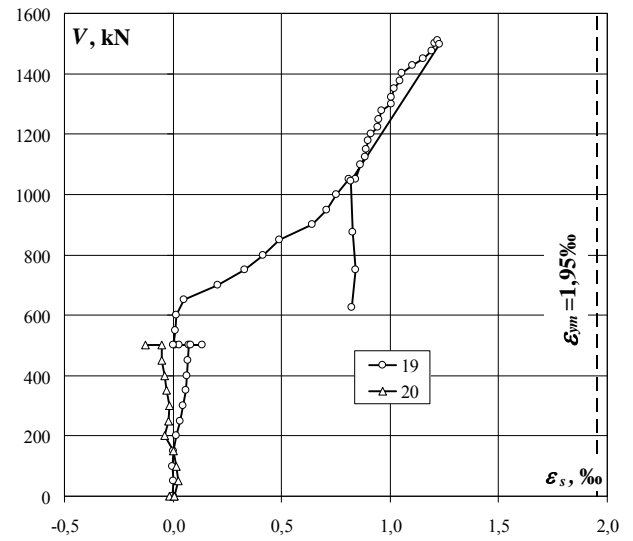
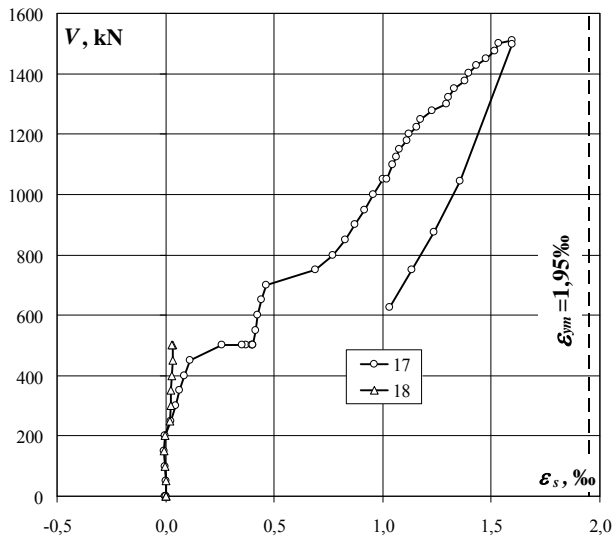
Strzemię 3 – odkształcenia po stronie S i N (ε_s) / Stirrup 3 – strains on S and N side (ε_s)

E-I

Strzemię 4 – odkształcenia po stronie S i N (ε_s) / Stirrup 4 – strains on S and N side (ε_s)

obciążenie wspornika corbel load	odkształcenie S S strain			odkształcenie N N strain		
	21	22	średnia/ average	23	24	średnia/ average
	%	%	%	%	%	%
kN						
0	0,000	0,000	0,000	0,000	0,000	0,000
0	0,006	0,000	0,003	-0,009	-0,003	-0,006
0	0,004	0,003	0,004	0,005	-0,003	0,001
50	-0,010	-0,010	-0,010	0,001	-0,003	-0,001
100	-0,019	-0,023	-0,021	-0,006	-0,018	-0,012
150	-0,042	-0,034	-0,038	-0,026	-0,030	-0,028
200	-0,065	-0,050	-0,058	-0,076	-0,052	-0,064
250	-0,057	-0,061	-0,059	-0,071	-0,058	-0,065
300	-0,048	-0,070	-0,059	-0,064	-0,066	-0,065
350	-0,049	-0,056	-0,053	-0,085	-0,079	-0,082
400	-0,040	-0,050	-0,045	-0,104	-0,084	-0,094
450	-0,026	-0,044	-0,035	-0,103	-0,079	-0,091
500	-0,027	-0,038	-0,033	-0,103	-0,076	-0,090
500	0,031	-0,041	-0,005	-0,133	-0,092	-0,113
500	0,124		0,124	-0,027	-0,063	-0,045
500	0,071		0,071	-0,264	-0,126	-0,195
500	0,095		0,095	-0,030	-0,058	-0,044
500	0,114		0,114	-0,278	-0,139	-0,209
550	0,108		0,108	-0,268	-0,149	-0,209
600	0,109		0,109	-0,261	-0,147	-0,204
650	0,115		0,115	-0,290	-0,168	-0,229
700	0,118		0,118	-0,299	-0,165	-0,232
750	0,167		0,167	-0,344	-0,149	-0,247
800	0,200		0,200	-0,350	-0,142	-0,246
850	0,213		0,213	-0,325	-0,121	-0,223
900	0,245		0,245	-0,256	-0,105	-0,181
950	0,257		0,257	-0,280	-0,136	-0,208
1000	0,271		0,271	-0,281	-0,131	-0,206
1050	0,298		0,298	-0,268	-0,131	-0,200
1050	0,318		0,318	-0,215	-0,080	-0,148
1100	0,325		0,325	-0,187	-0,050	-0,119
1125	0,343		0,343	-0,138	-0,001	-0,070
1150	0,352		0,352	-0,136	0,000	-0,068
1177	0,340		0,340	-0,097	0,059	-0,019
1201	0,340		0,340	-0,083	0,070	-0,007
1224	0,413		0,413	-0,004	0,222	0,109
1250	0,377		0,377	-0,002	0,240	0,119
1276	0,566		0,566	0,014	0,472	0,243
1300	0,690		0,690	0,079	0,600	0,340
1322	0,637		0,637	0,079	0,603	0,341
1351	0,706		0,706	0,080	0,614	0,347
1376	0,723		0,723	0,136	0,717	0,427
1401	0,718		0,718	0,149	0,739	0,444
1427	0,805		0,805	0,224	0,867	0,546
1450	0,874		0,874	0,292	0,990	0,641
1475	0,897		0,897	0,349	1,051	0,700
1499	0,933		0,933	0,366	1,094	0,730
1510	0,956		0,956	0,452	1,338	0,895
1497	0,999		0,999	0,532	1,544	1,038
1045	0,865		0,865		1,283	1,283
875	0,880		0,880		0,931	0,931
750	0,790		0,790		1,032	1,032
627	0,751		0,751		1,040	1,040

Strzemię 4 – odkształcenia po stronie S i N (ϵ_s) / Stirrup 4 – strains on S and N side (ϵ_s)

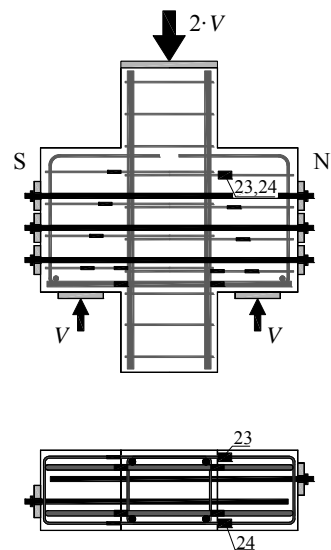
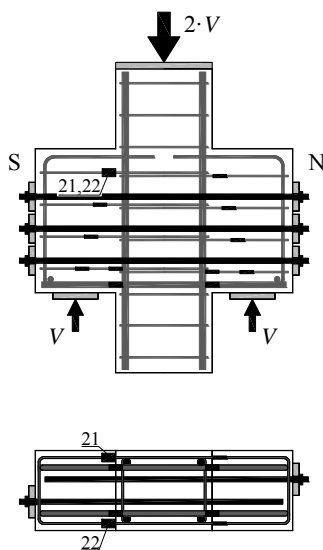
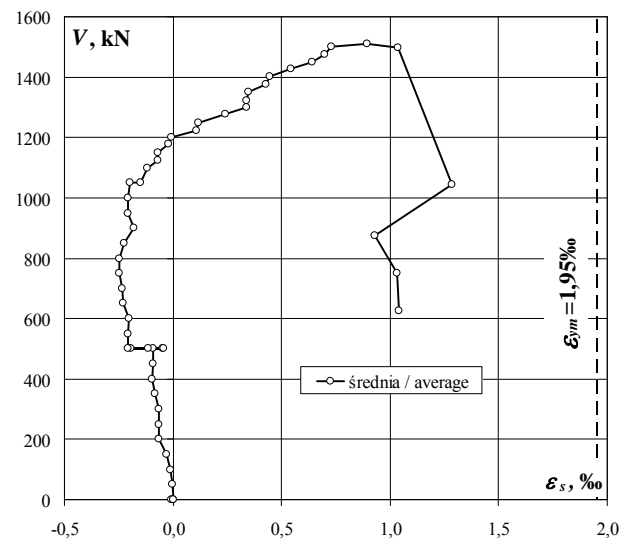
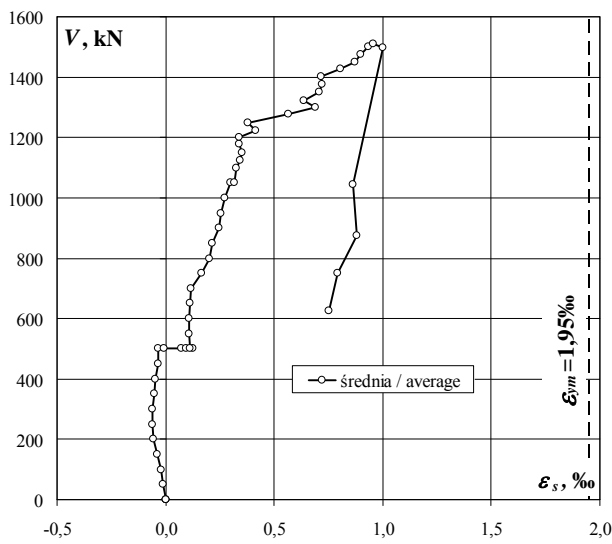
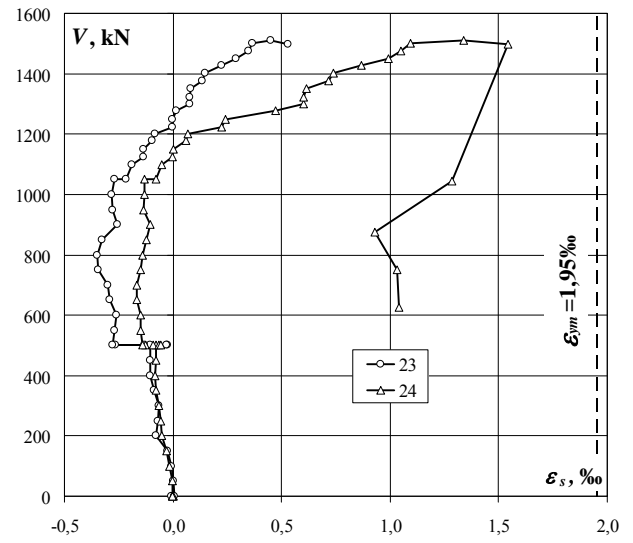
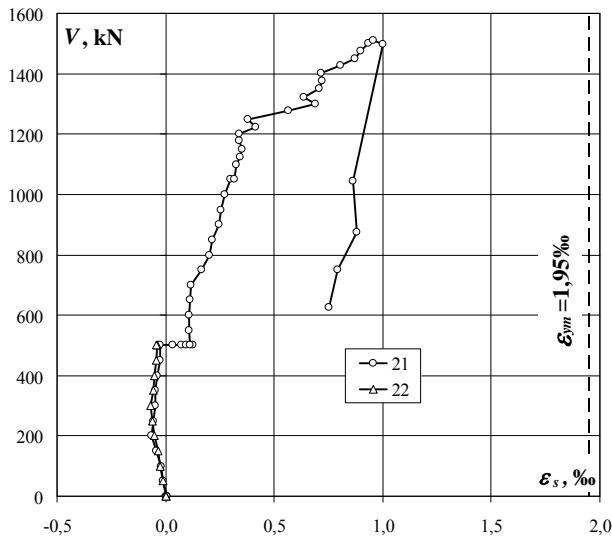

E-I

Odształcenia na pierwszym poziomie / Strains at the 1st level

obciążenie wspornika corbel load	przesunięcia wg ekstensometrów displacement acc to extensometers			obciążenie wspornika corbel load	przesunięcia wg systemu Aramis displacement acc to Aramis System		
	1	2	3		1'	2'	3'
kN	%	%	%	kN	%	%	%
0	0,000	0,000	0,000	0	0,00	0,00	0,00
0	0,010	-0,055	0,010	50	-0,12	0,04	0,07
0	0,000	0,015	0,015	100	-0,18	0,16	-0,01
50	0,020	0,000	0,025	150	-0,12	0,13	0,05
100	0,045	0,005	0,050	200	0,10	0,11	0,29
150	0,105	0,065	0,080	250	0,23	-0,05	0,33
200	0,210	0,000	0,155	300	0,40	0,17	0,52
250	0,525	0,000	0,310	350	0,52	0,25	0,76
300	0,660	-0,005	0,510	400	0,83	0,16	0,99
350	0,800	0,010	0,670	450	0,87	0,26	0,93
400	0,935	-0,010	0,870	500	1,00	0,30	1,42
450	1,070	0,000	1,100	550	0,99	0,34	1,43
500	1,200	-0,015	1,170	600	1,23	0,30	1,44
500	1,440	-0,010	1,285	650	1,41	0,43	1,63
500	1,595	0,040	1,350	700	1,42	0,18	2,01
500	1,605	0,120	1,545	750	1,56	0,31	2,04
500	1,650	0,035	1,520	800	1,87	0,36	2,23
500	1,650	0,030	1,510	850	1,94	0,33	2,30
550	1,660	0,030	1,550	900	1,79	0,47	2,38
600	1,700	0,030	1,605	950	2,15	0,70	2,52
650	1,840	0,030	1,640	1000	1,98	0,59	2,61
700	1,970	0,030	1,715	1050	2,27	0,65	2,58
750	2,080	0,030	1,930	1100	2,52	0,61	2,92
800	2,190	0,065	2,120	1150	2,69	0,66	3,17
850	2,295	0,030	2,235	1200	2,61	0,70	3,19
900	2,470	0,055	2,375	1250	2,87	0,94	3,36
950	2,610	0,030	2,470	1300	3,03	0,89	3,41
1000	2,750	0,030	2,575	1350	3,11	0,93	3,64
1050	2,885	0,030	2,690	1400	3,64	0,89	3,97
1050	2,945	0,030	2,735	1450	3,68	0,84	4,09
1100	3,010	0,045	2,810	1500	4,64	1,04	4,33
1125	3,100	0,025	2,900				
1150	3,115	0,030	2,930				
1177	3,250	0,035	3,035				
1201	3,280	0,030	3,060				
1224	3,390	0,020	3,170				
1250	3,415	0,025	3,195				
1276	3,585	0,020	3,400				
1300	3,740	0,025	3,575				
1322	3,755	0,020	3,595				
1351	3,790	0,020	3,635				
1376	3,925	0,020	3,780				
1401	3,955	0,015	3,805				
1427	4,135	0,020	4,010				
1450	4,320	0,015	4,200				
1475	4,455	0,015	4,330				
1499	4,485	0,015	4,370				
1510	4,645	0,005	4,560				
1497	4,740	0,010	4,570				
1045	5,950	-0,010	4,075				
875	6,510	-0,010	3,865				
750	6,510	0,000	3,720				
627	6,510	-0,010	3,550				

Według ekstensometrów / According to extensometers

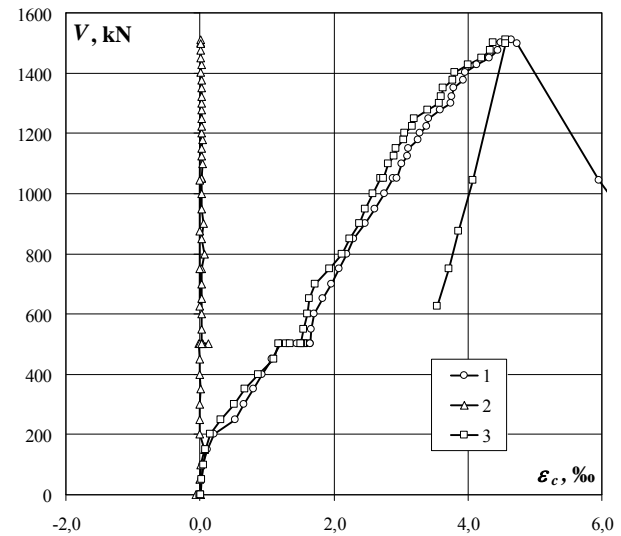

Według systemu Aramis / According to Aramis System

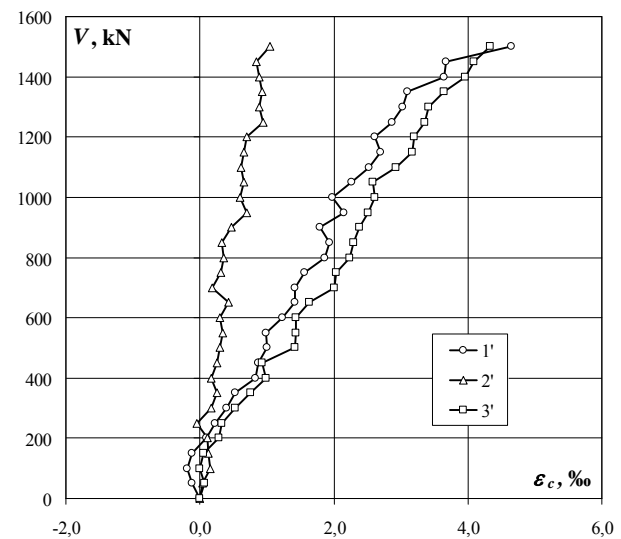

Ekstensometry
Extensometers

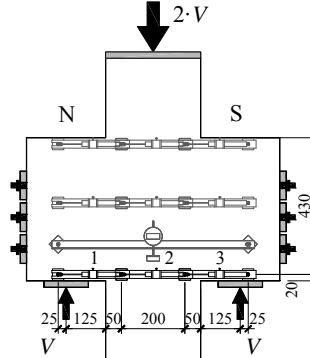

System Aramis
Aramis System

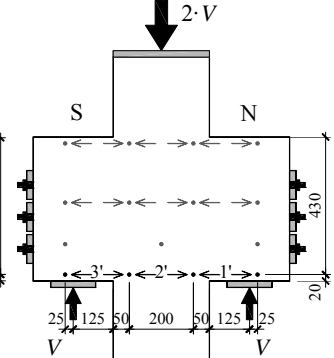

Odształcenia na drugim poziomie / Strains at the 2nd level

obciążenie wspornika corbel load	przesunięcia wg ekstensometrów displacement acc to extensometers			obciążenie wspornika corbel load	przesunięcia wg systemu Aramis displacement acc to Aramis System		
	4	5	6		4'	5'	6'
kN	‰	‰	‰	kN	‰	‰	‰
0	0,000	0,000	0,000	0	0,00	0,00	0,00
0	0,000	0,000	0,000	50	0,06	-0,39	-0,05
0	0,000	0,000	0,000	100	0,02	-0,17	-0,06
50	0,000	0,000	0,000	150	0,10	-0,13	-0,10
100	0,005	0,000	0,000	200	0,16	-0,18	0,01
150	0,020	0,000	0,000	250	0,08	-0,24	-0,01
200	0,035	0,020	0,000	300	-0,11	0,02	0,20
250	0,040	0,165	0,045	350	-0,14	0,08	0,05
300	0,045	0,240	0,000	400	0,06	0,37	0,10
350	0,050	0,315	0,005	450	0,02	0,35	0,07
400	0,060	0,355	0,015	500	0,11	0,44	0,31
450	0,040	0,415	0,025	550	0,05	0,36	0,30
500	0,080	0,470	0,035	600	-0,06	0,28	0,27
500	0,175	0,530	0,135	650	0,09	0,41	0,35
500	0,370	0,525	0,170	700	0,41	0,09	0,69
500	0,565	0,495	0,235	750	0,70	0,08	0,90
500	0,730	0,495	0,235	800	0,57	0,35	1,03
500	0,730	0,490	0,235	850	0,38	0,23	0,88
550	0,750	0,490	0,250	900	0,47	-0,04	1,11
600	0,775	0,490	0,235	950	0,68	0,32	1,45
650	0,965	0,460	0,235	1000	0,57	0,07	1,56
700	1,110	0,410	0,240	1050	0,73	0,06	1,38
750	1,240	0,325	0,250	1100	0,94	0,16	1,74
800	1,325	0,275	0,260	1150	1,14	0,17	1,87
850	1,415	0,275	0,265	1200	1,16	0,00	1,99
900	1,490	0,165	0,270	1250	1,70	-0,03	2,03
950	1,505	0,125	0,305	1300	1,74	-0,10	2,16
1000	1,560	0,095	0,280	1350	2,01	-0,11	2,18
1050	1,600	0,055	0,290	1400	2,39	0,05	2,32
1050	1,625	0,075	0,305	1450	2,38	-0,33	2,48
1100	1,635	0,015	0,295	1500	3,03	-0,45	2,77
1125	1,665	-0,020	0,300				
1150	1,665	-0,025	0,305				
1177	1,775	-0,070	0,320				
1201	1,795	-0,080	0,325				
1224	1,905	-0,120	0,330				
1250	1,930	-0,130	0,335				
1276	2,075	-0,195	0,355				
1300	2,240	-0,255	0,370				
1322	2,255	-0,260	0,370				
1351	2,285	-0,265	0,370				
1376	2,430	-0,315	0,385				
1401	2,445	-0,320	0,390				
1427	2,665	-0,395	0,420				
1450	2,890	-0,460	0,435				
1475	3,040	-0,500	0,455				
1499	3,070	-0,510	0,455				
1510	3,570	-0,635	0,485				
1497	3,800	-0,700	0,500				
1045	5,885	-0,340	0,540				
875	6,585	0,615	0,495				
750	6,550	0,650	0,465				
627	6,505	0,670	0,435				

Według ekstensometrów / According to extensometers

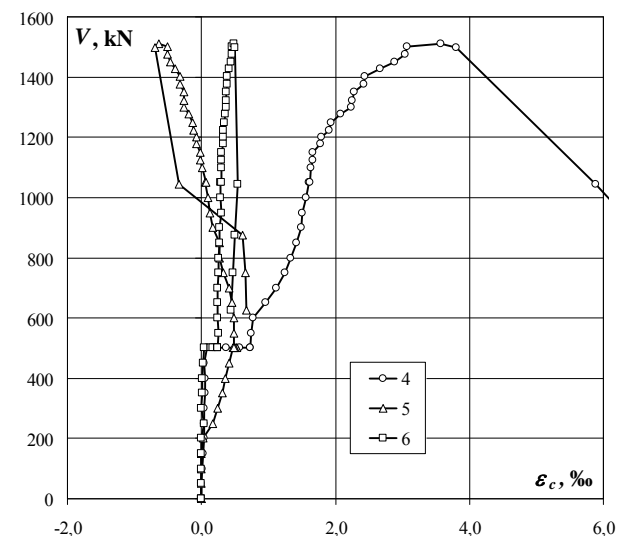

Według systemu Aramis / According to Aramis System

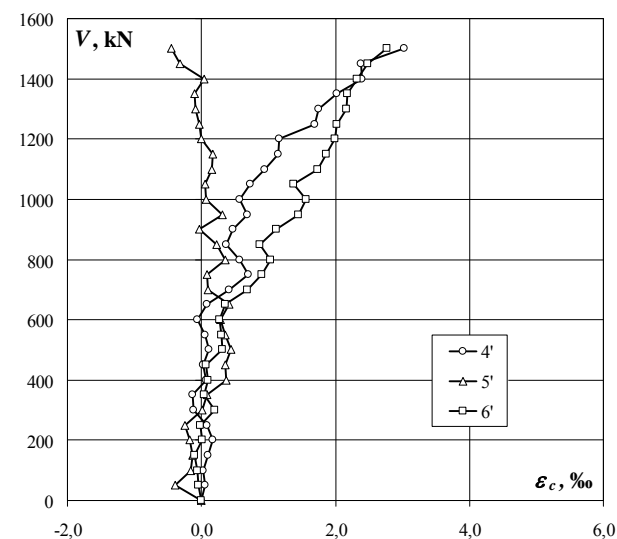
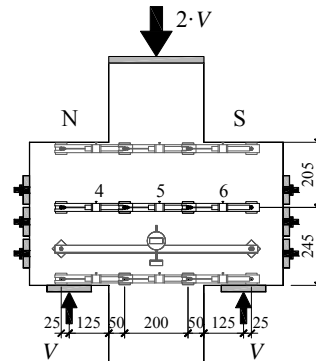
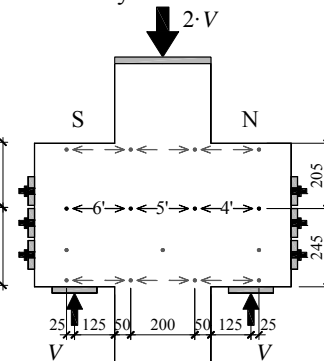
ekstensometry
Extensometerssystem Aramis
Aramis System

E-I

Odształcenia na trzecim poziomie / Strains at the 3rd level

obciążenie wspornika corbel load	przesunięcia wg ekstensometrów displacement acc to extensometers			obciążenie wspornika corbel load	przesunięcia wg systemu Aramis displacement acc to Aramis System		
	7	8	9		7'	8'	9'
kN	‰	‰	‰	kN	‰	‰	‰
0	0,000	0,000	0,000	0	0,00	0,00	0,00
0	0,000	0,000	0,000	50	-0,53	-0,33	0,13
0	0,000	0,000	-0,015	100	-0,29	-0,47	0,11
50	0,000	-0,015	0,000	150	-0,51	-0,46	-0,10
100	-0,005	-0,035	-0,010	200	-0,61	-0,19	-0,19
150	0,000	-0,050	-0,025	250	-0,66	-0,28	-0,25
200	0,000	-0,060	-0,045	300	-0,68	-0,25	0,03
250	-0,005	-0,100	-0,065	350	-0,49	-0,51	0,23
300	0,010	-0,125	-0,085	400	-0,57	-0,51	0,25
350	0,015	-0,135	-0,095	450	-0,68	-0,45	0,16
400	0,015	-0,155	-0,095	500	-0,64	-0,47	0,21
450	0,020	-0,170	-0,100	550	-0,56	-0,48	0,05
500	0,025	-0,185	-0,120	600	-0,63	-0,58	-0,03
500	0,145	-0,165	-0,075	650	-0,61	-0,38	0,02
500	0,245	-0,160	-0,155	700	-0,75	-0,47	0,07
500	0,255	-0,160	-0,145	750	-0,59	-0,50	0,05
500	0,265	-0,155	-0,135	800	-0,56	-0,30	0,20
500	0,265	-0,150	-0,135	850	-0,63	-0,50	0,05
550	0,285	-0,170	-0,155	900	-0,69	-0,73	0,06
600	0,220	-0,170	-0,145	950	-0,81	-0,28	0,06
650	0,265	-0,185	-0,150	1000	-0,69	-0,36	0,04
700	0,260	-0,200	-0,160	1050	-0,76	-0,54	0,13
750	0,270	-0,255	-0,175	1100	-0,40	-0,45	0,39
800	0,270	-0,260	-0,180	1150	-0,45	-0,72	0,23
850	0,270	-0,285	-0,180	1200	-0,48	-0,55	0,24
900	0,280	-0,305	-0,180	1250	-0,35	-0,61	0,17
950	0,265	-0,350	-0,180	1300	-0,39	-0,66	0,30
1000	0,280	-0,395	-0,210	1350	-0,50	-0,81	0,42
1050	0,295	-0,440	-0,180	1400	-0,07	-0,73	0,42
1050	0,295	-0,455	-0,180	1450	-0,36	-0,75	0,36
1100	0,310	-0,480	-0,185	1500	-0,29	-0,72	0,74
1125	0,300	-0,505	-0,180				
1150	0,305	-0,515	-0,185				
1177	0,300	-0,540	-0,180				
1201	0,300	-0,550	-0,175				
1224	0,305	-0,575	-0,180				
1250	0,310	-0,595	-0,175				
1276	0,315	-0,630	-0,125				
1300	0,325	-0,695	-0,045				
1322	0,330	-0,705	-0,045				
1351	0,340	-0,710	-0,035				
1376	0,340	-0,785	0,020				
1401	0,355	-0,800	0,020				
1427	0,370	-0,885	0,090				
1450	0,400	-0,965	0,160				
1475	0,420	-1,040	0,200				
1499	0,415	-1,045	0,205				
1510	0,530	-1,300	0,280				
1497	0,665	-1,620	0,275				
1045	3,170	-3,570	0,160				
875	3,920	-3,555	0,040				
750	3,930	-3,535	0,050				
627	3,930	-3,520	0,075				

Według ekstensometrów / According to extensometers

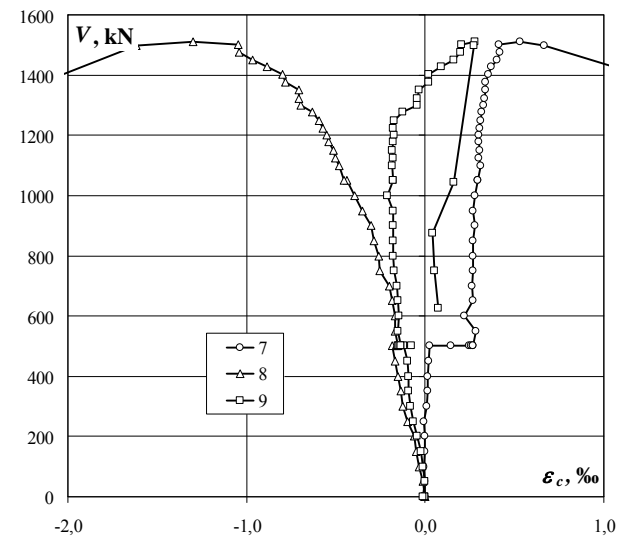

Według systemu Aramis / According to Aramis System

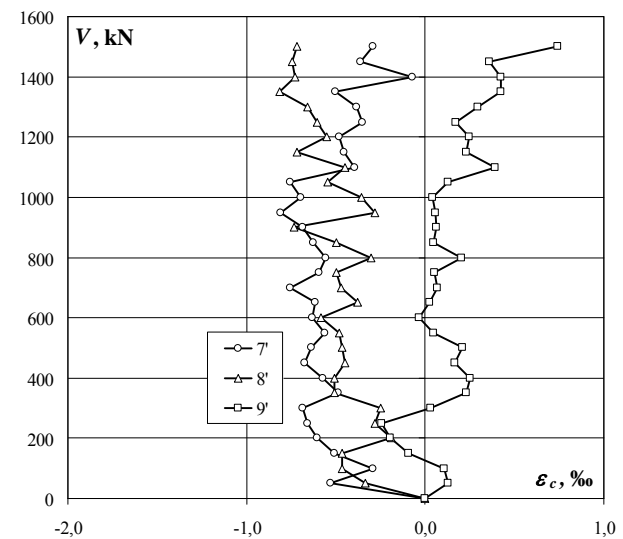

Ekstensometry
Extensometers

System Aramis
Aramis System

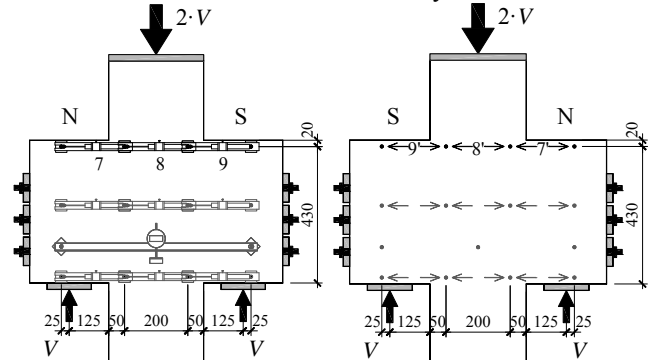

Przesunięcie słupa względem wsporników / The relative displacement between the column and the corbels

obciążenie wspornika corbel load	Przesunięcie wg czujnika Displacement acc to gauges	obciążenie wspornika corbel load	Przesunięcie wg systemu Aramis Displacement acc. to Aramis System
kN	mm	kN	mm
0	0,00	0	0,00
50	0,00	50	-0,01
100	0,01	100	0,02
150	0,02	150	0,03
200	0,04	200	0,05
250	0,09	250	0,09
300	0,11	300	0,13
350	0,14	350	0,17
400	0,18	400	0,20
450	0,20	450	0,24
500	0,24	500	0,31
wzmocnienie / strenghtening		550	0,32
500	0,24	600	0,35
550	0,23	650	0,38
600	0,25	700	0,44
650	0,26	750	0,47
700	0,28	800	0,50
750	0,33	850	0,55
800	0,36	900	0,58
850	0,38	950	0,61
900	0,43	1000	0,65
950	0,46	1050	0,67
1000	0,50	1100	0,74
1000	0,52	1150	0,78
1050	0,54	1200	0,83
1100	0,58	1250	0,87
1150	0,62	1300	0,93
1200	0,66	1350	0,99
1250	0,71	1400	1,05
1300	0,77	1450	1,13
1300	0,81	1500	1,27
1350	0,84		
1350	0,87		
1400	0,90		
1450	0,98		
1450	1,08		
1500	1,17		

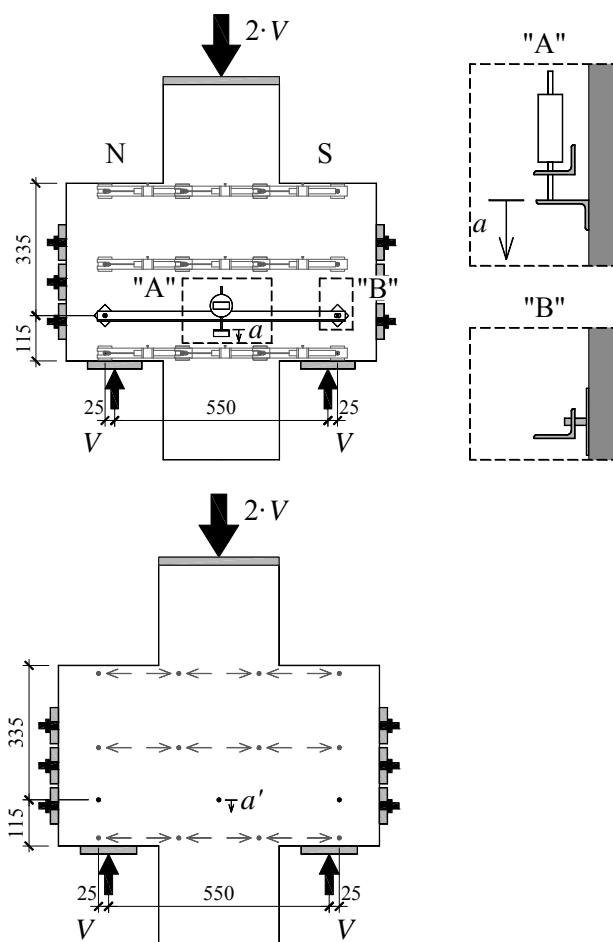
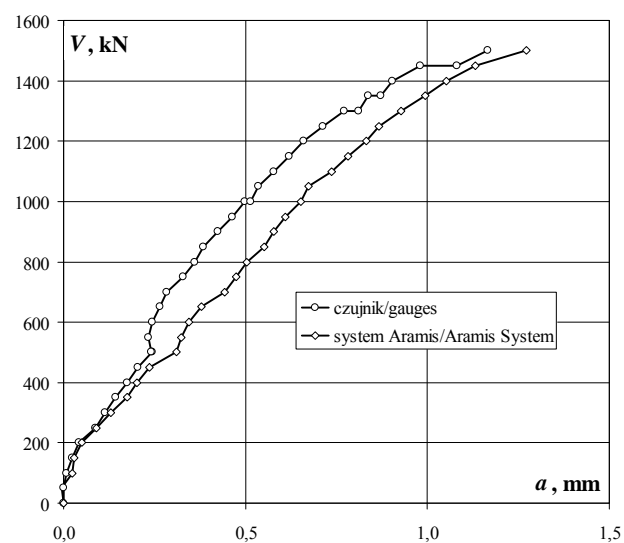

E-I

Szerokość rozwarcia rys / Crack width

obciążenie wspornika corbel load	Numer rysy / Crack number							
	1	2	3	4	5	6	7	8
	mm	mm	mm	mm	mm	mm	mm	mm
300								
350	0,15							
400	0,17							
450	0,20	0,17						
500	0,20	0,20						
	0,20	0,20						
500	0,20	0,20						
550	0,20	0,20						
600	0,20	0,22						
650	0,22	0,25						
	0,20	0,25						
700	0,20	0,25						
750	0,20	0,30						
800	0,25	0,30						
850	0,25	0,30						
900	0,27	0,30	0,15	0,10				
	0,25	0,32	0,20	0,12				
950	0,25	0,32	0,25	0,15	0,15			
1000	0,25	0,32	0,25	0,15	0,15			
1050	0,25	0,37	0,30	0,15	0,15			
1100	0,30	0,37	0,35	0,15	0,15	0,30		
1150	0,35	0,40	0,40	0,15	0,20	0,35		
	0,35	0,45	0,40	0,15	0,20	0,37		
1200	0,35	0,45	0,40	0,15	0,20	0,37		
1250	0,35	0,47	0,40	0,15	0,20	0,40		
1300	0,41	0,50	0,45	0,27	0,45	0,38		
1400	0,47	0,60	0,39		0,70			
1450	0,53		0,33		0,95			

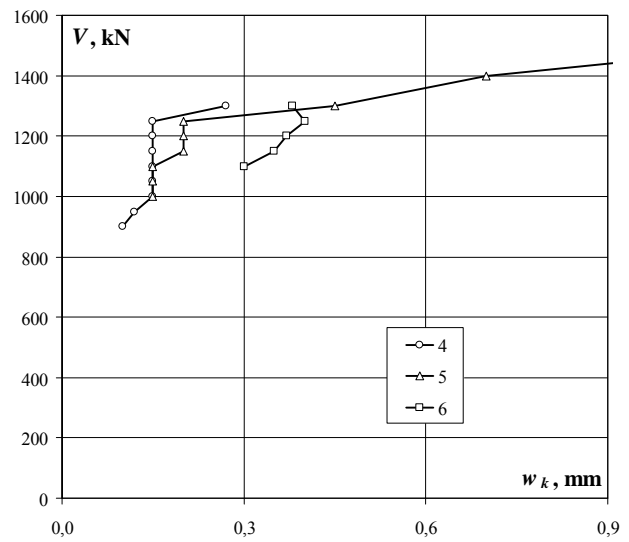
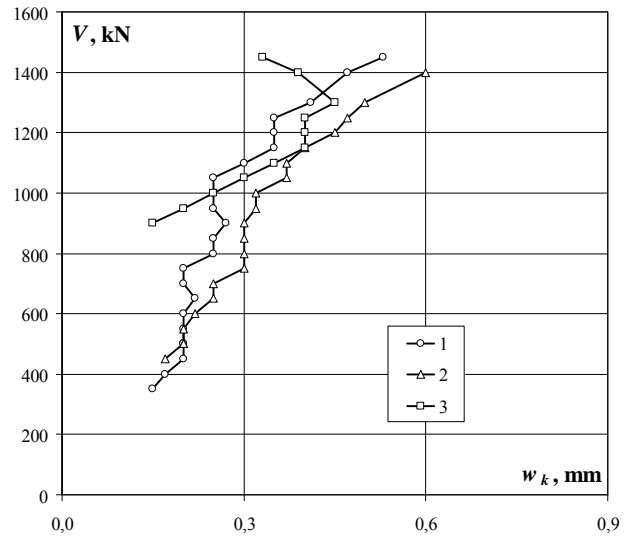

Układ rys przy sile 450kN / Crack pattern at 450kN

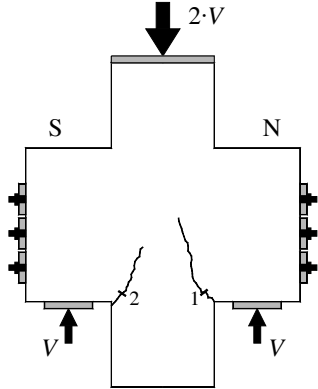

Układ rys przy sile 600kN / Crack pattern at 600kN

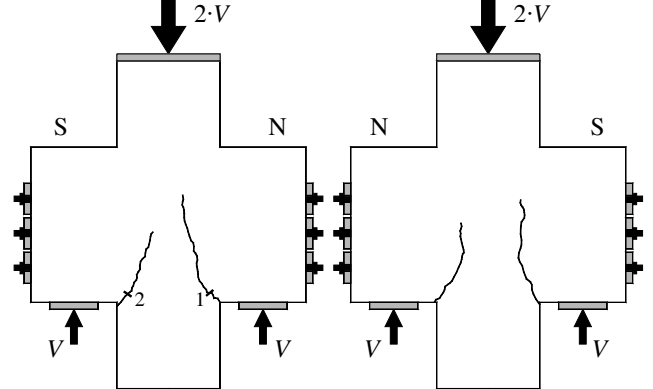

Układ rys przy sile 700kN / Crack pattern at 700kN

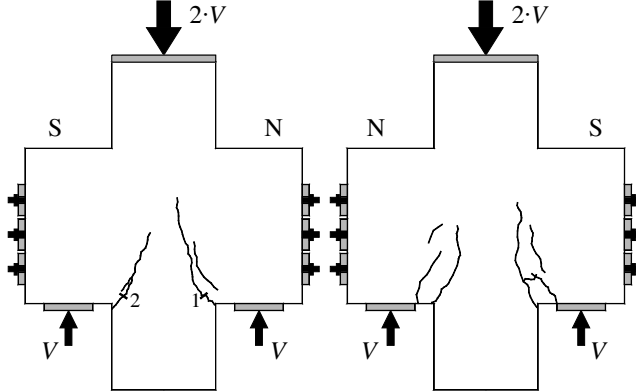

Układ rys przy sile 850kN / Crack pattern at 850kN

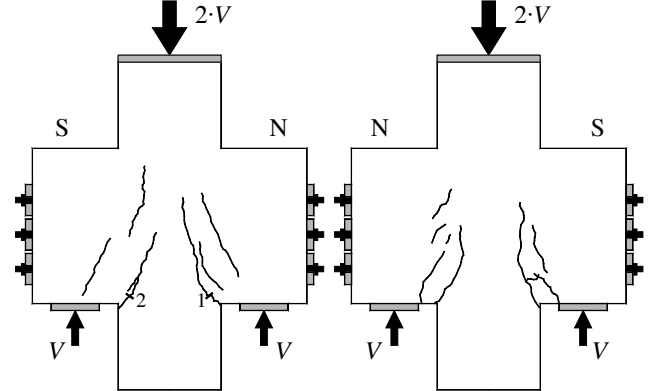

Układ rys przy sile 950kN / Crack pattern at 950kN

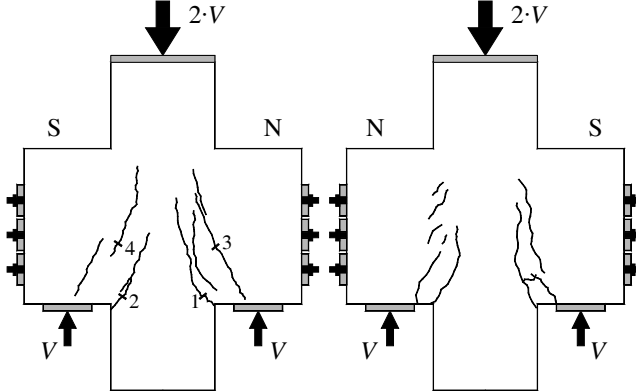

Układ rys przy sile 1100kN / Crack pattern at 1100kN

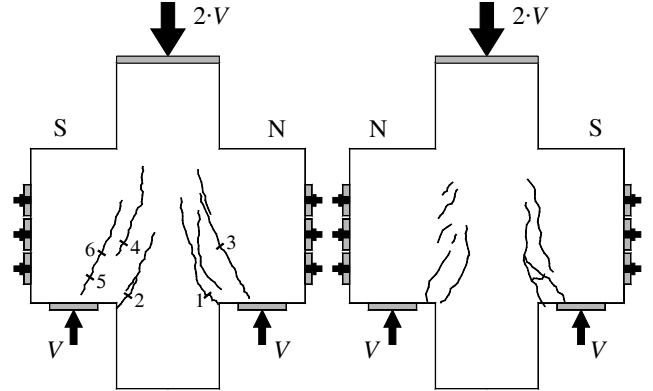

Układ rys przy sile 1450kN / Crack pattern at 1450kN

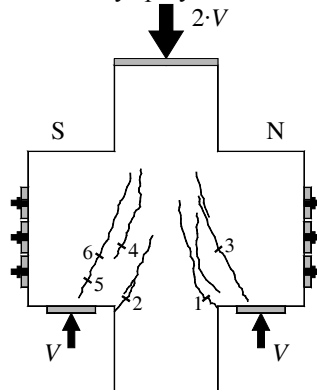

Układ rys przy sile 1510kN / Crack pattern at 1510kN

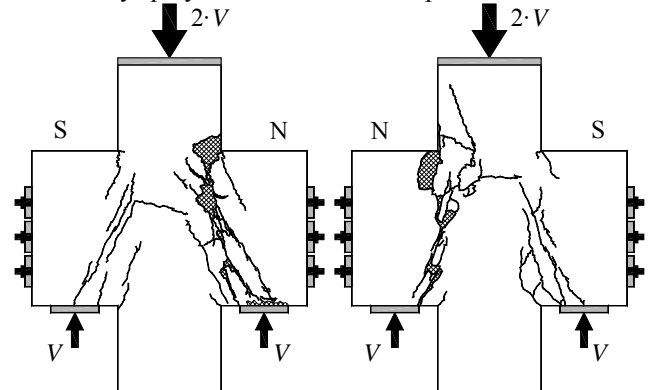

E-I

Szerokość rozwarcia rys według systemu Aramis / Crack width according to Aramis System

obciążenie wspornika corbel load	Numer rysy / Crack number							
	1	2	3	4	5	6	7	8
	mm	mm	mm	mm	mm	mm	mm	mm
0	0,00	0,00	0,00	0,00	0,00	0,00		
50	-0,04	0,03	-0,04	0,01	0,00	0,00		
100	-0,03	0,02	-0,03	0,03	-0,01	0,01		
150	-0,02	0,02	-0,04	0,03	0,01	0,01		
200	0,03	0,05	-0,05	0,03	0,01	0,01		
250	0,10	0,08	-0,05	0,01	-0,01	0,01		
300	0,15	0,12	-0,02	0,02	0,00	0,01		
350	0,16	0,16	0,01	0,04	0,01	0,02		
400	0,18	0,19	0,01	0,04	0,02	0,02		
450	0,19	0,23	0,03	0,04	0,00	0,02		
500	0,24	0,28	0,03	0,05	0,00	0,04		
550	0,24	0,27	0,02	0,04	0,01	0,04		
600	0,25	0,28	0,01	0,04	0,01	0,04		
650	0,27	0,30	0,03	0,07	-0,01	0,02		
700	0,24	0,32	0,12	0,19	0,11	0,14		
750	0,24	0,35	0,18	0,23	0,14	0,18		
800	0,26	0,36	0,20	0,24	0,17	0,21		
850	0,28	0,37	0,19	0,28	0,17	0,25		
900	0,30	0,37	0,23	0,27	0,19	0,27		
950	0,30	0,40	0,30	0,31	0,22	0,29		
1000	0,29	0,41	0,32	0,34	0,24	0,32		
1050	0,28	0,42	0,34	0,38	0,21	0,34		
1100	0,28	0,42	0,40	0,46	0,29	0,40		
1150	0,29	0,44	0,44	0,44	0,31	0,42		
1200	0,31	0,49	0,49	0,45	0,33	0,46		
1250	0,29	0,50	0,48	0,49	0,37	0,50		
1300	0,27	0,50	0,49	0,52	0,40	0,53		
1350	0,26	0,48	0,51	0,53	0,39	0,56		
1400	0,26	0,52	0,52	0,51	0,43	0,60		
1450	0,27	0,55	0,53	0,50	0,46	0,67		
1500	0,28	0,53	0,59	0,53	0,42	0,72		

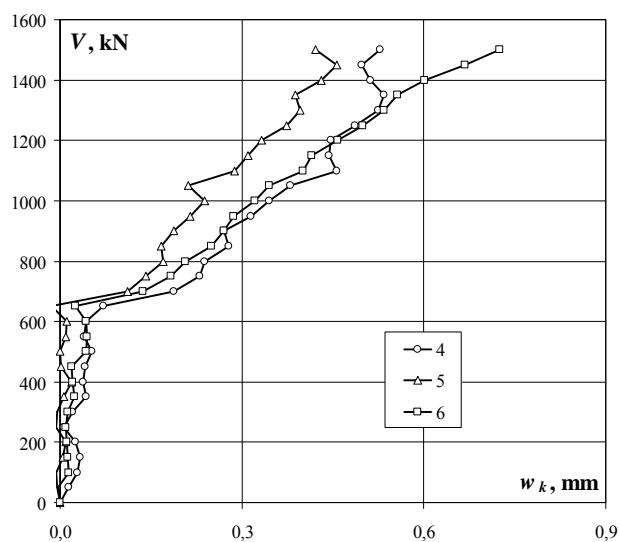
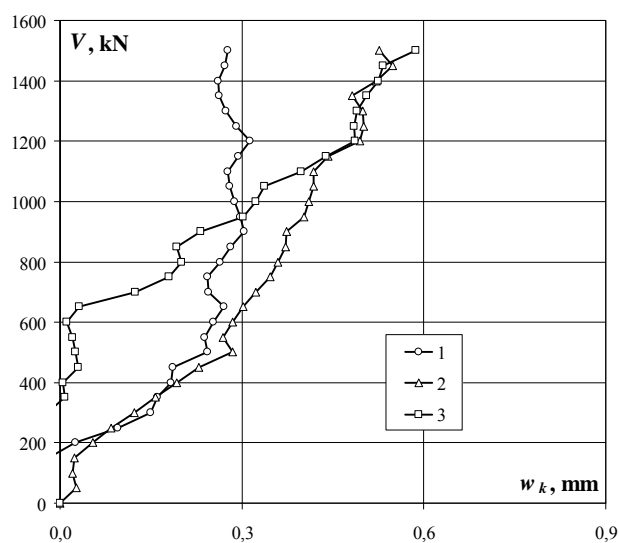

Układ rys przy sile 700kN / Crack pattern at 700kN

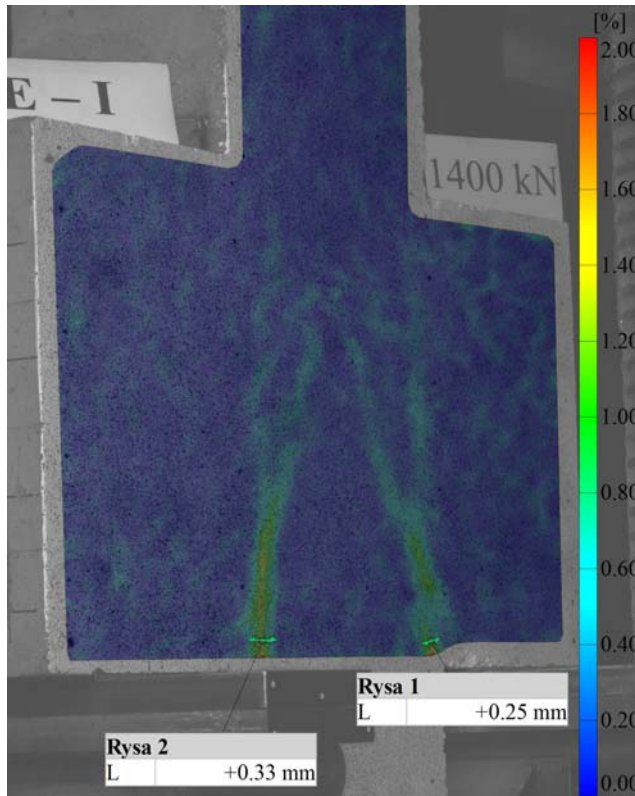

Układ rys przy sile 1100kN / Crack pattern at 1100kN

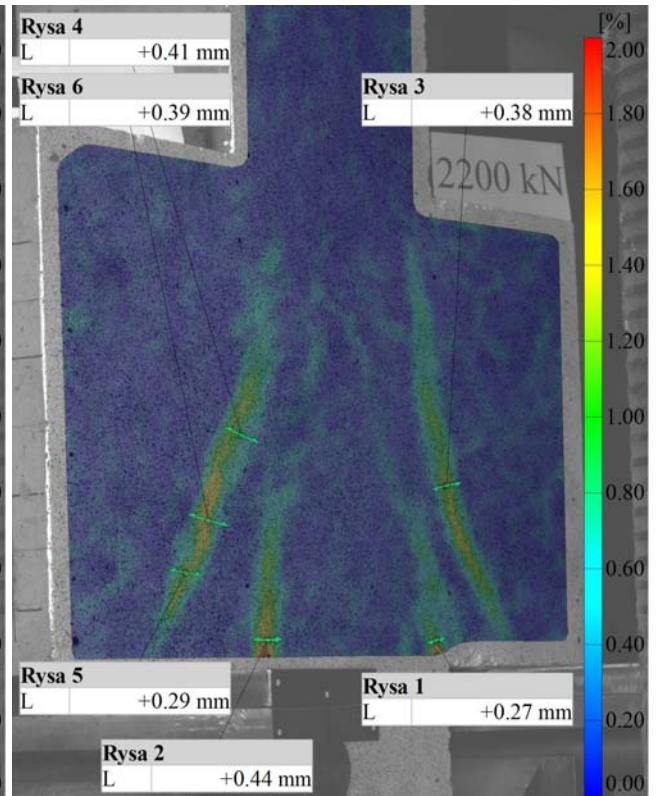

Układ rys przy sile 1500kN / Crack pattern at 1500kN

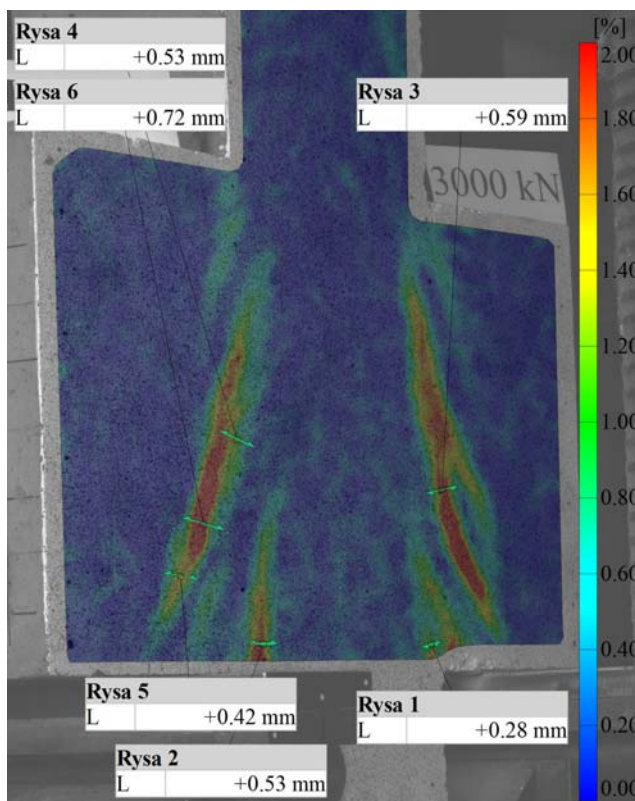

Układ rys przy sile 1510kN / Crack pattern at 1510kN

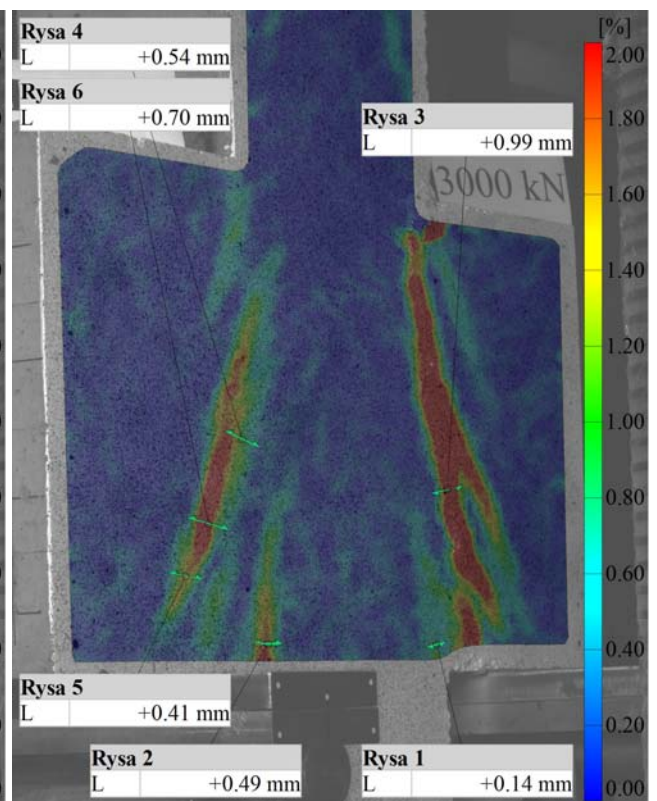

E-I



Wiercenie otworu
Drilling the hole



Powierzchnia boczna po zniszczeniu
Side surface after failure

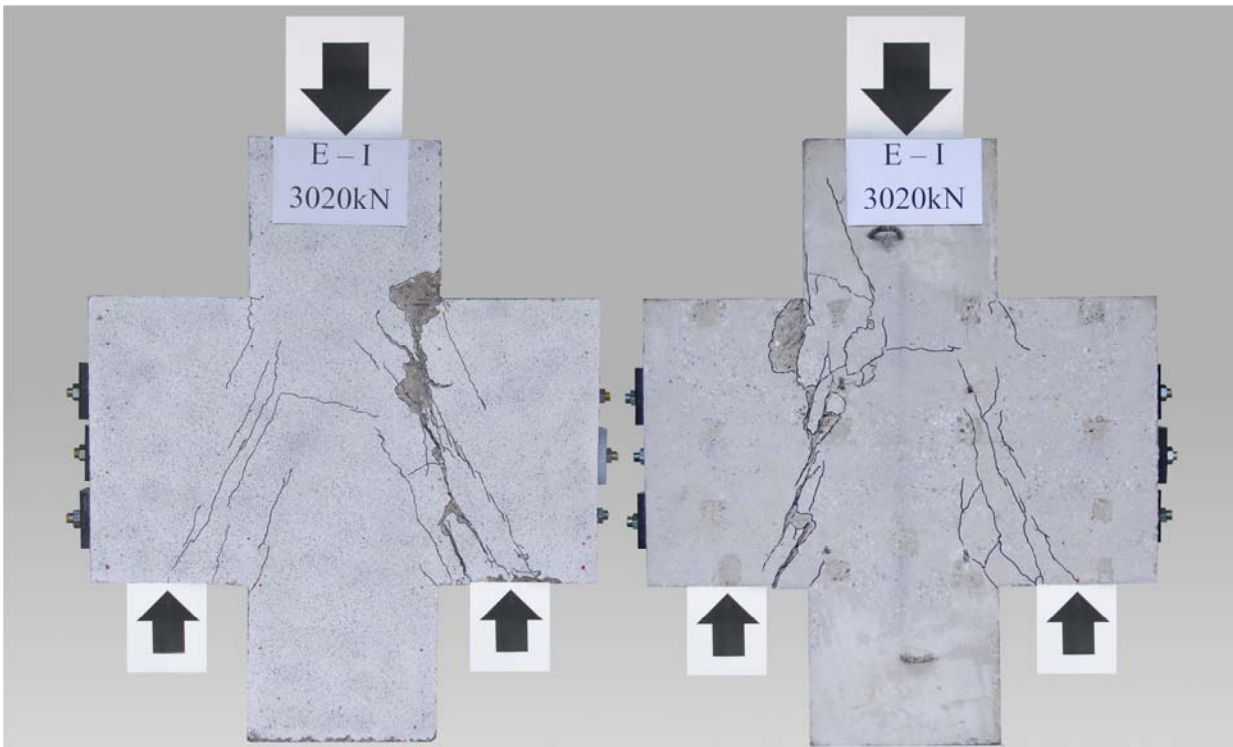

Wspornik po zniszczeniu / Corbel after failure

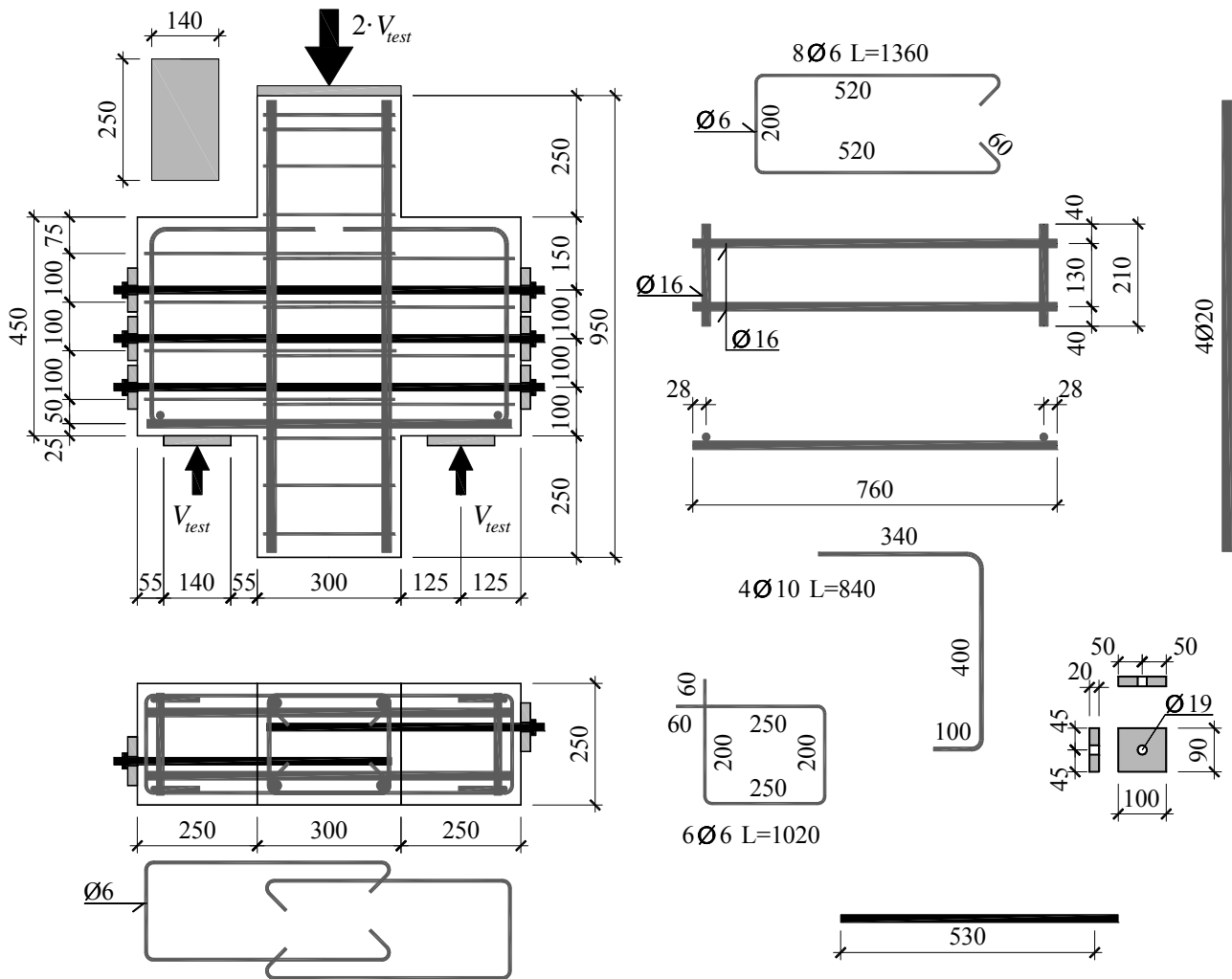

Zbrojenie modelu / Specimen's reinforcement

Wytrzymałość betonu na ściskanie / Compressive strength of concrete

$$f_{cm} = 47,3\text{MPa}$$

Moduł sprężystości podłużnej / Young's modulus

$$E_{cm} = 28,2\text{GPa}$$

Wytrzymałość betonu na rozciąganie przy rozłupywaniu / Tensile splitting strength of concrete

$$f_{ct,sp} = 3,9\text{MPa}$$

Gęstość betonu / Density of concrete

$$\rho = 2250\text{kg/m}^3$$

Charakterystyka zbrojenia / Characteristics of the reinforcement

Ø6

$$A_s = 28,07\text{mm}^2, f_{ym} = 385,6\text{MPa}, f_{tm} = 487,6\text{MPa}$$

Ø16

$$A_s = 200,53\text{mm}^2, f_{ym} = 533,6\text{MPa}, f_{tm} = 638,5\text{MPa}$$

Ø20

$$A_s = 310,67\text{mm}^2, f_{ym} = 541,0\text{MPa}, f_{tm} = 640,4\text{MPa}$$

M16

$$A_s = 141,03\text{mm}^2, f_{ym} = 1032,0\text{MPa}, f_{tm} = 1099,0\text{MPa}$$

Siła niszcząca / Failure force

$$V_{rest} = 1353\text{kN}$$

E-II

Beton – odkształcenia po stronie S i N (na wsporniku) (ε_c) / Concrete – strains on S and N side (on the corbel) (ε_c)

obciążenie wspornika corbel load	odkształcenie S S strain				odkształcenie N N strain			
	1	2	3	średnia/ average	4	5	6	średnia/ average
kN	‰	‰	‰	‰	‰	‰	‰	‰
0	0,000	0,000	0,000	0,000	0,000	0,000	0,000	0,000
0	0,002	0,000	-0,009	-0,002	0,000	0,000	0,000	0,000
50	-0,006	-0,005	-0,007	-0,006	-0,005	0,003	-0,002	-0,001
50	-0,004	-0,005	-0,010	-0,006	-0,005	0,002	-0,003	-0,002
0	0,000	0,000	0,002	0,001	-0,001	0,000	0,000	0,000
50	-0,010	-0,007	0,005	-0,004	-0,005	0,003	-0,003	-0,002
100	-0,024	-0,018	0,008	-0,011	-0,014	0,005	-0,009	-0,006
150	-0,047	-0,060	-0,008	-0,038	-0,029	-0,006	-0,040	-0,025
200	-0,088	-0,124	-0,048	-0,087	-0,059	-0,039	-0,099	-0,066
250	-0,117	-0,165	-0,072	-0,118	-0,106	-0,078	-0,167	-0,117
300	-0,142	-0,197	-0,085	-0,141	-0,165	-0,127	-0,255	-0,182
350	-0,161	-0,228	-0,101	-0,163	-0,181	-0,140	-0,307	-0,209
400	-0,195	-0,258	-0,101	-0,185	-0,195	-0,145	-0,338	-0,226
450	-0,223	-0,287	-0,103	-0,204	-0,220	-0,163	-0,382	-0,255
500	-0,248	-0,310	-0,100	-0,219	-0,248	-0,178	-0,417	-0,281
500	-0,253	-0,312	-0,075	-0,213	-0,262	-0,190	-0,442	-0,298
500	-0,272	-0,323	-0,075	-0,223	-0,268	-0,200	-0,476	-0,315
550	-0,296	-0,348	-0,087	-0,244	-0,296	-0,221	-0,515	-0,344
600	-0,344	-0,379	-0,062	-0,262	-0,320	-0,239	-0,549	-0,369
650	-0,135	-0,271	0,085	-0,107	-0,324	-0,239	-0,555	-0,373
700	-0,108	-0,260	0,125	-0,081	-0,329	-0,242	-0,561	-0,377
750	-0,085	-0,255	0,170	-0,057	-0,315	-0,197	-0,475	-0,329
800	-0,067	-0,252	0,204	-0,038	-0,320	-0,172	-0,406	-0,299
850	-0,046	-0,247	0,238	-0,018	-0,296	-0,145	-0,348	-0,263
900	-0,021	-0,239	0,275	0,005	-0,264	-0,128	-0,295	-0,229
950	0,007	-0,227	0,319	0,033	-0,258	-0,112	-0,236	-0,202
1000	0,032	-0,218	0,368	0,061	-0,254	-0,099	-0,183	-0,179
1050	0,067	-0,199	0,424	0,097	-0,245	-0,071	-0,112	-0,143
1100	0,105	-0,180	0,483	0,136	-0,222	-0,028	-0,026	-0,092
1150	0,151	-0,152	0,564	0,188	-0,182	0,036	0,087	-0,020
1176	0,207	-0,106	0,682	0,261	-0,144	0,135	0,191	0,061
1199	0,203	-0,113	0,681	0,257	-0,145	0,132	0,189	0,059
1226	0,249	-0,040	0,848	0,352	-0,109	0,238	0,280	0,136
1250	0,246	-0,049	0,847	0,348	-0,111	0,241	0,280	0,137
1273	0,297	0,021	0,957	0,425	-0,060	0,345	0,326	0,204
1300	0,295	0,016	0,958	0,423	-0,055	0,354	0,328	0,209
1323	0,375	0,090	1,087	0,517	0,024	0,501	0,412	0,312
1349	0,376	0,089	1,082	0,516	0,034	0,504	0,417	0,318
1353	0,397	0,105	1,094	0,532	0,075	0,535	0,437	0,349
1350	0,528	0,218	1,175	0,640	0,020	0,607	0,466	0,364
1334	0,545	0,232	1,165	0,647	-0,057	0,381	0,343	0,222

Beton – odkształcenia po stronie S i N (na wsporniku) (ϵ_c) / Concrete – strains on S and N side (on the corbel) (ϵ_c)

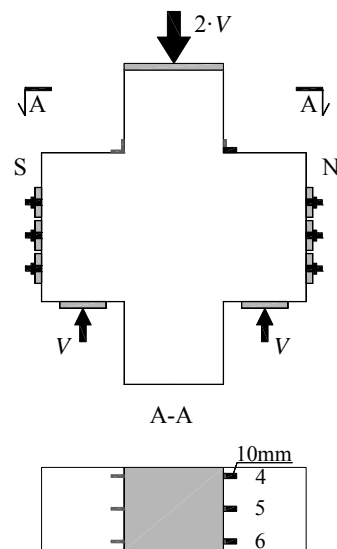
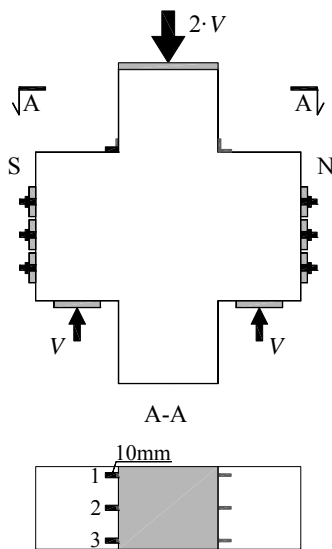
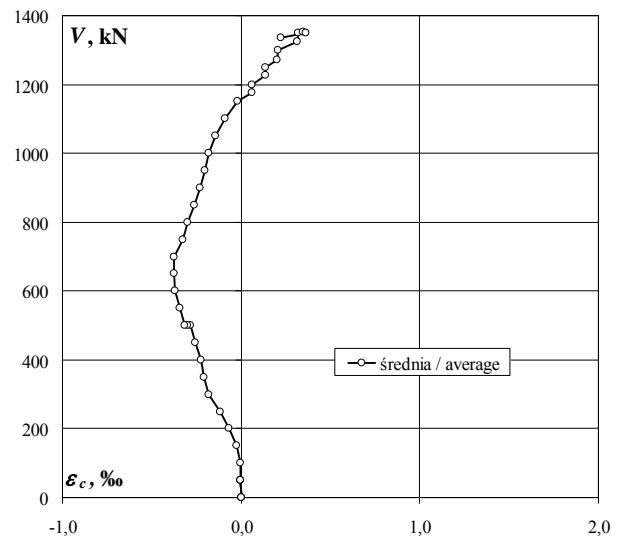
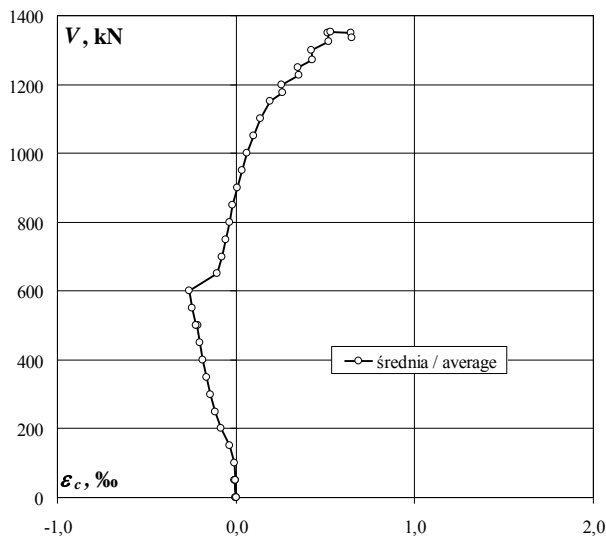
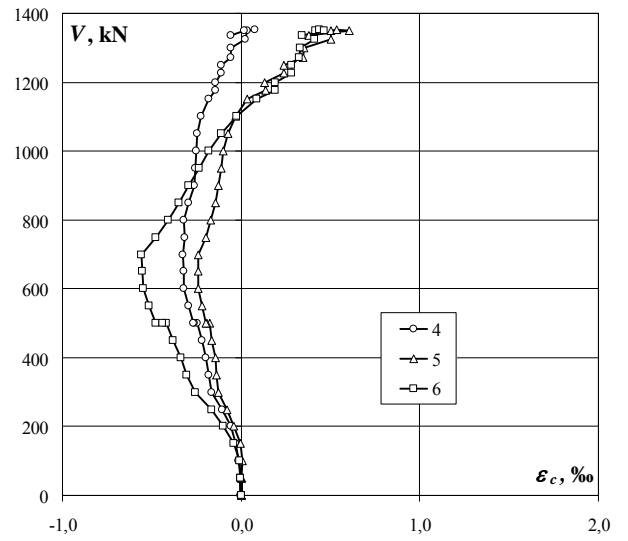
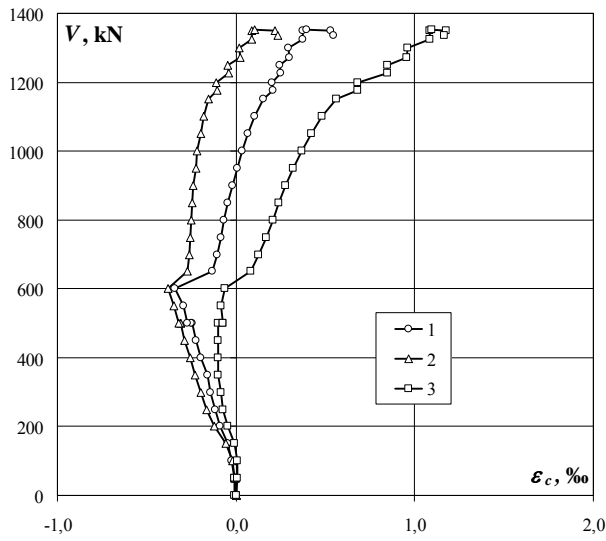

E-II

Beton – odkształcenia po stronie S i N (na słupie) (ε_c) / Concrete – strains on S and N side (on the column) (ε_c)

obciążenie wspornika corbel load	odkształcenie S S strain				odkształcenie N N strain			
	7	8	9	średnia/ average	10	11	12	średnia/ average
kN	‰	‰	‰	‰	‰	‰	‰	‰
0	0,000	0,000	0,000	0,000	0,000	0,000	0,000	0,000
0	0,000	-0,001	-0,002	-0,001	0,000	0,000	0,000	0,000
50	-0,002	-0,021	-0,024	-0,016	0,000	-0,010	-0,009	-0,006
50	-0,002	-0,022	-0,024	-0,016	-0,001	-0,010	-0,009	-0,007
0	0,000	-0,003	-0,004	-0,002	0,000	-0,002	-0,002	-0,001
50	-0,005	-0,021	-0,019	-0,015	-0,002	-0,012	-0,011	-0,008
100	-0,018	-0,057	-0,048	-0,041	0,000	-0,020	-0,017	-0,012
150	-0,067	-0,117	-0,089	-0,091	-0,005	-0,043	-0,023	-0,024
200	-0,150	-0,192	-0,138	-0,160	-0,034	-0,078	-0,041	-0,051
250	-0,248	-0,277	-0,193	-0,239	-0,084	-0,116	-0,055	-0,085
300	-0,347	-0,367	-0,262	-0,325	-0,147	-0,163	-0,074	-0,128
350	-0,454	-0,469	-0,341	-0,421	-0,225	-0,216	-0,097	-0,179
400	-0,546	-0,574	-0,425	-0,515	-0,302	-0,267	-0,121	-0,230
450	-0,635	-0,679	-0,503	-0,606	-0,367	-0,311	-0,139	-0,272
500	-0,721	-0,785	-0,609	-0,705	-0,429	-0,359	-0,163	-0,317
500	-0,818	-0,939	-0,855	-0,871	-0,490	-0,393	-0,200	-0,361
500	-0,840	-0,967	-0,938	-0,915	-0,499	-0,398	-0,217	-0,371
550	-0,909	-1,039	-0,987	-0,978	-0,548	-0,425	-0,233	-0,402
600	-0,976	-1,121	-1,059	-1,052	-0,590	-0,457	-0,245	-0,431
650	-1,287	-1,361	-1,179	-1,276	-0,639	-0,496	-0,267	-0,467
700	-1,407	-1,491	-1,279	-1,392	-0,702	-0,546	-0,290	-0,513
750	-1,551	-1,640	-1,394	-1,528	-0,792	-0,630	-0,332	-0,585
800	-1,698	-1,824	-1,508	-1,677	-0,869	-0,700	-0,369	-0,646
850	-1,860	-1,992	-1,625	-1,826	-0,981	-0,690	-0,410	-0,694
900	-2,017	-2,150	-1,740	-1,969	-1,078	-0,755	-0,449	-0,761
950	-2,206	-2,330	-1,877	-2,138	-1,182	-0,825	-0,490	-0,832
1000	-2,385	-2,499	-1,993	-2,292	-1,281	-0,898	-0,531	-0,903
1050	-2,611	-2,701	-2,124	-2,479	-1,404	-0,973	-0,584	-0,987
1100	-2,834	-2,913	-2,250	-2,666	-1,532	-1,029	-0,657	-1,073
1150	-3,088	-3,134	-2,388	-2,870	-1,691	-1,070	-0,732	-1,164
1176	-3,335	-3,308	-2,520	-3,054	-1,834	-1,096	-0,818	-1,249
1199	-3,375	-3,345	-2,546	-3,089	-1,860	-1,104	-0,827	-1,264
1226	-3,650	-3,510	-2,675	-3,278	-2,008	-1,102	-0,924	-1,345
1250	-3,699	-3,552	-2,703	-3,318	-2,036	-1,110	-0,937	-1,361
1273	-3,916	-3,712	-2,806	-3,478	-2,191	-1,113	-1,040	-1,448
1300	-3,980	-3,772	-2,842	-3,531	-2,229	-1,123	-1,071	-1,474
1323	-4,265	-3,983	-2,983	-3,744	-2,382	-1,137	-1,261	-1,593
1349	-4,323	-4,038	-3,013	-3,791	-2,383	-1,146	-1,299	-1,609
1353	-4,393	-4,101	-3,026	-3,840	-2,382	-1,145	-1,374	-1,634
1350	-4,769	-4,391	-3,162	-4,107	-2,425	-1,104	-1,947	-1,825
1334	-4,751	-4,376	-3,141	-4,089	-2,330	-1,041	-1,796	-1,722

Beton – odkształcenia po stronie S i N (na słupie) (ϵ_c) / Concrete – strains on S and N side (on the column) (ϵ_c)

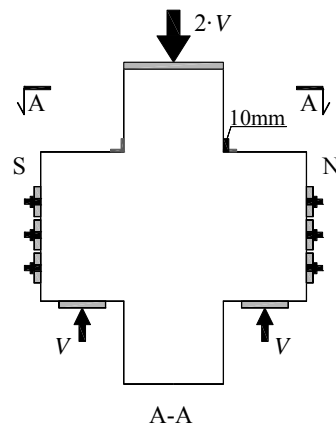
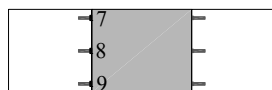
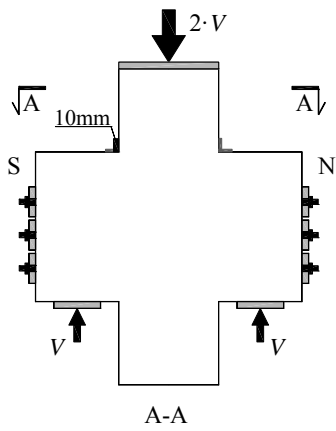
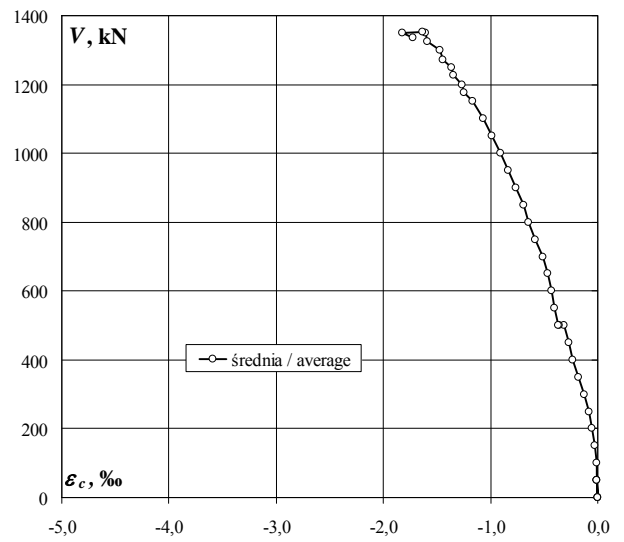
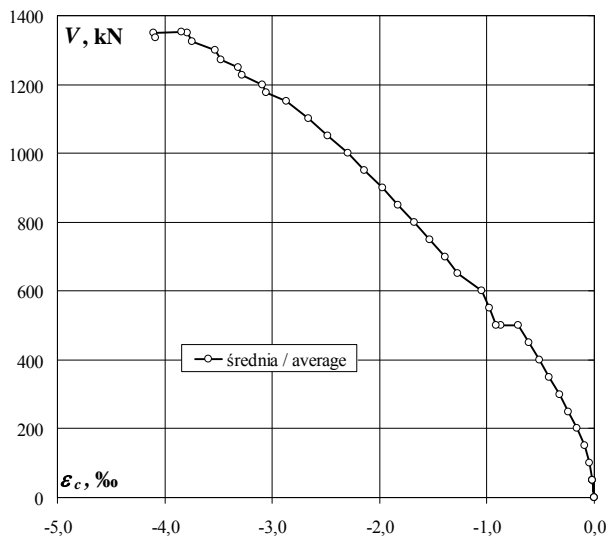
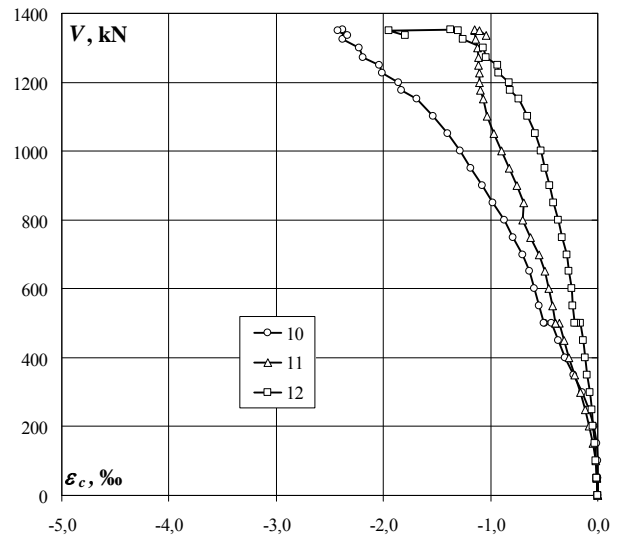
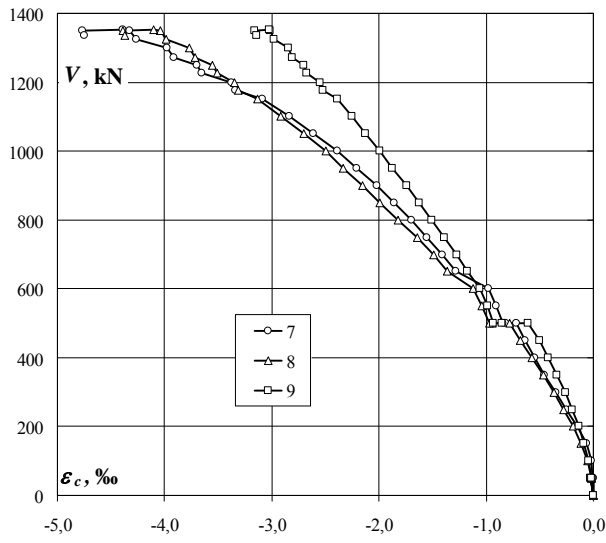

E-II

Zbrojenie główne – odkształcenia po stronie S i N (ε_s) / Main reinforcement – strains on S and N side (ε_s)

obciążenie wspornika corbel load	odkształcenie S S strain			odkształcenie N N strain		
	1	2	średnia/ average	3	4	średnia/ average
	%	%	%	%	%	%
kN						
0	0,000	0,000	0,000	0,000	0,000	0,000
0	0,000	-0,036	-0,018	-0,002	-0,005	-0,004
50	0,017	0,109	0,063	0,018	0,011	0,015
50	0,018	0,117	0,068	0,017	0,007	0,012
0	0,001	-0,048	-0,024	0,000	0,002	0,001
50	0,015	-0,029	-0,007	0,015	0,013	0,014
100	0,075	0,026	0,051	0,057	0,036	0,047
150	0,268	0,146	0,207	0,122	0,085	0,104
200	0,575	0,463	0,519	0,151	0,112	0,132
250	0,824	0,798	0,811	0,264	0,222	0,243
300	0,920	0,909	0,915	0,608	0,557	0,583
350	1,014	1,015	1,015	0,975	0,896	0,936
400	1,146	1,069	1,108	1,182	1,067	1,125
450	1,254	1,144	1,199	1,340	1,218	1,279
500	1,365	1,229	1,297	1,491	1,361	1,426
500	1,450		1,450	1,580	1,460	1,520
500	1,434		1,434	1,555	1,476	1,516
550	1,498		1,498	1,622	1,525	1,574
600	1,584		1,584	1,695	1,587	1,641
650	1,772		1,772	1,738	1,644	1,691
700	1,832		1,832	1,834	1,756	1,795
750	1,893		1,893	1,926	1,880	1,903
800	1,966		1,966	1,971	1,988	1,980
850	2,031		2,031	2,012	2,141	2,077
900	2,101		2,101	2,057	2,254	2,156
950	2,184		2,184	2,131	2,364	2,248
1000	2,263		2,263	2,197	2,459	2,328
1050	2,347		2,347	2,269	2,622	2,446
1100	2,427		2,427	2,331	2,817	2,574
1150	2,485		2,485	2,406	3,257	2,832
1176	2,520		2,520	2,556	3,901	3,229
1199	2,545		2,545	2,584	3,978	3,281
1226	2,573		2,573	2,773	5,059	3,916
1250	2,596		2,596	2,817	5,195	4,006
1273	2,673		2,673	3,083	6,883	4,983
1300	2,697		2,697	3,211	7,225	5,218
1323	2,727		2,727	4,278	8,893	6,586
1349	2,749		2,749	4,511	8,967	6,739
1353	2,763		2,763	5,030	9,419	7,225
1350	2,908		2,908	6,628	9,309	7,969
1334	2,891		2,891	6,547	9,303	7,925

Zbrojenie główne – odkształcenia po stronie S i N (ϵ_s) / Main reinforcement – strains on S and N side (ϵ_s)

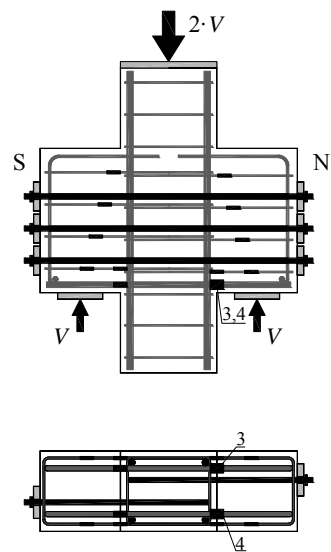
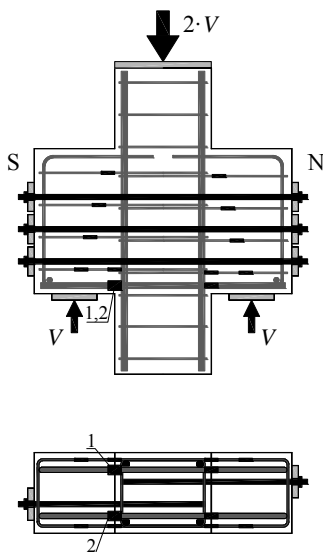
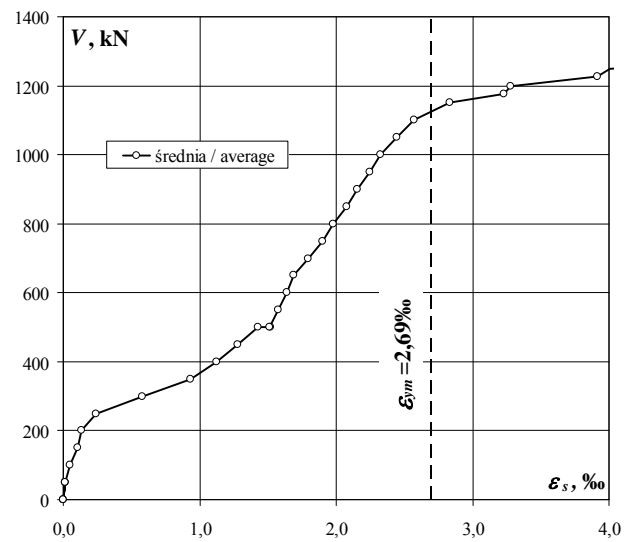
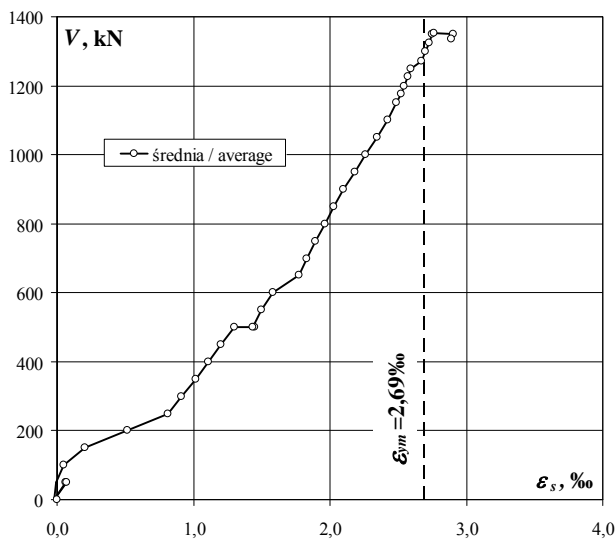
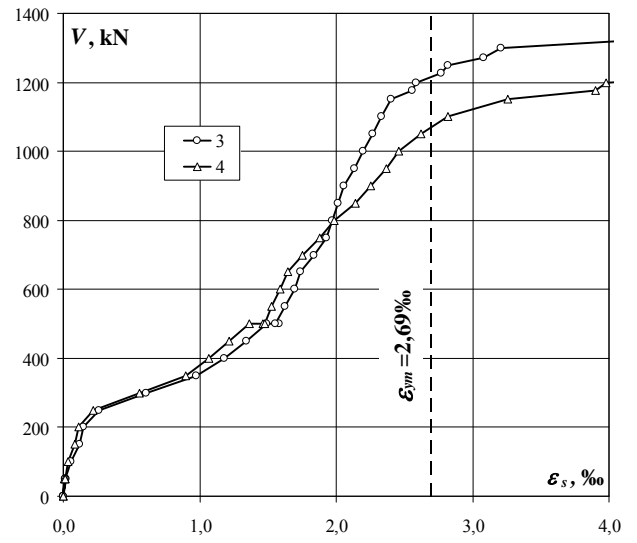
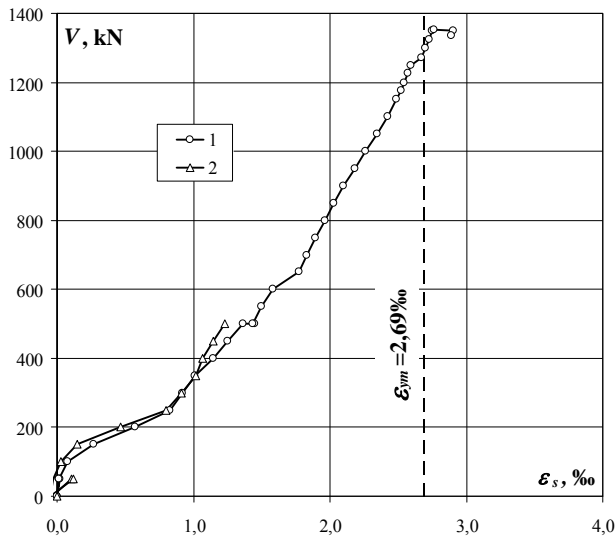

E-II

Strzeżnię 1a – odkształcenia po stronie S i N (ε_s) / Stirrup 1a – strains on S and N side (ε_s)

obciążenie wspornika corbel load	odkształcenie S S strain			odkształcenie N N strain		
	5	6	średnia/ average	7	8	średnia/ average
	kN	‰	‰	‰	‰	‰
0		0,000		0,000	0,000	0,000
0		0,035		0,001	0,005	0,003
50		0,000		0,007	0,016	0,012
50		0,036		0,007	0,013	0,010
0		0,025		0,001	-0,003	-0,001
50		-0,045		0,007	0,000	0,004
100		-0,061		0,032	0,017	0,025
150		0,064		0,068	0,053	0,061
200		0,134		0,085	0,100	0,093
250		0,451		0,199	0,279	0,239
300		0,662		0,513	0,540	0,527
350		0,786		0,611	0,810	0,711
400		1,345		0,733	0,969	0,851
450		1,566		0,767	1,102	0,935
500		1,772		0,811	1,314	1,063
500				0,805	1,421	1,113
500				0,791	1,343	1,067
550				0,831	1,406	1,119
600				0,871	1,469	1,170
650				0,902	1,568	1,235
700				0,979	1,705	1,342
750				1,122	1,744	1,433
800				1,229	1,772	1,501
850				1,317	1,736	1,527
900				1,382	1,716	1,549
950				1,471	1,734	1,603
1000				1,549	1,753	1,651
1050				1,634	1,768	1,701
1100				1,716	1,769	1,743
1150				1,799	1,721	1,760
1176				1,874	1,713	1,794
1199				1,890	1,721	1,806
1226				1,963	1,754	1,859
1250				1,983	1,763	1,873
1273				1,993	1,699	1,846
1300				2,032	1,693	1,863
1323				2,170	1,688	1,929
1349				2,199	1,690	1,945
1353				2,265	1,668	1,967
1350				3,862	1,553	2,708
1334				5,112	1,528	3,320

Strzemię 1a – odkształcenia po stronie S i N (ϵ_s) / Stirrup 1a – strains on S and N side (ϵ_s)

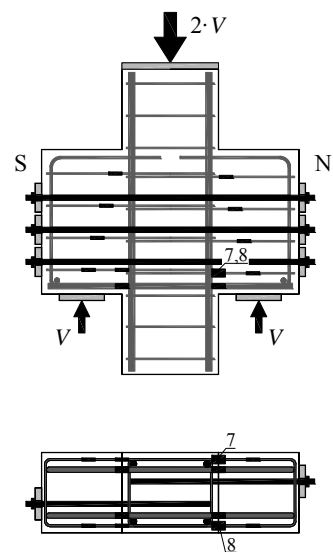
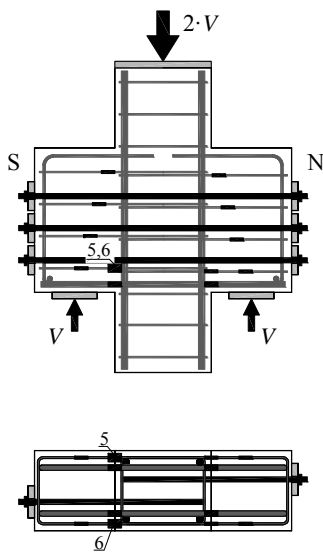
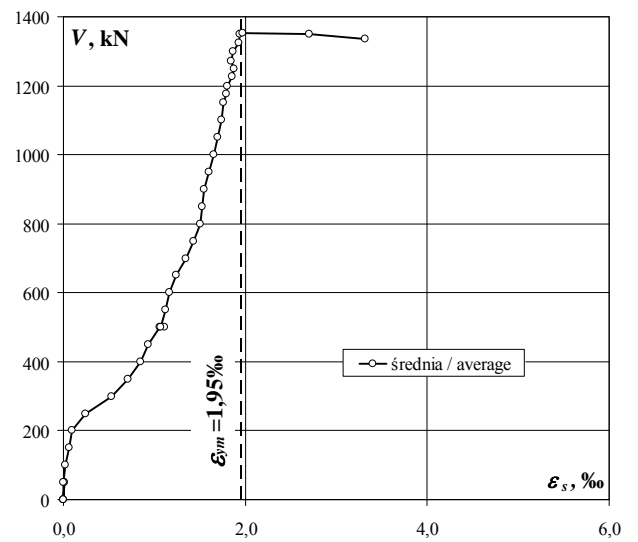
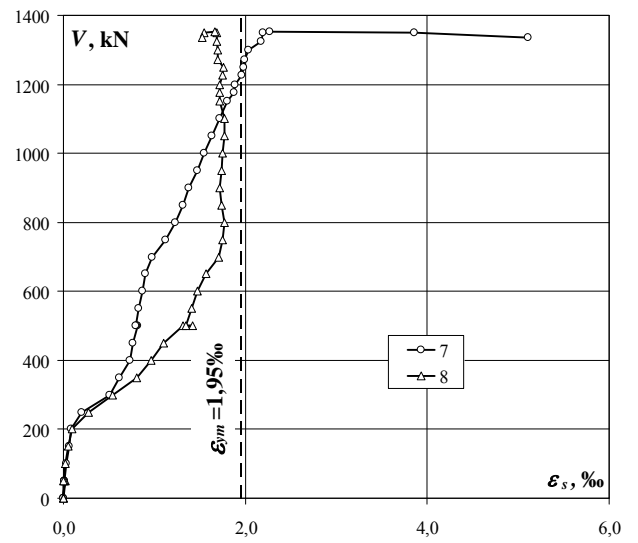
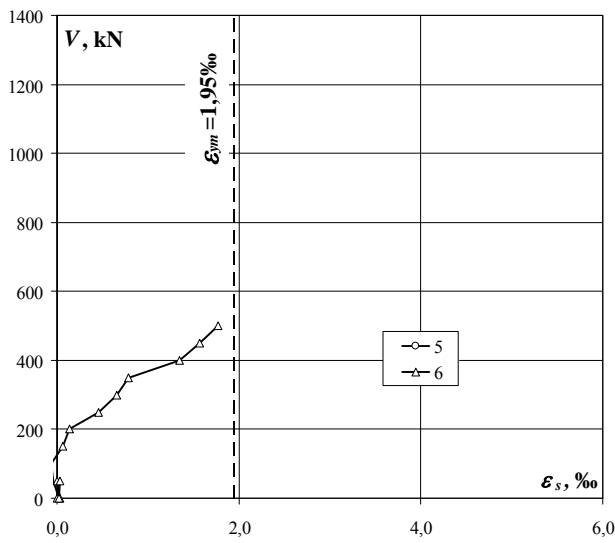

E-II

Strzemię 1b – odkształcenia po stronie S i N (ε_s) / Stirrup 1b – strains on S and N side (ε_s)

obciążenie wspornika corbel load	odkształcenie S S strain			odkształcenie N N strain		
	9	10	średnia/ average	11	12	średnia/ average
kN	‰	‰	‰	‰	‰	‰
0	0,000	0,000	0,000	0,000	0,000	0,000
0	-0,001	-0,005	-0,003	0,000	0,002	0,001
50	0,013	0,008	0,011	0,004	0,010	0,007
50	0,009	0,008	0,009	0,007	0,012	0,010
0	0,000	0,003	0,002	0,003	0,002	0,003
50	0,012	0,009	0,011	0,006	0,011	0,009
100	0,026	0,025	0,026	0,019	0,029	0,024
150	0,034	0,043	0,039	0,028	0,042	0,035
200	0,033	0,055	0,044	0,037	0,053	0,045
250	0,044	0,062	0,053	0,040	0,064	0,052
300	0,059	0,078	0,069	0,058	0,066	0,062
350	0,074	0,093	0,084		0,073	0,073
400	0,098	0,082	0,090		0,083	0,083
450	0,132	0,096	0,114		0,088	0,088
500	0,193	0,119	0,156		0,091	0,091
500	0,366	0,425	0,396		0,056	0,056
500	0,369	0,465	0,417		0,048	0,048
550	0,380	0,493	0,437		0,058	0,058
600	0,385	0,757	0,571		0,065	0,065
650	0,999	1,351	1,175		0,070	0,070
700	1,069	1,477	1,273		0,075	0,075
750	1,139	1,609	1,374		0,106	0,106
800	1,206	1,758	1,482		0,327	0,327
850	1,274	1,871	1,573		0,548	0,548
900	1,336	1,922	1,629		0,540	0,540
950	1,410	1,915	1,663		0,548	0,548
1000	1,474	1,900	1,687		0,556	0,556
1050	1,544	1,879	1,712		0,572	0,572
1100	1,576	1,863	1,720		0,592	0,592
1150	1,602	1,853	1,728		0,610	0,610
1176	1,641	1,851	1,746		0,635	0,635
1199	1,655	1,864	1,760		0,634	0,634
1226	1,697	1,837	1,767		0,654	0,654
1250	1,712	1,845	1,779		0,659	0,659
1273	1,727	1,820	1,774		0,660	0,660
1300	1,733	1,827	1,780		0,667	0,667
1323	1,751	1,823	1,787		0,701	0,701
1349	1,761	1,823	1,792		0,700	0,700
1353	1,747	1,812	1,780		0,703	0,703
1350	1,742	1,796	1,769		0,873	0,873
1334	1,717	1,768	1,743		0,914	0,914

Strzemię 1b – odkształcenia po stronie S i N (ϵ_s) / Stirrup 1b – strains on S and N side (ϵ_s)

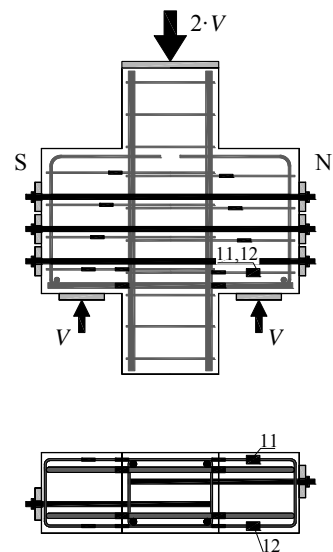
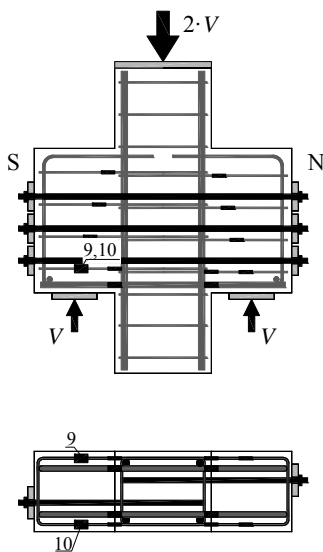
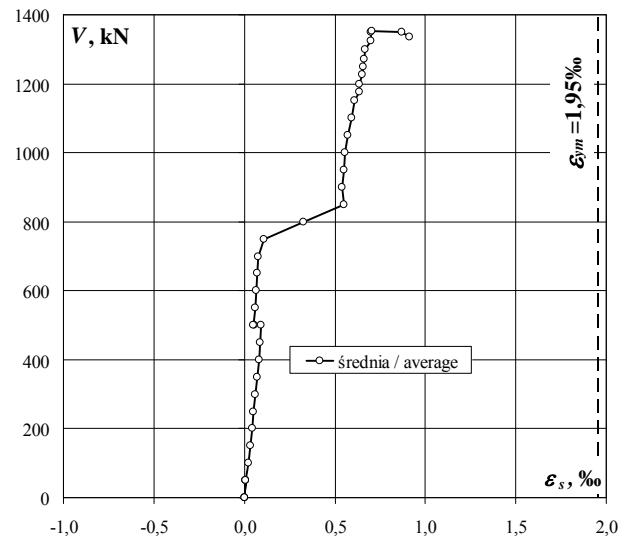
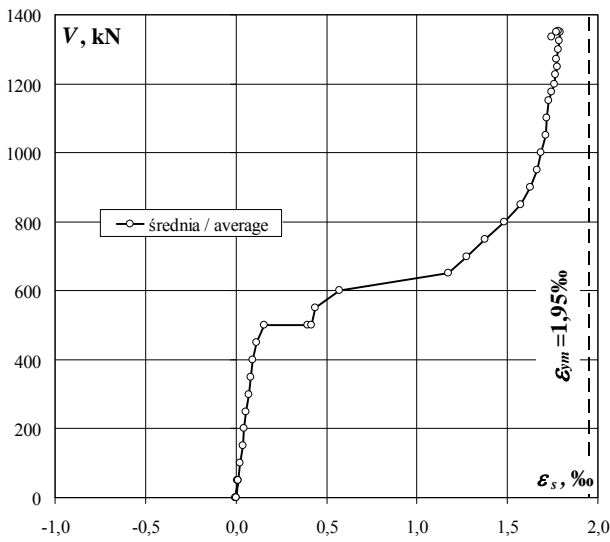
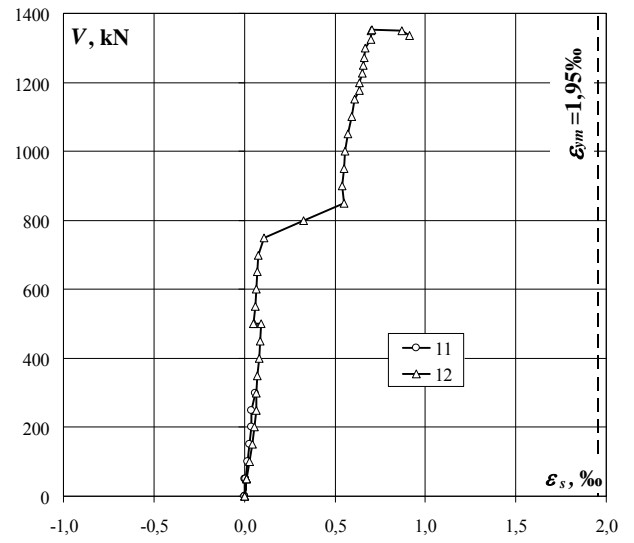
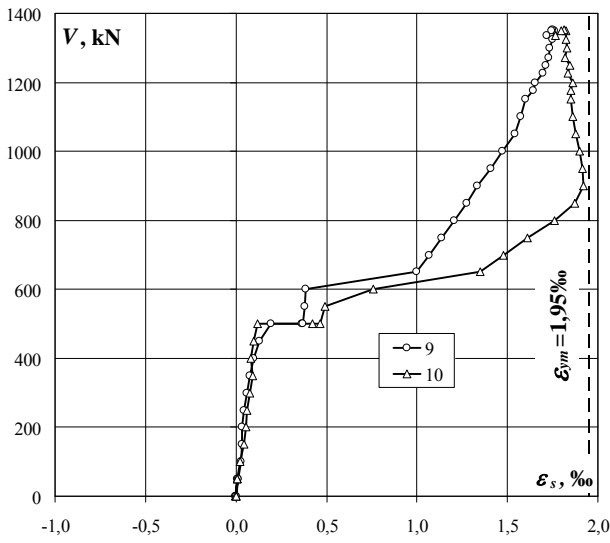

E-II

Strzemię 2 – odkształcenia po stronie S i N (ϵ_s) / Stirrup 2 – strains on S and N side (ϵ_s)

obciążenie wspornika corbel load	odkształcenie S S strain			odkształcenie N N strain		
	13	14	średnia/ average	15	16	średnia/ average
	kN	‰	‰	‰	‰	‰
0	0,000	0,000	0,000	0,000	0,000	0,000
0	-0,016	-0,004	-0,010	-0,001	0,002	0,001
50	0,014	0,002	0,008	0,000	0,006	0,003
50	0,012	0,002	0,007	0,005	0,006	0,006
0	-0,012	0,001	-0,006	0,004	-0,001	0,002
50	-0,021	0,003	-0,009	0,003	0,004	0,004
100	-0,033	0,010	-0,012	0,016	0,011	0,014
150	-0,026	0,023	-0,002	0,043	0,025	0,034
200	-0,020	0,041	0,011	0,055	0,035	0,045
250	-0,047	0,055	0,004	0,067	0,044	0,056
300	0,000	0,050	0,025	0,066	0,045	0,056
350	0,018	0,059	0,039	0,060	0,042	0,051
400	0,050	0,065	0,058	0,061	0,047	0,054
450	0,016	0,086	0,051	0,063	0,051	0,057
500	0,024	0,077	0,051	0,071	0,058	0,065
500	0,086	0,331	0,209	0,062	-0,083	-0,011
500	-0,059	0,356	0,149	0,076	0,109	0,093
550	-0,053	0,380	0,164	0,077	0,097	0,087
600	0,091	0,827	0,459	0,087	0,106	0,097
650	0,533	1,689	1,111	0,108	0,120	0,114
700	0,715	1,845	1,280	0,096	0,126	0,111
750	0,866	1,898	1,382	0,291	0,108	0,200
800	0,920	1,875	1,398	0,398	0,099	0,249
850	0,917	1,844	1,381	0,409	0,084	0,247
900	0,884	1,831	1,358		0,050	0,050
950	0,855	1,818	1,337		0,059	0,059
1000	0,859	1,805	1,332		0,020	0,020
1050	0,841	1,805	1,323		-0,003	-0,003
1100	0,886	1,787	1,337		-0,059	-0,059
1150	0,921	1,816	1,369		-0,054	-0,054
1176	0,934	1,837	1,386		-0,026	-0,026
1199	0,939	1,841	1,390		-0,020	-0,020
1226	0,983	1,824	1,404		0,067	0,067
1250	0,986	1,825	1,406		0,025	0,025
1273	1,024	1,812	1,418		0,107	0,107
1300	1,033	1,815	1,424		0,094	0,094
1323	1,087	1,811	1,449		0,180	0,180
1349	1,098	1,806	1,452		0,211	0,211
1353	1,108	1,794	1,451		0,227	0,227
1350	1,196	1,789	1,493		1,799	1,799
1334	1,198	1,753	1,476		1,963	1,963

Strzemię 2 – odkształcenia po stronie S i N (ϵ_s) / Stirrup 2 – strains on S and N side (ϵ_s)

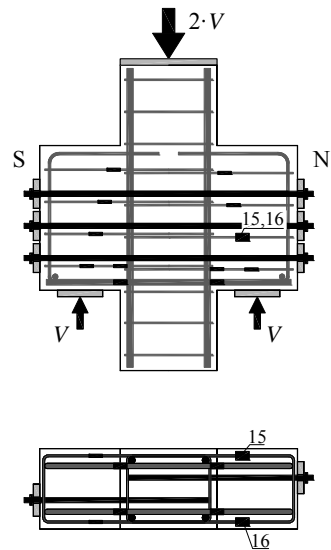
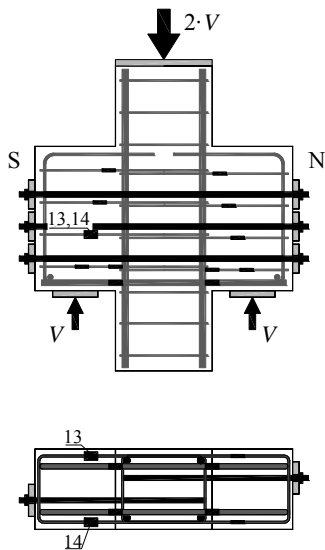
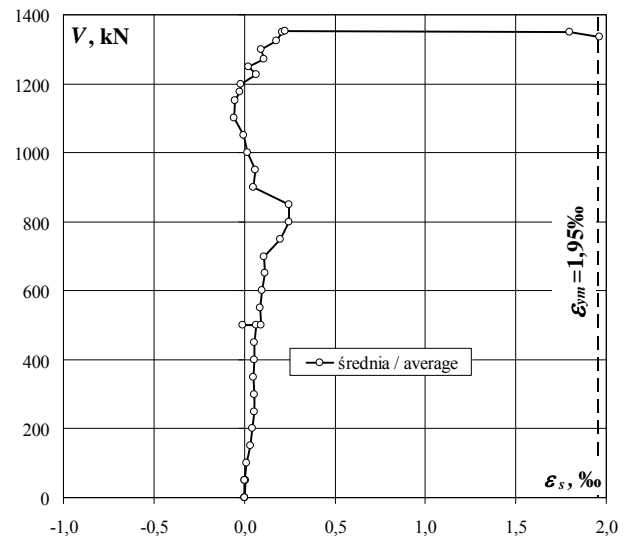
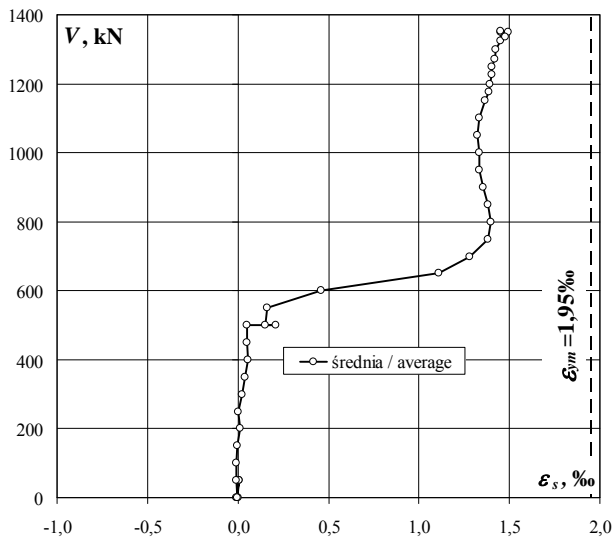
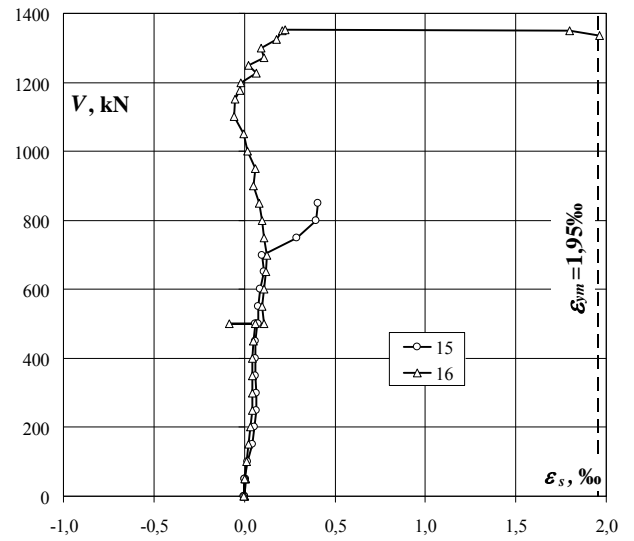
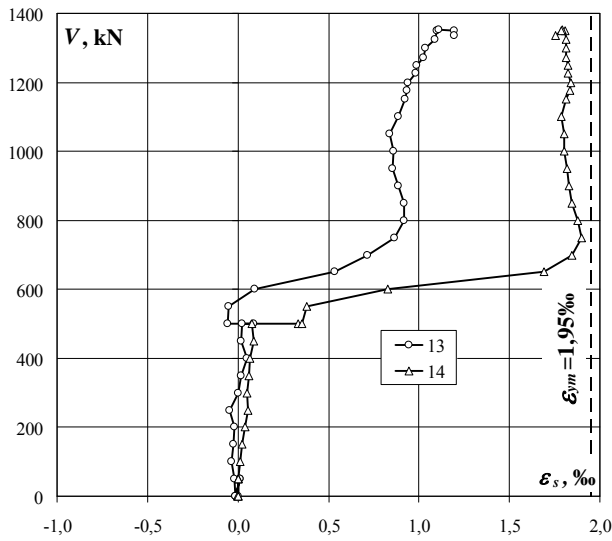

E-II

Strzemię 3 – odkształcenia po stronie S i N (ε_s) / Stirrup 3 – strains on S and N side (ε_s)

obciążenie wspornika corbel load	odkształcenie S S strain			odkształcenie N N strain		
	17	18	średnia/ average	19	20	średnia/ average
kN	‰	‰	‰	‰	‰	‰
0	0,000	0,000	0,000	0,000	0,000	0,000
0	-0,001	-0,002	-0,002	0,001	0,000	0,001
50	0,000	0,006	0,003	-0,005	0,002	-0,002
50	-0,003	0,004	0,001	-0,004	0,000	-0,002
0	0,000	0,001	0,001	0,002	-0,001	0,001
50	-0,001	0,006	0,003	-0,002	-0,004	-0,003
100	-0,001	0,017	0,008	-0,003	-0,005	-0,004
150	0,001	0,034	0,018	-0,003	-0,002	-0,003
200	0,018	0,042	0,030	0,000	0,000	0,000
250	0,022	0,043	0,033	0,006	0,008	0,007
300	0,027	0,051	0,039	0,019	0,024	0,022
350	0,030	0,057	0,044	0,022	0,032	0,027
400	0,035	0,066	0,051	0,023	0,038	0,031
450	0,039	0,076	0,058	0,026	0,035	0,031
500	0,044	0,085	0,065	0,033	0,039	0,036
500	-0,024	0,040	0,008	-0,004	0,019	0,008
500	-0,051	0,038	-0,007	-0,009	0,003	-0,003
550	-0,047	0,046	-0,001	-0,005	0,005	0,000
600	-0,052	0,047	-0,003	-0,001	0,005	0,002
650	0,734	0,918	0,826	0,011	0,014	0,013
700	0,796	0,943	0,870	0,090	0,031	0,061
750	0,855	0,981	0,918	0,347	0,049	0,198
800	0,914	1,031	0,973	0,440	0,051	0,246
850	0,973	1,084	1,029	0,564	0,063	0,314
900	0,965	1,137	1,051	0,628	0,085	0,357
950	1,002	1,201	1,102	0,666	0,106	0,386
1000	1,039	1,256	1,148	0,703	0,114	0,409
1050	1,084	1,325	1,205	0,748	0,125	0,437
1100	1,137	1,374	1,256	0,788	0,141	0,465
1150	1,207	1,430	1,319	0,840	0,154	0,497
1176	1,261	1,497	1,379	0,880	0,164	0,522
1199	1,275	1,520	1,398	0,892	0,167	0,530
1226	1,351	1,633	1,492	0,937	0,180	0,559
1250	1,365	1,656	1,511	0,954	0,183	0,569
1273	1,393	1,726	1,560	0,982	0,190	0,586
1300	1,412	1,765	1,589	1,000	0,193	0,597
1323	1,452	1,904	1,678	1,049	0,195	0,622
1349	1,467	1,950	1,709	1,069	0,202	0,636
1353	1,476	2,033	1,755	1,078	0,186	0,632
1350	1,539	2,344	1,942	1,258	0,948	1,103
1334	1,540	2,342	1,941	1,445	1,282	1,364

Strzemię 3 – odkształcenia po stronie S i N (ϵ_s) / Stirrup 3 – strains on S and N side (ϵ_s)

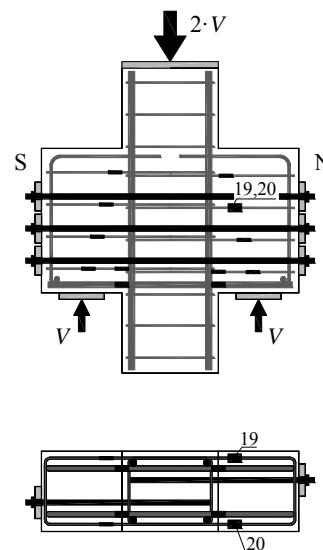
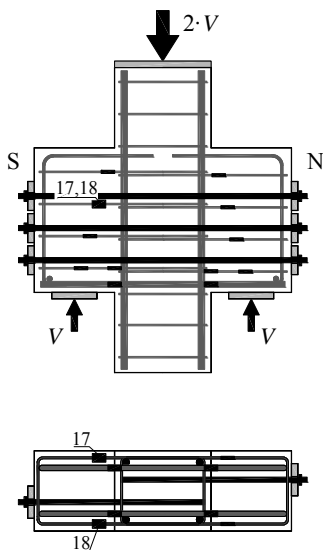
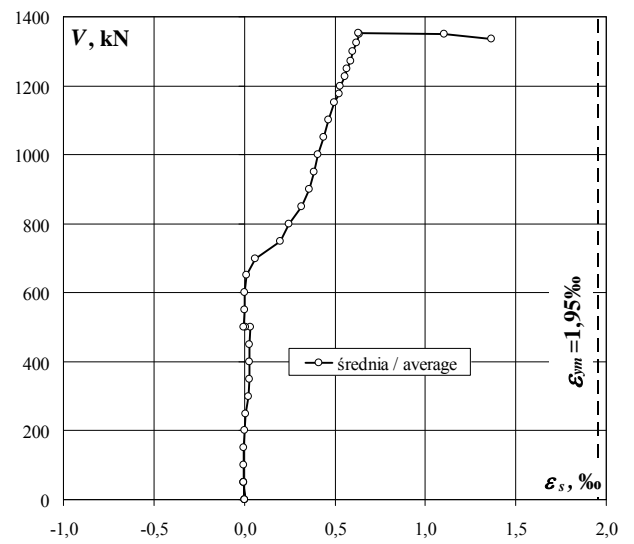
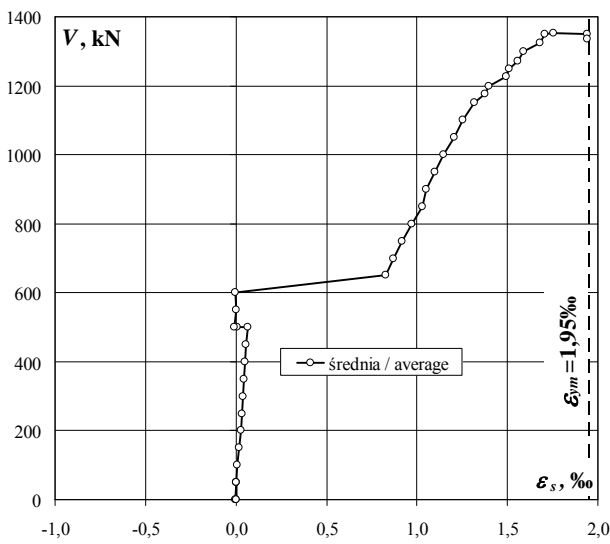
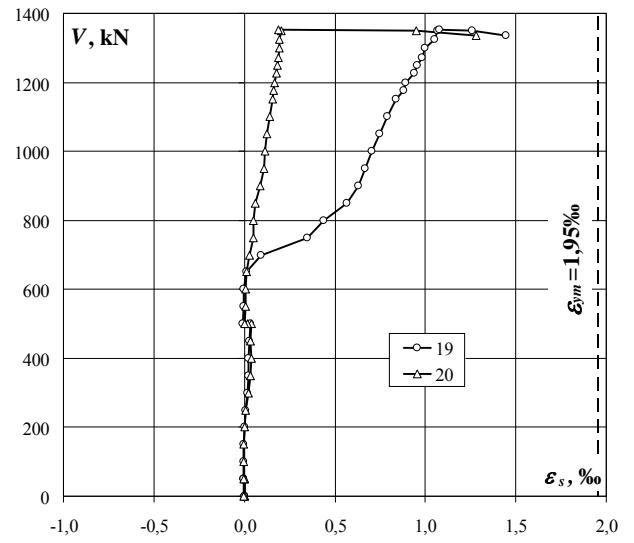
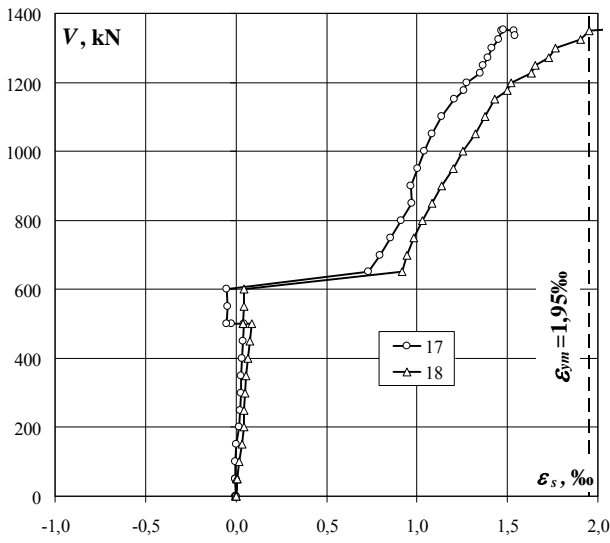

E-II

Strzemię 4 – odkształcenia po stronie S i N (ε_s) / Stirrup 4 – strains on S and N side (ε_s)

obciążenie wspornika corbel load	odkształcenie S S strain			odkształcenie N N strain		
	21	22	średnia/ average	23	24	średnia/ average
kN	‰	‰	‰	‰	‰	‰
0	0,000	0,000	0,000	0,000	0,000	0,000
0	-0,008	-0,003	-0,006	0,008	-0,003	0,003
50	-0,013	-0,012	-0,013	-0,016	-0,016	-0,016
50	-0,012	-0,012	-0,012	-0,032	-0,016	-0,024
0	-0,001	-0,002	-0,002	-0,026	-0,001	-0,014
50	-0,009	-0,011	-0,010	-0,031	-0,014	-0,023
100	-0,025	-0,026	-0,026	-0,050	-0,033	-0,042
150	-0,039	-0,048	-0,044	-0,054	-0,056	-0,055
200	-0,051	-0,076	-0,064	-0,033	-0,083	-0,058
250	-0,053	-0,095	-0,074	-0,095	-0,105	-0,100
300	-0,052	-0,107	-0,080	-0,069	-0,128	-0,099
350	-0,047	-0,123	-0,085	-0,074	-0,137	-0,106
400	-0,054	-0,126	-0,090	-0,078	-0,142	-0,110
450	-0,059	-0,127	-0,093	-0,068	-0,154	-0,111
500	-0,063	-0,127	-0,095	-0,070	-0,158	-0,114
500	-0,045	-0,130	-0,088	-0,321	-0,159	-0,240
500	-0,094	-0,140	-0,117	-0,446	-0,174	-0,310
550	-0,103	-0,148	-0,126	-0,471	-0,184	-0,328
600	-0,130	-0,097	-0,114	-0,498	-0,198	-0,348
650	0,101	0,059	0,080	-0,480	-0,196	-0,338
700	0,144	0,094	0,119	-0,385	-0,188	-0,287
750	0,195	0,136	0,166	-0,294	-0,141	-0,218
800	0,229	0,183	0,206	-0,334	-0,097	-0,216
850	0,262	0,235	0,249	-0,408	-0,047	-0,228
900	0,299	0,281	0,290	-0,348	-0,010	-0,179
950	0,344	0,350	0,347	-0,362	0,033	-0,165
1000	0,378	0,418	0,398	-0,358	0,069	-0,145
1050	0,420	0,504	0,462	-0,359	0,116	-0,122
1100	0,472	0,584	0,528	-0,314	0,172	-0,071
1150	0,529	0,683	0,606	-0,292	0,234	-0,029
1176	0,582	0,788	0,685	-0,345	0,304	-0,021
1199	0,589	0,802	0,696	-0,346	0,306	-0,020
1226	0,640	0,921	0,781	-0,389	0,382	-0,004
1250	0,649	0,937	0,793	-0,380	0,391	0,006
1273	0,722	1,042	0,882	-0,258	0,458	0,100
1300	0,745	1,071	0,908	-0,245	0,472	0,114
1323	0,825	1,199	1,012	-0,155	0,573	0,209
1349	0,842	1,224	1,033	-0,135	0,591	0,228
1353	0,878	1,271	1,075	-0,094	0,602	0,254
1350	0,972	1,410	1,191	0,239	1,206	0,723
1334	0,982	1,404	1,193	-0,285	1,448	0,582

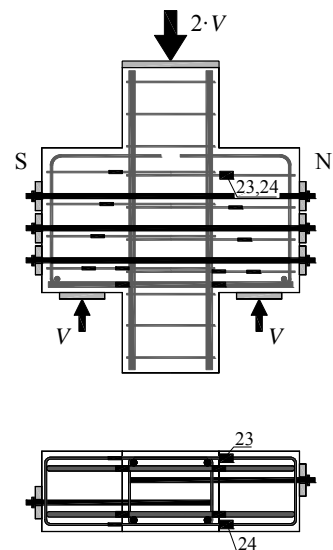
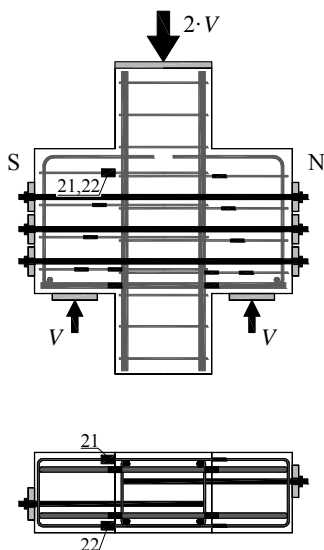
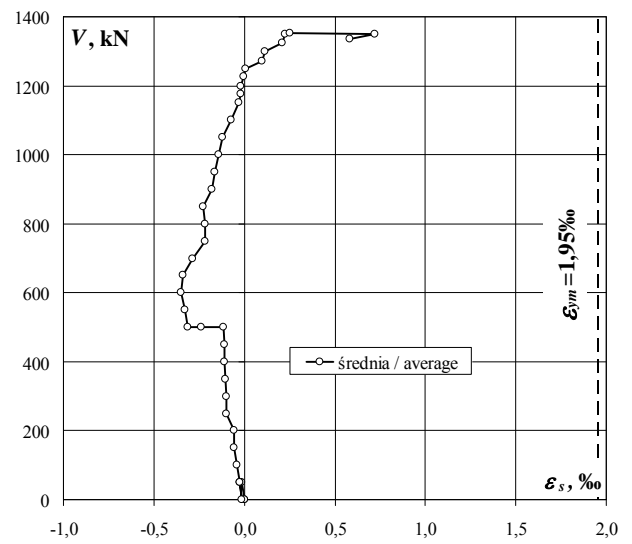
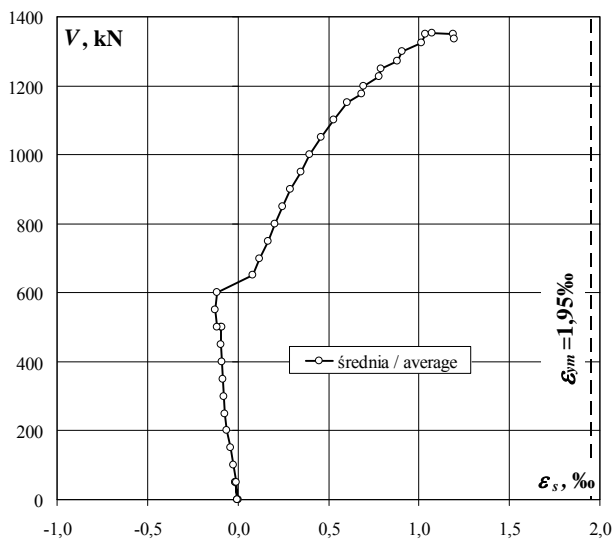
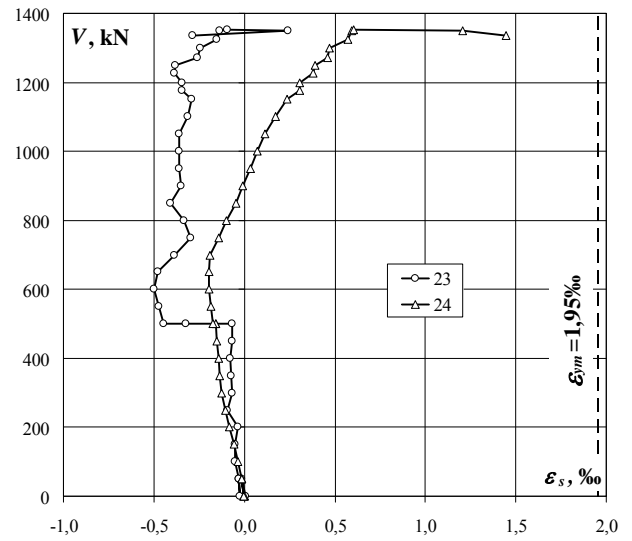
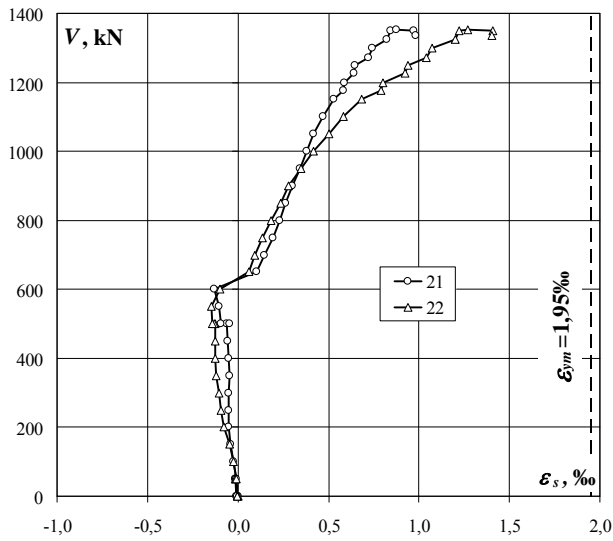
Strzemię 4 – odkształcenia po stronie S i N (ε_s) / Stirrup 4 – strains on S and N side (ε_s)

E-II

Odształcenia na pierwszym poziomie / Strains At the 1st level

obciążenie wspornika corbel load	przesunięcia wg ekstensometrów displacement acc to extensometers			obciążenie wspornika corbel load	przesunięcia wg systemu Aramis displacement acc to Aramis System		
	1	2	3		1'	2'	3'
kN	%	%	%	kN	%	%	%
0	0,000	0,000	0,000	0	0,00	0,00	0,00
0	0,000	0,000	-0,015	50	0,01	-0,06	0,02
50	0,010	0,000	-0,010	100	0,08	0,08	-0,21
50	0,010	0,000	-0,010	150	0,11	0,19	-0,17
0	0,000	-0,015	0,000	200	0,13	0,29	0,11
50	0,010	0,020	0,010	250	0,09	0,45	0,08
100	0,050	0,005	0,035	300	0,44	0,38	0,16
150	0,085	-0,010	0,130	350	0,45	0,39	0,14
200	0,090	-0,020	0,375	400	0,84	0,32	0,33
250	0,185	-0,015	0,700	450	0,94	0,60	0,41
300	0,465	-0,015	0,775	500	1,18	0,44	0,98
350	0,815	-0,020	0,880	550	1,17	0,39	0,92
400	1,045	-0,015	1,020	600	1,13	0,60	1,07
450	1,235	-0,010	1,160	650	1,37	0,60	1,28
500	1,405	-0,020	1,315	700	1,62	0,42	1,46
500	1,640	0,070	1,395	750	1,81	0,51	1,58
500	1,625	0,055	1,385	800	2,01	0,55	1,55
550	1,675	0,095	1,415	850	1,93	0,69	1,37
600	1,750	0,060	1,490	900	2,28	0,83	1,88
650	1,795	0,055	1,930	950	2,67	0,74	1,64
700	1,940	0,060	2,040	1000	2,66	0,60	2,01
750	2,175	0,050	2,135	1050	2,82	0,45	2,10
800	2,335	0,055	2,250	1100	3,24	0,76	2,38
850	2,570	0,050	2,380	1150	3,22	0,69	2,36
900	2,755	0,055	2,470	1200	3,87	1,04	2,55
950	2,915	0,050	2,600	1250	3,98	0,99	2,59
1000	3,055	0,050	2,710	1300	4,12	1,00	2,84
1050	3,210	0,055	2,865	1350	4,79	0,78	3,09
1100	3,365	0,045	3,035				
1150	3,530	0,060	3,220				
1176	3,700	0,035	3,380				
1199	3,720	0,045	3,420				
1226	3,935	0,060	3,565				
1250	3,975	0,055	3,610				
1273	4,240	0,030	3,740				
1300	4,290	0,040	3,770				
1323	4,655	0,045	3,950				
1349	4,710	0,225	3,985				
1353	4,850	0,035	4,040				
1350	5,995	0,035	4,260				
1334	6,160	0,030	4,265				

Według ekstensometrów / According to extensometers

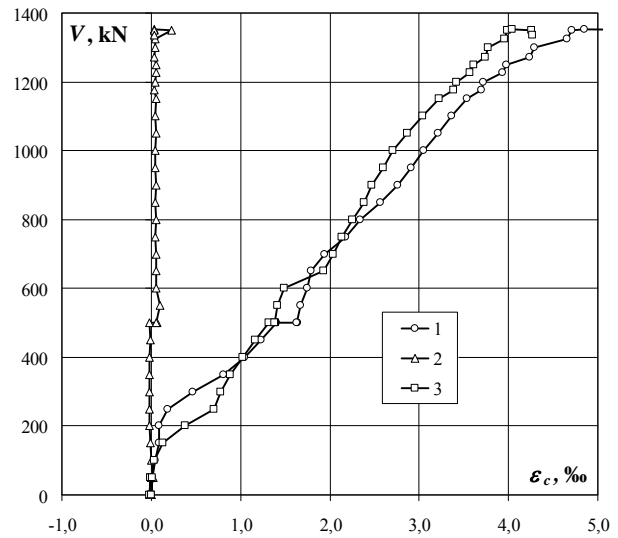

Według systemu Aramis / According to Aramis System

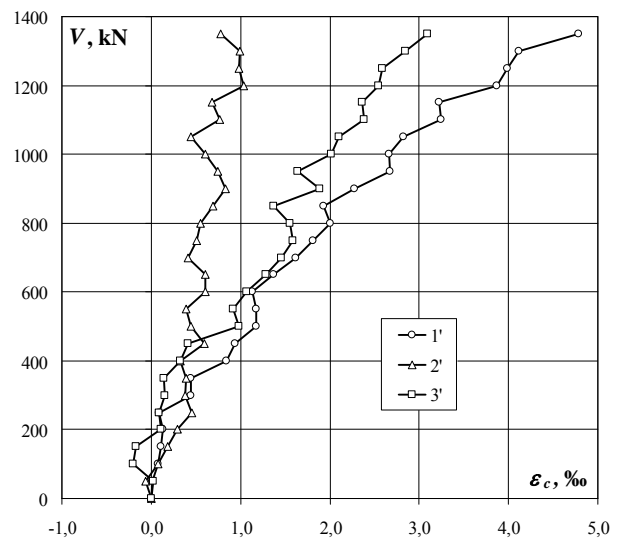

Ekstensometry
Extensometers

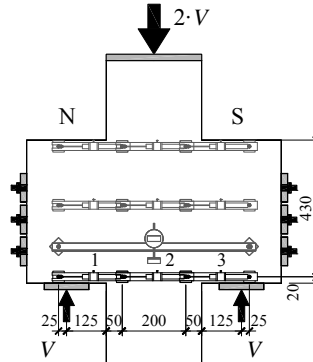

System Aramis
Aramis System

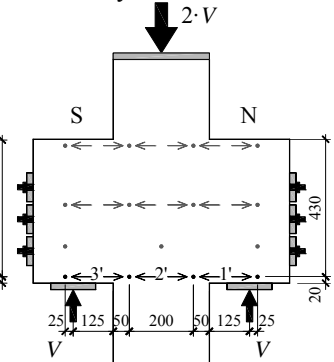

Odształcenia na drugim poziomie / Strains at the 2nd level

obciążenie wspornika corbel load	przesunięcia wg ekstensometrów displacement acc to extensometers			obciążenie wspornika corbel load	przesunięcia wg systemu Aramis displacement acc to Aramis System		
	4	5	6		4'	5'	6'
kN	%	%	%	kN	%	%	%
0	0,000	0,000	0,000	0	0,00	0,00	0,00
0	0,000	-0,015	0,000	50	-0,13	-0,13	-0,12
50	0,000	-0,015	0,000	100	-0,09	0,14	-0,21
50	0,000	-0,015	0,000	150	-0,10	0,26	-0,35
0	0,000	0,000	0,000	200	-0,10	0,04	-0,02
50	0,000	0,000	-0,015	250	-0,01	0,12	-0,07
100	0,000	-0,015	0,000	300	0,16	0,15	-0,06
150	0,005	0,000	0,015	350	-0,03	0,40	-0,05
200	0,000	0,065	0,010	400	-0,02	0,45	-0,21
250	0,010	0,205	0,025	450	0,12	0,71	-0,14
300	0,020	0,275	0,020	500	0,12	0,71	0,06
350	0,025	0,480	0,025	550	0,11	0,81	-0,01
400	0,030	0,670	0,020	600	0,22	0,69	0,20
450	0,025	0,815	0,020	650	0,31	0,69	0,46
500	0,030	0,930	0,020	700	0,36	0,64	0,65
500	0,450	1,185	0,075	750	0,47	0,61	0,79
500	0,455	1,185	0,075	800	0,63	0,59	0,75
550	0,465	1,190	0,080	850	0,64	0,63	0,67
600	0,465	1,200	0,080	900	1,10	0,62	1,10
650	0,485	1,020	0,095	950	0,65	0,50	1,24
700	0,590	0,965	0,100	1000	1,44	0,30	1,07
750	0,710	0,925	0,105	1050	1,37	0,34	1,34
800	0,730	0,905	0,105	1100	1,63	0,45	1,81
850	0,805	0,850	0,110	1150	1,62	0,38	1,57
900	0,965	0,770	0,095	1200	1,99	0,53	1,97
950	1,055	0,770	0,115	1250	2,08	0,36	2,05
1000	1,160	0,735	0,120	1300	2,34	0,38	2,22
1050	1,280	0,695	0,125	1350	2,74	0,28	2,33
1100	1,405	0,705	0,130				
1150	1,550	0,650	0,135				
1176	1,680	0,610	0,135				
1199	1,700	0,610	0,135				
1226	1,875	0,555	0,150				
1250	1,905	0,550	0,150				
1273	2,355	0,460	0,160				
1300	2,420	0,440	0,160				
1323	2,880	0,335	0,175				
1349	2,950	0,325	0,175				
1353	3,115	0,295	0,175				
1350	4,555	0,140	0,195				
1334	4,805	0,105	0,185				

Według ekstensometrów / According to extensometers

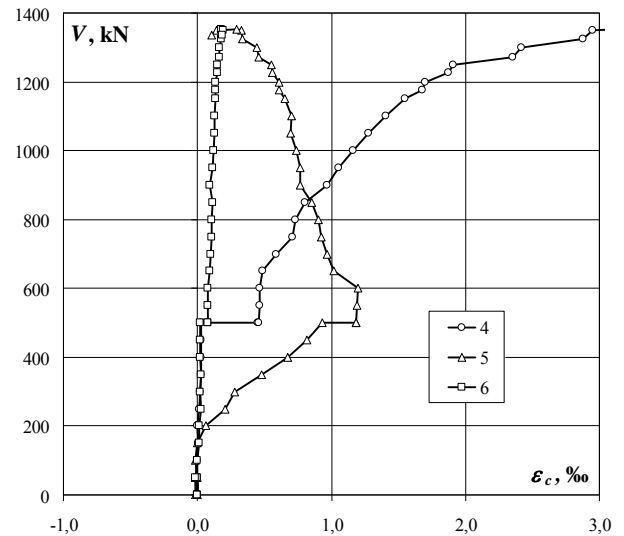

Według systemu Aramis / According to Aramis System

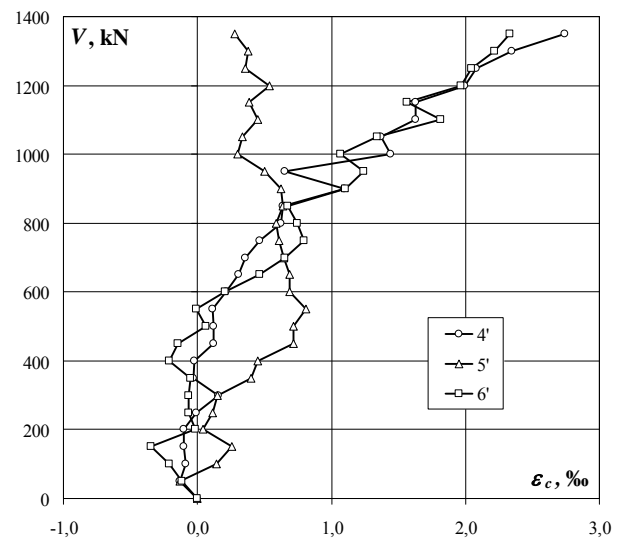

Ekstensometry
Extensometers

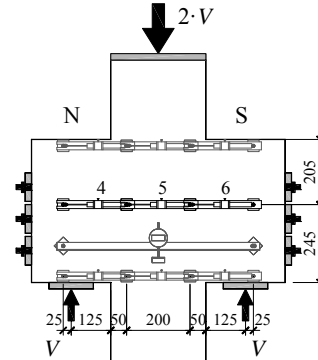

System Aramis
Aramis System

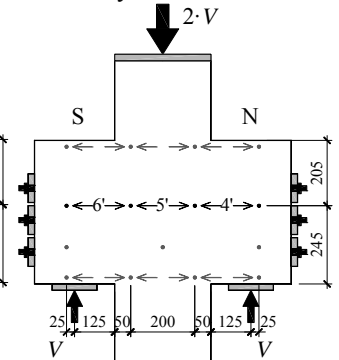

E-II

Odształcenia na trzecim poziomie / Strains at the 3rd level

obciążenie wspornika corbel load	przesunięcia wg ekstensometrów displacement acc to extensometers			obciążenie wspornika corbel load	przesunięcia wg systemu Aramis displacement acc to Aramis System		
	7	8	9		7'	8'	9'
kN	%	%	%	kN	%	%	%
0	0,000	0,000	0,000	0	0,00	0,00	0,00
0	-0,015	-0,040	0,000	50	0,10	-0,05	-0,02
50	-0,020	-0,045	0,000	100	0,31	-0,01	-0,11
50	-0,020	-0,120	-0,045	150	0,19	-0,01	-0,13
0	0,000	0,000	0,000	200	0,01	-0,10	0,02
50	0,000	0,000	0,000	250	-0,01	-0,14	-0,18
100	0,000	-0,010	0,000	300	-0,12	-0,06	-0,52
150	0,000	-0,050	-0,010	350	-0,05	-0,05	-0,42
200	0,000	-0,080	-0,015	400	-0,42	-0,14	-0,28
250	0,000	-0,100	-0,025	450	-0,06	-0,25	-0,56
300	0,000	-0,120	-0,035	500	-0,06	-0,20	-0,52
350	0,000	-0,135	-0,040	550	-0,01	-0,21	-0,52
400	0,000	-0,140	-0,055	600	0,01	-0,29	-0,41
450	0,010	-0,090	-0,065	650	-0,01	-0,13	-0,47
500	0,000	-0,155	-0,080	700	-0,04	-0,34	-0,42
500	0,005	-0,145	-0,075	750	0,10	-0,29	-0,54
500	0,000	-0,120	-0,075	800	0,12	-0,31	-0,35
550	0,000	-0,135	-0,075	850	-0,05	-0,44	-0,07
600	0,000	-0,170	-0,090	900	-0,02	-0,26	-0,18
650	0,015	-0,145	-0,085	950	-0,02	-0,44	-0,32
700	0,015	-0,140	-0,095	1000	0,11	-0,35	-0,13
750	0,020	-0,140	-0,105	1050	-0,11	-0,31	-0,03
800	0,015	-0,145	-0,115	1100	0,18	-0,37	-0,03
850	0,015	-0,145	-0,125	1150	0,29	-0,38	0,05
900	-0,010	-0,150	-0,130	1200	0,43	-0,40	0,09
950	0,020	-0,155	-0,140	1250	0,25	-0,36	0,09
1000	0,015	-0,165	-0,150	1300	0,13	-0,45	0,22
1050	0,020	-0,185	-0,155	1350	0,56	-0,41	0,44
1100	0,020	-0,205	-0,145				
1150	0,020	-0,235	-0,160				
1176	0,025	-0,270	-0,160				
1199	0,025	-0,275	-0,160				
1226	0,035	-0,320	-0,165				
1250	0,030	-0,330	-0,160				
1273	0,045	-0,365	-0,155				
1300	0,050	-0,375	-0,155				
1323	0,070	-0,450	-0,150				
1349	0,070	-0,460	-0,145				
1353	0,075	-0,485	-0,145				
1350	0,165	-0,725	-0,125				
1334	0,180	-0,760	-0,125				

Według ekstensometrów / According to extensometers

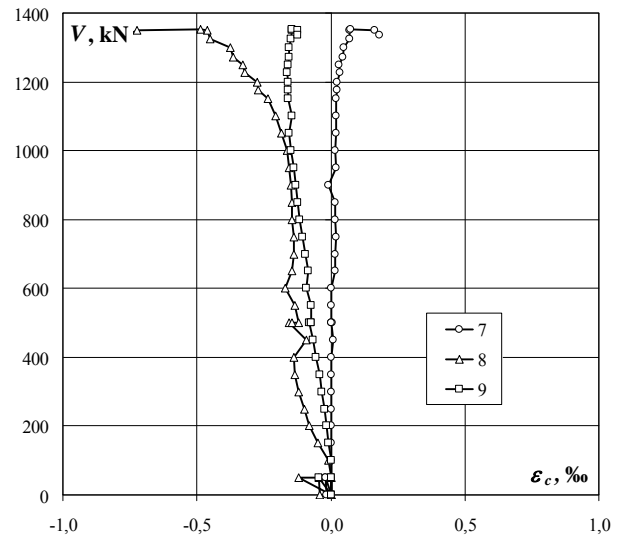

Według systemu Aramis / According to Aramis System

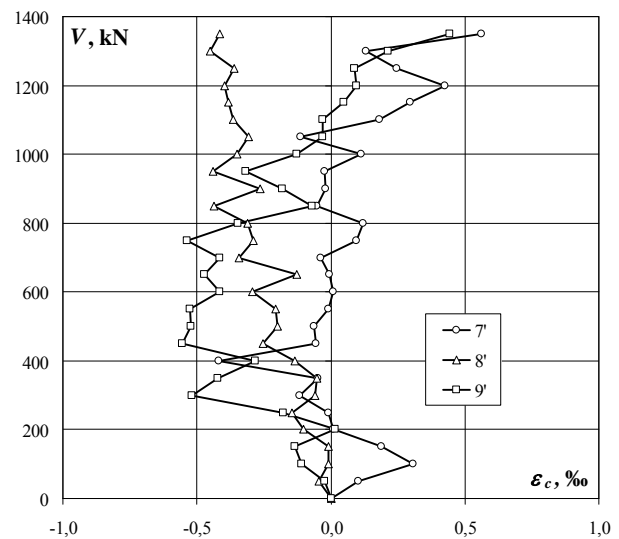

Ekstensometry
Extensometers

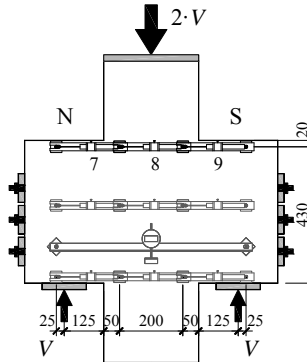

System Aramis
Aramis System

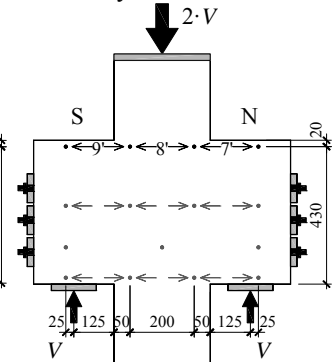

Przesunięcie słupa względem wsporników / The relative displacement between the column and the corbels

obciążenie wspornika corbel load	Przesunięcie wg czujnika Displacement acc to gauges	obciążenie wspornika corbel load	Przesunięcie wg systemu Aramis Displacement acc. to Aramis System
kN	mm	kN	mm
0	0,000	0	0,00
50	0,000	50	0,02
100	0,000	100	0,02
150	0,024	150	0,04
200	0,056	200	0,07
250	0,096	250	0,11
300	0,131	300	0,14
350	0,176	350	0,16
400	0,210	400	0,23
450	0,240	450	0,25
500	0,273	500	0,34
500	0,323	550	0,36
wzmocnienie / strengthening		600	0,40
500	0,324	650	0,43
550	0,331	700	0,47
600	0,347	750	0,52
600	0,352	800	0,56
650	0,400	850	0,58
700	0,436	900	0,64
700	0,459	950	0,68
750	0,483	1000	0,73
800	0,517	1050	0,77
850	0,560	1100	0,83
900	0,612	1150	0,91
950	0,651	1200	1,00
1000	0,688	1250	1,03
1050	0,732	1300	1,10
1050	0,758	1350	1,18
1100	0,790		
1150	0,851		
1200	0,922		
1250	0,989		
1300	1,070		
1300	1,131		
1350	1,176		

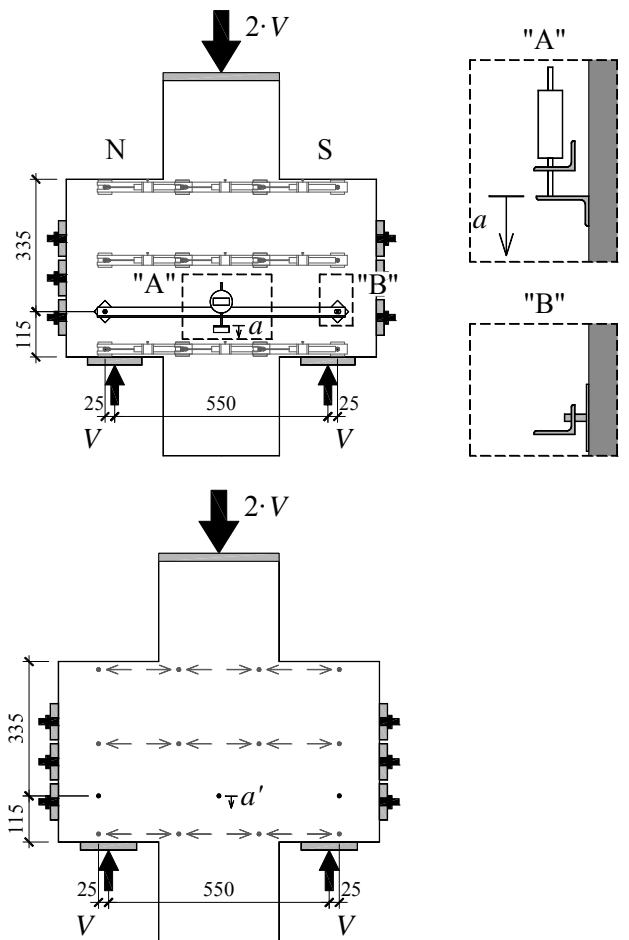
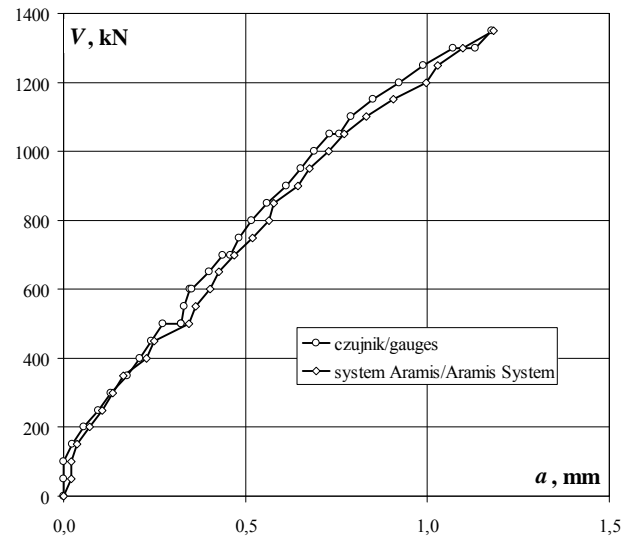

E-II

Szerokość rozwarcia rys / Crack width

obciążenie wspornika corbel load	Numer rysy / Crack number							
	1	2	3	4	5	6	7	8
	mm	mm	mm	mm	mm	mm	mm	mm
250								
300	0,10							
350	0,13	0,10						
400	0,15	0,12						
450	0,15	0,15						
500	0,15	0,15						
500	0,15	0,15						
550	0,15	0,20	0,15					
600	0,15	0,20	0,17					
650	0,17	0,20	0,17	0,17				
700	0,17	0,25	0,17	0,20				
750	0,17	0,25	0,17	0,22	0,12			
800	0,15	0,22	0,20	0,20	0,12			
850	0,17	0,22	0,20	0,20	0,17			
900	0,20	0,25	0,20	0,22	0,20	0,20		
950	0,20	0,25	0,20	0,22	0,20	0,20		
1000	0,22	0,22	0,20	0,22	0,25	0,20	0,25	
1050	0,20	0,25	0,20	0,22	0,25	0,20	0,27	
1100	0,20	0,22	0,20	0,20	0,30	0,20	0,30	
1150	0,20	0,25	0,20	0,22	0,37	0,27	0,35	0,40
1200	0,20	0,25	0,25	0,25	0,45	0,30	0,35	0,45

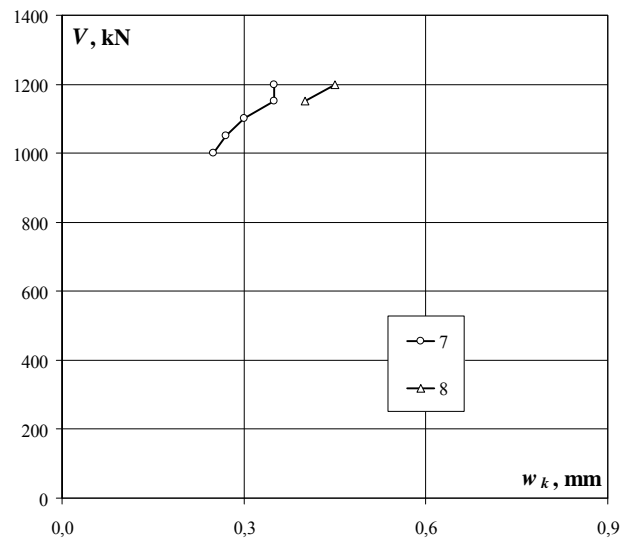
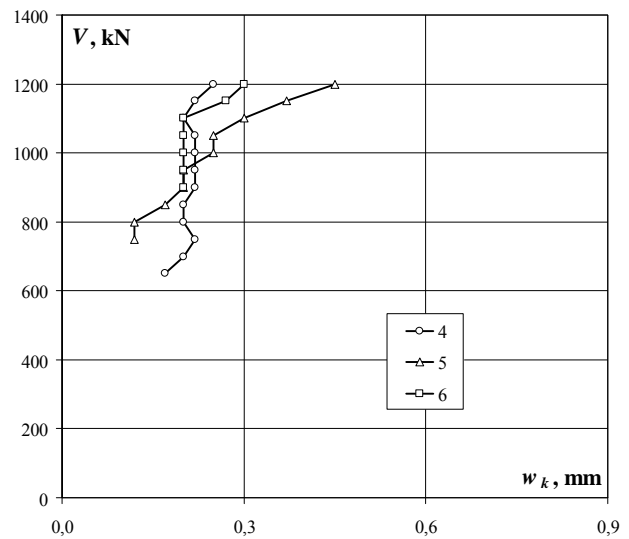
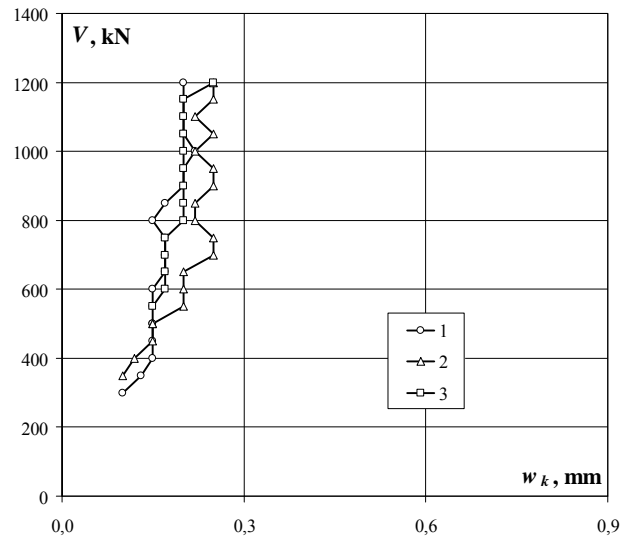

Układ rys przy sile 250kN / Crack pattern at 250kN

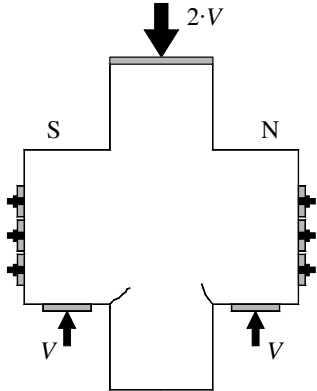

Układ rys przy sile 500kN / Crack pattern at 500kN

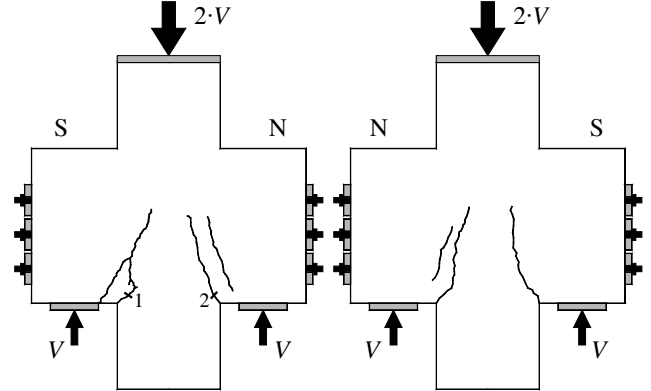

Układ rys przy sile 600kN / Crack pattern at 600kN

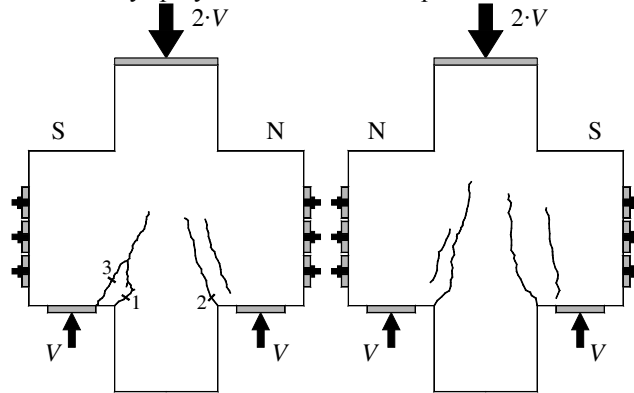

Układ rys przy sile 800kN / Crack pattern at 800kN

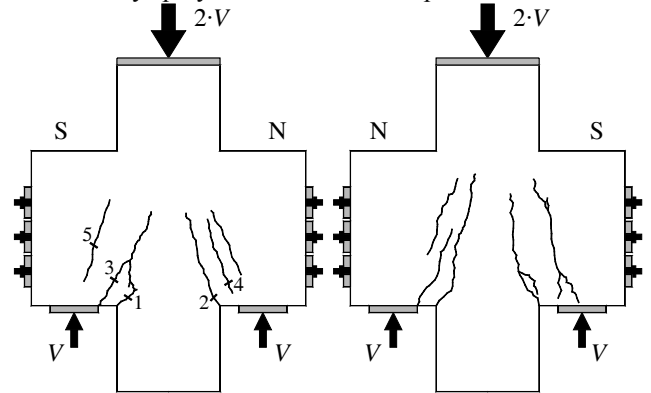

Układ rys przy sile 900kN / Crack pattern at 900kN

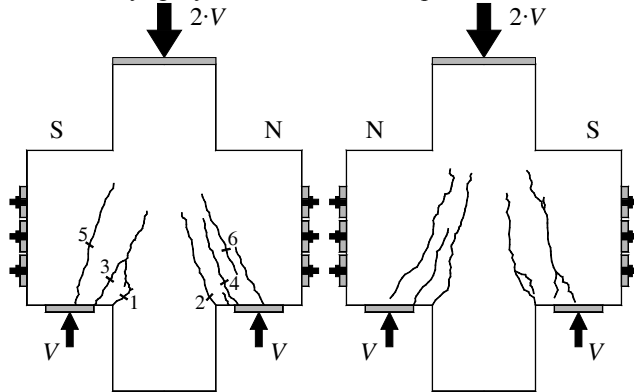

Układ rys przy sile 1000kN / Crack pattern at 1000kN

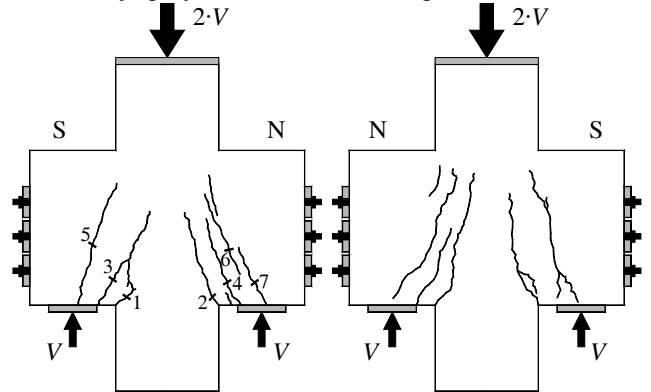

Układ rys przy sile 1200kN / Crack pattern at 1200kN

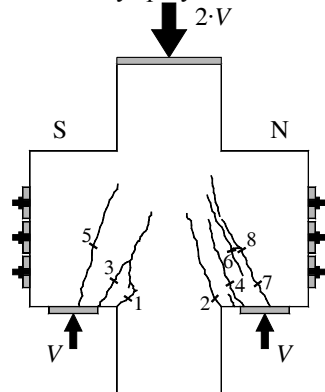

Układ rys przy sile 1353kN / Crack pattern at 1353kN

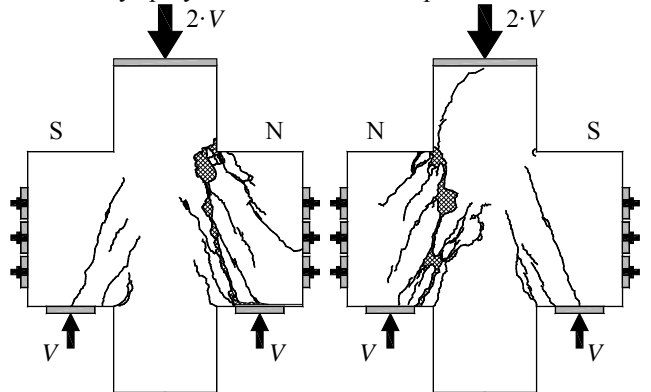

E-II

Szerokość rozwarcia rys według systemu Aramis / Crack width according to Aramis System

obciążenie wspornika corbel load	Numer rysy / Crack number							
	1	2	3	4	5	6	7	8
	mm	mm	mm	mm	mm	mm	mm	mm
0	0,00	0,00	0,00	0,00	0,00	0,00	0,00	0,00
50	0,02	0,00	0,08	0,04	0,01	-0,01	0,01	
100	0,01	-0,02	0,08	0,04	0,02	-0,02	0,02	
150	0,03	-0,01	0,07	0,04	0,03	-0,03	0,00	
200	0,10	0,03	0,09	0,05	0,01	0,02	0,01	
250	0,14	0,08	0,07	0,08	0,00	0,01	0,00	
300	0,16	0,11	0,06	0,03	0,01	0,01	0,03	
350	0,17	0,16	0,05	0,05	-0,01	0,02	0,02	
400	0,15	0,21	0,08	0,07	-0,01	0,01	0,01	
450	0,14	0,23	0,16	0,07	0,02	-0,01	0,03	
500	0,16	0,25	0,27	0,17	0,05	0,03	-0,01	
550	0,17	0,25	0,28	0,16	0,06	0,02	0,00	
600	0,20	0,26	0,25	0,13	0,15	0,03	0,00	
650	0,21	0,27	0,24	0,13	0,18	0,03	0,01	
700	0,22	0,27	0,23	0,18	0,21	0,07	0,03	
750	0,23	0,26	0,22	0,21	0,24	0,15	0,10	
800	0,22	0,27	0,24	0,20	0,26	0,20	0,15	
850	0,21	0,28	0,27	0,18	0,26	0,22	0,18	
900	0,23	0,29	0,29	0,17	0,33	0,29	0,27	
950	0,24	0,31	0,27	0,18	0,35	0,31	0,30	
1000	0,25	0,29	0,24	0,14	0,37	0,40	0,32	
1050	0,27	0,29	0,24	0,14	0,40	0,46	0,34	
1100	0,29	0,29	0,30	0,19	0,45	0,51	0,40	
1150	0,28	0,30	0,31	0,16	0,49	0,59	0,40	
1200	0,29	0,31	0,31	0,13	0,51	0,65	0,35	
1250	0,30	0,28	0,29	0,15	0,55	0,68	0,35	
1300	0,32	0,28	0,28	0,11	0,62	0,76	0,34	
1350	0,33	0,26	0,30	0,10	0,66	0,85	0,33	

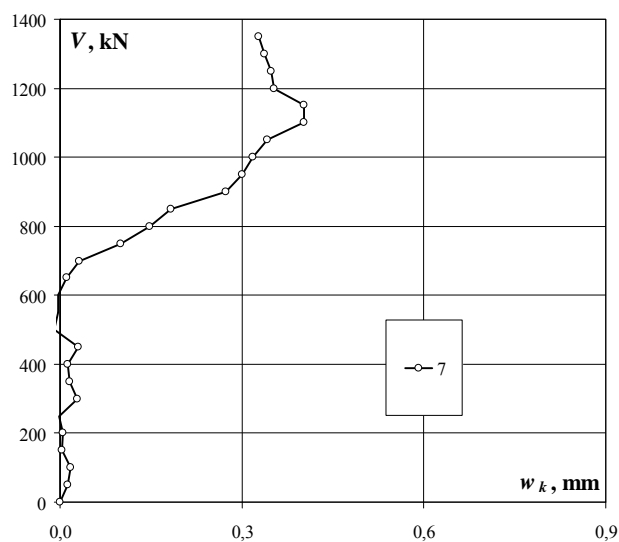
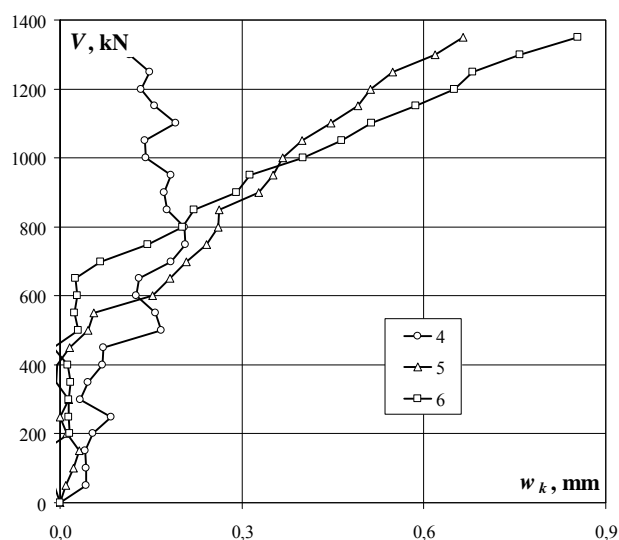
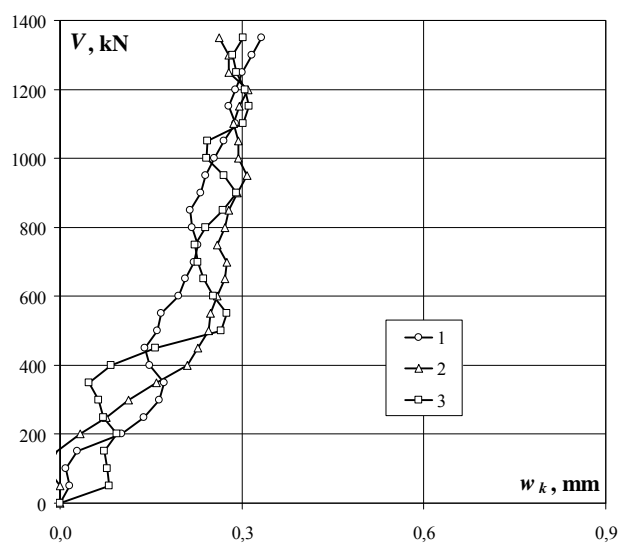

Układ rys przy sile 800kN / Crack pattern at 800kN

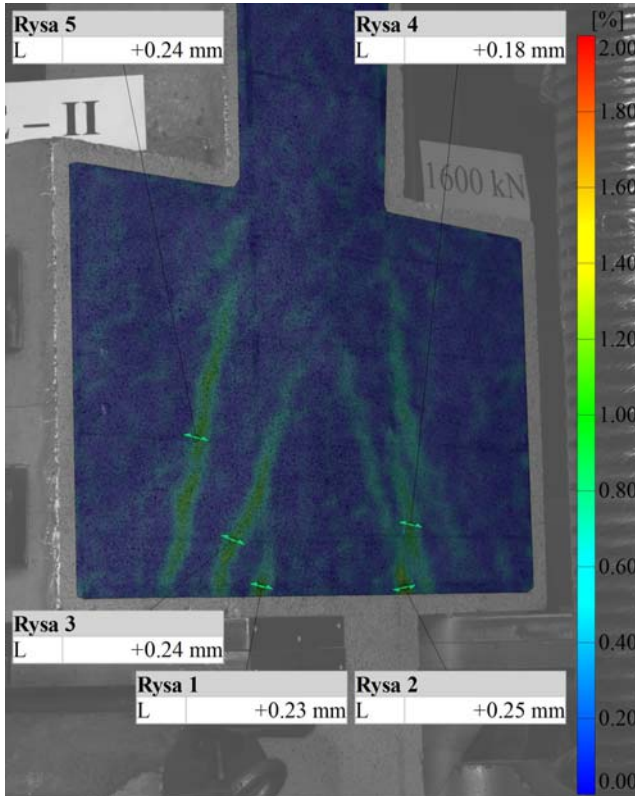

Układ rys przy sile 1100kN / Crack pattern at 1100kN

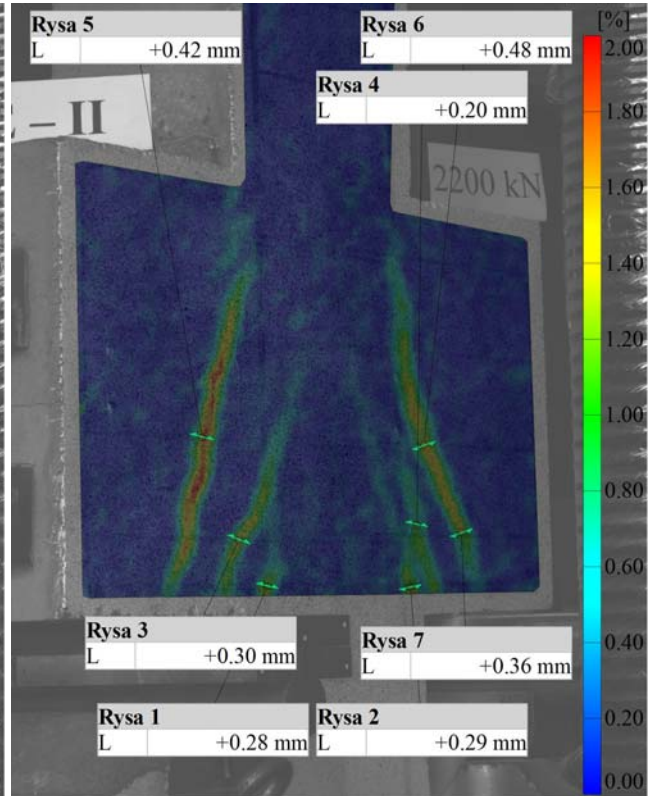

Układ rys przy sile 1350kN / Crack pattern at 1350kN

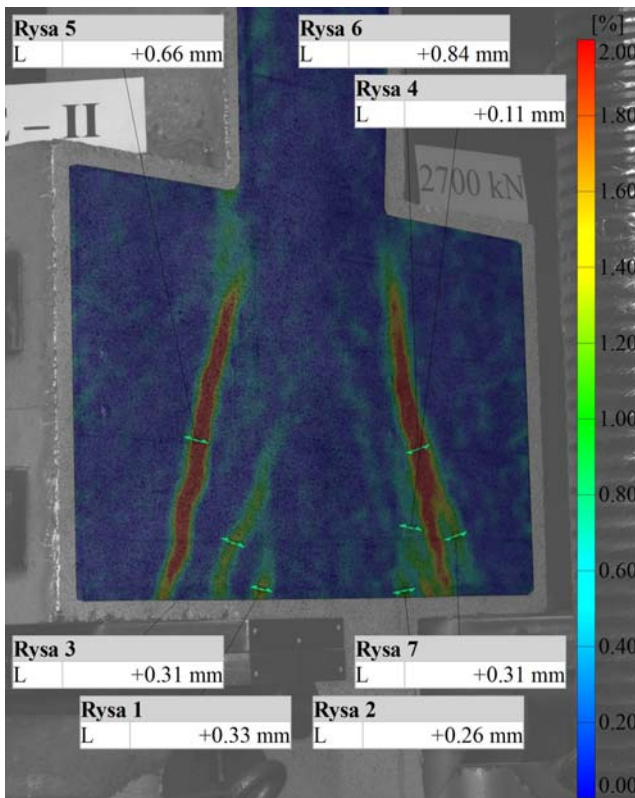

Układ rys przy sile 1353kN / Crack pattern at 1353kN

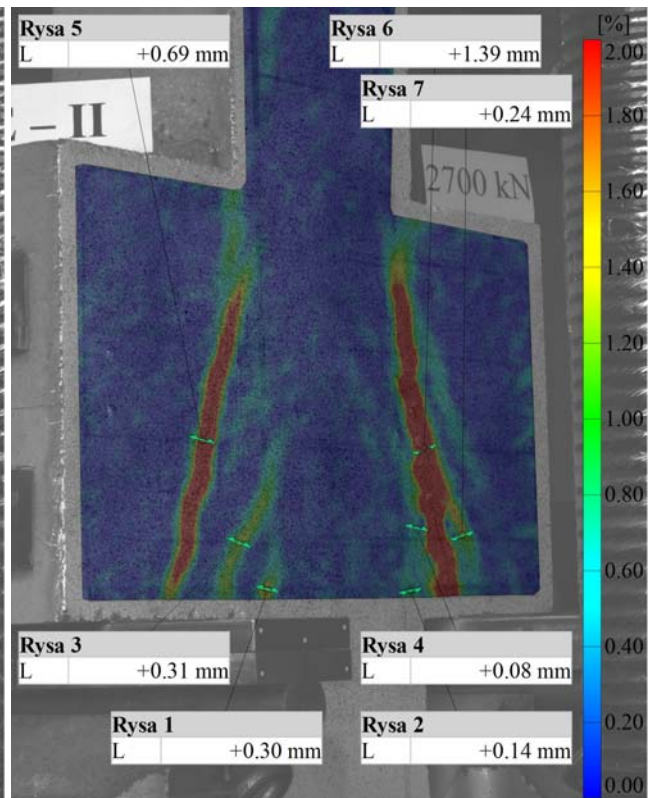

E-II



Powierzchnia boczna po zniszczeniu
Side surface after failure

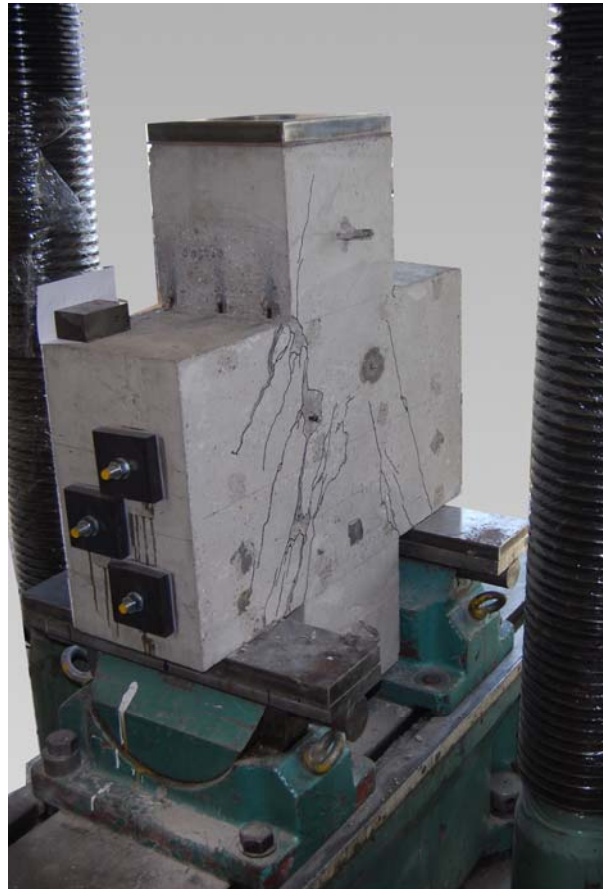

Wspornik po zniszczeniu w stanowisku
Corbel after failure in test setup

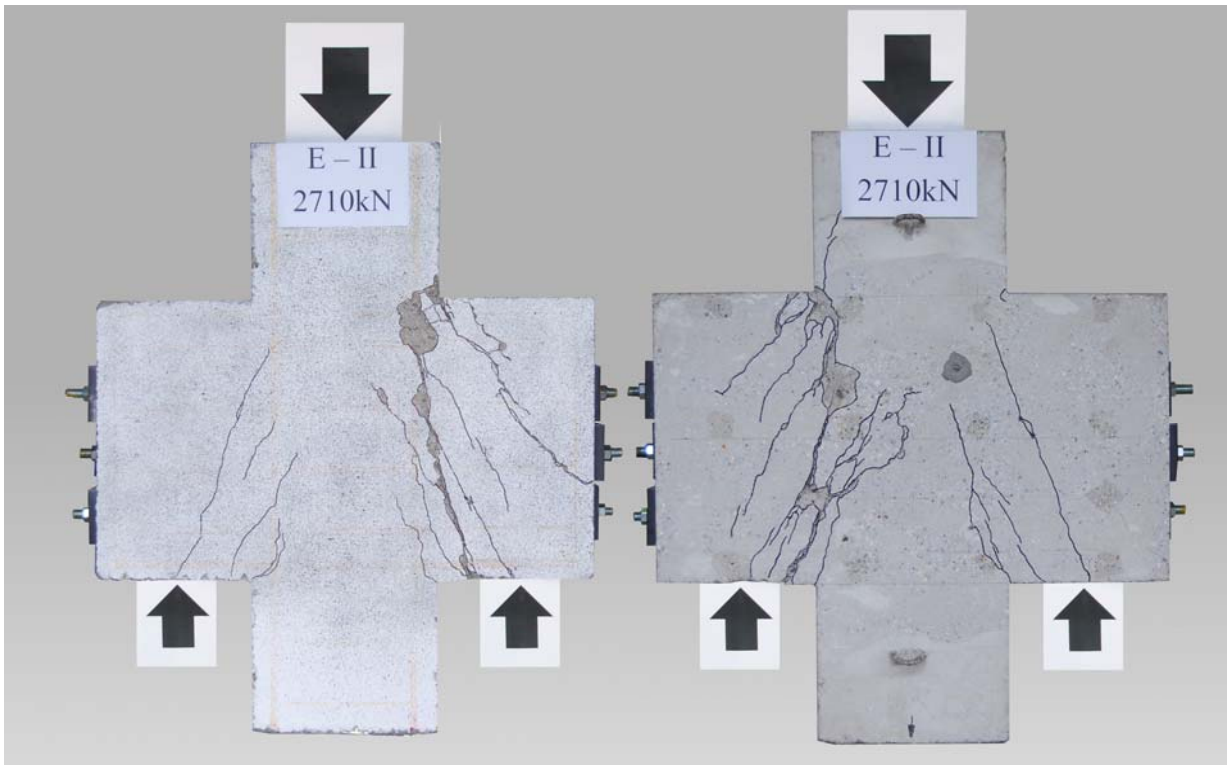

Wspornik po zniszczeniu / Corbel after failure

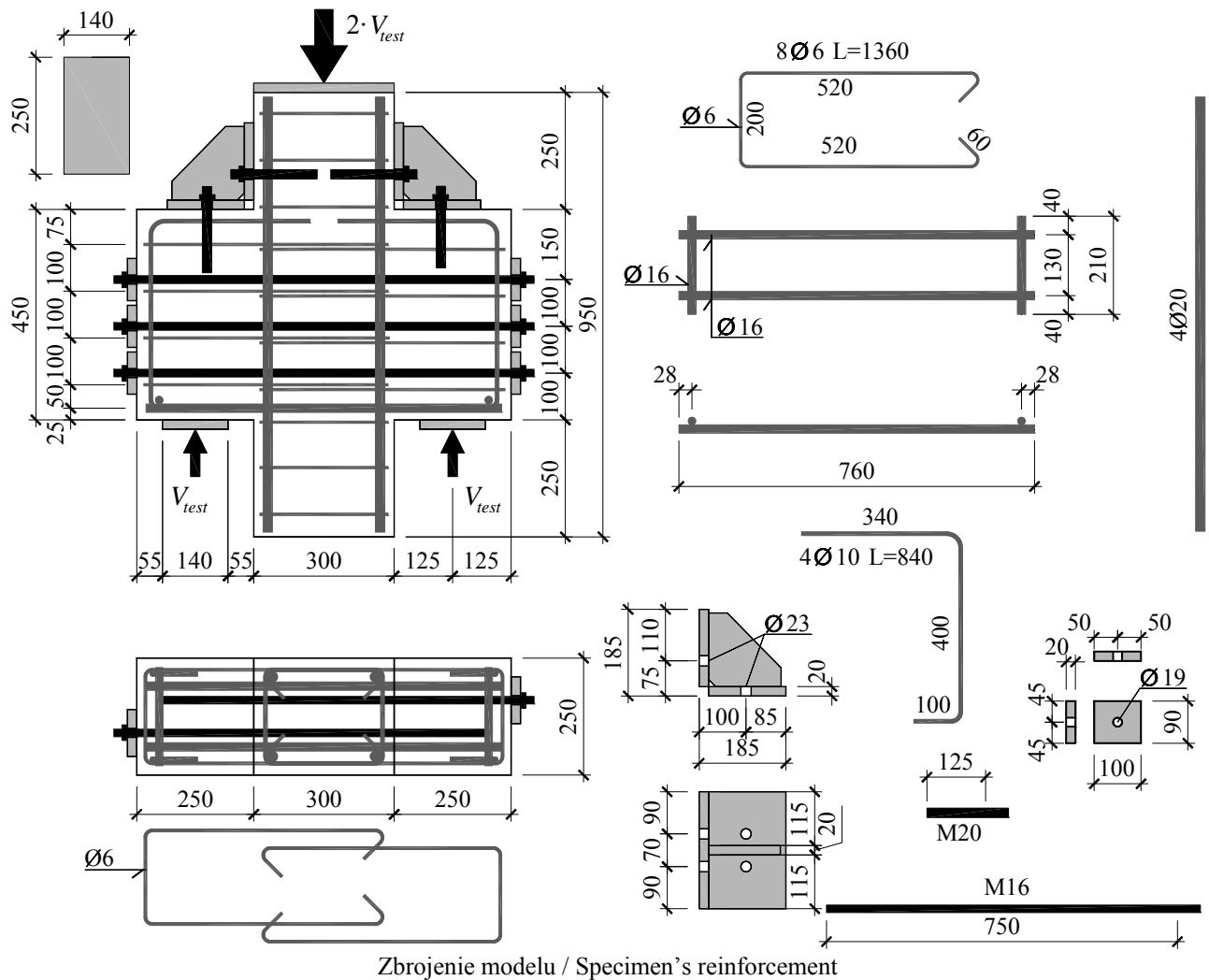

Wytrzymałość betonu na ściskanie / Compressive strength of concrete

$$f_{cm} = 47,3 \text{ MPa}$$

Moduł sprężystości podłużnej / Young's modulus

$$E_{cm} = 28,2 \text{ GPa}$$

Wytrzymałość betonu na rozciąganie przy rozłupywaniu / Tensile splitting strength of concrete

$$f_{ct,sp} = 3,9 \text{ MPa}$$

Gęstość betonu płyty / Density of slab concrete

$$\rho = 2220 \text{ kg/m}^3$$

Charakterystyka zbrojenia / Characteristics of the reinforcement

Ø6

$$A_s = 28,07 \text{ mm}^2, f_{ym} = 385,6 \text{ MPa}, f_{tm} = 487,6 \text{ MPa}$$

Ø16

$$A_s = 200,53 \text{ mm}^2, f_{ym} = 533,6 \text{ MPa}, f_{tm} = 638,5 \text{ MPa}$$

Ø20

$$A_s = 310,67 \text{ mm}^2, f_{ym} = 541,0 \text{ MPa}, f_{tm} = 640,4 \text{ MPa}$$

M16

$$A_s = 141,05 \text{ mm}^2, f_{ym} = 827,3 \text{ MPa}, f_{tm} = 953,1 \text{ MPa}$$

Siła niszcząca / Failure force

$$V_{test} = 1558 \text{ kN}$$

E-III

Beton – odkształcenia po stronie S i N (na wsporniku) (ε_c) / Concrete – strains on S and N side (on the corbel) (ε_c)

obciążenie wspornika corbel load	odkształcenie S S strain				odkształcenie N N strain			
	1	2	3	średnia/ average	4	5	6	średnia/ average
kN	‰	‰	‰	‰	‰	‰	‰	‰
0	0,000	0,000	0,000	0,000	0,000	0,000	0,000	0,000
0	0,000	0,000	0,000	0,000	0,002	0,000	0,000	0,001
50	-0,007	-0,010	-0,018	-0,012	0,001	-0,012	-0,011	-0,007
100	-0,014	-0,025	-0,049	-0,029	-0,004	-0,038	-0,040	-0,027
150	-0,020	-0,049	-0,096	-0,055	-0,022	-0,083	-0,089	-0,065
200	-0,036	-0,087	-0,166	-0,096	-0,057	-0,152	-0,157	-0,122
250	-0,053	-0,123	-0,252	-0,143	-0,066	-0,205	-0,212	-0,161
300	-0,074	-0,164	-0,354	-0,197	-0,084	-0,248	-0,255	-0,196
350	-0,081	-0,181	-0,461	-0,241	-0,117	-0,289	-0,311	-0,239
400	-0,086	-0,190	-0,535	-0,270	-0,138	-0,330	-0,367	-0,278
450	-0,090	-0,200	-0,597	-0,296	-0,159	-0,370	-0,410	-0,313
500	-0,096	-0,214	-0,657	-0,322	-0,189	-0,409	-0,493	-0,364
500	-1,582		-2,526	-2,054				
500	-1,408		-2,493	-1,951				
500	-1,613		-2,936	-2,275				
500	-1,594		-3,301	-2,448				
550	-1,579		-3,382	-2,481				
600	-1,563		-3,407	-2,485				
650	-1,550		-3,431	-2,491				
700	-1,474		-3,444	-2,459				
750	-1,416		-3,448	-2,432				
800	-1,334		-3,462	-2,398				
850	-1,261		-3,471	-2,366				
900	-1,179		-3,506	-2,343				
950	-1,093		-3,550	-2,322				
1000	-1,454		-3,601	-2,528				
1050	-1,751		-3,654	-2,703				
1100	-1,879		-3,739	-2,809				
1150	-1,965		-3,803	-2,884				
1200	-1,952		-3,863	-2,908				
1250	-1,769		-3,776	-2,773				
1300	-1,739		-3,782	-2,761				
1350	-1,727		-3,811	-2,769				
1400	-1,692		-3,880	-2,786				
1450	-1,671		-3,918	-2,795				
1500	-1,637		-3,969	-2,803				
1550	-1,647		-4,034	-2,841				
1550	-1,655		-4,057	-2,856				
1558	-1,658		-4,066	-2,862				
1509	-1,704		-4,094	-2,899				
1263	-1,705		-4,111	-2,908				
999	-1,795		-4,172	-2,984				
707	-1,862		-4,345	-3,104				

Beton – odkształcenia po stronie S i N (na wsporniku) (ϵ_c) / Concrete – strains on S and N side (on the corbel) (ϵ_c)

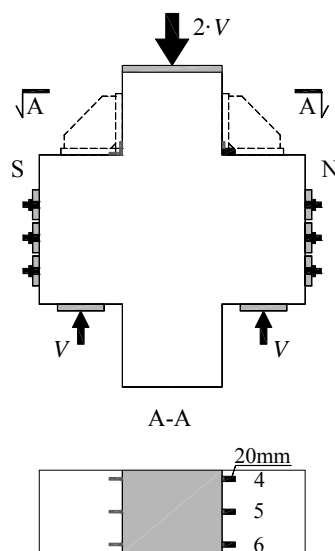
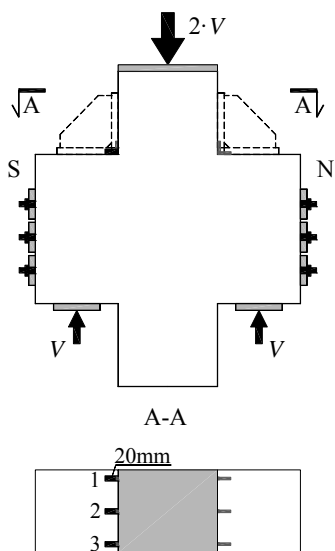
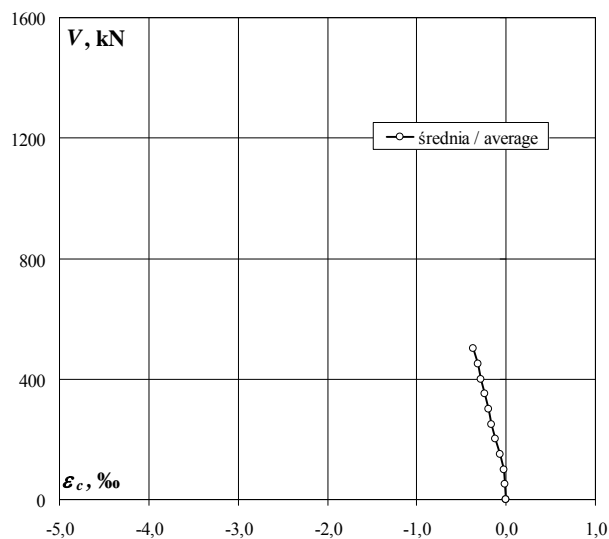
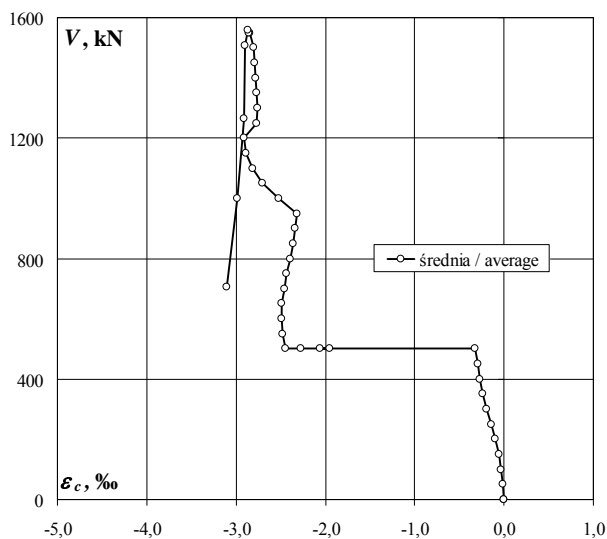
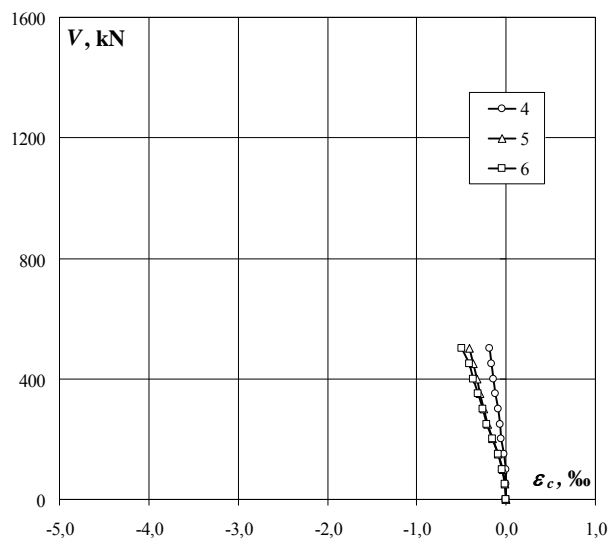
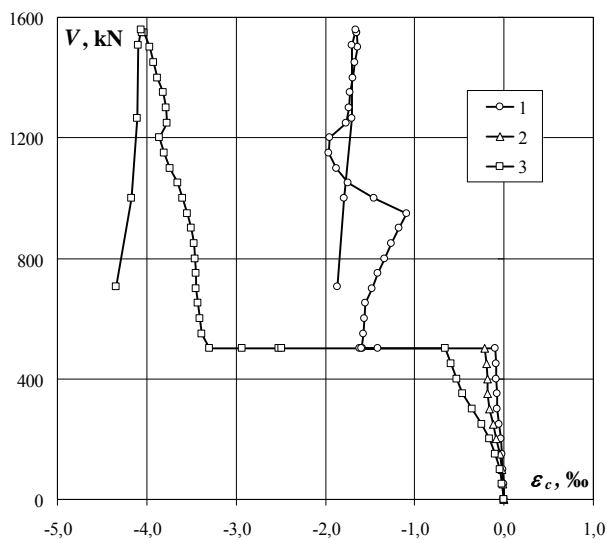

E-III

Beton – odkształcenia po stronie S i N (na słupie) (ε_c) / Concrete – strains on S and N side (on the column) (ε_c)

obciążenie wspornika corbel load	odkształcenie S S strain				odkształcenie N N strain			
	7	8	9	średnia/ average	10	11	12	średnia/ average
kN	‰	‰	‰	‰	‰	‰	‰	‰
0	0,000	0,000	0,000	0,000	0,000	0,000	0,000	0,000
0	0,000	0,000	0,002	0,001	0,004	0,000	0,002	0,002
50	0,000	-0,012	-0,030	-0,014	-0,512	-0,114	-0,251	-0,292
100	-0,003	-0,039	-0,077	-0,040	-0,985	-0,261	-0,461	-0,569
150	-0,012	-0,081	-0,132	-0,075	-1,355	-0,396	-0,638	-0,796
200	-0,033	-0,132	-0,201	-0,122	-1,654	-0,518	-0,824	-0,999
250	-0,072	-0,182	-0,280	-0,178	-1,913	-0,638	-1,038	-1,196
300	-0,126	-0,238	-0,364	-0,243	-2,178	-0,770	-1,270	-1,406
350	-0,196	-0,307	-0,467	-0,323	-2,449	-0,916	-1,548	-1,638
400	-0,275	-0,367	-0,557	-0,400	-2,693	-1,040	-1,833	-1,855
450	-0,349	-0,428	-0,639	-0,472	-2,895	-1,152	-2,124	-2,057
500	-0,414	-0,494	-0,719	-0,542	-3,101	-1,259	-2,431	-2,264
500	-1,244	-1,458		-1,351	-3,640		-4,528	-4,084
500	-1,433	-3,057		-2,245	-3,082		-4,976	-4,029
500	-2,088	-3,259		-2,674	-3,154		-5,096	-4,125
500	-2,421	-3,000		-2,711	-3,160		-5,468	-4,314
550	-2,719	-3,049		-2,884	-3,227		-5,541	-4,384
600	-2,800	-3,177		-2,989	-3,317		-5,613	-4,465
650	-2,736	-3,164		-2,950	-3,425		-5,686	-4,556
700	-3,229	-3,244		-3,237	-3,562		-5,784	-4,673
750	-3,861	-3,340		-3,601	-3,826		-5,971	-4,899
800	-4,007	-3,548		-3,778	-4,017		-6,117	-5,067
850	-3,537	-3,648		-3,593	-4,168		-6,244	-5,206
900	-3,483	-3,761		-3,622	-4,328		-6,417	-5,373
950	-3,570	-3,725		-3,648	-4,484		-6,552	-5,518
1000	-3,719	-3,767		-3,743	-4,668		-6,720	-5,694
1050	-4,357	-3,841		-4,099	-4,867		-6,870	-5,869
1100	-3,957	-3,924		-3,941	-5,056		-7,071	-6,064
1150	-4,130	-3,999		-4,065	-5,274		-7,242	-6,258
1200	-4,667	-4,077		-4,372	-5,481		-7,445	-6,463
1250	-5,003	-4,268		-4,636	-5,620		-7,608	-6,614
1300	-5,325			-5,325	-5,809		-7,823	-6,816
1350	-5,297			-5,297	-6,021		-8,117	-7,069
1400	-5,568			-5,568	-6,524		-9,424	-7,974
1450	-5,574			-5,574			-9,760	-9,760
1500	-5,807			-5,807			-7,860	-7,860
1550	-5,903			-5,903			-7,401	-7,401
1550	-5,865			-5,865			-7,482	-7,482
1558	-5,851			-5,851			-7,528	-7,528
1509	-5,809			-5,809				
1263	-5,910			-5,910				
999	-5,748			-5,748				
707	-5,484			-5,484				

Beton – odkształcenia po stronie S i N (na słupie) (ϵ_c) / Concrete – strains on S and N side (on the column) (ϵ_c)

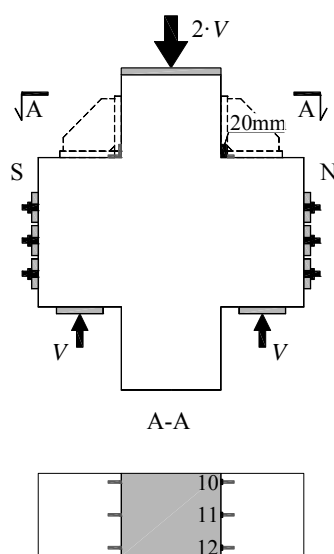
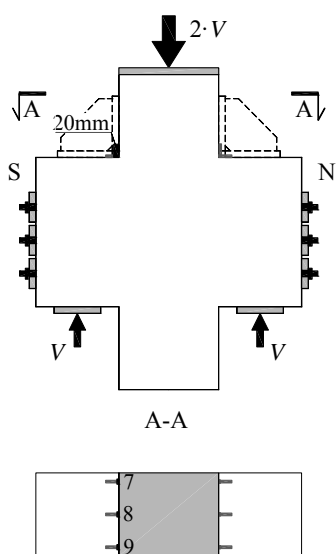
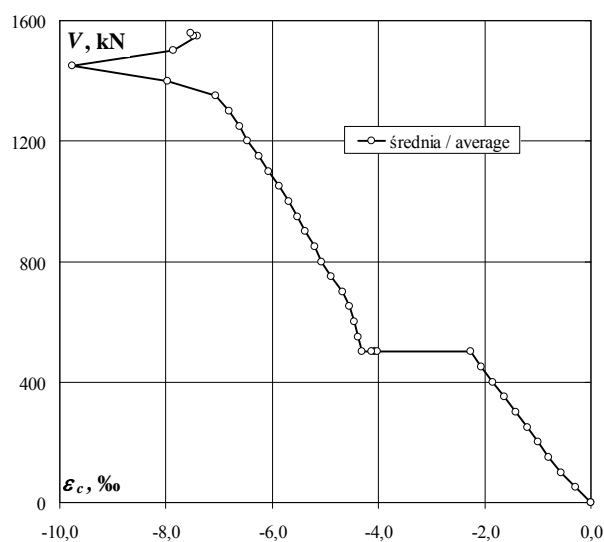
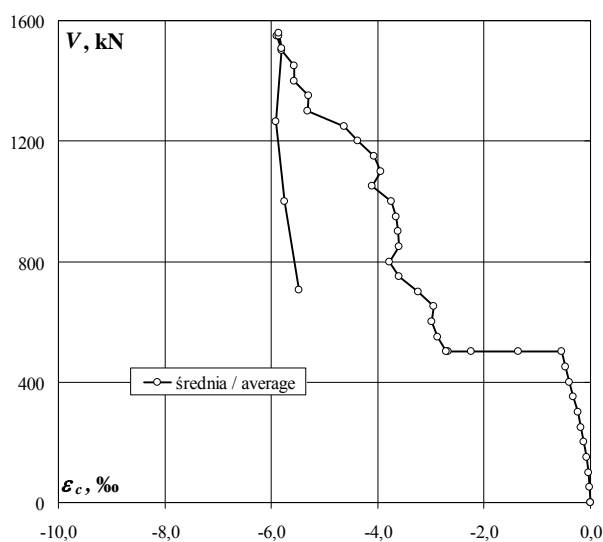
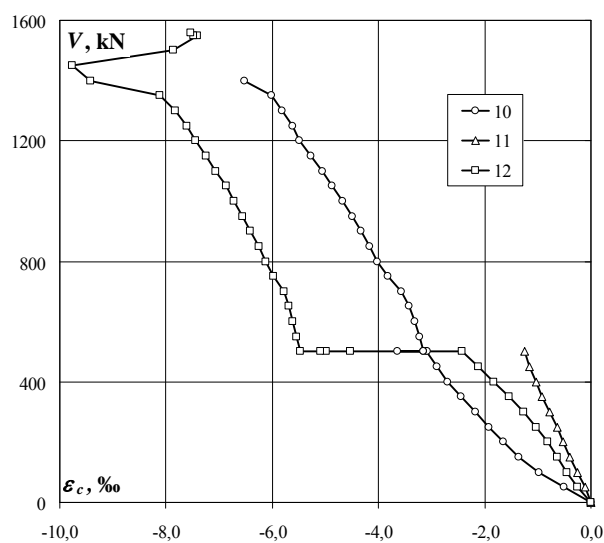
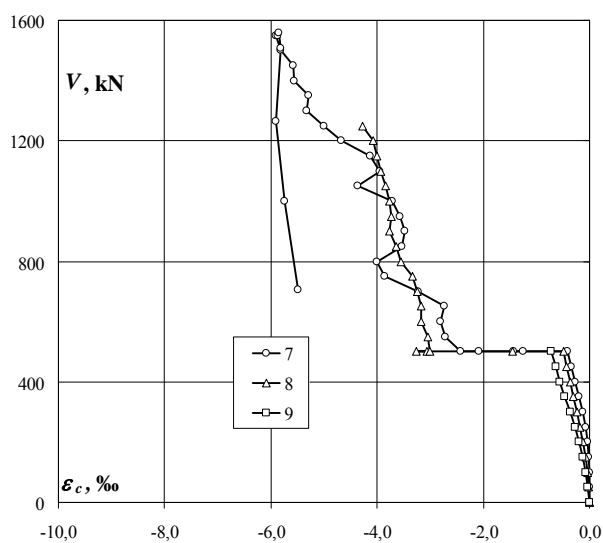

E-III

Zbrojenie główne – odkształcenia po stronie S i N (ε_s) / Main reinforcement – strains on S and N side (ε_s)

obciążenie wspornika corbel load	odkształcenie S S strain			odkształcenie N N strain		
	1	2	średnia/ average	3	4	średnia/ average
	%	%	%	%	%	%
0	0,000	0,000	0,000	0,000	0,000	0,000
0	0,000	0,000	0,000	-0,001	0,000	-0,001
50	0,013	0,012	0,013	0,018	0,016	0,017
100	0,040	0,027	0,034	0,080	0,043	0,062
150	0,064	0,041	0,053	0,204	0,130	0,167
200	0,078	0,052	0,065	0,449	0,424	0,437
250	0,159	0,123	0,141	0,686	0,686	0,686
300	0,442	0,430	0,436	0,783	0,798	0,791
350	0,825	0,852	0,839	0,873	0,854	0,864
400	1,078	1,045	1,062	0,987	0,979	0,983
450	1,256	1,188	1,222	1,118	1,125	1,122
500	1,435	1,317	1,376	1,250	1,253	1,252
500	1,178	1,385	1,282	1,374	1,328	1,351
500	0,915	1,432	1,174	1,449	1,360	1,405
500	0,489	1,415	0,952	1,234		1,234
500	0,354	1,416	0,885	1,284		1,284
550	0,401	1,454	0,928	1,317		1,317
600	0,441	1,501	0,971	1,380		1,380
650	0,496	1,557	1,027	1,449		1,449
700	0,602	1,653	1,128	1,459		1,459
750	0,622	1,657	1,140	1,563		1,563
800	0,668	1,703	1,186	1,595		1,595
850	0,715	1,746	1,231	1,637		1,637
900	0,767	1,791	1,279	1,679		1,679
950	0,813	1,846	1,330	1,716		1,716
1000	0,860	1,895	1,378	1,759		1,759
1050	0,914	1,947	1,431	1,803		1,803
1100	0,963	2,003	1,483	1,846		1,846
1150	1,012	2,059	1,536	1,890		1,890
1200	1,037	2,139	1,588	1,934		1,934
1250	1,126	2,253	1,690	1,984		1,984
1300	1,258	2,330	1,794	2,031		2,031
1350	1,298	2,415	1,857	2,078		2,078
1400	1,344	2,540	1,942	2,141		2,141
1450	1,374	2,751	2,063	2,434		2,434
1500	1,405	3,065	2,235	2,700		2,700
1550	1,474	3,546	2,510	2,935		2,935
1550	1,555	3,751	2,653	2,959		2,959
1558	1,561	3,852	2,707	2,965		2,965
1509	1,500	3,820	2,660	1,617		1,617
1263	1,273	3,502	2,388	-0,798		-0,798
999	1,105	3,342	2,224	-0,736		-0,736
707	0,883	3,105	1,994			

Zbrojenie główne – odkształcenia po stronie S i N (ϵ_s) / Main reinforcement – strains on S and N side (ϵ_s)

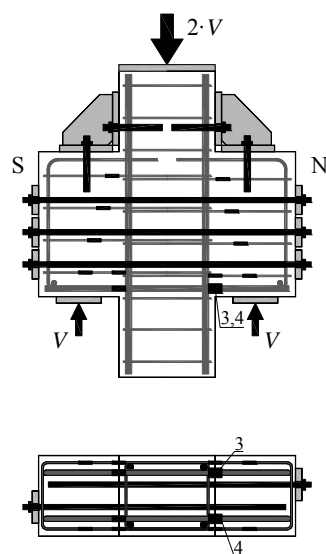
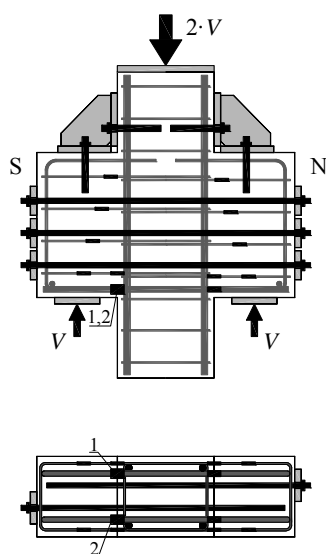
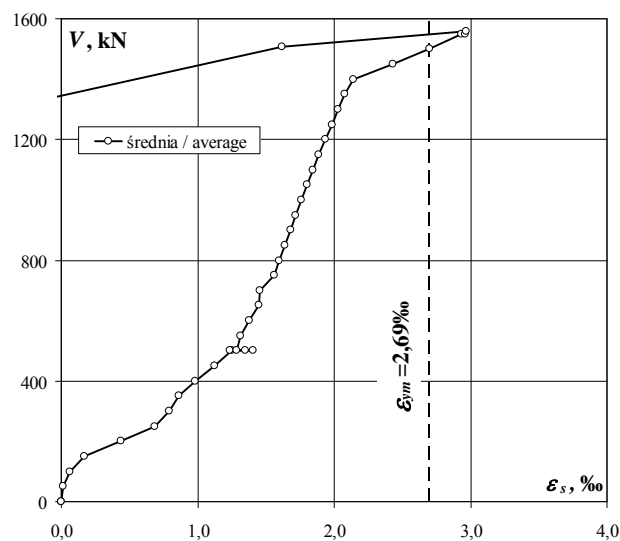
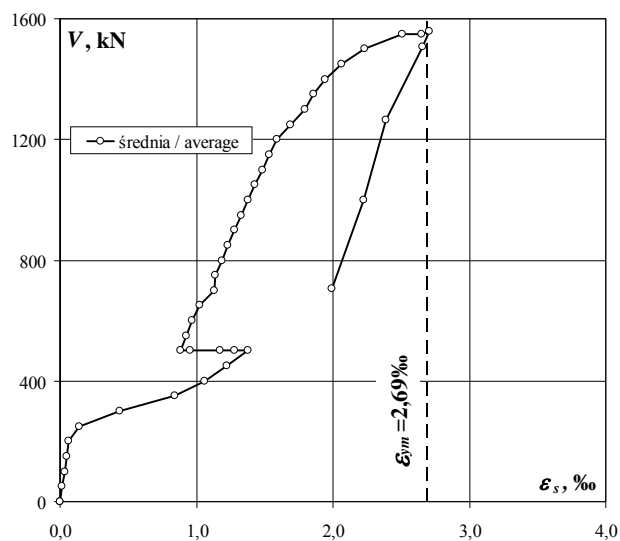
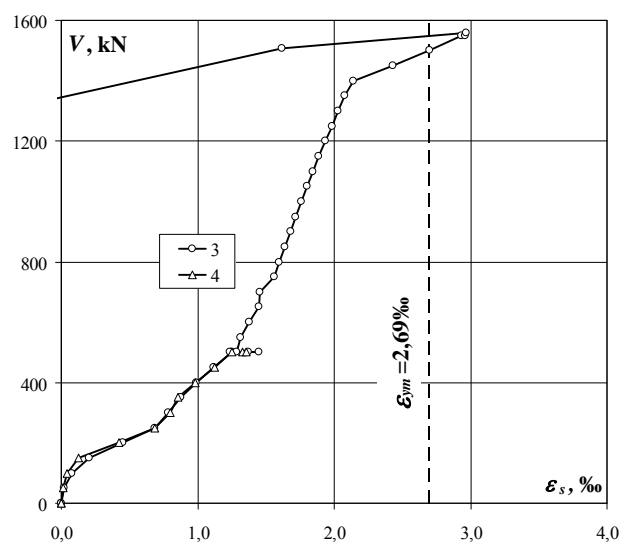
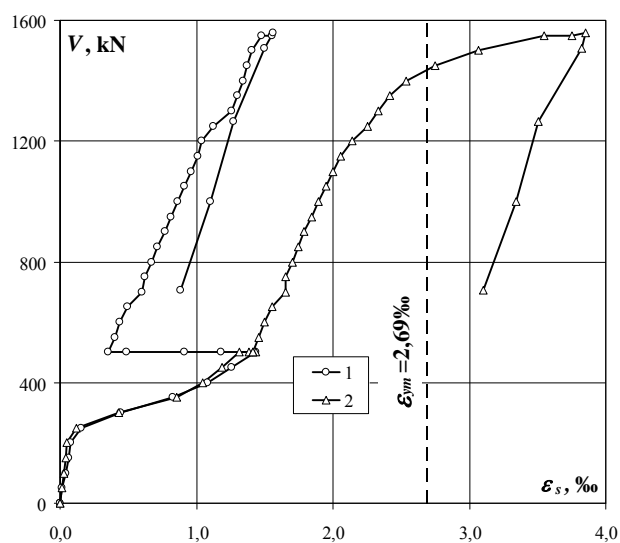

E-III

Strzeżnię 1a – odkształcenia po stronie S i N (ϵ_s) / Stirrup 1a – strains on S and N side (ϵ_s)

obciążenie wspornika corbel load	odkształcenie S S strain			odkształcenie N N strain		
	5	6	średnia/ average	7	8	średnia/ average
	%	%	%	%	%	%
kN						
0	0,000	0,000	0,000	0,000		
0	0,000	0,000	0,000	0,000		
50	0,007	0,006	0,007	0,012		
100	0,020	0,010	0,015	0,041		
150	0,032	0,023	0,028	0,103		
200	0,044	0,031	0,038	0,357		
250	0,086	0,063	0,075	0,571		
300	0,378	0,281	0,330	0,668		
350	0,731	0,679	0,705	0,744		
400	0,840	0,929	0,885	0,822		
450	0,944	1,125	1,035	0,897		
500	1,077	1,308	1,193	0,978		
500	1,139	1,377	1,258	1,130		
500	1,103	1,287	1,195	1,183		
500	1,023		1,023	1,201		
500	0,950		0,950	1,284		
550	1,012		1,012	1,332		
600	1,069		1,069	1,390		
650	1,128		1,128	1,458		
700	1,004		1,004	1,489		
750	1,025		1,025	1,599		
800	1,072		1,072	1,672		
850	1,123		1,123	1,736		
900	1,174		1,174	1,812		
950	1,226		1,226	1,865		
1000	1,280		1,280	1,927		
1050	1,339		1,339	1,992		
1100	1,396		1,396	2,056		
1150	1,426		1,426	2,085		
1200	1,483		1,483	2,115		
1250	1,552		1,552	2,108		
1300	1,608		1,608	2,111		
1350	1,655		1,655	2,111		
1400	1,705		1,705	2,088		
1450	1,715		1,715	2,091		
1500	1,755		1,755	2,073		
1550	1,789		1,789	2,091		
1550	1,787		1,787	2,113		
1558	1,787		1,787	2,109		
1509	1,749		1,749	1,289		
1263	1,563		1,563	2,396		
999	1,336		1,336	2,440		
707	0,998		0,998	2,252		

Strzemię 1a – odkształcenia po stronie S i N (ϵ_s) / Stirrup 1a – strains on S and N side (ϵ_s)

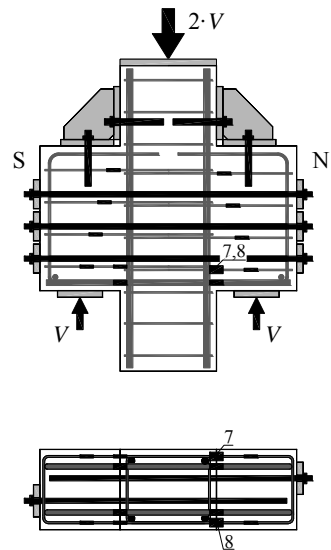
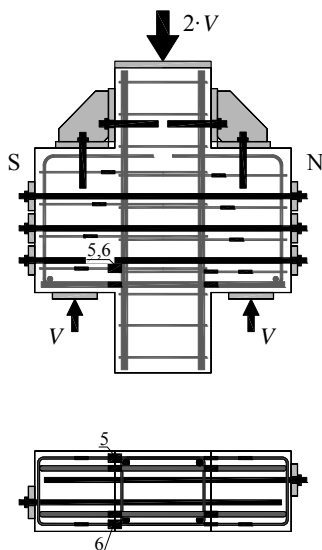
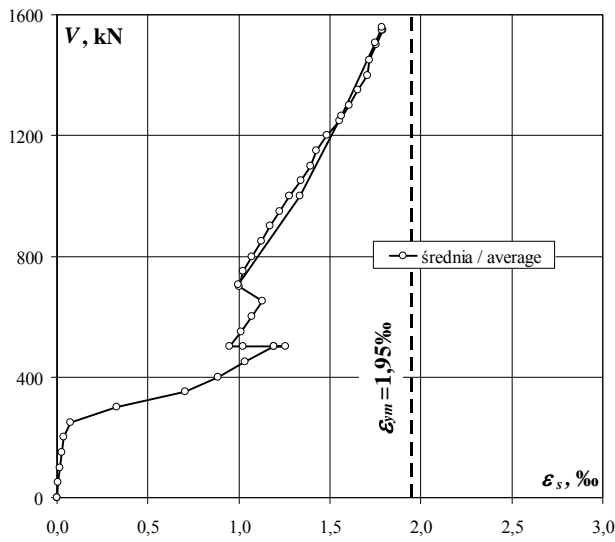
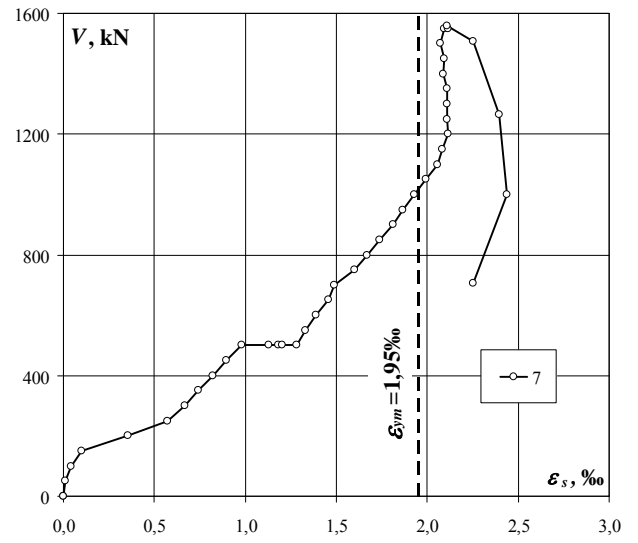
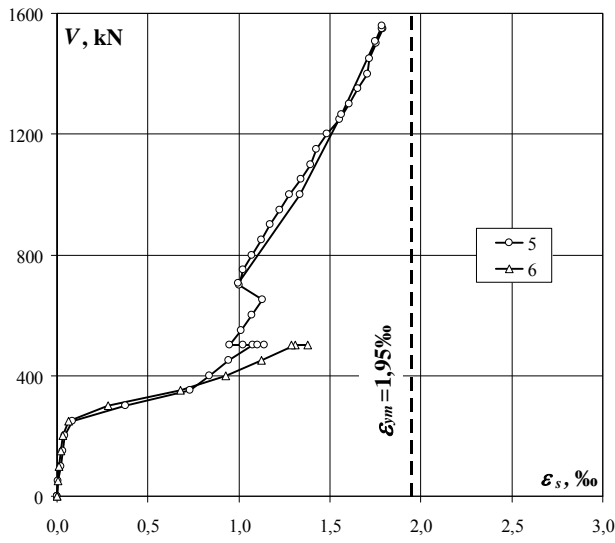

E-III

Strzeżenie 1b – odkształcenia po stronie S i N (ϵ_s) / Stirrup 1b – strains on S and N side (ϵ_s)

obciążenie wspornika corbel load	odkształcenie S S strain			odkształcenie N N strain		
	9	10	średnia/ average	11	12	średnia/ average
kN	‰	‰	‰	‰	‰	‰
0	0,000	0,000	0,000	0,000	0,000	0,000
0	0,000	0,000	0,000	0,000	0,000	0,000
50	0,010	0,015	0,013	0,012	0,013	0,013
100	0,018	0,036	0,027	0,027	0,029	0,028
150	0,027	0,055	0,041	0,040	0,043	0,042
200	0,033	0,073	0,053	0,049	0,051	0,050
250	0,037	0,086	0,062	0,061	0,059	0,060
300	0,045	0,093	0,069	0,080	0,069	0,075
350	0,114	0,098	0,106	0,096	0,082	0,089
400	0,316	0,108	0,212	0,126	0,094	0,110
450	0,411	0,120	0,266	0,180	0,104	0,142
500	0,497	0,133	0,315	0,269	0,112	0,191
500	0,583	0,105	0,344	0,435	0,114	0,275
500	0,629	0,010	0,320	0,453	0,095	0,274
500	0,600		0,600	0,328		0,328
500	0,612		0,612	0,229		0,229
550	0,618		0,618	0,231		0,231
600	0,629		0,629	0,240		0,240
650	0,643		0,643	0,250		0,250
700	0,939		0,939	0,260		0,260
750	0,977		0,977	0,236		0,236
800	1,028		1,028	0,120		0,120
850	1,105		1,105	0,095		0,095
900	1,167		1,167	0,067		0,067
950	1,217		1,217	0,054		0,054
1000	1,268		1,268	0,038		0,038
1050	1,318		1,318	0,024		0,024
1100	1,373		1,373	0,007		0,007
1150	1,370		1,370	-0,005		-0,005
1200	1,413		1,413	-0,019		-0,019
1250	1,486		1,486	-0,043		-0,043
1300	1,543		1,543	-0,058		-0,058
1350	1,592		1,592	-0,074		-0,074
1400	1,649		1,649			
1450	1,673		1,673			
1500	1,702		1,702			
1550	1,720		1,720			
1550	1,724		1,724			
1558	1,725		1,725			
1509	1,681		1,681			
1263	1,524		1,524			
999	1,439		1,439			
707	1,299		1,299			

Strzemię 1b – odkształcenia po stronie S i N (ϵ_s) / Stirrup 1b – strains on S and N side (ϵ_s)

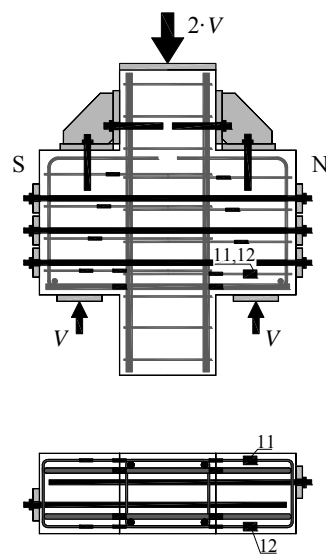
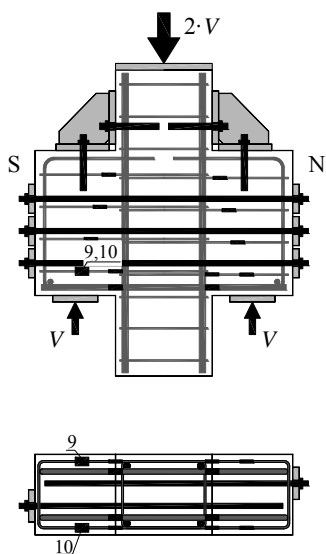
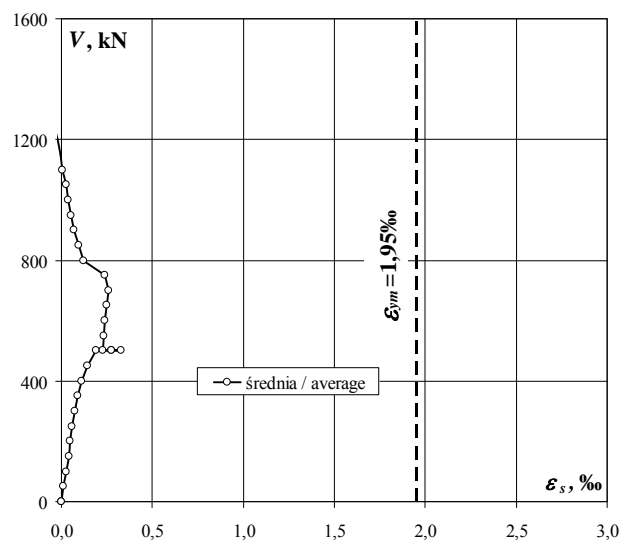
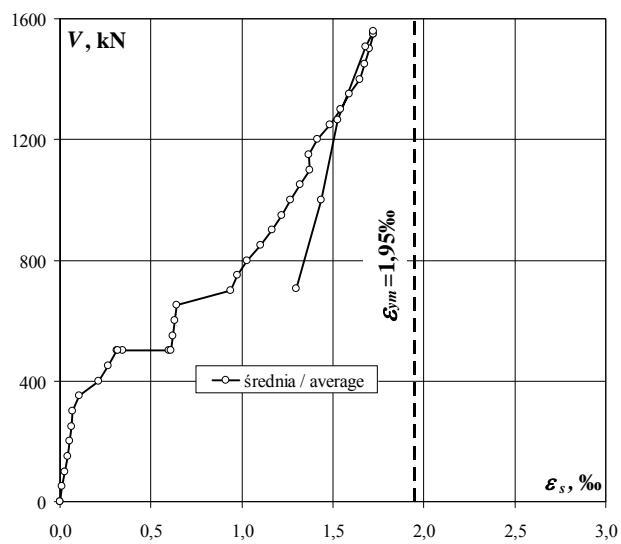
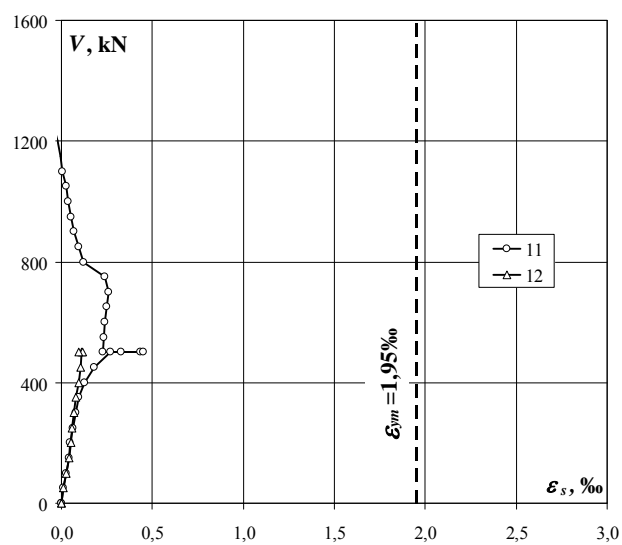
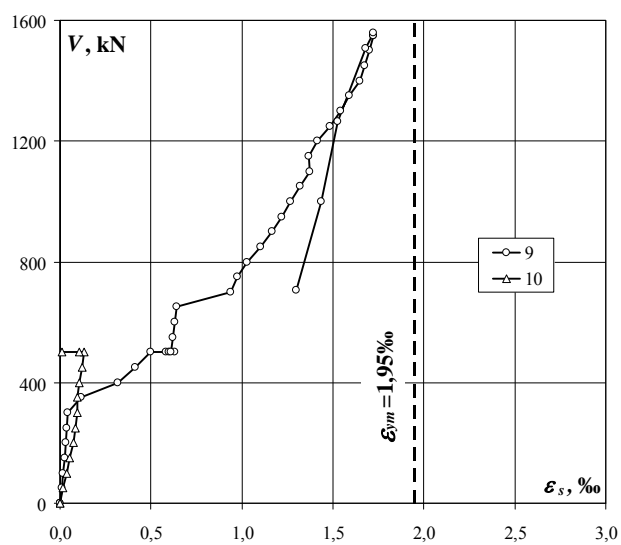

E-III

Strzemię 2 – odkształcenia po stronie S i N (ϵ_s) / Stirrup 2 – strains on S and N side (ϵ_s)

obciążenie wspornika corbel load	odkształcenie S S strain			odkształcenie N N strain		
	13	14	średnia/ average	15	16	średnia/ average
	%	%	%	%	%	%
0	0,000	0,000	0,000	0,000	0,000	0,000
0	0,000	-0,002	-0,001	0,000	0,000	0,000
50	0,004	0,001	0,003	0,007	0,007	0,007
100	0,008	0,017	0,013	0,020	0,014	0,017
150	0,016	0,031	0,024	0,035	0,031	0,033
200	0,031	0,049	0,040	0,046	0,048	0,047
250	0,042	0,068	0,055	0,047	0,050	0,049
300	0,045	0,075	0,060	0,055	0,056	0,056
350	0,045	0,081	0,063	0,064	0,066	0,065
400	0,051	0,090	0,071	0,073	0,076	0,075
450	0,061	0,098	0,080	0,081	0,082	0,082
500	0,073	0,107	0,090	0,090	0,087	0,089
500	0,089	0,156	0,123	0,103	0,136	0,120
500	0,162		0,162	0,152		0,152
500	0,108		0,108	0,219		0,219
500	0,005		0,005	0,173		0,173
550	0,012		0,012	0,179		0,179
600	0,014		0,014	0,184		0,184
650	0,031		0,031	0,195		0,195
700	0,403		0,403	0,218		0,218
750	0,441		0,441	0,541		0,541
800	0,494		0,494	0,584		0,584
850	0,528		0,528	0,622		0,622
900	0,589		0,589	0,672		0,672
950	0,637		0,637	0,706		0,706
1000	0,680		0,680	0,740		0,740
1050	0,734		0,734	0,771		0,771
1100	0,803		0,803	0,804		0,804
1150	0,861		0,861	0,829		0,829
1200	0,934		0,934	0,855		0,855
1250	0,928		0,928	0,872		0,872
1300	0,980		0,980	0,890		0,890
1350	1,029		1,029	0,902		0,902
1400	1,115		1,115	0,918		0,918
1450	1,139		1,139	1,164		1,164
1500	1,202		1,202	1,323		1,323
1550	1,282		1,282	1,433		1,433
1550	1,299		1,299	1,450		1,450
1558	1,299		1,299	1,461		1,461
1509	1,321		1,321	1,383		1,383
1263	1,214		1,214	0,234		0,234
999	1,059		1,059	-0,026		-0,026
707	0,812		0,812	-0,087		-0,087

Strzemię 2 – odkształcenia po stronie S i N (ϵ_s) / Stirrup 2 – strains on S and N side (ϵ_s)

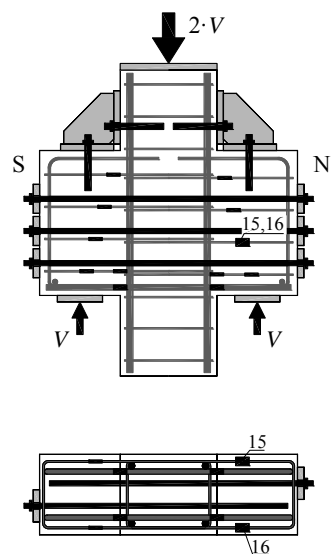
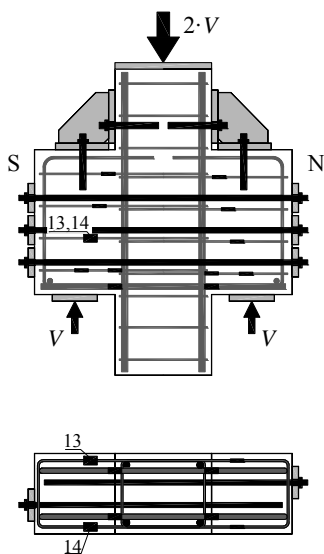
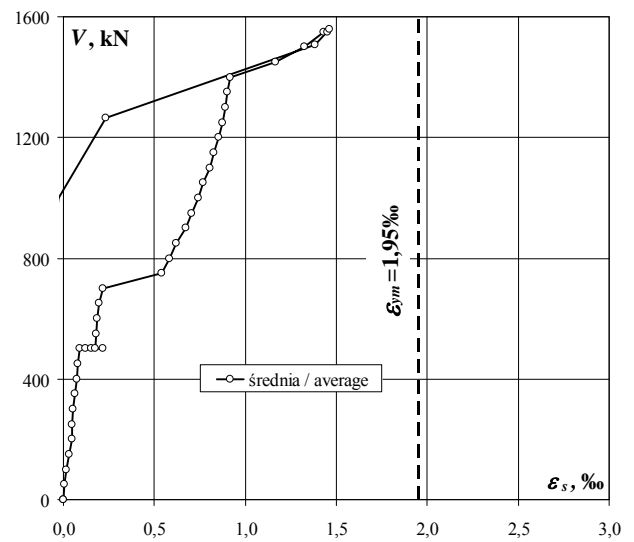
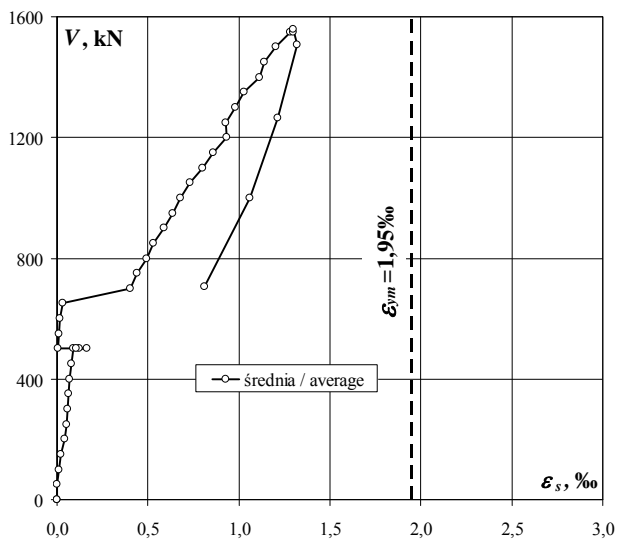
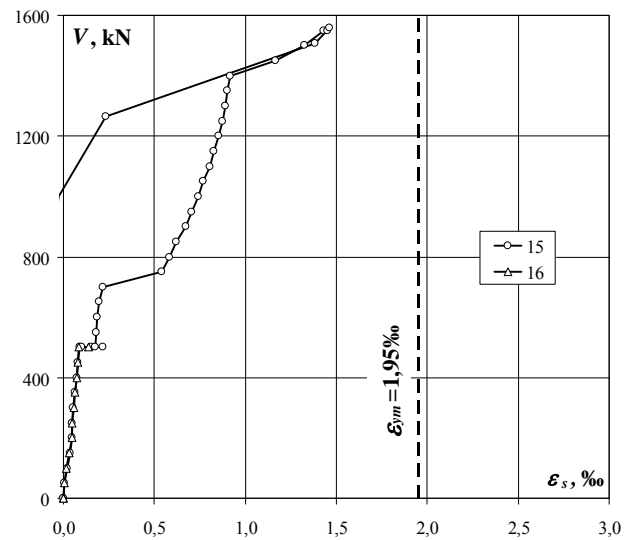
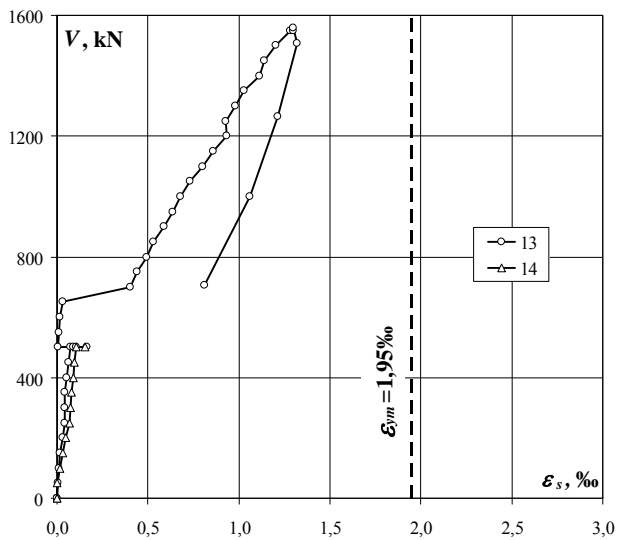

E-III

Strzemię 3 – odkształcenia po stronie S i N (ε_s) / Stirrup 3 – strains on S and N side (ε_s)

obciążenie wspornika corbel load	odkształcenie S S strain			odkształcenie N N strain		
	17	18	średnia/ average	19	20	średnia/ average
kN	‰	‰	‰	‰	‰	‰
0	0,000			0,000	0,000	0,000
0	-0,002			0,000	0,000	0,000
50	0,000			-0,002	0,000	-0,001
100	0,000			0,000	-0,001	-0,001
150	0,002			0,006	0,000	0,003
200	0,010			0,031	0,013	0,022
250	0,019			0,044	0,026	0,035
300	0,036			0,050	0,033	0,042
350	0,045			0,055	0,040	0,048
400	0,046			0,063	0,048	0,056
450	0,052			0,070	0,056	0,063
500	0,060			0,072	0,062	0,067
500	0,090			0,082	0,046	0,064
500	0,303			0,023		0,023
500	0,781			0,037		0,037
500	0,725			-0,016		-0,016
550	0,727			-0,012		-0,012
600	0,730			-0,003		-0,003
650	0,739			0,010		0,010
700	1,080			0,046		0,046
750	1,151			0,314		0,314
800	1,208			0,399		0,399
850	1,256			0,448		0,448
900	1,312			0,495		0,495
950	1,354			0,529		0,529
1000	1,379			0,563		0,563
1050	1,362			0,594		0,594
1100	1,360			0,630		0,630
1150	1,272			0,662		0,662
1200	1,292			0,694		0,694
1250	1,391			0,711		0,711
1300	1,472			0,738		0,738
1350	1,563			0,767		0,767
1400	1,709			0,816		0,816
1450	1,763			-1,400		-1,400
1500	1,898			-0,500		-0,500
1550	2,068			0,091		0,091
1550	2,105			0,243		0,243
1558	2,134			0,301		0,301
1509	2,191			0,033		0,033
1263	2,101			-0,472		-0,472
999	1,927			-0,677		-0,677
707	1,711			-0,854		-0,854

Strzemię 3 – odkształcenia po stronie S i N (ϵ_s) / Stirrup 3 – strains on S and N side (ϵ_s)

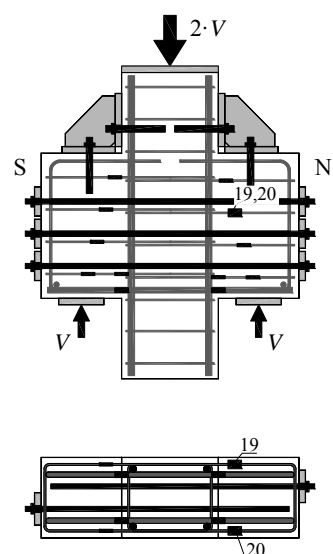
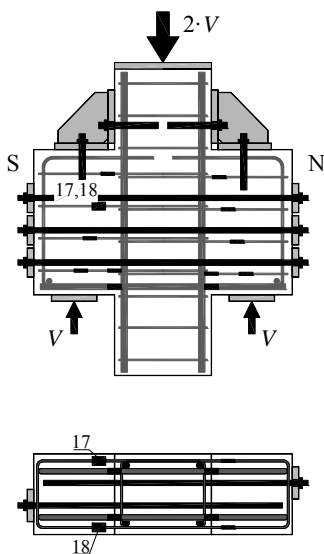
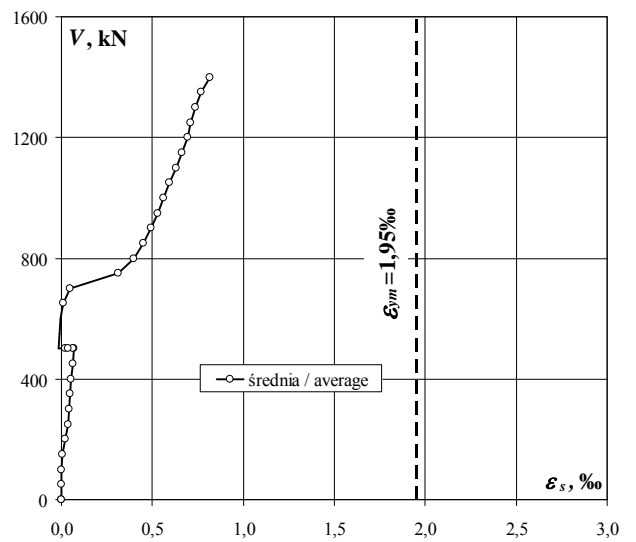
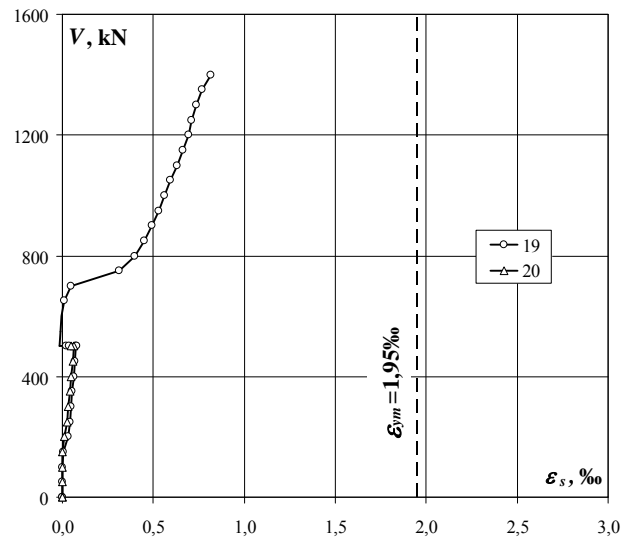
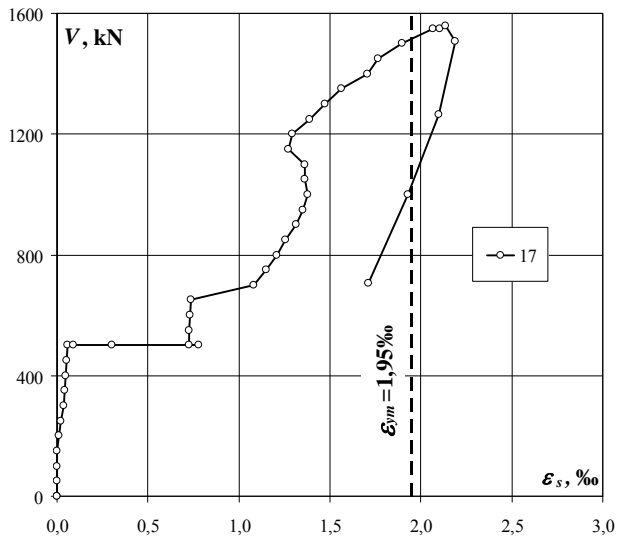

E-III

Strzemię 4 – odkształcenia po stronie S i N (ε_s) / Stirrup 4 – strains on S and N side (ε_s)

obciążenie wspornika corbel load	odkształcenie S S strain			odkształcenie N N strain		
	21	22	średnia/ average	23	24	średnia/ average
kN	‰	‰	‰	‰	‰	‰
0	0,000	0,000	0,000	0,000	0,000	0,000
0	-0,034	0,000	-0,017	0,000	0,000	0,000
50	-0,048	-0,010	-0,029	-0,009	-0,009	-0,009
100	-0,062	-0,021	-0,042	-0,020	-0,022	-0,021
150	-0,069	-0,033	-0,051	-0,030	-0,037	-0,034
200	-0,079	-0,045	-0,062	-0,041	-0,053	-0,047
250	-0,081	-0,056	-0,069	-0,037	-0,060	-0,049
300	-0,077	-0,062	-0,070	-0,036	-0,060	-0,048
350	-0,063	-0,054	-0,059	-0,033	-0,060	-0,047
400	-0,058	-0,053	-0,056	-0,033	-0,063	-0,048
450	-0,058	-0,051	-0,055	-0,033	-0,065	-0,049
500	-0,062	-0,048	-0,055	-0,029	-0,068	-0,049
500	-0,121	-0,049	-0,085	-0,022	-0,059	-0,041
500	-0,295		-0,295	-0,391		-0,391
500	-0,366		-0,366	-0,421		-0,421
500	-0,483		-0,483	-0,436		-0,436
550	-0,483		-0,483	-0,431		-0,431
600	-0,477		-0,477	-0,429		-0,429
650	-0,473		-0,473	-0,428		-0,428
700	-0,432		-0,432	-0,418		-0,418
750	-0,426		-0,426	-0,346		-0,346
800	-0,408		-0,408	-0,318		-0,318
850	-0,389		-0,389	-0,298		-0,298
900	-0,357		-0,357	-0,264		-0,264
950	-0,335		-0,335	-0,239		-0,239
1000	-0,300		-0,300	-0,210		-0,210
1050	-0,263		-0,263	-0,185		-0,185
1100	-0,194		-0,194	-0,159		-0,159
1150	-0,146		-0,146	-0,129		-0,129
1200	-0,037		-0,037	-0,099		-0,099
1250	0,142		0,142	-0,081		-0,081
1300	0,243		0,243	-0,053		-0,053
1350	0,310		0,310	-0,025		-0,025
1400	0,438		0,438	0,026		0,026
1450	0,455		0,455	0,461		0,461
1500	0,534		0,534	0,692		0,692
1550	0,615		0,615	0,801		0,801
1550	0,632		0,632	0,841		0,841
1558	0,653		0,653	0,857		0,857
1509	0,721		0,721	0,102		0,102
1263	0,693		0,693	1,813		1,813
999	0,559		0,559	1,659		1,659
707	0,392		0,392	1,455		1,455

Strzemię 4 – odkształcenia po stronie S i N (ϵ_s) / Stirrup 4 – strains on S and N side (ϵ_s)

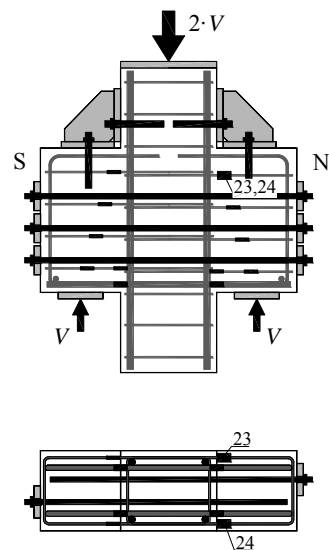
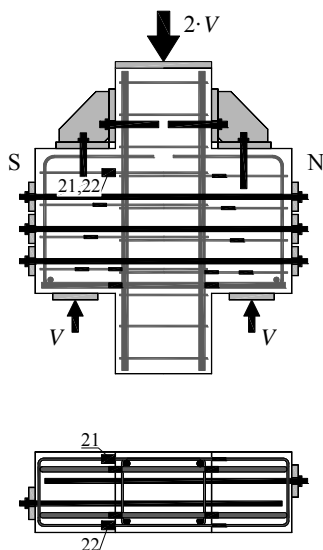
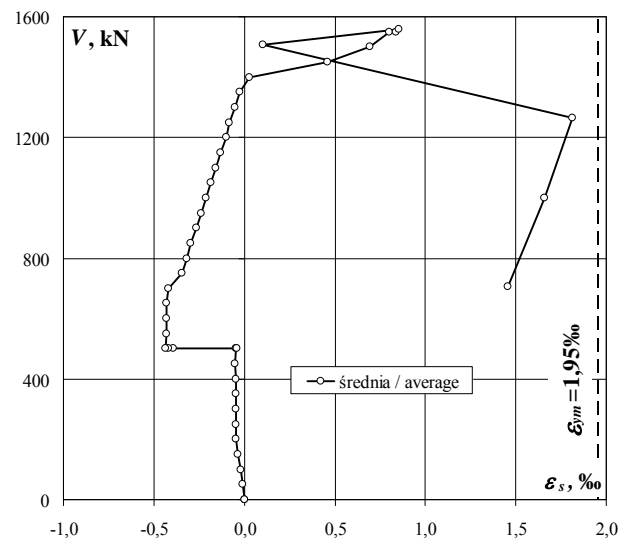
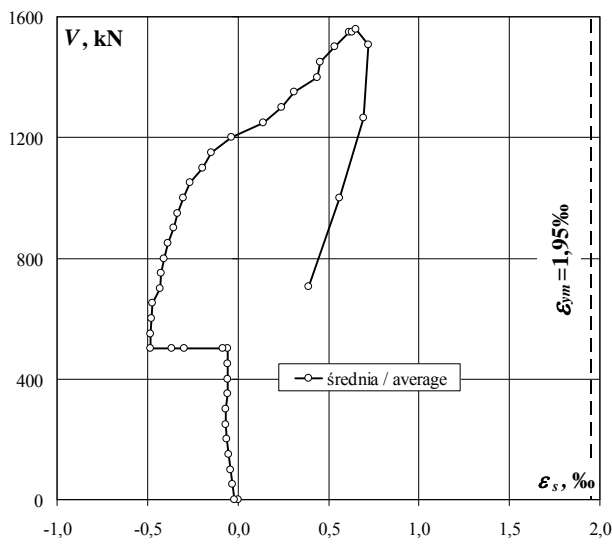
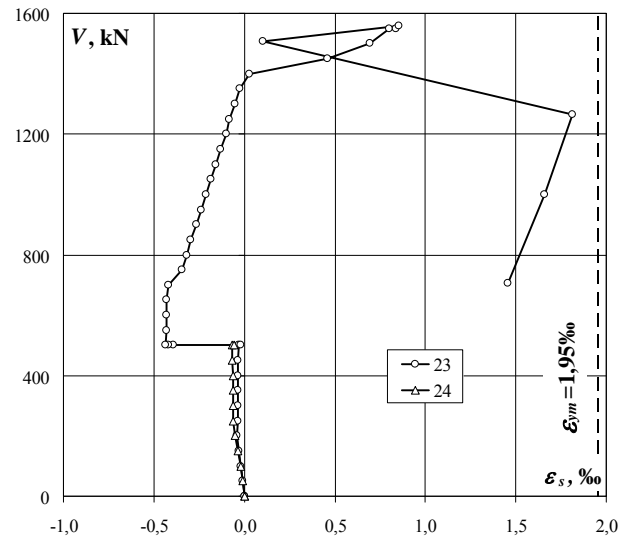
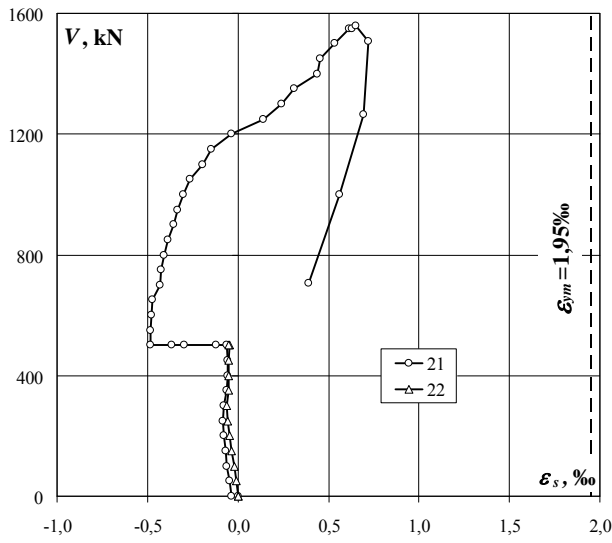

E-III

Odształcenia na pierwszym poziomie / Strains at the 1st level

obciążenie wspornika corbel load	przesunięcia wg ekstensometrów displacement acc to extensometers			obciążenie wspornika corbel load	przesunięcia wg systemu Aramis displacement acc to Aramis System		
	1	2	3		1'	2'	3'
kN	‰	‰	‰	kN	‰	‰	‰
0	0,000	0,000	0,000	0	0,00	0,00	0,00
0	0,000	-0,010	0,025	50	0,15	0,26	-0,19
50	0,010	-0,015	0,000	100	0,06	0,09	-0,12
100	0,065	0,015	0,005	150	0,08	0,11	-0,05
150	0,160	-0,015	0,005	200	0,37	0,23	-0,01
200	0,360	-0,015	0,000	250	0,54	0,17	-0,12
250	0,645	0,015	0,010	300	0,64	0,48	0,02
300	0,720	-0,015	0,020	350	0,79	0,64	0,09
350	0,815	-0,020	0,035	400	0,79	0,70	0,08
400	0,925	-0,020	0,140	450	1,02	0,79	0,09
450	1,060	-0,020	0,290	500	1,77	0,98	0,34
500	1,195	-0,020	0,415	550	1,96	1,01	0,30
500	1,330	-0,030	0,540	600	1,91	1,13	0,31
500	1,390	-0,045	0,555	650	2,01	1,20	0,32
500	1,440	-0,050	0,620	700	2,10	1,24	0,70
500	1,440	-0,035	0,620	750	2,14	1,04	0,65
550	1,470	-0,050	0,640	800	2,38	1,13	0,78
600	1,505	-0,050	0,675	850	2,44	1,22	0,73
650	1,570	-0,050	0,720	900	2,39	1,23	0,73
700	1,585	-0,055	0,935	950	2,59	1,30	0,94
750	1,735	-0,055	1,000	1000	2,47	1,41	0,98
800	1,830	-0,050	1,080	1050	2,66	1,32	1,14
850	1,905	-0,050	1,155	1100	2,86	1,32	1,27
900	1,980	-0,055	1,240	1150	2,78	1,33	1,46
950	2,065	-0,055	1,315	1200	3,01	1,45	1,58
1000	2,145	-0,035	1,405	1250	3,15	1,54	1,60
1050	2,230	-0,055	1,505	1300	3,19	1,63	1,85
1100	2,330	-0,055	1,605	1350	3,48	1,57	2,03
1150	2,400	-0,055	1,705	1400	3,95	1,61	2,21
1200	2,510	-0,055	1,840	1450	4,49	1,65	2,35
1250	2,630	-0,055	2,035	1500	4,94	1,70	2,54
1300	2,740	-0,040	2,230	1550	5,08	1,62	2,54
1350	2,830	-0,055	2,365				
1400	3,010	-0,055	2,605				
1450	3,510	-0,060	2,770				
1500	3,850	-0,060	3,025				
1550	4,085	-0,060	3,270				
1550	4,200	-0,045	3,385				
1558	4,270	0,105	3,435				
1509	4,850	-0,080	3,545				
1263	6,175	-0,105	3,535				
999	6,210	-0,120	3,510				
707	6,175	-0,115	3,465				

Według ekstensometrów / According to extensometers

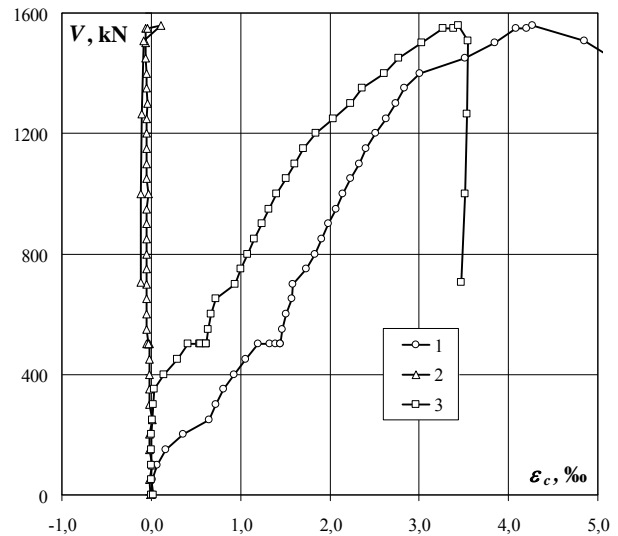

Według systemu Aramis / According to Aramis System

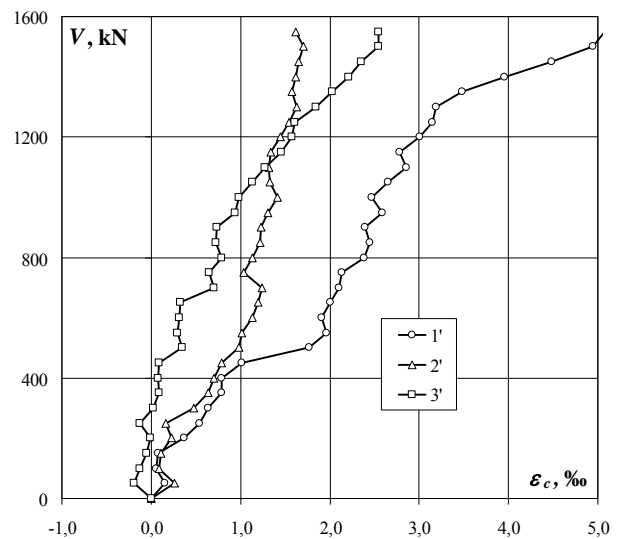

Ekstensometry
Extensometers

System Aramis
Aramis System

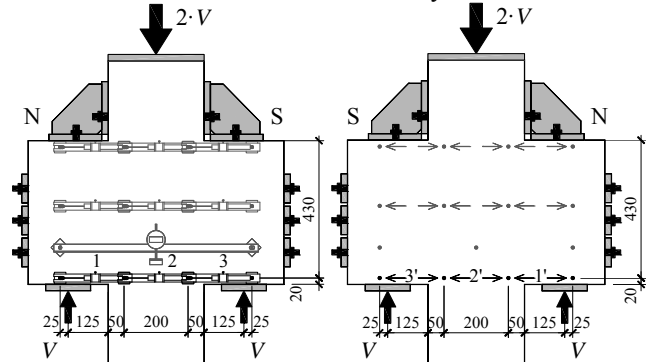

Odształcenia na drugim poziomie / Strains at the 2nd level

obciążenie wspornika corbel load	przesunięcia wg ekstensometrów displacement acc to extensometers			obciążenie wspornika corbel load	przesunięcia wg systemu Aramis displacement acc to Aramis System		
	4	5	6		4'	5'	6'
kN	‰	‰	‰	kN	‰	‰	‰
0	0,000	0,000	0,000	0	0,00	0,00	0,00
0	0,000	0,000	0,000	50	0,29	0,03	-0,05
50	0,000	0,000	0,000	100	0,12	0,11	-0,14
100	0,005	0,000	0,000	150	0,13	-0,06	-0,17
150	0,015	0,010	0,015	200	0,28	0,07	-0,04
200	0,045	0,035	0,000	250	0,32	-0,02	-0,14
250	0,050	0,140	0,005	300	0,25	0,18	-0,13
300	0,050	0,245	0,010	350	0,37	0,38	-0,09
350	0,050	0,375	0,020	400	0,25	0,42	-0,07
400	0,055	0,515	0,020	450	0,28	0,76	-0,09
450	0,075	0,615	0,020	500	0,57	1,00	0,10
500	0,150	0,660	0,025	550	0,53	1,03	-0,02
500	0,210	0,990	0,050	600	0,55	1,05	-0,03
500	0,255	0,985	0,110	650	0,61	1,08	0,07
500	0,340	0,930	0,130	700	0,96	1,03	0,21
500	0,300	0,925	0,110	750	0,77	0,96	0,14
550	0,320	0,925	0,110	800	1,11	1,03	0,29
600	0,355	0,930	0,115	850	1,01	1,01	0,33
650	0,370	0,930	0,115	900	1,02	0,96	0,26
700	0,385	0,900	0,105	950	1,17	1,06	0,32
750	0,590	0,835	0,105	1000	1,25	1,12	0,45
800	0,665	0,815	0,105	1050	1,52	1,07	0,60
850	0,725	0,795	0,105	1100	1,55	1,09	0,68
900	0,815	0,765	0,110	1150	1,60	0,84	0,83
950	0,880	0,745	0,110	1200	1,84	0,88	1,17
1000	0,945	0,715	0,115	1250	1,84	0,86	1,49
1050	1,020	0,675	0,130	1300	2,05	0,85	1,56
1100	1,100	0,640	0,125	1350	2,31	0,77	1,73
1150	1,180	0,590	0,130	1400	2,90	0,65	2,07
1200	1,265	0,530	0,140	1450	3,03	0,57	2,10
1250	1,365	0,435	0,155	1500	3,58	0,64	2,39
1300	1,475	0,365	0,170	1550	3,72	0,52	2,42
1350	1,560	0,310	0,150				
1400	1,755	0,255	0,195				
1450	2,510	-0,025	0,210				
1500	2,890	-0,175	0,235				
1550	3,305	-0,410	0,250				
1550	3,540	-0,625	0,285				
1558	3,775	-0,855	0,300				
1509	7,505	-3,705	0,330				
1263	9,035	-2,735	0,280				
999	8,960	-2,685	0,190				
707	8,830	-2,685	0,110				

Według ekstensometrów / According to extensometers

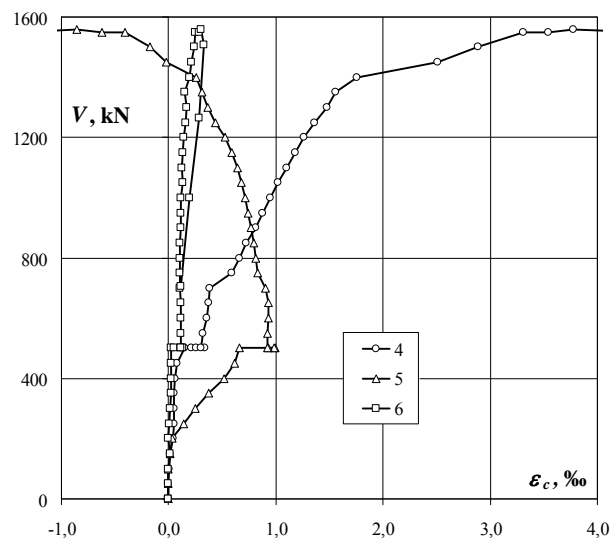

Według systemu Aramis / According to Aramis System

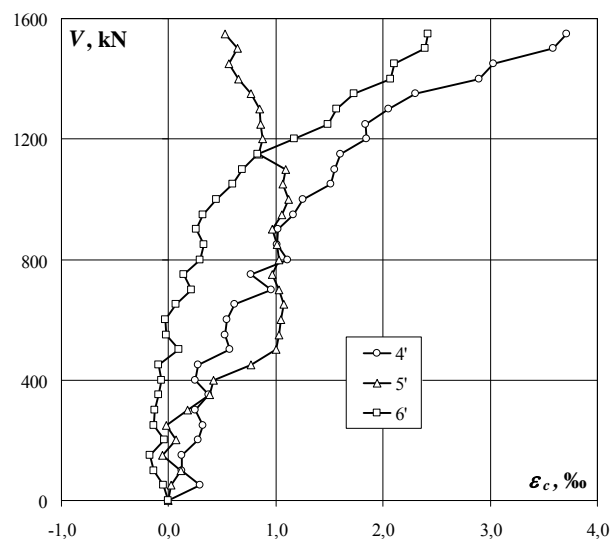

Ekstensometry
Extensometers

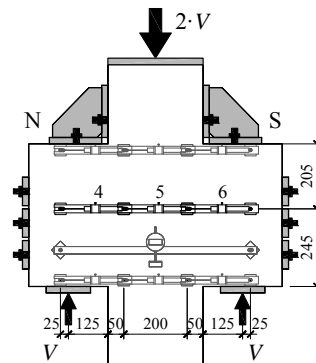

System Aramis
Aramis System

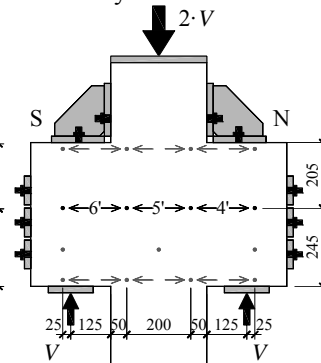

E-III

Odształcenia na trzecim poziomie / Strains at the 3rd level

obciążenie wspornika corbel load	przesunięcia wg ekstensometrów displacement acc to extensometers			obciążenie wspornika corbel load	przesunięcia wg systemu Aramis displacement acc to Aramis System		
	7	8	9		7'	8'	9'
kN	‰	‰	‰	kN	‰	‰	‰
0	0,000	0,000	0,000	0	0,00	0,00	0,00
0	0,000	0,000	0,000	50	-0,01	-0,07	
50	-0,010	0,000	-0,005	100	-0,14	-0,10	
100	-0,015	-0,010	-0,010	150	0,05	-0,31	
150	-0,030	-0,020	-0,020	200	0,01	-0,14	
200	-0,040	0,005	-0,040	250	-0,14	-0,32	
250	-0,060	-0,060	-0,060	300	-0,24	-0,18	
300	-0,070	-0,075	-0,085	350	-0,25	-0,09	
350	-0,025	-0,055	-0,110	400	-0,39	-0,09	
400	-0,080	-0,100	-0,105	450	-0,31	-0,06	
450	-0,090	-0,115	-0,115	500	0,09	-0,29	
500	-0,090	-0,125	-0,120	550	0,00	-0,29	
500	-0,060	-0,165	-0,170	600	-0,14	-0,24	
500	0,045	-0,140	-0,105	650	-0,15	-0,15	
500	0,075	-0,150	-0,105	700	-0,18	-0,07	
500	-0,065	-0,060	-0,110	750	-0,30	-0,25	
550	-0,065	-0,060	-0,110	800	0,02	-0,10	
600	-0,065	-0,060	-0,115	850	-0,09	-0,13	
650	-0,070	-0,060	-0,115	900	-0,14	-0,05	
700	-0,065	-0,060	-0,115	950	-0,20	-0,03	
750	-0,035	-0,060	-0,110	1000	-0,10	-0,02	
800	-0,020	-0,060	-0,110	1050	-0,08	0,04	
850	-0,015	-0,060	-0,105	1100	0,01	0,06	
900	-0,010	-0,060	-0,105	1150	0,23	0,11	
950	-0,005	-0,060	-0,105	1200	-0,01	0,30	
1000	0,015	-0,060	-0,125	1250	-0,04	0,39	
1050	0,000	-0,050	-0,105	1300	-0,06	0,52	
1100	0,000	0,005	-0,100	1350	0,03	0,47	
1150	-0,005	-0,055	-0,100	1400	0,15	0,38	
1200	-0,010	-0,060	-0,100	1450	0,04	0,45	
1250	-0,020	-0,065	-0,100	1500	0,06	0,52	
1300	-0,025	-0,075	-0,095	1550	0,08	0,38	
1350	-0,025	-0,110	-0,090				
1400	-0,025	-0,140	-0,060				
1450	0,025	-0,310	-0,040				
1500	0,050	-0,410	0,040				
1550	0,075	-0,525	0,125				
1550	0,095	-0,550	0,185				
1558	0,105	-0,580	0,205				
1509	0,300	-1,365	0,255				
1263	-0,150	-0,340	0,195				
999	-0,140	-0,330	0,195				
707	-0,140	-0,350	0,215				

Według ekstensometrów / According to extensometers

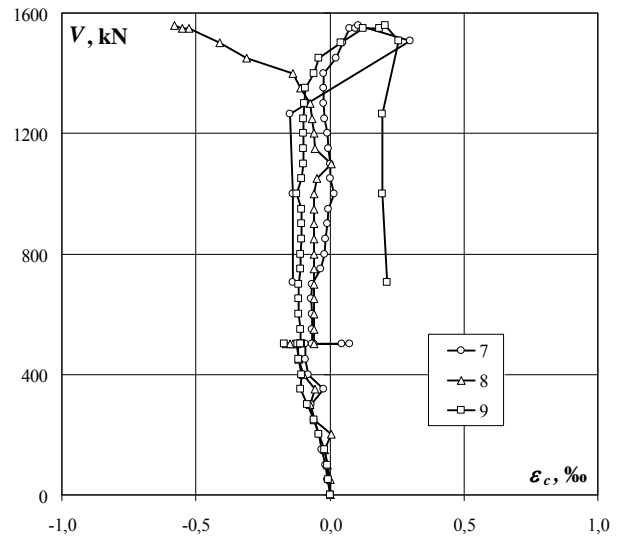

Według systemu Aramis / According to Aramis System

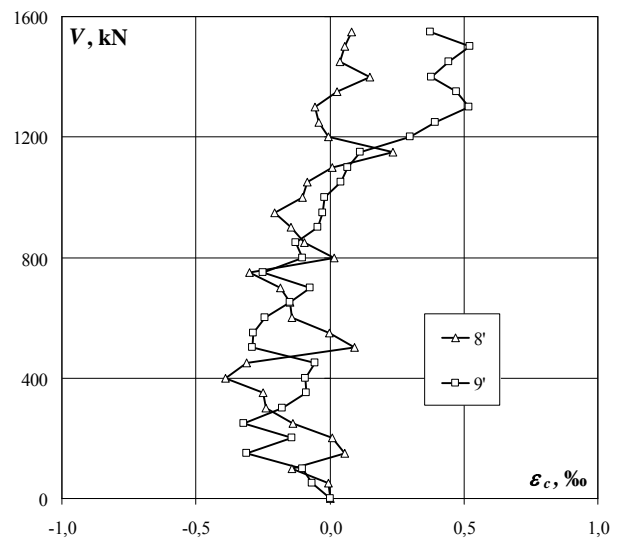

Ekstensometry
Extensometers

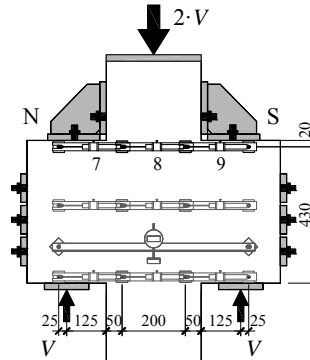

System Aramis
Aramis System

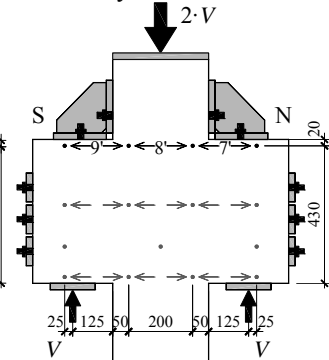

Przemieszczenie słupa względem wsporników / The relative displacement between the column and the corbels

obciążenie wspornika corbel load	Przemieszczenie wg czujnika Displacement acc to gauges	obciążenie wspornika corbel load	Przemieszczenie wg systemu Aramis Displacement acc. to Aramis System
kN	mm	kN	mm
0	0,000	0	0,000
50	0,003	50	-0,006
100	0,013	100	0,019
150	0,028	150	0,031
200	0,054	200	0,047
250	0,089	250	0,072
300	0,115	300	0,124
350	0,152	350	0,160
400	0,192	400	0,187
450	0,224	450	0,215
500	0,260	500	0,287
500	wzmocnienie / strengthening	550	0,300
500	0,238	600	0,321
550	0,240	650	0,341
600	0,247	700	0,404
650	0,269	750	0,428
700	0,290	800	0,446
750	0,335	850	0,469
800	0,362	900	0,494
850	0,386	950	0,518
900	0,411	1000	0,551
950	0,431	1050	0,586
1000	0,455	1100	0,606
1050	0,482	1150	0,651
1100	0,514	1200	0,690
1150	0,543	1250	0,741
1200	0,580	1300	0,784
1250	0,632	1350	0,865
1300	0,677	1400	0,956
1350	0,717	1450	1,051
1400	0,786	1500	1,151
1450	0,915	1550	1,177
1500	1,017		
1550	1,150		
1550	1,350		

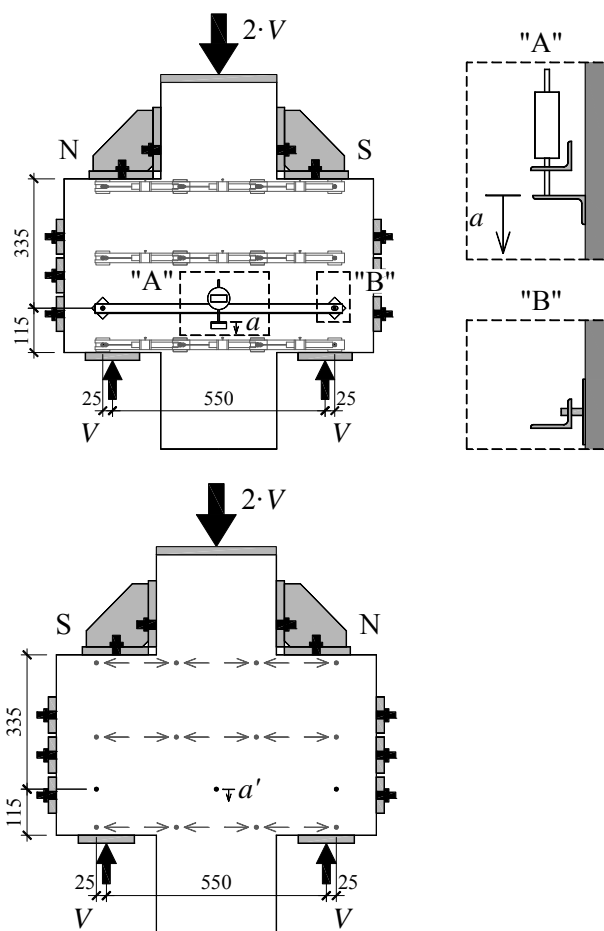
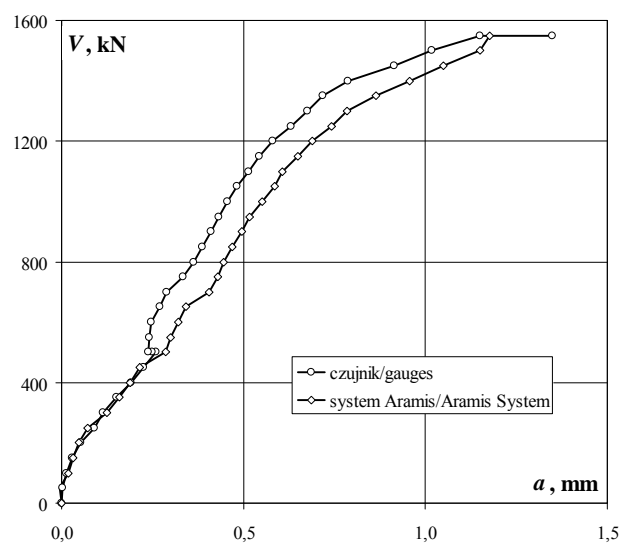

E-III

Szerokość rozwarcia rys / Crack width

obciążenie wspornika corbel load	Numer rysy / Crack number							
	1	2	3	4	5	6	7	8
	mm	mm	mm	mm	mm	mm	mm	mm
250								
300	0,10							
350	0,15	0,10						
400	0,15	0,15						
450	0,17	0,15						
500	0,20	0,17						
500	0,20	0,19						
500	0,20	0,20						
550	0,20	0,20						
600	0,22	0,20						
650	0,22	0,20						
700	0,22	0,20						
750	0,22	0,20						
800	0,22	0,20						
850	0,25	0,20						
900	0,25	0,20	0,15					
950	0,25	0,20	0,18					
1000	0,25	0,20	0,20	0,15				
1050	0,25	0,20	0,22	0,15				
1100	0,25	0,20	0,25	0,17				
1150	0,28	0,20	0,25	0,17				
1200	0,30	0,20	0,25	0,17	0,25			
1250	0,30	0,20	0,25	0,17	0,27	0,30		
1300	0,30	0,20	0,25	0,20	0,30	0,30		
1350	0,30	0,17	0,25	0,20	0,30	0,30		
1400	0,30	0,15	0,25	0,25	0,30	0,30		
1450	0,30	0,15	0,25	0,30	0,30	0,30		
1500	0,30	0,15	0,25	0,30	0,32	0,35		

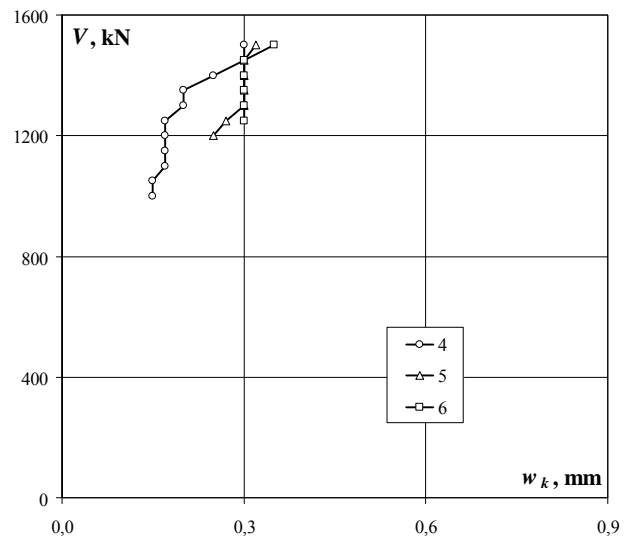
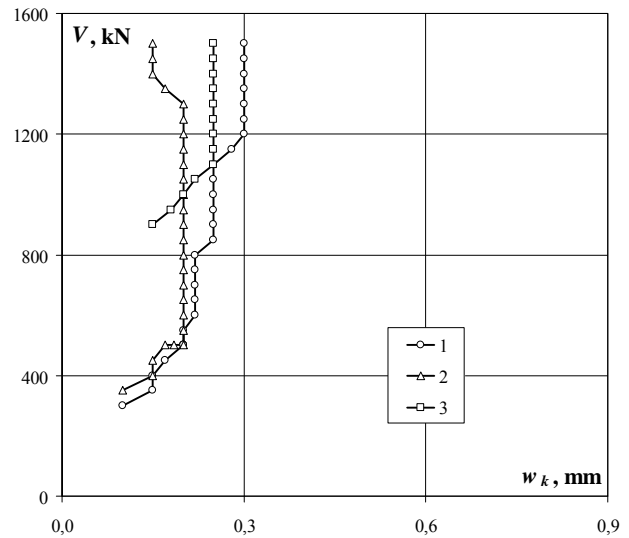

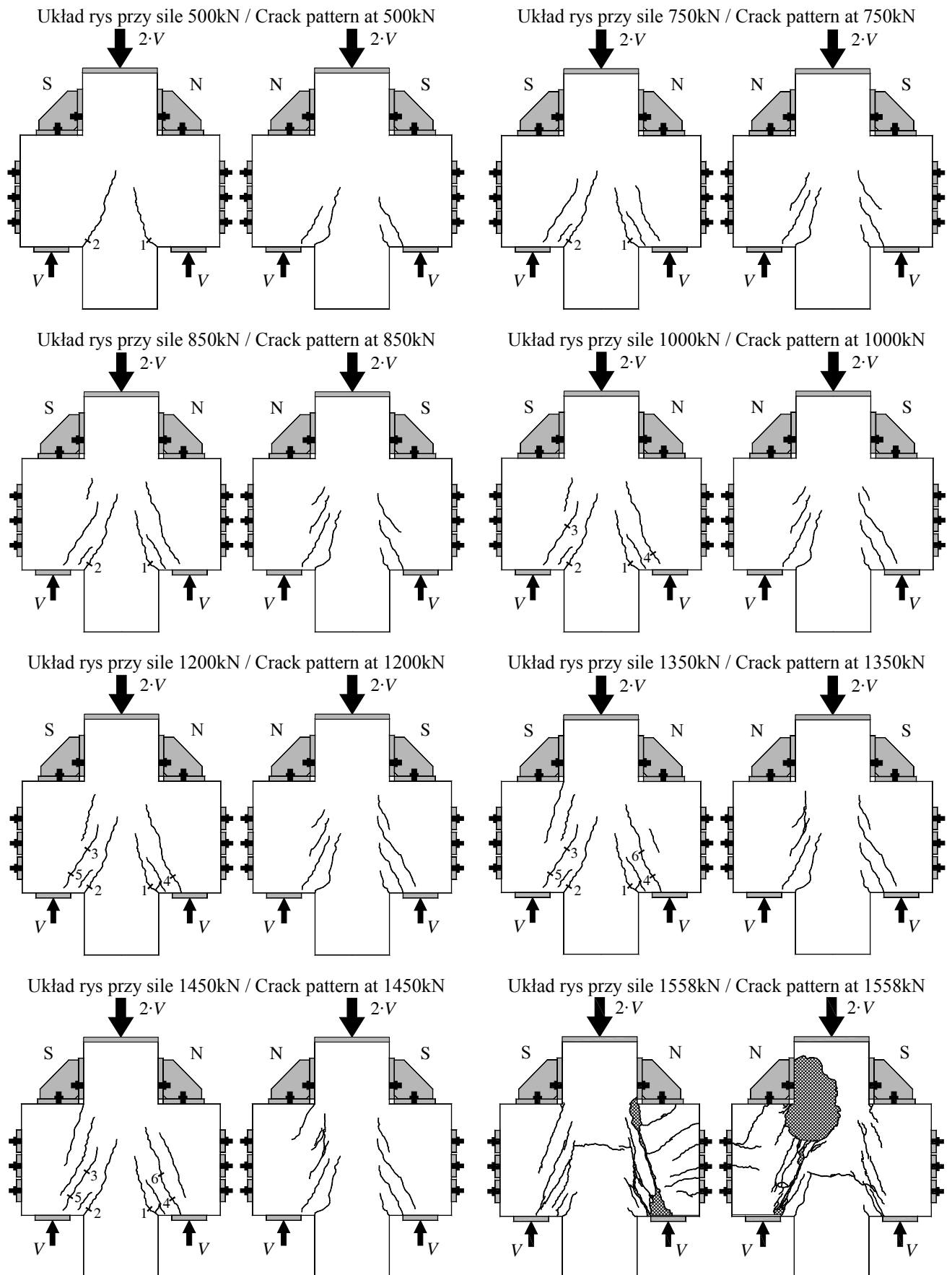

E-III

Szerokość rozwarcia rys według systemu Aramis / Crack width according to Aramis System

obciążenie wspornika corbel load	Numer rysy / Crack number							
	1	2	3	4	5	6	7	8
	mm	mm	mm	mm	mm	mm	mm	mm
0	0,00	0,00	0,00	0,00	0,00	0,00		
50	0,01	-0,02	0,00	-0,03	-0,03	0,00		
100	-0,01	-0,01	0,01	-0,01	-0,01	0,00		
150	0,00	0,02	-0,01	0,00	-0,01	0,01		
200	0,06	0,03	0,01	0,01	0,00	0,05		
250	0,10	0,03	0,01	0,01	0,00	0,03		
300	0,11	0,10	0,00	0,01	-0,01	0,02		
350	0,12	0,16	0,00	0,02	-0,01	0,02		
400	0,15	0,19	-0,01	0,01	-0,01	0,02		
450	0,18	0,22	0,01	-0,02	0,00	0,02		
500	0,25	0,27	0,06	-0,02	-0,05	0,03		
550	0,28	0,27	0,05	-0,01	-0,04	0,02		
600	0,27	0,28	0,05	-0,01	-0,04	0,03		
650	0,26	0,27	0,05	0,00	-0,03	0,04		
700	0,22	0,29	0,14	0,08	0,05	0,12		
750	0,23	0,30	0,16	0,12	0,05	0,16		
800	0,24	0,31	0,19	0,13	0,07	0,17		
850	0,24	0,32	0,20	0,16	0,11	0,20		
900	0,24	0,32	0,20	0,17	0,12	0,20		
950	0,24	0,32	0,21	0,20	0,13	0,21		
1000	0,23	0,31	0,25	0,23	0,14	0,24		
1050	0,21	0,32	0,29	0,27	0,19	0,26		
1100	0,20	0,32	0,28	0,28	0,23	0,27		
1150	0,20	0,34	0,29	0,30	0,26	0,32		
1200	0,21	0,35	0,27	0,32	0,28	0,34		
1250	0,22	0,35	0,27	0,37	0,34	0,35		
1300	0,22	0,35	0,28	0,40	0,39	0,35		
1350	0,21	0,35	0,29	0,41	0,41	0,35		
1400	0,20	0,36	0,29	0,46	0,46	0,34		
1450	0,20	0,37	0,30	0,47	0,48	0,37		
1500	0,19	0,36	0,29	0,47	0,49	0,38		
1550	0,19	0,35	0,28	0,49	0,50	0,35		

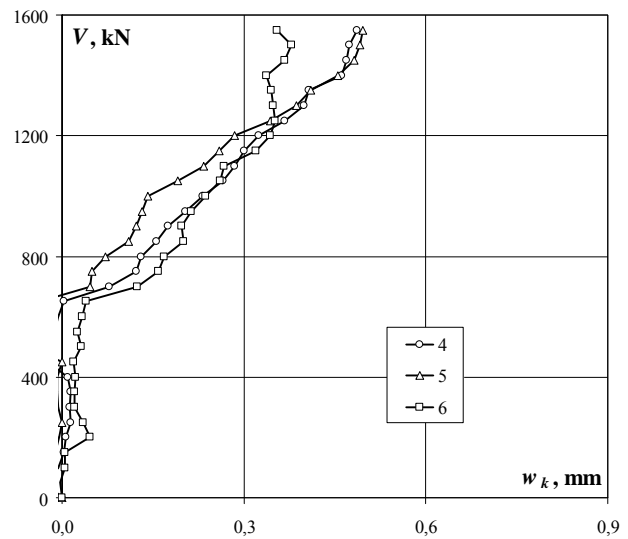
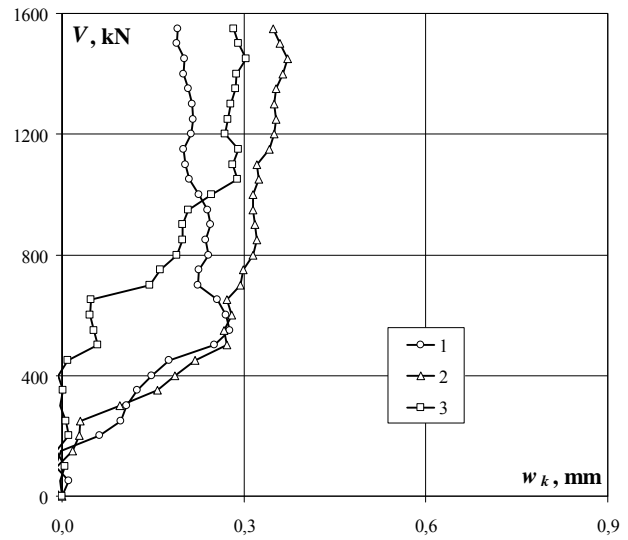

Układ rys przy sile 750kN / Crack pattern at 750kN

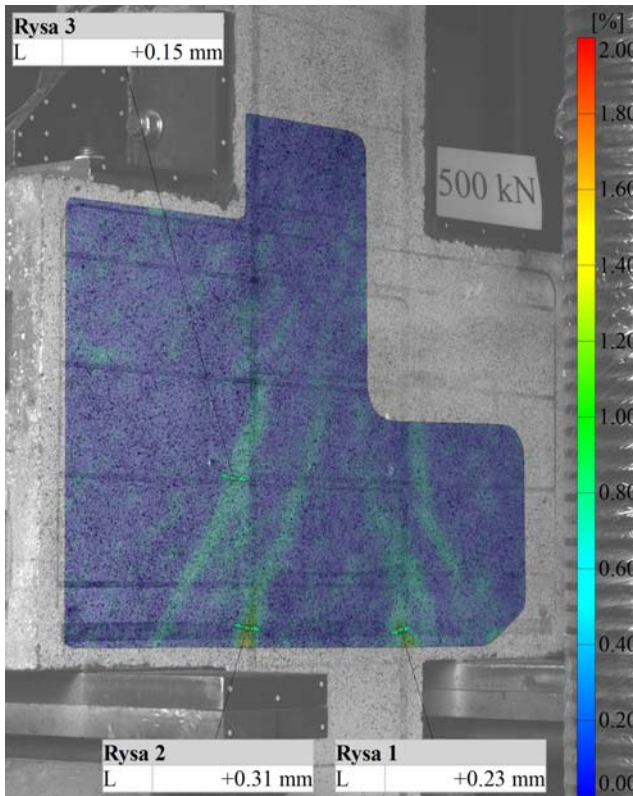

Układ rys przy sile 1000kN / Crack pattern at 1000kN

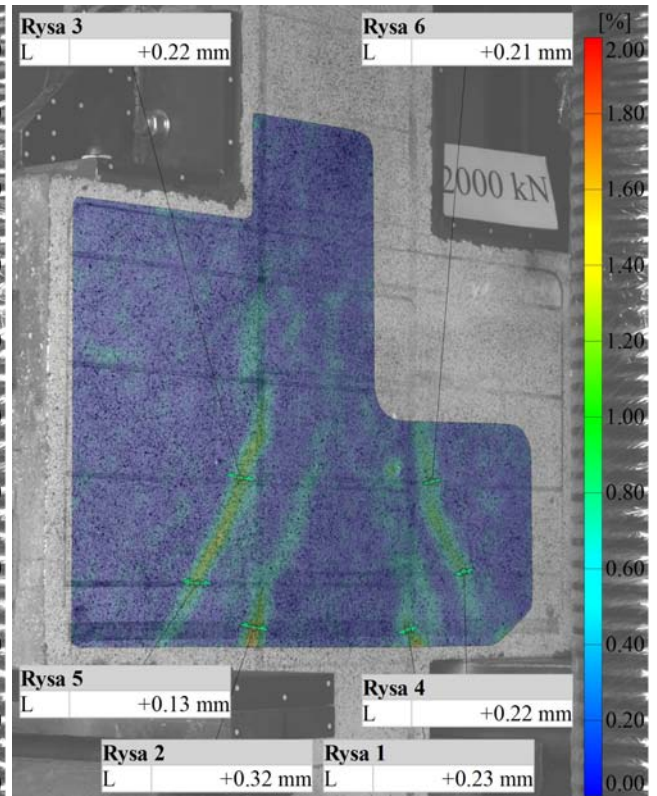

Układ rys przy sile 1350kN / Crack pattern at 1350kN

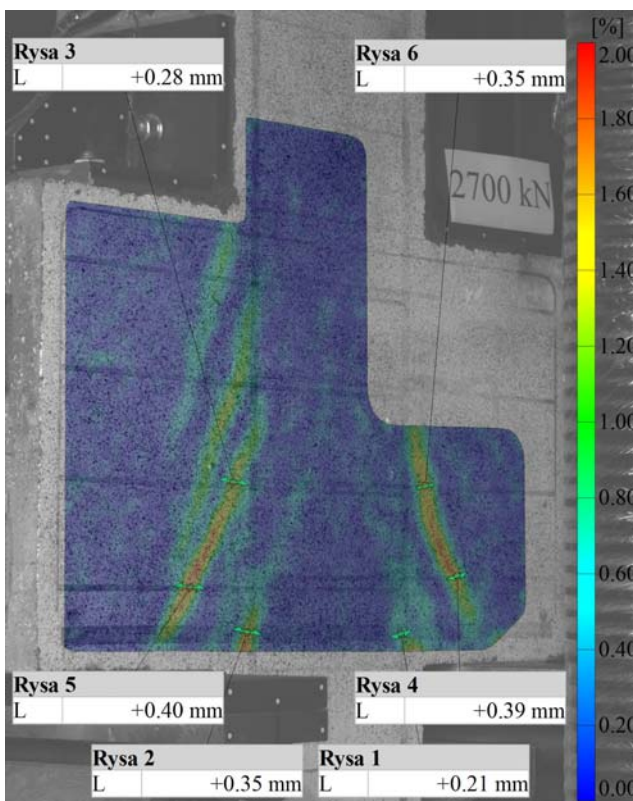

Układ rys przy sile 1558kN / Crack pattern at 1558kN

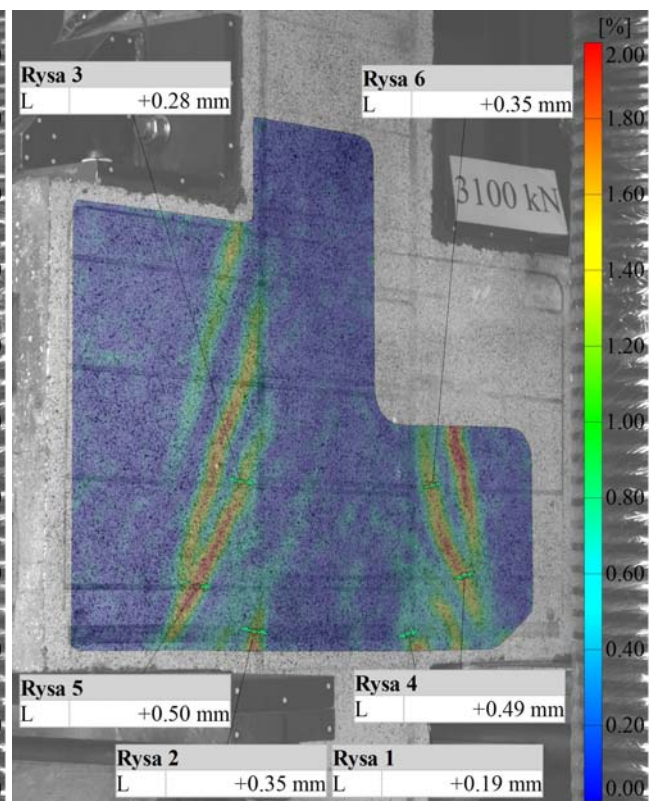

E-III



Nakładanie kleju na akcesorium
Placing of the glue on accessory

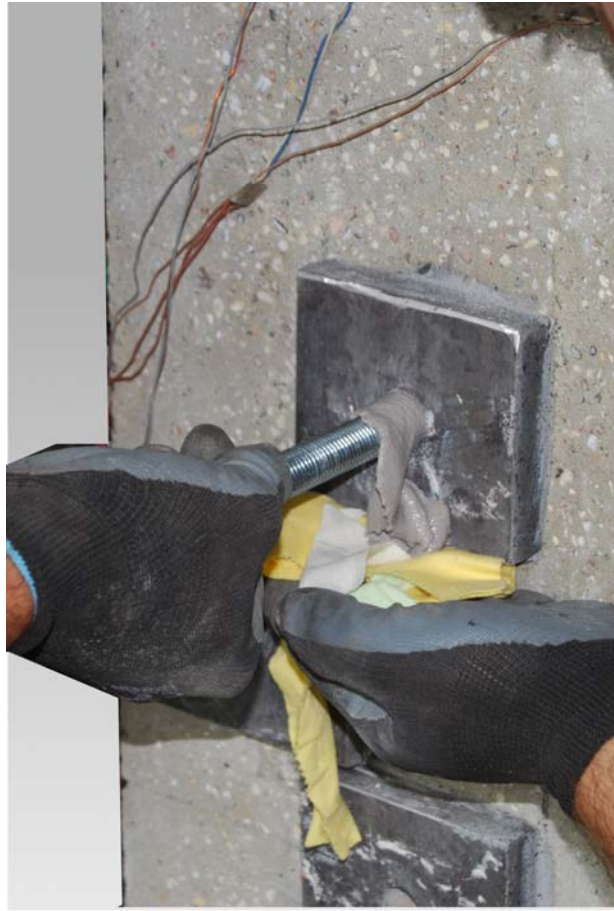

Wkręcanie pręta
Screwing of the rod

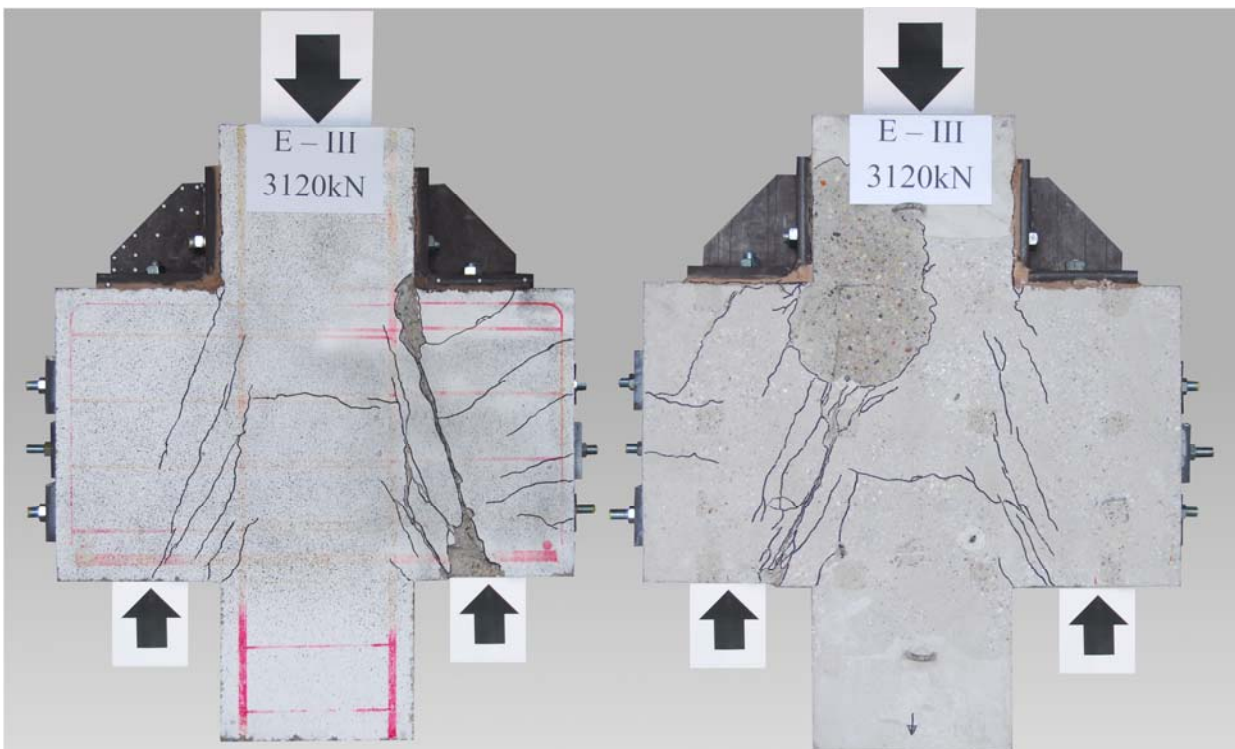

Wspornik po zniszczeniu / Corbel after failure

Seria F
F Series

Wykres $\sigma - \varepsilon$ dla: / $\sigma - \varepsilon$ diagram for:

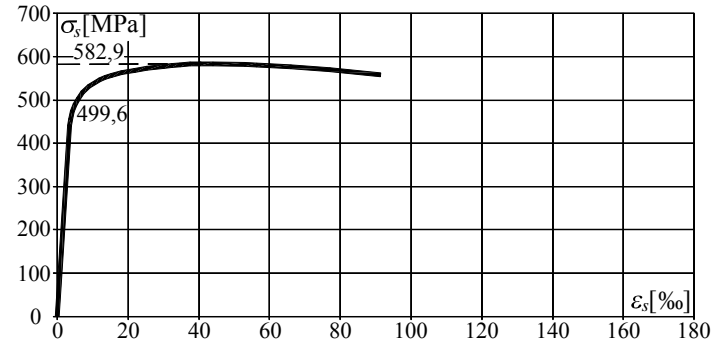

prętów zbrojeniowych Ø8 / reinforcement bars Ø8

Tabele $\sigma - \varepsilon$ dla: / $\sigma - \varepsilon$ tables for:

ε_s	σ_s	ε_s	σ_s
%	MPa	%	MPa
0	0	6,26	499,6
2,88	200,0	9,07	525,0
3,13	250,0	16,73	550,0
3,37	300,0	38,0	575,0
3,63	350,0	52,2	582,9
3,92	400,0	70,0	570,9
4,44	450,0	80,0	567,8

prętów Ø8 / bars Ø8, $A_s=49,77\text{mm}^2$

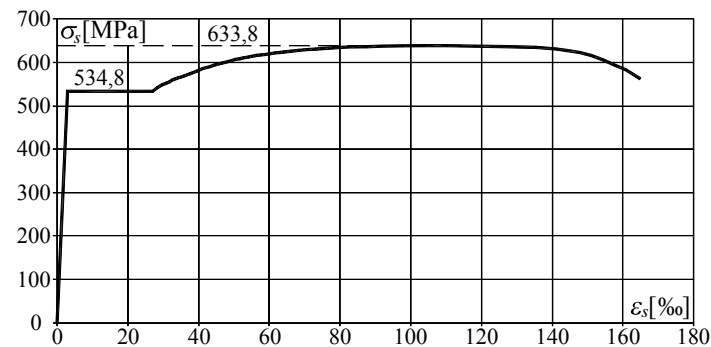

prętów zbrojeniowych Ø16 / reinforcement bars Ø16

ε_s	σ_s	ε_s	σ_s
%	MPa	%	MPa
0	0	80	622,7
3,957	534,8	90	627,2
28,5	530,6	120	631,8
30	542,2	130	631,5
40	573,2	140	630,4
50	592,8	150	628,2
60	606,4	160	620,6
70	616,1		

prętów Ø16 / bars Ø16, $A_s=201,36\text{mm}^2$

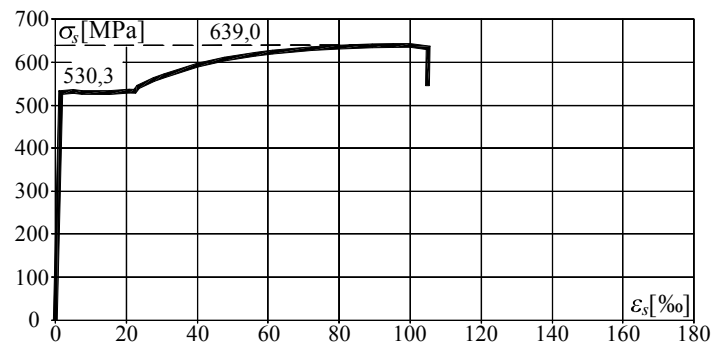

prętów zbrojeniowych Ø10 / reinforcement bars Ø10

ε_s	σ_s	ε_s	σ_s
%	MPa	%	MPa
0	0	70	630,1
2,100	530,3	80	635,3
25,5	535,3	90	638,2
30	567,8	100	638,7
40	593,0		
50	610,5		
60	622,2		

prętów Ø10 / bars Ø10, $A_s=77,60\text{mm}^2$

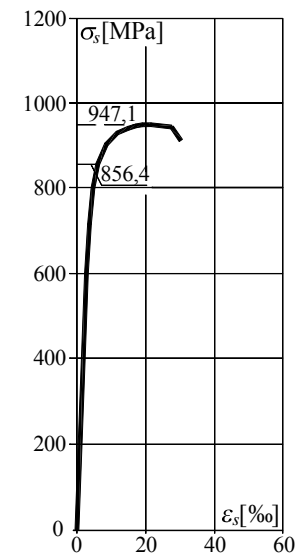

prętów gwintowanych M20 / threaded rods M20

ε_s	σ_s	ε_s	σ_s
%	MPa	%	MPa
0	0	8,352	900
2,814	600	15,862	940
3,485	700		
4,671	800		
5,821	850		

prętów M20 / rods M20, $A_s=227,78\text{mm}^2$

Beton / Concrete

	f_{cm}	E_{cm}	$f_{ct,sp}$	ρ_c
	MPa	GPa	MPa	kg/m ³
średnia / average	35,22	26,06	3,47	2250
odchylenie standardowe / standard deviation	1,002	1,547	0,228	15,3
współczynnik zmienności / coefficient of variation	2,84%	5,93%	6,58%	0,68%
liczba próbek / number of specimens	18	15	15	36
minimalna wartość / minimum value	33,0	24,2	3,15	2220
maksymalna wartość / maximum value	37,0	29,9	3,90	2274

Rozwój wytrzymałości betonu w czasie / Development of the concrete strength in time

data / date	badany element / tested specimen	wiek / age	f_{cm}
		dni / days	MPa
2017-06-24	F-0	58	34,00
2017-06-27	F-I	61	35,80
2017-06-29	F-II	63	34,40
2017-07-05		69	35,60
średnia / average			35,22
odchylenie standardowe / standard deviation			1,002
współczynnik zmienności / coefficient of variation			2,84%
liczba próbek / number of specimens			15
minimalna wartość / minimum value			33,0
maksymalna wartość / maximum value			37,0

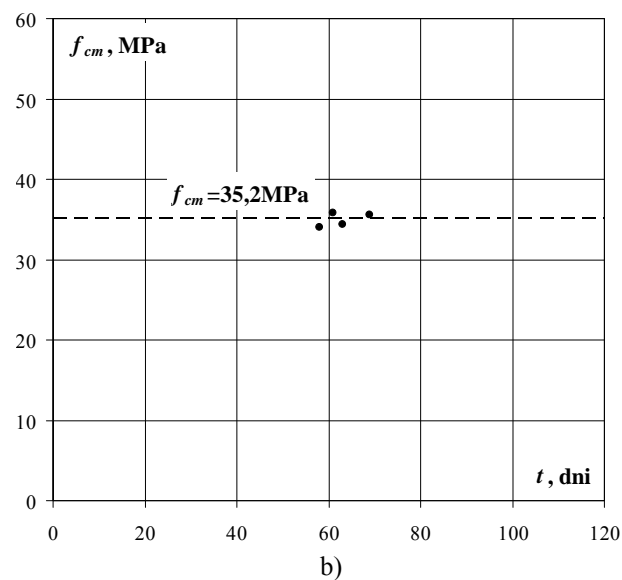
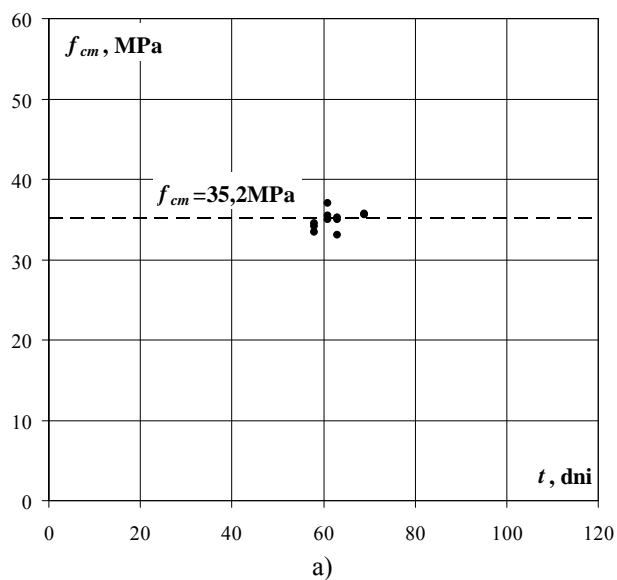

Rozwój wytrzymałości betonu w czasie: a) wyniki badań, b) średnie dzienne
Development of the concrete strength in time: a) test results, b) daily average

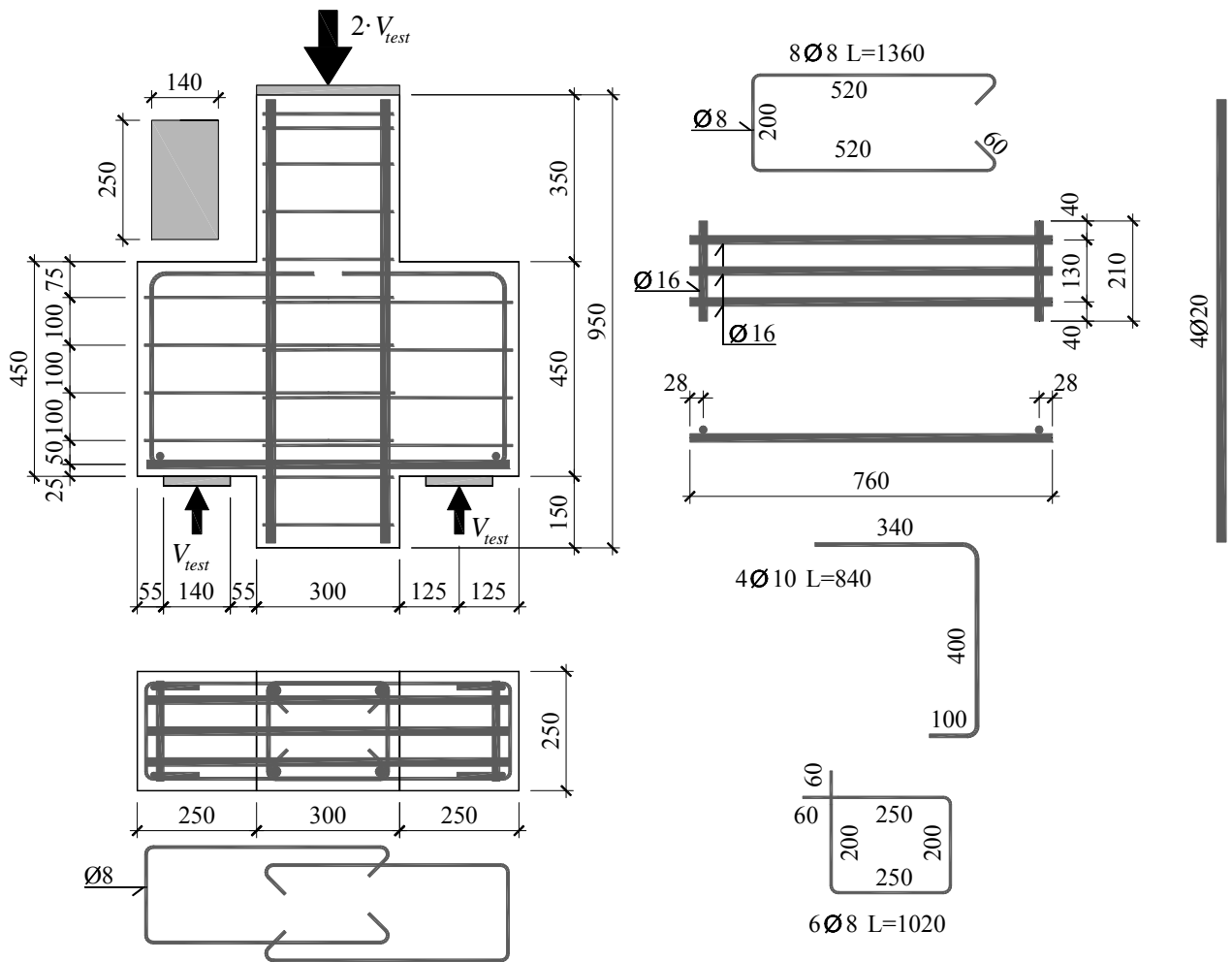

Zbrojenie modelu / Specimen's reinforcement

Wytrzymałość betonu na ściskanie / Compressive strength of concrete

$$f_{cm} = 35,22\text{MPa}$$

Moduł sprężystości podłużnej / Young's modulus

$$E_{cm} = 26,1\text{GPa}$$

Wytrzymałość betonu na rozciąganie przy rozłupywaniu / Tensile splitting strength of concrete

$$f_{ct,sp} = 3,47\text{MPa}$$

Gęstość betonu / Density of concrete

$$\rho = 2250\text{kg/m}^3$$

Charakterystyka zbrojenia / Characteristics of the reinforcement

Ø8

$$A_s = 49,77\text{mm}^2, f_{ym} = 499,6\text{MPa}, f_{tm} = 582,9\text{MPa}$$

Ø10

$$A_s = 77,60\text{mm}^2, f_{ym} = 530,3\text{MPa}, f_{tm} = 639,0\text{MPa}$$

Ø16

$$A_s = 201,36\text{mm}^2, f_{ym} = 534,8\text{MPa}, f_{tm} = 633,8\text{MPa}$$

M20

$$A_s = 227,78\text{mm}^2, f_{ym} = 856,4\text{MPa}, f_{tm} = 947,1\text{MPa}$$

Siła niszcząca / Failure force

$$V_{test} = 990\text{kN}$$

Beton – odkształcenia na słupku i wsporniku (strona N) (ϵ_c) / Concrete – strains on the column and corbel (side N) (ϵ_c)

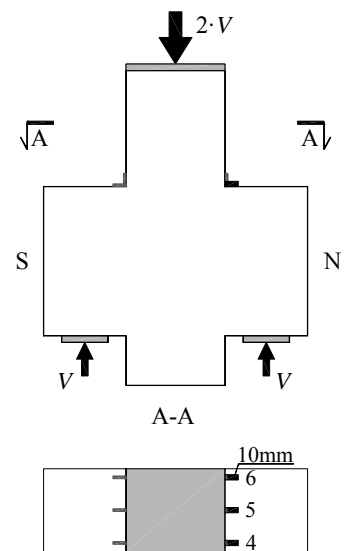
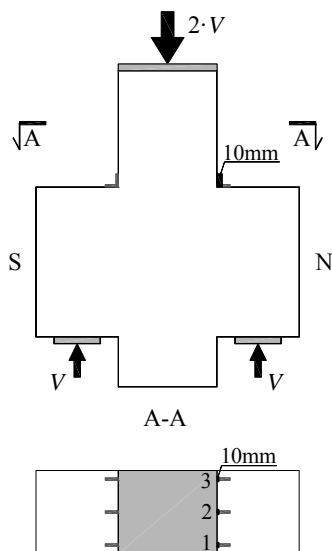
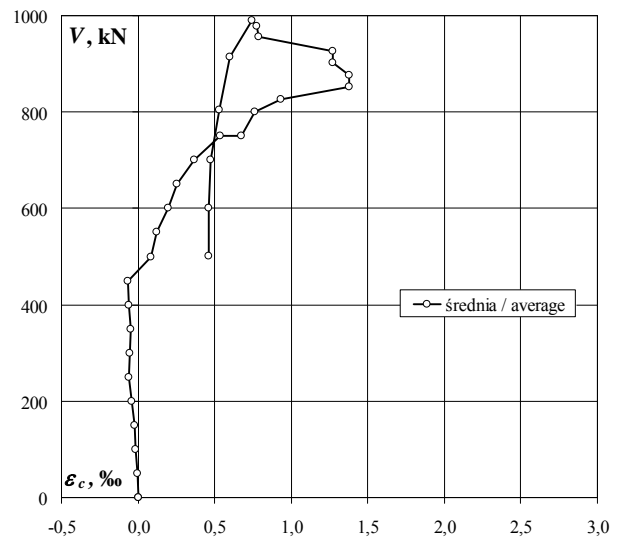
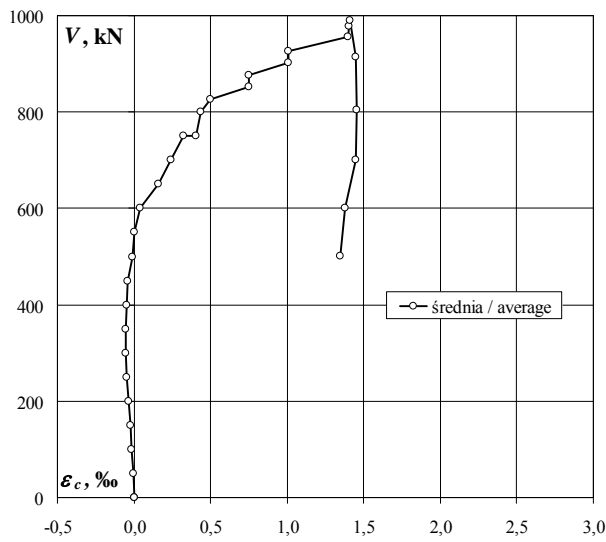
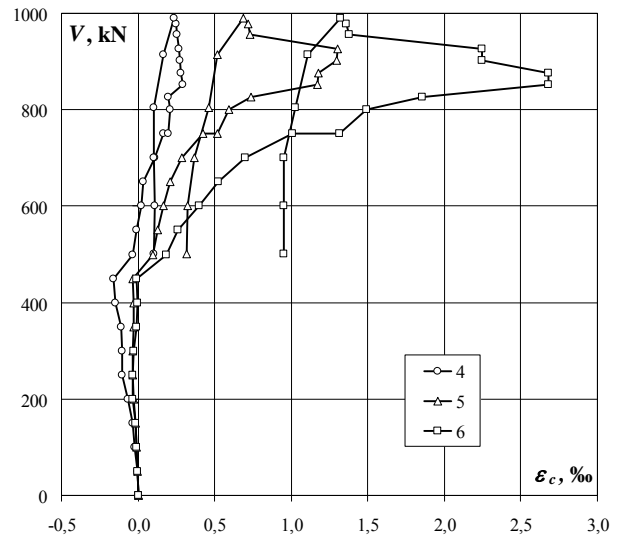
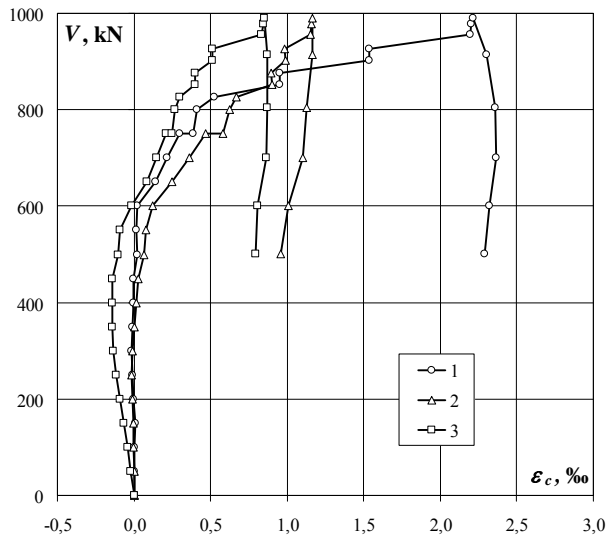

F-0

Beton – odkształcenia na słupku i wsporniku (strona S) (ϵ_c) / Concrete – strains on the column and corbel (side S) (ϵ_c)

obciążenie wspornika corbel load	odkształcenie S S strain				odkształcenie N N strain			
	7	8	9	średnia/ average	10	11	12	średnia/ average
kN	‰	‰	‰	‰	‰	‰	‰	‰
0	0,000	0,000		0,000	0,000	0,000	0,000	0,000
0	0,000	0,000		0,000	0,000	0,000	0,000	0,000
50	-0,015	-0,019		-0,017	-0,035	-0,042	-0,007	-0,028
100	-0,044	-0,047		-0,046	-0,084	-0,095	-0,020	-0,066
150	-0,082	-0,077		-0,080	-0,141	-0,150	-0,044	-0,112
200	-0,128	-0,107		-0,118	-0,196	-0,206	-0,084	-0,162
250	-0,181	-0,143		-0,162	-0,255	-0,264	-0,128	-0,216
300	-0,242	-0,186		-0,214	-0,321	-0,333	-0,183	-0,279
350	-0,309	-0,230		-0,270	-0,383	-0,411	-0,242	-0,345
400	-0,384	-0,275		-0,330	-0,450	-0,489	-0,307	-0,415
450	-0,456	-0,319		-0,388	-0,519	-0,569	-0,370	-0,486
500	-0,562	-0,387		-0,475	-0,663	-0,756	-0,529	-0,649
550	-0,652	-0,434		-0,543	-0,756	-0,886	-0,637	-0,760
600	-0,761	-0,487		-0,624	-0,861	-1,030	-0,764	-0,885
650	-0,940	-0,550		-0,745	-0,967	-1,184	-0,892	-1,014
700	-1,106	-0,608		-0,857	-1,085	-1,370	-1,046	-1,167
750	-1,269	-0,670		-0,970	-1,225	-1,633	-1,257	-1,372
750	-1,355	-0,690		-1,023	-1,291	-1,772	-1,370	-1,478
800	-1,448	-0,718		-1,083	-1,387	-1,910	-1,470	-1,589
825	-1,594	-0,751		-1,173	-1,502	-2,086	-1,600	-1,729
853	-1,773	-0,803		-1,288	-1,741	-2,406	-1,870	-2,006
876	-1,801	-0,814		-1,308	-1,773	-2,443	-1,901	-2,039
903	-1,934	-0,871		-1,403	-2,083	-2,792	-2,249	-2,375
926	-1,962	-0,881		-1,422	-2,114	-2,828	-2,282	-2,408
956	-2,166	-0,978		-1,572	-2,598	-3,106	-2,735	-2,813
978	-2,193	-0,989		-1,591	-2,630	-3,133	-2,762	-2,842
989	-2,209	-0,996		-1,603	-2,644	-3,134	-2,784	-2,854
914	-2,163	-0,975		-1,569	-2,523	-2,950	-2,695	-2,723
805	-2,111	-0,950		-1,531	-2,351	-2,725	-2,518	-2,531
701	-2,125	-0,945		-1,535	-2,123	-2,398	-2,307	-2,276
601	-1,970	-0,875		-1,423	-2,084	-2,308	-2,267	-2,220
501	-1,869	-0,837		-1,353	-2,072	-2,296	-2,257	-2,208

Beton – odkształcenia na słupku i wsporniku (strona S) (ϵ_c) / Concrete – strains on the column and corbel (side S) (ϵ_c)

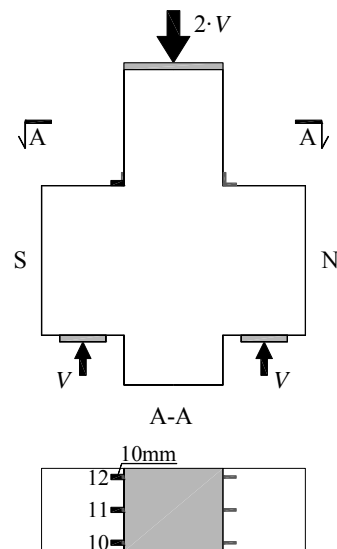
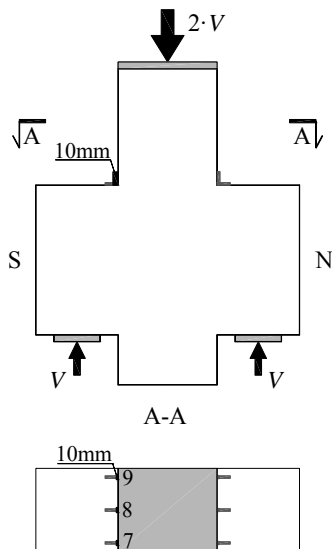
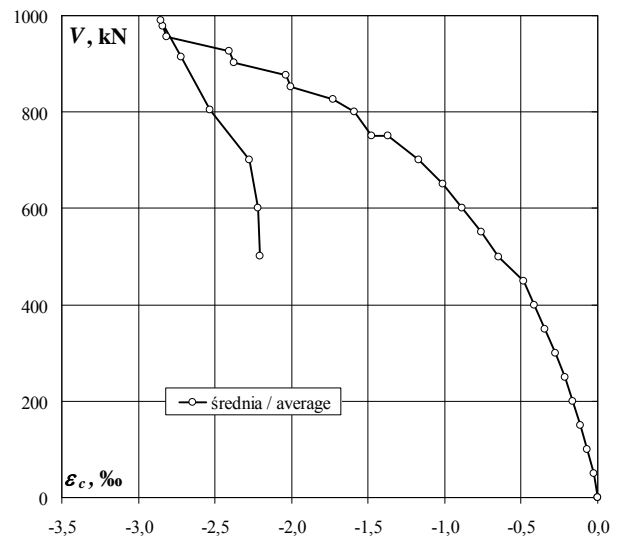
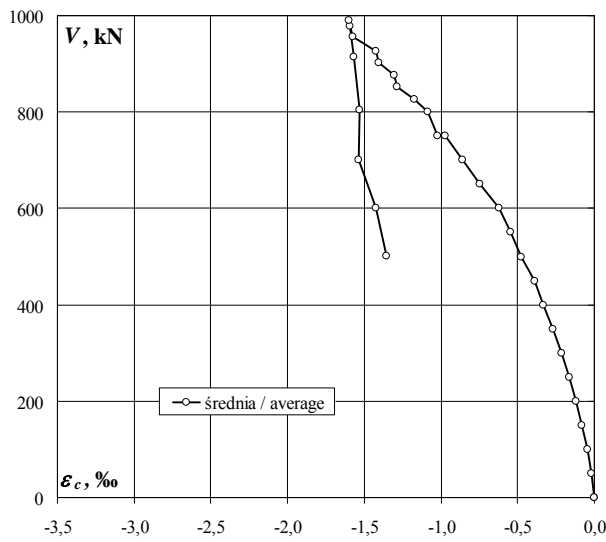
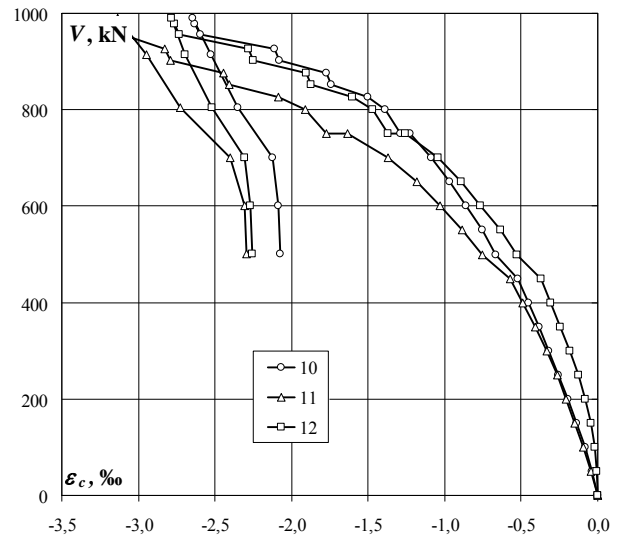
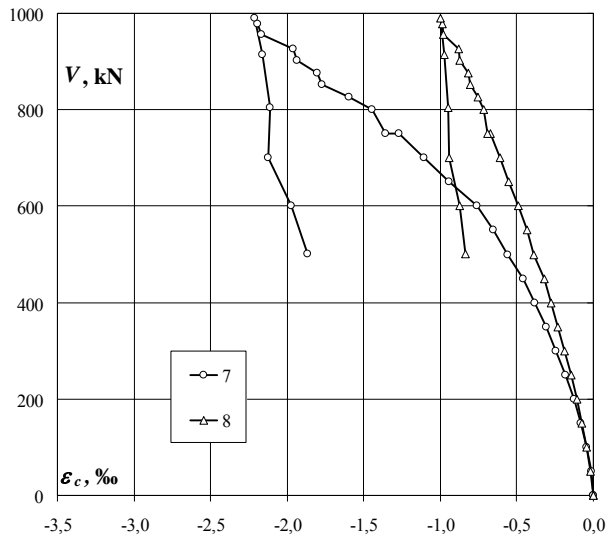

F-0

Zbrojenie główne – odkształcenia po stronie S i N (ε_s) / Main reinforcement – strains on S and N side (ε_s)

obciążenie wspornika corbel load	odkształcenie S S strain			odkształcenie N N strain		
	1	2	średnia/ average	3	4	średnia/ average
	%	%	%	%	%	%
kN						
0	0,000			0,000	0,000	0,000
0	-0,002			0,000	0,000	0,000
50	0,141			0,059	0,056	0,058
100	0,340			0,145	0,146	0,146
150	0,495			0,215	0,217	0,216
200	0,643			0,269	0,281	0,275
250	0,990			0,350	0,380	0,365
300	1,381			0,460	0,533	0,497
350	1,705			0,538	0,655	0,597
400	2,017			0,624	0,729	0,677
450	2,314			0,710	0,792	0,751
500	2,860			0,928	0,958	0,943
550	3,158			1,015	1,015	1,015
600	3,534			1,110	1,073	1,092
650	4,069			1,198	1,115	1,157
700	4,428			1,319	1,176	1,248
750	4,811			1,459	1,243	1,351
750	4,964			1,523	1,257	1,390
800	5,218			1,609	1,312	1,461
825	5,469			1,711	1,360	1,536
853	5,951			1,947	1,451	1,699
876	6,026			1,971	1,469	1,720
903	6,579			2,247	1,583	1,915
926	6,652			2,271	1,604	1,938
956	7,783			2,995	1,981	2,488
978	7,972			3,040	2,015	2,528
989	8,030			3,105	2,047	2,576
914	7,711			3,048	2,014	2,531
805	7,279			4,379	1,846	3,113
701	6,562					
601	6,884					
501	6,757					

Zbrojenie główne – odkształcenia po stronie S i N (ϵ_s) / Main reinforcement – strains on S and N side (ϵ_s)

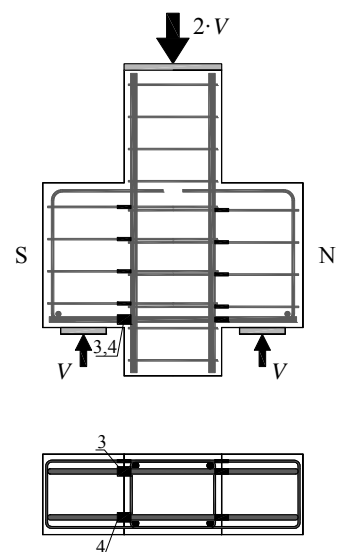
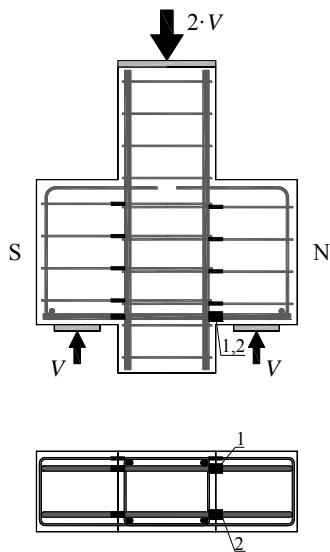
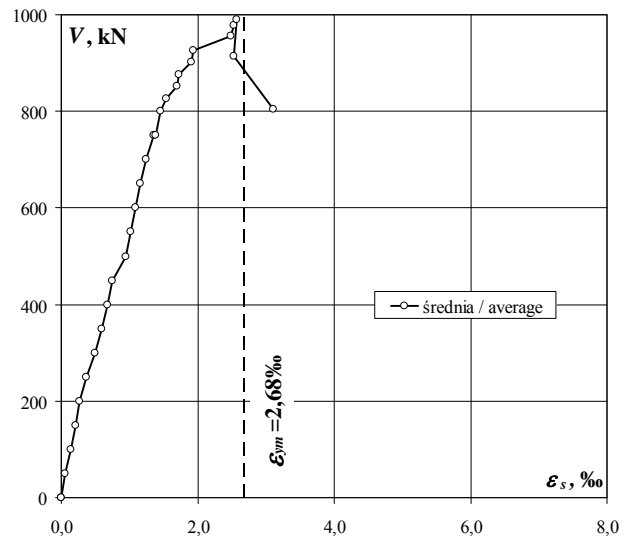
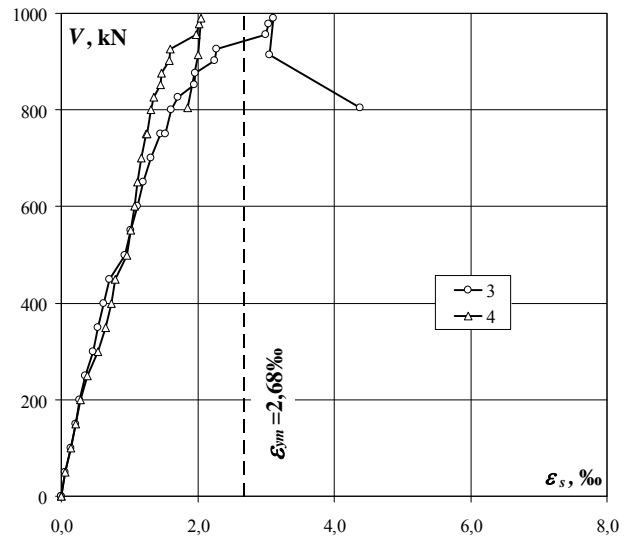
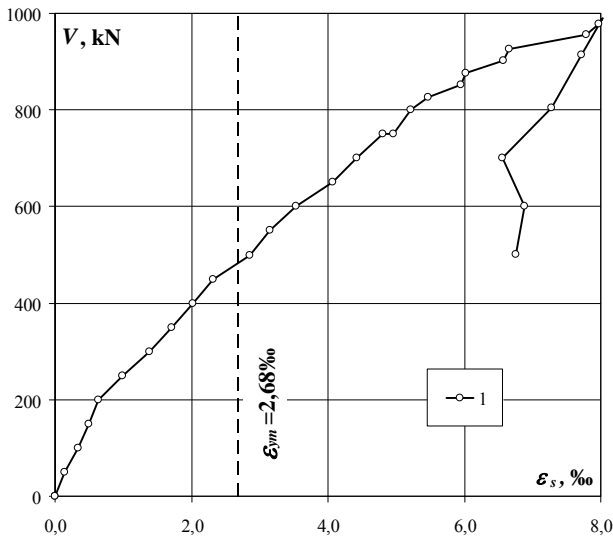

Strzemiona – odkształcenia po stronie S i N (ϵ_s) / Stirrups – strains on S and N side (ϵ_s)

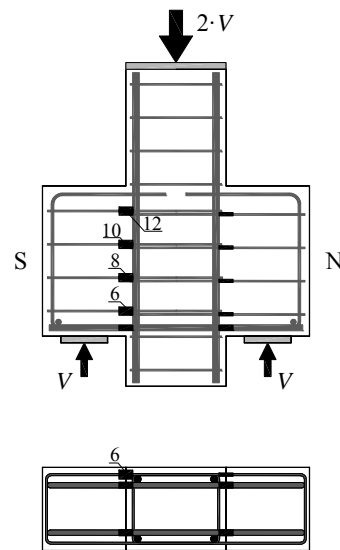
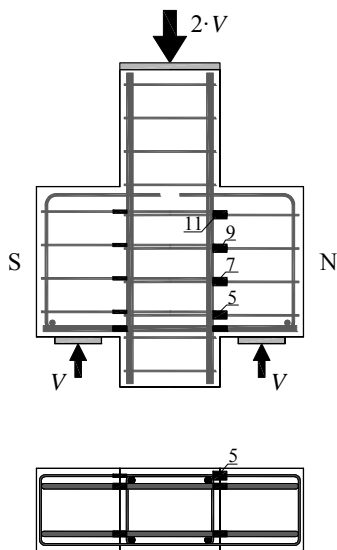
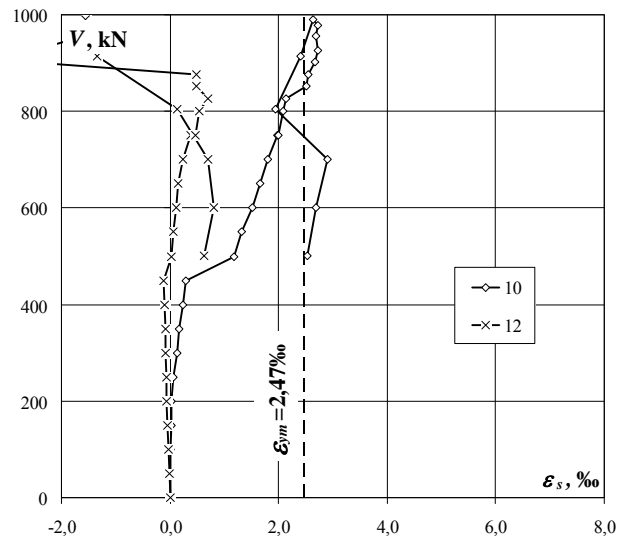
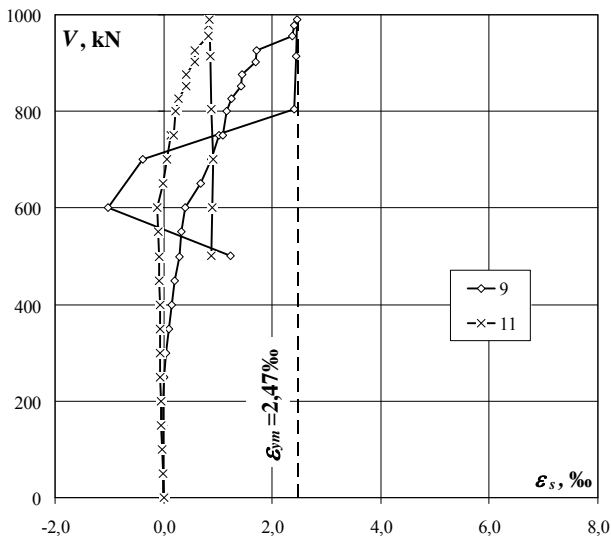
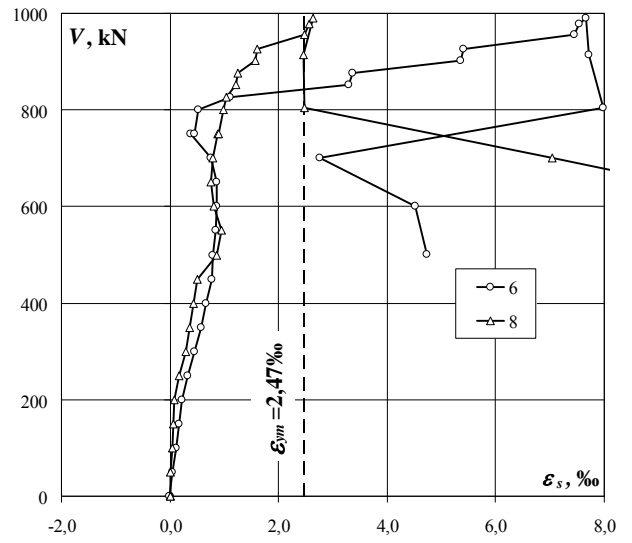
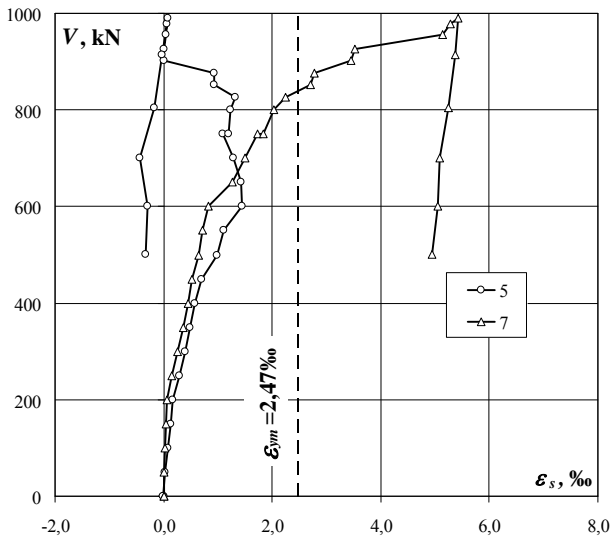

F-0

Odształcenia powierzchni betonu / Strains of concrete surface

obciążenie wspornika corbel load	przesunięcia wg systemu Aramis displacement according to Aramis System									
	1'	2'	3'	4'	5'	6'	7'	8'	9'	
	‰	‰	‰	‰	‰	‰	‰	‰	‰	‰
0	0,05	-0,08	0,06	-0,01	0,01	0,05	0,06	-0,05	0,01	
50	0,39	-0,19	0,31	0,22	-0,08	0,29	0,33	-0,01	0,25	
100	0,19	-0,03	0,43	0,08	0,22	0,25	0,23	-0,03	0,21	
150	0,26	0,19	0,30	0,14	0,23	0,24	0,36	-0,14	0,18	
200	0,39	0,20	0,41	0,14	0,10	0,30	0,44	-0,13	0,05	
250	0,59	0,18	0,43	0,15	0,09	0,32	0,45	-0,06	0,00	
300	0,63	0,40	0,38	0,29	0,21	0,28	0,41	-0,01	0,12	
350	0,78	0,36	0,59	0,22	0,29	0,29	0,28	0,09	-0,02	
400	0,76	0,27	0,69	0,27	0,24	0,27	0,21	-0,10	-0,08	
450	0,93	0,25	0,74	0,48	0,21	0,34	0,42	-0,25	0,03	
500	1,28	0,29	0,93	0,84	0,17	0,49	0,36	-0,22	0,20	
550	1,17	0,54	1,05	0,95	0,17	0,48	0,25	-0,03	0,06	
600	1,24	0,40	1,38	1,06	0,19	0,65	0,31	-0,06	0,11	
650	1,54	0,35	1,51	1,25	0,19	0,91	0,65	-0,30	0,10	
700	1,69	0,52	1,53	1,17	0,15	1,06	0,53	-0,30	0,18	
750	1,69	0,60	1,69	1,13	0,16	1,19	0,53	-0,20	0,09	
800	1,89	0,49	2,10	1,52	0,20	1,26	0,56	-0,22	0,10	
850	2,07	0,41	2,24	1,57	0,24	1,43	0,77	-0,37	0,18	
900	2,47	0,45	2,60	2,17	0,25	1,73	0,98	-0,44	0,13	
950	2,67	0,57	3,03	3,15	0,09	2,07	1,48	-0,71	0,59	
990	3,19	0,30	3,31	3,20	0,14	2,48	1,64	-0,70	0,80	
750	4,37	0,16	3,29	4,25	0,13	2,35	2,96	-0,81	0,81	

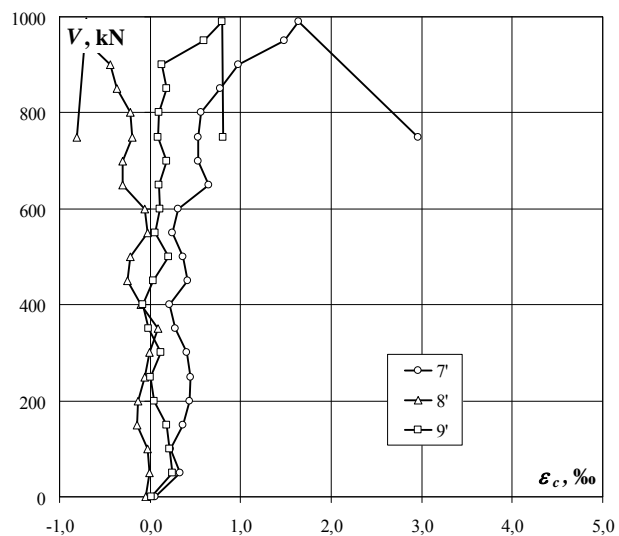
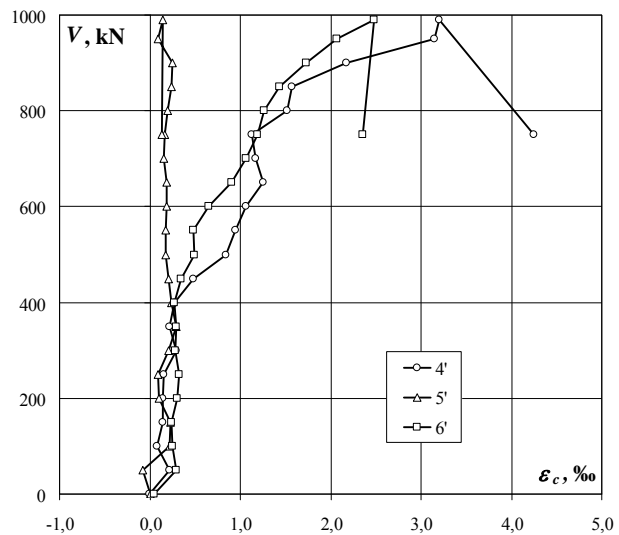
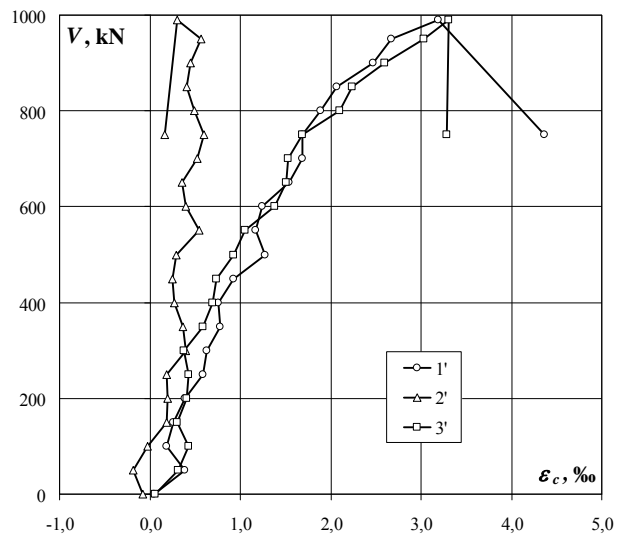
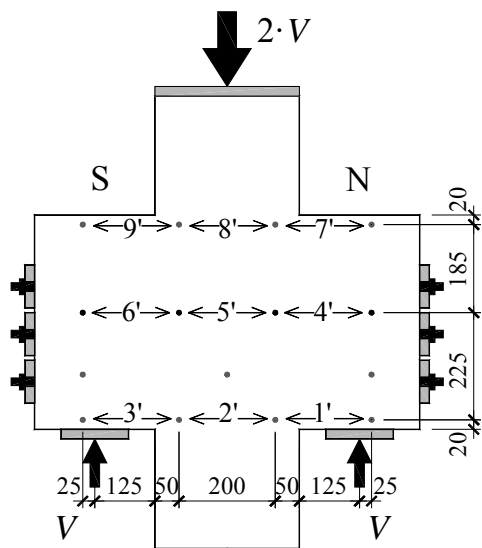

Przemieszczenie słupa względem wsporników / The displacement of the column with respect to the corbels

obciążenie wspornika corbel load	przemieszczenie wg systemu Aramis displacement according to Aramis System
kN	mm
0	0,02
50	0,00
100	0,02
150	0,04
200	0,05
250	0,08
300	0,12
350	0,15
400	0,19
450	0,23
500	0,29
550	0,37
600	0,40
650	0,48
700	0,57
750	0,61
800	0,72
850	0,78
900	1,06
950	1,39
990	1,57
750	2,27

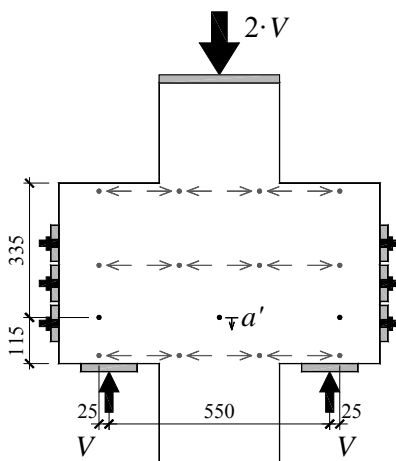
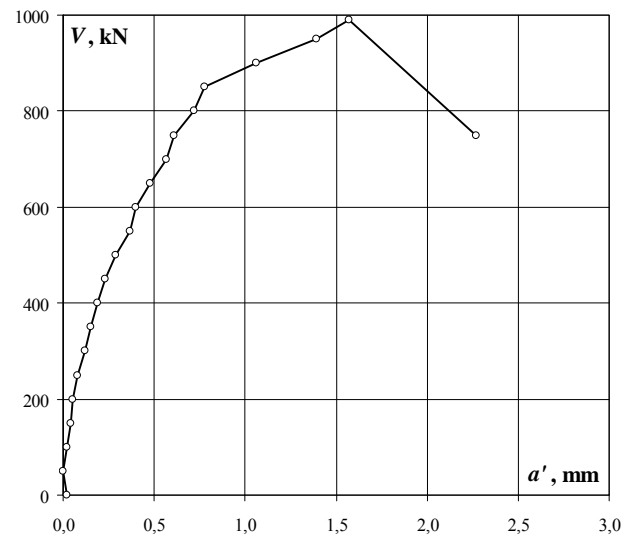

F-0

Szerokość rozwarcia rys / Crack width

obciążenie wspornika corbel load	Numer rysy / Crack number							
	1	2	3	4	5	6	7	8
	mm	mm	mm	mm	mm	mm	mm	mm
50								
100								
150								
200								
250								
300	0,10							
350	0,12							
400	0,15	0,08						
450	0,17	0,10						
500	0,20	0,15	0,10					
500	0,20	0,15	0,12					
500	0,20	0,15	0,13					
550	0,20	0,15	0,15					
600	0,20	0,17	0,20	0,07				
650	0,23	0,20	0,20	0,10				
700	0,23	0,25	0,30	0,20	0,15			
750	0,25	0,17	0,25	0,25	0,20	0,35		
800	0,20	0,30	0,25	0,35	0,25	0,37		

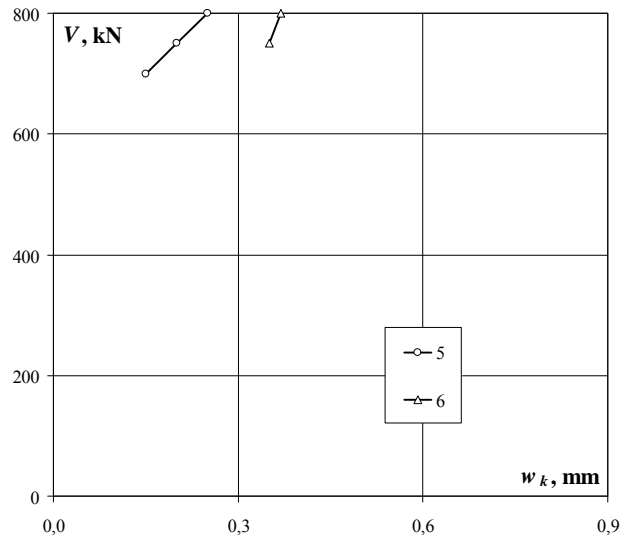
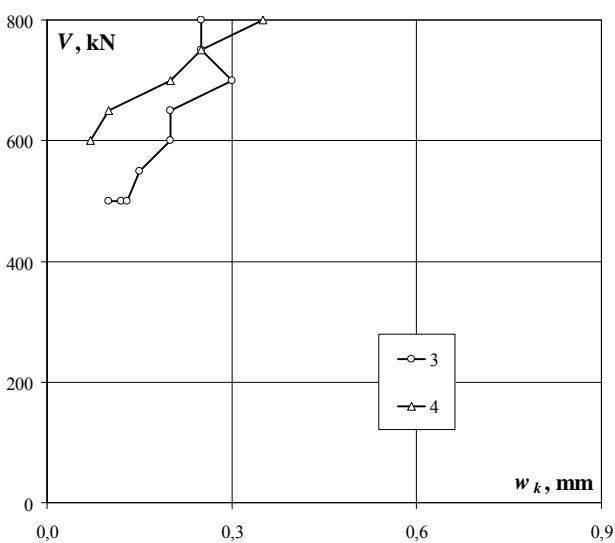
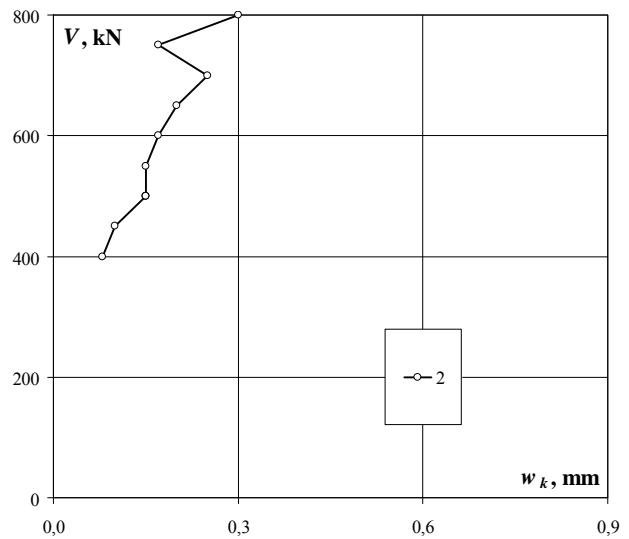
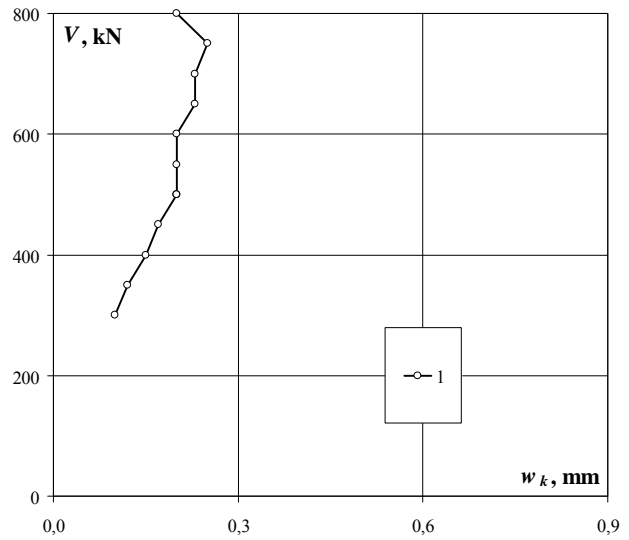

Układ rys przy sile 250kN / Crack pattern at 250kN

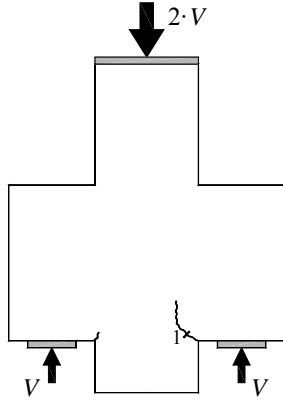

Układ rys przy sile 350kN / Crack pattern at 350kN

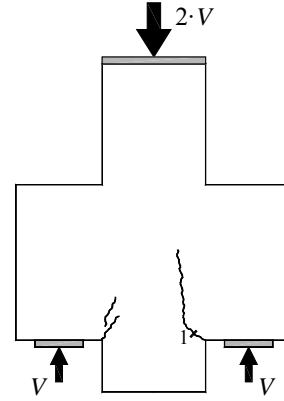

Układ rys przy sile 400kN / Crack pattern at 400kN

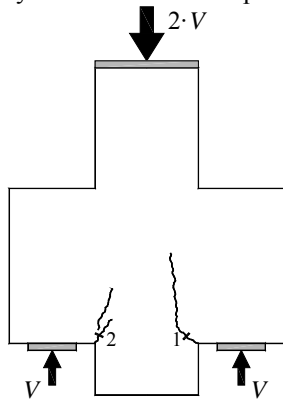

Układ rys przy sile 500kN / Crack pattern at 500kN

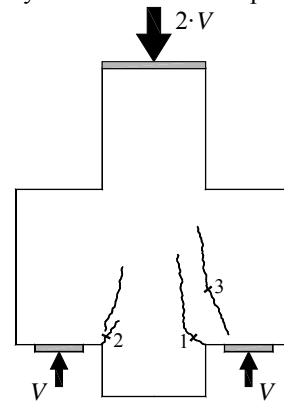

Układ rys przy sile 600kN / Crack pattern at 600kN

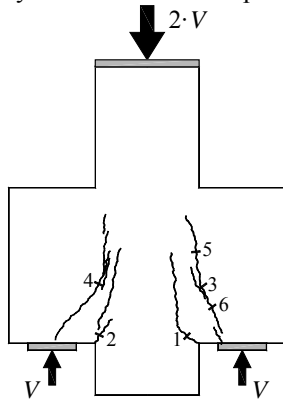

Układ rys przy sile 750kN / Crack pattern at 750kN

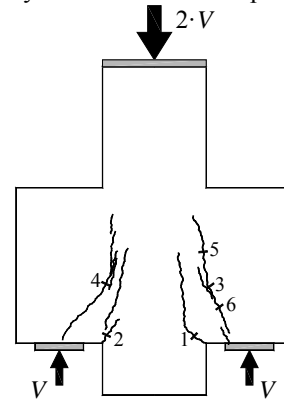

Układ rys przy sile 800kN / Crack pattern at 800kN

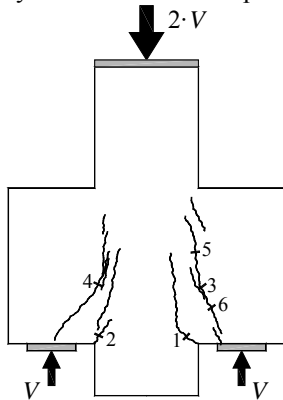

Układ rys przy sile 990kN / Crack pattern at 990kN

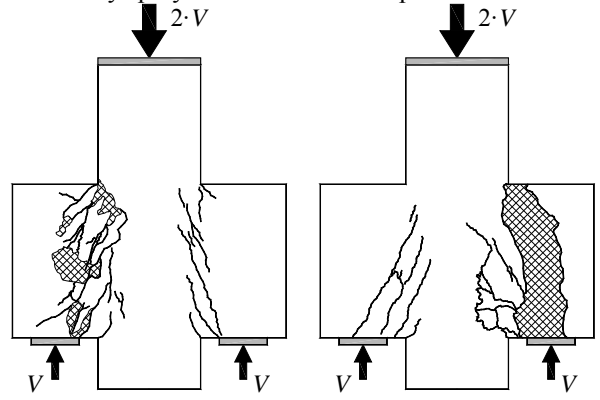

F-0

Szerokość rozwarcia rys według systemu Aramis / Crack width according to Aramis System

obciążenie wspornika corbel load	Numer rysy / Crack number							
	1	2	3	4	5	6	7	8
	mm	mm	mm	mm	mm	mm	mm	mm
0	0,00	0,00	0,00	0,00	0,00	0,00		
0	-0,01	0,04	0,01	-0,01	0,03	0,05		
50	0,01	0,03	0,00	0,01	0,02	0,01		
100	0,03	0,03	0,01	0,01	0,01	0,03		
150	0,04	0,03	0,00	0,02	0,02	0,02		
200	0,07	0,04	0,00	0,02	0,04	0,02		
250	0,07	0,06	0,03	0,00	0,02	0,03		
300	0,08	0,09	0,03	0,00	0,03	0,05		
350	0,10	0,12	0,02	0,01	0,05	0,04		
400	0,12	0,14	0,04	0,01	0,06	0,06		
450	0,15	0,16	0,06	-0,01	0,09	0,08		
500	0,16	0,19	0,13	0,01	0,14	0,19		
550	0,15	0,22	0,16	0,02	0,15	0,22		
600	0,17	0,24	0,18	0,04	0,17	0,24		
650	0,19	0,26	0,19	0,15	0,21	0,27		
700	0,18	0,28	0,22	0,20	0,22	0,34		
750	0,21	0,30	0,27	0,26	0,28	0,42		
800	0,21	0,33	0,29	0,27	0,29	0,45		
850	0,19	0,30	0,34	0,36	0,38	0,56		
850	0,20	0,30	0,33	0,36	0,37	0,57		
900	0,19	0,29	0,36	0,36	0,38	0,57		
900	0,21	0,29	0,40	0,38	0,46	0,66		
900	0,20	0,29	0,41	0,40	0,46	0,67		
950	0,21	0,29	0,44	0,43	0,50	0,69		
950	0,23	0,29	0,49	0,48	0,56	0,76		
950	0,22	0,29	0,51	0,49	0,60	0,80		
950	0,21	0,28	0,58	0,50	0,71	0,87		
1000	0,21	0,27	0,67	0,55	0,80	1,01		
1000	0,21	0,27	0,67	0,55	0,82	1,02		
1000	0,13	0,25	0,94	0,57	1,10	1,32		
750	-0,01	0,22	1,27	0,55	1,38	1,66		
750	-0,05	0,24	1,42	0,54	1,53	1,85		
750	-0,08	0,18	1,69	0,54	1,78	2,17		

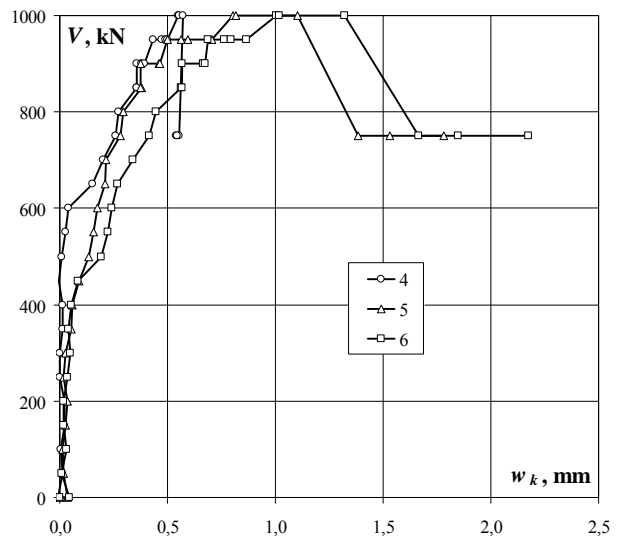
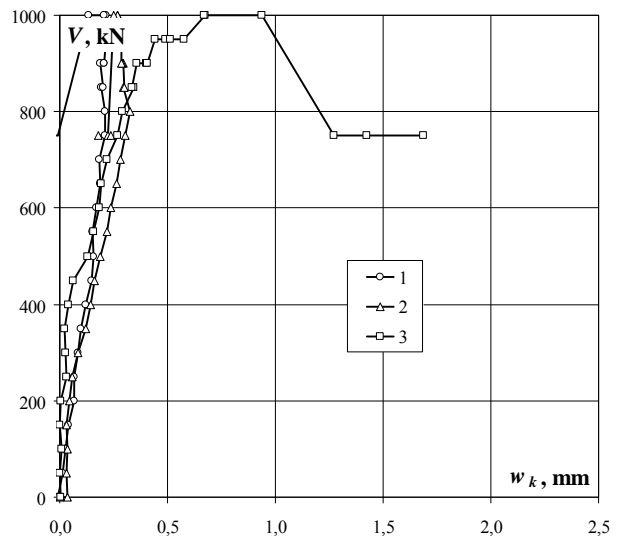

Układ rys przy sile 500kN / Crack pattern at 500kN

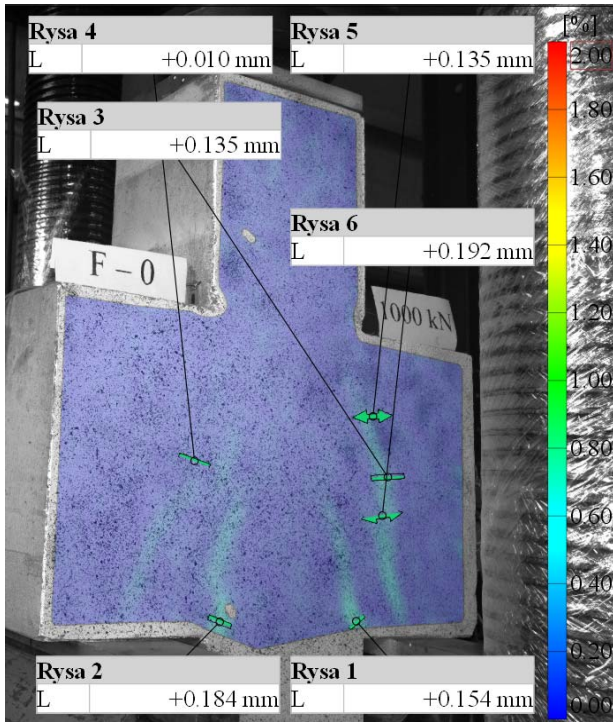

Układ rys przy sile 700kN / Crack pattern at 700kN

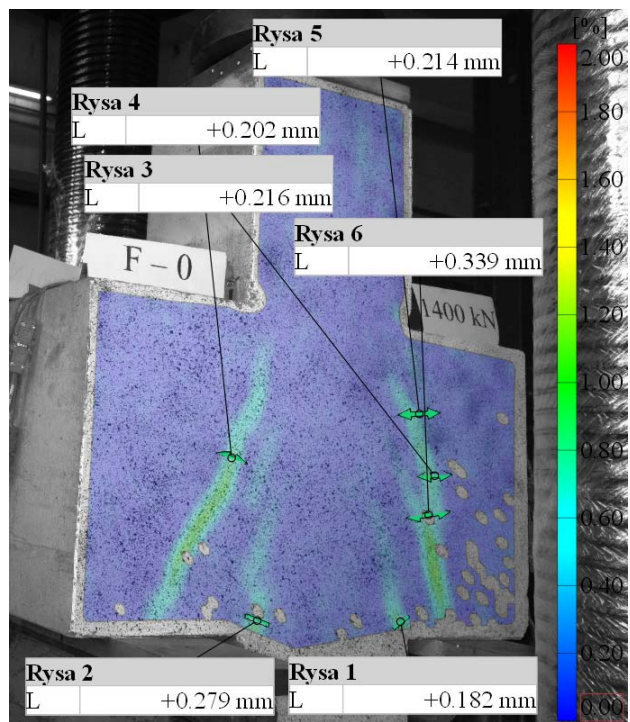

Układ rys przy sile 900kN / Crack pattern at 900kN

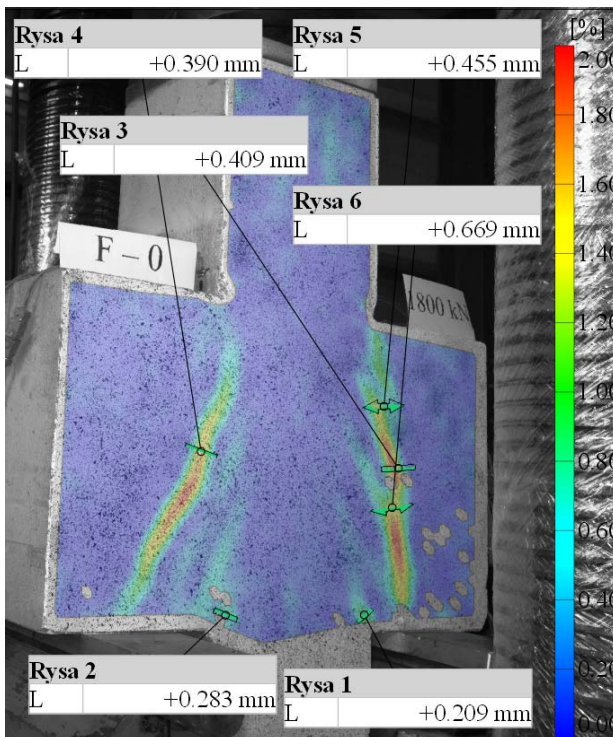

Układ rys przy sile 950kN / Crack pattern at 950kN

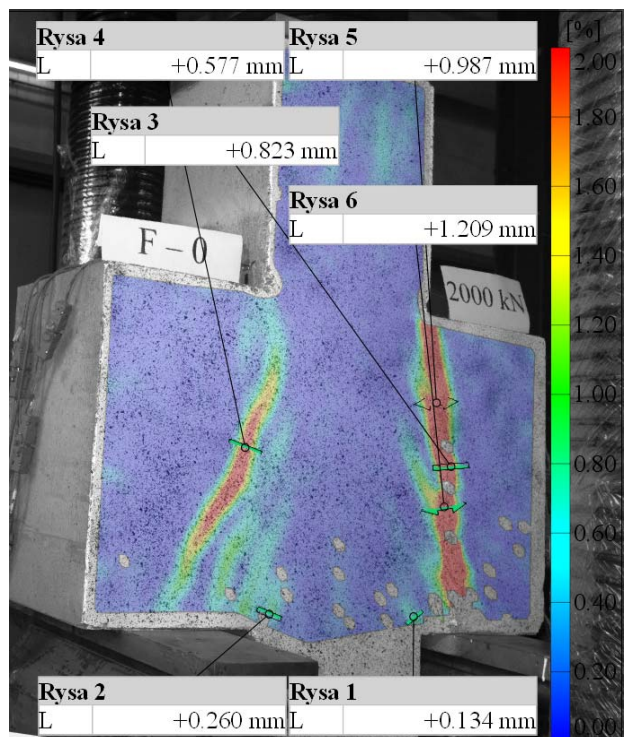

F-0

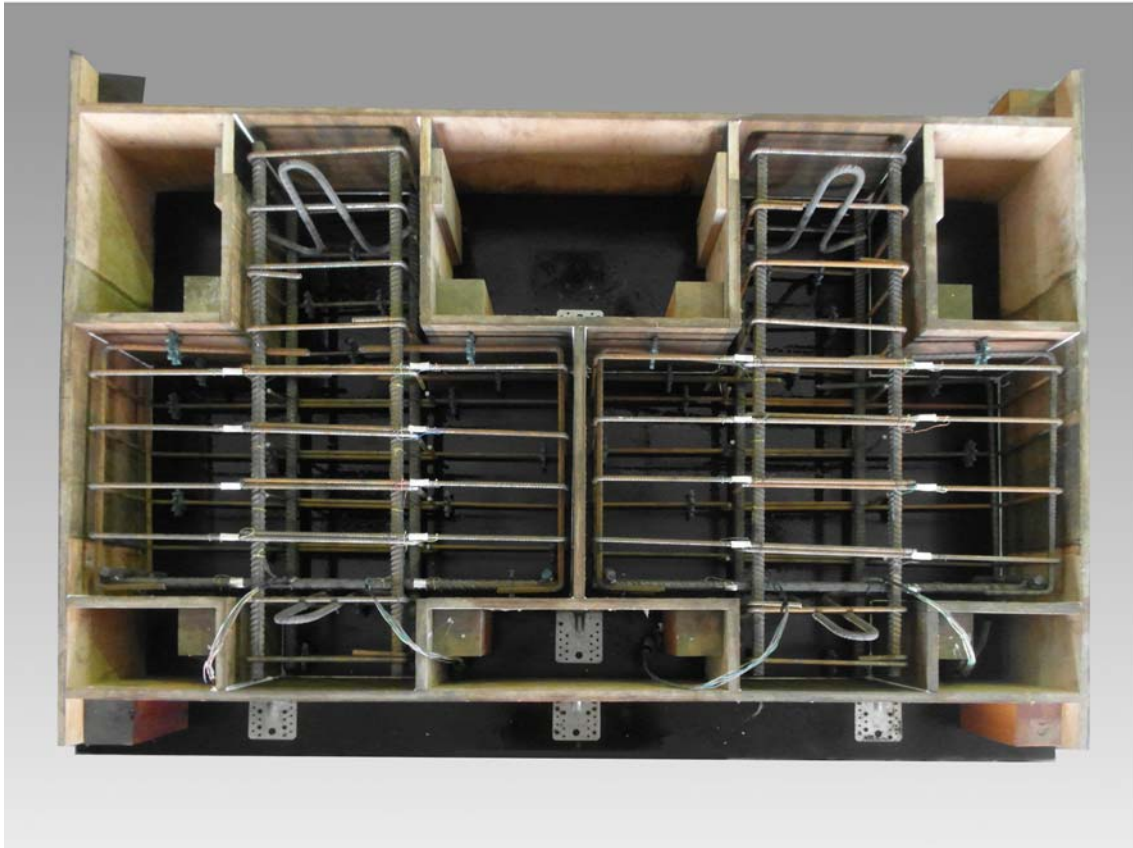

Wsporniki przed betonowaniem / Corbels before casting of concrete

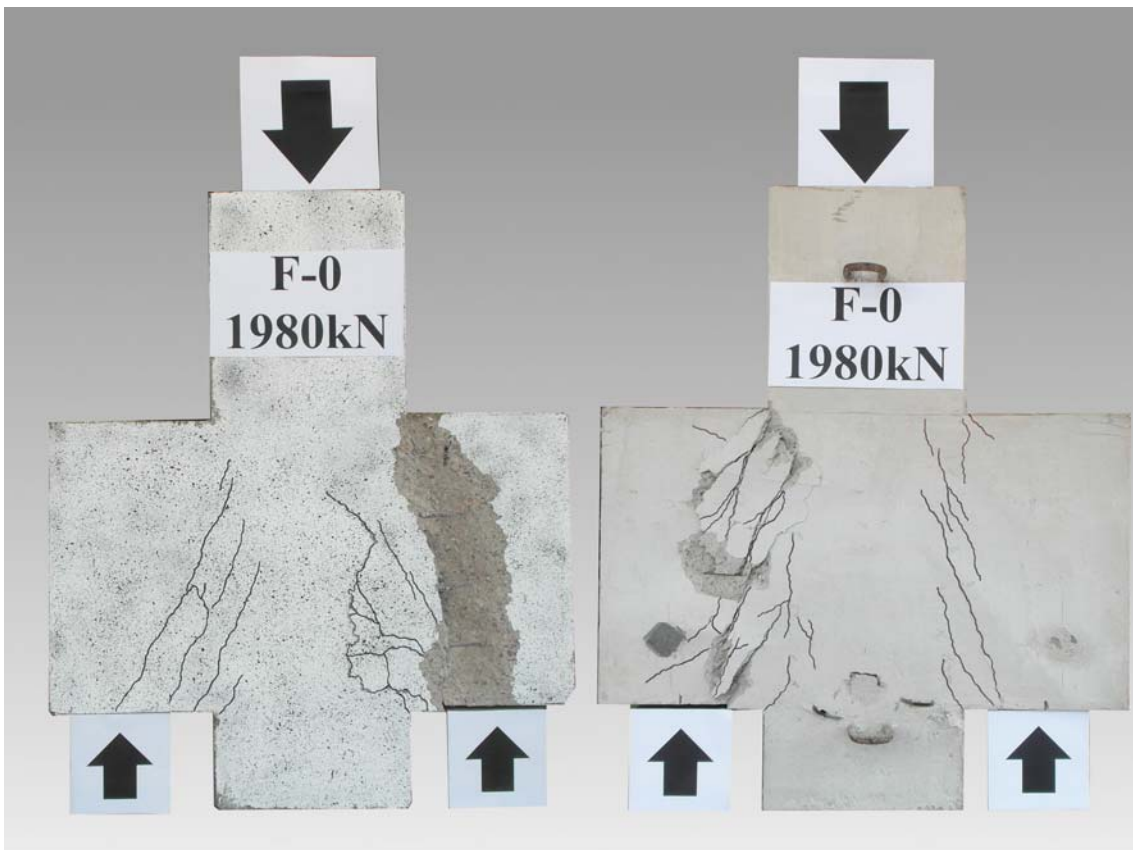

Wspornik po zniszczeniu / Corbel after failure

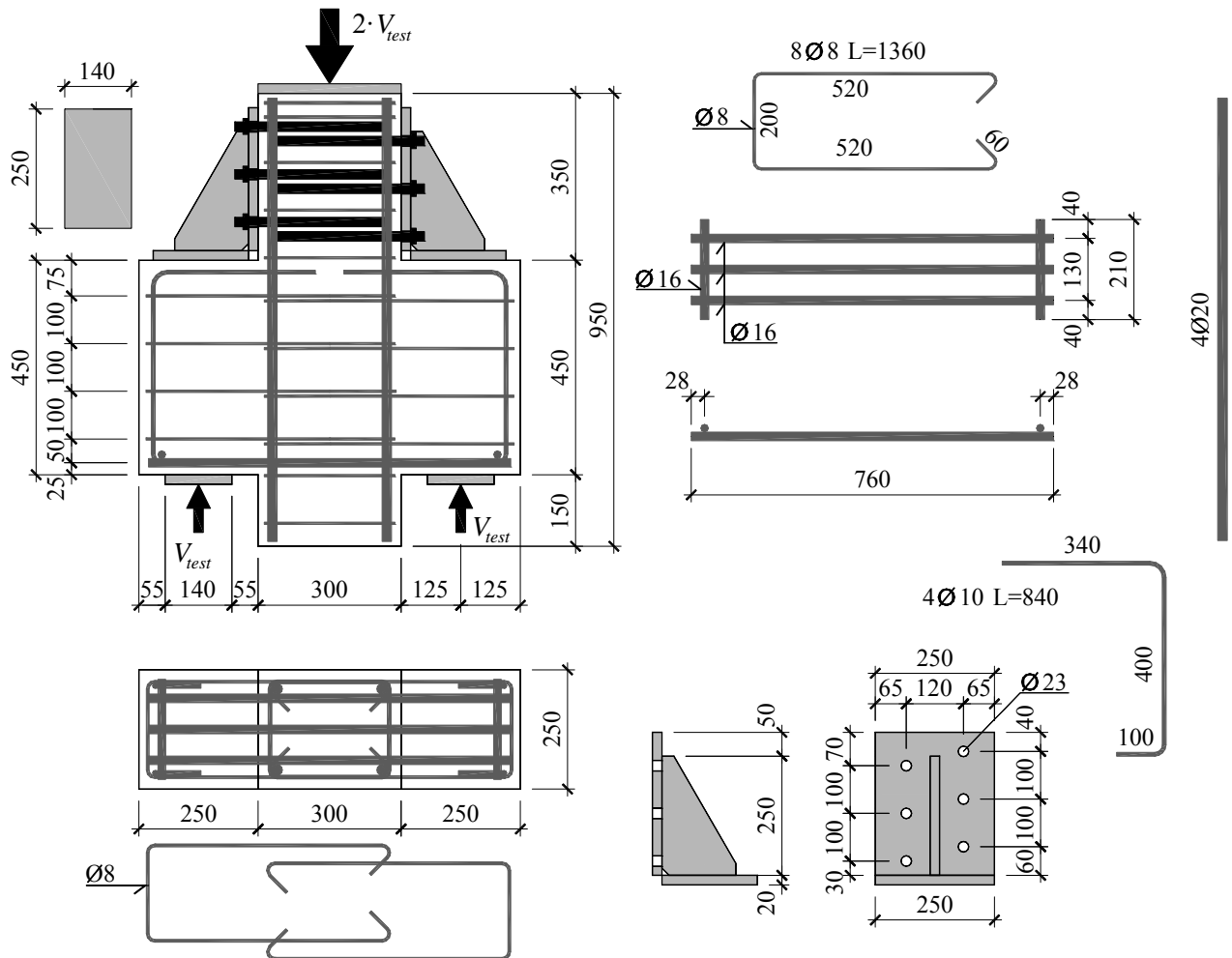

Zbrojenie modelu / Specimen's reinforcement

Wytrzymałość betonu na ściskanie / Compressive strength of concrete

$$f_{cm} = 35,22 \text{MPa}$$

Moduł sprężystości podłużnej / Young's modulus

$$E_{cm} = 26,1 \text{GPa}$$

Wytrzymałość betonu na rozciąganie przy rozłupywaniu / Tensile splitting strength of concrete

$$f_{ct,sp} = 3,47 \text{MPa}$$

Gęstość betonu / Density of concrete

$$\rho = 2250 \text{kg/m}^3$$

Charakterystyka zbrojenia / Characteristics of the reinforcement

Ø8

$$A_s = 49,77 \text{mm}^2, f_{ym} = 499,6 \text{MPa}, f_{tm} = 582,9 \text{MPa}$$

Ø10

$$A_s = 77,60 \text{mm}^2, f_{ym} = 530,3 \text{MPa}, f_{tm} = 639,0 \text{MPa}$$

Ø16

$$A_s = 201,36 \text{mm}^2, f_{ym} = 534,8 \text{MPa}, f_{tm} = 633,8 \text{MPa}$$

M20

$$A_s = 227,78 \text{mm}^2, f_{ym} = 856,4 \text{MPa}, f_{tm} = 947,1 \text{MPa}$$

Siła niszcząca / Failure force

$$V_{rest} = 1390 \text{kN}$$

F-I

Zbrojenie główne – odkształcenia po stronie S i N (ε_s) / Main reinforcement – strains on S and N side (ε_s)

obciążenie wspornika corbel load	odkształcenie S S strain			odkształcenie N N strain		
	1	2	średnia/ average	3	4	średnia/ average
kN	‰	‰	‰	‰	‰	‰
0	0,000	0,000	0,000	0,000	0,000	0,000
50	0,057	0,107	0,082	0,075	0,078	0,077
100	0,150	0,229	0,190	0,152	0,177	0,165
150	0,226	0,331	0,279	0,225	0,270	0,248
200	0,301	0,424	0,363	0,287	0,352	0,320
250	0,384	0,505	0,445	0,349	0,431	0,390
300	0,485	0,594	0,540	0,431	0,532	0,482
350	0,603	0,677	0,640	0,563	0,657	0,610
400	0,670	0,764	0,717	0,682	0,751	0,717
450	0,744	1,015	0,880	0,783	0,910	0,847
500	0,916	1,308	1,112	0,840	1,041	0,941
500	0,983	1,106	1,045	0,801	1,221	1,011
500	0,994	1,101	1,048	0,801	1,225	1,013
500	1,028	1,086	1,057	0,802	1,236	1,019
500	1,075	1,072	1,074	0,795	1,231	1,013
500	1,155	1,052	1,104	0,786	1,226	1,006
500	1,226	1,045	1,136	0,782	1,218	1,000
500	1,143	1,040	1,092	0,776	1,219	0,998
550	1,180	1,080	1,130	0,802	1,265	1,034
600	1,215	1,126	1,171	0,834	1,320	1,077
650	1,253	1,171	1,212	0,870	1,384	1,127
700	1,294	1,222	1,258	0,910	1,442	1,176
750	1,312	1,251	1,282	0,970	1,544	1,257
800	1,345	1,263	1,304	1,045	1,658	1,352
850	1,379	1,284	1,332	1,076	1,716	1,396
900	1,409	1,295	1,352	1,105	1,769	1,437
950	1,427	1,311	1,369	1,131	1,829	1,480
1000	1,452	1,248	1,350	1,161	1,896	1,529
1050	1,465	1,243	1,354	1,188	1,935	1,562
1050	1,472	1,233	1,353	1,191	1,921	1,556
1100	1,498	1,252	1,375	1,217	1,944	1,581
1100	1,502	1,247	1,375	1,222	1,918	1,570
1150	1,523	1,276	1,400	1,250	1,935	1,593
1150	1,532	1,278	1,405	1,258	1,896	1,577
1200	1,569	1,305	1,437	1,285	1,907	1,596
1200	1,573	1,308	1,441	1,296	1,868	1,582
1250	1,600	1,330	1,465	1,326	1,847	1,587
1274	1,629	1,368	1,499	1,354	1,843	1,599
1299	1,633	1,368	1,501	1,356	1,839	1,598
1325	1,651	1,469	1,560	1,404	1,981	1,693
1354	1,667	1,482	1,575	1,417	1,999	1,708
1369	1,702	1,500	1,601	1,430	2,016	1,723
1352	2,169	1,781	1,975	1,967	2,949	2,458
1326	2,203	1,784	1,994	1,980	2,949	2,465
1300	2,210	1,786	1,998	2,076	2,833	2,455
1272	2,201	1,768	1,985	2,106	2,563	2,335
1250	2,248	1,770	2,009	2,118	2,038	2,078
1224	2,290	1,780	2,035	2,144	1,988	2,066
1199	2,289	1,772	2,031	2,117	1,950	2,034
1171	2,282	1,768	2,025	2,080	1,910	1,995
1154	2,274	1,755	2,015	2,063	1,885	1,974
1123	2,259	1,750	2,005	2,045	1,843	1,944
1102	2,251	1,731	1,991	2,034	1,831	1,933
1075	2,234	1,717	1,976	2,018	1,804	1,911
1049	2,220	1,702	1,961	2,005	1,784	1,895
1023	2,203	1,688	1,946	1,992	1,766	1,879
1000	2,188	1,674	1,931	1,977	1,748	1,863

Zbrojenie główne – odkształcenia po stronie S i N (ϵ_s) / Main reinforcement – strains on S and N side (ϵ_s)

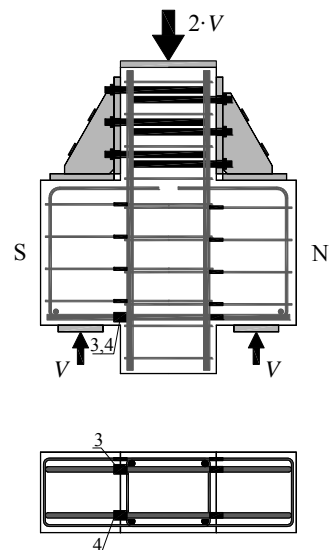
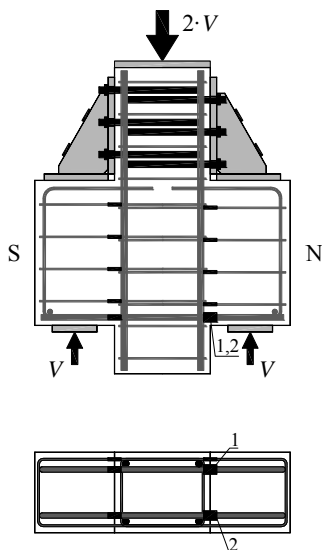
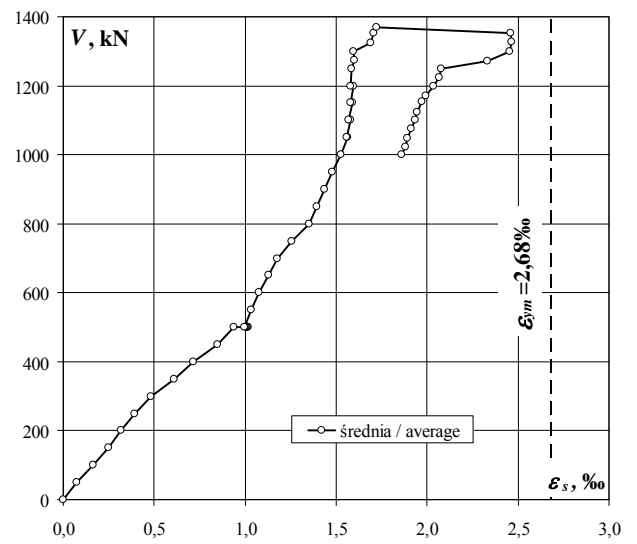
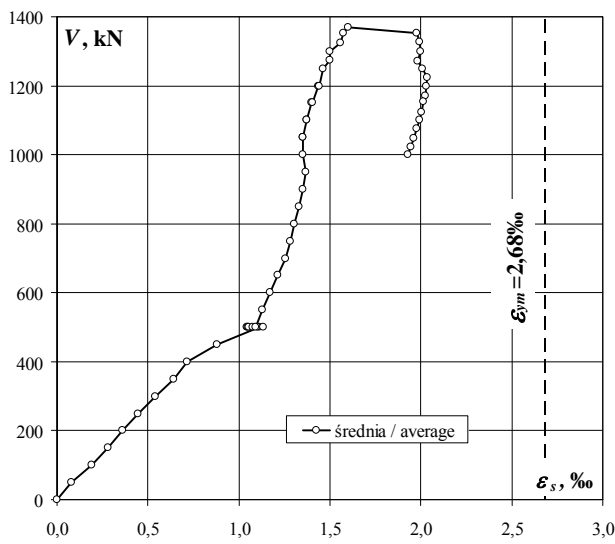
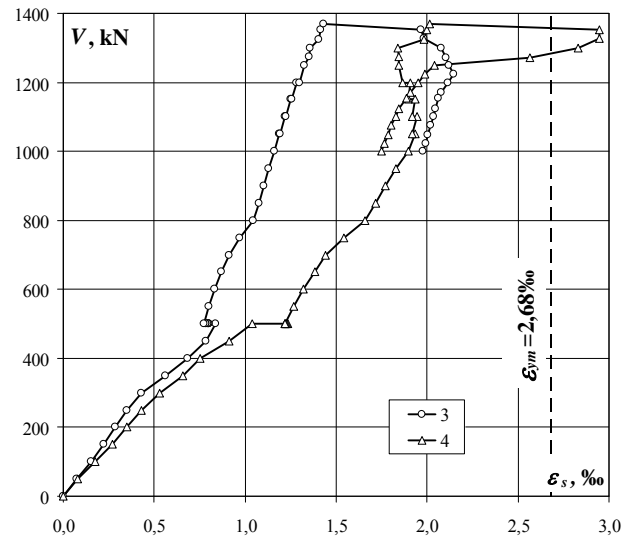
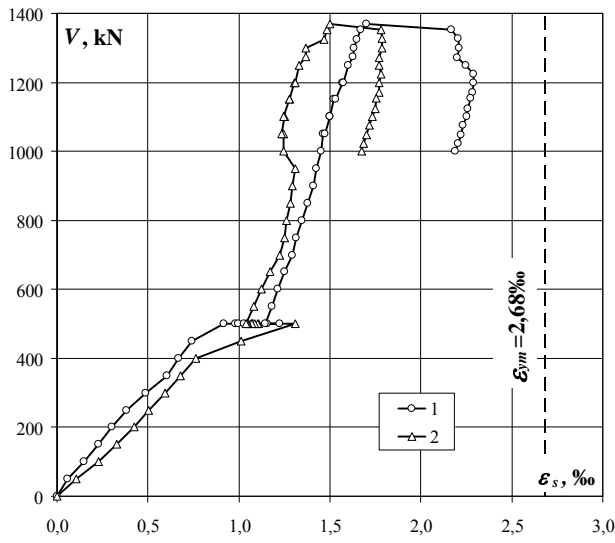

F-I

Strzemiona – odkształcenia po stronie S i N (ϵ_s) / Stirrups – strains on S and N side (ϵ_s)

obciążenie wspornika corbel load	odkształcenie S S strain			
	5	7	9	11
kN	‰	‰	‰	‰
0	0,000	0,000	0,000	0,000
50	0,050	0,045	0,009	-0,007
100	0,116	0,099	0,034	-0,012
150	0,177	0,144	0,057	-0,022
200	0,235	0,187	0,078	-0,020
250	0,288	0,226	0,103	-0,021
300	0,343	0,286	0,140	-0,023
350	0,386	0,352	0,188	-0,019
400	0,416	0,419	0,251	-0,013
450	0,442	0,495	0,287	-0,008
500	0,477	0,719	0,405	0,009
500	0,801	1,287	0,622	0,141
500	0,806	1,291	0,623	0,133
500	0,820	1,304	0,642	0,120
500	0,822	1,300	0,638	0,122
500	0,820	1,286	0,612	0,116
500	0,814	1,277	0,582	0,104
500	0,808	1,267	0,570	0,089
550	0,851	1,336	0,603	0,105
600	0,915	1,423	0,648	0,123
650	1,002	1,547	0,706	0,150
700	1,084	1,708	0,761	0,185
750	1,171	1,964	0,816	0,229
800	1,192	2,126	0,885	0,282
850	1,045	2,263	1,018	0,354
900	0,962	2,391	1,117	0,427
950	0,985	2,510	1,244	0,504
1000	0,913	2,622	1,456	0,625
1050	0,927	2,711	1,628	0,735
1050	0,912	2,723	1,686	0,789
1100	0,954	2,827	1,789	0,845
1100	0,913	2,870	1,869	0,926
1150	0,969	3,005	1,978	1,011
1150	0,960	3,060	2,068	1,135
1200	0,956	3,215	2,197	1,232
1200	0,877	3,313	2,329	1,305
1250	0,871	3,667	2,605	1,446
1274	0,636	3,716	2,930	1,584
1299	0,649	3,750	2,959	1,599
1325	0,118	4,005	3,177	1,687
1354	0,144	4,075	3,222	1,714
1369	0,129	4,156	3,289	1,740
1352	-0,359	3,806	3,301	2,471
1326	-0,413	3,770	3,334	2,591
1300	-0,459	3,747	3,377	2,648
1272	-0,490	3,736	3,400	2,655
1250	-0,544	3,791	3,485	2,752
1224	-0,578	3,800	3,529	2,833
1199	-0,609	3,745	3,514	2,811
1171	-0,644	3,672	3,492	2,771
1154	-0,616	3,621	3,472	2,734
1123	-0,573	3,529	3,441	2,682
1102	-0,587	3,475	3,414	2,643
1075	-0,607	3,395	3,380	2,591
1049	-0,627	3,322	3,346	2,550
1023	-0,628	3,251	3,315	2,507
1000	-0,641	3,182	3,290	2,471

obciążenie wspornika corbel load	odkształcenie N N strain			
	6	8	10	12
kN	‰	‰	‰	‰
0	0,000	0,000	0,000	0,000
50	0,045	0,026	0,005	-0,004
100	0,105	0,055	0,026	-0,010
150	0,160	0,087	0,042	-0,013
200	0,214	0,117	0,054	-0,023
250	0,272	0,152	0,076	-0,035
300	0,352	0,189	0,087	-0,029
350	0,491	0,199	0,163	-0,022
400	0,684	0,281	0,247	-0,006
450	0,858	0,345	0,334	0,013
500	1,030	0,364	0,415	0,041
500	1,348	0,248	0,547	0,101
500	1,356	0,247	0,552	0,106
500	1,387	0,226	0,558	0,092
500	1,397	0,213	0,556	0,102
500	1,400	0,190	0,551	0,097
500	1,398	0,171	0,540	0,095
500	1,397	0,176	0,528	0,081
550	1,459	0,200	0,551	0,089
600	1,529	0,222	0,581	0,104
650	1,606	0,228	0,627	0,124
700	1,703	0,230	0,676	0,143
750	1,885	0,194	0,805	0,198
800	1,818	0,043	1,020	0,423
850	1,768	0,203	1,114	0,546
900	1,713	0,300	1,192	0,656
950	1,652	0,396	1,258	0,778
1000	1,546	0,500	1,357	0,947
1050	1,555	0,583	1,462	1,098
1050	1,523	0,609	1,473	1,165
1100	1,531	0,658	1,541	1,239
1100	1,395	0,690	1,594	1,336
1150	1,370	0,735	1,685	1,426
1150	1,262	0,765	1,761	1,568
1200	1,258	0,815	1,861	1,678
1200	1,178	0,859	1,875	1,853
1250	1,074	0,973	2,048	2,128
1274	0,809	1,127	2,209	2,837
1299	0,818	1,137	2,232	2,859
1325	0,759	1,383	0,385	3,589
1354	0,781	1,410	0,685	3,626
1369	0,786	1,484	0,832	3,681
1352	3,715	2,075	3,739	6,823
1326	4,348	2,150	3,596	6,662
1300	4,778	2,214	3,496	7,428
1272	5,047	2,271	3,347	8,574
1250	4,868	2,203	3,354	8,068
1224	4,827	2,188	3,461	7,561
1199	4,770	2,161	3,451	7,251
1171	4,696	2,144	3,429	6,954
1154	4,649	2,135	3,408	6,802
1123	4,579	2,114	3,383	6,564
1102	4,526	2,110	3,350	6,445
1075	4,468	2,097	3,318	6,298
1049	4,419	2,084	3,288	6,172
1023	4,376	2,072	3,262	6,064
1000	4,338	2,064	3,232	5,971

Strzemiona – odkształcenia po stronie S i N (ϵ_s) / Stirrups – strains on S and N side (ϵ_s)

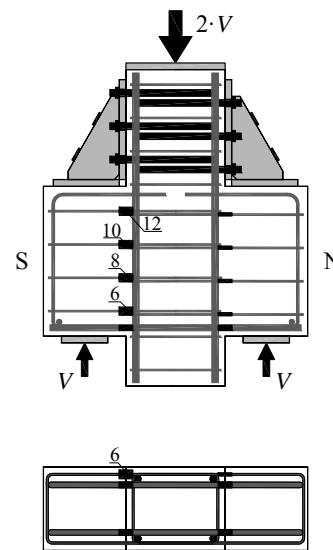
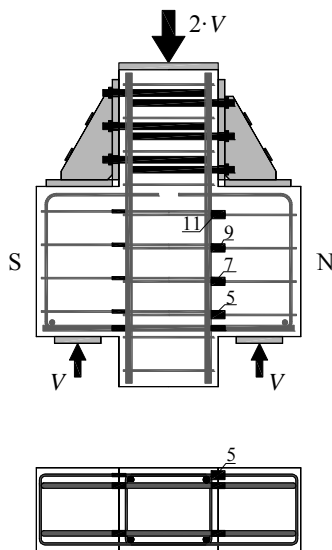
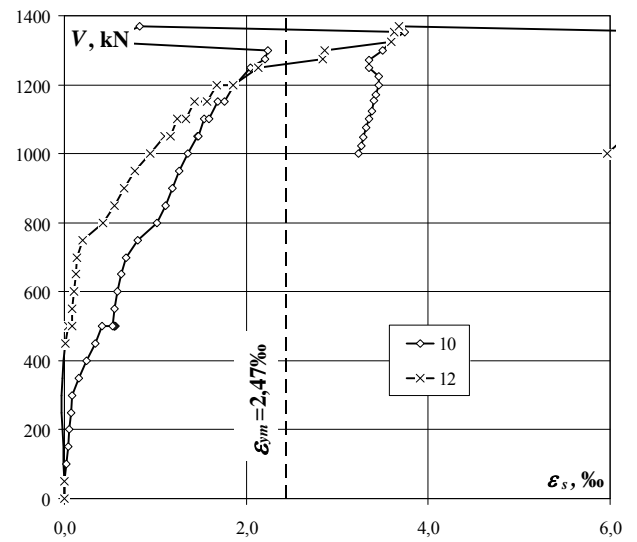
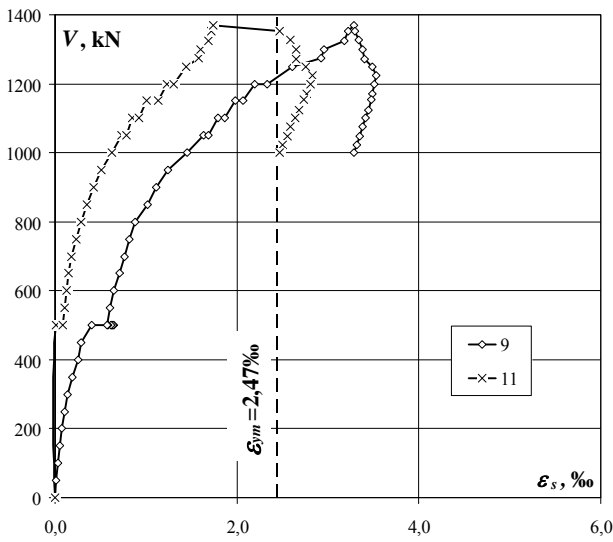
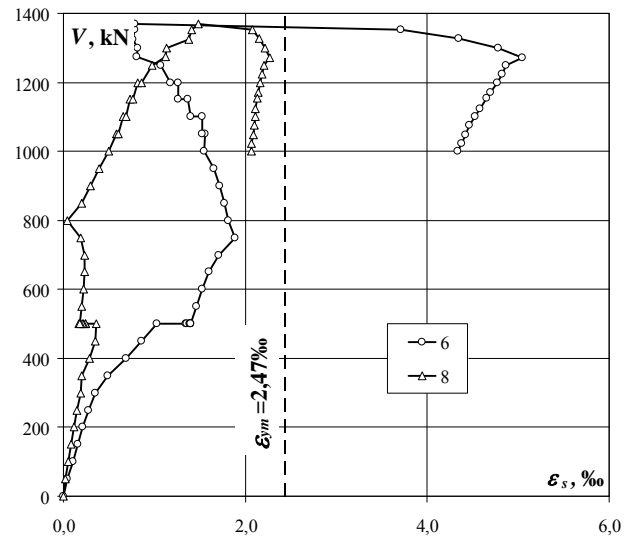
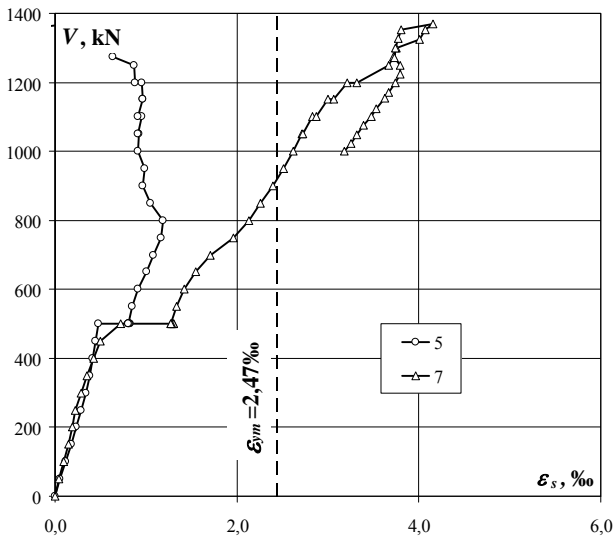

F-I

Akcesorium – odkształcenia po stronie S i N (ϵ_s) / Accessory – strains on S and N side (ϵ_s)

obciążenie wspornika corbel load	odkształcenie S S strain			odkształcenie N N strain		
	13	14	średnia/ average	15	16	średnia/ average
	kN	‰	‰	‰	‰	‰
0	0,000	0,000	0,000	0,000	0,000	0,000
50	-0,002	0,000	-0,001	-0,016	-0,030	-0,023
100	-0,002	-0,001	-0,002	-0,020	-0,032	-0,026
150	-0,003	-0,001	-0,002	-0,024	-0,033	-0,029
200	-0,005	0,000	-0,003	-0,023	-0,036	-0,030
250	-0,007	0,000	-0,004	-0,022	-0,036	-0,029
300	-0,009	0,000	-0,005	-0,019	-0,036	-0,028
350	-0,013	0,000	-0,007	-0,021	-0,035	-0,028
400	-0,014	-0,001	-0,008	-0,025	-0,036	-0,031
450	-0,017	-0,001	-0,009	-0,023	-0,036	-0,030
500	-0,019	0,000	-0,010	-0,023	-0,035	-0,029
500	-0,044	-0,008	-0,026	-0,042	-0,055	-0,048
500	-0,045	-0,006	-0,026	-0,060	-0,074	-0,067
500	-0,094	-0,027	-0,061	-0,126	-0,081	-0,104
500	-0,109	-0,029	-0,069	-0,144	-0,084	-0,114
500	-0,163	-0,050	-0,107	-0,242	-0,111	-0,177
500	-0,189	-0,081	-0,135	-0,306	-0,131	-0,219
500	-0,239	-0,091	-0,165	-0,321	-0,137	-0,229
550	-0,267	-0,119	-0,193	-0,348	-0,165	-0,257
600	-0,295	-0,148	-0,222	-0,374	-0,193	-0,284
650	-0,326	-0,182	-0,254	-0,403	-0,226	-0,315
700	-0,362	-0,220	-0,291	-0,437	-0,263	-0,350
750	-0,417	-0,276	-0,347	-0,481	-0,311	-0,396
800	-0,481	-0,346	-0,414	-0,528	-0,361	-0,445
850	-0,533	-0,406	-0,470	-0,578	-0,414	-0,496
900	-0,582	-0,475	-0,529	-0,626	-0,464	-0,545
950	-0,638	-0,551	-0,595	-0,678	-0,520	-0,599
1000	-0,701	-0,618	-0,660	-0,738	-0,582	-0,660
1050	-0,761	-0,681	-0,721	-0,791	-0,639	-0,715
1050	-0,779	-0,699	-0,739	-0,807	-0,658	-0,733
1100	-0,820	-0,741	-0,781	-0,843	-0,699	-0,771
1100	-0,843	-0,765	-0,804	-0,866	-0,723	-0,795
1150	-0,883	-0,807	-0,845	-0,904	-0,765	-0,835
1150	-0,907	-0,830	-0,869	-0,944	-0,790	-0,867
1200	-0,949	-0,875	-0,912	-0,990	-0,834	-0,912
1200	-0,980	-0,906	-0,943	-1,040	-0,867	-0,954
1250	-1,046	-0,975	-1,011	-1,142	-0,945	-1,044
1274	-1,104	-1,030	-1,067	-1,318	-1,007	-1,163
1299	-1,121	-1,046	-1,084	-1,335	-1,025	-1,180
1325	-1,184	-1,102	-1,143	-1,455	-1,169	-1,312
1354	-1,200	-1,120	-1,160	-1,472	-1,204	-1,338
1369	-1,212	-1,133	-1,173	-1,487	-1,231	-1,359
1352	-1,254	-1,199	-1,227	-1,772	-1,532	-1,652
1326	-1,268	-1,185	-1,227	-1,775	-1,532	-1,654
1300	-1,263	-1,162	-1,213	-1,779	-1,529	-1,654
1272	-1,248	-1,140	-1,194	-1,778	-1,523	-1,651
1250	-1,252	-1,130	-1,191	-1,809	-1,542	-1,676
1224	-1,249	-1,125	-1,187	-1,822	-1,545	-1,684
1199	-1,238	-1,114	-1,176	-1,815	-1,534	-1,675
1171	-1,223	-1,101	-1,162	-1,803	-1,518	-1,661
1154	-1,213	-1,094	-1,154	-1,795	-1,509	-1,652
1123	-1,200	-1,078	-1,139	-1,776	-1,492	-1,634
1102	-1,185	-1,067	-1,126	-1,767	-1,478	-1,623
1075	-1,168	-1,053	-1,111	-1,752	-1,462	-1,607
1049	-1,153	-1,038	-1,096	-1,739	-1,446	-1,593
1023	-1,137	-1,023	-1,080	-1,724	-1,432	-1,578
1000	-1,122	-1,008	-1,065	-1,710	-1,417	-1,564

Akcesorium – odkształcenia po stronie S i N (ϵ_s) / Accessory – strains on S and N side (ϵ_s)

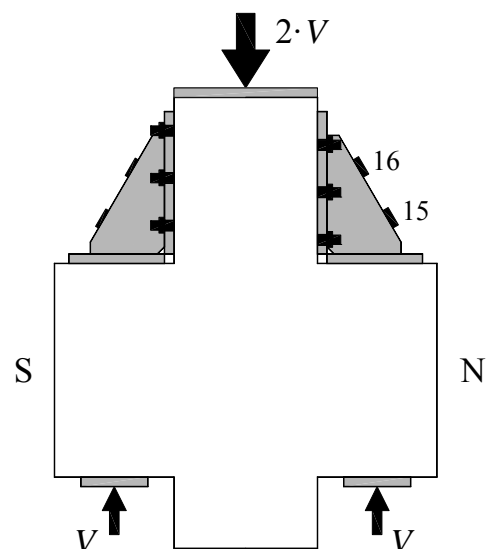
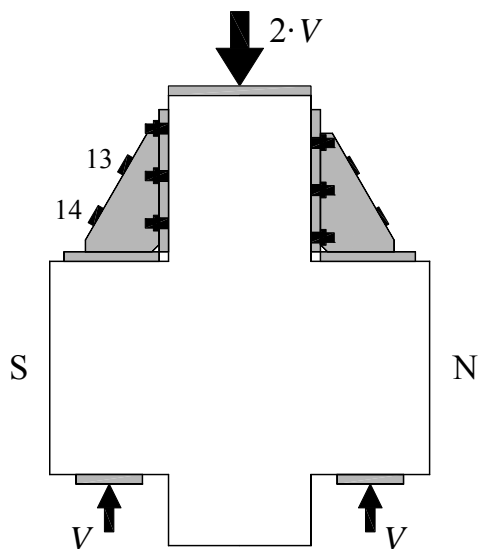
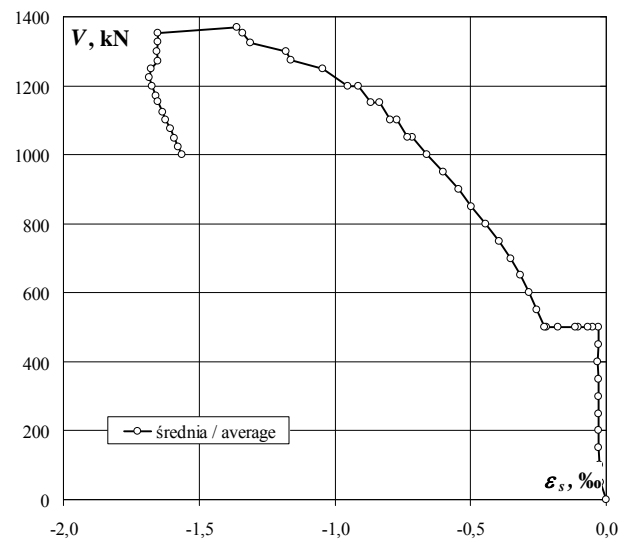
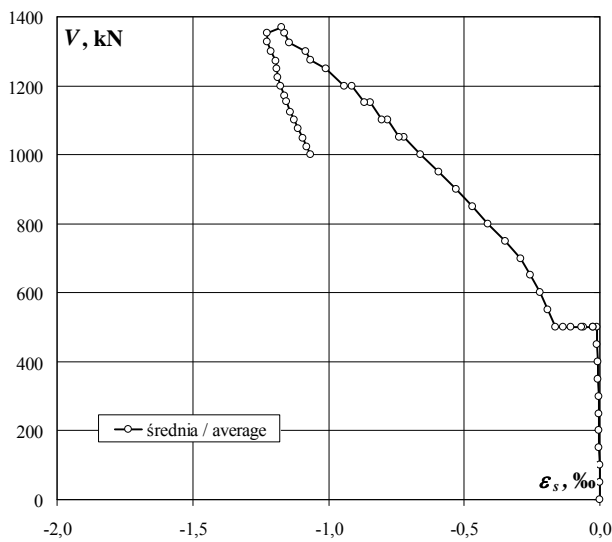
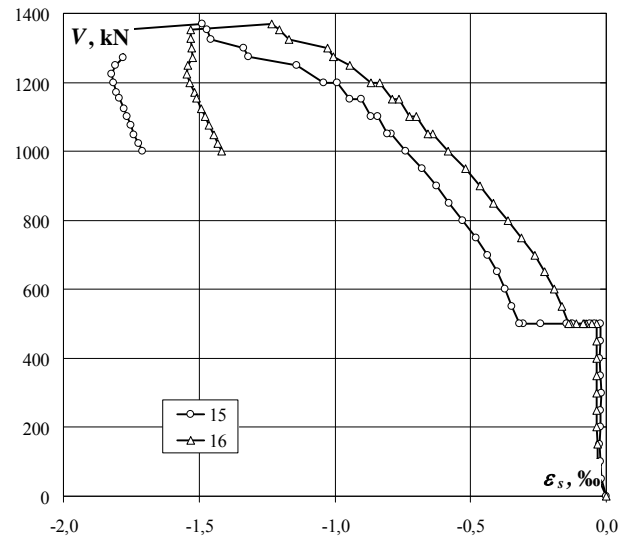
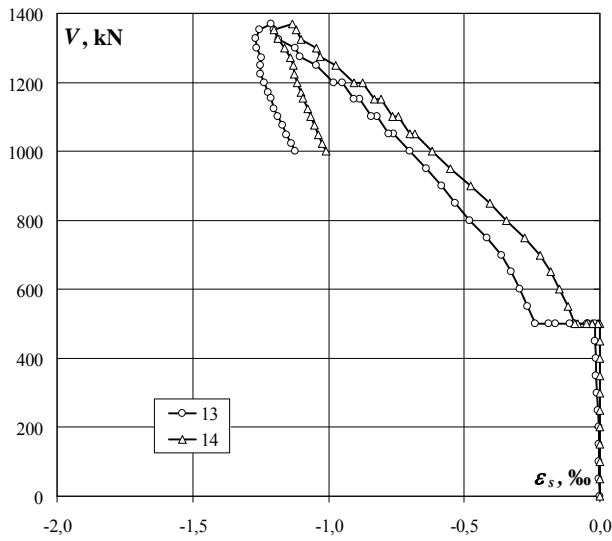

F-I

Odształcenia powierzchni betonu / Strains of concrete surface

obciążenie wspornika corbel load kN	przesunięcia wg systemu Aramis displacement according to Aramis System								
	1'	2'	3'	4'	5'	6'	7'	8'	9'
	‰	‰	‰	‰	‰	‰	‰	‰	‰
0	0,00	0,00	0,00	0,00	0,00	0,00	0,00	0,00	0,00
50	-0,23	0,23	0,02	0,10	-0,07	0,07	-0,20	0,22	-0,28
100	0,07	0,03	0,14	0,03	0,27	-0,15	0,09	-0,03	0,06
150	0,00	0,24	0,17	0,27	0,30	-0,28	0,33	-0,25	-0,03
200	0,33	0,17	0,09	0,47	-0,21	-0,05	0,10	-0,22	0,06
250	0,34	0,16	0,19	0,58	-0,28	0,05	-0,08	-0,16	0,03
300	0,40	0,09	0,39	0,36	-0,12	-0,09	-0,08	-0,18	0,05
350	0,39	0,09	0,44	0,49	0,09	-0,11	-0,15	-0,15	-0,03
400	0,56	-0,05	0,49	0,40	-0,06	0,05	-0,33	-0,21	-0,10
450	0,67	0,00	0,67	0,53	-0,28	0,22	-0,13	-0,14	-0,18
500	0,62	0,02	1,23	0,00	0,33	0,16	-0,33	-0,66	-0,03
550	0,69	0,14	1,23	0,05	0,35	0,13	-0,22	-0,69	0,03
600	0,69	0,23	1,09	0,12	0,30	0,16	-0,21	-0,64	-0,02
650	0,81	0,28	1,04	0,39	0,02	0,47	-0,29	-0,59	-0,06
700	1,01	0,14	1,14	0,67	-0,23	0,68	-0,18	-0,45	-0,18
750	1,12	0,06	1,31	0,71	-0,08	0,58	-0,24	-0,39	-0,08
800	1,23	0,16	1,30	0,68	0,13	0,51	-0,11	-0,47	-0,04
850	1,37	0,11	1,41	0,76	0,16	0,52	-0,21	-0,49	-0,04
900	1,40	0,28	1,47	0,97	-0,08	0,90	-0,29	-0,41	-0,04
950	1,55	0,40	1,45	1,39	-0,32	1,06	-0,02	-0,23	-0,12
1000	1,67	0,35	1,59	1,35	-0,31	1,16	-0,05	-0,25	-0,06
1050	1,74	0,28	1,81	1,35	0,05	1,09	0,01	-0,31	0,01
1100	1,82	0,31	1,92	1,62	-0,13	1,38	-0,03	-0,20	-0,06
1150	1,93	0,28	1,98	2,08	-0,18	1,72	0,18	0,07	0,00
1200	2,19	0,14	2,07	1,84	-0,18	1,68	0,06	-0,17	0,05
1250	2,50	0,08	2,45	2,32	0,08	2,15	0,43	-0,20	0,36
1300	2,75	0,34	2,75	2,70	-0,15	2,73	0,60	-0,12	0,62
1350	3,23	0,17	3,03	3,57	-0,10	3,36	1,25	-0,20	0,90
1390	4,57	-0,07	3,41	7,86	-0,67	4,99	4,45	-0,71	2,32

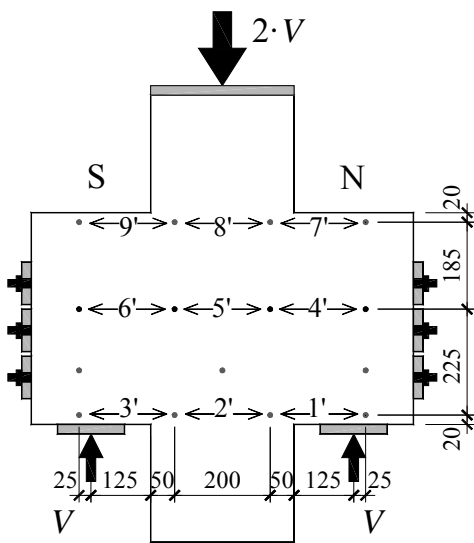
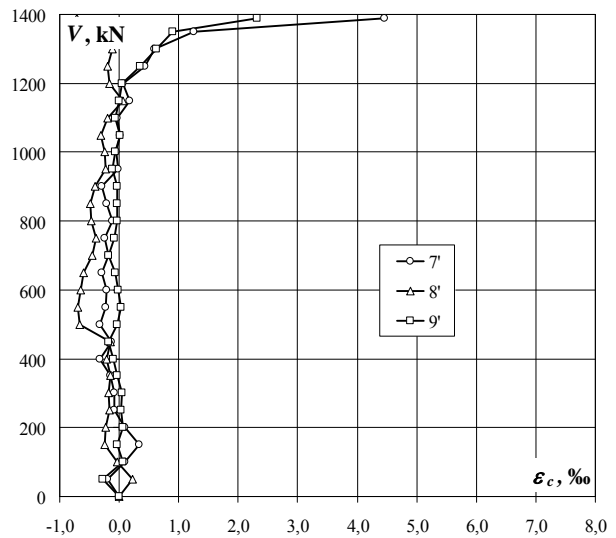
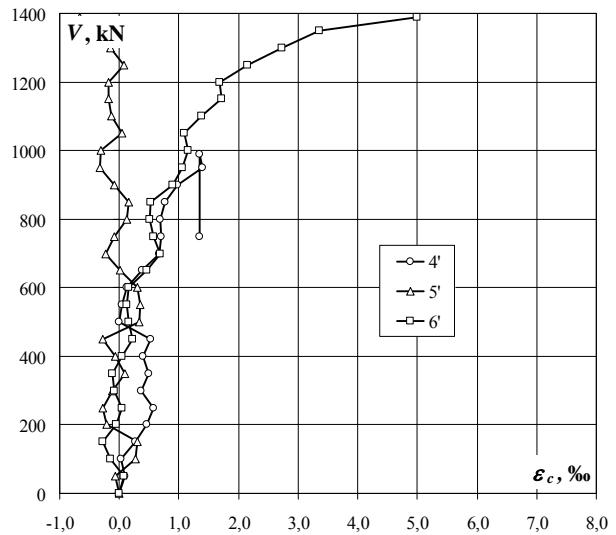
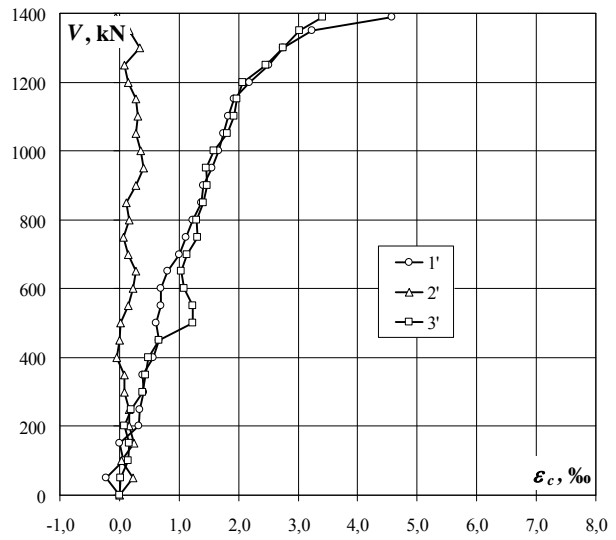

Przeszyczenie słupa wzgłędem wsporników / The displacement of the column with respect to the corbels

obciążenie wspornika corbel load	Przeszyczenie wg systemu Aramis Displacement according to Aramis System
kN	mm
0	0,00
50	0,02
100	0,06
150	0,06
200	0,09
250	0,11
300	0,14
350	0,18
400	0,21
450	0,23
500	0,38
550	0,38
600	0,40
650	0,41
700	0,44
750	0,46
800	0,50
850	0,53
900	0,55
950	0,58
1000	0,64
1050	0,68
1100	0,72
1150	0,77
1200	0,86
1250	0,94
1300	1,05
1350	1,27
1390	2,68

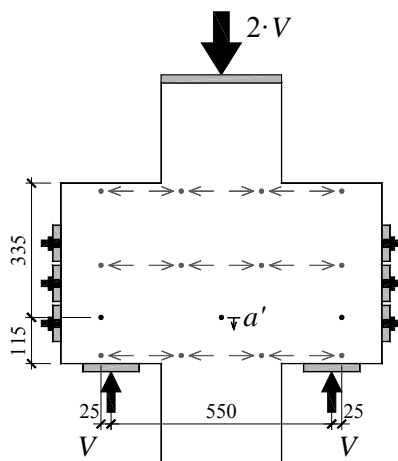
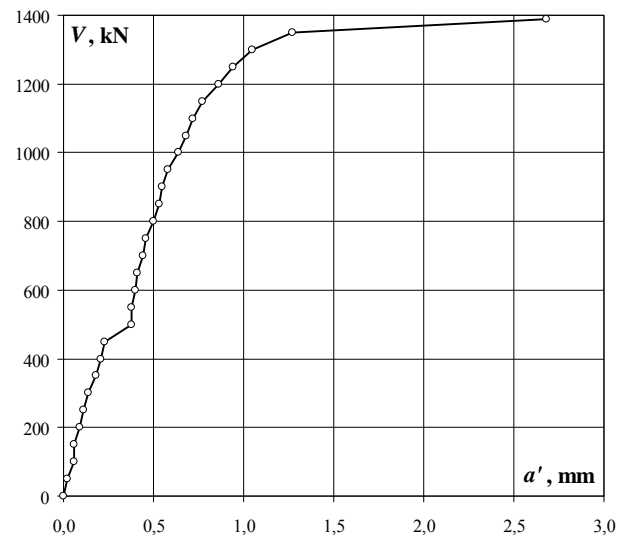

F-I

Szerokość rozwarcia rys / Crack width

obciążenie wspornika corbel load	Numer rysy / Crack number							
	1	2	3	4	5	6	7	8
	mm	mm	mm	mm	mm	mm	mm	mm
50								
100								
150								
200								
250	0,06							
300	0,08							
350	0,10	0,04						
400	0,15	0,10						
450	0,17	0,10						
500	0,20	0,12						
500	0,20	0,13						
500	0,20	0,15						
550	0,20	0,17	0,12					
600	0,20	0,20	0,12					
650	0,20	0,20	0,15					
700	0,22	0,20	0,17					
750	0,22	0,20	0,20					
800	0,25	0,20	0,20					
850	0,25	0,20	0,22	0,12				
900	0,27	0,22	0,27	0,15				
950	0,27	0,25	0,30	0,18				
1000	0,27	0,27	0,32	0,20				
1050	0,25	0,27	0,35	0,20				
1100	0,25	0,27	0,37	0,20				
1150	0,27	0,27	0,40	0,22				
1200	0,25	0,27	0,45	0,22				
1250	0,30	0,25	0,50	0,30				

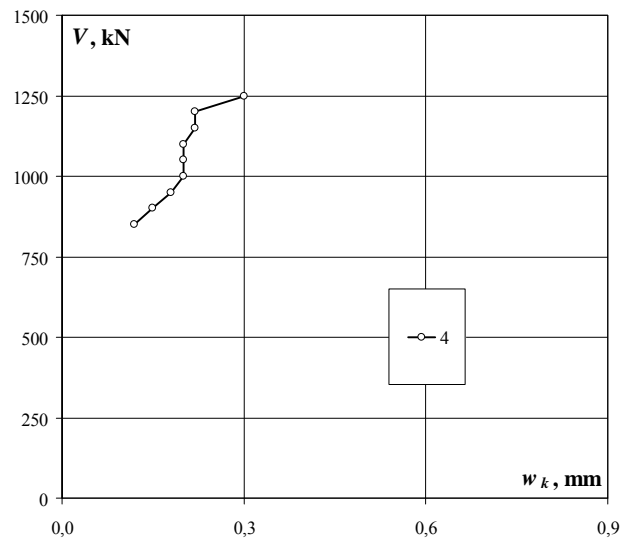
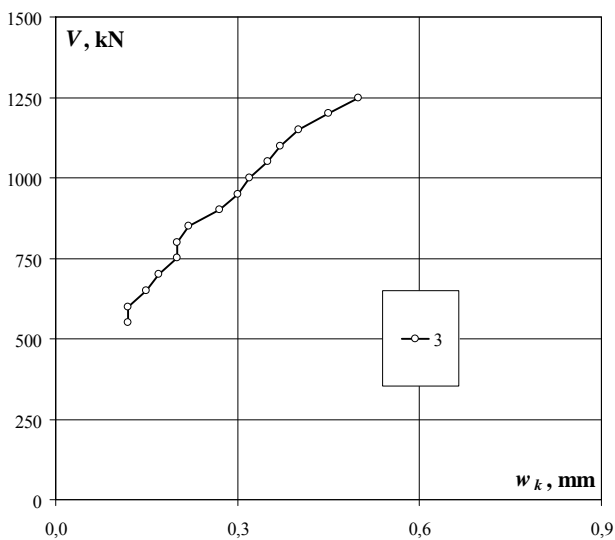
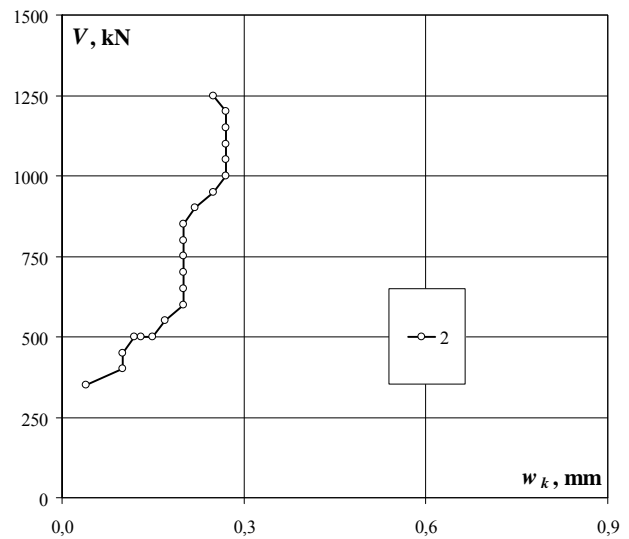
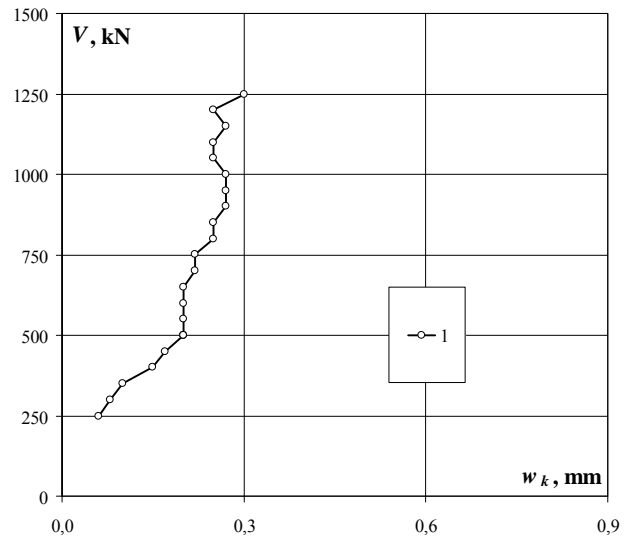

Układ rys przy sile 250kN / Crack pattern at 250kN

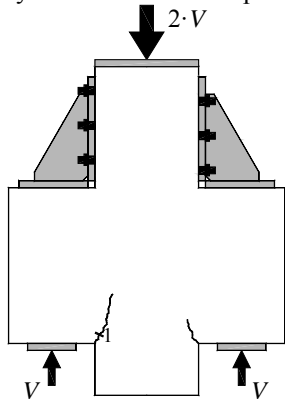

Układ rys przy sile 350kN / Crack pattern at 350kN

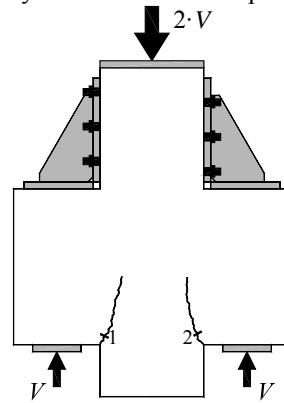

Układ rys przy sile 400kN / Crack pattern at 400kN

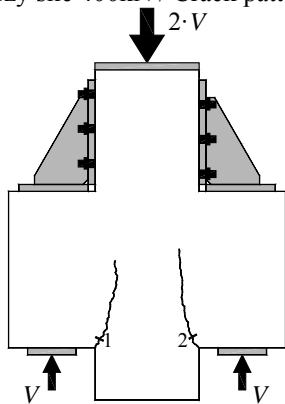

Układ rys przy sile 750kN / Crack pattern at 750kN

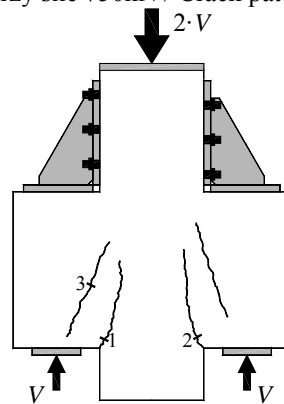

Układ rys przy sile 900kN / Crack pattern at 900kN

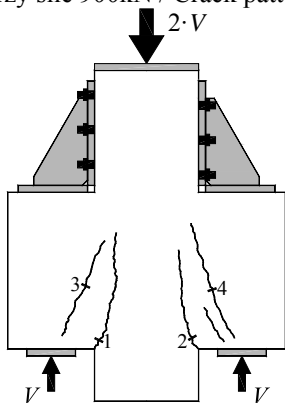

Układ rys przy sile 1100kN / Crack pattern at 1100kN

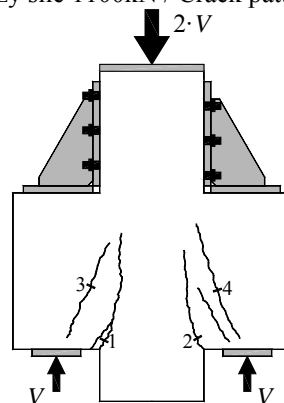

Układ rys przy sile 1200kN / Crack pattern at 1200kN

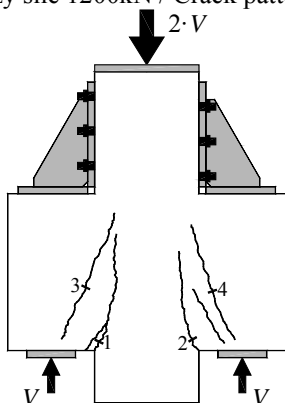

Układ rys przy sile 1370kN / Crack pattern at 1370kN

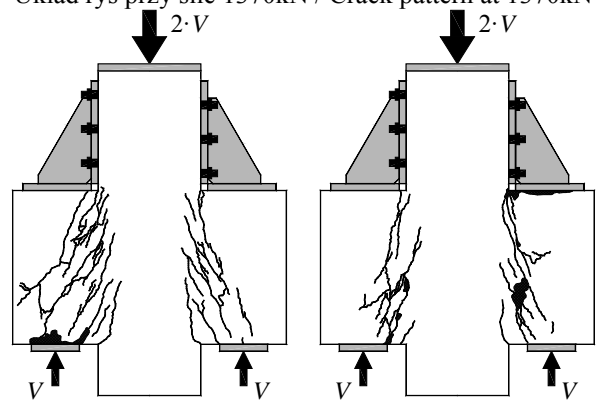

F-I

Szerokość rozwarcia rys według systemu Aramis / Crack width according to Aramis System

obciążenie wspornika corbel load	Numer rysy / Crack number							
	1 mm	2 mm	3 mm	4 mm	5 mm	6 mm	7 mm	8 mm
0	0,00	0,00	0,00	0,00				
50	0,02	0,05	0,02	0,05				
150	0,05	0,06	-0,01	-0,01				
200	0,07	0,09	-0,03	-0,04				
250	0,09	0,11	-0,02	-0,05				
300	0,09	0,09	-0,04	-0,03				
350	0,10	0,10	-0,03	-0,01				
400	0,11	0,12	-0,02	0,00				
450	0,13	0,17	0,00	0,00				
500	0,17	0,21	0,08	-0,03				
500	0,23	0,19	0,15	-0,06				
550	0,23	0,19	0,17	-0,05				
600	0,22	0,24	0,18	-0,05				
650	0,24	0,25	0,20	-0,03				
700	0,24	0,26	0,21	-0,01				
750	0,25	0,26	0,20	0,03				
800	0,23	0,25	0,22	0,08				
850	0,25	0,24	0,25	0,15				
900	0,28	0,26	0,26	0,16				
950	0,29	0,30	0,24	0,16				
1000	0,26	0,30	0,29	0,21				
1000	0,26	0,29	0,32	0,20				
1050	0,27	0,27	0,35	0,25				
1050	0,28	0,28	0,36	0,27				
1150	0,30	0,26	0,38	0,27				
1150	0,30	0,25	0,37	0,27				
1200	0,31	0,27	0,42	0,30				
1200	0,30	0,26	0,50	0,33				
1250	0,32	0,22	0,52	0,38				
1250	0,32	0,21	0,51	0,42				
1300	0,31	0,20	0,54	0,41				
1300	0,32	0,21	0,54	0,42				
1300	0,30	0,21	0,60	0,45				
1350	0,30	0,19	0,64	0,46				
1350	0,30	0,21	0,67	0,48				
1350	0,23	0,19	0,85	0,66				
1350	0,13	0,05		1,53				
1350	0,11	0,06		1,71				
1350	0,12	0,04		1,67				
1350	0,11	0,03		1,69				
1350	0,11	0,02		1,71				
1350	0,10	0,02						
1350	0,11	0,01						

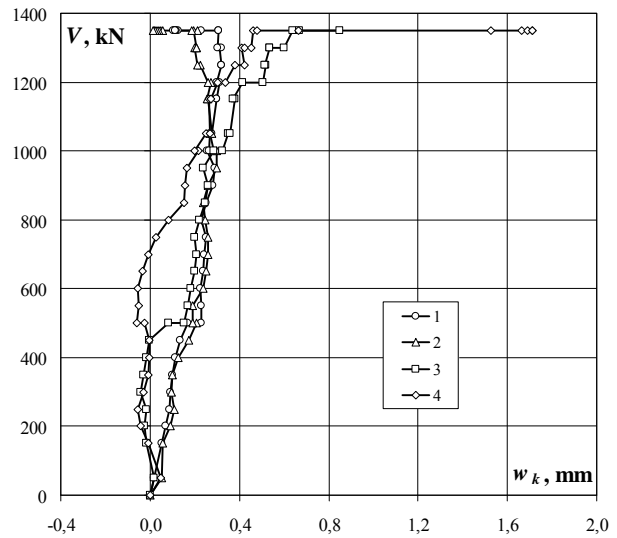

Układ rys przy sile 500kN / Crack pattern at 500kN

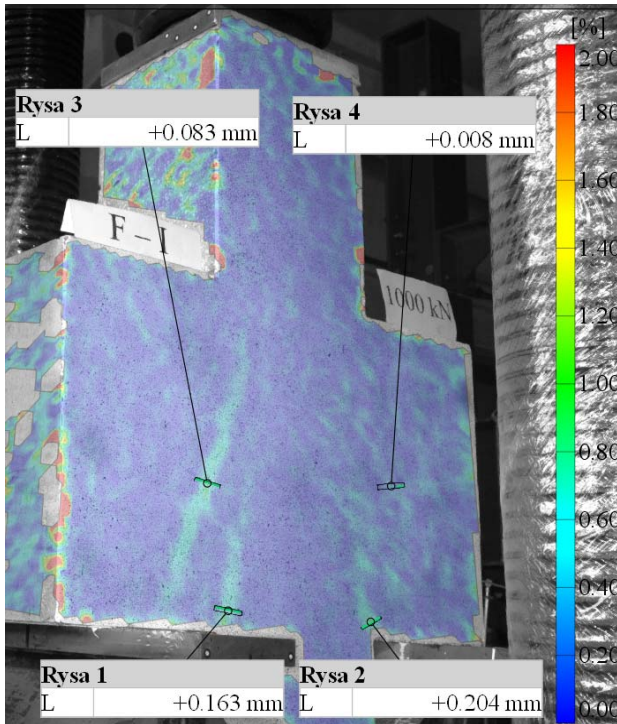

Układ rys przy sile 800kN / Crack pattern at 800kN

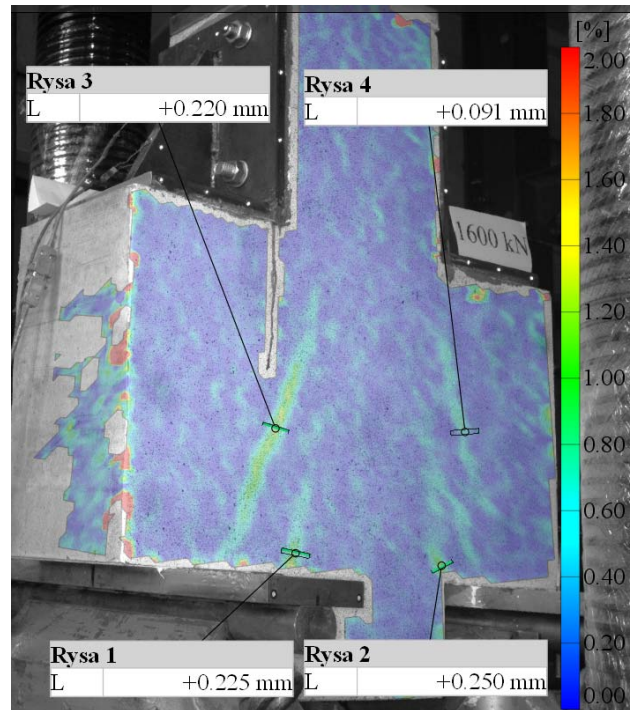

Układ rys przy sile 1250kN / Crack pattern at 1250kN

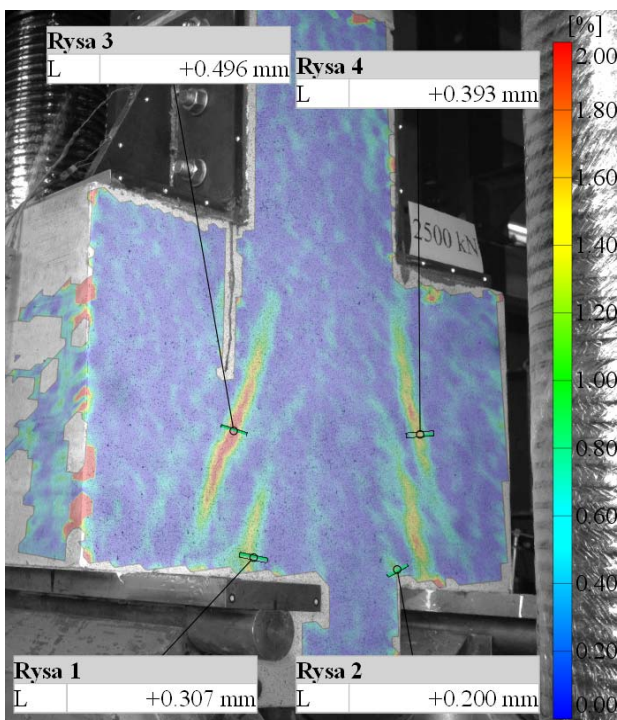

Układ rys przy sile 1350kN / Crack pattern at 1350kN

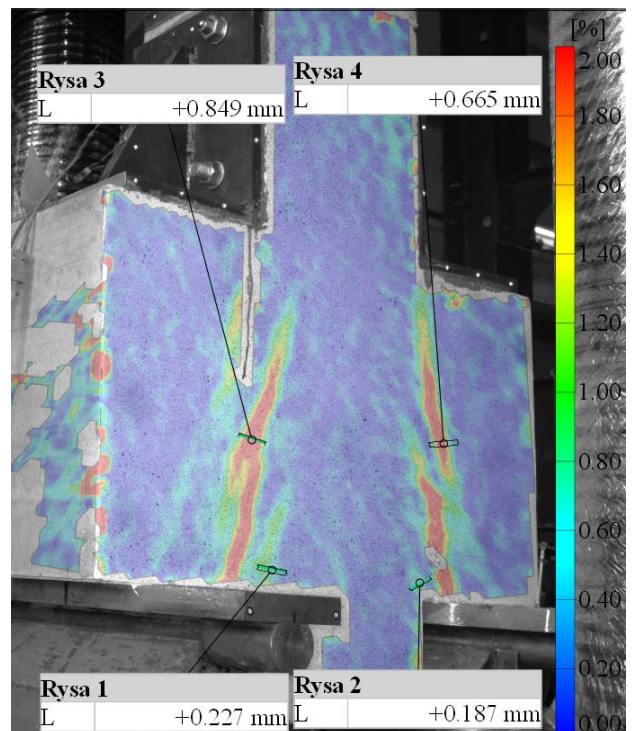

F-I



Nakładanie kleju na akcesorium
Placing of the glue on accessory



Wiązanie żywicy
Curing of the resin

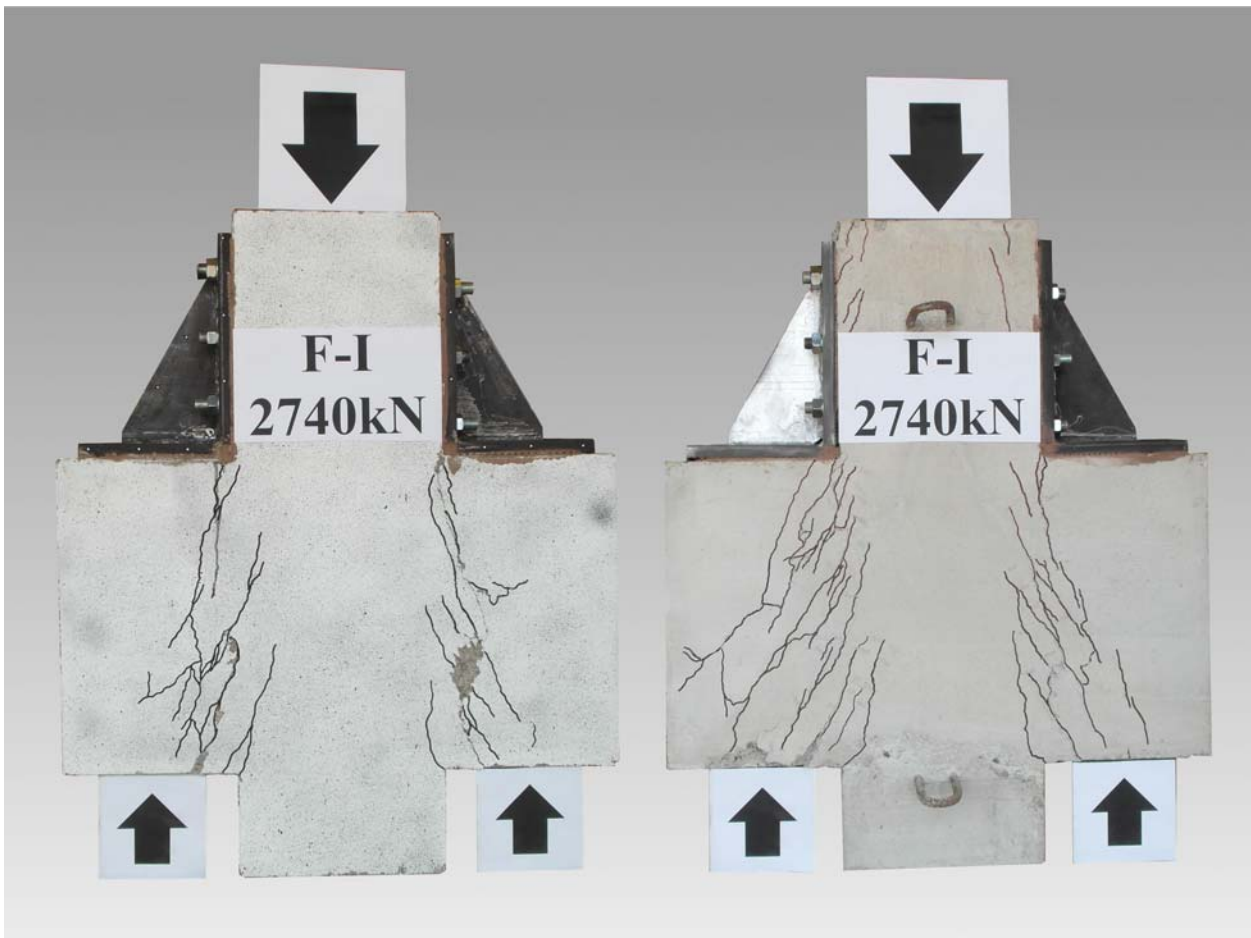

Wspornik po zniszczeniu / Corbel after failure

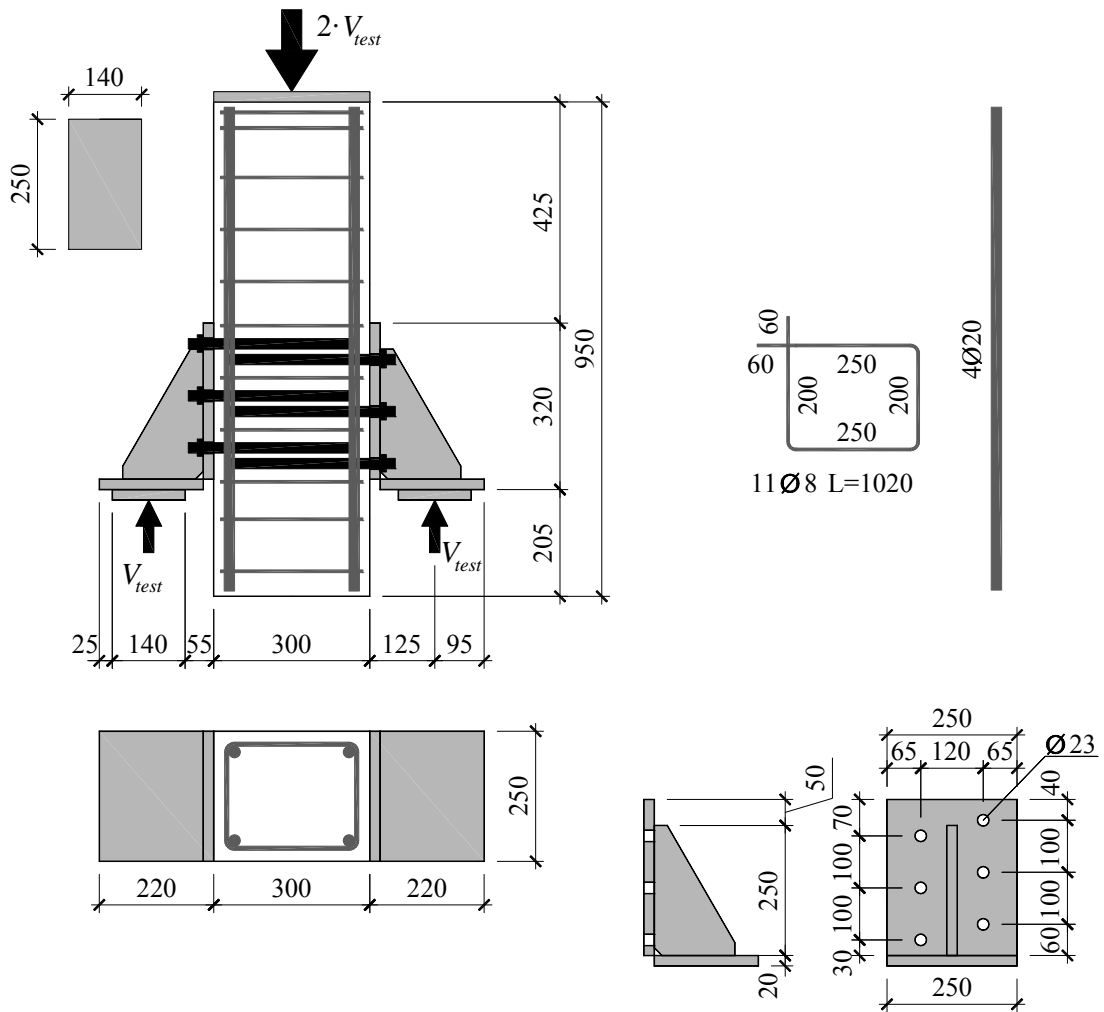

Zbrojenie modelu / Specimen's reinforcement

Wytrzymałość betonu na ściskanie / Compressive strength of concrete

$$f_{cm} = 35,22\text{MPa}$$

Moduł sprężystości podłużnej / Young's modulus

$$E_{cm} = 26,1\text{GPa}$$

Wytrzymałość betonu na rozciąganie przy rozłupywaniu / Tensile splitting strength of concrete

$$f_{ct,sp} = 3,47\text{MPa}$$

Gęstość betonu / Density of concrete

$$\rho = 2250\text{kg/m}^3$$

Charakterystyka zbrojenia / Characteristics of the reinforcement

Ø8

$$A_s = 49,77\text{mm}^2, f_{ym} = 499,6\text{MPa}, f_{tm} = 582,9\text{MPa}$$

Ø10

$$A_s = 77,60\text{mm}^2, f_{ym} = 530,3\text{MPa}, f_{tm} = 639,0\text{MPa}$$

Ø16

$$A_s = 201,36\text{mm}^2, f_{ym} = 534,8\text{MPa}, f_{tm} = 633,8\text{MPa}$$

M20

$$A_s = 227,78\text{mm}^2, f_{ym} = 856,4\text{MPa}, f_{tm} = 947,1\text{MPa}$$

Siła niszcząca / Failure force

$$V_{test} = 650\text{kN}$$

Akcesorium – odkształcenia po stronie S i N (ϵ_s) / Accessory – strains on S and N side (ϵ_s)

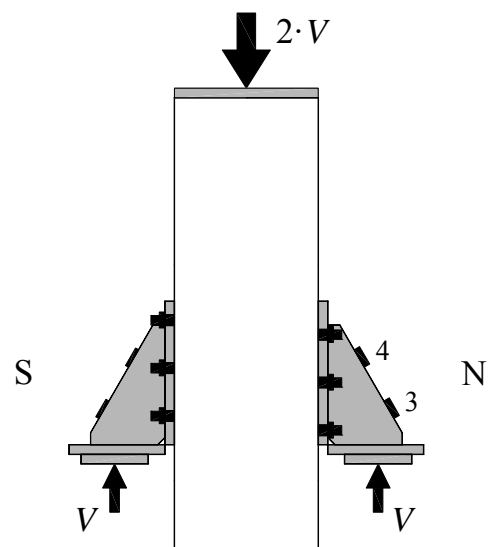
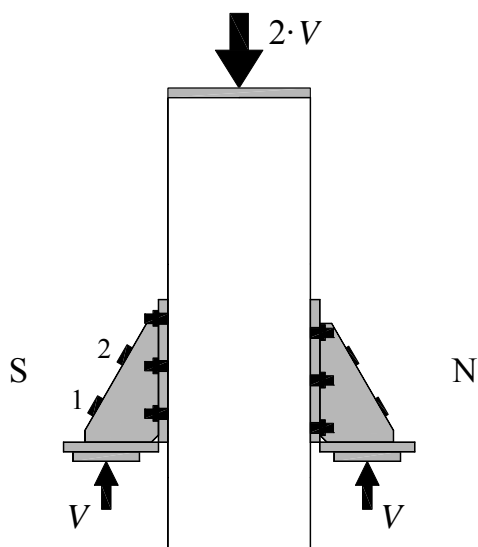
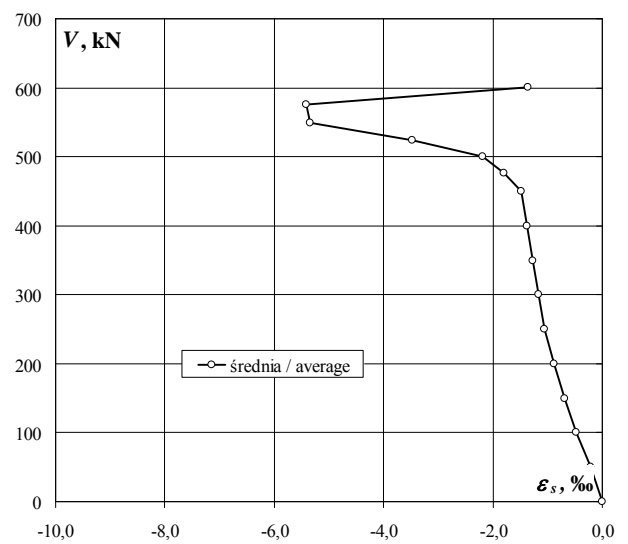
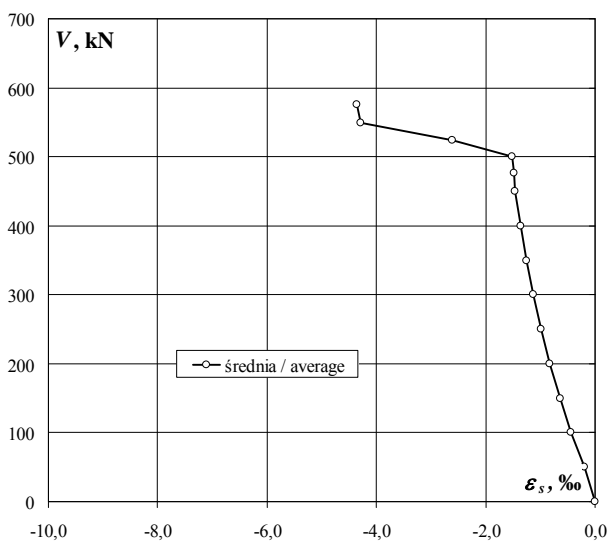
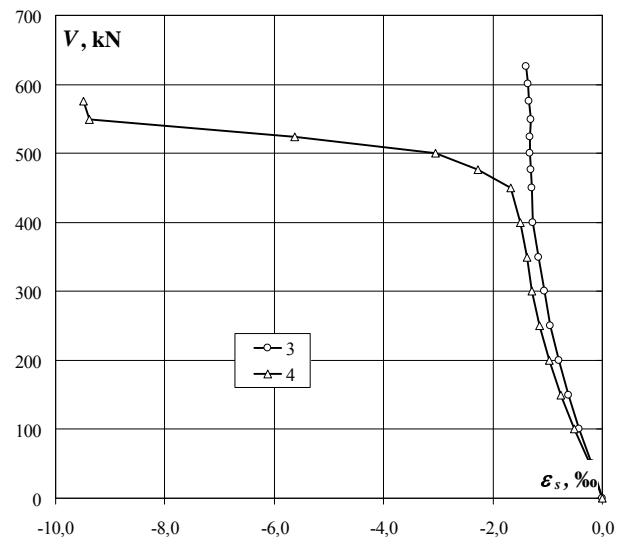
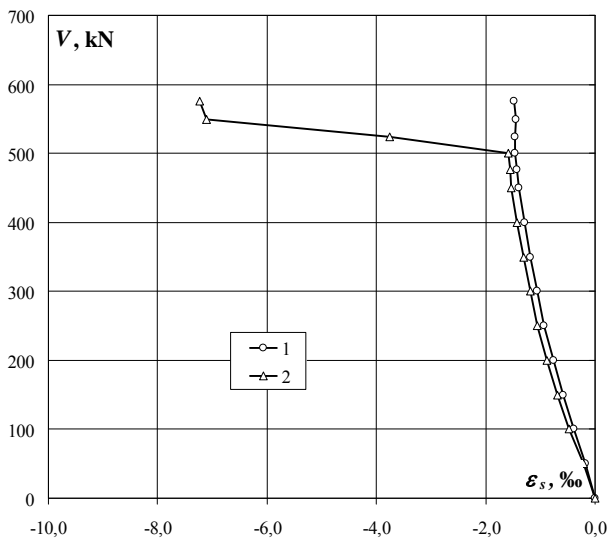

F-II

Przemieszczenia poziome pomiędzy słupem a akcesoriami / Horizontal displacements between column and accessories

obciążenie wspornika corbel load	Δl_x							
	1	3	5	7	2	4	6	8
	mm	mm	mm	mm	mm	mm	mm	mm
0	0,00	0,00	0,00	0,00	0,00	0,00	0,00	0,00
50	0,04	0,03	0,05	-0,04	0,00	0,04	0,02	-0,01
100	0,08	0,05	0,06	-0,04	-0,04	0,00	0,00	-0,01
150	0,08	0,10	0,06	-0,08	-0,06	0,01	-0,01	-0,01
200	0,16	0,12	0,10	-0,09	-0,06	0,04	-0,01	0,02
250	0,21	0,17	0,12	-0,07	-0,10	0,06	-0,02	0,01
300	0,29	0,28	0,20	0,02	-0,19	0,15	-0,07	0,05
350	0,90	0,89	0,84	0,65	-0,26	0,23	-0,10	0,15
400	1,17	1,16	1,12	0,92	-0,32	0,30	-0,21	0,18
450	1,47	1,47	1,42	1,23	-0,38	0,41	-0,12	0,35
500	2,00	2,00	1,93	1,75	-0,09	0,66	0,12	0,58
500	2,08	2,08	2,01	1,83	-0,04	0,70	0,16	0,64
550	2,23	2,27	2,17	1,99	0,06	0,76	0,24	0,75
550	2,44	2,44	2,35	2,17	0,29	0,97	0,47	0,93
600	3,20	3,14	2,98	2,80	0,79	1,53	0,92	1,37
600	3,36	3,29	3,13	2,92	0,94	1,66	1,01	1,46
650	3,50	3,43	3,25	3,06	1,02	1,72	1,05	1,54
650	3,78	3,69	3,47	3,29	1,21	1,89	1,18	1,69
650	4,09	3,94	3,76	3,55	1,58	2,29	1,43	1,92
650	4,30	4,12	3,93	3,75	1,86	2,60	1,59	2,10
650	5,01	4,72	4,49	4,32	3,18	3,82	2,45	2,94
650	6,53	5,67	5,28	5,11	6,70	7,61	5,49	5,63
650	7,87	6,17	5,74	5,59	9,36		7,33	7,02
650	6,55	5,17	4,74	4,58	8,12		6,55	6,33

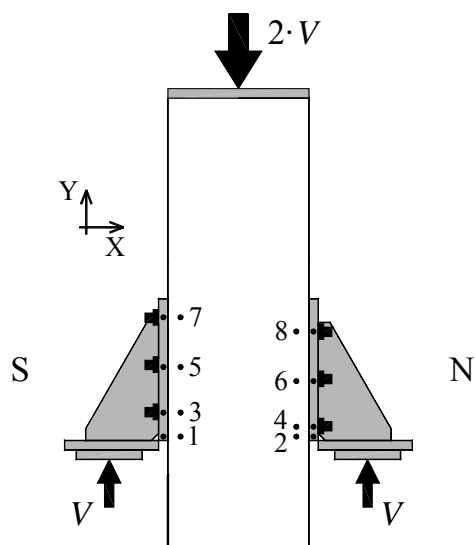
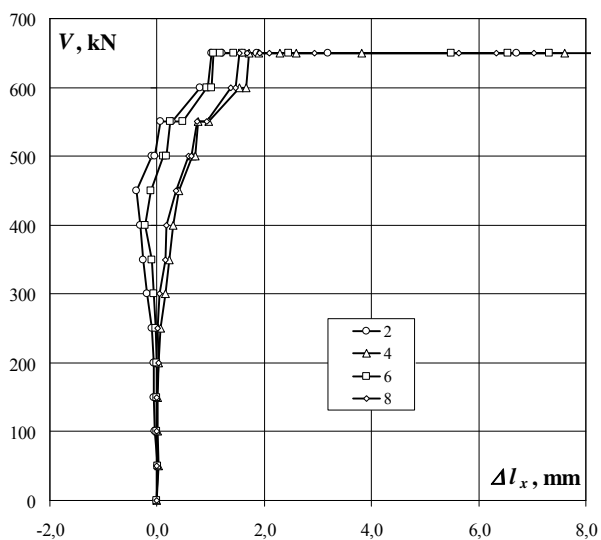
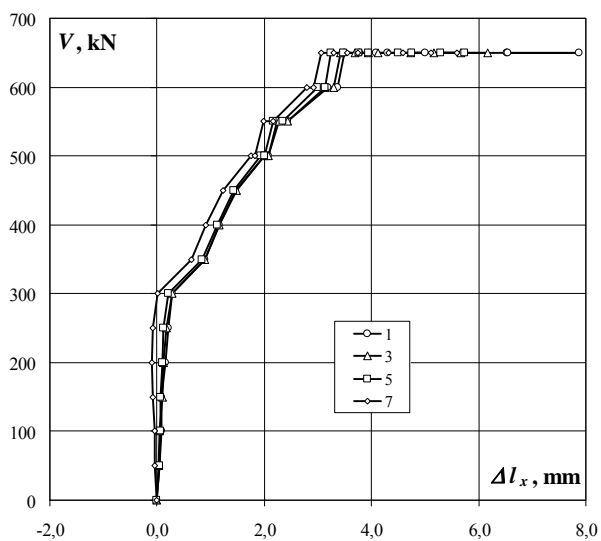

Przemieszczenia pionowe pomiędzy słupem a akcesoriami / Vertical displacements between column and accessories

obciążenie wspornika corbel load	Δl_y							
	1	3	5	7	2	4	6	8
	mm	mm	mm	mm	mm	mm	mm	mm
0	0,00	0	0	0	0	0	0	0
50	0,05	-0,03	-0,01	-0,04	-0,13	-0,09	0,03	0,01
100	0,12	-0,01	-0,01	-0,04	-0,09	-0,02	0,02	-0,01
150	0,19	0,00	-0,03	-0,04	-0,05	-0,04	0,01	-0,03
200	0,25	0,04	-0,04	0,01	-0,03	-0,01	0,04	-0,02
250	0,29	0,09	-0,04	0,08	0,03	0,06	0,02	-0,01
300	0,35	0,13	0,01	0,13	0,04	0,07	0,02	0,02
350	0,39	0,24	0,22	0,34	0,13	0,13	0,02	0,05
400	0,44	0,28	0,29	0,43	0,14	0,15	0,05	0,09
450	0,51	0,32	0,35	0,50	0,21	0,18	0,11	0,13
500	0,65	0,43	0,46	0,59	0,31	0,22	0,13	0,11
500	0,68	0,45	0,47	0,61	0,33	0,24	0,12	0,11
550	0,72	0,48	0,50	0,64	0,34	0,26	0,14	0,10
550	0,76	0,53	0,54	0,67	0,37	0,26	0,12	0,12
600	1,18	0,79	0,65	0,86	0,57	0,34	0,09	0,12
600	1,36	0,88	0,69	0,83	0,63	0,40	0,11	0,09
650	1,44	0,94	0,71	0,88	0,68	0,40	0,10	0,08
650	1,85	1,10	0,79	0,99	0,88	0,50	0,07	0,08
650	2,37	1,31	0,83	1,06	1,09	0,57	0,03	0,03
650	2,48	1,57	0,90	1,10	1,17	0,50	0,00	0,02
650	4,67	2,76	1,17	1,13	4,15	2,90	-0,15	-0,22
650	6,68	2,48	1,29	1,12			0,65	-1,03
650	6,85	2,31	1,19	1,01			4,06	-1,44
650	5,39	1,75	1,10	0,84			3,57	-1,47

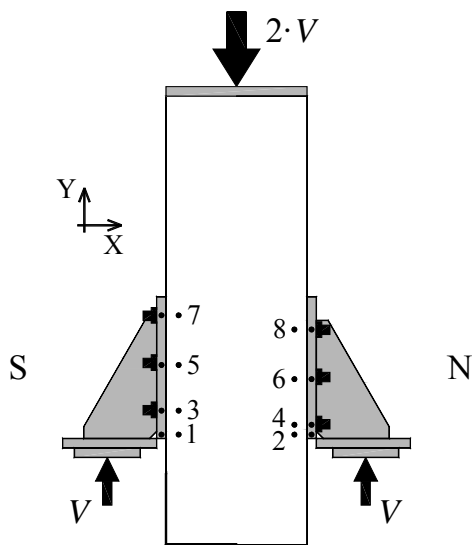
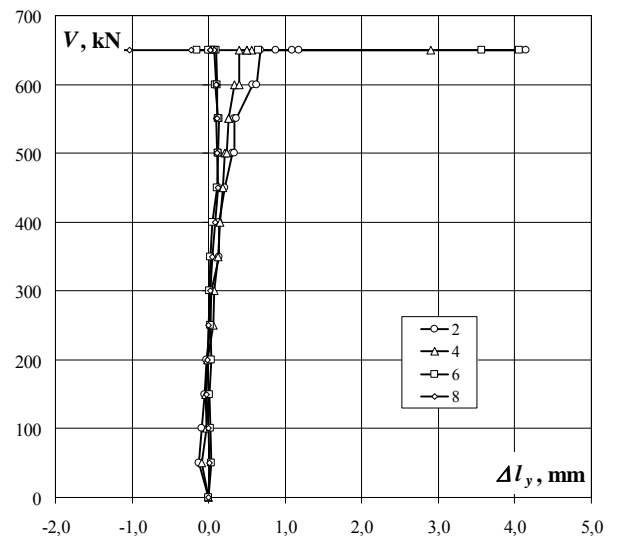
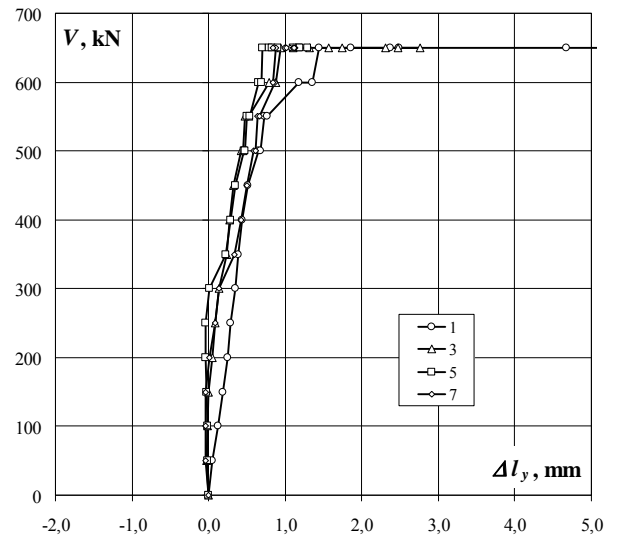

F-II

Układ rys przy sile 650kN / Crack pattern at 650kN

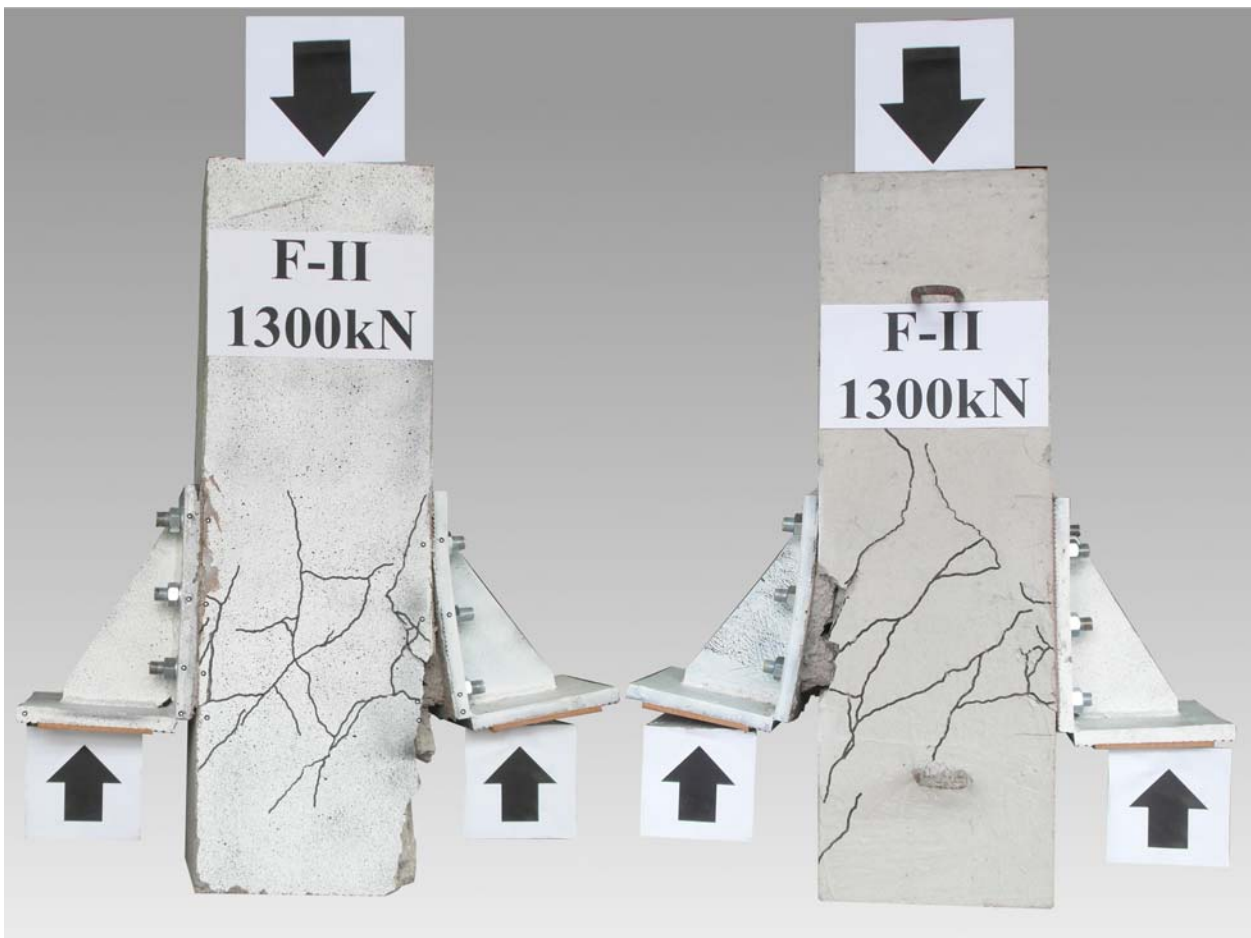
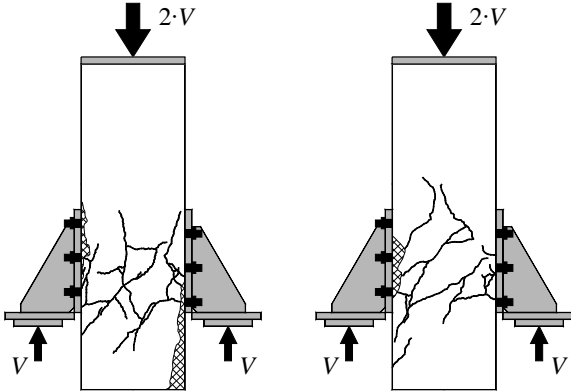

Element po zniszczeniu / Specimen after failure