



12-2012

The Harmonica as a Blues Instrument

Gordon Ramsey

Loyola University Chicago, gramsey@luc.edu

Christopher Banaszak

Joseph Wiseman

Recommended Citation

Ramsey, Gordon; Banaszak, Christopher; and Wiseman, Joseph, "The Harmonica as a Blues Instrument" (2012). *Physics: Faculty Publications and Other Works*. Paper 41.

http://ecommons.luc.edu/physics_facpubs/41

This Article is brought to you for free and open access by the Faculty Publications at Loyola eCommons. It has been accepted for inclusion in Physics: Faculty Publications and Other Works by an authorized administrator of Loyola eCommons. For more information, please contact ecommons@luc.edu.



This work is licensed under a [Creative Commons Attribution-Noncommercial-No Derivative Works 3.0 License](https://creativecommons.org/licenses/by-nc-nd/3.0/).

© Acoustical Society of America, 2012.

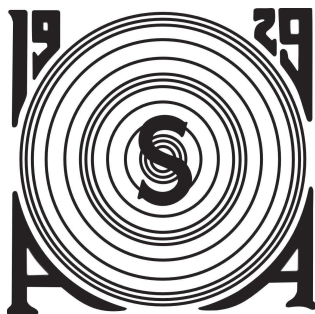

**164th Meeting of the Acoustical Society of America
Kansas City, Missouri
22 - 26 October 2012**

Session 3aMU: Musical Acoustics

3aMU5. The harmonica as a blues instrument

Gordon Ramsey*, Christopher Banaszak and Joseph Wiseman

*Corresponding author's address: Physics, Loyola University Chicago, 1032 W Sheridan Rd, Chicago, IL 60660, gprspinphys@yahoo.com

The modern harmonica, or harp, has been around since the early 19th century. It is typically used in blues, country, rock and roll and folk music. These musical genres are somewhat similar in structure and form, and often borrow ideas from each other. The harmonica is appropriate as a backup to the main vocal melody and instruments due to its rich harmonic structure and subdued intensity. The ability to apply vibrato and gradual slurs make it a perfect instrument to achieve a "bluesy" sound. Our harp research group has investigated the physical properties of harmonica structure to illustrate how different structures lead to varied sounds, each of which is appropriate to a particular style of music. We present an overview of the use of the harmonica as a blues instrument and describe the details and significance of our research project.

Published by the Acoustical Society of America through the American Institute of Physics

1. INTRODUCTION

Modern harmonicas, or blues harps, have been around for almost 200 years. Other free reed instruments existed long before in Eastern Asia, but the first early version of the modern harmonica was invented in 19th Century Europe. The first version of the modern harmonica was invented by Christian Buschman in 1821. Joseph Richter invented the tuning and blow/draw mechanism, which characterizes the modern harmonica and gives it more flexibility and range. This version was used in early German and American folk music and precursors to modern blues. It was very popular during the American Civil War, due to its size and ease in carrying around. There were reports that the harmonica was used by such famous people as Abraham Lincoln, Wyatt Earp and Billy the Kid. [1]

The chromatic harp was introduced in 1924, which opened it up to be appropriate for the blues and other musical genres. During the 1920s, the harmonica was used as a backup in jazz, blues and country and western music (known then as "hillbilly music"). Larry Adler introduced the harmonica into classical music during the 1930s. Little Walter (Marion Walter Jacobs) brought modern blues phrasing and the amplified harmonica into the blues scene in the early 1950's. His popular recording of "Juke" in 1952 helped to establish the harmonica as an important instrument in the blues genre. At that time, he played with Muddy Waters, who in turn initiated the "Chicago blues sound" that became very popular. During the 1950s, the harmonica was used extensively in blues and country music. During the 1960s, much of rock and roll was influenced by the blues. As a result, the harmonica was used by groups such as Beatles, Cream, Rolling Stones, Black Sabbath and Stevie Wonder.

What major properties of the harmonica lent itself to such popularity in these musical genres? In early German and American folk music, its bright sound and high pitch gave a light touch to the folk songs. For the early country and western genre, it provided a complement to strings and it was cheap and easy to carry around. In early jazz it provided a complement to the piano, brass and reeds. At the time jazz was developing in the early twentieth Century, the invention of chromatic harps contributed to its appropriate use. The ability to slur and create vibrato helped to set the blues mood. For the rock and roll songs influenced by the blues, the harmonica was a natural addition to the band. It is suitable for any rock songs, as it complements the guitars and keyboards typically seen in these bands. There are many styles of harmonicas, each made of different materials and having unique shapes. All of these styles lead to different sounds and effects for blues music.

Acoustical research on the harmonica and free reed instruments has surged lately. [2] Our work is focused on the correlation between the physical properties of each harmonica and the corresponding sound spectrum, and hence the appropriate style for which it is suited. It consists of gathering sound spectra for many different harmonica types and taking high speed video of the reeds to investigate the role they play in creating effects unique to the harmonica. This paper is organized as follows: in Section 2, we discuss the harmonica as a blues instrument from a players perspective, Section 3 consists an outline of the main properties of the instrument and subsequent description of our experimental program. In Section 4, we summarize some of the key results, comparing three distinct harmonicas in their properties and corresponding suitability for different elements of the blues. We conclude by discussing the larger part of our study in comparing different harmonica types.

2. THE HARMONICA AS A BLUES INSTRUMENT

Musical genres are characterized by melody, harmony and rhythm. In that sense, the Blues genre is unique in many ways. It borrows styles from gospel and early jazz. The melodies are simple and somewhat repetitive, characteristics of gospel music. The harmonies are based on seventh chords in a variation of the I-IV-V pattern. The interesting point about the melody and harmony that sets the blues apart is the addition of the "blue notes". These are diminished thirds, fifths and sevenths, that are approximately quarter tones below these notes. Many blues musicians slur up or down to these notes to give the sad feeling of the blues. Stringed instruments and most reed instruments are designed to allow

this slurring effect. The harmonica is such an instrument. [3]

From the view of the musician, one can get completely different tones depending on the playing method. Differences in embouchure, breath pressure, and how one punctuates the notes change the sound both subtly and distinctly. All of these changes originate from the same harmonica, so if one changes the harmonica it becomes another instrument with different keys, different tonality, and a different sound. A musician wonders how the different parts play a role in the harmonica's sound. Reed structures do not change from one harmonica to the next. The reed plate can be adjusted to get the desired gap space which changes the harmonica's response to the musician. Seydel is a brand that uses stainless steel for their reeds, and for a particular model, German silver for the reed plates. The different reed and reed plate materials make a difference in the tone.

After the reed and reed plates, the next important part is the cover plate of the harmonica, which changes between each of them. Generally the cover plates are changed for the purpose of creating more room for larger reeds, changing the grip of the harmonica or simply for changing its visual aesthetic. Often, the cover plates of the harmonica are altered by professional players. Altering the cover plates can change the tone of the harmonica. Many harmonicas have solid cover plates that are only open in the back and operate as if you were cupping your hands to yell. Cutting vents into the sides of the harmonica cover plates will thin out the tone. There are a few sellers that will provide specifically designed cover plates.

The final important part is the comb of the harmonica. The comb is the main body of the instrument and separates the upper and lower reed plates. It provides a chamber for the standing waves to resonate. Combs can be very different between harmonicas. In the past, there have been a number of theories about what the comb does for the harmonica's tone. The general theory states between two main comb materials; wood and plastic, plastic will yield a bright tone, while wood will yield a more mellow tone. There are other materials ranging from exotic woods to steel which give a range of yet more diverse tones. No work has been done with the exotic woods, but the steel combed harmonica seems to have a more full tone with more harmonics. The other issue that arises with the comb is its durability. Many currently produced wood combs are not sealed and are exceptionally porous. When played for an extended time, saliva and other liquids can be soaked up by the wood of the comb and cause it to swell. This is generally not desired. When the wood swells, it has a chance of cracking or breaking. This swelling effect has caused many companies to change from the standard wood of the marine band harmonica to materials such as plastic, steel and even bamboo. Generally, many hobbyists generally enjoy plastic combs for their low cost and durability.

3. PHYSICAL PROPERTIES OF THE HARMONICA

The physical properties of the harmonica aid in its extensive use throughout blues music. The main features of the harmonica include the reeds, comb, and enclosure, each affecting the final sound of the instrument in their own unique way. Figure 1 shows a typical harmonica. The comb is the part with the rectangular holes to allow airflow. The reeds are enclosed on either side of the comb with the enclosure covering them. Harmonicas typically exhibit many harmonics, but these vary, depending on each of the properties mentioned above. These properties allow the blues musician to produce sounds that transcend that of any other instrument used in the genre.

The reeds of the harmonica are the property most associated with the pitch of the sound. By inhaling and exhaling, the player can manipulate the reed to produce different pitches. Single reeds are connected to a reed plate, which in turn is connected to the harmonica's comb. This reed plate is usually made of brass, but other materials such as aluminum or steel are occasionally used. A single harmonica contains two reed plates, attached to the top and bottom of the comb. The top reed plate contains the blow reeds and responds to exhalation of air, while the bottom reed plate contains the draw reeds and responds to inhalation of air. Each reed is activated with one direction of air flow. One reed vibrates when blown forward, while the other vibrates when the player inhales. Figure 2 shows the flow of air in each case. The maximum amplitude of harmonica reed vibration is typically about 15% of the reed length. [2] Reed



FIGURE 1. Typical harmonica

vibration is the result of fluid dynamics, determined by the physical properties of the reed. The airflow through the reed helps sustain the oscillation. This is the result of the interplay between the Bernoulli effect and the restoring force of the bending reed. This interplay is such that when the blow reed is active, the draw reed is clamped and vice-versa. (Figure 3)

Prior research has focused on mechanisms of reed oscillation and the influence of resonators on tone quality and pitch, especially pitch bending. The area of a single reed determines the overall pitch of the note sounded. Considering that the reeds share the same depth and width, the length of the reed corresponds to the overall area. A longer reed length correlates with a larger area, and thus the reed resonates with a lower frequency and produces a lower note. [4] Our data confirm this, as shown in Figure 5.

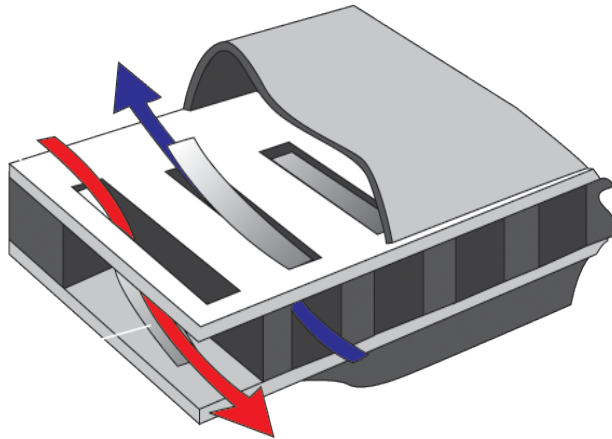

FIGURE 2. Airflow through reeds and into comb

The reed chamber, or comb, of the harmonica separates the two reed plates and acts as a medium to amplify the waves produced by the reeds. It also contains air chambers that surround the individual reeds and allow the player to direct air at specific reeds. The comb was mostly made of wood in previous years, but now the materials vary between wood, metal, and plastic.

The airflow through the comb is three-dimensional. Thus, the comb volume, in principle, plays a role in the interface

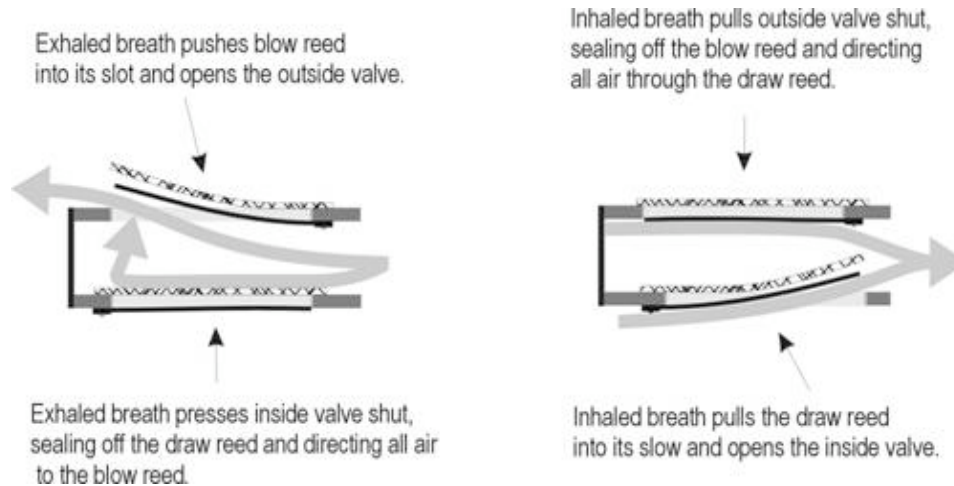

FIGURE 3. Bernoulli effect in the comb

between the reed and the enclosure. The reeds oscillate in and out of the channels of the comb, which provide a standing wave medium for each reed. These channels have a relatively uniform volume, whereas the reeds vary in length to create the frequencies heard. The air supply is a positive pressure when blowing or a relative vacuum when inhaling.

Although the comb affects the tone quality, a more significant resonator is the musician's vocal tract. Harmonica playing is a synergy of the player and instrument. The vocal tract and mouth play a significant role in the style heard. The timbre depends in part on the player in addition to the instrument structure. [5, 6]

The enclosure of the harmonica encapsulates both reed plates and the comb. The materials utilized for the enclosure, as well as its shape, vary greatly and directly affect the overall timbre of the instrument. The enclosure also amplifies the overall pitch from the harmonica.

The bend feature of the harmonica

The fact that the pitch of certain notes on the harmonica can be continuously lowered is crucial to its use as a blues instrument. This feature is called bending and is possible in many free-reed instruments. There are many modes for the harmonica reeds, the first three of which are shown in Figure 4. [7] The bending mechanism is only possible for the draw reeds. This is because the bend requires an effective increase in the length of the vocal tract, which creates the effect. [2] A complete discussion of the techniques used by the vocal tract the bending effect can be found in reference [6].

4. RESEARCH PROGRAM AND RESULTS

Part of our goal was to investigate how the coordination between the reeds, combs and enclosures contribute to the timbre of the instrument. In turn, our data gave insight into the versatility of the harmonica in its use in the genres mentioned in the first section of this paper. We measured the physical properties of three harmonicas, including the reed and comb dimensions of D, A and G harmonicas. Although the thicknesses of the reeds decreased with frequency, the fundamental frequencies had greater dependence on the length than any other geometric parameter. All three sets of combs had identical cross sectional areas, to within the measurement errors. After correlation of the reed "dimensions"

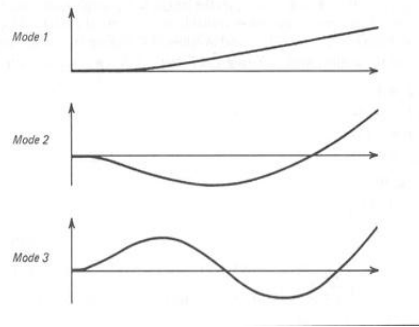

FIGURE 4. Displacement patterns for the first three transverse modes of a free-reed.

were performed, the best results occurred with the frequency versus length “dimension”. Figures 5 and 6 show plots of the fundamental frequencies of each note versus reed lengths (in mm) and comb length (in cm), respectively.

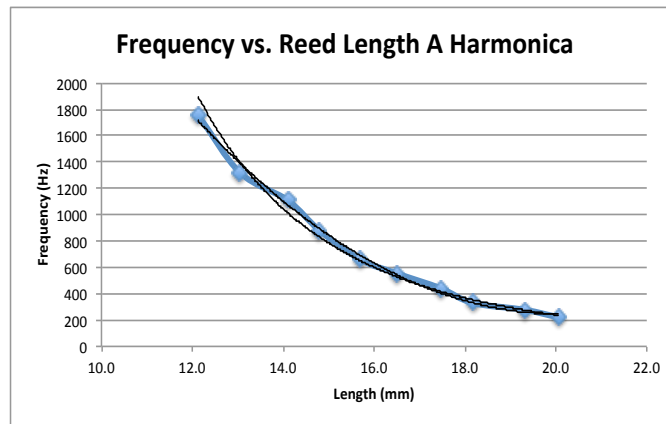

FIGURE 5. Frequency vs. Reed Length for the A harmonica

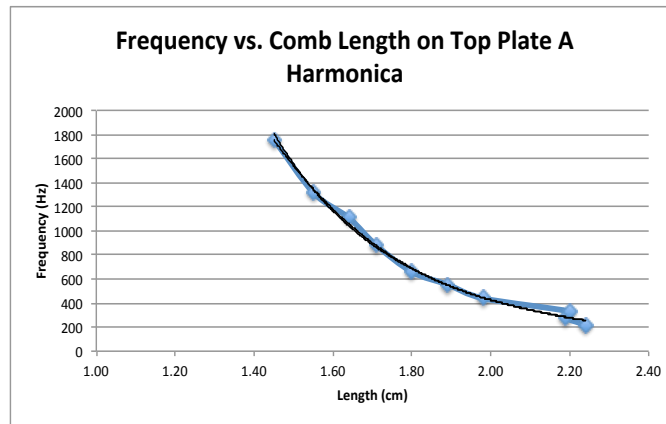

FIGURE 6. Frequency vs. Comb Length for the A harmonica top plate

We fit the data with power law curves, as they reproduced the data well, as evidenced by the R^2 correlation values. It was much easier to draw comparisons with these fits. Table 1 shows the results of these fits, which depict the fundamental frequency of each note with the reed and comb lengths. The length behavior (power law) of the reeds and comb for the A and G harmonicas are quite similar. However, the D harmonica exhibits a slower falloff of the fundamental harmonics with length. We attribute this difference to the fact that the D harmonica comb is wooden, while the A and G harmonicas have plastic combs. This difference is also seen in the harmonic analysis we performed on the harmonicas.

TABLE 1. Table of best fit equations for frequency versus length: reeds and combs

Harp	Reed/Comb	Best fit: $f(\text{Hz})$ vs L^a	R^2 value
A	Blow Reed	$6.0E7L^{-4.14}$	0.991
A	Draw Reed	$7.0E6L^{-3.38}$	0.983
A	Top reed/Comb	$9.7E3L^{-4.50}$	0.986
A	Bottom reed/Comb	$6.0E3L^{-3.66}$	0.963
G	Blow Reed	$5.0E7L^{-4.12}$	0.993
G	Draw Reed	$6E6L^{-3.35}$	0.981
G	Top Reed/Comb	$1.3E4L^{-5.14}$	0.986
G	Bottom Reed/Comb	$7.6E3L^{-4.19}$	0.969
D	Blow Reed	$2.0E7L^{-3.67}$	0.997
D	Draw Reed	$3.0E6L^{-2.99}$	0.990
D	Top Reed/Comb	$2.7E4L^{-4.92}$	0.998
D	Bottom Reed/Comb	$1.5E4L^{-4.02}$	0.988
		a in mm for the reeds and cm for the combs	

Harmonic spectral analyses were performed on each harmonica. The spectrum for each note on the harmonicas was recorded. The sound data displayed the raw waveforms for each note on the harmonicas. Taking the Fourier Transform yielded the harmonic spectra for each. These are plotted on "Lego" plots, 3-D bar charts resembling Legos stacked in 3-D, to illustrate the harmonic structure for all the notes of a particular harmonica. These plots enable one to extract trends of the harmonic structure for each harmonica as a whole. Figures (7-9) show this analysis for the three harmonicas. The heights of the bars indicate the relative intensity of that harmonic.

The D harmonica generally had less harmonics overall and thus, a more mellow sound. The small amount of higher harmonics at the center of the range may be due to the rectangular structure of the enclosure, allowing these few low-intensity frequencies to be present. It is clearly seen that the majority of the intensity lies in the lowest harmonics. Overall, this lack of harmonics across the notes contributes to its mellow sound, often used for ballads and some blues songs. It is clear that the A harmonica sound contains a richer harmonic structure. Most of the notes, except at the high end, exhibit from six to nine harmonics, except for the extremely low and high ones. These are amplified by the trapezoidal enclosure. This yields a bright sound that can be heard in Rock, marches and some of the brassier blues music. Finally, the G harmonica with its plastic comb and hourglass shaped enclosure, manifests its bright sound with a rich harmonic structure. The higher harmonics are more numerous, but of slightly less intensity. So, although the sound is bright, it is different than the A harmonica. Thus, it can be used in any of the genres discussed in the introduction. All of the conclusions involving the enclosures is qualitative, as we did not measure their volumes.

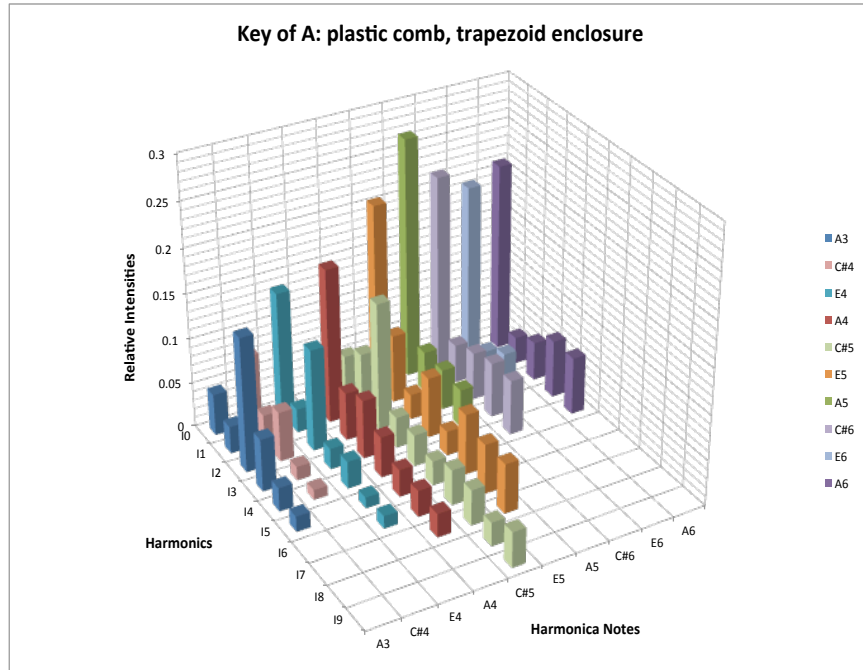

FIGURE 7. Harmonics for the Key A Harmonica

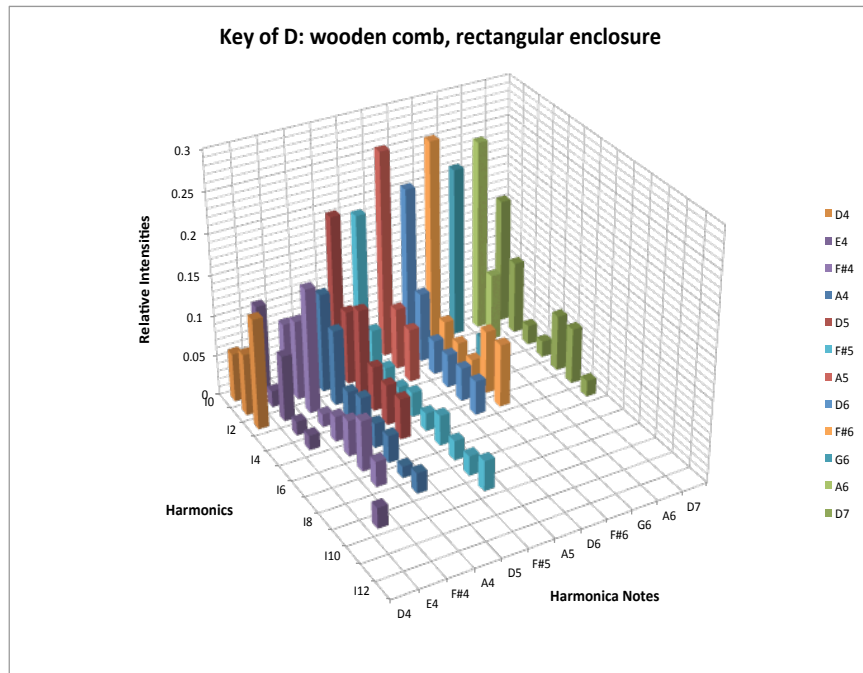

FIGURE 8. Harmonics for the D Harmonica

5. CONCLUSION

The harmonica, or blues harp, is used in many genres of music, including the blues genre extensively. We have discussed the key features that make the harmonica suitable for various moods created by the blues including the

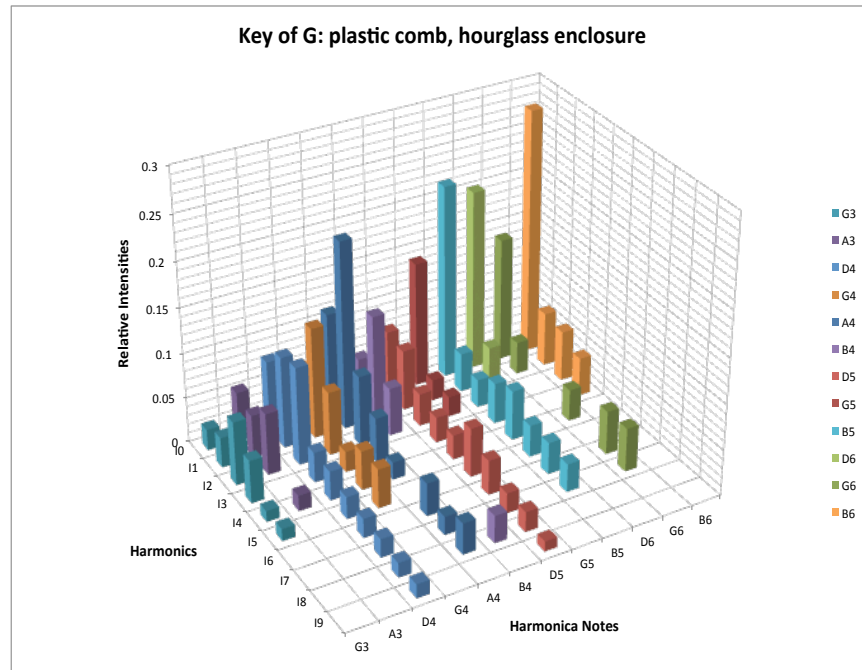

FIGURE 9. Harmonics for the Key of G Harmonica

ballads and the brassier hard blues sound. The following features of the harmonica, substantiated by our data, make it a suitable instrument for the blues genre.

Reed and comb interplay or connection Lengths of the reeds and combs contribute to the fundamental frequency (pitch) heard, but do not contribute substantially to the timbre.

Compact design The rapidly falling dependence of the fundamental frequency on the lengths of reeds and comb allow the harmonica to be compact and easy to carry compared with other instruments.

Various timbres, depending on design Different shaped enclosures and comb material, of either plastic or wood, allow different timbres and hence effects related to the blues sound. Modifying the enclosure physically or by cupping the hands over the enclosure allow for creating different effects.

Connection with vocal tract The close connection between the vocal tract and harmonica allows various effects that contribute to the blues, including most notably, the bending effect.

Bending effect The ability to play "blue" notes in between normal pitches create the blues sound.

All of these factors contribute to the important role that the harmonica has played in the blues and other musical genres.

ACKNOWLEDGMENTS

One of the authors (GPR) would like to thank James Cottingham for useful discussions and the referee for careful reading of the manuscript.

REFERENCES

1. Wikipedia: <http://en.wikipedia.org/wiki/Harmonica>
2. J. Cottingham, "Acoustics of free-reed instruments", *Physics Today*, March 2011
3. Wikipedia: <http://en.wikipedia.org/wiki/Blues-Scale> and M. A. Hall and L. Smith, "A computer model of blues music and its evaluation", *J. Acoust. Soc. Am.*, Vol 100, No. 2, pp 1163-1167 (1996)
4. R. Johnston, "Pitch Control in Harmonica Playing", *Acoust. Australia* **15**, 69-75, (1987)
5. H. F. Olson, *Music, Physics and Engineering*, 2nd Ed., Dover Publications, Inc., New York, NY, 1967.
6. H. T. Bahnson, J. F. Antaki and Q. C. Beery, "Acoustical and physical dynamics of the diatonic harmonica", *J. Acoust. Soc. Am.* **103**, 2134-2144, (1998)
7. T. D. Rossing, F. R. Moore and P. A. Wheeler, *The Science of Sound*, 3rd Ed., Addison-Wesley, San Francisco, CA, 2002.