



THE UNIVERSITY *of* EDINBURGH

Edinburgh Research Explorer

Post-combustion carbon capture

Citation for published version:

Chao, C, Deng, Y, Dewil, R, Baeyens, J & Fan, X 2021, 'Post-combustion carbon capture', *Renewable and Sustainable Energy Reviews*, vol. 138, 110490. <https://doi.org/10.1016/j.rser.2020.110490>

Digital Object Identifier (DOI):

[10.1016/j.rser.2020.110490](https://doi.org/10.1016/j.rser.2020.110490)

Link:

[Link to publication record in Edinburgh Research Explorer](#)

Document Version:

Peer reviewed version

Published In:

Renewable and Sustainable Energy Reviews

General rights

Copyright for the publications made accessible via the Edinburgh Research Explorer is retained by the author(s) and / or other copyright owners and it is a condition of accessing these publications that users recognise and abide by the legal requirements associated with these rights.

Take down policy

The University of Edinburgh has made every reasonable effort to ensure that Edinburgh Research Explorer content complies with UK legislation. If you believe that the public display of this file breaches copyright please contact openaccess@ed.ac.uk providing details, and we will remove access to the work immediately and investigate your claim.



Post-combustion Carbon Capture

Cong Chao¹, Yimin Deng², Raf Dewil^{2*}, Jan Baeyens³, Xianfeng Fan^{1*}

¹ Institute for Materials and Processes, School of Engineering, The University of Edinburgh, Edinburgh, EH9 3JL, UK.

² KU Leuven, Department of Chemical Engineering, Leuven, Belgium

³ European Powder and Process Technology, Park Tremeland 9, 3120 Tremelo, Belgium

*Co-corresponding authors

Raf Dewil: Raf.Dewil@kuleuven.be; Xianfeng Fan: X.Fan@ed.ac.uk

Keywords: post-combustion, carbon capture, technologies, absorption, adsorption, membranes, nanomaterials

Abstract

CCS, Carbon Capture and Storage, is considered a promising technology to abate CO₂ emissions from point sources. The present review deals with the principle of post-combustion capture techniques, including thermal or pressure swing principles, adsorption or absorption, and electrical swing or membrane separation processes. Opportunities and challenges are assessed. In the first section of absorption processes, several commercial technologies are compared, and complemented by the aqueous or chilled ammonia (NH₃) process, and a dual or strong alkali absorption. The second section deals with adsorption where fixed beds, circulating fluidized beds and counter-current bed configurations will be discussed, with special focus on the different adsorbents ranging from zeolites or activated carbon, to more complex amine-functionalized adsorbents, nanotubes or metal organic frameworks (MOFs), and alkali-

promoted oxides. Thirdly, membrane processes will be analysed. The review will finally summarize challenges and opportunities.

Several research groups confirmed that absorption is the most mature post-combustion capture process: among the assessment of post-combustion CCS, 57% apply absorption, 14% rely on adsorption, 8% use membranes, and 21% apply mineralization or bio-fixation. This conclusion was in-line with expectations, since absorption gas separation has been largely applied in the various petro-chemical industries. All other systems need further development prior to large scale application.

Abbreviations

APTS 3-aminopropyl-triethoxysilane	CA Cellulose acetate
CAP Chilled ammonia process	CCS Carbon capture and storage
CFB Circulating fluidized beds	CTAB Hexadecyltrimethylammonium bromide
DAA Dual alkali absorption	DEA 2,2'-iminodiethanol
DGA Diglycolamine	DIPA Diisopropanolamine
DMMEA Dimethyl ethanolamine	EDA Ethylenediamine
ESA Electrical swing adsorption	Fluor EFG+ Fluor Econamine FG Plus SM
KMALC Kerr-McGee/AGG Lummus Crest	KM-CDR Kansai Mitsubishi Carbon Dioxide Recovery
MAE Methylaminoethanol	MDEA N-methyl-2,2'-iminodiethanol
MEA Monoethanol amine	MMEA Monomethylethanolamine
MWCNTs Multi-walled carbon nanotubes	MOF Metal organic frameworks
PES Polyethersulfone	PEI Polyethylenimine

PI Polyimide	PSA Pressure swing adsorption
PSf Polysulfone	SWCNTs Single-walled carbon nanotubes
TEA Triethanolamine	TEPA Tetraethylenepentamine
TETA Triethylenetetramine	TiNT TiO ₂ nanotubes
TSA Temperature swing adsorption	VSA Vacuum swing adsorption

1. Introduction

Worldwide commercial energy remains fossil fuel-based for > 80%, but releases 3×10^{13} kg of CO₂ annually[1] resulting in an increased atmospheric CO₂ concentration and associated climate changes[2]. Reducing these CO₂ emissions is of paramount importance. To maintain a global temperature-rise well below 2°C above the pre-industrial level by the end of this century, the European Union (EU) has set a binding target to cut at least 40% of the CO₂ emissions by 2030 compared to 1990, and by 30% compared to 2005[3]. The final target aims to move towards a climate-neutral economy - an economy with net-zero greenhouse gas emissions by 2050[4]. The UK Government set an 80% CO₂ emission reduction target by 2050[5], and India aims to reduce 33 to 35% of its CO₂ by 2030.

CCS, i.e. carbon capture and storage, can effectively reduce the CO₂ emission during the period of transition to low-carbon alternatives: CO₂ is captured and concentrated from flue gas, and then compressed/liquefied at about 100 bar prior to transportation, injection and permanent storage into oil and gas fields, coal beds, salt cavities or aquifers[6], and more details about CO₂ storage in salt aquifers, oil fields can be found in [7] [8, 9]. CCS is however accompanied by high investment costs and high energy penalties, in which the most expensive part is the CO₂ capture.

CO₂ capture from power plant exhausts involves techniques of post- or pre-combustion capture, or oxy-fuel combustion, as illustrated in Figure 1[10]. In pre-combustion capture, the fossil fuel is partially oxidized and reacted with steam to produce syngas (CO and H₂O), which will be further converted to CO₂ and H₂. H₂ can be used as fuel, and CO₂ is captured by techniques before combustion taking place. The operating pressure is 20-30 bar and the temperature is high[11]. In oxy-fuel combustion, the fuel is burned in oxygen not air, the flue gas is mainly composed of CO₂ and the impurities, such as SO_x. It is better suitable for the CCS storage without separating CO₂ from N₂. The oxy-fuel combustion reacts at a high pressure in the range of 20-30 bar, and at a temperature of 100-300°C [11]. The oxygen concentration in oxy-fuel combustion is very high, which will lead to the change of ash chemistry, and cause many problems, such as corrosion, fouling, potential leaks into the plant, high maintenance cost, and very stringent safety management[12]. The overall net efficiency is reported to be decreased by 8-12% points, which leads to a 21-35% increase in fuel consumption as significant auxiliary power is required to separate the oxygen from the air, to purify and liquefy CO₂-enriched flue gas[13]. The post-combustion CO₂ abatement is a straightforward approach and forms the basis of the current infrastructure in CCS. Despite distinct advantages of both pre-combustion and oxy-fuel capture, these methods will unlikely replace the post-combustion capture on a global scale. The fundamentals of the different methods and their economic impacts were recently discussed in detail[13].

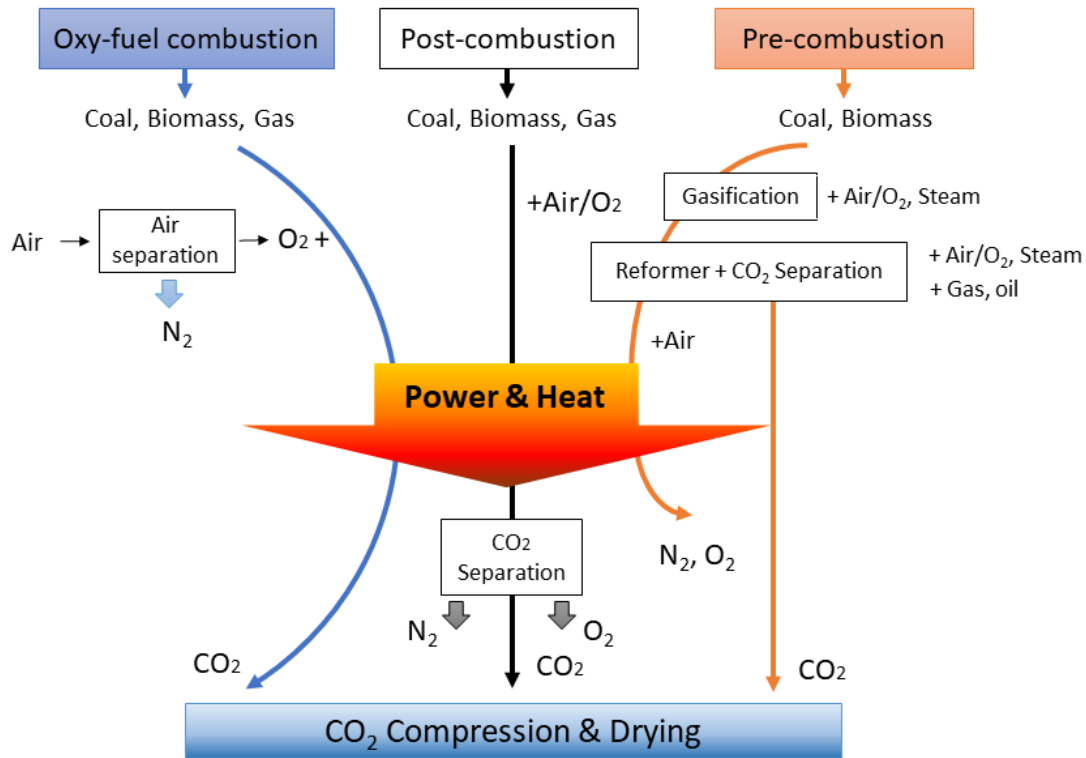

Figure 1. The different CCS Systems, with Coal, Natural Gas and Biomass as energy sources

This article provides a review of various post-combustion capture techniques and the development of adsorbents, absorbents and membrane separation. Section 2 mainly focuses on the fundamental principles of the four major post-combustion capture techniques. Section 3 gives detailed discussions of the absorption technologies, such as the KMALC technology, the Fluor EFG+ technology, the KM-CDR technology, the Aqueous ammonia (NH₃) process, the Chilled ammonia process, and the Dual or Strong alkali absorption. Section 4 reviews the configurations of different adsorption processes. Section 5 reviews the various types of adsorbents applied in CCS. Membrane separation techniques are dealt with in Section 6. The summary of major advantages and challenges of each technology is provided in Section 7.

2. Post-combustion Carbon Capture Processes

The post-combustion CO₂ capture technique can remove CO₂ and other gases from burning fossil fuel resources, based upon physical or chemical adsorption/absorption mechanisms. Based on the principles of the capture process, it can be classified as adsorption, absorption, membrane separation, chemical reactions, as shown in Figure 2 [14-19]. Biochemical methods involving the biological fixation by terrestrial vegetation[20] and marine or freshwater microalgae are well-known and not considered in the present review. Based on the principles of the regeneration, post-combustion capture techniques by adsorption can be classified as temperature swing, pressure swing, vacuum swing, electric swing and hybrid processes.

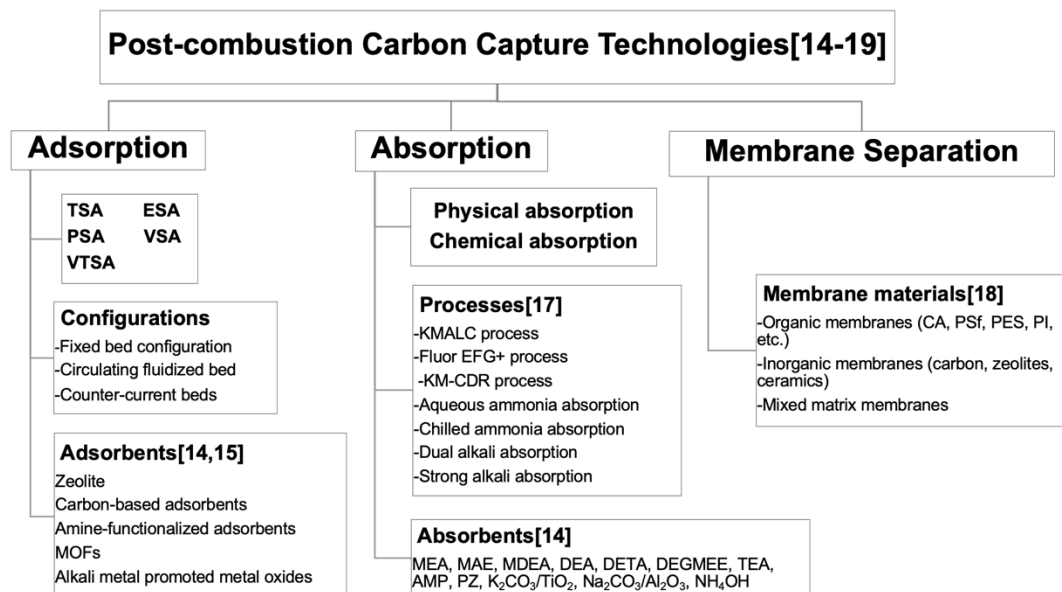

Figure 2. Post-combustion carbon capture technologies

2.1 Adsorption using the effect of altering temperatures

This adsorption method referred to as Temperature Swing Adsorption (TSA) is related to adsorbing volatile organic components from the air. In TSA, CO₂ adsorption and desorption cyclically occur by adapting the operating temperature. TSA involves

several connected vessels, operating with fixed, moving or fluidized beds. Adsorption occurs mostly at a lower temperature, where desorption requires heating of the adsorbent bed and a cyclic mode of adsorption and desorption is hence applied. The advantages of TSA are multiple: (1) the impact of impurities in the flue gas such as SO_x , H_2S , NO_x and H_2O vapour is low, and these impurities are removed at a temperature of $\sim 160^\circ\text{C}$; (2) TSA systems are operated at low pressure (< 4 bar), and can hence be easily maintained; (3) TSA is often cheap to operate, but has a high initial cost; and (4) TSA is readily integrated into existing power plants, where low-grade waste energy is available for adsorbent regeneration. It is a low-risk and short-term implementation option[21].

Whereas CO_2 adsorption is favoured at a low temperature, $40\text{-}60^\circ\text{C}$, desorption requires a higher temperature between 120 and 160°C , implying that the adsorption columns are sequentially operated at 60°C (to efficiently capture CO_2), and then heated mostly by hot air or steam to 120°C to release CO_2 , and finally to 160°C to remove possibly present impurities. A large air flow rate is needed for heating the bed for regeneration, due to the low heat capacity of air, thus diluting the released CO_2 stream. This dilution is partly avoided when using steam, and totally avoided when the desorbing bed is heated electrically[16].

The TSA heating and cooling cycles are energy-intensive, which consumes and research was conducted to reduce this energy penalty through optimising the capture process, through energy integration, and through developing adsorbents for use at lower temperatures. Operation costs are significantly reduced in power plants, since a large amount of low-grade heat is available. For industrial plants, such as cement and lime plants, regeneration heat is normally also present onsite. If an additional heat generator is required, it will significantly affect the economics of CO_2 capture[21]. Although

fluidized beds are widely used in the post-combustion CCS, Pirngruber et al. demonstrated that a fixed bed operation has a higher thermodynamic driving force for CO₂ adsorption, compared to fluidized bed[22]. Fixed bed heat transfer is however significantly lower than in fluidized beds, and a higher heat exchanging area will be required. Both fixed and fluidized bed processes see their performances significantly improved when the adsorption is operated under nearly isothermal conditions. Operating temperature, energy consumption, CO₂ purity and subsequent recovery, yields and regeneration gas flow rate are interrelated in a TSA. A higher desorption temperature will increase the CO₂ purity and recovery, but will be associated with a higher energy consumption. The minimum energy consumption (minimum CO₂ desorption temperature) is a strong function of the purge flow rate. Clause et al. confirmed a higher productivity at a low purge flow rate for a lower desorption temperature (below 130°C), while a high purge flow rate increases the productivity above 130°C[23]. With a regeneration at 160°C and a purge of 0.3NL·min⁻¹, the minimum energy consumption to obtain a 95% pure CO₂, at an 81% CO₂ recovery was 3,230 kJ kgCO₂⁻¹, while CO₂ productivity of 57.7 g kg_{ads}⁻¹ h⁻¹ was achieved. To increase the TSA performance, a preliminary pre-cooling step can be used to limit the initial CO₂ breakthrough when the bed is still hot. An increased productivity and reduced energy consumption can be obtained by using a hybrid VTSA process with a decreasing desorption temperature. A balance between heat and electrical consumption needs to be investigated[23].

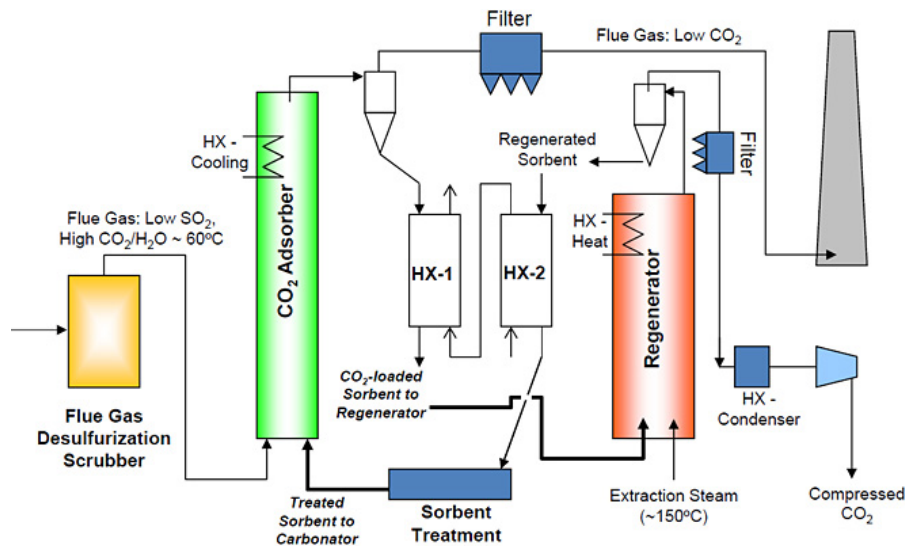

Figure 3. Flow sheet of a temperature swing CO₂ capture using solid sorbents (retrieved from www.netl.doe.gov)

2.2 Pressure swing adsorption

In pressure swing adsorption (PSA), CO₂ is adsorbed onto the surfaces of solid sorbents at a high pressure and is released at a low pressure. The operating principle relies upon molecular characteristics and affinity of CO₂ and N₂ for the solid sorbents. At a higher pressure, CO₂ is selectively adsorbed by the adsorbent bed, whereas N₂ will not be adsorbed. When the bed is saturated with CO₂, regeneration can be achieved at a low pressure, thereby releasing the adsorbed CO₂, and a new CO₂ adsorption cycle can be started. The advantages and disadvantages of PSA in CO₂ capture will be discussed in the comparison of VSA in the next section. The PSA can, however, be combined with TSA to improve the recovery and purity rate of captured CO₂. The combination of PSA and TSA (PTSA) can achieve a 99% CO₂ purity and a 90% CO₂ recovery using a dedicated zeolite[24].

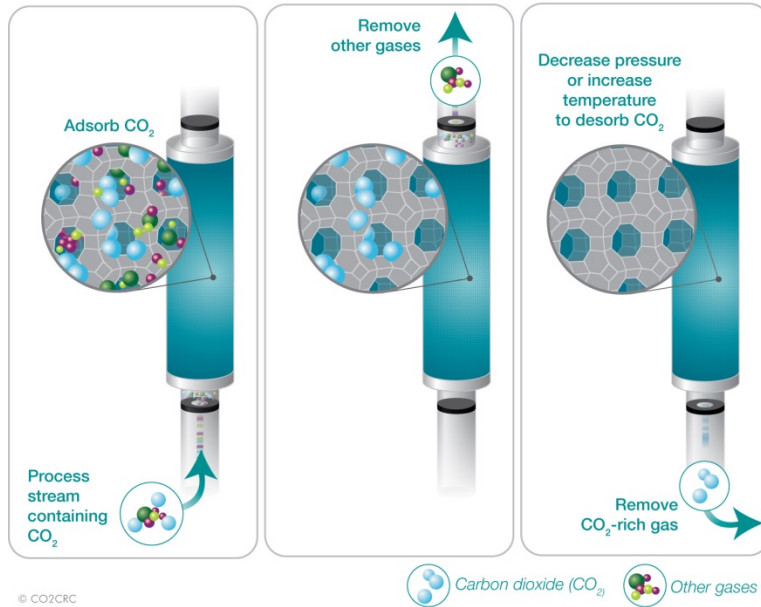

Figure 4. Principles of a PSA Operation (retrieved from http://www.co2crc.com.au/aboutccs/cap_adsorption.html)

2.3 Vacuum swing adsorption (VSA)

The VSA process has been industrially used for CO₂ separation for several decades with advantages of a potentially extended use of the adsorbent, of process simplicity, and of low energy consumption[25-27]. The adsorption at atmospheric pressure is followed by desorption under vacuum, thus different from PSA. In the VSA case, the high desorption efficiency under vacuum enables the use of a single absorption/desorption vessel, and high separation efficiencies and yields are obtained: in a VSA with an activated carbon adsorbent, a 17% CO₂ flue gas concentration can be concentrated to >> 99% with a recovery of 68.4%[28].

VSA applications avoid several operation modules of the traditional PSA systems, since avoiding the use of feed air compressors, process valves, associated dryers and feed air filtering systems. The single-vessel VSA system eliminates many problems associated with the design of a two-bed PSA, and its simplicity contributes to a higher efficiency,

lower cost, and reduced maintenance. VSA systems are moreover less susceptible to dust deposits in the adsorbent bed since the pressure swings are of a lower order of magnitude. The lower operating pressures also both prevent water condensation, thus allowing operation in humid environments, and provide a superior regeneration of the molecular sieve, thus extending its service life contrary to a PSA that commonly requires re-packing of the adsorbent sieve material every 3–5 years. Since no air compressor is required, energy requirements are around 50% of the simplest PSA systems. Since a VSA operates within the steepest part of the isotherm curves, it has the potential to achieve maximum efficiencies[24].

Many factors determine the performance of PSA and VSA systems, such as feed gas temperature and CO₂ concentration, applied pressures, nature of the adsorbents, and flue gas impurities. Zhang et al. demonstrated that a VSA process has a CO₂ recovery in excess of 70%, a CO₂ purity exceeding 90% and a low power cost when the VSA was fed at 40°C and used a moderate vacuum[29]. Feeding a higher CO₂ concentration to the plant will enhance the performance. Simulation and measurements of a three-bed pilot plant moreover demonstrated that the 13X zeolite selectivity and thermal effects had a more outspoken effect on the specific power consumption than on the CO₂ adsorption capacity, while its increased specific surface area did not enhance the overall performance. The upper limit of adsorbent performance was estimated by Maring and Webley using a model-material with the specific surface area as MOF-177: applying 35 kJ heat during CO₂ adsorption yielded a 68% increase in operating capacity and an increased purity from 78% to 94% in comparison with 13X zeolite[30].

Kinetics and adsorption capacity of potential solid sorbents for PSA and VSA were screened at the University of Edinburgh using a "Zero Length Column" and a "Dual Piston PSA" approach. These screening tests can moreover support molecular

modelling and simulation of novel nano-porous materials, and membrane-based CO₂ separation. Maring and Webley applied a simplified P/VSA adsorption model for preliminary screening of CO₂ adsorbents, based upon combining and outweighing a complete adsorption simulation and assessment of isotherms and selectivity calculations[30]. A complete simulation is tedious and requires a detailed knowledge of the PSA operation, while simple calculations are mostly incorrect and misleading. PSA and VSA are very sensitive to the flue gas impurities. The flue gas from a typical power plant usually contains 68–75% N₂, 10–15% CO₂, 5–10% H₂O, 2–5% O₂ and a trace amounts of NO_x and SO_x[31]: a pre-treatment/drying stage has to be applied to remove H₂O, NO_x and SO_x from the flue gas, thus significantly increasing the overall capture cost[29, 32]. Research hence mostly uses a dry feed gas.

The use of a hybrid VSA/TSA process can improve the CO₂ capture, as shown in Figure 5. It was found that a VTSA can significantly increase the desorption rate of CO₂ compared to TSA or VSA. The productivity and purity of captured CO₂ follow the order of VTSA>VSA>TSA, and the CO₂ concentration would be 97% with a VTSA process[33].

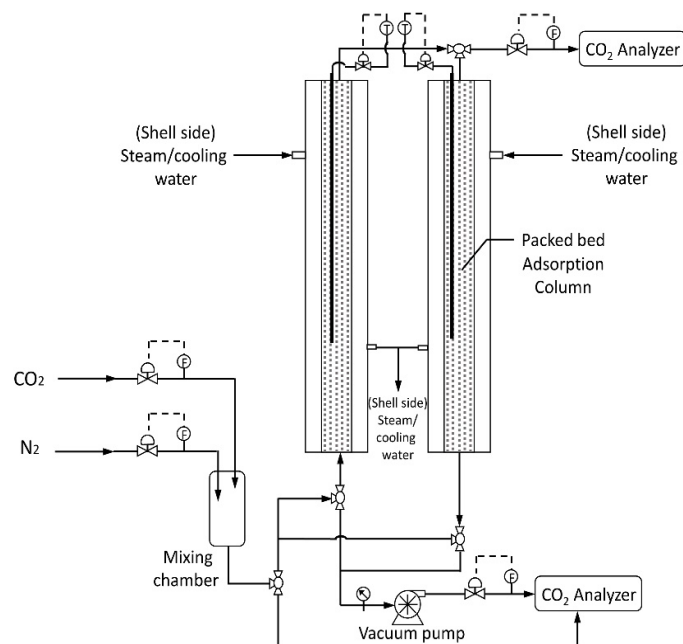

Figure 5. Combination of TSA and VSA with T as thermocouple and F as mass flow rate controller. The figure is reproduced with permission from [34].

2.4 Electric swing adsorption (ESA)

This ESA method was first applied for CO₂ capture in 1997, based upon activated carbon adsorption of volatile organic compounds (VOCs) from the air. A low voltage electric current is supplied to the adsorbents to regenerate them and the adsorbent bed directly heated by Joule effect, hence potentially reducing the energy cost for CO₂ capture without heating the adsorption unit and its accessories. Compared with PSA and TSA, ESA offers several advantages including less heat demanded, fast heating rate, better desorption kinetics and dynamics, and independent control of gas and heat flow rates. Semi-conductive activated carbon fibre materials have a high specific surface area, a high adsorption capability, and a high water vapour resistance. They are thus suitable for directly heating the adsorbent through Joule effect. Morphologies of activated carbons as monoliths, beads and fibre cloth were extensively compared by Luo et al. Activated carbon monoliths showed the lowest pressure drop, the highest permeability and the lowest cost, followed closely by activated carbon fibre materials[35]. These advantages significantly reduce the capital and operating costs.

The economy of ESA mainly results from the energy savings in the desorption step when the Joule effect is solely applied to the adsorbent bed. To optimise the process in view of a higher energy efficiency, investigations hence focused on the desorption operating parameters, including the carrier gas flow rate, the current/voltage and energy intensity, and the time for preheating. The electric conductivity remains an important property of the ESA adsorbent, and a few CO₂ adsorbents only can use the Joule effect[36].

2.5 Summary of TSA/PSA/VSA

Within the post-combustion CCS techniques mentioned above, costs and energy penalties need to be considered. In general, TSA is suitable for both adsorption using solids and absorption using solvents. The requirement of TSA on the impurities (H_2S , SO_x , NO_x) in flue gas is not very strict. The adsorbed/absorbed H_2S , SO_x , NO_x , etc. can be removed from adsorbents or solvents at a higher temperature. However, the energy penalty of TSA is high as the regeneration is often at a temperature around 140°C , and adsorption/absorption is at a temperature around 40°C . The repeated heating and cooling of the solvents/adsorbents consumes a large amount of energy. Development of new solvents/adsorbents with a high capacity and a low regeneration temperature is urgently required. PSA and VSA are suitable for the adsorption process, and can be conducted at room temperature, avoiding the cost from repeat heating and cooling. However, the pressurization and vacuum consume a large amount of energy. The impurities in flue gas have a detrimental impact on PSA, as the adsorbed H_2S , SO_x and NO_x cannot be removed from the adsorbents at ambient pressure. Cold PSA shows slightly lower efficiency than the absorption-based TSA. However, PSA may become more energy efficient if a hot gas feed can be used. Sorption-enhanced processes are even more promising. The TVSA process combines the advantages of the TSA and VSA, and can reduce the temperature required for TSA, i.e. lower the energy consumption for CO_2 capture with high CO_2 purity and recovery if a suitable low-grade waste heat source is used. The VPSA, especially a two-stage VPSA has been proven to be able to meet the CCS targets with more advantages over other technologies, such as lower capital investment and flexibility to adapt to different operating conditions[34, 37, 38]. As only a few CO_2 adsorbents can use the Joule effect in ESA processes, the

development of adsorbents/absorbents with effective Joule effect is essential for their practical applications.

3. Absorption Processes

Absorption involves physical or chemical principles to remove CO₂ from a gas stream into the bulk of liquid solvents, hence different from active-surface driven adsorption[39]. Figure. 5 depicts the counter-current flow of a CO₂-lean solvent at a low temperature (around 40-60⁰C) with the CO₂-loaded flue gas, while CO₂ physically passes the gas into the liquid phase. The CO₂-rich solvent is transferred to a thermal stripper for regeneration at 120 to 160°C and a near-atmospheric pressure. Absorbed CO₂ is stripped from the solvent, which is returned to the absorber column. The CO₂ is separated with the concentration up to 99% through releasing the gas stream from the stripper[40-42]. Flue Gas streams with up to 20% CO₂ can be handled when using appropriate solvents, such as amines.

Based upon the absorbent types, the absorption processes include alkanolamines absorption[43, 44], aqueous ammonia absorption[45, 46], dual-alkali absorption[18], sodium carbonate (Na₂CO₃) slurry absorption[47, 48] and the chilled ammonia process[49]. CO₂ absorption by aqueous amines has attracted much attention because of their high CO₂ affinity. It is a mature technique. Early applications in the natural gas industry and to produce food and beverage grade CO₂ were described in the literature[39, 50].

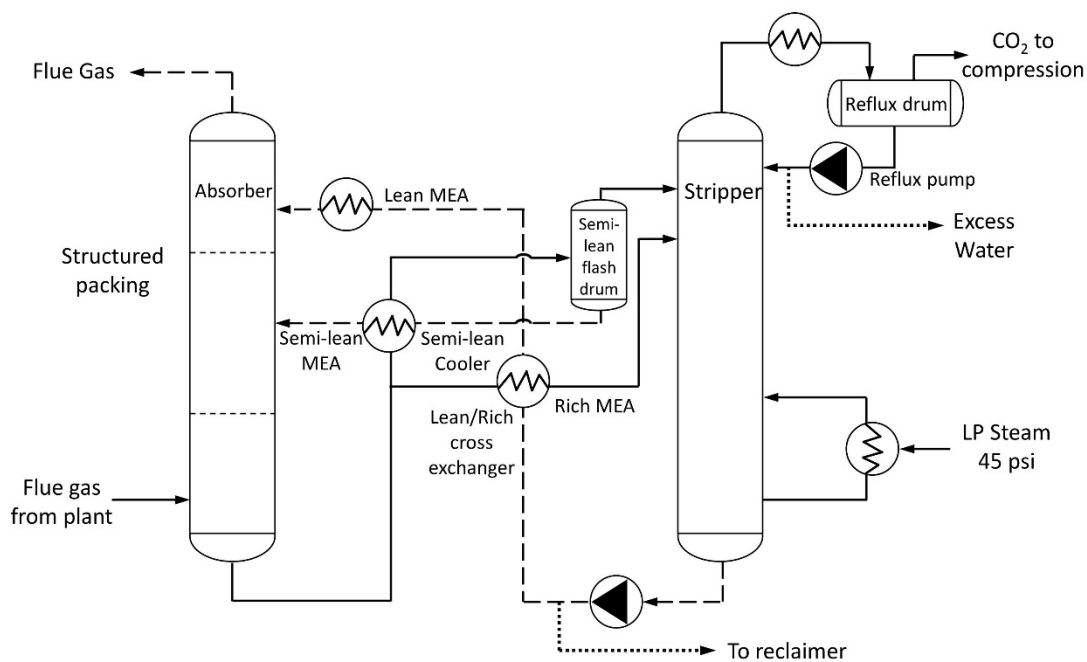

Figure 6. A typical CO₂ absorption process with absorber and stripper or desorber column (adapted from [www. power-technology.com](http://www.power-technology.com))

Alkanolamines are derived from ammonia (NH₃), where one or more hydrogen atoms are replaced by a functional group through reaction with e.g. ethanol. The number of substituents defines the classes of primary, secondary and tertiary amines, In CO₂ capture, primary amines are commonly monoethanol amine HOC₂H₄NH₂ (MEA) and diglycolamine H₂NCH₂CH₂OCH₂CH₂OH (DGA). Secondary amines are mostly 2,2'-iminodiethanol C₄H₁₁NO₂ (DEA), diisopropanolamine (DIPA) and monomethylethanolamine CH₃NHCH₂CH₂OH (MMEA). Tertiary amines include N-methyl-2,2'-iminodiethanol CH₃N(C₂H₄OH)₂ (MDEA), triethanolamine (TEA) and dimethylethanolamine (DMMEA). The reaction of CO₂ with amines is reversible since the weak bond formed is easily disrupted when heating the liquid. CO₂ reacts with MEA to form a carbamate and bicarbonate solution while releasing 83.6 kJ/mol as shown in

equation (1)[51]. Upon heating the MEA solution, the MEA carbamate and bicarbonate are decomposed while regenerating the amine and releasing CO₂.



MEA is generally considered for immediate industrial applications to remove CO₂ and H₂S[52], despite critical drawbacks of high-energy consumption and corrosion. A recent study reported that the energy penalty is very high with an estimated efficiency loss from the MEA installation between 25 and 28% for new constructions and between 36 and 42% for retrofitting an existing plant[53]. MEA is much more corrosive than secondary or tertiary amines. The degradation of MEA absorbents is attributed to irreversible chemical reactions between the oxygen and acids from flue gas components and the amine solution. The MEA absorbents are degraded to corrosive, toxic and dangerous chemicals[54]. Approaches to decrease the energy consumption includes improvement of the operation in the stripper (reboiler) temperature[55], a higher alkanolamines concentration[56], CO₂ loading, mixed amines, and mixture of ionic liquid and alkanolamines[57]). For example, the amine corrosion rate for AISI 1018 carbon steel coupon is $r_a = k_a \exp\left(-\frac{\Delta H}{T}\right) \cdot [amine] \cdot [CO_2]^b \cdot [O_2]^c$. If the solvent temperature at the stripper decreases from 120°C to 70°C, the corrosion rate will be reduced by $\exp\left(-\frac{\Delta H}{339}\right) / \exp\left(-\frac{\Delta H}{343}\right) = \exp(0.000371\Delta H)$. For MEA, $\Delta H = 8963.8J$, the corrosion rate will be reduced to 1/28 of the corrosion rate at 120°C.

Commercially-available MEA processes can be classified as the Kerr-McGee/AGG Lummus Crest process (KMALC)[58], the Fluor Econamine FG PlusSM process (Fluor EFG+), and the Kansai Mitsubishi Carbon Dioxide Recovery Process (KM-CDR)[39].

3.1 The KMALC Process

This technology uses a 15–20 wt % of MEA solution. A KMALC demonstration plant yielded a CO₂ absorption capacity of 800 ton CO₂/day with 2 parallel absorption columns[58, 59].

3.2 The Fluor EFG+ process

This CO₂ capture process is proven, cost-effective and applicable to low-pressure, O₂-containing flue gas. It was licensed to 28 plants worldwide[60]. The CO₂ recovery pilot plant, commissioned in 2012 at the E.ON's coal-fired power plant in Wilhelmshaven, Germany, was designed to handle 19,500 Nm³/h flue gas or 70 ton per day CO₂ at a 90% CO₂ recovery. The more recent large-scale CCS plant, using the Econamine FG PlusSM Process, was designed for NRG's WA Parish Electric Generation to capture 90% of the CO₂ present in a 240 MW equivalent flue gas stream, thus producing 4,776 ton per day of supercritical CO₂ for sequestration. The Econamine FG PlusSM Process was optimized to reduce the regeneration energy needs and capital cost, to reduce the solvent flowrate and the environmental footprint. Improvements involve a flue gas conditioning (cooling and reducing the SO₂ concentration), absorber intercooling, and a lean vapour compression in the solvent regeneration step. Increasing the MEA concentration to 35 wt% in a recent plant, reduces the solvent degradation through oxidation, while the corrosive nature of the MEA solvent is reduced by adding a proprietary inhibitor to the MEA solution. SO₂ should be removed to below 10 ppm to limit the cost of proprietary inhibitors and excessive solvent makeup[39, 59, 60].

3.3 KM-CDR technology

This process, launched by Mitsubishi Heavy Industries, Ltd. (MHI), in collaboration with Kansai Electric Power Co., Inc. (KEPCO), aimed at reducing the CO₂ capture costs for oil industries. Several (>10) of such plants are currently operated in chemical and fertilizer industries with a maximum CO₂ capture capacity of 450 metric ton per day. CO₂ is captured from the flue gas of a natural gas-fired steam reformer and subsequently used to react with ammonia to produce urea. For the CCS purpose, the KM CDR process of Alabama Power's Plant Barry (USA) can achieve a 500 ton/day CO₂ capture and demonstrates the black coal 'full chain' CCS. Both initial partners, MHI and KEPCO, further improved the energy-efficiency of the process by using the sterically hindered amine solvent, KS-1TM [61], where a bulky molecule is attached to a nitrogen atom as illustrated in equation (2). It is slightly corrosive and less prone to O₂ degradation compared with the MEA[62, 63].

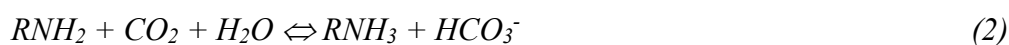

Despite anti-corrosion and low degradation advantages, a low CO₂ loading capacity (< 0.40 kg CO₂/kg for MEA[51]), a high energy consumption in stripping/regeneration, a large plant, and the production of a hazardous waste stream (which increases the plant footprint) are recognized drawbacks[39].

Diethanol amine (DEA) and methyldiethanol amine (MDEA) have been used in CCS to overcome the drawbacks of MEA absorption. Although DEA and MDEA have a similar molecular structure and are of comparable basic strength (DEA, $K_{b(293\text{ K})} = 1.02 \times 10^{-5}$; MDEA, $K_{b(293\text{ K})} = 5.53 \times 10^{-6}$)[64], their chemical performances in CO₂ capture and desorption are different. Compared with tertiary MDEA, the secondary DEA has a lower absorption capacity but a higher reaction rate towards CO₂. By using ¹³C NMR spectroscopy, Barzagli et al. demonstrated a maximum loading capacity for DEA and MDEA of 0.5 and 1 mol, respectively. At equilibrium, achieved after 13 h,

the CO₂ absorption efficiency is 82.6% in MDEA, and 84.0% in DEA. The amine regeneration efficiency ranges on average from 69.6% (DEA) to 78.2% (MDEA)[65]. The required regeneration energy is lower for primary and secondary amines than for tertiary amines.

The absorption capability of different alkanolamines was further correlated in terms of their structural properties and operating parameters (reaction temperature, flue gas flow rate, CO₂ partial pressure, the concentration of the absorbents and the acid-base reaction mechanisms). Idem et al. demonstrated that a mixture of MEA/MDEA can achieve a modest reduction of the circulation rate, but a large reduction in the required stripping heat, in comparison with the MEA system[66].

3.4 Aqueous ammonia (NH₃) process

Ammonia has been regarded as a possible alternative to the MEA solvent as it is a relatively cheap, commercially available solvent with a relatively high CO₂ absorption capacity. It is less corrosive and has a lower susceptibility to degradation compared with MEA. Ammonia reacts with CO₂ as described by equations (3-5)[17, 67]. Carbamate is mainly formed in the early reaction stages where excess ammonia is present, while in the final NH₃-lean stage the main species becomes bicarbonate. To counteract the high volatility of ammonia, the CO₂ adsorption is achieved at a low temperature of 15 to 27°C. CO₂ is stripped from the CO₂ loaded solution by heating to between 27 and 92°C in a stripping column. Ammonium bicarbonate and carbonate thermally release CO₂ while restoring the original ammonia solvent. The bicarbonate formation is more desirable since its decomposition heat is lower than that of carbonate. Throughout the process, the carbonate concentration is lower than the concentration of

carbamate[17, 36, 68]. The carbonate formation is promoted at a high pH, whereas bicarbonates are preferably formed at a low pH.

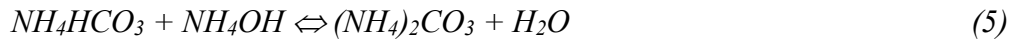
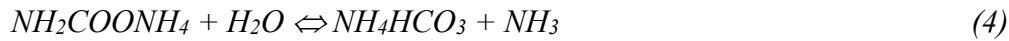

The CO₂ capture efficiency increases exponentially with a moderate increase of the aqueous ammonia concentration and the maximum efficiency is 99%. A high concentration of aqueous ammonia is however detrimental to the absorption efficiency, which achieves a limit value, as demonstrated by Zhu et al.[69].

The forward ammonia-CO₂ reaction dominates at low temperature (around ambient temperature), but is reversed at a higher temperature in the range of 38 to 60°C[70].

The reaction temperature affects the CO₂ absorption efficiency in a complex and a non-monotonical manner, whereby all operating parameters (flow rates, energy consumption, reactor design) should be considered.

Similar to other absorption processes, the CO₂ capture efficiency is a function of the intimate contact between ammonia and CO₂, as fostered by a large contact surface area to increase the mass transfer. Hollow fiber membranes[71, 72], rotating disc high gravity reactors[73, 74] and vortex spray scrubbing technology[75, 76] have been designed for increasing the contact area. Both latter methods are similar in principle which enhances the liquid-gas mixing and mass transfer by externally applied super gravity or centrifugal rotation forces[17].

Ammonia also reacts with the impurities NO₂ and SO₂ (in an oxidizing atmosphere present as SO₃) to generate NH₄NO₃ and (NH₄)₂SO₄ respectively. The products from

the aqua ammonia process (carbonates, nitrates, sulphates) could be directly used as fertilizers, hence saving energy otherwise required in solvent regeneration, CO₂ compression and storage.

In comparison with the other absorption processes, the aqueous ammonia absorption offers the advantages of a high CO₂ loading capacity (1.20 kg CO₂/kg NH₃), the possible reaction with other flue gas impurities, and the formation of co-fertilizer-grade ammonium nitrate and sulphate. Its major disadvantages are the loss of volatile NH₃ vapor (NH₃ slip), the secondary contamination during stripping, and the high-energy needs in the solvent regeneration stage[39, 77].

3.5 Chilled ammonia process, CAP

Patented in 2006 by Eli Gal, the CAP process absorbs CO₂ at low temperatures (between 0 and 20°C but preferably below 10°C), and it significantly reduces the concentration of moisture, acidic and volatile components. CAP reduces the NH₃ slip, and limits the NH₃ loss to less than 6% of the solvent, compared with conventional aqueous ammonia process with common NH₃ losses up to 9%[78]. The adsorption step applies a 28 wt% ammonia solution at a near-atmospheric pressure. The recycled CO₂-lean stream should have a low molar CO₂ ratio of the ammonia molar amounts (ammonia in its various aqueous forms) and ranges between 0.25 and 0.67, but preferably between 0.33 and 0.67 hence fostering a high adsorption efficiency. To release CO₂, the CO₂-rich stream is pressurized and heated to 100-150°C in the desorber. Both low absorption and desorption temperatures reduce the respective energy consumptions and absorbent degradation, and it was claimed that CAP energy use is only 50% of the energy use in a conventional MEA process[6], despite the extra energy needed for flue gas cooling, water condensation, cooling of the recycle CO₂-lean

solvent stream, and abatement of the NH₃ slip. Drawbacks of CAP include the NH₃ volatility, the low absorption rate, the use of multiple absorber vessels[49].

3.6 Dual alkali absorption (DAA)

DAA modified the Solvay process. CO₂ reacts with NaCl, methylaminoethanol (MAE) and water to produce sodium bicarbonate (NaHCO₃), subsequently calcined to produce commercial grade Na₂CO₃, as shown in Equation (6). In the capture process, MAE catalyses the absorption of CO₂, while NaCl increases the Na⁺ concentration to enhance the precipitation of NaHCO₃. The calcination of NaHCO₃, with associated CO₂ release, hampers the application of the process for large scale CO₂ capture. The gas stream must be cooled to 25⁰C and be treated in a de-NO_x/ de-SO_x step. Acidic impurities from the flue gas (e.g. SO_x and C_nO_x) and ash will react with MAE to generate heat-stable salts, which are regarded as one of the leading reason of absorption capacity reduction of the system[54]. A pre-treatment of the flue gas is thus required to remove impurities[41].

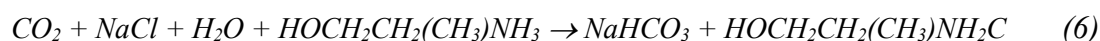

3.7 Strong alkali absorption

Alkali metal-based oxides can be used for CO₂ capture in the presence of H₂O to form e.g. sodium or potassium bicarbonates at temperatures of 50-60°C. At a moderate temperature of 120-200°C, these bicarbonates decompose and release both CO₂ and H₂O. Water can be easily removed through condensation. For adsorption and regeneration, fluidized-bed or transport reactors can be used. Common adsorbents are mixtures of K₂CO₃ and activated carbon, K₂CO₃ and Al₂O₃, K₂CO₃ and TiO₂, K₂CO and MgO, Na₂CO₃ slurry. These strong alkali reactants have high CO₂ capture capacities and carbonation reaction rates are high[11, 79]. They can be fully regenerated

within a temperature range from 130 to 400°C (130°C for $\text{K}_2\text{CO}_3/\text{AC}$ and $\text{K}_2\text{CO}_3/\text{TiO}_2$, 350°C for $\text{K}_2\text{CO}_3/\text{MgO}$ and 400°C for $\text{K}_2\text{CO}_3/\text{Al}_2\text{O}_3$). When the regeneration temperatures are below 200°C, the reduced CO_2 capture capacity of $\text{K}_2\text{CO}_3/\text{Al}_2\text{O}_3$ and $\text{K}_2\text{CO}_3/\text{MgO}$ is mainly caused by the formation of $\text{KAl}(\text{CO}_3)_2(\text{OH})_2$, $\text{K}_2\text{Mg}(\text{CO}_3)_2$ and $\text{K}_2\text{Mg}(\text{CO}_3)_2 \cdot 4(\text{H}_2\text{O})$.

The support material plays an important role in the process absorption and regeneration capacities. In humid conditions, $\text{K}_2\text{CO}_3/\text{AC}$ is more suitable for cyclic fixed-bed operation, while $\text{K}_2\text{CO}_3/\text{Al}_2\text{O}_3$ is more applicable in fluidized-bed systems. The good multi-cycle behaviour of this attrition-resistant sorbent is particularly beneficial for the CO_2 capture capacity[80].

Although strong alkali adsorption does not involve the use of volatile chemicals, its lower absorption rate of CO_2 in comparison with amines, and the large equipment size of the absorption remain major drawbacks.

3.8 Summary of absorption

Chemical absorption with amines is currently the most mature technology for CO_2 capture and has been commercialized for many years. Prior to absorption, other acid gases such as SO_2 and NO_2 should be removed to reduce the formation of thermally stable by-products. Beside the high-energy penalty, thermal degradation and corrosion are other two major problems. In terms of capture performance and the regeneration cost, MEA is the best single solvent for CO_2 capture. 30% of MEA aqueous solution is still the most commonly used solvent for chemical absorption for CCS. Recent research has demonstrated that the mixture of MEA with other solvents can provide much better CO_2 absorption capacity and kinetics[81]. The regeneration temperature can be reduced significantly. The addition of the DEGMEE to MEA solution, especially those at low

MEA concentration (20–40 wt%) showed good absorption and desorption rates, but also low energy consumptions during the regeneration steps. The addition of NMF to MEA greatly enhanced the CO₂ absorption kinetics due to a possible increase of the pKa of MEA when dissolved in NMF, but the presence of the amide group and high dielectric constant of NMF may speed up the deprotonation step of the zwitterions into carbamates.

Solvent-based absorption process presents a series of drawbacks, such as high energy requirement with sorbent regeneration, solvent losses due to thermal and chemical degradation, evaporation, corrosion, reduced absorption capacity when flue gas impurities are present (e.g. O₂, SO₂, HCl and particulates). New effective solvents are crucial to developed for a lower energy consumption and acceptable solvent degradation and corrosion. The use of mixed solvents may be a right approach towards this direction.

4. Adsorption Processes

Adsorption processes are low-cost alternatives for post-combustion CO₂ capture. It is a physical or chemical process where atoms, ions, or molecules from a gas, liquid, or dissolved ions are captured by the adsorbent. CO₂ adsorption on surfaces of the solid adsorbents mostly involves physical principles via the formation of a range of physical interactions between CO₂ and solid surfaces, by e.g. the Van der Waals force. The adsorption is reversible in the function of applied temperature or pressure without adsorbent degradation. After desorption, the adsorbents can be recycled many times. The thermodynamics of the gas-adsorption is governed by the adsorption isotherms (P, T), which define how the adsorption capability of the solid depends on temperature and

pressure. Physical adsorption has a lower adsorption heat than chemisorption, and the heat required for CO₂ desorption is even lower.

Adsorption and desorption will hence apply a pressure swing or temperature swing process (PSP and TSP). In PSP, CO₂ is captured at high pressure, and desorbed from the solids by a pressure reduction. The opposite is used in TSP with a low temperature during adsorption and a higher temperature for desorption. The number of molecules adsorbed increases with the increase of pressure, up to a saturation status. In TSP, CO₂ is favourably attached to adsorbents at a low temperature due to the exothermicity of adsorption. Temperature swing operation can also remove other adsorbed impurities, i.e. SO_x and NO_x, thus maintaining a high CO₂ concentration. TSP omits the energy penalty of the PSP-compression of CO₂. Regeneration in PSP is however much faster than in TSP. Several configurations have been proposed for both pressure and temperature driven processes, as discussed hereafter.

4.1 Fixed bed configuration

The fixed bed application is shown in Figure 7, where adsorption and desorption take place in a single column. After a certain time, mainly determined by the amount of CO₂ to be adsorbed and by the amount of adsorbent being present, the fixed adsorber bed will progressively be saturated (from bottom to top) and CO₂ will break through at the column exit. The adsorption step is then interrupted, and desorption is started.

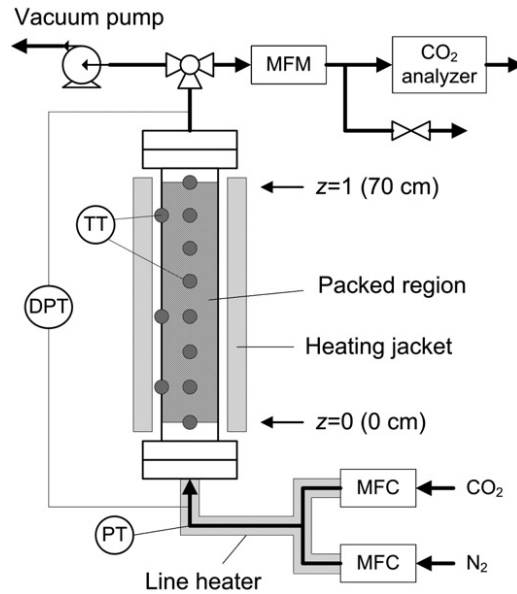

Figure. 7. Fixed bed setup with stainless steel adsorption column, packed in the middle with zeolite 13X. A glass mesh in the bottom 10 cm of the column ensured a uniform gas distribution. The figure is reproduced with permission from [82].

4.2. Circulating fluidized beds (CFB)

The CFB configuration is a mature technology, which is used in many applications such as metallurgy, biomass combustion and chemical industry in general. It is mainly used because of some highly beneficial properties including excellent heat and mass transfer and its capability to handle large gas flow rates. Its scale-up is relatively easy and can be performed in a short timescale. Two separate columns, i.e., the downcomer and the riser are present in this configuration to perform the CO₂ adsorption and desorption simultaneously: CO₂ capture takes place in the riser and the adsorbent regeneration in the downcomer. The adsorbed CO₂ and the residual CO₂ in the flue gas at the exit of the riser are close to being in equilibrium.

The CFB used by Veneman et al (2012) for continuous CO₂ capture is depicted in Figure 8. Amine functionalized beads were used as adsorbents, circulating between the

riser and downcomer[83] and introduced a simulated flue-gas at the bottom of the absorber fluid bed. Selective adsorption of CO₂ from the flue gas in both the absorber fluid bed and the riser section was observed at temperatures between 40 and 60°C. The transport of the sorbent particles in the riser and to the cyclone was carried out via a co-current gas flow. The CO₂-loaded particles were separated in the cyclone and transported downwards again via the downcomer to the regenerator section. The purified gas was evacuated from the system via the cyclone exhaust. The fluidised bed of the desorber was rectangular with a cross-section of 5×3 cm² and was 1 m high. Water cooling was applied to the adsorber section through the concentric tube with 4 cm inner diameter and 0.5 m height. The riser consisted of a 1.9 m long glass tube with an inner diameter of 1.5 cm[83].

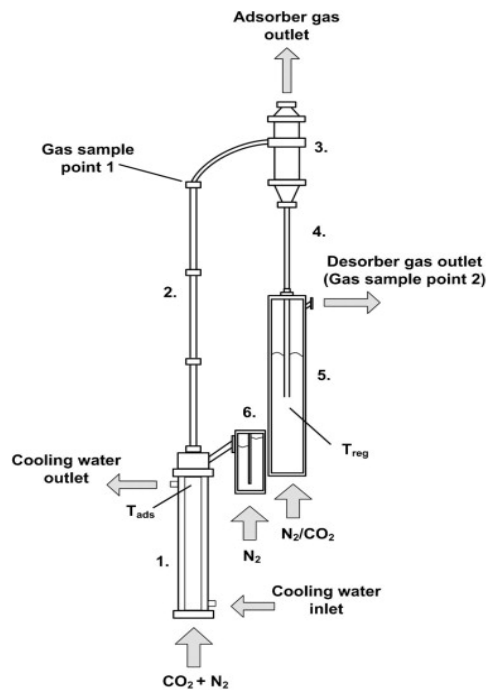

Figure 8. CFB set-up [the figure is reproduced with permission from[83]]. The sorbent recycle loop seal 6 connects the adsorber and desorber columns and prevents undesired mixing of flue gas and the purge gas.

Dinca and Badea (2013) described a pilot-scale CFB system using MEA as an absorbent for CO₂ separation from flue gases. Heat contained in the flue gases is used for the regeneration of the MEA, combined with additional heat supply via an electrical re-boiler. The added heat increased in the solvent temperature to 90-100°C[84].

Recently, Veneman [85] utilized multi-stage fluidized bed desorber with a gas-solid trickle flow adsorber to achieve the counter-current flow of sorbent and gas, to improve the operational efficiency of the TSA process. The increasing the number of stages in the adsorber and desorber can achieve a better working capacity, hence, reducing the energy consumption for CCS in TSA processes [86].

4.3 Counter-current beds

Although yet not further investigated, some US patents (US 7594956 and US 5169607) describe a counter-current moving bed for flue gas CO₂ capture, executed as a parallel plate heat exchanger, and capable of treating 80 to 500 °C flue gas. Detailed conditions of the operation are however not specified in the patents, thus making its assessment impossible.

In summary, the fixed bed configuration combines adsorption and desorption (regeneration) in a single column. This arrangement can reduce capital investment, maintaining cost and operational cost, but works in intermittent operation mode and the gas-adsorbent contact time is shorter. Circulating fluidized bed provides a continually operational mode. The adsorption and regeneration are conducted in different columns. The co-current flow increases the contact time of flue gas with adsorbents. However, the fast motion of the adsorbents increases the erosion of the column wall and the attrition of the adsorbent particles.

5. Adsorbents

Various porous materials have been tested for their capability to adsorb CO₂. Both physical adsorption based on Van der Waals attraction between CO₂ and the adsorbent, and chemical adsorption in which the CO₂ is chemically bound to the adsorbent surface are possible. Criteria that have been put in place to evaluate the applicability and efficiency of CO₂ adsorbents are capacity, selectivity, rate of adsorption and desorption, required adsorption and desorption temperatures, thermal and mechanical stability, the possibility for regeneration, manufacturing and regeneration cost, the influence of impurities in the flue gas such as H₂O, Hg, SO₂, and NO_x, environmental impact etc. In reality, the advantages and disadvantages of an adsorbent material should be evaluated toward the practical application of the adsorption at a relevant scale, and should include cost considerations.

A wide variety of factors influence the adsorption selectivity. Examples are the concentration of active adsorption sites on the surface, pore size and pore geometry, presence of impurities and water in the flue gas, temperature and pressure of operation, and CO₂ content. Metal oxides have been identified to possess very beneficial properties in CO₂ adsorption, but they also present a strong affinity towards H₂S, H₂O, SO_x and NO_x, requiring these impurities to be removed before introduction in the adsorption bed (even to trace level). Otherwise, a strong competition with CO₂ for adsorption sites would be in place. Additionally, some of these components will accumulate at the adsorbent at each adsorption/desorption cycle because of the present low desorption rates leading to a drastic reduction in CO₂ adsorption capacity of the adsorbents.

Characteristics of the adsorption capacity and kinetics are mainly related to chemical (chemical composition of the adsorbent material) and structural (pore size, pore

structure and total exposed surface area) properties of the adsorbent. Pore geometry can be cylindrical, or in the form of interconnected cages or slits (via pore windows). The separation of gas molecules occurs because of differences in equilibrium concentration, adsorption kinetics, or molecular sieving mechanisms.

The following properties should be present to achieve an effective CO₂ adsorption: (1) a high total exposed surface area providing a high number of adsorption sites, (2) an optimal pore size distribution enabling a high intraparticle diffusivity of gases, (3) a high selectivity towards CO₂ and low selectivity towards other impurities in the flue gas, (4) a high tolerance to commonly present flue gas impurities such as SO_x, which may bind to the adsorbent surface and are not readily desorbed through regeneration, (5) a high adsorption and desorption rate to limit the required residence time in the column, (6) the application of mild desorption conditions (e.g. a low-temperature difference between adsorption and desorption operating mode)[39]. Recently, the selection criteria based on the AHP/TOPSIS approach has been proposed to compare the potential of sorbents. Particle density, the specific heat, reactions with a negative free Gibbs energy, etc. were considered as the essential criteria to evaluate the CO₂ conversion rate for chemical reaction with various sorbents. MgO and Mg(OH)₂ were shown the highest potential as CO₂ sorbents[11].

The CO₂ adsorption materials can be classified in function of their chemical composition as activated carbons, zeolites, metal organic frameworks (MOFs), amine-functionalized adsorbents, alkali-doped metal oxides, and other compounds. Based upon the pore size of the support materials, distinction can be made between microporous materials (interconnected pores with < 2 nm pore windows) and mesoporous ones (crystalline materials with narrow pore-size distributions or amorphous materials with broader pore-size distributions, however in general a pore

size in a range of 2–50 nm) adsorbents[2]. The separation mechanisms for microporous adsorbents is based on equilibrium, kinetics, or molecular sieving. The large pore size of mesoporous adsorbents enhances the mass transport of gas molecules in the interconnected pores for rapid reverse cycles. Belmabkhout et al. reported a specifically high adsorption capacity for CO₂ of mesoporous adsorbents. When combining meso- and microporous sorbents, a high mass transfer rate will allow more rapid adsorption/desorption cycles[87]. This principle was illustrated by Ma et al. for a MCM41 sorbent with both micro- and mesopores. The mesopores were tailored using either hexadecyltrimethylammonium bromide (CTAB) as a soft template, or mesoporous carbon as a hard template[88]. These obtained materials showed a high CO₂ adsorption capacity at CO₂ pressures in excess of those applied in the VSA or TSA.

5.1 Zeolite adsorbents

Zeolites are crystalline materials composed of silicon, aluminium and oxygen. The crystals are TO₄ tetrahedra (T=Si or Al), which form a matrix of channels and cavities providing a porous structure with a large total specific surface area, as illustrated in Figure 9. Zeolites show high adsorption capacities with fast adsorption rate under mild operating conditions (0-100°C, 0.1–1 bar CO₂). The adsorption capacity rapidly decreases with an increase in temperature, and becomes insignificant above 200°C. Therefore, the flue gas must be cooled to less than 100°C before zeolite adsorption. Synthesized zeolites are denoted by X (having high alumina content) and Y (having high silica content), and were initially produced by Milton and Breck[89]. The main mechanism of CO₂ adsorption on zeolite surfaces is physisorption, which was identified by near infrared (IR) spectroscopy. Cations in the silicate framework (e.g., Na⁺ and Li⁺), induce a negative charge on the framework, providing the zeolite with the capability to

adsorb a wide variety of flue gas components, such as H₂O, CO₂, NO_x, SO_x and H₂S[90]. The amount and nature of the cations determine to a large extent the adsorption. Also, the Si/Al ratio in the lattice plays a predominant role. Ideally, a low Si/Al ratio (such as NaLSX, Si/Al = 1, NaX with Si/Al = 1.25) is desirable since it promotes the presence of a higher number of cations, hence leading to a higher CO₂ adsorption capacity[91]. Substituting general cations such as Na with less common ones such as Rb, Cs, K and Li further increases the adsorption capacity of the zeolite for CO₂[92]. The K/Na ratio also affects the efficient separation of CO₂ from N₂. When the K⁺/(K⁺ + Na⁺) ratio in a NaKA zeolite is about 17 %, N₂ adsorption is negligible whereas the CO₂ adsorption capacity remains high. At a high K⁺/(K⁺ + Na⁺) ratio, the CO₂ adsorption also decreases significantly[2].

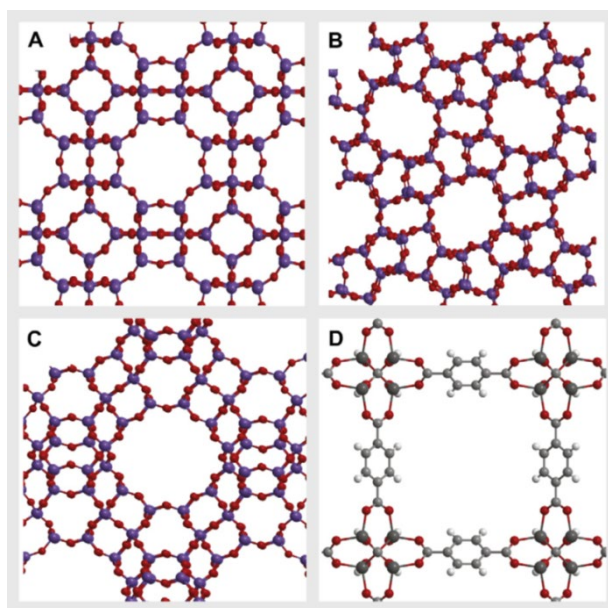

Figure 9. Structures of zeolites and metal organic framework (MOF): (A) zeolite A, (B) ZSM-5, (C) zeolite X and (D) MOF-5. The figure is reproduced with permission of [2].

The porous structure of the zeolite is an additional determining factor controlling the CO₂ adsorption. Pore size determines the diffusion rate and selectivity of CO₂

adsorption. A large pore size promotes the diffusion rate of CO₂. Whereas pore sizes similar to the kinetic diameter of CO₂ enhance the kinetic selectivity (separation of CO₂ and other gases), a small pore size prohibits the diffusion rate of CO₂ throughout the zeolite, but also improves the separation selectivity. The particle size determines gas diffusion rates: typically a quadratic decrease is observed with increasing the particle size. 13X shows the highest adsorption capacity among various commercially available zeolites (4A, 5A, 13X, APG-II, and WE-G 592) because of its largest pore diameter and volume⁸¹. 36 molecular simulations carried out by Kohen using grand canonical Monte Carlo method and the ideal adsorbed solution theory confirm the relevance of the pore structure when developing zeolites with good CO₂ adsorption properties. The disadvantage of zeolites is their strong hydrophilic nature, resulting in strong water absorption and low gas selectivity. A preferential adsorption of the polar H₂O, SO_x, NO_x and H₂S molecules to the cations in zeolites will take place, hence occupying adsorption sites for CO₂ molecules[93]. To achieve the optimal adsorption performance using zeolites, removal of the impurities (NO_x, SO_x, and H₂O) has to be thoroughly conducted prior to adsorption. Due to its strong hydrophilic property, relatively high temperature and a long time will be required to regenerate zeolite adsorbents. If the heating temperature is 150°C, the CO₂ adsorption capacity of zeolite 13X could only be restored to 2.7 mmol/g. However, when the temperature increases to 350°C for 6h under the same dry N₂ flow, the restored CO₂ adsorption capacity of zeolite 13X monoliths increased to 5.15 mmol/g[94]. The main reason is that a temperature of 150°C is insufficient to desorb water molecules from zeolite pores. Surface modification of zeolites can also increase the CO₂ adsorption capacity, water-resistance and selectivity against N₂, by functionalizing zeolites with amines to alter the CO₂ adsorption from physisorption to chemisorption[95].

5.2 Porous carbon-based adsorbents

Activated carbon, carbon nanotubes and nanofibers are all types of carbon-based adsorbents. Various low-cost raw materials are used for activated carbon production, including bamboo, coconut shells, wood, industrial by-products and other types of biomass (waste) sources[96, 97]. This leads to a wide spectrum of chemical and structural properties, and pore size (distribution) and hence a widely varying adsorption performance.

5.2.1 Activated carbon

Activated carbon is the most frequently used adsorbent in industry. For CO₂ adsorption, they have a lower cost compared to other adsorbents[98], but their adsorption capacity is only comparable to zeolites under high CO₂ pressure[99]. The adsorption kinetics of CO₂ are similar to zeolites, reaching the maximum adsorption capacity within minutes. Adsorption studies show that activated carbon exhibits lower adsorption heats compared to zeolites[28]. Their regeneration by TSA, PSA, VSA and ESA are rather easy[98]. The efficiency of activated carbon is the highest around room temperature and under high CO₂ pressure condition (>4 bar). The adsorption capacity dramatically decreases with increasing temperature. At low CO₂ partial pressure, activated carbon has low selectivity and adsorption capacity due to the unfavourable adsorption isotherms with a high degree of hysteresis. The commercial activated carbon (VR-5 and VR-93) can achieve a volumetric adsorption capacity, yielding up to 380 and 500 cm³/cm³, respectively at 25 °C and 50 bar[100].

The selectivity and adsorption capacity of activated carbon rely on the high specific surface area, complex structure and chemical characteristics, specifically the acidic and

basic character[98]. Their chemical characteristics are predominantly determined by heteroatoms that are included in the structure, such as nitrogen, oxygen, sulfur, hydrogen, phosphorus, and metal ions. These are originating directly from the composition of the raw material or being introduced via the activation process. The acidic or basic character of activated carbon surface affects the adsorption capacity and selectivity of activated carbons through the surface functional groups formed from these heteroatoms and the delocalized electrons of the carbon structure[101, 102]. The acidic character relates to the functional groups containing oxygen, and the acidity of the activated carbon will be higher when the oxygen concentration at the outer surface of the basal plane increases[103]. Lewis base sites are associated with the carbon structure itself. The basicity of activated carbon, which is closely related to the CO₂ adsorption capacity of activated carbon[104], is caused by the resonance of π -electrons present in carbon aromatic rings, which attract protons, and basic surface functionalities, such as nitrogen-containing groups[105-107].

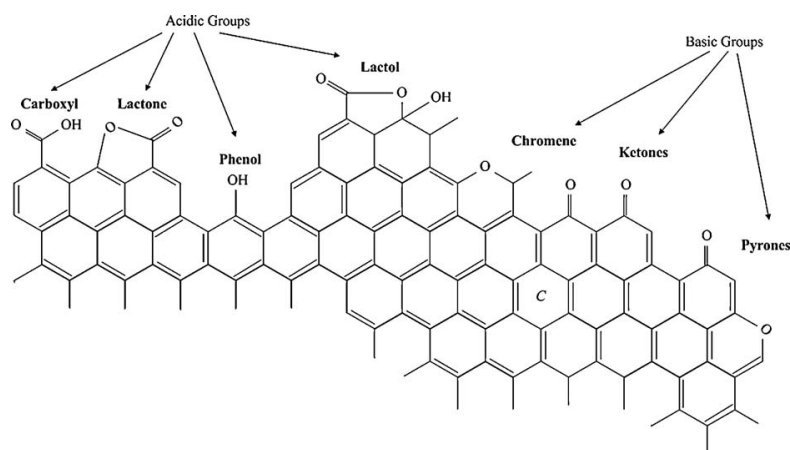
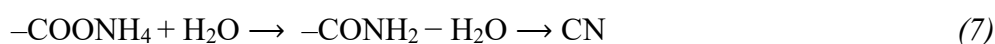

Figure 10. Functional groups (acidic and basic) in a carbon basal plane. The figure is reproduced with permission from [104, 106].

To improve the selectivity of the activated carbon materials, the basicity of activated carbons should be increased to enhance the affinity of CO₂ and the carbon material. It

can be achieved by thermal treatment and ammonia treatment, which removes or neutralizes the acidic groups, or even introduces basic groups, such as basic nitrogen functionalities. At 800–1000°C, most oxygen functional groups on carbon surfaces can be decomposed under inert nitrogen or helium, which leads to an increase in Lewis basic sites on the oxygen-free graphene layers and the few basic oxygen-containing groups (pyrone and chromene) remaining in the carbon surface[108, 109]. The unsaturated surfaces were generated due to the removal of acidic functional groups, which leads to the increase of the hydrophobicity of the activated carbons[104, 110]. Another approach to increase the basicity of activated carbon is to introduce basic nitrogen functionalities to the carbon surfaces[111, 112] by either reacting with nitric acid, ammonia, amines, or with nitrogen-containing precursors[113]. Functional nitrogen-containing groups include lactam, imide, amide, pyrrolic and pyridinic groups. When applying ammonia thermal treatment, the alkaline nitrogen functionalities are integrated in the surface by heating the activated carbons in the presence of a continuous ammonia flow. The ammonia decomposition induced by the high-temperature results in the presence of free radicals such as NH, NH₂, atomic hydrogen and nitrogen, which subsequently react with carbon and create nitrogen-containing functional groups[114]. The reaction of carboxylic acid sites with ammonia in the carbon leads to the formation of ammonium salts via dehydration, with end-products amides and nitriles:



It is reported that introducing various nitrogen functional groups to polyethylenimine (PEI)-derived activated carbon achieves 4.9–5.7 mmol/g CO₂ uptake at 0 °C and 2.9–3.7 mmol/g at 25 °C, 1 bar. The rich nitrogen content brings a typical high specific

surface micro-porosity. The PEI-derived carbons were proven to keep a high stability after multiple adsorption-desorption cycles and to keep the high selectivity of CO₂ adsorption over N₂ at 25 °C[115].

Activated carbons possess a better tolerance to water moisture and SO_x, NO_x, H₂S in the flue gas than zeolites because of their higher hydrophobicity, but still a strong competition of these with CO₂ is present for adsorption sites. The flue gas should be cooled to 25–75⁰C, and NO_x, SO_x, and H₂O have to be scrubbed before separating CO₂ from N₂. A study showed that the capacity of bamboo activated carbon would be reduced by about 75% in the presence of H₂O at 0°C and 1 bar CO₂.

5.2.2 Carbon nanomaterials

Carbon nanomaterials include fullerenes, carbon nanotubes (CNTs), graphene and carbon nanofilms or fibers. They are widely available and have excellent CO₂ adsorption capacities, due to their fast adsorption kinetics, hydrophobicity, reversibility and low regeneration energy requirement[15]. Other advantages comprise their tight pore size distribution, their high specific surface area, their good chemical and physical stability, their high thermal conductivity, their low mass density and strong affinity[116, 117]. Carbon nanomaterials possess a hierarchical porous structure with both macro- and micropores. This structure feature is appropriate for CO₂ capture since the macropores create low resistance pathways, whereas micropores offer a high surface area.

CNTs have been widely investigated and their synthesis was previously reported[118-120]. Two types of carbon nanotubes available for CO₂ capture, being multi-walled (MWCNTs) and single-walled carbon nanotubes (SWCNTs). CO₂ adsorption on CNTs depends upon the fraction of the opened and unblocked nanotubes, the available

adsorption sites and the CNT oxygen content. Metal/non-metal dopants and eventual impurities further determine their adsorption performance. While more adsorption sites are provided by opened CNT bundles than by capped CNTs, the number of adsorption sites is dependent on the external surface area, the spaces in the central graphite tube, the grooves on the outer surface of a nanotube bundle, the distance between the coaxial tubes of MWCNTs, and the surface area of the outermost nanotubes. The adsorption capacity is influenced by the oxygen present in CNTs. Functional oxygen-containing groups, such as $-OH$, $-CO$, and $-COOH$ can be formed using various acids[121, 122], ozone[123-125] and plasma[126], and can be removed via heating. The thermal treatment and surface modification alter the variety of functional groups on the surface and improve the selectivity and CO_2 adsorption capacity of CNTs. Su et al. modified CNTs with a solution of 3-aminopropyl-triethoxysilane (APTS) and reported that these modified CNTs adsorbed CO_2 at $20^\circ C$, and released CO_2 at a fairly low temperature[127]. Combined thermo-chemical treatments have also been applied to improve the CNTs performance in CO_2 capture. After heating the CNTs at $300^\circ C$ for 60 min and subsequently dispersed into chemical solutions, they were proven to have a higher CO_2 adsorption capacity, even increasing with an increase in relative humidity. The dissolution of CO_2 in the adsorbed water on the CNT surface and the interaction of CO_2 and APTS forming bicarbonate in the presence of water were considered underlying facts for the high CO_2 adsorption[128]. One major drawback for potential industrial application of MWCNTs is its high cost of the purified MWCNTs. Some researchers have found that impregnating TEPA with industrial-grade MWCNTs can achieve a higher adsorption capacity up to 3.088mmol/g comparable to that of TEPA impregnated purified MWCNTs, but with a much lower cost[129].

5.3 Amine-functionalized adsorbents

Flue gas CO₂ removal using amine solutions of 20-30 wt% is the only technique commercially proven and available to date, despite drawbacks of equipment corrosion and energy consumption, as described before. Immobilization of the amines onto solid supports can significantly limit these drawbacks, and various supports including silicates, zeolites, MOFs, carbon-based materials, and others were investigated. The loading method of amine on/into these materials are similar. Silica-supported amines using amorphous silica gels produced by co-condensation of various amine-containing silanes were already reported in 1992 for CO₂ capture under dry conditions. Leal proposed amine-functionalized mesoporous silicas in 1995 when silane chemistry immobilized n-propylamine groups were grafted onto a commercial, amorphous, mesoporous silica gel. Further to these early investigations, the use of supported amines for CO₂ capture was further investigated[93, 130]. The two most common methods to synthesize the amine-functionalized adsorbents are wet amine impregnation and grafting (amines-containing covalently bound to oxide supports).

5.3.1 Wet impregnation

This technique is simple and typically consists of physically mixing silica or other porous solid supports with amines and solvents, normally water or organic solvents for an appropriate mixing time at room temperature. Amine and solvents diffuse into the sorbent pores to create active sites for adsorption, and solvents are subsequently removed by evaporation. In wet impregnation, amines diffuse into the pores of the supports and interact with the hydroxyls (silanols) on the silica surfaces by hydrogen bonds, which promote the uniform distribution of the polymer chains onto pore surfaces.

This explanation is supported by a decreasing maximum decomposition temperature of this type of adsorbents as the amine content increases[131].

Polyethyleneimine (PEI) is widely used for wet impregnation, and is commonly used a very high amine concentration (~33 wt% N). TEPA is an ultra-low-molecular-weight PEI, and its silica-impregnation was investigated by Zhu[132], who also investigated the impregnation of mixtures of TEPA and diethanolamine (DEA) into SBA-15.

The adsorbent capacity and selectivity produced by wet impregnation rely on the loading capacity of the support solids, the pore-diffusion of CO₂, temperature and impurities of flue gas. Five mesoporous silica supports impregnated with 50 wt% PEI were investigated by Son et al. (2008): the equilibrium adsorption capacities increased with increasing pore size[133]. Sayari and Zhu also reported larger loading capacities of amine on MCM-41 which possesses a larger pore volume[134, 135]. Flue gas impurities, such as NO_x and SO_x, can react with liquid amine to form stable salts, resulting in a large reduction of the adsorption capacity. A pre-treatment process is thus needed to remove water vapour, NO_x, SO_x and other impurities. The temperature of the flue gas must be cooled to between 50 and 75°C before the flue enters the adsorption vessels, since amine adsorbents can degrade at elevated temperatures and limits the CO₂ adsorption capacity of the amine-impregnated adsorbents.

5.3.2 Amine-functionalized TiO₂ nanotubes

These adsorbents were prepared through impregnating TiO₂ nanotubes (TiNT) with functional liquids to increase the sorption capacities, applying monoethanolamine (MEA), ethylenediamine (EDA), triethylenetetramine (TETA) and tetraethylenepentamine (TEPA), providing the higher amino-groups content. The

highest CO₂ adsorption of the TEPA-loaded nanotubes was ~ 4.37 mmol/g at 60 °C, but increased to 5.24 mmol/g in humid gas.

5.3.3 Amines, covalently tethered to oxide supports

Amine-functionalized CO₂ adsorbents can also be prepared when amines are covalently bound to the active linkages (such as hydroxyl, alkyl-silyl) of the porous solid supports, less prone to leach during CO₂ capture than amine-impregnated porous solids, unless the covalent amine/solid support bonds are disrupted. These adsorbents can be fully regenerated by TSA and have a long life-time.

Their adsorption capacities depend on the number of active groups on the surface of the adsorbents, and this as the function of the temperature and pressure of the adsorption. Capacities vary from 0.089 to 0.22 g CO₂/g adsorbent when the pressure (0.05–1 bar CO₂) and temperature (25–75°C) change[93]. The CO₂ partial pressure is of less importance than for activated carbons and zeolites. Amine-tethered adsorbents are applicable in mildly humid environments and at low CO₂ pressure, as confirmed by Yue et al. when demonstrating that a small amount of water increased the adsorption efficiency by providing a bicarbonate formation pathway[135]. The adsorption yield of TEPA and DEA impregnated SBA-15's increased by 20% under humid conditions. An equal molar ratio of CO₂ and H₂O is believed to be the optimum for CO₂ adsorption, at a temperature of 50 to 75°C, hence requiring a flue gas cooling prior to the adsorption column. Impurities such as H₂S, NO_x and SO_x will strongly compete with amine through their irreversible adsorption onto the silane groups or other active sites of the oxide carrier. TSA is commonly used for adsorbent regeneration, although the adsorption capacity decreases by 4 to 9% after the first adsorption/desorption cycle even though the flue gas has been pre-treated very well[93].

5.4 Metal Organic Frameworks (MOFs)

MOFs, also referred to as coordination polymers, are considered potential adsorbents or membrane separation materials for CO₂ abatement due to excellent properties of very high and accessible porosities (up to 6000 m³/g), high surface areas, very low densities, high tenability of pore functional groups, and dynamic and reversible structural characteristics. The volume and mass capacity of MOFs can be as high as 390 cm³ (STP)/cm³ and 40 mmol/g at 31°C and 50bar[136]. Yaghi et al. reported that MOFs with an ultra-high porosity possess the mass capacity of 54.5 mmol/g[137]. The CO₂ adsorption by MOFs is preferably at ambient temperature (25⁰C) and high CO₂ partial pressure. In fact, the adsorption capacity is poor compared with zeolites and activated carbon when the CO₂ partial pressure is low (0.1-0.2 bar)[138].

MOFs can be synthesized as crystalline porous materials through solution reaction under ambient condition[139]. Many transition metals (Cu, Zn, Ni, Al, Gr and Mn) have been incorporated in MOFs to improve the framework rigidity or flexibility. Rigid MOFs are stable and have robust frameworks with permanent porosity, similar to zeolites. Flexible MOFs contain dynamic and “soft” frameworks, thus facilitating their response to pressure, temperature, and guest molecules. They are a promising material for P/T-dependent molecular sieving. Structures and properties of flexible MOFs can be designed and fine-tuned through a rigorous choice of the building blocks before synthesis, and by tailoring in post-synthetic modifications[140]. Yaghi et al. demonstrated that MOFs pore spaces and stability can be tailored by applying dicarboxylate ligands within a substantial range[141]. In CO₂ capture, water vapour and other flue gas impurities can, however, displace framework ligands thus generating defects in the crystal lattice, thereby leading to the MOFs degradation even in the first

adsorption cycle. For using MOFs as adsorbents, impurities and water have to be removed before the capture stage. The water resistance (hydrophobicity) of MOFs can be improved through modification, as demonstrated by Cohen et al. when grafting long-chain alkyl groups onto IRMOF-3[140]. Li et al. reported how vapor amine-modified MOFs resists water while achieving a CO₂ adsorption capacity of 2.45 mmol/g at 25 °C and 1 bar. It also shows a good selectivity as CH₄ capacity was only 2.68×10^{-5} mmol/g. Xian et al. synthesized PEI-impregnated UiO-66 with the CO₂ adsorption capacity of 2.41mmol/g under the wet conditions[142]. Su et al. found that the CO₂ adsorption capacity of amino-Mg-MOF-74 has reached to 5.68 mmol/g at 25°C[143]. The water-resistance of MOF can be improved by loading amine as the amine layer protects the MOF structure from adsorbing water.

A “gate” phenomenon with an increased adsorption at low pressure and saturation at a higher pressure in several flexible MOFs was reported upon[144, 145]. Maji et al. illustrated this “gate” effect when capturing CO₂ through Cu(pyrdc)(bpp) (pyrdc=pyridine-2,3-dicarboxylate, bpp=1,3-bis(4-pyridyl)propane)[146]. The desorption and adsorption isotherms were considerably different. To understand this difference, Maji et al. analysed the MOF crystal structure after CO₂ inclusion: CO₂ molecules formed a C–H···O (2.46–2.59Å) H-bond with the pore walls, thus creating a sorption driving force within a strong confinement in the framework. The same "gate effect" was recently observed in (Cu(4,4'-bipy)(H₂O)₂(BF₄)₂)(4,4'-bipy) (4,4'-bipy = 4,4'-bipyridine)[147], and Zn(Gly-Ala)₂[148]. Further experiments and molecular simulations indicated that these unusual phenomena were the result of both torsion and displacement of peptide linkers, and a modified pore conformation. The resulting flexibility smoothly increased the effective pore volume with an increased CO₂ loading.

Table 1. Properties of MOF adsorbents

Adsorbents	BET-surface area (m ² /g)	Capacity (mmol/g)	T/°C	P/bar
Mg-MOF-74[138]	1495	8.48	25	1
Co-MOF-74[138]	957	7.55	25	1
Ni-MOF-74[138]	936	7.15	25	1
SIFSIX-2-Cu-i[149]	735	5.41	25	1

ZIFs, which has the imidazole as the building unit and M-Im-M as linkages, have been investigated as analogous to MOF due to their identical topology. ZIFs have the advantages of both MOF and zeolites, and have a greater potential than MOFs in CCS as they possess zeolite-like structure, higher thermal and chemical stability, and better water resistance[150, 151]. Although the CO₂ capacity of MOFs is much higher than ZIFs, the ZIFs have a better CO₂ selectivity over water. Xian et al. found that the adsorption capacity of PEI impregnated ZIF-8 would be 1.99 mmol/g and CO₂/N₂ selectivity reaches 89.3 at 55% relative humidity[152].

5.5 Alkali metal promoted oxides

Recently, alkali oxides and hydroxides attracted and increasing attention for CO₂ capture at a high temperature[11]. These chemical adsorbents have high theoretical capacities, while the reaction kinetics is slow and regenerability is relatively low as the regeneration of these materials needs decarbonisation at high temperature. CO₂ reaction and regeneration temperatures for widely available calcium and magnesium oxides/hydroxides were recently assessed using an AHP/TOPSIS multi-criteria method[11]. Although their theoretical adsorption capacities are relatively high (e.g. 24.8 mmol CO₂/g MgO), the actual uptake of CO₂ by MgO is significantly lower due to slow kinetics and pore size reduction by the high molecular volume carbonates that

are formed[11, 153]. Xiao et al. used mixed MgCO_3 and K_2CO_3 with different Mg/K ratio to absorb CO_2 at a temperature between 300 and 400°C: the CO_2 adsorption capacities were 1.65 wt% at 300 °C, 8.47 and 8.55 wt% at 350 and 375 °C, and 0.63 wt% at 400 °C at a CO_2 partial pressure of nearly 1 bar[154]. Among different lithium-based ceramics, $\text{Li}_{2-x}\text{Na}_x\text{ZrO}_3$, Li_4SiO_4 , Li_4TiO_4 , $\text{Li}_{2+x}\text{CuO}_{2+x/2}$, and Li_5AlO_4 , Wang et al. demonstrated that Li_4SiO_4 was most suitable for its high sorption capacity, multi-cycle durability, fast rates of sorption/desorption and its mechanical strength[155]. Hatton et al. reported that coating alkali metal nitrates with MgO particles can promote the CO_2 adsorption capacity to 10.2 mmol/g at moderate temperature (about 300°C) under ambient pressure[156]. The molten alkali metal nitrates prevent the formation of a rigid, CO_2 -impermeable, unidentate carbonate layer on the surfaces of MgO particles, thus allowing a high rate of CO_2 sorption.

5.6 Summary of adsorbents

In summary, many adsorbents can be used for CO_2 capture. The selection of adsorbents should consider their production cost, adsorption capacity, selectivity, rate of adsorption and desorption, required adsorption and desorption temperatures, thermal and mechanical stability, regeneration and resistance to degradation due to the impurities in the flue gas. Zeolites, MOFs and ZIFs have tunable pore size, large surface area and high porosity, therefore high CO_2 adsorption capacity, but the cost for preparation of these adsorbents is high, and their tolerance to the impurities in flue gas, particularly moisture, is low. Removal of water vapor and other impurities pre- CO_2 capture process is essential in the use of these adsorbents. Amine-functionalized TiO_2 nanotubes and carbon nanotubes have lower adsorption capacity in comparison with MOFs etc., but their tolerance to water moisture is better. Theoretically, wet

impregnation of porous particles with amines can combine the advantages of solvents (the high portion of adsorption sites) and porous adsorbents (large specific surface area), the adsorption capacity of amine impregnated adsorbents should be high and the production cost is relatively low. However, the challenge in wet impregnation processes is how to distribute liquid amine uniformly onto pore surfaces without blocking the pores, and how to improve the stability of liquid amines on the pore surfaces. Table 2 presents a summary of the major advantages and disadvantages of each adsorbent for CO₂ capture.

Table 2 Summary of advantages, disadvantages and improvements of major solid adsorbents

Adsorbents	Advantages	Disadvantages	Improvement
Zeolites	Uniform pore size; high porosity; high adsorption capacity, high thermal/photo stability	Strong water absorption and low gas selectivity; low acid/alkali resistance	Surface modification with amines; improve selectivity and tolerance to the impurities in flue gas
Porous carbon[151, 157, 158] (e.g. activated carbon, carbon nanotubes and nanofibers)	Various precursors; low cost; high specific surface area; light weight; high acid/alkali resistance; high thermal stability	Not suitable for low CO ₂ concentration; strong water absorption and low gas selectivity	Increase the basicity of carbon materials and tolerance to the impurities in the flue gas; surface modification
Amine-functionalized adsorbents[150]	Applicable at low CO ₂ pressure; high CO ₂ selectivity, relatively high CO ₂ adsorption capacity; good regeneration ability	Amine degradation at high temperature; low thermal stability; dependent on solid supports	Improve thermal stability, Optimization of pore volume, size, multi-layered structure, etc.
MOFs[151]	Large specific surface area; adjustable pore size and surface	Complex synthesis; high cost; low adsorption capacity under low pressure;	Removal of the flue gas impurities and water; increase the

	property; high capacity	instability under acid or alkali condition;	hydrophobicity; amino modification;
Alkali-metal based oxides[159]	Applicable under a wide temperature range (20-700 ⁰ C); wide availability; low cost (for MgO and CaO)	High cost (e.g. Li ₄ SiO ₄ and Li ₂ ZrO ₃); low cyclic stability; relatively low adsorption capacity (for MgO and hydrotalcite-like based adsorbents);	Add inert materials to improve the cyclic stability; nanosized CaO adsorbents; pre-removal of the flue gas impurities and water

6. Membrane Separation

The application of membranes in CO₂ abatement is a relatively novel approach, with the membrane gas separation and the membrane contactor proposed. Membranes form semi-permeable barriers to separate compounds through various effects of diffusion, solution, adsorption, molecular sieve action and ionic transport[18]. Some gas molecules permeate the selective membrane more readily than others. A membrane contactor combines the membrane (acting as a gas/liquid interface) and adsorption.

Membranes are the key elements for both two processes to ensure feasibility and compatibility. Based on the materials applied, the membrane can be of different nature and includes organic (polymeric), inorganic (carbon, zeolites, ceramics) and mixed matrix membranes. Each membrane has its advantages and disadvantages in terms of lifetime, operational and material cost, and CO₂ capture performance. The membrane performance is measured by its permeability and selectivity, themselves a function of mostly membrane nature, and applied conditions of temperature, pressure and concentration of the target compound. Permeability defines the permeation of a specific volumetric flow rate of a gas species per unit membrane surface area. Selectivity quantifies the relative preference of the membrane to permeate one gas species over another[39, 160]. In recent years, permeance (gas flux) rather than permeability has

been more emphasized as it is more desirable for a membrane can achieve an increased the gas flux through the membrane without losing the selectivity[161].

The common polymer materials include mostly cellulose acetate (CA), polysulfone (PSf), polyethersulfone (PES), and polyimide (PI). Polyimides possess the best performance and are applied for membrane CO₂ separation, for their good thermo-mechanical and chemical stabilities, and varying CO₂ permeability[162]. An enhanced selectivity of polymeric membranes requires an increased solubility of CO₂ in the membrane material through both changing the polymer composition and increasing the CO₂ diffusion by modifying the polymer packing within the membrane. Combining these modifications extended the range of polymeric membranes with fair permeability and selectivity towards an effective CO₂ separation[41].

In comparison with polymer membranes, inorganic membranes have a higher selectivity, a lower CO₂ permeability, but superior chemical and thermal stability. Both porous and non-porous inorganic membranes are available. The non-porous membranes offer high selectivity for gas molecules. Porous membranes are of twin-layer composition, with a porous thin membrane layer cast on a porous support with good mechanical strength, usually of metallic or ceramic nature. The difficulty to mass produce uniform and defect-free inorganic membranes with large surface areas, makes their production more expensive. Porous inorganic materials are mostly alumina, carbon, silica or glass, SiC, titania, and zeolites[41]. For example, SAPO-34 (a silico aluminophosphate zeolite) membranes have shown a good CO₂ selectivity and good CO₂ adsorption capacity. Fan et al. utilized SAPO-34 zeolite membrane combined with a non-thermal plasma reactor, and this hybrid system gives a satisfactory CO₂ efficiency (91.8%) with excellent stability according to the 40h longevity test[163].

Mixed matrix membranes also apply to add inorganic porous micro- or nanoparticles (discrete phase) into a polymer matrix (continuous phase). Adding these inorganic particles into the polymeric membrane increase the physical, thermal, and mechanical properties, while moreover increasing their hydrophobicity. Such mixed matrix membranes are expensive, brittle, and not yet commercially available.

Membrane separation for CO₂ capture is simple and does not involve chemicals or regeneration. Capital costs are moderate. Among these membrane materials mentioned above, polymeric and its hybrid membranes are the most intensively investigated as they have relatively high separation selectively, good membrane process ability and low cost[164]. However, most membrane applications are still under development. Efficient membrane separation moreover needs a much higher initial pressure, with 20% or higher CO₂ concentrations, hence questionable when considering the low partial CO₂ pressure in post-combustion flue gas (4% CO₂ concentration) is the main challenge, where multistage membrane systems could offer a solution. When comparing membrane separation and basic amine absorption, Bounaceur et al. showed that the energy consumption of a membrane separation significantly exceeds that of a basic amine system for CO₂ streams containing 10% or less CO₂[165]. Also, the commercial membranes cannot be applied at high temperature, thus necessitating compression and cooling steps.

7. Conclusions, opportunities and Challenges

Over the past decades, considerable progress has been made and the different technologies dealt with in this review show promising for CO₂ mitigation, each with specific operational conditions, advantages and drawbacks. Major challenges remain before the industrial application can take place. Several research groups, including

EPRI (Palo Alto, USA) confirmed that absorption is the most mature post-combustion capture process: among the assessment of post-combustion CCS, 57% apply absorption, 14% rely on adsorption, 8% use membranes, and 21% apply mineralization or bio-fixation. This conclusion was in-line with expectations, since absorption gas separation has been largely applied in the various petro-chemical industries. All other systems need further development prior to large scale application. Membrane separation does not involve any use of chemicals, temperature swing or pressure swing for regeneration. It shows a high potential to become an environmental-friendly and sustainable technology for CO₂ capture. Pilot-scale experiments of CO₂ capture has demonstrated its long-period stable performance. Further development to reduce the operational cost, to optimize the selectivity, permeability and antifouling, and to improve membrane life-time will promote its application to an industrial scale.

The high-energy penalty (about 29-52%) towards the use in a power plant is significant and detrimental to operate the CCS processes[40, 166]. The reduction of the energy penalty is of paramount importance with heat pinch, process integration and improvements, and/or developing adsorbents with a higher CO₂ capacity and low heat capacity as major research targets, albeit still at an initial stage of research. It is urgent to reassess every aspect of CO₂ capture processes to significantly reduce the energy penalty and achieve an energy-acceptable level for large-scale application.

A 90% capture of CO₂ from the flue gas by amine absorption will consume about 30% of the power generated by the power plant, at a cost of 40 to 100\$ per ton of CO₂ captured [167]. Besides the high-energy penalty, corrosion and solvent degradations are other major problems in absorption processes. Amines are very corrosive to equipment such as the reboiler, heat exchangers, pipes and the column[23, 168]. Development of next generation solvents with low regeneration temperature will

significantly reduce their corrosion and degradation, therefore the operational cost. The solvent with low regeneration temperature will also benefit to the use of industrial waste heat.

Among the range of CCS systems, it appears that adsorption has a high potential towards future application. Adsorptive capture of CO₂ by PSA has been studied in most detail, although most of the experimental work used a synthetic mixture of CO₂ and N₂. Since flue gas contains significant amounts of water vapour, SO_x and NO_x, these impurities must be taken into consideration for their strong chemisorption on adsorbents, hence permanently reducing the adsorption capacity. Further investigations of the effects of impurities in adsorption processes and of the physico-chemical properties of the adsorbents are required prior to promoting their full-scale use as CCS. The degradation of adsorbents caused by the presence of impurities also requires further investigation. For current use, a pre-treatment of flue gas for impurities removal is necessary for full use of the now available ad- and ab-sorbents. The additional equipment required and the increased capital and operating costs need to be examined for the large-scale CCS application. Research on systems that effectively and simultaneously abates NO_x, SO_x, and CO₂ is needed, since it would partly avoid the costs of the otherwise required pre-treatment stage in CCS systems. The development of novel absorbents or adsorbents is required.

Fixed bed and circulating fluidized bed are the common configurations used for post-combustion CO₂ capture. The column size of these two configurations is large and more suitable for CO₂ capture from large emission points, such as power plants. CO₂ emission from many industrial sectors, such as chemical refineries and iron/steel plants are from a number of small, low concentration sources with a wide range of flue gas compositions and impurity profiles. If a centralized CCS plant is applied, a large piping

network and compression power will be required (e.g., based on the INEOS Grangemouth refinery near Edinburgh[169]). It is necessary to develop compact and flexible capture units to deal with these small industrial emission, with low operating and capital costs and high efficiency able to use waste heat from different process units. Available techniques rely on small-scale experimental units, and their upscaling and integration have been seldom investigated, despite the expected operational issues and cost increases[6]. A 500 MW fossil fuel fired power plant emits about 8000 ton/day of CO₂, present in multi-million m³ of flue gas, and such quantities and volumes present major challenges towards CCS design. Retrofitting will involve major modifications of the applied equipment, but the scale-up to the large quantities of flue gas and CO₂ from burning fossil fuels remains a huge challenge!

Acknowledgments

Authors gratefully acknowledge the UK-India Education and Research Initiative and Engineering and Physical Sciences Research Council (EPSRC) of the UK [grant number EP/N024672/1]. We also thank the Royal Society of Chemistry, ELSEVIER and the owners of Figures 5 and 7-10 for their permissions to use the diagrams.

References

1. Hester, R.E. and R.M. Harrison, *Carbon capture: sequestration and storage*. Vol. 29. 2010: Royal Society of Chemistry.
2. Cheung, O., et al., *Adsorption kinetics for CO₂ on highly selective zeolites NaKA and nano-NaKA*. *Applied Energy*, 2013. **112**: p. 1326-1336.10.1016/j.apenergy.2013.01.017
3. *2030 climate & energy framework*. https://ec.europa.eu/clima/policies/strategies/2030_en
4. *2050 long-term strategy*. 2018, https://ec.europa.eu/clima/policies/strategies/2050_en#tab-0-0
5. *The Climate Change Act 2008 (2050 Target Amendment)* www.legislation.gov.uk/uksi/2019/1056/contents/made

6. Blomen, E., C. Hendriks, and F. Neele, *Capture technologies: Improvements and Promising Developments*. Greenhouse Gas Control Technologies 9, 2009. **1**(1): p. 1505-1512.10.1016/j.egypro.2009.01.197
7. Newell, P. and A.G. Ilgen, *Overview of Geological Carbon Storage (GCS)*, in *Science of Carbon Storage in Deep Saline Formations*. 2019, Elsevier. p. 1-13.
8. Jia, B., J.S. Tsau, and R. Barati, *A review of the current progress of CO₂ injection EOR and carbon storage in shale oil reservoirs*. Fuel, 2019. **236**: p. 404-427.10.1016/j.fuel.2018.08.103
9. Bachu, S., *Review of CO₂ storage efficiency in deep saline aquifers*. International Journal of Greenhouse Gas Control, 2015. **40**: p. 188-202.10.1016/j.ijggc.2015.01.007
10. Rubin, E.S., C. Chen, and A.B. Rao, *Cost and performance of fossil fuel power plants with CO₂ capture and storage*. Energy Policy, 2007. **35**(9): p. 4444-4454.10.1016/j.enpol.2007.03.009
11. Liu, J., et al., *The chemical CO₂ capture by carbonation-decarbonation cycles*. J Environ Manage, 2020. **260**: p. 110054.10.1016/j.jenvman.2019.110054
12. Toftgaard, M.B., et al., *Oxy-fuel combustion of solid fuels*. Progress in Energy and Combustion Science, 2010. **36**(5): p. 581-625.10.1016/j.pecs.2010.02.001
13. Scheffknecht, G., et al., *Oxy-fuel coal combustion—A review of the current state-of-the-art*. J International Journal of Greenhouse Gas Control, 2011. **5**: p. S16-S35.10.1016/j.ijggc.2011.05.020
14. Samanta, A., et al., *Post-Combustion CO₂ Capture Using Solid Sorbents: A Review*. Industrial & Engineering Chemistry Research, 2012. **51**(4): p. 1438-1463.10.1021/ie200686q
15. Creamer, A.E. and B. Gao, *Carbon-based adsorbents for postcombustion CO₂ capture: a critical review*. J Environmental science technology, 2016. **50**(14): p. 7276-7289.10.1021/acs.est.6b00627
16. Tlili, N., G. Grévillet, and C. Vallières, *Carbon dioxide capture and recovery by means of TSA and/or VSA*. J International Journal of Greenhouse Gas Control, 2009. **3**(5): p. 519-527.10.1016/j.ijggc.2009.04.005
17. Zhao, B.T., et al., *Post-combustion CO₂ capture by aqueous ammonia: A state-of-the-art review*. International Journal of Greenhouse Gas Control, 2012. **9**: p. 355-371.10.1016/j.ijggc.2012.05.006
18. Mondal, M.K., H.K. Balsora, and P. Varshney, *Progress and trends in CO₂ capture/separation technologies: A review*. Energy, 2012. **46**(1): p. 431-441.10.1016/j.energy.2012.08.006
19. Ho, S., et al., *Perspectives on microalgal CO₂-emission mitigation systems—a review*. Biotechnology advances, 2011. **29**(2): p. 189-198.10.1016/j.biotechadv.2010.11.001
20. RA, G., et al., *Nonlinear grassland responses to past and future atmospheric CO₂*. Nature, 2002. **417**: p. 279-282.10.1038/417279a
21. Kuramochi, T., et al., *Comparative assessment of CO₂ capture technologies for carbon-intensive industrial processes*. Progress in Energy and Combustion Science, 2012. **38**(1): p. 87-112.10.1016/j.pecs.2011.05.001
22. Pirngruber, G.D., et al., *A theoretical analysis of the energy consumption of post-combustion CO₂ capture processes by temperature swing adsorption using solid sorbents*. International Journal of Greenhouse Gas Control, 2013. **14**: p. 74-83.10.1016/j.ijggc.2013.01.010
23. Clause, M., J. Merel, and F. Meunier, *Numerical parametric study on CO₂ capture by indirect thermal swing adsorption*. International Journal of Greenhouse Gas Control, 2011. **5**(5): p. 1206-1213.10.1016/j.ijggc.2011.05.036

24. Ishibashi, M., et al., *Technology for removing carbon dioxide from power plant flue gas by the physical adsorption method*. Energy Conversion and Management, 1996. **37**(6-8): p. 929-933. Doi 10.1016/0196-8904(95)00279-0
25. Gomes, V.G. and K.W.K. Yee, *Pressure swing adsorption for carbon dioxide sequestration from exhaust gases*. Separation and Purification Technology, 2002. **28**(2): p. 161-171. 10.1016/S1383-5866(02)00064-3
26. Ko, D., R. Siriwardane, and L.T. Biegler, *Optimization of pressure swing adsorption and fractionated vacuum pressure swing adsorption processes for CO₂ capture*. Industrial & Engineering Chemistry Research, 2005. **44**(21): p. 8084-8094. 10.1021/ie050012z
27. Ho, M.T., G.W. Allinson, and D.E. Wiley, *Reducing the cost of CO₂ capture from flue gases using pressure swing adsorption*. Industrial & Engineering Chemistry Research, 2008. **47**(14): p. 4883-4890. 10.1021/ie070831e
28. Kikkinides, E.S., R.T. Yang, and S.H. Cho, *Concentration and recovery of carbon dioxide from flue gas by pressure swing adsorption*. J Industrial Engineering Chemistry Research, 1993. **32**(11): p. 2714-2720. <https://doi.org/10.1021/ie00023a038>
29. Zhang, J., P.A. Webley, and P. Xiao, *Effect of process parameters on power requirements of vacuum swing adsorption technology for CO₂ capture from flue gas*. Energy Conversion and Management, 2008. **49**(2): p. 346-356. 10.1016/j.enconman.2007.06.007
30. Maring, B.J. and P.A. Webley, *A new simplified pressure/vacuum swing adsorption model for rapid adsorbent screening for CO₂ capture applications*. International Journal of Greenhouse Gas Control, 2013. **15**: p. 16-31. 10.1016/j.ijggc.2013.01.009
31. Ahn, H. and C.H. Lee, *Effects of capillary condensation on adsorption and thermal desorption dynamics of water in zeolite 13X and layered beds*. Chemical Engineering Science, 2004. **59**(13): p. 2727-2743. 10.1016/j.ces.2004.04.011
32. Dong, X., et al., *Effect of water vapor from power station flue gas on CO₂ capture by vacuum swing adsorption with activated carbon*. J Journal of Fuel Chemistry Technology, 2011. **39**(3): p. 169-174. 10.1016/S1872-5813(11)60016-9
33. Plaza, M.G., et al., *Post-combustion CO₂ capture with a commercial activated carbon: Comparison of different regeneration strategies*. Chemical Engineering Journal, 2010. **163**(1-2): p. 41-47. 10.1016/j.cej.2010.07.030
34. Su, F.S. and C.Y. Lu, *CO₂ capture from gas stream by zeolite 13X using a dual-column temperature/vacuum swing adsorption*. J Energy Environmental Science, 2012. **5**(10): p. 9021-9027. 10.1016/S1872-5813(11)60016-9
35. Luo, L., et al., *Adsorption and electrothermal desorption of organic vapors using activated carbon adsorbents with novel morphologies*. Carbon, 2006. **44**(13): p. 2715-2723. 10.1016/j.carbon.2006.04.007
36. Ahn, C.K., et al., *Determination of Ammonium Salt/Ion Speciation in the CO₂ Absorption Process Using Ammonia Solution: Modeling and Experimental Approaches*. 10th International Conference on Greenhouse Gas Control Technologies, 2011. **4**: p. 541-547. 10.1016/j.egypro.2011.01.086
37. Jiang, N., et al., *CO₂ capture from dry flue gas by means of VPSA, TSA and TVSA*. Journal of CO₂ Utilization, 2020. **35**: p. 153-168. 10.1016/j.jcou.2019.09.012
38. Wang, L., et al., *CO₂ Capture from Flue Gas in an Existing Coal-Fired Power Plant by Two Successive Pilot-Scale VPSA Units*. Industrial & Engineering Chemistry Research, 2013. **52**(23): p. 7947-7955. 10.1021/ie4009716
39. Spigarelli, B.P. and S.K. Kawatra, *Opportunities and challenges in carbon dioxide capture*. Journal of CO₂ Utilization, 2013. **1**: p. 69-87. 10.1016/j.jcou.2013.03.002
40. Rubin, E. and H. De Coninck, *IPCC special report on carbon dioxide capture and storage*. J UK: Cambridge University Press. TNO : Cost Curves for CO₂ Storage, Part, 2005. **2**: p. 14, http://www.rite.or.jp/English/lab/geological/geowse/20-3-1_Rubin.pdf

41. Olajire, A.A., *CO₂ capture and separation technologies for end-of-pipe applications—a review*. *J Energy*, 2010. **35**(6): p. 2610-2628.10.1016/j.energy.2010.02.030
42. Pires, J.C.M., et al., *Recent developments on carbon capture and storage: An overview*. *Chemical Engineering Research & Design*, 2011. **89**(9): p. 1446-1460.10.1016/j.cherd.2011.01.028
43. Yu, C.H. and C.S. Tan, *Mixed Alkanolamines with Low Regeneration Energy for CO₂ Capture in a Rotating Packed Bed*. *Ghgt-11*, 2013. **37**: p. 455-460.10.1016/j.egypro.2013.05.131
44. Maceiras, R. and A. Cancela, *Measurement of the interfacial area during CO₂ capture with alkanolamines*. *Chemical Engineering Journal*, 2011. **172**(1): p. 335-340.10.1016/j.cej.2011.06.014
45. Zhang, M.K. and Y.C. Guo, *Rate based modeling of absorption and regeneration for CO₂ capture by aqueous ammonia solution*. *Applied Energy*, 2013. **111**: p. 142-152.10.1016/j.apenergy.2013.04.074
46. Kim, Y., S.R. Lim, and J.M. Park, *The effects of Cu(II) ion as an additive on NH₃ loss and CO₂ absorption in ammonia-based CO₂ capture processes*. *Chemical Engineering Journal*, 2012. **211**: p. 327-335.10.1016/j.cej.2012.09.087
47. Knuutila, H., H.F. Svendsen, and M. Anttila, *CO₂ capture from coal-fired power plants based on sodium carbonate slurry; a systems feasibility and sensitivity study*. *International Journal of Greenhouse Gas Control*, 2009. **3**(2): p. 143-151.10.1016/j.ijggc.2008.06.006
48. Nelson, T.O., et al., *The Dry Carbonate Process: Carbon dioxide recovery from power plant flue gas*. *Greenhouse Gas Control Technologies 9*, 2009. **1**(1): p. 1305-1311.10.1016/j.egypro.2009.01.171
49. Darde, V., et al., *Chilled ammonia process for CO₂ capture*. *Greenhouse Gas Control Technologies 9*, 2009. **1**(1): p. 1035-1042.10.1016/j.egypro.2009.01.137
50. Yang, H., et al., *Progress in carbon dioxide separation and capture: a review*. *J Environ Sci (China)*, 2008. **20**(1): p. 14-27.10.1016/s1001-0742(08)60002-9
51. Herzog, H. and D. Golomb, *Carbon capture and storage from fossil fuel use*. *J Encyclopedia of energy*, 2004. **1**(6562): p. 277-287.10.1016/B0-12-176480-X/00422-8
52. Kittel, J., et al., *Corrosion in MEA units for CO₂ capture: pilot plant studies*. *J Energy Procedia* 2009. **1**(1): p. 791-797.10.1016/j.egypro.2009.01.105
53. Stover, B., C. Bergins, and J. Klebes, *Optimized Post Combustion Carbon capturing on Coal fired Power Plants*. *10th International Conference on Greenhouse Gas Control Technologies*, 2011. **4**: p. 1637-1643.10.1016/j.egypro.2011.02.035
54. Ghayur, A., T.V. Verheyen, and E. Meuleman, *Biological and chemical treatment technologies for waste amines from CO₂ capture plants*. *J Environ Manage*, 2019. **241**: p. 514-524.10.1016/j.jenvman.2018.07.033
55. Tobiesen, F.A. and H.F. Svendsen, *Study of a modified amine-based regeneration unit*. *Industrial & Engineering Chemistry Research*, 2006. **45**(8): p. 2489-2496.10.1021/ie050544f
56. Abu-Zahra, M.R.M., et al., *CO₂ capture from power plants - Part II. A parametric study of the economical performance based on mono-ethanolamine*. *International Journal of Greenhouse Gas Control*, 2007. **1**(2): p. 135-142.10.1016/S1750-5836(07)00032-1
57. F, Z., et al., *Absorption of CO₂ in the aqueous solutions of functionalized ionic liquids and MDEA*. *Chemical Engineering Journal*, 2010. **160**(2): p. 691-697.10.1016/j.cej.2010.04.013
58. Barchas, R. and R. Davis, *The Kerr-Mcgee Abb Lummus Crest Technology for the Recovery of Co₂ from Stack Gases*. *Energy Conversion and Management*, 1992. **33**(5-8): p. 333-340. Doi 10.1016/0196-8904(92)90028-U

59. Parker, L. and P. Folger, *Capturing CO₂ from Coal-Fired Power Plants: Challenges for a Comprehensive Strategy*. Congressional Research Service, Washington, DC, 2010, 2010, <https://digitalcommons.unl.edu/crsdocs/61/>
60. Reddy, S., et al., *Initial results from Fluor's CO₂ capture demonstration plant using Econamine FG PlusSM technology at E. ON Kraftwerke's Wilhelmshaven Power Plant*. J Energy Procedia, 2013. **37**: p. 6216-6225.10.1016/j.egypro.2013.06.550
61. Kadono, K., et al., *New Energy Efficient Processes and Newly Developed Absorbents for Flue Gas CO₂ Capture*. Energy Procedia, 2013. **37**: p. 1785-1792.10.1016/j.egypro.2013.06.055
62. Mimura, T., et al., *Development of energy saving technology for flue gas carbon dioxide recovery in power plant by chemical absorption method and steam system*. Energy Conversion and Management, 1997. **38**: p. S57-S62.Doi 10.1016/S0196-8904(96)00246-4
63. Kishimoto, S., et al., *Current status of MHI's CO₂ recovery technology and optimization of CO₂ recovery plant with a PC fired power plant*. J Energy Procedia, 2009. **1**(1): p. 1091-1098,
64. Littel, R.J., M. Bos, and G.J. Knoop, *Dissociation-Constants of Some Alkanolamines at 293-K, 303-K, 318-K, and 333-K*. Journal of Chemical and Engineering Data, 1990. **35**(3): p. 276-277.DOI 10.1021/je00061a014
65. Barzagli, F., F. Mani, and M. Peruzzini, *A 13C NMR investigation of CO₂ absorption and desorption in aqueous 2, 2'-iminodiethanol and N-methyl-2, 2'-iminodiethanol*. J International Journal of Greenhouse Gas Control, 2011. **5**(3): p. 448-456.10.1016/j.ijggc.2010.04.006
66. Idem, R., et al., *Pilot plant studies of the CO₂ capture performance of aqueous MEA and mixed MEA/MDEA solvents at the University of Regina CO₂ capture technology development plant and the Boundary Dam CO₂ capture demonstration*. Industrial & Engineering Chemistry Research, 2006. **45**(8): p. 2414-2420.10.1021/ie050569e
67. Liu, J.Z., et al., *Absorption of carbon dioxide in aqueous ammonia*. Greenhouse Gas Control Technologies 9, 2009. **1**(1): p. 933-940.10.1016/j.egypro.2009.01.124
68. Pellegrini, G., R. Strube, and G. Manfreda, *Comparative study of chemical absorbents in postcombustion CO₂ capture*. Energy, 2010. **35**(2): p. 851-857.10.1016/j.energy.2009.08.011
69. Zhu, D.C., et al., *Semi-batch experimental study on CO₂ absorption characteristic of aqueous ammonia*. 10th International Conference on Greenhouse Gas Control Technologies, 2011. **4**: p. 156-163.10.1016/j.egypro.2011.01.036
70. Pelkie, J.E., et al., *Product distributions in the carbon dioxide-ammonia-water system from liquid conductivity measurements*. J Industrial engineering chemistry research, 1992. **31**(9): p. 2209-2215.10.1021/ie00009a018
71. Baker, R.W., *Future directions of membrane gas separation technology*. Industrial & Engineering Chemistry Research, 2002. **41**(6): p. 1393-1411.10.1021/ie0108088
72. Klaassen, R., P. Feron, and A. Jansen, *Membrane contactor applications*. Desalination, 2008. **224**(1-3): p. 81-87.10.1016/j.desal.2007.02.083
73. Lin, C.C. and B.C. Chen, *Characteristics of cross-flow rotating packed beds*. Journal of Industrial and Engineering Chemistry, 2008. **14**(3): p. 322-327.10.1016/j.jiec.2008.01.004
74. Sun, B.C., et al., *Simultaneous Absorption of CO₂ and NH₃ into Water in a Rotating Packed Bed*. Industrial & Engineering Chemistry Research, 2009. **48**(24): p. 11175-11180.10.1021/ie9001316
75. Legentilhomme, P. and J. Legrand, *The Effects of Inlet Conditions on Mass-Transfer in Annular Swirling Decaying Flow*. International Journal of Heat and Mass Transfer, 1991. **34**(4-5): p. 1281-1291.Doi 10.1016/0017-9310(91)90036-E

76. Javed, K.H., T. Mahmud, and E. Purba, *Enhancement of mass transfer in a spray tower using swirling gas flow*. Chemical Engineering Research & Design, 2006. **84**(A6): p. 465-477.10.1205/cherd.05119
77. Yeh, A.C. and H.L. Bai, *Comparison of ammonia and monoethanolamine solvents to reduce CO₂ greenhouse gas emissions*. Science of the Total Environment, 1999. **228**(2-3): p. 121-133.Doi 10.1016/S0048-9697(99)00025-X
78. Molina, C.T. and C. Bouallou, *Assessment of different methods of CO₂ capture in post-combustion using ammonia as solvent*. Journal of Cleaner Production, 2015. **103**: p. 463-468.10.1016/j.jclepro.2014.03.024
79. Zhao, C.W., et al., *Capturing CO₂ in flue gas from fossil fuel-fired power plants using dry regenerable alkali metal-based sorbent*. Progress in Energy and Combustion Science, 2013. **39**(6): p. 515-534.10.1016/j.peccs.2013.05.001
80. Lee, S.C., et al., *CO₂ absorption and regeneration of alkali metal-based solid sorbents*. Catalysis Today, 2006. **111**(3-4): p. 385-390.10.1016/j.cattod.2005.10.051
81. Bougie, F., D. Pokras, and X.F. Fan, *Novel non-aqueous MEA solutions for CO₂ capture*. International Journal of Greenhouse Gas Control, 2019. **86**: p. 34-42.10.1016/j.ijggc.2019.04.013
82. Won, W., S. Lee, and K.S. Lee, *Modeling and parameter estimation for a fixed-bed adsorption process for CO₂ capture using zeolite 13X*. Separation and Purification Technology, 2012. **85**: p. 120-129.10.1016/j.seppur.2011.09.056
83. Veneman, R., et al., *Continuous CO₂ capture in a circulating fluidized bed using supported amine sorbents*. Chemical Engineering Journal, 2012. **207**: p. 18-26.10.1016/j.ccej.2012.06.100
84. Dinca, C. and A. Badea, *The parameters optimization for a CFBC pilot plant experimental study of post-combustion CO₂ capture by reactive absorption with MEA*. International Journal of Greenhouse Gas Control, 2013. **12**: p. 269-279.10.1016/j.ijggc.2012.11.006
85. Veneman, R., et al., *CO₂ capture in a continuous gas–solid trickle flow reactor*. Chemical Engineering Journal, 2016. **289**: p. 191-202.10.1016/j.ccej.2015.12.066
86. Pirklbauer, J., et al., *Impact of stage configurations, lean-rich heat exchange and regeneration agents on the energy demand of a multistage fluidized bed TSA CO₂ capture process*. International Journal of Greenhouse Gas Control, 2018. **72**: p. 82-91.10.1016/j.ijggc.2018.03.018
87. Belmabkhout, Y., R. Serna-Guerrero, and A. Sayari, *Adsorption of CO₂ from dry gases on MCM-41 silica at ambient temperature and high pressure. 1: Pure CO₂ adsorption*. Chemical Engineering Science, 2009. **64**(17): p. 3721-3728.10.1016/j.ces.2009.03.017
88. Ma, Y.H., et al., *Synthesis of Micro/Mesoporous Composites and Their Application as CO₂ Adsorbents*. Acta Physico-Chimica Sinica, 2011. **27**(3): p. 689-696.10.3866/Pku.Whxb20110335
89. Stamires, D.N., *Properties of the Zeolite, Faujasite, Substitutional Series: A Review with New Data*. Clays and Clay Minerals, 1973. **21**(5): p. 379-389.10.1346/ccmn.1973.0210514
90. Castro, M., et al., *Silicoaluminophosphate Molecular Sieves STA-7 and STA-14 and Their Structure-Dependent Catalytic Performance in the Conversion of Methanol to Olefins*. Journal of Physical Chemistry C, 2009. **113**(35): p. 15731-15741.10.1021/jp904623a
91. Ferey, G., *Hybrid porous solids: past, present, future*. Chemical Society Reviews, 2008. **37**(1): p. 191-214.10.1039/b618320b
92. Walton, K.S., M.B. Abney, and M.D. LeVan, *CO₂ adsorption in Y and X zeolites modified by alkali metal cation exchange*. Microporous and Mesoporous Materials, 2006. **91**(1-3): p. 78-84.10.1016/j.micromeso.2005.11.023

93. Bui, T.X. and H. Choi, *Adsorptive removal of selected pharmaceuticals by mesoporous silica SBA-15*. J Hazard Mater, 2009. **168**(2-3): p. 602-8.10.1016/j.jhazmat.2009.02.072
94. Akhtar, F., et al., *Colloidal processing and CO₂ capture performance of sacrificially templated zeolite monoliths*. Applied Energy, 2012. **97**: p. 289-296.10.1016/j.apenergy.2011.12.064
95. Su, F.S., et al., *Adsorption of CO₂ on Amine-Functionalized Y-Type Zeolites*. Energy & Fuels, 2010. **24**(2): p. 1441-1448.10.1021/ef901077k
96. Davini, P., *Flue gas treatment by activated carbon obtained from oil-fired fly ash*. Carbon, 2002. **40**(11): p. 1973-1979.10.1016/S0008-6223(02)00049-0
97. Sircar, S., T.C. Golden, and M.B. Rao, *Activated carbon for gas separation and storage*. Carbon, 1996. **34**(1): p. 1-12.Doi 10.1016/0008-6223(95)00128-X
98. Balsamo, M., et al., *CO₂ adsorption onto synthetic activated carbon: Kinetic, thermodynamic and regeneration studies*. Separation and Purification Technology, 2013. **116**: p. 214-221.10.1016/j.seppur.2013.05.041
99. Wahby, A., et al., *High-surface-area carbon molecular sieves for selective CO₂ adsorption*. J ChemSusChem, 2010. **3**(8): p. 974-981.10.1002/cssc.201000083
100. Silvestre-Albero, J., et al., *Ultrahigh CO₂ adsorption capacity on carbon molecular sieves at room temperature*. Chemical Communications, 2011. **47**(24): p. 6840-6842.10.1039/c1cc11618e
101. Laszlo, K. and A. Szucs, *Surface characterization of polyethyleneterephthalate (PET) based activated carbon and the effect of pH on its adsorption capacity from aqueous phenol and 2,3,4-trichlorophenol solutions*. Carbon, 2001. **39**(13): p. 1945-1953.Doi 10.1016/S0008-6223(01)00005-7
102. El-Sayed, Y. and T.J. Bandosz, *Adsorption of valeric acid from aqueous solution onto activated carbons: role of surface basic sites*. J Colloid Interface Sci, 2004. **273**(1): p. 64-72.10.1016/j.jcis.2003.10.006
103. Ania, C.O., J.B. Parra, and J.J. Pis, *Oxygen-induced decrease in the equilibrium adsorptive capacities of activated carbons*. Adsorption Science & Technology, 2004. **22**(4): p. 337-351.Doi 10.1260/0263617041514875
104. Shafeeyan, M.S., et al., *A review on surface modification of activated carbon for carbon dioxide adsorption*. Journal of Analytical and Applied Pyrolysis, 2010. **89**(2): p. 143-151.10.1016/j.jaap.2010.07.006
105. El-Sayed, Y. and T.J. Bandosz, *Acetaldehyde adsorption on nitrogen-containing activated carbons*. Langmuir, 2002. **18**(8): p. 3213-3218.10.1021/la0116948
106. Montes-Moran, M.A., et al., *On the nature of basic sites on carbon surfaces: An overview*. Carbon, 2004. **42**(7): p. 1219-1225.10.1016/j.carbon.2004.01.023
107. Pereira, M.F.R., et al., *Adsorption of dyes on activated carbons: influence of surface chemical groups*. Carbon, 2003. **41**(4): p. 811-821.10.1016/S0008-6223(02)00406-2
108. Zielke, U., K. Hüttinger, and W. Hoffman, *Surface-oxidized carbon fibers: I. Surface structure and chemistry*. Carbon, 1996. **34**(8): p. 983-998.10.1016/0008-6223(96)00032-2
109. Figueiredo, J.L., et al., *Modification of the surface chemistry of activated carbons*. Carbon, 1999. **37**(9): p. 1379-1389.Doi 10.1016/S0008-6223(98)00333-9
110. Menendez, J.A., et al., *On the Difference between the Isoelectric Point and the Point of Zero Charge of Carbons*. Carbon, 1995. **33**(11): p. 1655-1657.10.1016/0008-6223(95)96817-R
111. Biniak, S., et al., *The characterization of activated carbons with oxygen and nitrogen surface groups*. Carbon, 1997. **35**(12): p. 1799-1810.Doi 10.1016/S0008-6223(97)00096-1

112. Abe, M., et al., *Amination of activated carbon and adsorption characteristics of its aminated surface*. Langmuir, 2000. **16**(11): p. 5059-5063. DOI 10.1021/la990976t
113. Mangun, C.L., et al., *Surface chemistry, pore sizes and adsorption properties of activated carbon fibers and precursors treated with ammonia*. Carbon, 2001. **39**(12): p. 1809-1820. Doi 10.1016/S0008-6223(00)00319-5
114. Bota, K.B. and G.M.K. Abotsi, *Ammonia - a Reactive Medium for Catalyzed Coal-Gasification*. Fuel, 1994. **73**(8): p. 1354-1357. Doi 10.1016/0016-2361(94)90313-1
115. Zhang, X., D. Lin, and W. Chen, *Nitrogen-doped porous carbon prepared from a liquid carbon precursor for CO₂ adsorption*. RSC advances, 2015. **5**(56): p. 45136-45143. 10.1039/C5RA08014B
116. Burchell, T.D. and R.R. Judkins, *Passive CO₂ removal using a carbon fiber - Composite molecular sieve*. Energy Conversion and Management, 1996. **37**(6-8): p. 947-954. Doi 10.1016/0196-8904(95)00282-0
117. An, H., B. Feng, and S. Su, *CO₂ capture by electrothermal swing adsorption with activated carbon fibre materials*. International Journal of Greenhouse Gas Control, 2011. **5**(1): p. 16-25. 10.1016/j.ijggc.2010.03.007
118. See, C.H. and A.T. Harris, *A review of carbon nanotube synthesis via fluidized-bed chemical vapor deposition*. J Industrial engineering chemistry research, 2007. **46**(4): p. 997-1012. 10.1021/ie060955b
119. Zhang, Q., et al., *The road for nanomaterials industry: a review of carbon nanotube production, post-treatment, and bulk applications for composites and energy storage*. Small, 2013. **9**(8): p. 1237-1265. 10.1002/smll.201203252
120. Yan, Y.B., et al., *Carbon nanotube catalysts: recent advances in synthesis, characterization and applications*. J Chemical Society Reviews, 2015. **44**(10): p. 3295-3346. 10.1039/C4CS00492B
121. Liu, J., et al., *Fullerene pipes*. Science, 1998. **280**(5367): p. 1253-1256. DOI 10.1126/science.280.5367.1253
122. Toebes, M.L., et al., *The influence of oxidation on the texture and the number of oxygen-containing surface groups of carbon nanofibers*. Carbon, 2004. **42**(2): p. 307-315. 10.1016/j.carbon.2003.10.036
123. Sham, M.L. and J.K. Kim, *Surface functionalities of multi-wall carbon nanotubes after UV/Ozone and TETA treatments*. Carbon, 2006. **44**(4): p. 768-777. 10.1016/j.carbon.2005.09.013
124. Byl, O., J. Liu, and J.T. Yates, Jr., *Etching of carbon nanotubes by ozone--a surface area study*. Langmuir, 2005. **21**(9): p. 4200-4. 10.1021/la040132w
125. Liu, L.V., W.Q. Tian, and Y.A. Wang, *Ozonization at the vacancy defect site of the single-walled carbon nanotube*. Journal of Physical Chemistry B, 2006. **110**(26): p. 13037-13044. 10.1021/jp055999x
126. Chen, C.L., et al., *Oxygen Functionalization of Multiwall Carbon Nanotubes by Microwave-Excited Surface-Wave Plasma Treatment*. Journal of Physical Chemistry C, 2009. **113**(18): p. 7659-7665. 10.1021/jp9012015
127. Su, F., et al., *Capture of CO₂ from flue gas via multiwalled carbon nanotubes*. Sci Total Environ, 2009. **407**(8): p. 3017-23. 10.1016/j.scitotenv.2009.01.007
128. Lu, C., et al., *Capture of carbon dioxide by modified multiwalled carbon nanotubes*, in *Environanotechnology*. 2010, Elsevier. p. 55-69. 10.1016/B978-0-08-054820-3.00004-6
129. Liu, Q., et al., *Amine-functionalized low-cost industrial grade multi-walled carbon nanotubes for the capture of carbon dioxide*. Journal of Energy Chemistry, 2014. **23**(1): p. 111-118. 10.1016/S2095-4956(14)60124-8

130. Sayari, A., Y. Belmabkhout, and R. Serna-Guerrero, *Flue gas treatment via CO₂ adsorption*. Chemical Engineering Journal, 2011. **171**(3): p. 760-774.10.1016/j.cej.2011.02.007
131. Martin, C.F., et al., *Wet impregnation of a commercial low cost silica using DETA for a fast post-combustion CO₂ capture process*. Applied Energy, 2016. **183**: p. 1705-1721.10.1016/j.apenergy.2016.09.081
132. Yue, M.B., et al., *CO₂ capture by as-prepared SBA-15 with an occluded organic template*. J Advanced Functional Materials, 2006. **16**(13): p. 1717-1722.10.1002/adfm.200600427
133. Son, W.J., J.S. Choi, and W.S. Ahn, *Adsorptive removal of carbon dioxide using polyethyleneimine-loaded mesoporous silica materials*. Microporous and Mesoporous Materials, 2008. **113**(1-3): p. 31-40.10.1016/j.micromeso.2007.10.049
134. Franchi, R.S., P.J.E. Harlick, and A. Sayari, *Applications of pore-expanded mesoporous silica. 2. Development of a high-capacity, water-tolerant adsorbent for CO₂*. Industrial & Engineering Chemistry Research, 2005. **44**(21): p. 8007-8013.10.1021/ie0504194
135. Yue, M.B., et al., *Efficient CO₂ capturer derived from as-synthesized MCM-41 modified with amine*. Chemistry, 2008. **14**(11): p. 3442-51.10.1002/chem.200701467
136. Llewellyn, P.L., et al., *High uptakes of CO₂ and CH₄ in mesoporous metal-organic frameworks MIL-100 and MIL-101*. Langmuir, 2008. **24**(14): p. 7245-50.10.1021/la800227x
137. Furukawa, H., et al., *Ultrahigh porosity in metal-organic frameworks*. Science, 2010. **329**(5990): p. 424-8.10.1126/science.1192160
138. Dasgupta, S., et al., *CO₂ recovery from mixtures with nitrogen in a vacuum swing adsorber using metal organic framework adsorbent: A comparative study*. International Journal of Greenhouse Gas Control, 2012. **7**: p. 225-229.10.1016/j.ijggc.2011.10.007
139. Klinowski, J., et al., *Microwave-assisted synthesis of metal-organic frameworks*. J Dalton Transactions, 2011. **40**(2): p. 321-330.10.1039/C0DT00708K
140. Wang, Z.Q. and S.M. Cohen, *Postsynthetic modification of metal-organic frameworks*. J Chemical Society Reviews, 2009. **38**(5): p. 1315-1329.10.1039/B802258P
141. Eddaoudi, M., et al., *Systematic design of pore size and functionality in isorecticular MOFs and their application in methane storage*. Science, 2002. **295**(5554): p. 469-472.DOI 10.1126/science.1067208
142. Xian, S.K., et al., *Enhanced Dynamic CO₂ Adsorption Capacity and CO₂/CH₄ Selectivity on Polyethylenimine-Impregnated UiO-66*. Industrial & Engineering Chemistry Research, 2015. **54**(44): p. 11151-11158.10.1021/acs.iecr.5b03517
143. Su, X., et al., *Postsynthetic Functionalization of Mg-MOF-74 with Tetraethylenepentamine: Structural Characterization and Enhanced CO₂ Adsorption*. ACS Appl Mater Interfaces, 2017. **9**(12): p. 11299-11306.10.1021/acsami.7b02471
144. Mulfort, K.L., et al., *An Interpenetrated Framework Material with Hysteretic CO₂ Uptake*. Chemistry-a European Journal, 2010. **16**(1): p. 276-281.10.1002/chem.200902104
145. Ma, S., et al., *Preparation and gas adsorption studies of three mesh-adjustable molecular sieves with a common structure*. J Am Chem Soc, 2009. **131**(18): p. 6445-51.10.1021/ja808896f
146. Yoo, B. and K. Kirshenbaum, *Protease-mediated ligation of abiotic oligomers*. J Am Chem Soc, 2005. **127**(49): p. 17132-3.10.1021/ja055105m
147. Cheng, Y., et al., *Reversible structural change of Cu-MOF on exposure to water and its CO₂ adsorptivity*. Langmuir, 2009. **25**(8): p. 4510-3.10.1021/la803818p
148. Rabone, J., et al., *An adaptable peptide-based porous material*. Science, 2010. **329**(5995): p. 1053-7.10.1126/science.1190672

149. Nugent, P., et al., *Porous materials with optimal adsorption thermodynamics and kinetics for CO₂ separation*. *Nature*, 2013. **495**(7439): p. 80-84.10.1038/nature11893
150. Hu, X.Y., et al., *A review of N-functionalized solid adsorbents for post-combustion CO₂ capture*. *Applied Energy*, 2020. **260**: p. 114244.10.1016/j.apenergy.2019.114244
151. Modak, A. and S. Jana, *Advancement in porous adsorbents for post-combustion CO₂ capture*. *Microporous and Mesoporous Materials*, 2019. **276**: p. 107-132.10.1016/j.micromeso.2018.09.018
152. Xian, S., et al., *Vapor-enhanced CO₂ adsorption mechanism of composite PEI@ ZIF-8 modified by polyethyleneimine for CO₂/N₂ separation*. *Chemical Engineering Journal*, 2015. **280**: p. 363-369.10.1016/j.cej.2015.06.042
153. Fagerlund, J., J. Highfield, and R. Zevenhoven, *Kinetics studies on wet and dry gas-solid carbonation of MgO and Mg(OH)₂ for CO₂ sequestration*. *RSC advances*, 2012. **2**(27): p. 10380-10393.10.1039/C2RA21428H
154. Xiao, G.K., et al., *Advanced adsorbents based on MgO and K₂CO₃ for capture of CO₂ at elevated temperatures*. *International Journal of Greenhouse Gas Control*, 2011. **5**(4): p. 634-639.10.1016/j.ijggc.2011.04.002
155. Ren, X.M., et al., *Carbon nanotubes as adsorbents in environmental pollution management: A review*. *Chemical Engineering Journal*, 2011. **170**(2-3): p. 395-410.10.1016/j.cej.2010.08.045
156. Harada, T., et al., *Alkali Metal Nitrate-Promoted High-Capacity MgO Adsorbents for Regenerable CO₂ Capture at Moderate Temperatures*. *Chemistry of Materials*, 2015. **27**(6): p. 1943-1949.10.1021/cm503295g
157. Hao, G.P., et al., *Rapid synthesis of nitrogen-doped porous carbon monolith for CO₂ capture*. *Adv Mater*, 2010. **22**(7): p. 853-7.10.1002/adma.200903765
158. Wu, Z., et al., *One-pot generation of mesoporous carbon supported nanocrystalline calcium oxides capable of efficient CO₂ capture over a wide range of temperatures*. *Physical Chemistry Chemical Physics*, 2011. **13**(7): p. 2495-2503.10.1039/C0CP01807D
159. Wang, S.P., et al., *Recent advances in capture of carbon dioxide using alkali-metal-based oxides*. *Energy & Environmental Science*, 2011. **4**(10): p. 3805-3819.10.1039/c1ee01116b
160. Powell, C.E. and G.G. Qiao, *Polymeric CO₂/N₂ gas separation membranes for the capture of carbon dioxide from power plant flue gases*. *J Journal of Membrane Science*, 2006. **279**(1-2): p. 1-49.10.1016/j.memsci.2005.12.062
161. Xie, K., et al., *Increasing both selectivity and permeability of mixed-matrix membranes: Sealing the external surface of porous MOF nanoparticles*. *Journal of Membrane Science*, 2017. **535**: p. 350-356.10.1016/j.memsci.2017.04.022
162. Norahim, N., et al., *Recent Membrane Developments for CO₂ Separation and Capture*. *Chemical Engineering & Technology*, 2018. **41**(2): p. 211-223.10.1002/ceat.201700406
163. Chen, H.H., et al., *Integration of Membrane Separation with Nonthermal Plasma Catalysis: A Proof-of-Concept for CO₂ Capture and Utilization*. *Industrial & Engineering Chemistry Research*, 2020. **59**(17): p. 8202-8211.10.1021/acs.iecr.0c01067
164. Wang, M.H., et al., *Recent progress on submicron gas-selective polymeric membranes*. *Journal of Materials Chemistry A*, 2017. **5**(19): p. 8860-8886.10.1039/c7ta01862b
165. Favre, E., *Carbon dioxide recovery from post-combustion processes: can gas permeation membranes compete with absorption?* *J Journal of Membrane Science*, 2007. **294**(1-2): p. 50-59.10.1016/j.memsci.2007.02.007
166. House, K.Z., et al., *The energy penalty of post-combustion CO₂ capture & storage and its implications for retrofitting the US installed base*. *J Energy Environmental Science*, 2009. **2**(2): p. 193-205.10.1039/B811608C

167. Merkel, T.C., et al., *Power plant post-combustion carbon dioxide capture: An opportunity for membranes*. Journal of Membrane Science, 2010. **359**(1-2): p. 126-139.10.1016/j.memsci.2009.10.041
168. Kittel, J. and S. Gonzalez, *Corrosion in CO₂ post-combustion capture with Alkanolamines—A review*. Oil & Gas Science and Technology—Revue d'IFP Energies nouvelles, 2014. **69**(5): p. 915-929.10.2516/ogst/2013161
169. Simmonds, M., et al. *A study of very large scale post combustion CO₂ capture at a refining & petrochemical complex*. in *Greenhouse Gas Control Technologies-6th International Conference*. 2003. Elsevier. 10.1016/B978-008044276-1/50007-6