

A New Approach to Improve Dynamic Characteristics of Digitally Controlled Buck-Boost DC-DC Converter

Fujio Kurokawa*, Taku Ishibashi*, Junya Sakemi* and Tadatosh Babasaki**

* Nagasaki University, 1-14 Bunkyo-machi, Nagasaki-shi, Nagasaki, 852-8521 Japan

** NTT, 9-11, Midori-Cho 3-Chome, Musashino-shi, Tokyo, 180-8585 Japan

Abstract--This paper presents a new digital control buck-boost dc-dc converter with bias model to improve dynamic characteristics. The buck-boost converter needs to respond appropriately to changing input voltage and load change with wide input voltage. This approach makes adjustment to the bias value by input voltage and output current. As a result, it is revealed that not only the dynamic characteristics but also static characteristics can be improved and it is effective for wide range input voltage.

Index Terms-- Buck-boost dc-dc converter, Digital control, FIR filter

I. INTRODUCTION

At present, the analog control is used as a control system of the converter. However, the digital control has been attracting attention with the speeding up of the processing speed of the CPU and reducing the cost in recent years. While digital control has negative elements for response such as operation time and A-D conversion time, it is possible that the addition of the monitoring function, the control that is high in complexity, the part mark of the control circuit and the reduction of the fine adjustment point are enabled. Therefore the high function high-reliability, high promotion of efficiency converter are expected, and the digital control of the converter attracts attention [1]-[6].

The buck-boost dc-dc converter is used such as photovoltaic power generation, wind force power generation. However, these output voltages of electricity generated energy are unstable. Therefore, the buck-boost dc-dc converter is required because it has wide input voltage range.

This paper presents a new approach to improve the dynamic characteristics of the digitally controlled buck-boost dc-dc converter. As new approach, the bias value controlled appropriately by detecting input voltage and output current. After reviewing the fundamental configuration of digitally controlled dc-dc converter with the minimum phase FIR filter control [7]-[8] and its operation principle, we analyze the dynamic

characteristics of digitally controlled buck-boost dc-dc converter with changing load and input voltage. The key point of this paper is to describe the possibility to realize the high performance and stable digitally controlled buck-boost dc-dc converter using DSP.

II. OPERATION PRINCIPLE

Figure 1 shows the block diagram of the digitally controlled buck type dc-dc converter using DSP. E_i is the input voltage, e_o is the output voltage and i_o is the output current. T_r is the main switch, D is the fly wheel diode, L is the energy storage reactor, C is the output smoothing capacitor and R is the load. The output current i_o is detected as the voltage e_s by a sensing resistor R_s .

Figure 2 shows the configuration of the digital control circuit in Fig. 1.

e_o , E_i and e_s are sent to the A-D converter through the anti-aliasing filter and is converted into digital amount. The relation between the input e_o and output values $N_{eo,n}$ of the A-D converter is given by equation (1) when it approximately shows the linear expression by considering the width of the quantization to be small.

$$N_{eo,n} = G_{eo} e_o \quad (1)$$

where n denotes an n -th switching cycle and G_{eo} is a gain of the A-D converter.

The digital amount N_n is sent to DSP. In DSP, the numerical value N_{Ton} that corresponds to the on-time interval T_{on} is calculated. The relation between the on-time interval T_{on} and the numerical value N_{Ton} is shown as follows;

$$\frac{T_{on,n+1}}{T_s} = \frac{N_{Ton,n+1}}{N_{Ts}} \quad (2)$$

where N_{Ts} is a numerical value corresponding to the switching period T_s ($=1/f_s$). N_{Ts} is calculated in the PWM signal generation circuit which is composed of a digital comparator or a counter. According to the relation between the on-time interval T_{on} and the numerical value N_{Ton} , T_{on} is generated. This T_{on} regulates the output voltage e_o .

The on-time interval N_{Ton} using the minimum phase FIR filter control circuit is represented as follows;

This work is supported in part by the Grant-in-Aid for Scientific Research (No. 21360134) of JSPS (Japan Society for the Promotion of Science) and the Ministry of Education, Science, Sports and Culture.

$$N_{Ton, n} = N_B - K \sum_{i=0}^q h_i (N_{eo, n-i} - N_R) \quad (3)$$

where K is proportional gain, h_i denotes the digital filter coefficients, q is the amount of the sampling points and N_R is reference value.

In conventional method, it operates FIR filter control by detecting only e_o . Furthermore bias value N_B is fixed.

In this approach, it operates FIR filter control and controls bias value appropriately by detecting E_i and e_s . These analog values are converted to digital values in A-D converter.

$$N_{Ei, n} = G_{Ei} E_i \quad (4)$$

$$\begin{aligned} N_{es, n} &= G_{es} e_s \\ &= G_{es} i_o R_s \end{aligned} \quad (5)$$

N_B is decided by expression (6).

$$N_B = \frac{(2^{N_{bit}} - 1)(2E_o^* + E_i - \sqrt{E_i^2 - 4r \cdot I_o(E_i + E_o^*)})}{2(E_i + E_o^*)} + N_{BI} \quad (6)$$

where E_o^* is desired output voltage and N_{bit} is the number of bits of A-D converter. There is N_{BI} to make up for losses for parasitic resistance in circuit.

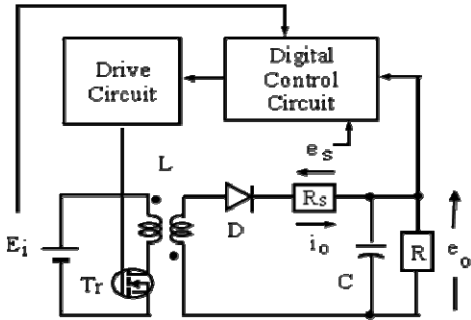

Fig. 1 Diagram of the digitally controlled buck-boost type dc-dc converter using DSP.

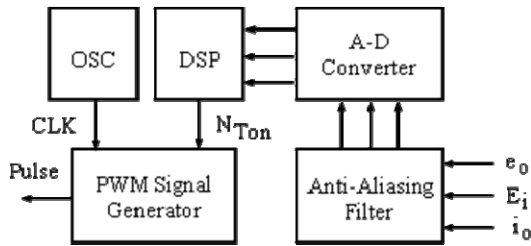

Fig. 2 Digital control circuit.

III. TRANSIENT RESPONSE

A. Load change

Figures 3 through 5 show the simulated transient response of the dc-dc converter with digital control in step change of the load resistor R from 100Ω to 10Ω in each condition. The simulator is PSIM. In these figure,

T_{st} is the time to settle within 1% of the rated output voltage. The switching frequency is 100kHz . The number of the bits of the digital control circuit is 11 bits. The circuit parameters are desired output voltage $E_o^*=10\text{V}$, $L=260\mu\text{H}$, $C=1400\mu\text{F}$ and the leakage inductance is $4\mu\text{H}$. gain K is fixed to 8. In conventional method, the bias value N_B is fixed to 1180. In new approach, N_B depends on E_i and I_o , N_{BI} is 69. These bias numbers are set to output voltage become 10V when input voltage is 10V and load resistor R is 10Ω . The r is 0.4. Little r become less effective, but too large r , it makes losing control.

As for the parameter of FIR filter, pass band frequency is 2.5kHz , transition band frequency is 1.0kHz and stop band frequency is 3.5kHz .

At first, as static characteristics in new approach, it follows that output voltage is nearly desired output voltage E^* in every situation, E_i is 5, 10, 15V and R is 10 and 100Ω .

Figure3 shows transient response in step change load when E_i is 5V and (a) is conventional method, the under shoot is 118mV , and transient time T_{st} is 2.1ms . In figure3 (b) new approach, the under shoot is 249mV and transient time T_{st} is 5.1ms .

Figure4 is $E_i=10\text{V}$ and (a) is conventional method. The under shoot is 133mV , and transient time T_{st} is 1.0ms . In figure4 (b) new approach, the under shoot is 102mV and transient time T_{st} is 0.8ms .

In figure5, $E_i=15\text{V}$ and (a) is conventional method. The under shoot is 116mV , and transient time T_{st} is 0.7ms . In figure5 (b), the under shoot is 158mV and transient time T_{st} is 0.7ms .

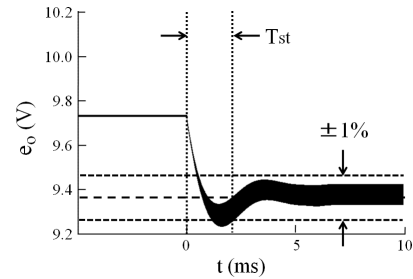

(a) Conventional method

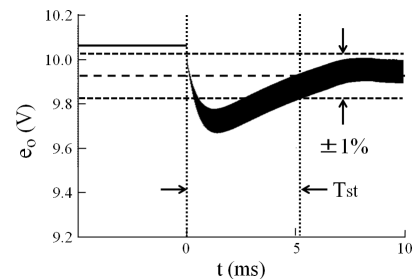

(b) New approach

Fig. 3 Transient response in step change load when E_i is 5V.

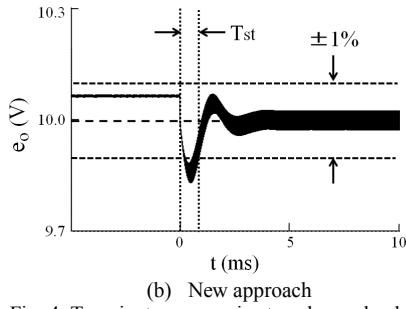
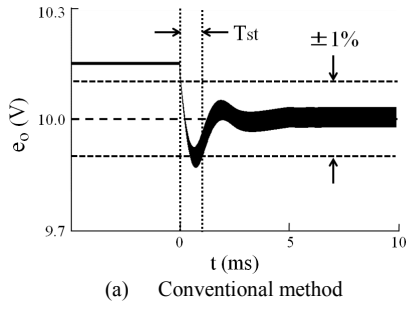

Fig. 4 Transient response in step change load when E_i is 10V.

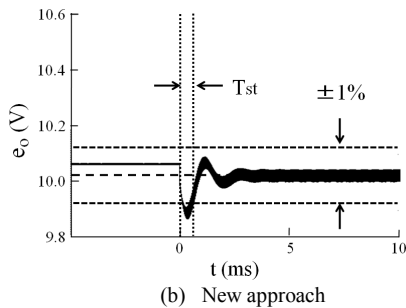
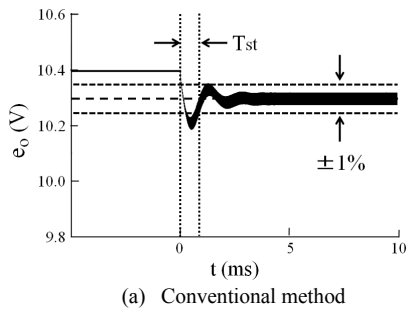

Fig. 5 Transient response in step change load when E_i is 15V.

B. Input voltage change

Figures 6 through 9 show the simulated transient response of the dc-dc converter with digital control in step change of the input voltage. The load resistor R is 10Ω . The other conditions are same as the last time.

Figure6 shows transient response in step change input voltage from 5 to 10V and (a) is conventional method, the over shoot is 293mV, and transient time T_{st} is 2.4ms. In figure6 (b) new approach, the over shoot is 209mV and transient time T_{st} is 0.9ms.

In figure7, E_i changes from 10 to 5V and (a) is conventional method. The under shoot is 131mV and transient time T_{st} is 2.6ms. In figure7 (b), the under shoot is 144mV and transient time T_{st} is 2.9ms.

In figure8, E_i changes from 10 to 15V. In conventional method, the under shoot is 130mV and transient time T_{st} is 1.0ms. In figure8 (b), the under shoot is 73mV and since the output voltage does not exceed 1%, T_{st} is 0ms.

In figure9, E_i changes from 15 to 10V. In conventional method, the under shoot is 293mV and transient time T_{st} is 1.4ms. In figure9 (b), the under shoot is 63mV and since the output voltage does not exceed 1%, T_{st} is 0ms.

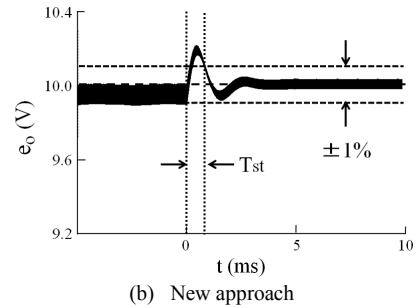
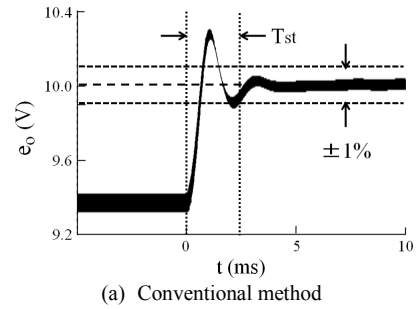

Fig. 6 Transient response in step change input voltage from 5 to 10V.

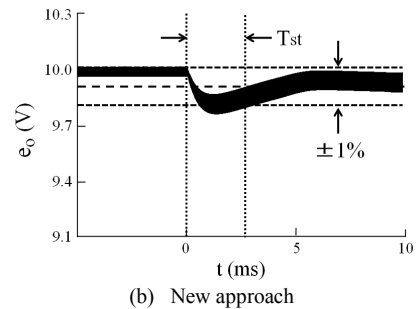
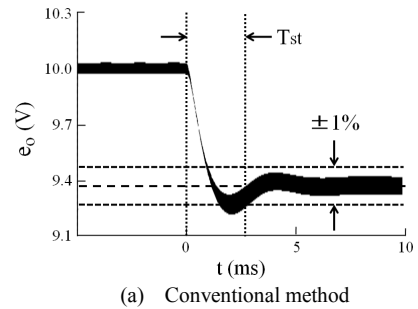

Fig. 7 Transient response in step change input voltage from 10 to 5V.

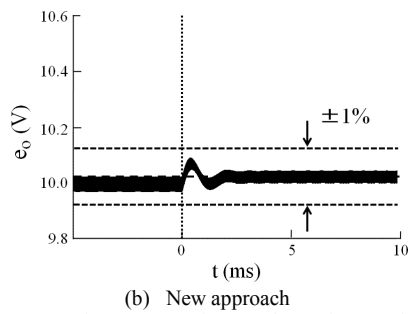
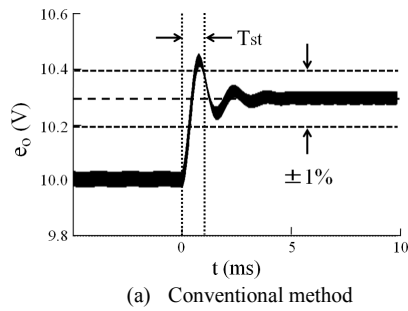

Fig. 8 Transient response in step change input voltage from 10 to 15V.

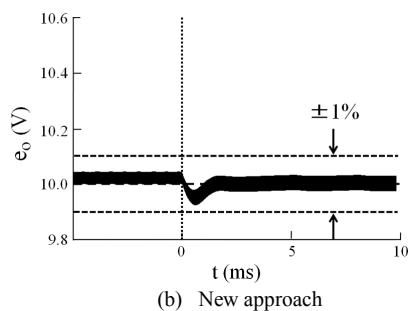
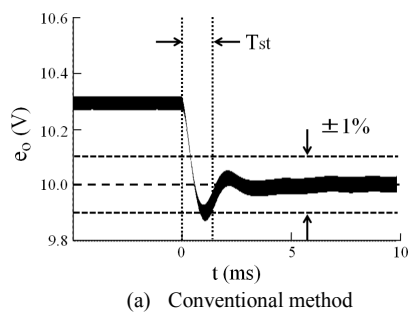

Fig. 9 Transient response in step change input voltage from 15 to 10V.

IV. CONCLUSIONS

The converter is controlled with digital FIR filter. The feed back of conventional method is only detecting output voltage. As a new approach, bias value in DSP is controlled appropriately by detecting input voltage and output current.

We compared it with a conventional method under step change load and input voltage.

As a result, the static characteristics are improved in all conditions. Furthermore, the dynamic characteristics could be also improved in many cases.

We confirm that these results are useful to realize the next generation model of the switching power supply for the renewable energy source.

REFERENCES

- [1] D. Maksimovic, R. Zane and R. Erickson: "Impact of digital control in power electronics," Proc. of ISPSD, pp. 13-22, May 2004.
- [2] H. Hu, V. Yousefzadeh and D. Maksimovic: "Nonlinear control for improved dynamic response of digitally controlled dc-dc converters," IEEE PESC Record, pp. 2584-2590, June 2006.
- [3] V. Yousefzadeh, A. Babazadeh, B. Ramachandram and E. Alarcon: "Proximate time-optimal digital control for dc-dc converters," IEEE PESC Record, pp. 124-130, June 2007.
- [4] F. Kurokawa, K. Tanaka and H. Eto: "Performance characteristics of switching dc-dc power converter with static model reference," Proc. of ICEMS, pp. 1-5, Nov. 2006.
- [5] P. T. Krein: "Digital control generations digital controls for power electronics through the third generation," Proc. of IEEE PEDS, pp. P1-P5, Nov. 2007.
- [6] D. Plaza, R. De Keyser and J. Bonilla: "Model Predictive and Sliding Mode Control of a Boost Converter," Proc. of IEEE SPEEDAM, pp.37-42, June 2008.
- [7] B. Mulgrew, P. Grant and J. Thompson: "Digital signal processing," Macmillan Press Ltd., London, 1999.
- [8] Fujio Kurokawa and Taku Ishibashi, "Dynamic Characteristics of Digitally Controlled Buck-Boost DC-DC Converter," IEEE PEDS, pp1-6, Oral4_3A_4, Nov. 2009.