



# Metal contamination budget at the river basin scale: a critical analysis based on the Seine River

L. Lestel, Michel Meybeck, Daniel Thevenot

► **To cite this version:**

L. Lestel, Michel Meybeck, Daniel Thevenot. Metal contamination budget at the river basin scale: a critical analysis based on the Seine River. Hydrology and Earth System Sciences Discussions, European Geosciences Union, 2007, 4 (3), pp.1795-1822. <hal-00330803>

**HAL Id: hal-00330803**

**<https://hal.archives-ouvertes.fr/hal-00330803>**

Submitted on 20 Jun 2007

**HAL** is a multi-disciplinary open access archive for the deposit and dissemination of scientific research documents, whether they are published or not. The documents may come from teaching and research institutions in France or abroad, or from public or private research centers.

L'archive ouverte pluridisciplinaire **HAL**, est destinée au dépôt et à la diffusion de documents scientifiques de niveau recherche, publiés ou non, émanant des établissements d'enseignement et de recherche français ou étrangers, des laboratoires publics ou privés.

Papers published in *Hydrology and Earth System Sciences Discussions* are under open-access review for the journal *Hydrology and Earth System Sciences*

# Metal contamination budget at the river basin scale: a critical analysis based on the Seine River

L. Lestel<sup>1</sup>, M. Meybeck<sup>2</sup>, and D. R. Thévenot<sup>3</sup>

<sup>1</sup>Centre d'Histoire des Techniques et de l'Environnement, CNAM Case I-161, 5 rue du Vertbois, 75003 Paris, France

<sup>2</sup>UMR Sisyphe 7619, Université P. et M. Curie, boîte 105, 4 place Jussieu, 75006 Paris, France

<sup>3</sup>Centre d'Enseignement et de Recherche sur l'Eau, la Ville et l'Environnement (Cereve), UMR-MA 102, Université Paris 12 Val de Marne, Faculté de Sciences et Technologie, 61 Avenue du Général de Gaulle, 94010 Créteil Cedex, France

Received: 23 May 2007 – Accepted: 25 May 2007 – Published: 20 June 2007

Correspondence to: L. Lestel (lestel@cnam.fr)

**HESSD**

4, 1795–1822, 2007

## Metal contamination budget at the river basin scale

L. Lestel et al.

Title Page

Abstract

Introduction

Conclusions

References

Tables

Figures

◀

▶

◀

▶

Back

Close

Full Screen / Esc

Printer-friendly Version

Interactive Discussion

EGU

## Abstract

Material flow analysis and environmental contamination analysis are merged into a flux-flow analysis (F2A) as illustrated for the metal circulation in the Seine River catchment. F2A combines about 30 metal flows in the anthroposphere (14 million people) and/or metal fluxes in the environment (atmosphere, soils, and aquatic system) originating from two dozens of sources. The nature and quality of data is very heterogeneous going from downscaled national economic statistics to upscaled daily environmental surveys.

A triple integration is performed: space integration over the catchment (65000 km<sup>2</sup>), time integration for the 1950–2000 trend analysed at 5 year resolution, and a conceptual integration resulting in two F2A indicators.

Despite the various data sources an average metal circulation is established for the 1994–2003 period and illustrated for zinc: (i) metal circulation in the anthroposphere is now two orders of magnitude higher than river outputs, (ii) long term metal storage, and their potential leaks, in soils, wastedumps and structures is also orders of magnitude higher than present river fluxes. Trend analysis is made through two F2A indicators, the per capita excess load at the river outlet and the leakage ratio (excess fluxes/metal demand). From 1950 to 2000, they both show a ten fold improvement of metal recycling while the metal demand has increased by 2.5 to 5 for Cd, Cu, Cr, Pb and Zn, and the population by 50 %.

## 1 Introduction

Transfers of contaminants on a given territory are generally considered by different communities considering either the material flow analysis (MFA) (Baccini and Brunner, 1991; Brunner and Rechberger, 2004; Graedel and Allendy, 2003; Stigliani et al., 1993) or the environmental contamination analysis (ECA) (Horowitz, 1991; Cave et al., 2003). Both communities are using different approaches and concepts, their time and space

## Metal contamination budget at the river basin scale

L. Lestel et al.

Title Page

Abstract

Introduction

Conclusions

References

Tables

Figures

◀

▶

◀

▶

Back

Close

Full Screen / Esc

Printer-friendly Version

Interactive Discussion

scales may be different and they rarely share identical indicators.

From an environmental point of view, particularly for river catchment contamination, analyses are often focused on pollutants fluxes and fate; the transfers occurring in the anthroposphere are not addressed and only considered through potential leaks (Salomons and Forstner, 1984). Classical MFA focuses on imports, exports, usage of goods, their transformation and recycling.

MFA is often made for administrative spatial units such as cities (Stockholm, Bergbäck et al., 2001), counties, and countries (Belgium, Billen et al., 1983) for which economic statistics are available. They also have their own time steps, annual to pluri-annual, and their data uncertainty is often unknown. ECA is performed on entities with natural boundaries such as river basins for which output fluxes can be determined, providing natural space integration. Some ECA are also made at very fine spatial (e.g. rain gauges, lysimeters) and temporal (subdaily) scales. Long term trends on economic data (>20 y) are more common than those available from environmental surveys.

We are trying here to combine both MFA and ECA approaches in a single study of metal contamination in the Seine River catchment. Metals have been chosen because their use history is relatively well documented, and their contamination trends can be reconstructed over a period of 50 years from sediment archives. The Seine River catchment is selected for multiple reasons: (i) its size (65 000 km<sup>2</sup>) and multiple economic activities make it very representative of the post-war II evolution of western Europe catchments, (ii) its economic drivers and human pressures on the environment can be determined from national and local statistics, (iii) the environmental circulation of metals has been described in many papers published by the PIREN Seine program and recently synthesized by Thévenot et al. (2007) and Meybeck et al. (2007). The catchment is characterized by a very high population density (average 215 people.km<sup>-2</sup>) essentially aggregated in Paris conurbation (2740 km<sup>2</sup>, 9.47 M inhabitants, 415 municipalities), which is further mentioned as Paris megacity.

In this paper, we are presenting first our conceptual integration of MFA and ECA, termed here F2A (fluxes-flows analysis), then a critical analysis of our data base. The

## Metal contamination budget at the river basin scale

L. Lestel et al.

Title Page

Abstract

Introduction

Conclusions

References

Tables

Figures

◀

▶

◀

▶

Back

Close

Full Screen / Esc

Printer-friendly Version

Interactive Discussion

integrated budget of zinc for the period 1994–2003 is discussed. Finally, the long term circulation (1950–2000) of metals in the system is analysed through two integrated indicators.

## 2 The F2A methodology (fluxes-flows analysis)

Both MFA and ECA are characterized by inputs/outputs fluxes and by stocks of material in constructions, goods, dumps and in soils and sediments.

The F2A can be conceived as a triple integration (Fig. 1): (i) first a spatial integration, merging the spatial limits of both MFA and ECA: we believe that it is easier to constrain MFA boundaries to natural boundaries, such as river catchment, than the opposite, (ii) then a temporal integration, using the same budget periods and time steps for all kinds of indicators either economics (indicators i) or environmental (indicators j), (iii) finally a conceptual integration resulting in F2A indicators (indicators k) defined for the selected temporal and spatial scales. This approach has a great similarity to the one established by Billen et al. (1983) for the matter circulation in Belgium. The consideration of a river catchment allows for an easier estimate of present excess load and the reconstruction of their past trajectories through environmental archives.

In its present stage, the F2A analysis on a river catchment is mixing five different types of information (Tables 1 to 3 and Fig. 2): (i) circulation of metal products and goods (flows P1 to P10), (ii) leaks from the anthroposphere to the environment (L1 to L7), (iii) transfers of metal in the atmosphere and into the river system (T1 to T4), (iv) anthropogenic storage of metals on the catchment (SA, SF, SI, SL, SU) and storage of metal-containing sediments along the river course, from lakes and reservoirs to the estuary (SR<sub>2</sub> to SR<sub>5</sub>), (v) contamination records obtained from sediment archives (A2 to A5). The floodplain cores in the lower course of the river (A4) are used to reconstruct the metal contamination over 65 years (Meybeck et al., 2007).

Since it is very difficult to obtain all the necessary information at the same time, i.e. for a given year, we have considered an average metal budget for a period of 10 years,

## Metal contamination budget at the river basin scale

L. Lestel et al.

Title Page

Abstract

Introduction

Conclusions

References

Tables

Figures

◀

▶

◀

▶

Back

Close

Full Screen / Esc

Printer-friendly Version

Interactive Discussion

assuming that most fluxes and flows determined over shorter periods (e.g. sewage budgets; fertilizer uses; atmospheric fallout) are constant and/or can be averaged. Transfers that are controlled by human activities are termed flows throughout this paper and uncontrolled transfers are termed fluxes. For example, sewage collection (e.g.  $L3_{A,B}$ ), treatment and reuse ( $P8_B$ ), release ( $L4$ ) and the river sediment dredging ( $P10$ ) are considered as flows while the street runoff ( $L6$ ) is considered as a flux.

Two indicators illustrating the long-term evolution of metal circulation have been generated from the fluxes-flows analysis (F2A): the per capita excess loads of metals and the leakage ratio. They describe the evolution of metal circulation over a period of 50 y: (i) the per capita excess load of metals corresponds to the estimated metal surplus in river material that escapes the river system, expressed as g metal per capita per year, (ii) the leakage ratio over the river catchment is the ratio of excess metal flux at the river outlet divided by the general metal use in the catchment (Meybeck et al., 2007). Both indicators are averaged over periods of 5 years that smoothes the year to year variations of metal uses and of the riverine fluxes.

### 3 Characterization and critical analysis of data sources

The construction of this metal budget implies the use of heterogeneous data from multiple sources, which are first presented. Many of them have to be upscaled/downscaled spatially or temporally in order to allow their integration in our conceptual model. This will be discussed in the second subsection. Finally the limitations of each type of data are analysed through various criteria: data quality control, space adequation, temporal adequation and data accessibility.

#### 3.1 Data collection

More than 30 different sources of data have been used to assess the drivers of metal uses and their related pressures and the state of the environment (Tables 1, 2, 3). Pri-

## Metal contamination budget at the river basin scale

L. Lestel et al.

Title Page

Abstract

Introduction

Conclusions

References

Tables

Figures

◀

▶

◀

▶

Back

Close

Full Screen / Esc

Printer-friendly Version

Interactive Discussion

## Metal contamination budget at the river basin scale

L. Lestel et al.

Title Page

Abstract

Introduction

Conclusions

References

Tables

Figures

◀

▶

◀

▶

Back

Close

Full Screen / Esc

Printer-friendly Version

Interactive Discussion

5 many sources originate from diverse public providers, including five different ministries, the French National Statistic Institution (INSEE), specific institutions such the National Environmental Agency (ADEME), the Seine River Basin Authority (AESN), Paris megacity Sanitation Institution (SIAAP), the Seine River Navigation Authority (SNS),  
 10 the technical assistance service (SATESE) to wastewater treatment plants (WWTP), the national atmospheric emission agency (CITEPA). The non ferrous metal industries yearbooks are our main data source from the private sector (FEDEM, 2003). For the Environmental state, academic studies (most of them generated by the PIREN Seine program, Azimi et al., 2003; Azimi et al, 2005; Garnaud et al., 1999; Gromaire et al.,  
 15 2002; Grosbois et al., 2006; Meybeck et al., 2007; Thévenot et al, 2007) were used, along with river survey data at the River basin scale from the River Basin Authority and data arising from European programs (such as the Corine Land Cover from the European Environmental Agency, EEA, 2000), and some data coming from ministries.

Many data for metal circulation of goods result from the combination of several primary sources: as examples, lead contained in TV screens (P4a, Table 4) is known from the amount of lead in a cathodic tube then multiplied by the number of TV sets estimated in the Seine river basin. Cadmium inputs to crops from P fertilisers are calculated from fertiliser use statistics (Unifa, 2005) and their average Cd/P ratio. Despite the diversity of sources, some data are still missing such as metal stocks which remain mostly unknown.

Some metal flows are estimated by different agencies using different approaches. This is illustrated for lead-tetraethyl use and/or emission to the atmosphere (P4d, Table 4 and Fig. 3) and for the metal contents in industrial waste waters which can be estimated (i) from nominal rates based on industrial production, (ii) from auto controls reported by industries (EauFrance, 2004; IREP, 2004) and (iii) from external controls without notice made by assistance services (SATESE) at random dates.

Aggregated statistics on usages of goods are commonly found in economical statistics. Yet the environmental behavior of these products is often very different: e.g. lead pigments and explosives are combined as “chemicals”. The metal content of many

goods and wastes is often not monitored and may greatly vary over time (cadmium in batteries, mercury in dental care). Until recently, the only available metal emissions to the river were aggregated by water authorities (Agences de l'eau) through the METOX load, a basket of six metals weighted according to their respective toxicity, assessed from industrial production data: this indicator is obviously unusable for MFA.

### 3.2 Upscaling/downscaling

Data have been collected at multiple spatial scales from 10 m<sup>2</sup> (agricultural plots) to 550 000 km<sup>2</sup> (national statistics). Since the Seine catchment area is 65 000 km<sup>2</sup>, they had to be either downscaled or upscaled:

(1): Downscaling socioeconomic data. Many economic activity data are only available at the country scale. They were downscaled here proportionally to Seine river basin (i) population (14/60 million inhabitants in 2000), (ii) industrial activity (typically 30% according to specific industrial inventories), and (iii) agricultural production (e.g. 20% for the oleaginous plants and for cereals).

(2): Upscaling socioeconomic data. Few economic data are generated at the county scale ("département" in French, typically 5 000 km<sup>2</sup>), as the atmospheric emissions, or at the municipal scale (typically 20 km<sup>2</sup>), as the population. These data have been prorated to the proportion of their area within the catchment limits.

(3): Upscaling environmental data. (i) Agricultural plots (10 m<sup>2</sup>) were used to assess metal circulations in agrochemicals, soils, water and crops and were upscaled proportionally to land use and land cover data derived from satellite (Corinne Land Cover) and from agricultural census. (ii) A pilot study on an urban sewage basin (0.4 km<sup>2</sup>) was used to assess metal circulation in Paris megacity from atmospheric fallout, roof and street runoff, and domestic sources (Thévenot et al., 2007). It was upscaled proportionally to Paris megacity land cover and to population according to population census. (iii) Sewage inputs have to be upscaled using data related to the large waste water treatment plant (WWTP) of Paris megacity (Seine-Aval WWTP), at which 8 million inhabitants were connected; these pressures were then upscaled to the whole catchment

## Metal contamination budget at the river basin scale

L. Lestel et al.

Title Page

Abstract

Introduction

Conclusions

References

Tables

Figures

◀

▶

◀

▶

Back

Close

Full Screen / Esc

Printer-friendly Version

Interactive Discussion



using the population ratio. (iv) Small forested river basins (10 to 100 km<sup>2</sup>) were used to assess natural geochemical background of metals. (v) River surveys at stations upstream (10 000 km<sup>2</sup>) and downstream of Paris provided data for the Paris megacity impact (total area: 2740 km<sup>2</sup>).

(4): Extrapolating metal contamination inventories. Only very few data pertinent to the metal contamination are collected and archived at the river basin scale, as domestic and industrial sewage inputs. However these data sets are not comprehensive and have variable data quality control. A new register of point sources inputs is currently realised (AESN, 2006) as a consequence of the Water Framework Directive application but could not be used here in a retrospective budget.

The range of temporal resolution of data is also wide. Available data result from (i) episodic events such as Saharan dust storms (few days per year or less) which represent roughly 50% of the external input of atmospheric particles, (ii) daily to monthly data, such as the environmental monitoring in WWTP, (iii) monthly data (such as custom registers) and (iv) annual data (economical statistics). Occasional 24 h surveys (once or twice a year) of industrial waste waters release in rivers were also used.

River exports at mouth, commonly determined on an annual basis, encapsulate the whole catchment information, i.e. natural fluxes, leaks from the anthroposphere and retention processes within aquatic system. In our averaged 10 year budget (Thévenot et al., 2007), monthly and/or seasonal surveys were upscaled at the annual level. Some fluxes (eg. River outputs T4, Fig. 1, Table 2) were averaged over the 1990–2000 period, to smooth the annual variation of river metal contamination (Gromaire et al., 2002; Grosbois et al, 2006; Meybeck et al., 2007), which results from the following events: (i) during major storm events Paris sewers overflow into the river, resulting in spikes of suspended matter contamination within the Parisian reach; (ii) during high water periods metal contents may vary with tributary mixing and re-suspension of deposited sediments; (iii) year to year variations of average metal contents in suspended matter are linked to the average river discharge with higher values observed during dry years; (iv) on the contrary the river fluxes of metal are directly linked to suspended matter

## Metal contamination budget at the river basin scale

L. Lestel et al.

Title Page

Abstract

Introduction

Conclusions

References

Tables

Figures

◀

▶

◀

▶

Back

Close

Full Screen / Esc

Printer-friendly Version

Interactive Discussion

fluxes, always higher during wet years. Other fluxes were known only for few years only and had to be extrapolated to the whole period.

### 3.3 Critical analysis of selected data sources

Each type of material flow should be characterized by its period of record, its space scale (generally at the country level), its uncertainty, and its availability. Upscaling/downscaling issues and miscellaneous time scales lead to diverse data uncertainties and limitations, which are here qualitatively estimated (Table 4).

As an example, the metal atmospheric fallout T1 was determined by aggregating several sources of data, followed by data upscaling. It is noteworthy that only few academic studies of atmospheric fallout of metals are available in France. There is no fallout network, therefore the 5-year survey of terrestrial mosses contamination is considered (Gombert et al., 2004). Its sampling point's grid is 30×30 km in accordance to the European guidelines for moss sampling sites. Several hundred stations of moss contamination for Cd, Cu, Pb, Ni and Zn were used. A multi-metal index of moss contamination was then generated and spatially distributed in the Seine river catchment, allowing for the determination of four zones of moss contamination levels with their respective area. Pilot studies of atmospheric fallout were conducted at six stations located in these different zones, assuming a direct relation between metal fallout and moss contamination, resulting in specific areal weights for each fallout station. The Seine basin fallout is then computed on the basis of station fallout figures ( $\text{kg km}^{-2} \text{y}^{-1}$ ) and their respective weights.

Another example of three different approaches is shown in Fig. 3: the long term trend (1950–2000) of atmospheric lead contamination is estimated from both economic and environmental data. Atmospheric lead is mainly due to leaded gasoline. Its flows (P4d) since the 1950's can be estimated (i) from economical statistics (INSEE) of leaded gasoline products here downscaled to the Seine basin limits, (ii) from car traffic records times gas consumption, taking into account the evolution of lead content in French gasoline since the 1970's, which decreases from 1.3 g/l PbEt<sub>4</sub> before

## Metal contamination budget at the river basin scale

L. Lestel et al.

Title Page

Abstract

Introduction

Conclusions

References

Tables

Figures

◀

▶

◀

▶

Back

Close

Full Screen / Esc

Printer-friendly Version

Interactive Discussion

1975 to 0.40 between 1975 and 1991, to 0.15 after 1991, before been banned in 2000 (various sources; INSEE, 2002), (iii) direct emissions (L2 of Fig. 2) of lead metal to the atmosphere as published at the county scale since 1990, which only covers the very last part of the atmospheric lead story (CITEPA, 2004), and (iv) annual lead fallout data as calculated from moss contamination and direct fallout measurements at six stations ( $T1_F + T1_A + T1_U$ ). Although the recent decrease of Pb emission and fallout is well established in the four approaches, absolute numbers may be different up to a factor 8, in 1995.

The Table 4 is a first attempt to take into account these difficulties of F2A: the general heterogeneity of these various sources of information is striking, yet they can be merged into general budgets, comparison of fluxes and flows and trend analysis.

#### 4 Application of the F2A approach to the metal circulation in the Seine catchment

The flux-flow analysis, despite its difficulties and uncertainties, can be performed at the river basin scale. It is presented here for the zinc budget (1994–2003), comparing fluxes and flows, and for the long term trends of fluxes and flows through two specific indicators.

##### 4.1 The average zinc budget (1994–2003)

The annual Zn budget has been assessed in the Seine River basin, for the 1994-2003 period, using the sets of data previously described in Thévenot et al. (2007) (Fig. 4). More than two dozens of fluxes have been measured or estimated and ranked. They all refer to a catchment area of 65 000 km<sup>2</sup>. Atmospheric deposits reach 500 and 600 ty<sup>-1</sup> on forests-grassland and on cultivated land respectively. These Zn inputs to soils ( $T1_A + T1_F$ : 1100 ty<sup>-1</sup>) are much larger than those related to the use of fertilisers (P7: 30 ty<sup>-1</sup>) and to the recycling of waste water treatment plant sludge (P8: 80 ty<sup>-1</sup>). They

## Metal contamination budget at the river basin scale

L. Lestel et al.

Title Page

Abstract

Introduction

Conclusions

References

Tables

Figures

◀

▶

◀

▶

Back

Close

Full Screen / Esc

Printer-friendly Version

Interactive Discussion

**Metal contamination budget at the river basin scale**

L. Lestel et al.

Title Page

Abstract

Introduction

Conclusions

References

Tables

Figures

◀

▶

◀

▶

Back

Close

Full Screen / Esc

Printer-friendly Version

Interactive Discussion

are only overpassed by waste disposal in waste dumps (urban solid waste and collected sand from domestic sewer settling chambers, P9: 1700 t.y<sup>-1</sup>; and a fraction of waste water treatment plant sludge, P8<sub>A</sub>: 180 t.y<sup>-1</sup>). The circulation of Zn in the anthroposphere is thus, hopefully, much higher than direct inputs to rivers: anthropogenic leaks in rural area are estimated as 5 t.y<sup>-1</sup>(T2<sub>A</sub>). They are negligible when compared to industrial direct inputs (L5: 35 t.y<sup>-1</sup>) and to urban area inputs: sewer overflows (L6: 80 t.y<sup>-1</sup>) and waste water treatment plant outlet (L4: 130 t.y<sup>-1</sup>). If these direct inputs to rivers (250 t.y<sup>-1</sup>) are added to the upstream river basin erosion (T3: 42 t.y<sup>-1</sup>) and corrected by particulate retention in reservoirs (SR2: 0.7 t.y<sup>-1</sup>), alluvial plains (SR3 + SR4: 2.5 t.y<sup>-1</sup>) or related to sediment dredging for river navigation maintenance (P10: 14 t.y<sup>-1</sup>), one should expect a total output of 275 t.y<sup>-1</sup> at the river mouth at Poses. The difference with the measured value (T4: 450 t.y<sup>-1</sup> i.e. 315 t.y<sup>-1</sup> for particulate Zn + 135 t.y<sup>-1</sup> for dissolved Zn) shows clearly that some significant inputs to river have not been accounted for. It is likely that such inputs result from unaccounted leaks from urban and industrial storage sites.

4.2 Comparison of fluxes and flows approaches

Two types of comparison have been made: first on atmospheric emissions and fallout then on the anthropogenic output *versus* total output at the river mouth.

Industrial emissions (flows) and measured fallout (fluxes) are estimated separately in most studies. Figure 5 is comparing these two estimates for seven metals (Thévenot et al., 2007). Agreement between emissions and excess fallout (corrected from Aeolian erosion) are generally good, fallout being between 0.8 and 10 times the emissions figures: when taking into account the absence of any quality control in most industrial declarations of their annual metal emissions, such agreement can be considered as reasonably good.

In Fig. 6, the total metal output at the river mouth is compared to (i) natural sources, (ii) domestic inputs based on river surveys and (iii) industrial sewage release to rivers, resulting both from voluntary industrial declaration procedure and from partially mea-

sured and extrapolated fluxes. “Domestic” inputs were calculated from metal fluxes at selected river stations (n=15), upstream and down stream Paris, for population density ranging from 20 to 800 inhab/km<sup>2</sup>. These fluxes were found to be proportional to the population density for most stations. These fluxes were then prorated to the population, determining a “domestic” per capita release expressed in g per capita per year, of which the median is considered and then extrapolated to the whole catchment. The large percentage of “unknown sources” illustrates the interest of comparing fluxes and flows: such discrepancy between measured values and determined outputs reveals the lack of knowledge about data uncertainties and some metal contamination sources. We suspect that reported industrial sources are underestimated: surveys are much less frequent and/or representative of total annual releases than river survey. Unaccounted leaks from past metal storage sites as industrial sites (SI) and landfills (SL) must also be considered. Long term storage in soils and sediments, in waste dumps and urban structures represents an important retention on continents, which is a major feature of the Earth system functioning (Meybeck and Vorosmarty, 2005). This heritage of more than 200 years of metal industries in the catchment should now be investigated. Another long term heritage of human activity is the acute contamination of Zn, Cd and other metal in a restricted area of about 30 km<sup>2</sup> west of Paris where the city waste waters have been used for farmland irrigation since the 1890’s (Barles, 1999).

### 4.3 Integrated F2A indicators

The combination of flows and fluxes indicators allows for the proposition of two integrated indicators that describe the evolution of metal circulation over a period of 50 years (Meybeck et al., 2007): (i) the per capita excess load of metals corresponds to the estimated metal load in river particulates that adds to natural erosion and is present at the river mouth; it is averaged here over a period of 5 years and expressed as g metal per capita per year; (ii) the leakage ratio over the river catchment, i.e. the ratio of excess metal flux at the river outlet divided by the general metal use within the

## Metal contamination budget at the river basin scale

L. Lestel et al.

Title Page

Abstract

Introduction

Conclusions

References

Tables

Figures

◀

▶

◀

▶

Back

Close

Full Screen / Esc

Printer-friendly Version

Interactive Discussion

catchment, also averaged over periods of 5 years. These indicators are here illustrated for cadmium and zinc (Fig. 7).

The per capita excess loads of metal have been determined at the river mouth station. The metal contamination survey carried on suspended matter since 1983 has been used to validate the metal contamination archived in floodplain cores for the 1935–2000 period at the same site. A constant sediment flux of 700 000 t/year is then associated to metal contents to generate average fluxes for 5 y periods. Grain-size corrections, dissolved metals correction, background references and population evolution are detailed in Meybeck et al. (2007). The excess loads depend on metals and periods as illustrated for zinc and cadmium (Fig. 7). For zinc the maximum excess load is observed from 1935 to 1955, with a notch in 1940–1945 that can be attributed to the impact of World War II on the general industrial activity. Since 1955 there is an 8-fold decrease of excess zinc per capita from 150 to 21 g Zn cap<sup>-1</sup> y<sup>-1</sup>. For cadmium, there is a well-marked maximum in 1960–1965, then a 30-fold decrease from 3.35 to 0.10 g Cd cap<sup>-1</sup> y<sup>-1</sup>. These values are close to those established for Stockholm in 1999 by Sörme and Lagerkvist (2002) (Zn: 16.3 g cap<sup>-1</sup> y<sup>-1</sup> and Cd: 0.04 g cap<sup>-1</sup> y<sup>-1</sup>). Other metals (Pb, Cu, Cr and Hg) trajectories confirm a major decrease of contamination in the last 50 years.

The second indicator rates the excess fluxes exported by the river basin, averaged for 5 y periods (Meybeck et al., 2007). The metals flows from 1950 to 2000 have several patterns: (i) general increase by a factor 2.5 to 5 for Cu, Cr, P and Zn, (ii) general decrease since 1960 by more than 10 for Hg and (iii) a recent decrease by 40% of the Cd demand since 1995. The leakage ratio of all metals is markedly decreasing: in 1960 it exceeded more than 20% for Cd and was an order of magnitude less for Zn. Now it has decreased by an order of magnitude for both metals (Fig. 7).

Only the comparison of fluxes (metal export by the river) and flows (metal demand on the catchment) could lead to such trend analysis: despite the increasing population (50%) and increasing use of metal per capita, the metal decontamination is really effective. This is attributed to the early de-industrialization of the catchment since

## Metal contamination budget at the river basin scale

L. Lestel et al.

Title Page

Abstract

Introduction

Conclusions

References

Tables

Figures

◀

▶

◀

▶

Back

Close

Full Screen / Esc

Printer-friendly Version

Interactive Discussion

1960, particularly Paris megacity and to the recycling of metals in the industrial sector (Thévenot et al., 2007; Meybeck et al., 2007).

## 5 Conclusions

The F2A is an adequate tool for better understanding the circulation of contaminants that is needed from the local to the global scale (Steffen et al., 2004). It is based on multiple and heterogeneous sources of data which are generated at different space and time scales, and have variable data quality insurance. Actually many data on waste release have no quality insurance comparable to those found in environmental studies, from field sampling and laboratory analyses to flux determinations (Rode and Suhr, 2007). One should think now to generate and focus the economic data considering their eventual use as data sources for environmental budgets.

Despite these uncertainties the F2A can lead to a coherent description of metal circulation. The river catchment is a natural unit for such analysis provided that its size allows for the downscaling of many economic statistics that are only known at the national level. The detailed budget analysis allows the ranking of the major fluxes and flows. In the Seine catchment it is clear that metal flows in the anthroposphere are now one to two orders of magnitude greater than present metal leaks to the environment, either to the atmosphere or to the aquatic system. The catchment budget also reveals several types of long term storage in soils and sediments and in waste dumps and urban structures. However, it seems difficult to realize such budget for another period, e.g. at the peak of contamination in 1955–1960, for lack of detailed fluxes and flows.

The per capita excess loads and the leakage ratio are robust indicators which describe the overall metal circulation in the system and can be generated from country statistics and sediment archives. The trend analysis should now be compared to other well-documented catchments as the Rhine, Elbe, Scheldt or Humber, in order to check if the efficiency of the anthroposystem in recycling its metals has also been greatly improved over the last 50 years.

## Metal contamination budget at the river basin scale

L. Lestel et al.

Title Page

Abstract

Introduction

Conclusions

References

Tables

Figures

◀

▶

◀

▶

Back

Close

Full Screen / Esc

Printer-friendly Version

Interactive Discussion

*Acknowledgements.* This paper is part of the PIREN-Seine Programme (1989–2005) which benefited from the financial support of a dozen public and private institutions backed by the Agence de l'Eau Seine-Normandie (AESN). We greatly acknowledge all of them. The help of several laboratories (Unité de Science du Sol (INRA), Laboratoire des Sciences du Climat et de l'Environnement (LSCE), Laboratoire Interuniversitaire des Systèmes atmosphériques (LISA)) has been much appreciated.

## References

AESN: Priority pollutant released by industries upstream the Seine River mouth: first results of the 2005–2006 campaign. AESN, Nanterre, 2006.

Azimi, S., Ludwig, A., Thévenot, D. R., and Colin, J. L.: Trace metal determination in total atmospheric deposition in rural and urban areas, *Sci. Total Environ.*, 308, 247–256, 2003.

Azimi, S., Rocher, V., Garnaud, S., Varrault, G., and Thévenot, D.: Decrease of atmospheric deposition of heavy metals in an urban area from 1994 to 2002 (Paris, France), *Chemosphere*, 61, 645–651, 2005.

Baccini, P., and Brunner, P. H.: *Metabolism of the Anthroposphere*. Springer-Verlag, Berlin, 1991.

Barles, S.: *La ville délétère*, Champ Vallon, Seyssel, 1999.

Bergbäck, B., Johansson, K., and Molhander, U.: Urban metal flows – a case study of Stockholm. Review and Conclusions, *Water Air Soil Pollut. Focus*, 1(3–4), 3–24, 2001.

Billen, G., Toussaint, F., Peters, P., Sapir, M., Steenhout, A., and Vanderborght, J. P.: *L'écosystème Belgique. Essai d'écologie industrielle*. CRISP, Bruxelles, 1983, 163 pp.

Brunner, P. H. and Rechberger, H.: *Practical Handbook of Material Flow Analysis*. Lewis Publishers, New York, 2004.

Cave, R. R., Ledoux, L., Turner, K., Jickells, T., Andrews, J. E., and Davies, H.: The Humber catchment and its coastal area: from UK to European perspectives, *Sci. Total Environ.*, 314–316, 31–52, 2003.

CITEPA: Calcul des émissions dans l'air. Principes méthodologiques généraux, <http://www.citepa.org>, CITEPA, Paris, 2004.

EEA: Corine Land Cover, <http://dataservice.eea.eu.int/dataservice>. European Environment Agency, Copenhagen, 2000.

## Metal contamination budget at the river basin scale

L. Lestel et al.

Title Page

Abstract

Introduction

Conclusions

References

Tables

Figures

◀

▶

◀

▶

Back

Close

Full Screen / Esc

Printer-friendly Version

Interactive Discussion



- EauFrance: Rejets industriels, 1998 to 2002 data. [www.eaufrance.fr](http://www.eaufrance.fr). Ministère de l'Ecologie et du Développement Durable, Paris, 2004.
- FEDEM (Fédération des métaux non ferreux): L'industrie des minerais, minéraux industriels et métaux non ferreux. Chiffres clés 2002. FEDEM, Paris, 2003.
- 5 Garnaud, S., Mouchel, J. M., Chebbo, G., and Thévenot, D.: Heavy metal concentrations in dry and wet atmospheric deposits in Paris district: comparison with urban runoff, *Sci. Total Environ.*, 235, 235–245, 1999.
- Gombert, S., Rausch de Traubenberg, C., Losno, R., Leblond, S., Colin, J. L., and Cossa, D.: Biomonitoring of element deposition using mosses in the 2000 French survey: identifying  
10 sources and spatial trends. *J. Atmos. Chem.*, 49, 479–502, 2004.
- Graedel, T. E. and Allendy, B. R.: *Industrial Ecology*, 2<sup>nd</sup> edition. Prentice Hall, Pearson Education Inc., Upper Saddle River, New Jersey, 2003.
- Gromaire, M. C., Chebbo, G., and Constant, A.: Impact of zinc roofing on urban runoff pollutant loads: the case of Paris, *Water Sci. Technol.*, 45(7), 113–122, 2002.
- 15 Grosbois, C., Meybeck, M., Horowitz, A., and Ficht, A.: The spatial and temporal trends of Cd, Cu, Hg, Pb and Zn in Seine River floodplain deposits (1994–2000), *Sci. Total Environ.*, 356, 22–37, 2006.
- Horowitz, A. J.: *A primer on sediment-trace element chemistry*, 2<sup>nd</sup> ed. Lewis publishers Inc, Chelsea, MI, 1991.
- 20 INSEE: 2000 Annual report, Institut National de la Statistique et des Etudes Economiques, Paris, 2002.
- IREP: Registre Français des Emissions Polluantes, 2004, <http://www.pollutionsindustrielles.ecologie.gouv.fr/IREP/>, Ministère de l'Ecologie et du Développement Durable, Paris, 2004.
- Meybeck, M., Lestel, L., Bonté, P., Moilleron, R., Colin, J. L., Rousselot, O., Hervé, D., de  
25 Pontevès, C., Grosbois, C., and Thévenot D. R.: Historical perspective of heavy metals (Cd, Cr, Cu, Hg, Pb, Zn) in the Seine river basin (France) following a DPSIR approach (1950–2005), *Sci. Total Environ.*, 375, 204–231, 2007.
- Meybeck, M. and Vorosmarty, C.: Fluvial filtering of land-to-ocean fluxes: from natural Holocene variations to Anthropocene. *C. R. Geosciences*, 337, 107–123, 2005.
- 30 Rode, M. and Suhr, U.: Uncertainties in selected river water quality data, *Hydrol. Earth Syst. Sci.*, 11, 863–874, 2007,  
<http://www.hydrol-earth-syst-sci.net/11/863/2007/>.
- Salomons, W. and Forstner, U.: *Metals in the Hydrocycle*. Springer Verlag, New York, 1984.

## Metal contamination budget at the river basin scale

L. Lestel et al.

Title Page

Abstract

Introduction

Conclusions

References

Tables

Figures

◀

▶

◀

▶

Back

Close

Full Screen / Esc

Printer-friendly Version

Interactive Discussion

Sörme, L. and Lagerkvist, R.: Sources of heavy metals in urban wastewater in Stockholm, *Sci. Total Environ.*, 298, 131–145, 2002.

Steffen, W, Sanderson, A., Tyson, P. D., Jager, J., Matson, P. A., Moore, B., Oldfield, F., Richardson, K., Schellnhuber, H. J., Turner, B. L., and Wasson, R. J. (Eds): *Global change and The Earth System*. Springer-Verlag, New York, 2004.

Stigliani, W. M., Jaffé, P. R., and Anderberg, S.: Heavy Metal Pollution in the Rhine Basin, *Environ. Sci. Technol.*, 27, 786–793, 1993.

Thévenot, D. R., Moilleron, R, Lestel, L., Gromaire, M. C., Rocher, V., Cambier, P., Bonté, P., Colin, J. L., de Pontevès, C., and Meybeck, M.: Critical budget of metal sources and pathways in the Seine river basin (1994–2003) for Cd, Cr, Cu, Hg, Ni, Pb and Zn, *Sci. Total Environ.*, 375, 180–203, 2007.

Unifa: Les livraisons de fertilisants en France, campagne 2003–2004. Les chiffres-clés 2005, <http://www.unifa.fr>, Union des industries de la fertilisation, Paris, 2005.

## HESSD

4, 1795–1822, 2007

### Metal contamination budget at the river basin scale

L. Lestel et al.

Title Page

Abstract

Introduction

Conclusions

References

Tables

Figures

◀

▶

◀

▶

Back

Close

Full Screen / Esc

Printer-friendly Version

Interactive Discussion

## Metal contamination budget at the river basin scale

L. Lestel et al.

Title Page

Abstract

Introduction

Conclusions

References

Tables

Figures

◀

▶

◀

▶

Back

Close

Full Screen / Esc

Printer-friendly Version

Interactive Discussion

**Table 1.** Major data sources of metal flows (Pi) for material flow analysis (MFA) (see also Fig. 2).

	Type of flows	Data sources	Start of record	Data provider
P1	Import of ores and ingots	Mines yearbook	<1847	Ministry of Industries
P2/P3	Import/export of Me-containing goods	Yearbooks of imported/exported goods	>1950	Ministry of Finances (customs)
P4	Metal demand	Mines yearbook; Non-ferrous ores and metal yearbook	1816	Ministry of Agriculture, Industry and Public Works (19th century) and national federation of Non-ferrous metal industries (20th century)
P4a,d	Metal containing goods			Calculated from miscellaneous sources
P5	Collection of metals for recycling	Spots estimates	1990's	National Environmental Agency (ADEME)
P6	Scrap industry	Non-ferrous ores and metal yearbook	1940's	Non-ferrous metal industries national federation
P7	Metal-containing fertiliser inputs to soils	Land use/cover x fertilizer use	1980's	EU Corine Land Cover, Ministry of Agriculture
P8 <sub>B</sub>	Reuse of treated urban sludges	Direct survey before/after treatment x reuse statistics	1977	Paris megacity sanitary institution (SIAAP)
P9	Collection and incineration of municipal and industrial solid wastes	Annual collection rate x estimated metal content	1980's	ADEME
P10	Dredged river material	Direct survey of sediments before the dredging operation x dredging statistics	1990's	Seine River navigation Authority (SNS)

## Metal contamination budget at the river basin scale

L. Lestel et al.

Title Page

Abstract

Introduction

Conclusions

References

Tables

Figures

◀

▶

◀

▶

Back

Close

Full Screen / Esc

Printer-friendly Version

Interactive Discussion

**Table 2.** Major data sources for environmental contamination analysis (ECA) (transfers Tj) (Fig. 2).

	Fluxes	Type of data	Start of record	Data provider
T1	Atmospheric fallout	Daily to monthly fall-out survey at selected sites	1994	Academic publications (Azimi et al., 2003, 2005)
T2	Outputs from forested (T2F) and agricultural (T2A) catchments	Direct metal analysis of river sediment from forested and agricultural stream catchments x erosion rates		Academic publications (Grosbois et al., 2006)
T3	Natural river fluxes	Pristine headwaters inventories; sediment archives	1994	Academic publications (Grosbois et al., 2006)
T4	River basin output	River mouth survey (RNB national network)	1983	Seine Basin Authority; Ministry of Environment (DIREN de Bassin); Academic studies

## Metal contamination budget at the river basin scale

L. Lestel et al.

Title Page

Abstract

Introduction

Conclusions

References

Tables

Figures

◀

▶

◀

▶

Back

Close

Full Screen / Esc

Printer-friendly Version

Interactive Discussion

**Table 3.** Data sources for metal leaks to the environment (Li, Lj, see Fig. 2).

	Leaks	Type of data	Start of record	Data provider
L1/L2	Atmospheric metal emissions	Specific register of atmospheric emissions (metal section)	1990	CITEPA (founded by the Ministry of Environment)
L1	Industrial atmospheric emission	European pollutants emission register	2001	EPER, European Environmental Agency
L4	Release of treated wastewater to the river	Monthly surveys x water budgets	1977	Paris megacity Sanitation Institution (SIAAP)
L3 <sub>A</sub> /L5 <sup>(1)</sup>	Nominal industrial waste water production	Pollution tax register	1980's	Seine Basin Authority, AESN
L3 <sub>A</sub> /L5 <sup>(1)</sup>	Industrial waste water production	Auto control	1980's	Seine Basin Authority, AESN
L3 <sub>A</sub> /L5 <sup>(1)</sup>	Industrial waste water production	Voluntary industrial declaration procedure	2000's	Ministry of Environment (IREP national register)
L3 <sub>A</sub> /L5 <sup>(1)</sup>	Industrial waste water production	External control without notice	1990's	SATESE (Technical assistance service to sewage treatment plants)
L6	Metal in urban wastes	Direct surveys of untreated wastes and sludges	1977	Paris megacity Sanitation Institution (SIAAP)

(1) the leaks from industry to the river system (L3<sub>A</sub>+L5) are calculated or measured by different ways.

**Table 4.** Limitations of selected data sources for flux-flow analysis (Fig. 2).

Flows and fluxes	Space coverage (1)	Record frequency (2)	Space treatment (3)	Time treatment (4)	Data accessibility (5)	Data precision (6)	Remarks
P1, P2 Imports of metals and goods	N	Y	3	-	I to II	H	Needs to be disaggregated for each type of good
P4a Lead in TV set	N	M	2,3	D	V	M	Needs primary sources combination
P4d Leaded gasoline	N	Y	2,3	-	II or V	H to M	
P5 Recycled goods	N	M	3	D	I, V	L to M	
P8 <sub>p</sub> Sewage sludge	I	Y	1	-	III	H	Needs to be better localized
P10 Dredged material	B	M	-	A, B	III	M	Needs to be better localized
T1 Atmospheric fallout	S	S	1	A, B	IV	H	Very limited space cover
T2F Background level	B	-	-	-	IV	H	
T3, T4 Upper river fluxes	B	S	-	A	I	H to M	
L1, L2 Atmospheric emissions (CITEPA)	C, N	Y	3, 4	-	I	L to VL	Based on nominal emission rates
L1 Atmospheric emission (EPER)	I	Y	4	-	I	M to L	Improve frequency: possible bias in survey
L3 <sub>4</sub> , L5 Industrial wastes waters (AESN)	I	Y	4	B	II	L	Autocontrols mixed with random analyses (lost records)
L6 Urban wastewaters (SIAAP)	I	Y	4	-	III	H	SIAAP survey protocol to be generalized on basin
SA Agricultural soil storage	C	L	-	C	I to III	H	Database accessibility limited
SL Landfill storage	I, C	L	2, 4	C	II to III	L	Need for specific inventories
SU Storage in structures	I	L	2, 4	C	IV	L to VL	Very limited information
R4 Long term sediment archives	B	-	-	-	IV	H to M	Needs to be completed on subbasins

(1) Space coverage. N: national, B: basin and subbasins, C: county, S: station survey, I: individual (e.g. For each industry or city).

(2) Record frequency. Y: yearly, M: multiannual, S: seasonal to monthly, L: long term.

(3) Space treatment. Type 1: need for upscaling since data are available on very small territories, Type 2: need for downscaling (data available at very large territory), Type 3: need for boundaries adjustment (administration census different from hydrological limits), Type 4: need for completeness (missing data in inventories).

(4) Temporal treatment. Type A: need for temporal extrapolation (data available over short periods only), Type B: need for temporal interpolation (fragmented data), Type C: need for cumulated fluxes and stocks, Type D: need for gradual evolution (instead of stepwise).

(5) Data accessibility. Type I: downloadable computerized data, Type II: accessible non-computerized data, Type III: restricted access data (exchangeable, person to person connexion ...), Type IV: academic study without accessible database, Type V: combination of different sources with variable access.

(6) Data precision. VL (very low): L (low): M (medium): H (high).

Title Page

Abstract Introduction

Conclusions References

Tables Figures

◀ ▶

◀ ▶

Back Close

Full Screen / Esc

Printer-friendly Version

Interactive Discussion

**Metal contamination budget at the river basin scale**

L. Lestel et al.

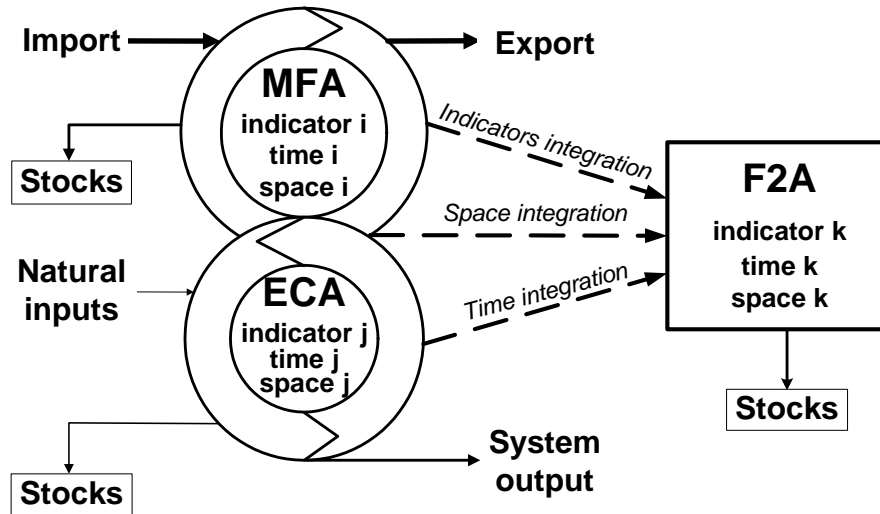

**Fig. 1.** The triple integration of material flow/contaminant fluxes analysis (F2A).

Title Page

Abstract Introduction

Conclusions References

Tables Figures

◀ ▶

◀ ▶

Back Close

Full Screen / Esc

Printer-friendly Version

Interactive Discussion

Metal contamination budget at the river basin scale

L. Lestel et al.

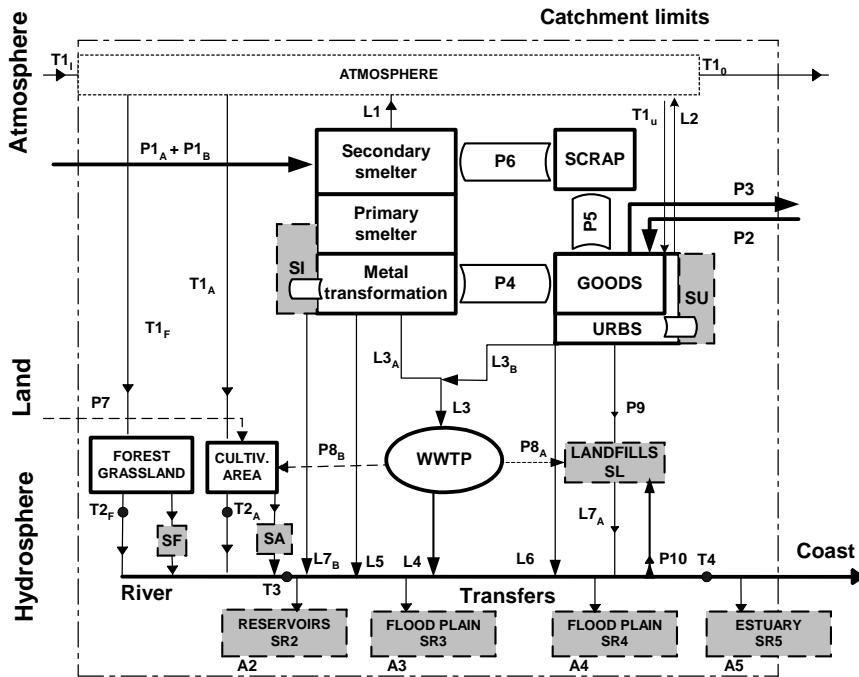

**Fig. 2.** Schematic sources, transfers, sinks of metals in a river catchment combined with metal uses, recycling and leaks in the anthroposphere. P1 to P10: circulation of metal products and goods. L1 to L7: leaks from the anthroposphere to the environment. T1 to T4: transfers. SA to SU: storage. A: sediment archives of past river contamination. Grey area: metal storage sites. (•): River stations. (WWTP): waste water treatment plants (see also Tables 1, 2, 3).

Title Page	
Abstract	Introduction
Conclusions	References
Tables	Figures
◀	▶
◀	▶
Back	Close
Full Screen / Esc	
Printer-friendly Version	
Interactive Discussion	



**Metal contamination budget at the river basin scale**

L. Lestel et al.

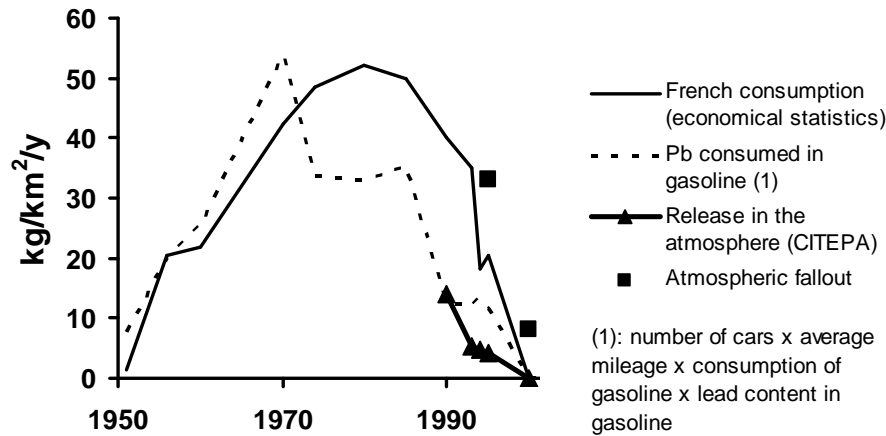

**Fig. 3.** Long term trend of leaded gasoline in atmosphere (flows/fluxes in kg/km<sup>2</sup>/y).

Title Page

Abstract

Introduction

Conclusions

References

Tables

Figures

◀

▶

◀

▶

Back

Close

Full Screen / Esc

Printer-friendly Version

Interactive Discussion

## Metal contamination budget at the river basin scale

L. Lestel et al.

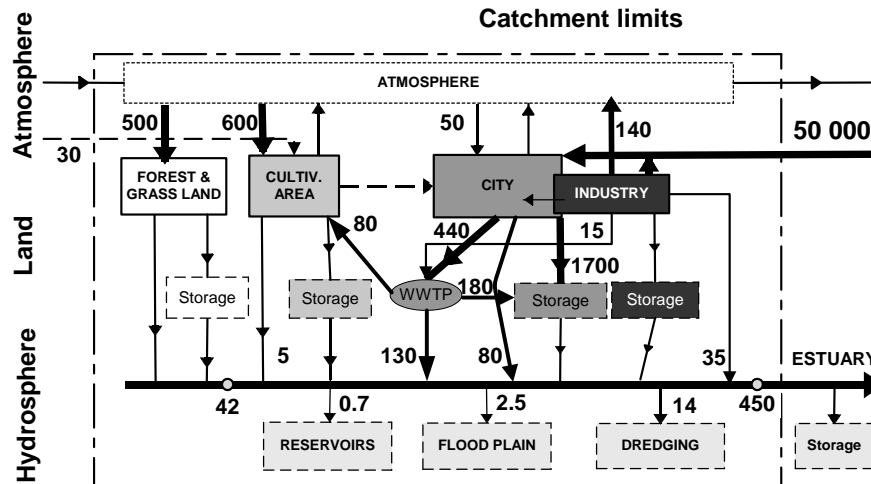

**Fig. 4.** Zinc budget in the Seine basin : mean fluxes and flows during the 1994–2003 period ( $\text{t y}^{-1}$ ) (data from Thévenot et al., 2007).

Title Page

Abstract Introduction

Conclusions References

Tables Figures

◀ ▶

◀ ▶

Back Close

Full Screen / Esc

Printer-friendly Version

Interactive Discussion

**Metal contamination budget at the river basin scale**

L. Lestel et al.

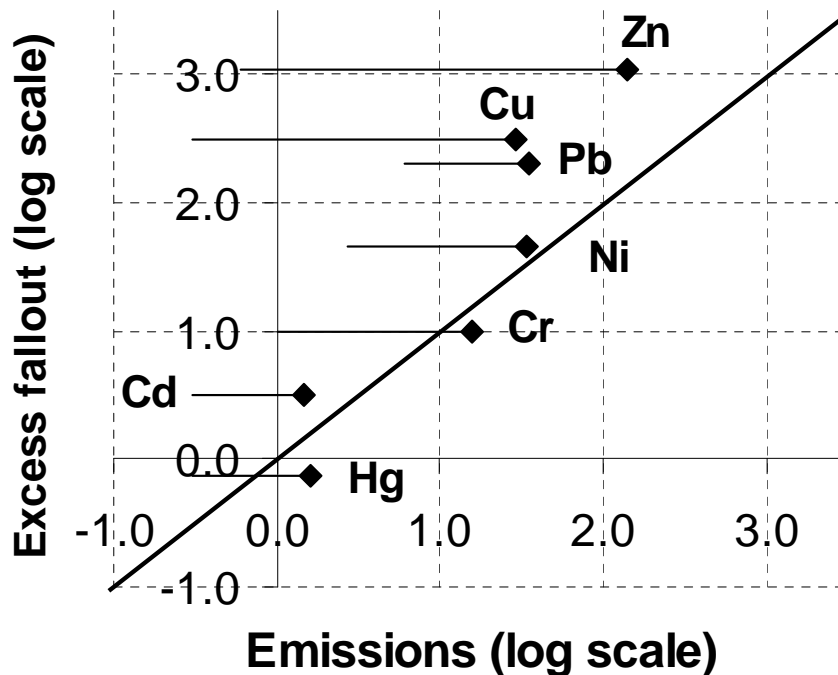

**Fig. 5.** Comparison of measured atmospheric fallout, corrected from soil dust resuspension, to declared and aggregated atmospheric emissions over the whole Seine River basin ( $\text{t y}^{-1}$ ) (bars represent emission uncertainties) (data from Thévenot et al., 2007).

Title Page

Abstract Introduction

Conclusions References

Tables Figures

◀ ▶

◀ ▶

Back Close

Full Screen / Esc

Printer-friendly Version

Interactive Discussion

## Metal contamination budget at the river basin scale

L. Lestel et al.

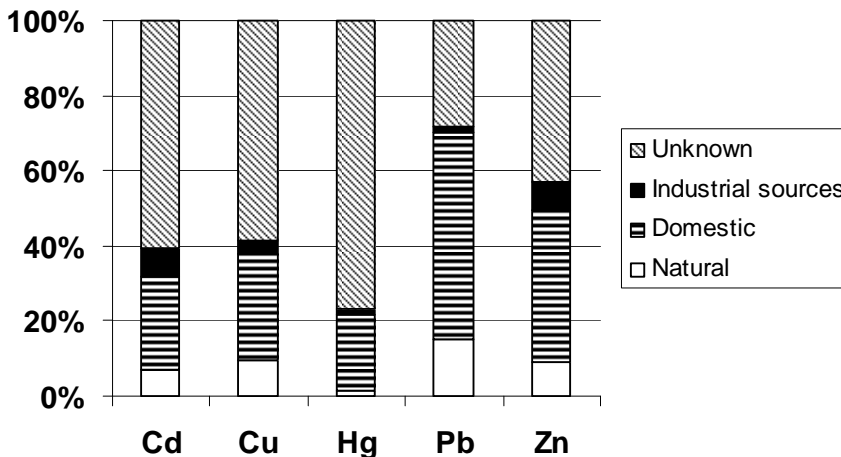

**Fig. 6.** Percentage of metal sources Cd, Cu, Hg, Pb, Zn, in total export at the river mouth station Poses: (i) release from erosion (“natural”), (ii) calculated domestic release (“domestic”) and (iii) directly measured or declared direct release of industrial waste water into rivers, (iv) unknown sources.

Title Page

Abstract

Introduction

Conclusions

References

Tables

Figures

◀

▶

◀

▶

Back

Close

Full Screen / Esc

Printer-friendly Version

Interactive Discussion

**Metal contamination budget at the river basin scale**

L. Lestel et al.

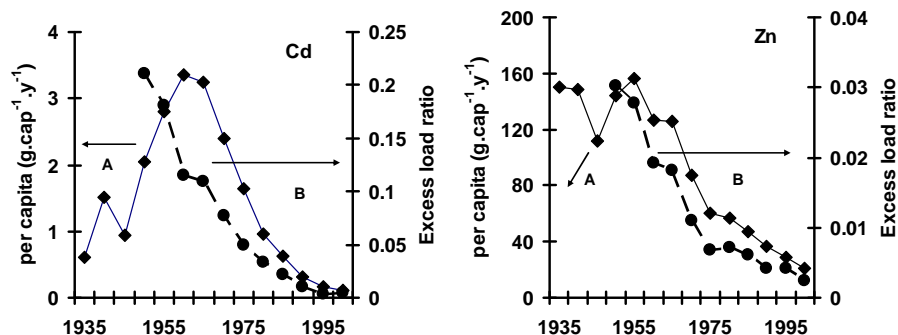

**Fig. 7.** Integrated F2A indicators for Cd (left) and Zn (right). A: Annual average river excess metal load prorated to the Seine basin population ( $\text{g cap}^{-1} \text{y}^{-1}$ ). B: Annual export by the river/total metal demand in the catchment (leakage ratio) (data from Meybeck et al., 2007).

Title Page

Abstract

Introduction

Conclusions

References

Tables

Figures

◀

▶

◀

▶

Back

Close

Full Screen / Esc

Printer-friendly Version

Interactive Discussion