

RESEARCH ARTICLE

OPEN ACCESS

Modeling and design of a combined transverse and axial flow threshing unit for rice harvesters

Zhong Tang^{1*}, Yaoming Li¹, Lizhang Xu¹ and Francis Kumi^{1,2}

¹ Key Laboratory of Modern Agricultural Equipment and Technology, Jiangsu University, Jiangsu Province, Zhenjiang, Jiangsu, China. ² University of Cape Coast, School of Agriculture, Department of Agricultural Engineering, Cape Coast, Ghana

Abstract

The thorough investigation of both grain threshing and grain separating processes is a crucial consideration for effective structural design and variable optimization of the tangential flow threshing cylinder and longitudinal axial flow threshing cylinder composite units (TLFC unit) of small and medium-sized (SME) combine harvesters. The objective of this paper was to obtain the structural variables of a TLFC unit by theoretical modeling and experimentation on a tangential flow threshing cylinder unit (TFC unit) and longitudinal axial flow threshing cylinder unit (LFC unit). Threshing and separation equations for five types of threshing teeth (knife bar, trapezoidal tooth, spike tooth, rasp bar, and rectangular bar), were obtained using probability theory. Results demonstrated that the threshing and separation capacity of the knife bar TFC unit was stronger than the other threshing teeth. The length of the LFC unit was divided into four sections, with helical blades on the first section (0-0.17 m), the spike tooth on the second section (0.17-1.48 m), the trapezoidal tooth on the third section (1.48-2.91 m), and the discharge plate on the fourth section (2.91-3.35 m). Test results showed an un-threshed grain rate of 0.243%, un-separated grain rate of 0.346%, and broken grain rate of 0.184%. Evidenced by these results, threshing and separation performance is significantly improved by analyzing and optimizing the structure and variables of a TLFC unit. The results of this research can be used to successfully design the TLFC unit of small and medium-sized (SME) combine harvesters.

Additional key words: combine harvester; threshing and separation; tangential flow threshing cylinder; longitudinal axial flow threshing cylinder; mathematical model.

Introduction

Three types of threshing and separation units have reached common use over the last century of innovation and development of combine harvesters within the agricultural industry. The first is a single or multiple transversely-arranged threshing cylinder unit (or tangential flow threshing cylinder, referred to as a TFC unit). The second is a single or multiple vertically

arranged threshing cylinder unit (or longitudinal axial flow threshing cylinder, referred to as an LFC unit). The third type is the combined structure of transversely-arranged threshing cylinders and vertical arranged threshing cylinders. The combined threshing and separation structure of single transversely-arranged threshing cylinders and single vertically-arranged threshing cylinders (the TLFC unit) was proven suitable for Asian SME combine harvesters, due to its simple structure,

* Corresponding author: tangzhong2012@gmail.com

Received: 14-04-14. Accepted: 17-11-14.

This work has one supplementary figure that does not appear in the printed article but that accompanies the paper online.

Abbreviations used: LFC (longitudinal axial flow threshing cylinder); MOG (material other than grain); SME (small and medium-sized); TFC (tangential flow threshing cylinder); TLFC (tangential flow threshing cylinder and longitudinal axial flow threshing cylinder composite). **Parameters:** k (primary threshing coefficient); l (arc length of the grid concave); s_i (un-separated grain); s_j (un-threshed grain); q_j (total grain rate); u (primary separation coefficient); y (rate of accumulative threshed grain); z (rate of accumulative separated grain); λ (re-threshed coefficient); β (re-separated coefficient).

small size, and flexibility (Xu *et al.*, 2013, 2014). As of now, the TLFC unit is the primary mechanical structure of combine harvesters in the Asian region.

The process of threshing and separating grain from rice panicle heads by high-speed rotation threshing cylinder is traditionally quite complex (Gregory, 1988; Gasparetto *et al.*, 1989). A process whereby grain is effectively threshed from panicle heads and separated through a grid concave is crucial to the successful design and performance variables selection of a TLFC unit. Many previous researchers and developers have explored the threshing process as applied to combine harvesters, as it can assist in the prediction and analysis of grain loss.

In 1979, for example, researchers deduced and developed a rice threshing and separation model based on field trials and performance tests of 224 groups (Kumar & Goss, 1979). A few years later, Huynh *et al.* (1982) further indicated that the probability distribution of grain threshing and separation is an index of decreasing function with threshing time. These results became the key design factors of threshing and separation devices. In another study, the time of grain separation through the grid concave was measured with a centrifugal force field on a special threshing and separation test apparatus. Resistance analysis of the distribution of rice stalks was obtained, then, by solving relevant equations of the motion of grains (Long, 1982). Distribution characteristics of the mixture as separated through grid concave were also investigated. Based on these characteristics in total, Ndirika (1994) and Nwuba & Braide (1994) indicated that cleaning performance was affected by the composition and distribution of a mixture.

Equipment that monitors the grain threshing process was then manufactured for further study. Exploration of specific functions of the threshing and separation process was performed based on different properties of different crops with different feeding rates (Maertens & Baerdemaeker, 2003). A mathematical model of the threshing and separation of a B90 longitudinal axial flow threshing cylinder was deduced and developed, and the process controlled by changing its operating variables (Valentin *et al.*, 2009). Osueke *et al.* (2011) determined an equation that describes the threshing and separation process based on multiple factors including the rotation of the cylinder, feeding rate, threshing gap, threshing force, and material flow.

To summarize, there are two main categories of threshing and separation models: regression models,

which do not describe the threshing and separation process but instead summarize and build statistics of test results; and theoretical models, which create assumptions and simplifications of the threshing and separation process, based on a theoretical basis of the threshing and separation mechanism. Regression models are more easily determined, as they are only applicable to specific test apparatus. Theoretical models, conversely, can be used to design several threshing and separation units, but these theoretical models are very rare. Also, though widely accepted, some theoretical models are not completely correct.

This study attempts to deduce and develop theoretical models of the threshing and separation process of both a TFC unit and LFC unit for the threshing teeth of a knife bar, trapezoidal tooth, spike tooth, rasp bar and rectangular bar. A TLFC unit will be design, based on experimentation and theoretical calculations. The favorable performance will be verified by investigating a series of rice harvesting experiments.

Material and methods

Combined transverse and axial flow threshing unit

The SME combine harvester with TLFC unit was typical in structure, consisting primarily of a reel cutting table, control panel, feeder conveyor, tangential flow threshing cylinder, vibrating and cleaning sieve, longitudinal axial flow threshing cylinder, transmission, engine, and crawler chassis (Klinner *et al.*, 1987; Tado *et al.*, 1998; Golpira, 2013). The main structure of the SME combine harvester used was as shown in Fig. 1.

The TFC unit was laid out horizontally, perpendicular to the longitudinal axial forward direction of the combine harvester. The LFC unit had a longitudinal axial layout, parallel to the longitudinal axial forward direction of the combine harvester. The axis of the LFC unit corresponded to the cross-section centerline of the TFC unit. The main structure of the TLFC unit was as shown in Fig. 2.

The diameter of the TFC unit was 490 mm and its length was 1125 mm. The threshing teeth were arranged in a four head spiral, and bar spacing between any two adjacent threshing bars was 55 mm. The height of the threshing tooth was 70 mm. The concave clearance at the entrance was 40 mm and 30 mm at the output

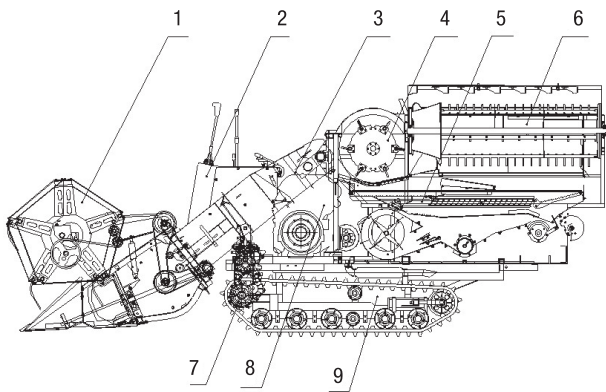

Figure 1. Small and medium-sized (SME) combine harvester of TLFC unit: 1, reel cutting table; 2, control panel; 3, feeder conveyor; 4, tangential flow threshing cylinder (TFC unit); 5, vibrating and cleaning sieve; 6, longitudinal axial flow threshing cylinder (LFC unit); 7, transmission; 8, engine; 9, crawler chassis. The copyright of this SME combine harvester has been applied for invention patents in China.

concave clearance. The speed of the TFC unit was set to 24.47 m s^{-1} . There were four kinds of tangential threshing tooth: the knife bar, rectangular bar, spike tooth, and rasp bar. The four threshing teeth on the TFC unit were as shown in Fig. 3.

The diameter of the LFC unit was 500 mm, and its total length was 3390 mm. There were helical blades 170 mm in length in front of the LFC unit, 2740 mm trapezoidal teeth within its center, and a discharge plate

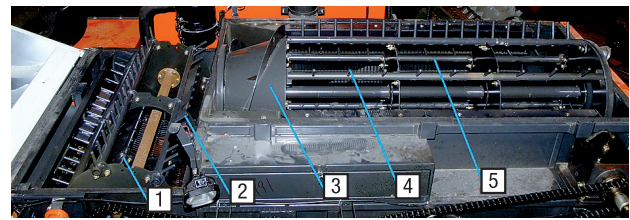

Figure 2. Combined transverse and axial flow threshing unit: 1, TFC unit; 2, tangential flow threshing tooth; 3, spiral feed head; 4, longitudinal axial flow threshing tooth; 5, LFC unit.

480 mm in length at the rear of the unit. The coordinate origin, (the starting point of grain separation,) was a point 960 mm from the top of the unit. The concave clearance of the LFC unit was 30 mm, and the concave wrap angle was 180° . Six lines of threshing bars were evenly arranged on the circumference of the LFC unit, and the space between any two adjacent threshing bars was 150 mm. The LFC unit speed was 21.95 m s^{-1} . There were four kinds of LFC unit threshing tooth: the trapezoidal tooth, rectangular bar, spike tooth, and rasp bar. The spike tooth on the LFC unit was as shown in Fig. 4.

Rice cultivar and test conditions

Experiments were performed with rows of rice (*Oryza sativa* L.), individually spaced 15 cm apart. The rice

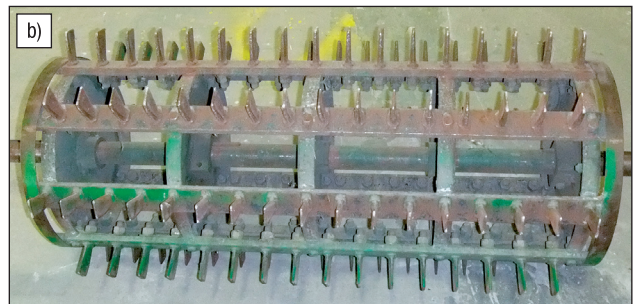
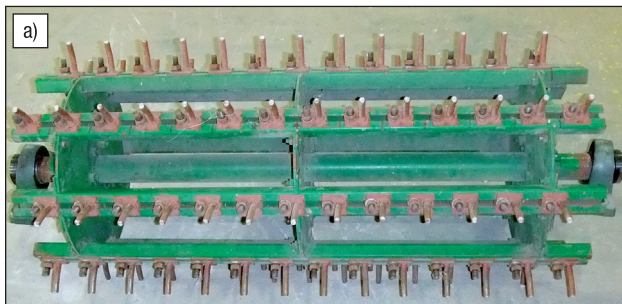

Figure 3. Structural diagram of four threshing tooth TFC unit: (a) spike tooth, (b) knife bar, (c) rectangular bar, and (d) rasp bar.

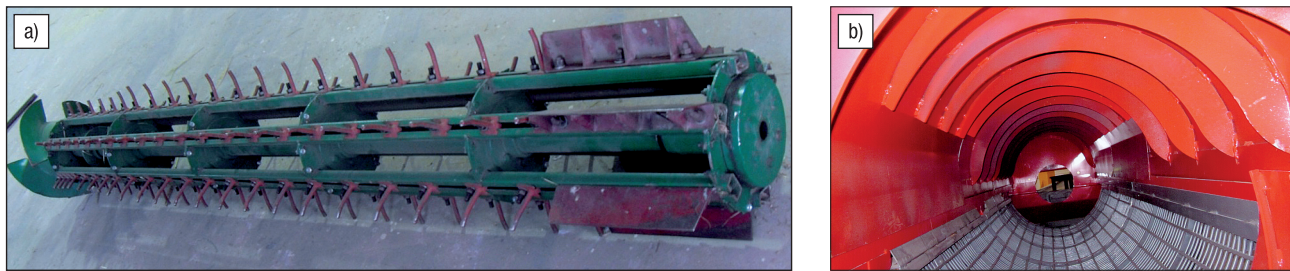

Figure 4. Schematic diagram of LFC unit and threshing and separation cell: (a) spike tooth LFC unit, (b) threshing and separation cell.

cultivar used in this study was *Wu '2645'*. The average grain output was 9745 kg hm^{-2} , which is typical of the Jiangsu area. Suppl. Fig. S1 [pdf online] shows the physical and morphological appearance of the rice.

Freshly-cut rice (84 g) was placed on a $12 \text{ m} \times 1 \text{ m}$ conveyer belt with a liner speed of 1 m s^{-1} and feeding rate of 7 kg s^{-1} over a feeding time of 12 s. The weight of the grains and the mixture was obtained manually. After the rice was threshed and the grain was separated through the grid concave (forming “collected grain”), a few grains remained that were not threshed (un-threshed grain), some that had not separated from the rice panicle (un-separated grain), and some that had mixed into the collected grain and been crushed by the threshing process (broken grain) - all of these combined formed the “total grain”. The mass of the grains and the material other than grain (MOG) were weighed manually (using an electronic scale, JY60001, Shanghai Fangrui Instrument Co., Ltd.) The measurement accuracy of the electronic scale was $\pm 0.1 \text{ g}$, and its maximum range was 6 kg. The un-threshed grain rate, un-separated grain rate, and broken grain rate were a mass percentage of the un-threshed grain, un-separated grain, and broken grain as they correspond to the total grain.

Statistical analysis

Means \pm standard errors (SE) were calculated for each experiment with the same variables ($n = 5$). The mean data were analyzed statistically using a factorial design in SPSS software (version 13.0, SPSS Inc., CA, USA), and the mean results were compared using a least significant difference (LSD) post-hoc test at the 5% significance level ($p < 0.05$). The grain threshing and separation probability density curves of both the TFC unit and LFC unit were drawn using MATLAB 7.6 software.

Grain threshing and separation model development

The threshing and separation method described in this paper was validated through a series of experiments, for the TFC unit and LFC unit both. In the threshing unit that consisted of threshing cylinder, grid concave and cylinder cover, the grains were removed from the ears and separated, for the most part, through the grid concave and into the grain box.

To model the grain threshing and separation process, the following general assumptions of Miu (1994, 1995, 1999, 2002), Miu *et al.* (1997, 1998a,b) and Miu & Kutzbach (2000) were taken into consideration: (a) the material throughput is constant, where material moves through the threshing space as a continuous stream; (b) the material to be processed is homogeneous, *i.e.*, the ears are uniformly distributed within the straw mass; (c) in the TFC unit, the material is homogeneous in any cross-section (perpendicular on the longitudinal axis direction), of the threshing space; (d) in the LFC unit, the material is homogeneous in any cross section of the threshing space; (e) the mass of the material is continuously distributed throughout the threshing space and its volumetric density is a continuous function of position and time.

Grain threshing and separation model of TFC unit

Based on these assumptions, the grain threshing and separation of the TFC unit was as follows (Hamdy *et al.*, 1966; Alferov & Braginec, 1972; Trollope, 1982; Segarceanu *et al.*, 1983):

$$\frac{dy}{dl} = k(1 - y) \quad [1]$$

$$\frac{dz}{dl} = u(y - z) \quad [2]$$

where y is the rate of accumulative threshed grain; z is the rate of accumulative separated grain; l is the arc length of the grid concave. Coefficients k (primary threshing coefficient) and u (primary separation coefficient) were affected by the material properties, structural variables, and operating variables of the threshing unit.

When the rice is at the entrance of the TFC unit, $l = 0$. Assuming the threshed grain = 0, the y is also zero. Thus, Eq. [1] can be solved:

$$y = 1 - e^{-kl} \quad [3]$$

When the rice is at the entrance of the TFC unit, $l = 0$. Assuming the separated grain = 0, the z is also zero. Thus, according to Eq. [3], Eq. [2] can be solved:

$$\frac{dz}{dl} + uz = u(1 - e^{-kl}) \quad [4]$$

Eq. [4] is a non-homogeneous linear equation. In order to obtain the general solution of Eq. [4], both a general answer of a homogeneous version of Eq. [4] and a particular answer of a non-homogeneous version must be solved. The homogeneous equation of Eq. [4] is as follows:

$$\frac{dz}{dl} + uz = 0 \quad [5]$$

The solution to the homogeneous equation of Eq. [4] is obtained by:

$$z = C(l)e^{-ul} \quad [6]$$

where $C(l)$ is the function of the arc length of grid concave l . In order to express $C(l)$, Eq. [6] must be solved first:

$$\frac{dz}{dl} = C'(l)e^{-ul} - uC(l)e^{-ul} \quad [7]$$

By substituting Eq. [7] and Eq. [6] for Eq. [4], Eq. [4] can then be solved:

$$C'(l) = ue^{ul} - ue^{(u-k)l} \quad [8]$$

Eq. [8] is as follows:

$$C(l) = e^{ul} - \frac{u}{u-k} e^{(u-k)l} + C_0 \quad [9]$$

where C_0 is a coefficient. Both the general and particular versions of Eq. [4] combined can be written as follows:

$$z = e^{-ul} \left[e^{ul} - \frac{u}{u-k} e^{(u-k)l} + C_0 \right] \quad [10]$$

When the rice is at the entrance of the TFC unit, $l = 0$. Assuming that the separated grain was zero, $z = 0$. So, the Eq. [10] could be solved as

$$z = 1 + \frac{u}{k-u} e^{-kl} - \frac{k}{k-u} e^{-ul} \quad [11]$$

According to Eq. [1] and Eq. [2], Eq. [4] can be expressed as:

$$\frac{dz}{dl} = u(1 - e^{-kl} - z) \quad [12]$$

Eq. [12] is then written as:

$$\frac{dz}{dl(1-z)} = u \left(1 - \frac{e^{-kl}}{1-z} \right) = u - \frac{u}{1-z} e^{-kl} \quad [13]$$

Because the rate of accumulative threshed grain y was greater than the rate of accumulative separated grain z , k was far greater than l (Tang *et al.*, 1989; Miu & Kutzbach, 2000). When the arc length of the grid concave l is over 300 mm, $e^{-kl} \sim 0$ and could be ignored. According to Eq. [11] and Eq. [13], the separated experimental coefficients u can be written as:

$$u = -\frac{\ln(1-z)}{l} \quad [14]$$

The threshed experimental coefficients k is provided by Eq. [15]:

$$k = \frac{1+uz}{z+e^{-ul}} \quad [15]$$

If $\frac{d}{dl} \left(\frac{dz}{dl} \right) = 0$, then $\frac{dz}{dl}$ is the maximum. Based on

Eq. [12], the minimum arc length of grid concave l_m is expressed:

$$l_m = \frac{\ln \frac{k}{k-u}}{k-u} \quad [16]$$

When the difference between the rate of threshed grain y and the rate of separated grain z was at its maximum, the differential result of dz/dl was maximum, and l_m was the minimum arc length. When $l < l_m$, the threshed rate capacity was much greater than the separated rate capacity, and the result of $(y-z)$ grew larger. The threshing and separating capability of the TFC unit was then unstable and unreliable. When $l > l_m$, the threshed rate capacity was much lower than the separated rate capacity, and the result of $(y-z)$ shrank. The threshing and separating capability of the TFC unit was then stable and reliable.

Grain threshing and separation model of LFC unit

The straw was threshed and separated preliminarily by the TFC unit. Next, the straw was transported to the LFC unit to be threshed and separated again. The mixture in the LFC unit contained both un-threshed grain (s_j) and un-separated grain (s_i). The total grain rate in the LFC unit is then q_j , described as:

$$q_j = s_i + s_j \tag{17}$$

Assuming that δx is an arbitrary infinitely small distance, which is one point of the LFC, λ is the re-threshed coefficient, and β is the re-separated coefficient; i and j are natural numbers ($i = 0, 1, 2, 3, \dots; j = 1, 2, 3, \dots$). Threshed grain probability density $f(x)$ is as described by Miu & Kutzbach (2000, 2008a,b). We then obtain:

$$\frac{f(x)}{[1 - F(x)]} = \lambda \tag{18}$$

where x is one point of the LFC, and $F(x)$ is the cumulative total rate of threshed grain through the concave grid.

Eq. [18] is then written as:

$$F(x) = \int_0^x f(\zeta) d\zeta \tag{19}$$

where ζ is a variable. Eq. [18] and Eq. [19] can be merged:

$$\frac{dF(x)}{1 - F(x)} = \lambda dx \tag{20}$$

The cumulative total rate of threshed grain from the concave grid of the LFC is:

$$F(x) = 1 - e^{-\lambda x} \tag{21}$$

Threshed grain probability density is expressed as:

$$f(x) = s_j \lambda e^{-\lambda x} \tag{22}$$

Similarly, the separated grain probability density is expressed as:

$$g(x) = \beta e^{-\beta x} \tag{23}$$

The total rate of un-threshed grain can be described as follows:

$$s_n(x) = s_j (1 - \int_0^x \lambda e^{-\lambda \zeta} d\zeta) = s_j e^{-\lambda x} \tag{24}$$

where $x = L$, and L is the effective threshing and separation length of the LFC unit. Thus, the un-threshed grain discharged from the tail hole of the LFC unit is

considered lost grain. The un-threshed grain rate $S_n(L)$ is expressed:

$$s_n(L) = s_j e^{-\lambda L} \tag{25}$$

According to probability theory, independent constant random variables with the densities $f(x)$ and $S_n(x)$ for sum variables convolute Eq. [26], with these density functions $h'(x)$:

$$h'(x) = f(\xi) * g(x - \xi) = \int_0^x f(x) g(x - \xi) d\xi \tag{26}$$

where ξ is a variable. Based on Eq. [26], Eq. [27] is written:

$$h'(x) = \frac{\lambda \beta}{\lambda - \beta} (e^{-\beta x} - e^{-\lambda x}) \tag{27}$$

The grain separation probability density $h(x)$ is expressed as:

$$h(x) = s_j h'(x) + s_i g(x) = s_j \frac{\lambda \beta}{\lambda - \beta} (e^{-\beta x} - e^{-\lambda x}) + s_i \beta e^{-\beta x} \tag{28}$$

The rate of cumulative separated grain through the LFC unit's concave grid is written:

$$H(x) = s_j \frac{\beta e^{-\lambda x} - \lambda e^{-\beta x}}{\lambda - \beta} + s_j + s_i (1 - e^{-\beta x}) \tag{29}$$

In every cross-section of the LFC unit at a current position x of the threshing length, the mass balance for grain can be obtained:

$$H(x) + s_n(x) + s_f(x) = q_j \tag{30}$$

To this effect, the total rate of un-separated grain in the LFC unit is obtained:

$$s_f(x) = q_j - H_j(x) - s_n(x) \tag{31}$$

where $x = L$, and the un-separated grain discharged from the tail hole of the LFC unit is lost grain. The un-separated grain rate of the LFC unit is expressed:

$$s_f(L) = s_i e^{-\beta L} - s_j (e^{-\lambda L} + \frac{\beta e^{-\lambda L} - \lambda e^{-\beta L}}{\lambda - \beta}) \tag{32}$$

Results

Threshing and separation test of TFC unit

Crop properties relevant to harvesting were measured during trials (see Table 1). Table 2 shows the rate

Table 1. Physical properties of rice during harvest. The data are shown as means ± standard errors (SE) ($n = 5$)

Variable	Mean ± SE
Grain weight per 1000 grains (g)	26.80 ± 1.12
Grain moisture content (% w.b.)	22.56 ± 1.02
Stalks moisture content (% w.b.)	65.46 ± 2.04
Plant height (mm)	900 ± 9.00
Ratio Grain: Material other than grain	2.25 ± 0.08
Spike length (mm)	166 ± 11.00

w.b.= wet basis.

Based on the rate of cumulative threshed grain y and separated grain z , primary separated coefficient u , and primary threshing coefficient k can be calculated using Eq. [14] and Eq. [15], respectively. The rate of cumulative threshed grain y can also be obtained using Eq. [3]. The minimum arc length of grid concave l_m can be determined using Eq. [16]. All the calculation results are shown in Table 2. In the TFC unit, y and z were a function of l . Assuming that $k = 2, 2.5, 3, 3.5,$ and 4 m^{-1} (these scopes represent the test values), $u = 1, 1.5, 2, 2.5,$ and 3 m^{-1} (again, because these scopes were test

Table 2. Coefficients and parameters of primary threshing and separation using different threshing teeth

Coefficients and parameters	Threshing teeth of TFC unit			
	Spike tooth	Knife bar	Rectangular bar	Rasp bar
Arc length of grid concave l (mm)	676.67	676.67	676.67	676.67
Rate of accumulative separation grain z (%)	44.76	47.71	41.41	46.32
Rate of accumulative threshing grain y (%)	85.04	87.04	82.33	86.14
Primary separation coefficient u (m^{-1})	1.83	1.92	1.74	1.88
Primary threshing coefficient k (m^{-1})	2.81	3.02	2.56	2.92
Minimum arc length l_m (mm)	437.74	411.94	470.34	423.78

Table 3. The primary threshed coefficient k , primary separated coefficient u , cumulative threshed grain rate y , and cumulative separated grain rate z

No.	k (m^{-1})	y (%)	u (m^{-1})	z (%)
1	2	74.16	1	24.18
2	2.5	81.58	1.5	37.03
3	3	86.87	2	48.75
4	3.5	90.64	2.5	58.94
5	4	93.32	3	67.49
6	3	86.87	1	30.32
7	3	86.87	1.5	40.65
8	3	86.87	2	48.75
9	3	86.87	2.5	55.14
10	3	86.87	3.1	61.09
11	2	74.16	2	40.35
12	2.5	81.58	2	44.50
13	3	86.87	2	48.75
14	3.5	90.64	2	52.20
15	4	93.32	2	55.00

k and u were based on the test values; y and z were calculated using Eqs. [3] and [11].

of separated grain z measured using the four different types of tangential flow threshing teeth (knife bar, rectangular bar, spike tooth and rasp bar).

values), y and z were calculated. The results are shown in Table 3. The rate of accumulative threshed grain y and the rate of accumulative separated grain z were then drawn using MATLAB software. The results are shown in Fig. 5.

Threshing and separation test of LFC unit

The rice straw was first threshed and separated preliminarily by the TFC unit. Next, the straw with grain was moved to the LFC unit to be threshed and separated again. The un-threshed grains needed to be re-threshed, and the un-separated grain and threshed grain needed to be re-separated.

The knife bar was used in the TFC unit. The trapezoidal tooth, rectangular bar, spike tooth, and rasp bar were installed, respectively, in the LFC unit to perform the threshing and separation tests. The separated grains from the LFC unit were divided into 13 parts, perpendicular to the axial direction. The percentage of the total grain in every part, the un-threshed grain rate, and the un-separated grain rate were measured for the four longitudinal axial flow threshing teeth. All the test results are shown in Table 4. The re-threshing coeffi-

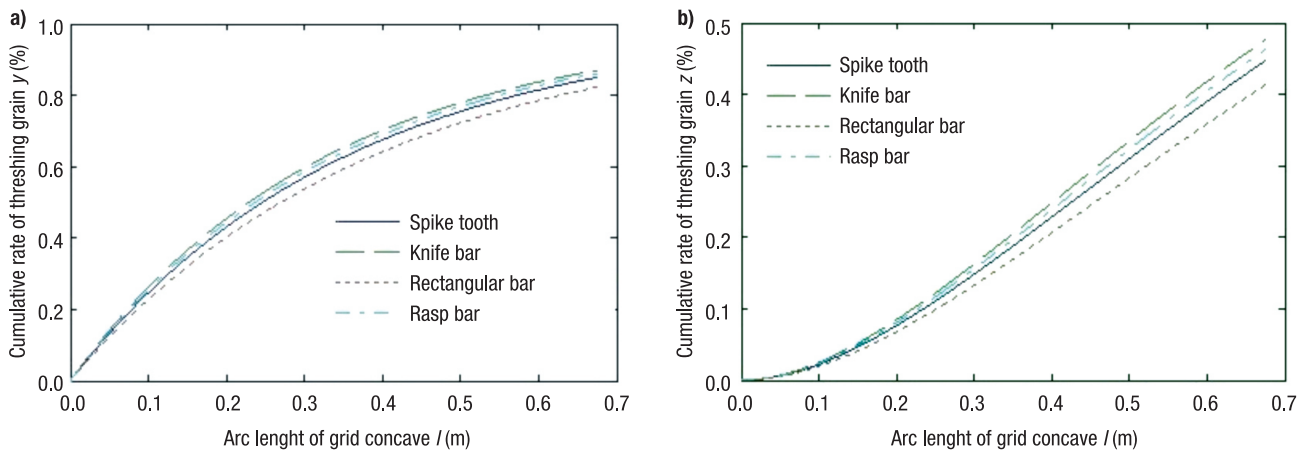

Figure 5. Cumulative threshing (a) and separating (b) rates of the TFC unit with different threshing bars.

Table 4. Accumulative separation grain percentages; means \pm standard errors (SE) under LFC unit ($n = 5$)

Packet sequence number	Rectangular bar	Rasp bar	Spike tooth	Trapezoidal tooth
1	6.19 \pm 0.38	4.81 \pm 0.32	4.67 \pm 0.29	5.40 \pm 0.28
2	9.91 \pm 0.87	13.21 \pm 0.67	14.55 \pm 0.62	10.66 \pm 0.74
3	11.42 \pm 1.45	11.29 \pm 1.23	12.75 \pm 1.06	14.01 \pm 1.36
4	6.59 \pm 0.32	5.51 \pm 0.32	5.81 \pm 0.29	6.56 \pm 0.27
5	5.51 \pm 0.27	4.67 \pm 0.23	5.13 \pm 0.22	5.46 \pm 0.28
6	3.40 \pm 0.24	2.87 \pm 0.26	3.10 \pm 0.23	3.22 \pm 0.19
7	2.40 \pm 0.23	2.04 \pm 0.17	1.90 \pm 0.13	2.34 \pm 0.26
8	1.94 \pm 0.21	2.28 \pm 0.23	1.33 \pm 0.22	1.34 \pm 0.22
9	1.50 \pm 0.17	1.57 \pm 0.16	0.86 \pm 0.18	1.10 \pm 0.23
10	1.13 \pm 0.16	1.14 \pm 0.16	0.72 \pm 0.12	0.63 \pm 0.18
11	0.91 \pm 0.09	0.77 \pm 0.09	0.58 \pm 0.07	0.43 \pm 0.12
12	0.66 \pm 0.04	0.62 \pm 0.03	0.28 \pm 0.04	0.32 \pm 0.02
13	0.19 \pm 0.01	0.47 \pm 0.04	0.16 \pm 0.04	0.22 \pm 0.02
Un-separated rate (%)	0.46 \pm 0.04	0.91 \pm 0.05	0.44 \pm 0.04	0.58 \pm 0.03
Un-threshed rate (%)	0.08 \pm 0.01	0.14 \pm 0.01	0.02 \pm 0.01	0.04 \pm 0.01

Table 5. Threshing and separation coefficient of LFC unit

Parameters	Rectangular bar	Rasp bar	Spike tooth	Trapezoidal tooth
Un-threshed grain rate (%)	0.08	0.14	0.02	0.04
Un-separated grain rate (%)	0.46	0.91	0.44	0.58
Re-threshing coefficient λ (m^{-1})	2.59	2.31	3.31	2.95
Re-separation coefficient β (m^{-1})	2.87	2.43	2.71	2.60

cient λ was then able to be obtained using Eq. [22], and the re-separation coefficient β could be obtained using Eq. [23]. The results were as shown in Table 5. The threshing probability density equation $f(x)$ of the LFC unit and separation probability density equation

$h(x)$ of the LFC unit were drawn using MATLAB. The results are shown in Fig. 6.

Based on the above test results, the composite structure of the LFC unit with spike tooth and trapezoidal tooth is shown in Fig. 7. Freshly-cut rice straw was

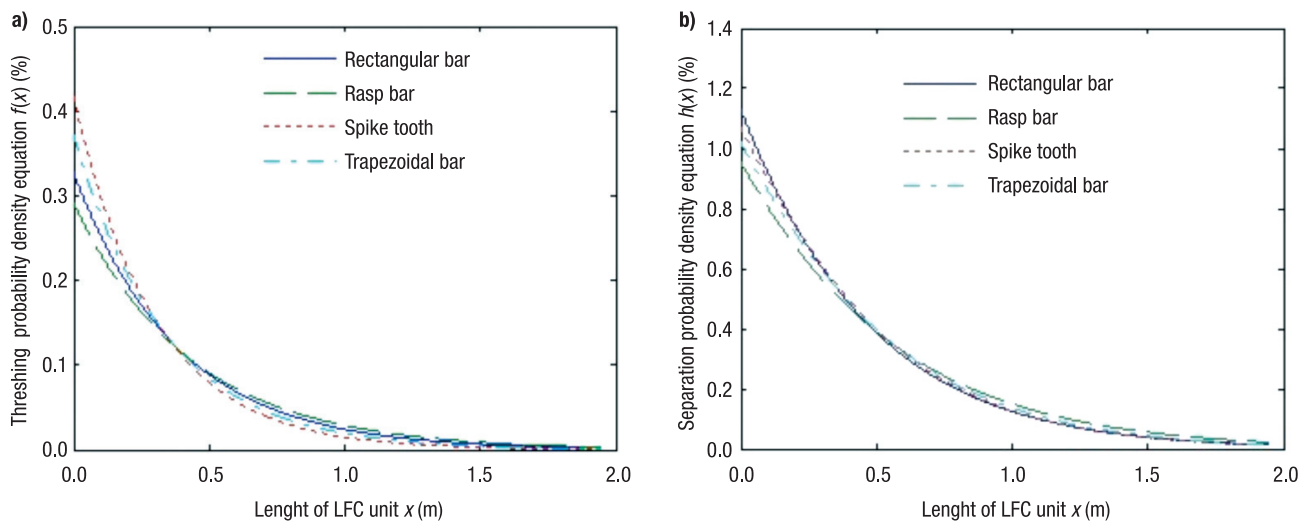

Figure 6. Grain threshing (a) and separation (b) probabilities density curves of the LFC unit.



Figure 7. Composite structure of the LFC unit with both spike and trapezoidal teeth.

used for testing purposes. At a feeding rate of 7 kg s^{-1} , the un-threshed grain rate was 0.243%, the un-separated grain rate was 0.346%, and the broken grain rate was 0.184%.

Discussion

Grain primary threshing and separation performance of TFC unit

Miu (1994, 1995) previously developed a similar mathematical model for grain threshing and separation. The model is universal, as it was proven valid both for TFC units and LFC units with different crops (Miu, 2002). The threshing unit is composed of a cylinder, a concave, and cages/grates, which detach grains from ears and separates most of them through the concave and grate openings. These mathematical models, however, involve axial flow threshing cylinders with either

tangential flow feeding direction or longitudinal flow feeding direction - dissimilar to the TFC unit and LFC unit studied here. In this paper, these methods were modified to explore the threshing and separation mold of the TFC unit and LFC unit we used.

As shown in Table 2, the test results demonstrated that the threshed and separated capacity of the knife bar in the TFC unit was stronger than any other threshing teeth. The maximum primary threshing rate of the TFC unit's knife bar was 87.04%, and the maximum primary separation rate was 47.71%. The above test results, again, were in accordance with previous studies conducted by Tang *et al.* (2011). In order to ensure that the separated capacity was stronger than threshed capacity of the knife bar in the TFC unit, the minimum arc length of the grid concave was set to 411.90 mm. After being threshed and separated by the TFC unit, the mixture in the LFC unit contained both un-threshed grain and un-separated grain. The un-threshed grain rate s_j was 12.60%, and the un-separated grain rate s_j was 39.33% in the TFC unit.

Table 3 shows the relationships between k and u , plus y and z . When u was constant at 2 m^{-1} and k increased from 2 to 4 m^{-1} , the increasing rate of coefficient k was 100%. The increasing rate of z was only 0.899%, however. Similarly, when k was constant at 3 m^{-1} and u increased from 1 to 3 m^{-1} , the increasing rate of coefficient u was 200%; but the increasing rate of z was only 3.347%. The coefficient z was more susceptible to changes in u than to changes in k . These values and variations as-calculated were consistent with previous studies conducted by Tang *et al.* (1989).

As shown in Table 2 and Table 3, the coefficients u and k were obtained using test results. The calculation results for coefficient u and coefficient k were applied to Eq. [3] and Eq. [11]. The equations of y and z were also obtained. The equation structure of y and z were in accordance with previous studies conducted by Miu & Kutzbach (2008a), but the specific expressions were dissimilar. This could be due to the differing characteristics and variables of the threshing and separation unit used in our study. As shown in Figs. 5a and 5b, y and z increased alongside increases in the arc length of the grid concave. If $l > 0$, the threshed and separated capacity of the knife bar of the TFC unit was stronger than other threshing teeth. The maximum primary threshing rate of the knife bar was 87.04%, and the maximum primary separation rate was 47.71%. In order to ensure that the separated capacity was stronger than the threshed capacity of the knife bar, the minimum arc length of grid concave l_m was set to 411.90 mm.

Grain re-threshing and re-separation performance of LFC unit

First, the rice straw was preliminarily threshed and separated by the TFC unit with the knife bar. Next, the straw was moved to the LFC unit, where the resultant un-threshed grain was threshed and separated by the LFC unit with either a trapezoidal tooth, rectangular bar, spike tooth, or rasp bar, respectively. According to Table 2, the un-threshed grain rate s_j was 39.33%, and the un-separated grain rate s_i was 22.96%. These results were in accordance with previous studies conducted by Tang *et al.* (2011).

As shown in Table 4, after threshing and separation by LFC unit, results demonstrated an un-separated grain rate of 0.44%, and an un-threshed grain rate of 0.02% with the spike tooth in the TFC unit. The value of un-threshed grain rate $S_n(L)$ and the un-separated grain rate of the LFC unit were then obtained.

The threshing and separation probability density equations for the LFC unit using a trapezoidal tooth, rectangular bar, spike tooth and rasp bar were all obtained. The structure of threshing and separation probability density equations were in accordance with previous studies conducted by Miu & Kutzbach (2008b), but the specific expressions were not the same. This could be due to the differing characteristics and variables of the threshing and separation units used in our study. As shown in Fig. 6a, when $0 \leq x \leq 0.35$ m, according to the

0.96-1.31 m length of the LFC unit, the grain threshing probability density of the spike tooth was stronger than other threshing teeth. According to Fig. 6b, when $0.52 \leq x \leq 1.95$ m, according to the 1.48-2.91 m length of the LFC unit, the grain separation probability density of the trapezoidal tooth was stronger than other threshing teeth.

As shown in Fig. 7, the length of the LFC unit was then divided into four sections: the first section (0-0.17 m) was helical blades, the second section (0.17-1.48 m) was the spike tooth, the third section (1.48-2.91 m) was the trapezoidal tooth, and the fourth section (2.91-3.35 m) was the discharge plate. All measurements were subjected to analysis of variance. The result showed a highly significant ($p < 0.05$) correlation for test results of each experiment with the same variables ($n = 5$). The threshed and separated performance indicators thus met all design requirements.

As conclusions, the accumulative threshed grain rate (y) and the accumulative separated grain rate (z) increased alongside increasing arc length of the grid concave. The threshing and separation capacity of the knife bar in the TFC unit was stronger than other threshing teeth. The maximum primary threshing rate of the knife bar is 87.04%, and the maximum primary separation rate is 47.71%. In order to ensure that the separation capacity is stronger than the threshing capacity of the knife bar, the minimum arc length of the grid concave screen was set to 411.90 mm. After being primary threshed and separated by the TFC unit, the un-threshed rate was 12.60%, and the un-separated grain rate was 39.33% at the entrance of the TFC unit. At a length of 0.96-1.31 m, the grain threshing probability density of the spike tooth used in the LFC unit was stronger than other threshing teeth. At a length of 1.48-2.91 m, the grain separation probability density of the trapezoidal tooth used in the LFC unit was stronger than other threshing teeth.

After grains were primary threshed and separated by the TFC unit with knife bar, the length of the LFC unit was divided into four sections for further analysis: the first section (0-0.17 m) was helical blades, the second section (0.17-1.48 m) was the spike tooth, the third section (1.48-2.91 m) was the trapezoidal tooth, and the fourth section (2.91-3.35 m) was the discharge plate. The test results show an un-threshed grain rate of 0.243%, un-separated grain rate of 0.346%, and broken grain rate of 0.184% with a feeding rate of 7 kg s^{-1} . The results from this research can be used to effectively design a novel TLFC unit for small and medium-sized (SME) combine harvesters.

Acknowledgements

This research was supported by the Natural Science Foundation of Jiangsu Province College's General Program (14KJB460007), the Scientific Research Foundation of Jiangsu University (14JDG029), the Natural Science Foundation of Jiangsu Province (BK2011469), and a project funded by the Priority Academic Program Development of Jiangsu Higher Education Institutions (PAPD).

References

- Alferov SA, Braginec VS, 1972. Grain threshing and separation in threshers as a uniform probability-conditioned process. *Tractory I sel'chozmasini* 42 (4): 23-26. [In Russian].
- Gasparetto E, Febo P, Pessina D, Rizzato E, 1989. High speed movie observation of an axial flow combine harvester cylinder. *Land Water Use 1935-1942*. Rotterdam Balkema, Holland.
- Golpira H, 2013. Conceptual design of a chickpea harvesting header. *Span J Agric Res* 11(3): 635-641.
- Gregory JM, 1988. Modelling applications in agricultural engineering. Combine model for grain threshing. *Math Comput Model* 11 (5): 506-509.
- Hamdy MY, Stewart RE, Johnson WH, 1966. Theoretical analysis of centrifugal threshing and separation. ASAE Paper No. 66-613. ASAE, St. Joseph, MI, USA.
- Huynh MV, Powell T, Siddal NJ, 1982. Threshing and separating process-A mathematical model. *T ASAE* 25(1): 65-73.
- Klinner WE, Neale MA, Arnold RE, 1987. A new stripping header for combine harvesters. *Agric Eng* 42(1): 9-14.
- Kumar R, Goss JR, 1979. Analysis and modeling of alfalfa seed harvest losses. *T ASAE* (22): 237-242.
- Long LD, 1982. Mathematical model of the threshing process in a conventional combine-threshing. *J Agric Eng Res* (2): 119-130.
- Maertens K, Baerdemaeker JD, 2003. Flow rate based prediction of threshing process in combine harvesters. *Appl Eng Agr* (4): 383-388.
- Miu PI, 1994. Concave separation in a tangential threshing unit. ASAE Paper No. 941544. ASAE St Joseph, MI, USA.
- Miu PI, 1995. Modelarea procesului de treier la combinele de recoltat cereale [Mathematical modelling of threshing process in cereal combine harvesters], Ph.D. diss. Politehnica University, Department of Agricultural Engineering, Bucharest.
- Miu PI, 1999. Mathematical Modeling of material other-than-grain separation in threshing units. ASAE Paper No. 993208. ASAE, St. Joseph, MI, USA.
- Miu PI, 2002. Kinematic model of material movement through an axial threshing unit. ASAE Paper No. 023052. ASAE, St. Joseph, MI, USA.
- Miu PI, Beck F, Kutzbach HD, 1997. Mathematical modeling of threshing and separating process in axial threshing units. ASAE Paper No. 97-1063, ASAE, St. Joseph, MI, USA.
- Miu PI, Wacker P, Kutzbach HD, 1998a. A comprehensive simulation model of threshing and separating process in axial units. Part I. Further model development. *Proc Int Conf Agric Eng Oslo 98, Part 2, Paper 98-A-115*, pp: 765-766.
- Miu PI, Wacker P, Kutzbach HD, 1998b. A comprehensive simulation model of threshing and separating process in axial units. Part II. Model validation. *Proc Int Conf Agric Eng Oslo 98, Part 2, Paper 98-A-116*, pp: 767-768.
- Miu PI, Kutzbach HD, 2000. Simulation der Dresch-und Trennprozesse in Dreschwerken [Simulation of threshing and separation processes in threshing units]. *Agrartechnische Forschung Sonderheft* (6): 1-7.
- Miu PI, Kutzbach HD, 2008a. Modeling and simulation of grain threshing and separation in threshing units-Part I. *Comput Electron Agr* 60: 96-104.
- Miu PI, Kutzbach HD, 2008b. Modeling and simulation of grain threshing and separation in axial threshing units-Part II. Application to tangential feeding. *Comput Electron Agr* 60: 105-109.
- Ndirika VIO, 1994. Development and performance evaluation of a millet thresher. *J Agric Eng Technol* 2: 83-88.
- Nwuba AIU, Braide FG, 1994. Development of whole crop cowpea thresher as effected by grain and stalk properties. *J Agric Eng Technol* 2: 67-69.
- Osueke ECO, 2011. Simulation and optimization modeling of performance of a cereal thresher. *Int J Eng Technol IJET-IJENS* 11(3): 143-152.
- Segarceanu MI, Paunescu I, Chiriac R, Casandroi T, Cristea I, Maican C, 1983. Testing of axial flow combine harvesters, Note 12. Polytechnic Institute of Bucharest, Romania. [In Romanian].
- Tado CJM, Wacker P, Kutzbach D, Suministrado DC, 1998. Development of stripper harvester: a review. *J Agr Eng Res* 71(1): 103-112.
- Tang HJ, Zhao XD, Huang XD, 1989. The separation property of concave in grain threshing unit. *T CSAM* 4: 49-56.
- Tang Zh, Li YM, Xu LZ, 2011. Effects of different threshing components on grain threshing and separating by tangential-axial test device. *T CSAE* 27(3): 93-97.
- Trollope JR, 1982. A mathematical model of the threshing process in a conventional combine-thresher. *J Agr Eng Res* 27(2): 119-130.
- Valentin V, Lucreția P, Sorin B, Sorin B, Aurel D, 2009. Contributions to modeling the threshing and separating process within a threshing apparatus with axial flow. *UPB Sci Bull* 71(1): 150-158.
- Xu LZ, Li YM, Tang Zh, Wang LG, Jiao ZhY, 2013. 4LQZ-6 Tangential-longitudinal axial combine harvester. *T CSAM* 44(8): 94-98.
- Xu LZ, Li YM, Wang CH, Xue Zh, 2014. A combinational threshing and separating unit of combine harvester with a transverse tangential cylinder and an axial rotor. *T CSAM* 45(2): 106-108.