



# A review on microalgae and cyanobacteria in biofuel production

Mai Anh Nguyen, Anh Linh Hoang

► **To cite this version:**

| Mai Anh Nguyen, Anh Linh Hoang. A review on microalgae and cyanobacteria in biofuel production. Economies and finances. 2016. <hal-01383026>

**HAL Id: hal-01383026**

**<https://hal-enpc.archives-ouvertes.fr/hal-01383026>**

Submitted on 18 Oct 2016

**HAL** is a multi-disciplinary open access archive for the deposit and dissemination of scientific research documents, whether they are published or not. The documents may come from teaching and research institutions in France or abroad, or from public or private research centers.

L'archive ouverte pluridisciplinaire **HAL**, est destinée au dépôt et à la diffusion de documents scientifiques de niveau recherche, publiés ou non, émanant des établissements d'enseignement et de recherche français ou étrangers, des laboratoires publics ou privés.

UNIVERSITY OF SCIENCE AND TECHNOLOGY OF HANOI

DEPARTMENT OF ENERGY

INTAKE 2015 - 2017

# A review on microalgae and cyanobacteria in biofuel production

Mai Anh Nguyen

Anh Linh Hoang

Hanoi, July 2016

## ABSTRACT

Today, fossil fuel shortages and climate change impacts have led mankind to the search for an alternative energy. With many advantages, bioenergy is a promising source to replace conventional energy. However, biofuel productions in the first and second generation are likely to add more concerns to the problems in water scarcity and threats to food security. Meanwhile, third generation biofuels obtained from microalgae and cyanobacteria are able to overcome existing challenges thanks to their rapid growth rates, abilities to fix CO<sub>2</sub>, high yields in lipid extraction and capabilities to be grown in non-arable lands. Microalgae and cyanobacteria appear to be the only ones among renewable sources that are capable of producing a wide range of biofuels including biohydrogen, biomethane, bioethanol and biodiesel.

In this study, we present an overview about microalgae and cyanobacteria use for the production of biofuels in fundamentals, including their biology, cultivation systems taking into account the hydrodynamic conditions, harvesting, and processing. The review also provides a general picture at the current status of this renewable energy industry.

**Keywords:** Energy crisis; Microalgae; Cyanobacteria; Biohydrogen; Biomethane; Bioethanol; Biodiesel; Open ponds; Photobioreactors; Hydrodynamics; Motility

## ACKNOWLEDGEMENT

We would like to express our appreciation to all those who provided us the opportunity and possibility to accomplish this study. We give our deepest gratitude to our supervisors, Professor Hassan Perhossaini and Professor Minh-Ha Duong, whose contribution in providing guidance, suggestions, and encouragement, for supporting us to coordinate our project, especially in writing this report.

Furthermore, we are immensely grateful to Dr. Mojtaba Jarrahi for his engagement throughout our learning process and his suggestions to enhance this review.

We would also give our thankfulness to CleanED laboratory for facilitating us in accessing to a wide range of data and articles in order to complete our research.

## TABLE OF CONTENTS

1. Introduction .....	6
2. Backgrounds of microalgae and cyanobacteria .....	6
2.1 Characteristics of microalgae and cyanobacteria .....	6
2.1.1 Microalgae .....	6
2.1.2 Cyanobacteria .....	7
2.1.3 Photosynthetic mechanisms .....	7
2.2 Microalgae and cyanobacteria as potential sources for biofuel production.....	9
3. Biofuel production from microalgae and cyanobacteria .....	10
3.1 Biomass production .....	10
3.1.1 Open ponds.....	11
3.1.2 Closed photobioreactors.....	12
3.1.3 Comparison of open ponds and closed photobioreactors .....	16
3.1.4 Hydrodynamics and motility of microalgae and cyanobacteria .....	17
3.2 Harvesting methods.....	19
3.2.1 Bulk harvesting.....	19
3.2.2 Thickening .....	20
3.3 Extraction methods.....	21
3.3.1 Dewatering.....	21
3.3.2 Cell disruption .....	21
3.4 Biofuel products.....	21
3.4.1 Biohydrogen production .....	22
3.4.2 Biomethane production .....	23
3.4.3 Bioethanol production .....	25
3.4.4 Biodiesel production .....	27
4. Application and Conclusion.....	30
References .....	32

## LIST OF FIGURES

Figure 1. The photosynthesis mechanism in microalgae (Schenk et al., 2008) .....	8
Figure 2. Plan view of a raceway pond .....	12
Figure 3. A tubular photobioreactor with parallel run horizontal tubes (Bahadar and Bilal Khan, 2013) .....	13
Figure 4. Types of tubular photobioreactors [Adapted from Carvalho et al., (2006)].....	14
Figure 5. Front and side views of flat photobioreactor (Bahadar and Bilal Khan, 2013).....	15
Figure 6. Internally-illuminated photobioreactor (Ugwu et al., 2008) .....	16
Figure 7. Types of biofuel produced from microalgae and corresponding technologies.....	21
Figure 8. Direct biophotolysis (Hallenbeck and Benemann, 2002).....	22
Figure 9. Indirect biophotolysis (Hallenbeck and Benemann, 2002) .....	23
Figure 10. Pretreatment stages for improving biomethane production (Passos et al., 2014) .....	24
Figure 11. Biomethane production in an anaerobic digestion process (Diltz and Pullammanappallil, 2013) .....	25
Figure 12. General process of bioethanol production from microalgal biomass .....	26
Figure 13. Biodiesel production through transesterification of triglycerides (Mata et al., 2010) .....	29

## LIST OF TABLES

Table 1. Oil content of some microalgae (Chisti, 2007).....	9
Table 2. Comparison of some sources of biofuels (Anemaet et al., 2010) .....	10

## 1. Introduction

The rapid rise of climate change and its threats to the Earth have become a concern to all sectors in the recent years. Moreover, the world is placed under an energy crisis due to the conflict between fossil fuel depletion and increasing global energy demand. It is now urgent to search for new resources that provide opportunities for the production of clean and green energy.

Accounting for 70% of the total global energy demand, fuels are playing a crucial part in the life of humans. For a long term vision in energy domain, biofuel production is expected to replace certain natural fuel sources thanks to its abilities in preventing the dependence on fossil fuels, ensuring the constant supply and performing its environmental sustainability (Gouveia and Oliveira, 2009). However, most of the traditional sources that produce biofuels are from terrestrial crops, which may cause a problem for food security. Meanwhile, many studies on microorganisms are showing new chances in producing third generation biofuels. Microalgae and cyanobacteria are two microorganisms that are highly recommended for becoming biofuel manufacturers on account of their outstanding features such as high growth rate, high oil content, mitigation of CO<sub>2</sub> from the atmosphere, flexible adaptation and can be grown in non-arable lands (Gouveia and Oliveira, 2009). From microalgae and cyanobacteria, there are several types of biofuel can be produced which are biomethane, bioethanol, biodiesel and biohydrogen (Schenk et al., 2008).

In this study, the main objective is to provide an overview of the potentials of microalgae and cyanobacteria in producing green energy including their biological characteristics, available technologies for biomass cultivation and biofuel conversions.

## 2. Backgrounds of microalgae and cyanobacteria

### 2.1 Characteristics of microalgae and cyanobacteria

Thanks to the biological characteristics, both microalgae and cyanobacteria can be developed as exceptional energy factories that capture sunlight and CO<sub>2</sub> to convert to useful energy. A study on their biology is indispensable to understand their potentials in the energy sector.

#### 2.1.1 Microalgae

Microalgae are recognized as the oldest living organisms on the Earth. They belong to Protista group and have the size measured in micrometers. Microalgae are described as thallophytes, which means they lack plant roots, stems, and leaves. Besides, they have no sterile covering of cells around the reproductive cells (Brennan and Owende, 2010). The photosynthetic microorganism live in water or suspensions within a body of water (Wen and Johnson, 2009). Microalgae can be classified according to their pigment kinds, chemical nature of energy storage components and cell wall constituents. The

major classes are green algae, red algae and diatoms (Brennan and Owende, 2010). The possession of chlorophyll a is the key for microalgae to have photosynthesis. Their photosynthesis mechanism is similar to that of higher plants but they are capable of converting more efficiently solar energy as a result of the simple unicellular structure. In addition, because the cells grow in an aqueous environment, they have more proficient access to water, carbon dioxide, and other nutrients, thus, photosynthesis can occur more effectively.

Microalgae can be autotroph or heterotroph. Photoautotrophic microalgae are capable of self-producing energy through light and carbon dioxide. On the other hand, some heterotrophic microalgae species can grow in darkness and use organic carbons such as glucose or acetate as sources of energy. Biofuel productions are normally relied on photoautotrophic-algal growth to minimize the operational costs (Wen and Johnson, 2009).

### 2.1.2 Cyanobacteria

Basically, cyanobacteria can be considered as a type of microalgae (Bahadar and Bilal Khan, 2013). Cyanobacteria are usually called blue-green algae because of their color as well as similarities with microalgae. Unlike microalgae, cyanobacteria are prokaryotic so that they lack a nucleus or membrane bound organelles such as chloroplast, fungi, Golgi, etc. Cyanobacteria are the only bacteria that contain chlorophyll a. They have a relatively small genome and many of them have already been completely sequenced, thus it is easy to genetically modify their biological features in order to enhance the biofuel productivity (Quintana et al., 2011).

Similar to microalgae, cyanobacteria has a small size and grow in the aquatic environment. Cyanobacteria survive over a wide temperature range, however, most tend to have warm temperature optima for growth. Cyanobacteria can grow prolifically under specific conditions and this may cause “blooms”, which cause high turbidity in the water, anoxia, fish kills and food-web alterations (Quintana et al., 2011).

In this report, since microalgae and cyanobacteria have similarities in term of biofuel productions, the term “microalgae” is used to indicate both microorganisms. In specific cases, their names and differences will be stated separately.

### 2.1.3 Photosynthetic mechanisms

All the feedstocks for the production of biofuels from microalgae are driven from their oxygenic photosynthesis. Photosynthesis takes the credit in the conversion of solar energy into chemical energy and eventually plays an important role in manufacturing the available materials for biofuels. Despite their biological differences, both microorganisms follow the same mechanisms in their photosynthesis, which are divided into two stages: light-dependent reactions, which take place in



thylakoid and dark reactions (Calvin cycle), which occur inside the chloroplast for microalgae and in distinctive folds in the outer membrane for cyanobacteria. The processes are illustrated in Figure 1.

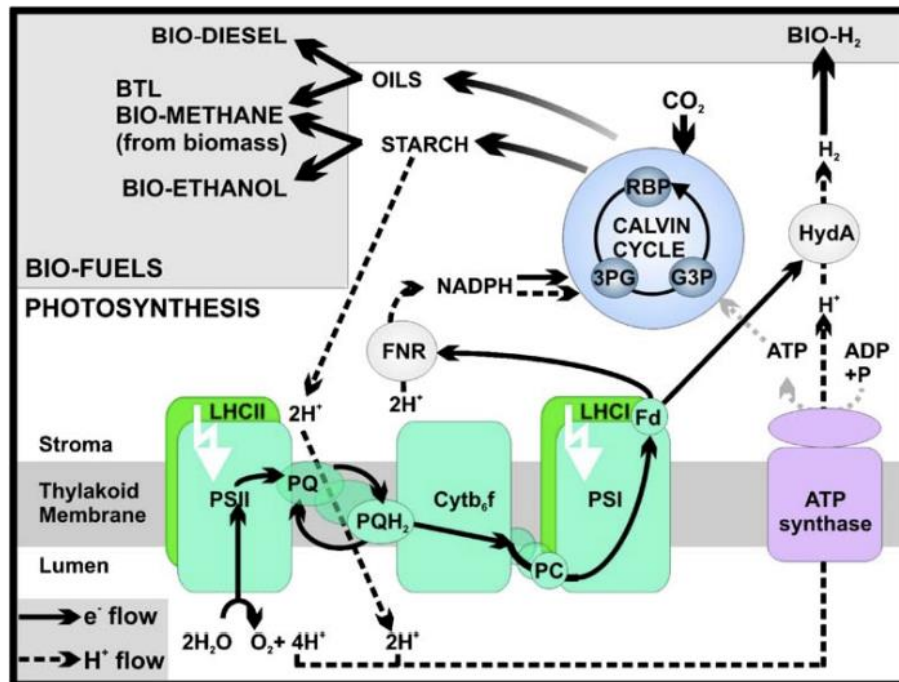

Figure 1. The photosynthesis mechanism in microalgae (Schenk et al., 2008)

Thylakoid contains a pair of photosystems called Photosystem I (PSI) and Photosystem II (PSII). Their duty is to work in tandem in order to generate the energy needed to produce carbohydrate in the Calvin cycle. Embedded in the photosynthetic membrane, protein complexes LCI and LCII are responsible for capturing sunlight. These proteins bind to a network of chlorophyll and carotenoid molecules that absorb the photons of light. Within these molecules, the absorbed light energy excites electrons to a higher state. The energized electrons are passed from PSII to an electron transport chain. In the meantime, there is a photosynthetic water splitting reaction in PSII to convert water into protons, oxygen, and electrons to make up for the transported energized electrons. Thus, oxygen is a by-product of photosynthesis. As the electrons pass through the transport chain, the energy of the electron is used to pump hydrogen ions to the thylakoid to create a concentration gradient that drives ATP production. Consequently, electrons that arrive in PSI are low in energy. In PSI, the process repeats as the light striking to LCI, the electrons are re-energized and passed through a transport chain, where the electron carrier NADPH is generated. In general, the main outputs of the light-dependent reactions are ATP and NADPH.

Dark reactions or the Calvin cycle is responsible for fixing CO<sub>2</sub>. The process uses ATP and NADPH that were generated from light reactions. The Calvin cycle consists of a series of reactions that reduce carbon dioxide to glyceraldehyde-3-phosphate (G3P). The cycle is composed of three steps which are

carbon fixation, reduction, and substrate regeneration. In the end of every cycle, one molecule of glyceraldehyde-3-phosphate is produced. They are then used to make glucose, fatty acids or glycerol. Several kinds of biofuel can be derived from the three compounds.

In some photosynthetic microalgal species, the protons and electrons extracted from water (or starch) in the two photosystems PSII and PSI can pass through the ATP synthase to the hydrogenase enzyme (HydA) to catalyze the direct photo-production of biohydrogen (Schenk et al., 2008).

## 2.2 Microalgae and cyanobacteria as potential sources for biofuel production

Microalgae are considered as strong candidates of the new energy generation for offering noteworthy advantages over higher plants. First, they have a very short life cycles. In particular, microalgae commonly double their biomass within 24 hours. During the exponential growth phase, they can increase their biomass to double in a short time of 3.5 hours (Chisti, 2007). Also, at an optimum growth temperature of 29.2°C, cyanobacteria has a mean growth rate of 0.92 day<sup>-1</sup> (LüRling et al., 2013). Thus, the quick growth of the microorganisms allows a constant cultivation throughout the year, which leads to a much higher oil yield per area in comparison with terrestrial crops.

Second, they can synthesize and accumulate large quantities of neutral lipids. Oil content of microalgae is usually between 20 % and 50 % dry weight (Table 1). In contrast, terrestrial crops, which take a season to cultivate, only contain a maximum of about 5 % dry weight of oil (Chisti, 2007). From the sources, microalgae will produce non-toxic and highly biodegradable biofuels (Schenk et al., 2008). A remark is that not only oil is highly applicable in biofuel production, but also other energy storage components including carbohydrates and proteins. Cyanobacteria possess unique properties which make them a promising model to transform all the C sources into valuable fuels (Quintana et al., 2011) Table 2. Theoretically, the amount of each type in a wide range of biofuels extracted from microalgae can be 10 to 50 times higher than biodiesel from oilseed crops (Table 2).

Table 1. Oil content of some microalgae (Chisti, 2007)

Microalgae	Oil content (% dry weight)
<i>Botryococcus braunii</i>	25–75
<i>Chlorella</i> sp.	28–32
<i>Cryptocodinium cohnii</i>	20
<i>Cylindrotheca</i> sp.	16–37
<i>Phaeodactylum tricornutum</i>	20–30
<i>Schizochytrium</i> sp.	50–77
<i>Tetraselmis suecia</i>	15–23

Table 2. Comparison of some sources of biofuels (Anemaet et al., 2010)

Source	Fuel product	Current yield (ha <sup>-1</sup> year <sup>-1</sup> )`	Maximal theoretical yield (ha <sup>-1</sup> year <sup>-1</sup> )
Sugar cane	Ethanol	6,000 L	
Palm Oil	Biodiesel	5,500 L	
Algae	Biodiesel		58,700 L
Cyanobacteria	Ethanol	50,000 L	168,000 L
Cyanobacteria	Ethylene	336 kg	82,000 kg
Cyanobacteria	Isobutanol	13,125 L	147,000 L
Cyanobacteria	Acetone	ND	159,000 L
Cyanobacteria	Propanol	ND	150,000 L
Cyanobacteria	Isobutyraldehyde	18,690 kg	126,000 kg

Third, microalgae and cyanobacteria are greatly adaptable to various climate conditions and grow easily with simple nutritional requirements. Moreover, microalgae are able to utilize waste water streams for growth, thereby greatly reducing freshwater needed (Schenk et al., 2008). Additionally, unlike higher plants which may compensate their biomass due to the maintenance of large non-productive parts in severe conditions such as poor soil quality or water availability, the presence of insects, microalgae have simple structures so that they can breed under optimal physiological conditions with high yields (Anemaet et al., 2010).

Finally, microalgae are environmental agents as they sequester carbon dioxide emitted from burning fossil fuels through photosynthesis. If a microalgal cultivating farm is built close to a power plant, CO<sub>2</sub> released by the power plant could be exploited as a carbon source for algal growth. Consequently, the greenhouse gasses emissions would be lowered through the transformation from gas to microalgal biomass (Wen and Johnson, 2009).

### 3. Biofuel production from microalgae and cyanobacteria

#### 3.1 Biomass production

Microalgae can grow spontaneously wherever there are water and light, however, a commercial production of biofuels requires a massive amount of biomass extracted. Therefore, an artificial and systematic production should be considered. The cultivation should offer a culturing condition that

replicates and boosts the optimum growth settings. A basic cultivating condition consists of light, carbon dioxide, water, inorganic salts and a temperature ranging from 20 to 30 °C (Chisti, 2007).

Commonly, microalgae collect CO<sub>2</sub> from the atmosphere. They can also fix carbon dioxide presented in discharge gasses from heavy industry or soluble carbonates (Wang et al., 2008). Microalgae are capable of fixing biomass with a high yield deriving from a large quantity of CO<sub>2</sub>. Approximately, the production of 100 tons of algal biomass involves 183 tons of carbon dioxide (Chisti, 2007).

Inorganic elements are essential for the constitutions of microalgal cells. The fundamental constituents are nitrogen (N), phosphorous (P), iron and silicon (in some cases). The supply of basic nutrition can be estimated using a molecular formula of microalgal biomass presented by Grobbelaar, (2003), which is CO<sub>0.48</sub>H<sub>1.83</sub>N<sub>0.11</sub>P<sub>0.01</sub>. According to the formula, carbon, hydrogen, and nitrogen play big roles in the growth. On the other hand, though phosphorous accounts for an extremely small amount throughout the cycle, it must be supplied with an excess quantity because phosphates ions may bond metal ions, thus, not all the supplied phosphorous is bioavailable (Brennan and Owende, 2010).

Sunlight is a free but unlimited natural resource for the conduction of photosynthesis. However, the absence of light during the night leads to respiration of microalgae. Due to respiration, up to 25 % of biomass produced in the day can be lost (Chisti, 2007).

Currently, there are main two cultivation techniques which are extensively used for the commercial production of microalgae. They are open ponds and closed photobioreactors.

### 3.1.1 Open ponds

Open ponds are classified into natural waters (lakes, ponds or lagoon) and artificial ponds. Raceway ponds are the most typical type of open ponds. The largest raceway-based biomass production is found in Calipatria, CA (USA). The facility occupies an area of 440,000 m<sup>2</sup> to grow *Spirulina* for human nutrition products (Spolaore et al., 2006).

Raceway ponds are closed loop recirculation channels and presented in oval shapes (Figure 2). It can be built either in the form of a compacted earth construction lined with a 1–2 mm thick plastic membrane or concrete block walls and dividers lined with a plastic membrane to prevent leakage (Chisti, 2016). Typically, the ponds are between 0.25 to 0.30 m deep and up to 0.5 ha in size. The disproportional relationship between the size and the depth of a pond must be taken into account since a lower depth increases the surface-to-volume ratio, which subsequently improves the light penetration for an efficient photosynthesis.

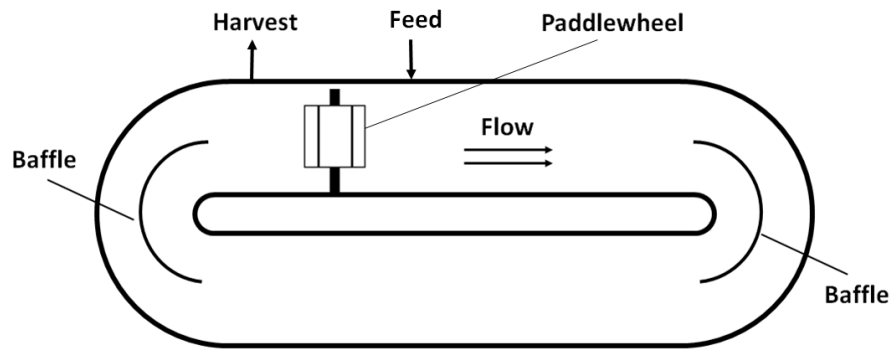

Figure 2. Plan view of a raceway pond

Main components of a raceway pond are microalgal broth, paddlewheel, and baffles (Figure 2). As the culture is introduced to the pond, the rotation of the paddlewheel not only forms the homogeneous mixture but also constantly create circulation in the pond. The baffles are in charge of guiding the flow to ensure it remains uniform throughout the curved bends and minimize dead zones formed at the ends of the pond (Chisti, 2013). For each cycle, on one side of the paddlewheel, the culture is continuously fed during daylight and the flow begins. As the flow completely circulates the pond, the microalgal broth is harvested on the other side of the paddlewheel (Figure 2).

In order to prevent the microalgal cells from being settled, which may cause massive mortality, the paddlewheel must operate all the time. Moreover, the operation of the paddlewheel enforces the vertical mixing, prevents thermal stratification and facilitates the removal of accumulated dissolved oxygen generated by photosynthesis, which later may cause photoinhibition and cell destruction. The maximum tolerable dissolved oxygen level should not exceed 400% of air saturation value (Chisti, 2016; Wen and Johnson, 2009). Besides, it is necessary to control the quantity of carbon dioxide required for photosynthesis. If the consumed amount of carbon dioxide is more rapid than the quantity supplied, the pH becomes alkaline. Referring to the concentration of CO<sub>2</sub> in the atmosphere (450 ppm), an extra supply of carbon dioxide to the pond should be considered.

### 3.1.2 Closed photobioreactors

Compared to open ponds, the cultivation conducted in closed photobioreactors permits a greater controllability. It allows to regulate and control most of the biotechnologically important parameters in determining the productivity. Besides, the closed systems have higher surface-to-volume ratio which leads to higher efficiency, shorter harvest times and ability to cultivate a wide range of algal species than open systems (Wang et al., 2008).

Generally, closed photobioreactors are a collection of thin panels of transparent tubes or plates that are situated properly to face the solar source. Circulating components play an important role in the

system as they prevent the sedimentation of microalgal broth. The two popular systems which can be in charge of the circulation are either mechanical pump or airlift. Typically, a system comprises of two main parts: a light-harvesting unit which provides a high area-to-volume ratio for efficient photosynthetic activity, and a gas exchange unit, in which CO<sub>2</sub> is supplied and biomass harvesting is processed (Carvalho et al., 2006). According to the design, photobioreactors can be classified into three main types: tubular, flat-plate and internally-illuminated photobioreactors.

### 3.1.2.1 Tubular photobioreactors

Tubular photobioreactors are the most widely used and considered the most promising systems because of high biomass yield and short harvest times (Bahadar and Bilal Khan, 2013). A tubular photobioreactor consists of an array of straight transparent tubes that are usually made of plastic or glass. The tubular arrays are placed in various positions including horizontally, vertically, inclined or as a helix in order to capture the highest quantity of solar light energy. The solar collector tubes often do not exceed 0.1 m in diameter in order to ensure a deep light penetration with the presence of dense cultural broth inside the tubes (Figure 3). The microalgal broth is circulated from a reservoir to the solar collector and back to the reservoir. In this structure, the solar collector favors the photosynthesis of microalgae while the reservoir performs as a gas exchanger. Degassing zone, i.e. the reservoir, is responsible for the disengagement of all the gas bubbles including oxygen from the broth in order to return the pure bubble-free broth to the solar collector.

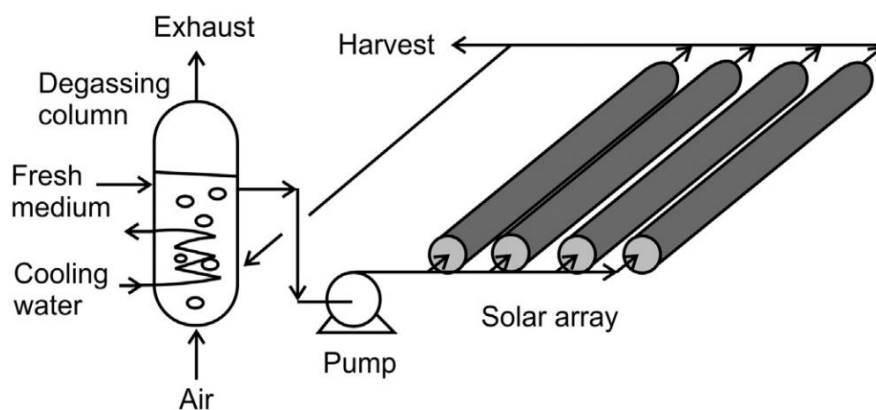

Figure 3. A tubular photobioreactor with parallel run horizontal tubes (Bahadar and Bilal Khan, 2013)

The arrangement of arrays and flow regimes inside the photobioreactors may define the configuration of tubular photobioreactors into one of the following four types (Figure 4): (i) vertical tubular photobioreactor, which is a simple airlift or transparent bubble column to allow for light penetration easily and supply CO<sub>2</sub> sufficiently via bubbling; (ii) horizontal tubular photobioreactor, which is composed of horizontal transparent tubes, usually bearing gas transfer systems attached to the connections; (iii) helical tubular photobioreactors, which is a flexible plastic tube coiled in a circular

framework; and (iv)  $\alpha$ -shape tubular photobioreactor, which is characterized by an unidirectional, high liquid flow rate in associated with a low air flow and a respective angle to capture sunlight (Carvalho et al., 2006).

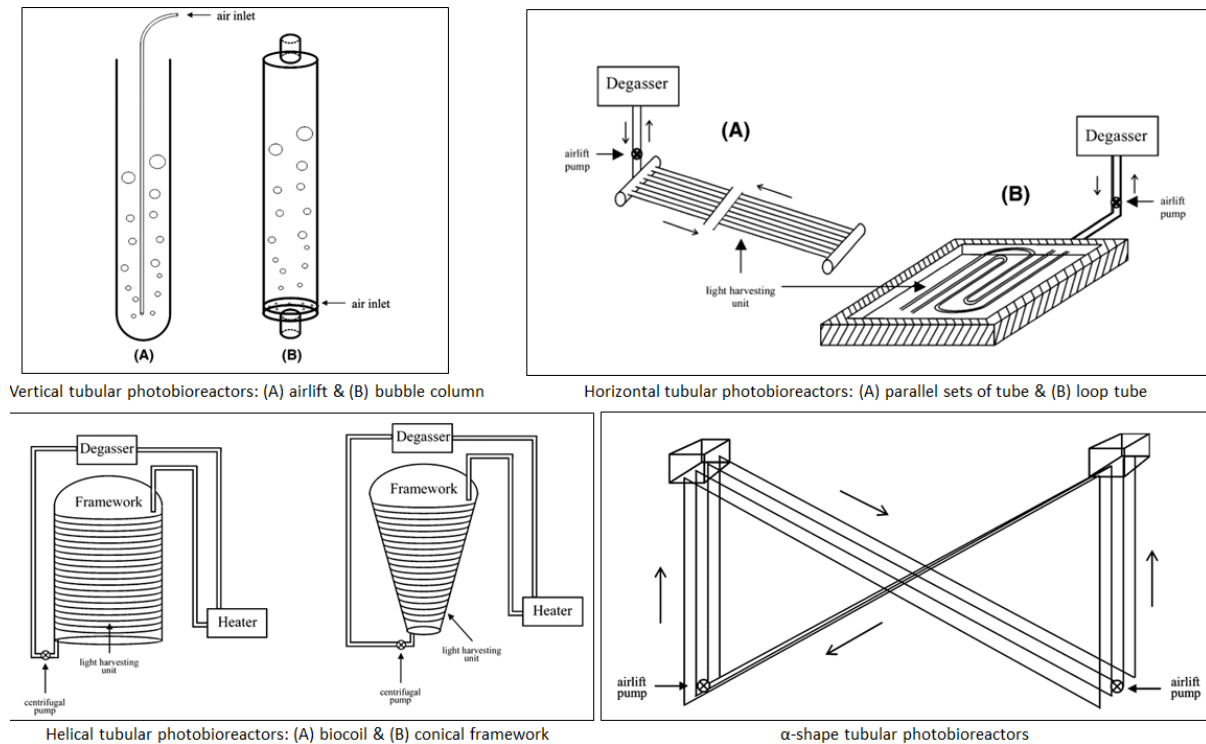

Figure 4. Types of tubular photobioreactors [Adapted from Carvalho et al., (2006)]

### 3.1.2.2 Flat-plate photobioreactors

Flat-plate photobioreactors can be classified as one of the earliest forms of cultivating closed systems. The system has been extensively researched due to the large surface area exposed to light and high densities of photoautotrophic cells (over  $80 \text{ g l}^{-1}$ ) maintained (Hu et al., 1998).

The photobioreactors are conceptually designed to make efficient use of sunlight by employing a thin layer of very dense culture in a flat transparent panel, which allows radiation penetration within few millimeters thickness (Brennan and Owende, 2010) (Figure 5). The use of high area-to-volume ratio panels allows an extensive absorption of light energy in the biomass production. Normally, the panels are directly exposed to sunlight on only one side and can be positioned in variable angles respective to the sunlight, which allows a better efficiency. The system employs a device which creates bubbles at the bottom through a perforated plastic tube (Figure 5). The tube introduces compressed  $\text{CO}_2$ -enriched air as a turbulent flow in the culture suspension (Hu et al., 1998). Due to the low accumulation of dissolved oxygen and the high photosynthetic efficiency achieved, the system is extremely suitable for massive cultivation of microalgae. Biomass productivity rapidly increases with a mixing rate, which supplies an adequate amount of  $\text{CO}_2$  to the culture and eliminates excess oxygen.

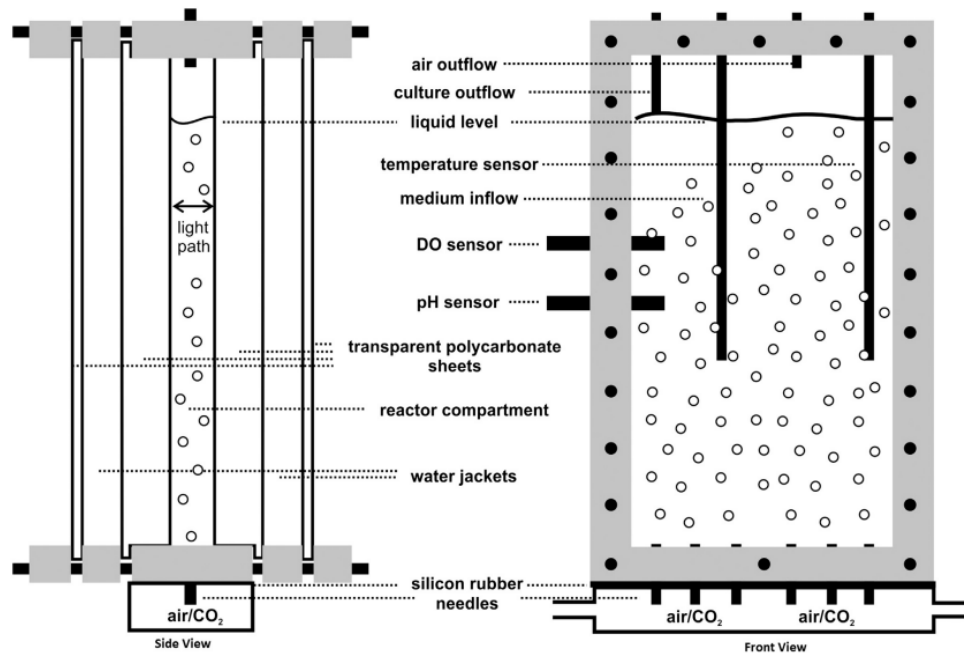

Figure 5. Front and side views of flat photobioreactor (Bahadar and Bilal Khan, 2013)

Despite the benefits that flat-plate photobioreactors can have, it is difficult to construct an industrial-qualified reactor since it is difficult to construct a very narrow culture chamber (below 1 cm) in combination with an efficient mixing device (Hu et al., 1998).

### 3.1.2.3 Internally-illuminated photobioreactors

The photobioreactor is a medium-size tube containing the microalgal broth and a gas exchanger system. The light source is powered by sunlight or fluorescent lamps to ensure the photosynthetic efficiency (Ugwu et al., 2008). The photobioreactor is equipped with impellers for agitation of the cultures. Air and carbon dioxide are constantly supplied by a sparger.

To overcome the threat of biomass loss due to respiration at night, the artificial light source is employed for as internal illumination (Figure 6). In such system, the solar light source is fully used and the artificial light is turned on once the natural light intensity decreases below a minimum level (Ugwu et al., 2008) to ensure the continuity of deep light penetration to the algal broth and maintain the constant supply of light throughout the day.



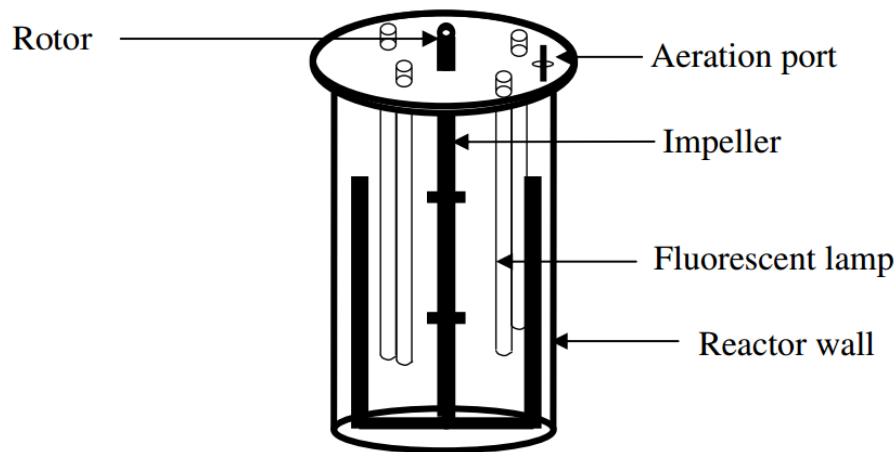

Figure 6. Internally-illuminated photobioreactor (Ugwu et al., 2008)

### 3.1.3 Comparison of open ponds and closed photobioreactors

In assessing the effectiveness of a microalgal biomass cultivating system, the following essential factors need to be considered: (i) a continuous access to light source; (ii) efficient operation to achieve a high productivity; (iii) sufficient amount of carbon dioxide while minimizing losses; (iv) removal of excess generated oxygen that may causes photo-inhibition or damage microalgal cells; and (v) possibility to avoid contamination or destruction by external factors. Both open ponds and closed photobioreactors methods are technically feasible, however, photobioreactors provide much greater oil yield per hectare compared with raceway ponds (Chisti, 2007).

Open ponds cost less to construct and operate than closed photobioreactors. However, the method, which relies largely on the natural conditions, includes several drawbacks and thus, has a lower productivity in general. First, due to the open-air systems, the production experiences a considerable amount of water evaporation. Thus, open ponds cannot allow microalgae to use carbon dioxide as efficiently, and biomass production is limited (Chisti, 2007). Second, biomass productivity is also affected by contamination by unwanted algal species as well as organisms that feed on algae. Third, because the variation of natural elements has major impacts on the system, optimal culture conditions are difficult to maintain in open ponds, and recovering the biomass from such a dilute culture is expensive (Molina Grima et al., 1999).

Meanwhile, closed photobioreactors are created to overcome the limitations existed in open ponds. Within a closed system, the problems concerning contamination and evaporation are eliminated. Moreover, the sophisticated designs and utilization of artificial light source allow the cells to access to better light regimes and reduce the biomass loss due to respiration at night. Thus, biomass productivity of photobioreactors can be in average 13 times more than that of a traditional raceway pond (Chisti, 2007). Harvest of biomass from photobioreactors is less expensive than from raceway

ponds because the typical algal biomass is about 30 times more concentrated than the biomass found in raceways (Chisti, 2007). However, closed photobioreactors also have some disadvantages. The biggest challenge is the difficulty in scaling up. Additionally, the light limitation is cannot be entirely overcome because light penetration is inversely proportional to the cell concentration (Wen and Johnson, 2009).

Concerning the cultivation of microalgae, there are certain advantages and disadvantages of each technique. Depending on the purpose and the facility, microalgae strain and product of interest, a selection of the suitable method will be defined. Photobioreactors and open ponds should not be seen as competing technologies but two options in producing biofuels from microalgae.

#### 3.1.4 Hydrodynamics and motility of microalgae and cyanobacteria

One of the main reasons for the high costs of microalgae production is the low cell density in the culturing system, usually caused by the limited light penetration (Luo and Al-Dahhan, 2012). Therefore, in order to design an easily implemented culturing system with high efficiency, it is a must to study the continuous flow properties inside the systems. Until now, most of the researches investigate the hydrodynamics in photobioreactors but there exist only a few publications on the motility of microalgae.

Hydrodynamic conditions and mass transfer in photobioreactors are characterized by the overall mass transfer rate, mixing time, bubble size and velocity and gas holdup. Mass transfer rate is determined by the overall volumetric mass transfer coefficient in photobioreactors. The coefficient is dependent on numerous factors including the agitation rate, type of sparger, surfactants/antifoam agents and temperature (Ugwu et al., 2008).

Mixing time and rate are important parameters to consider. It has been proved that boosted mixing rate in deep photobioreactors results in improved biomass production because of a better light regimen (Sobczuk et al., 2006), however, upon reaching some optimum value, the productivity declines rapidly with further increase in turbulence (Camacho et al., 2000). The optimization of mixing relies largely on the component that generates turbulent flows in the cultivating system. While in open ponds only the paddles play the role, in photobioreactors, there are many choices such as impellers, spargers which create bubbling air, airlift or baffles.

Gas bubble velocity is a measure of culture flow rates in tubular photobioreactors. As the gas dispersion rate is raised, relatively large bubbles are produced. Bubbles have a tendency to come together to form a boundary between the liquid broth, gas and the walls of the tube. The phenomenon

reduces the contact area between the liquid and gas, which causes poor mass transfer rates, and the decrease level is accelerated if the bubbles are in large sizes (Ugwu et al., 2008).

Gas holdup can be defined as the fraction of the reactor volume taken by the gas. A common method to estimate this parameter is to measure the volume of the liquid displaced by the gas due to aeration. Higher gas holdup increases the circulation rate, gas residence time the mass-transfer capacity (Kaiwan-arporn et al., 2012; Ugwu et al., 2008). Moreover, an increase in the liquid viscosity reduces the terminal velocity of bubbles in the liquid phase and enlarges the turbulent sublayer, which increases the gas velocity (Luo and Al-Dahhan, 2012).

On the other hand, hydrodynamic conditions in a photobioreactor directly influence the productivity of shear-sensitive cultures of microalgae in cell reproduction. Shear stress is certainly a significant parameter following the two arguments: (1) shear stress is an influential factor which partially controls the power absorption, mixing properties and mass transfer coefficient; (2) microalgal cells and other suspended elements are vulnerable to the dominant shear rate and associated shear stress (Sánchez Pérez et al., 2006). It is important to note that a beneficial shear stress may become detrimental as its excessiveness causes damages to the cells. Various laboratory works have been conducted in order to study the effects of different stresses on the productivity and their critical values. Several conclusions have been made. Camacho et al., (2000) found that fragile algae were extremely sensitive to shear stress and easy to be damaged in agitated and sparged photobioreactors. Barbosa et al., (2003) concluded that the gas entrance velocity provided by sparging component in a photobioreactor played a major role in causing cell death and there existed a self-surviving mechanism in the cell wall to fight against the hydrodynamic shear. In addition to discoveries of Barbosa et al., (2003), experiments conducted by Sobczuk et al., (2006) showed that the abilities to resist against hydrodynamic forces ranged were different with different microalgae. They also confirmed that an excessive mechanical agitation caused cell mortality. Sánchez Pérez et al., (2006) investigated the theoretical relationship between the shear stress and fluids in the flow regimes. The average shear rate in both laminar and turbulent flows depended on the impeller rotational speed but with different exponents. In bubble columns, the average shear rate was controlled by the superficial aeration velocity, the rheological properties of the fluid and its density. After studying the productivity of microalgae under hydrodynamic stress, Bronnenmeier and Märkl, (1982) explored a link between the critical hydrodynamic stress in free-jet and stirring experiments. The critical dissipated energy in a free-jet was approximately seven times lower than that of stirring experiments and the stress generated by free-jet could only last for a period while it was continuous for stirring systems. Luo and Al-Dahhan, (2012) performed experiments on red algae *Porphyridium* in airlift column photobioreactors. A conclusion was drawn on how microalgae affected noticeably the local multiphase flow dynamics and

how the split column photobioreactors were able to work more effectively than bubble and draft tube columns. After experimenting on *P. tricornutum*, Mirón et al., (2003) proved that the biomass productivity measured on a land area of vertical column photobioreactors was considerable higher than that of conventional horizontal tube photobioreactors. Scarsella et al., (2012) examined the hydrodynamic effects generated by centrifugal and airlift pumps on two microalgae and found that *C. vulgaris* cells appeared to be weaker than *S. dimorphus* cells.

Meanwhile, little works have been done regarding the motility of microalgae. The diffusion of microalgae inside the photobioreactors is remaining a new promising field for further investigation. By understanding the dynamic diffusion of microalgae throughout the biomass production, it is possible to optimize the design of photobioreactors for biofuel production. Experiments studying the motion of microorganisms done separately by Berg and Brown, 1972; Saragosti et al., 2012; Solomon et al., 1994; Ziburdaev et al., 2014 have shown that bacterial motility can be divided into two parts: high-speed “run” phases and low-speed “tumble” (or twiddle) phases. During the running periods, the microorganisms move with a quick uniform speed, however, they slow down and remain constrained on a certain region when on twiddling (Berg and Brown, 1972). Utilizing such model of movement, microorganisms are able to discover the most suitable areas for growth because they precisely arrive at reduced areas during tumble phases and change the direction to search for new areas from the end of one run to the beginning of the next phase (Berg and Brown, 1972; Vourc’h et al., 2016). Vourc’h et al., (2016) studied the intermittence of *Synechocystis* sp. motility. They found that the motility of the cyanobacteria reflected a global Fickian behavior, where the variance of the displacement distribution was proportional to the elapsed time.

## 3.2 Harvesting methods

The harvesting techniques depend on characteristics of microalgae such as size, density and the purpose of the product after harvesting. According to Brennan and Owende, (2010), the harvesting stage is divided into two steps which are bulk harvesting and thickening.

### 3.2.1 Bulk harvesting

The purpose of this step is to separate biomass from bulk suspension. Total solid matter can be separated about 2-7 % using gravity sedimentation, flotation or flocculation methods (Brennan and Owende, 2010).

Gravity sedimentation is one of the most common methods for algae biomass harvesting in waste water treatment, however, it only suits for large microalgae such as *Spirulina* (Brennan and Owende, 2010). Although this method is very simple, it takes a long time for pretreatment and requires a high-

temperature environment (Gouveia, 2011). Using lamella separators and sedimentation tanks can improve microalgae biomass by gravity sedimentation (Nyomi Uduman and Ying Qi, 2010).

Flotation is the biomass removal using gravity separation in which air or gas is bubbled through a solid-liquid suspension, then the solid particles get glued by the gaseous molecules. The size of the particles is important as the smaller the particle size, the more likely the particle can be levitated by the bubbles (Nyomi Uduman and Ying Qi, 2010). It is divided into dissolved air flotation, dispersed flotation and electrolytic flotation depending on the bubbles sizes.

Flocculation process involves the flocs, i.e. aggregates formed by solute particles in a solution when they collide with each other. Flocculation is a preparatory step prior to other methods including flotation or gravity sedimentation. In this process, chemical elements called flocculants are utilized to induce flocculation. Multivalent metal salts such as ferric chloride ( $\text{FeCl}_3$ ), aluminum sulfate ( $\text{Al}_2(\text{SO}_4)_3$ ) and ferric sulfate ( $\text{Fe}_2(\text{SO}_4)_3$ ) are suitable flocculants (Ugwu et al., 2008). This method allows the treatment of large quantities of microalgae as well as a wide range of species.

### 3.2.2 Thickening

The aim of this finalized step in harvesting is to concentrate on the slurry through techniques such as filtration, centrifugation and ultrasonic aggregation (Brennan and Owende, 2010). The stage consumes more energy than pretreatment step.

Filtration technique is applicable for the harvesting of large microalgae ( $> 70 \mu\text{m}$ ) such as *Coelastrum* and *Spirulina* (Brennan and Owende, 2010). The cost of this method depends on the membrane filtration and it is not appropriate for large-scale harvesting.

Ultrasonic aggregation is the method that can concentrate the cells of microalgae by acoustic force followed by enhanced sedimentation. Bosma et al., (2003) indicated the highlighted features of ultrasonic harvesting are that it can be operated continuously without inducing shear stress on the biomass, which could destroy potentially valuable metabolites, and it is a non-fouling technique which only suits for the laboratory scale.

Centrifugation is the cheapest and most reliable technique. Most microalgae and cyanobacteria can be harvested from dilute suspension by centrifugal forces. This method can reach high efficiency, i.e. more than 95 % and increase the slurry concentration. However, the high operational costs and mechanical problems due to freely moving parts which are the disadvantages of this method.

### 3.3 Extraction methods

After harvesting, collected biomass slurry must be processed rapidly to avoid the decomposition by water elimination or drying method. Besides, the presence of the water in the microorganism since can build up the energy costs and reduces the efficiency in product yield. Hence, dewatering process and cell disruption process are the first essential steps to be taken into account.

#### 3.3.1 Dewatering

To eliminate water, there are a lot of drying pathways including the use of sunlight for drying, drum drying, spray drying, freeze-drying and fluidized drying. Utilizing sunlight is the cost-free drying method even though it needs a long time and large space.

#### 3.3.2 Cell disruption

Cell disruption is very important in relation with the lipid extraction for the production of biodiesel. Cell disruption can be divided into four stages: mechanical, physical, chemical and enzymatic (Lee et al., 2012) with popular methods such as high-pressure homogenization, autoclaving, hydrochloric acid, sodium hydroxide and alkaline lysis. There exists a weakness is that the energy consumed is higher than the energy available in lipid recovered from microalgae.

### 3.4 Biofuel products

Biomass obtained from microalgae can be processed in different ways to produce biofuels including biohydrogen, biomethane (biogas), bioethanol and biodiesel. Different pathways that bioenergy conversion can take place are described in Figure 7.

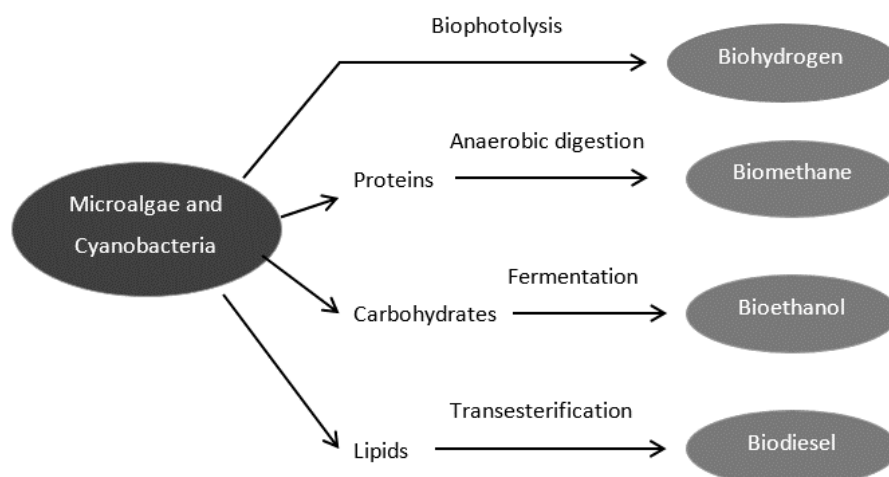

Figure 7. Types of biofuel produced from microalgae and corresponding technologies

### 3.4.1 Biohydrogen production

Through microalgae, biohydrogen can be obtained from the electrolysis of water or steam reforming of methane, thermochemical processes, or biological hydrogen production (Madamwar et al., 2001). Biological hydrogen production has more advantages than other chemical methods. Microalgae split water into oxygen and hydrogen molecules by using light energy in a specific pathway (see Section 2.1.3). This review will focus only on the technologies of direct and indirect biophotolysis for hydrogen production. The two hydrogen enzymes (hydrogenase and nitrogenase) are the keys to this progress.

#### 3.4.1.1 Direct biophotolysis

Direct biophotolysis is a process using solar energy to split water into hydrogen and oxygen.



In this process, the light energy is absorbed by photosystem II (PSII) or photosystem I (PSI) and produced electrons which are transferred to ferredoxin (Fd). Hydrogenase then obtains the electrons from ferredoxin directly to produce hydrogen (Adams, 1990). Hydrogenase is one of two general classes of enzyme which catalyze the hydrogen oxidation to protons and the reduction of protons to hydrogen (Madamwar et al., 2001) (Figure 8).

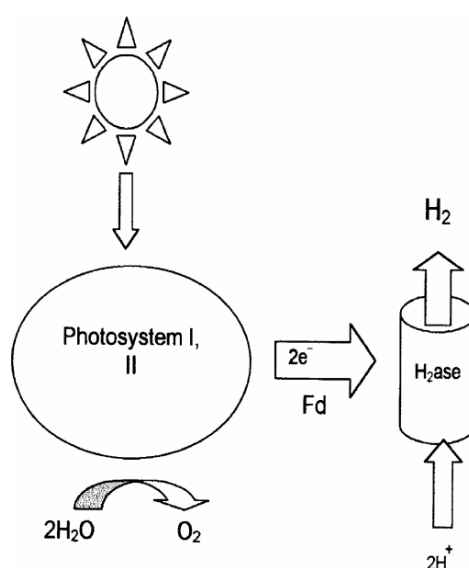
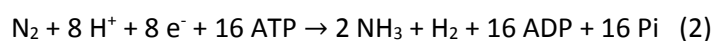

Figure 8. Direct biophotolysis (Hallenbeck and Benemann, 2002)

#### 3.4.1.2 Indirect biophotolysis

Indirect biophotolysis is known as a nitrogenase-based system. Nitrogenase is the catalyst in hydrogen production through the reduction of nitrogen to ammonia as seen in reaction (2) (Madamwar et al., 2001).



In this process, hydrogen is produced in two consecutive stages (Figure 9). Photosynthesis for carbohydrate accumulation and dark fermentation of the carbon reserve for hydrogen production. The reaction of hydrogen production is illustrated in reactions (3) and (4).

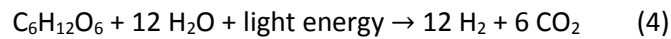
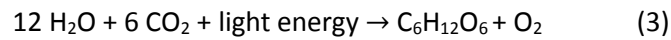

In this way, the oxygen and hydrogen evolutions are temporally separated spatially. This separation not only avoids the incompatibility of oxygen and hydrogen evolution but also makes hydrogen purification easily because carbon dioxide can be conveniently removed from the mixture of hydrogen and carbon dioxide. According to the scheme, CO<sub>2</sub> is reduced to starch by photosynthesis in the daytime and the formed starch is fermented to hydrogen gas and organic acids under anaerobic conditions during nighttime.

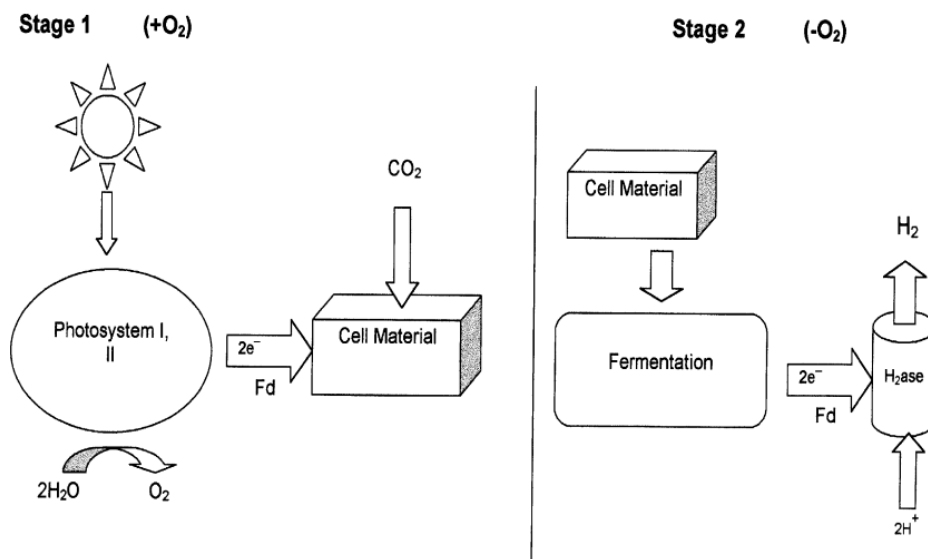

Figure 9. Indirect biophotolysis (Hallenbeck and Benemann, 2002)

### 3.4.2 Biomethane production

Biomethane (or biogas) is the product of anaerobic digestion process which consists of primary methane CH<sub>4</sub> (55 % to 65 %), carbon dioxide CO<sub>2</sub> (30 % to 45 %), small portion of hydrogen sulfide H<sub>2</sub>S, water vapor and a minute amount of H<sub>2</sub> and CO (Cooney et al., 2007; Costa and de Morais, 2011; Kapdi et al., 2005) The anaerobic digestion process is interesting since it covers the recovery of carbon dioxide, which is a compound produced from biogas (Harun et al., 2009).

The constituents of microalgae and cyanobacteria are useful for biomethane production through anaerobic digestion. Especially, the main component of cyanobacteria is proteins and they also lack a hard polysaccharide-based cell wall, which is favorable for the acceleration of biomass degradation.



These properties can explain the higher digesting capability of cyanobacterium species. Meanwhile, microalgae have the predominant organic component that can vary from carbohydrates to proteins or lipids.

#### 3.4.2.1 Pretreatment for biomethane production

To increase the efficiency of the anaerobic digestion process, Paris Hongley Chen and William J. Oswald, (1998) pointed out that the pretreatment is an essential step for microalgae cell disruption and biomethane production. Pretreatment is divided into four categories: thermal, mechanical, chemical and biological processes (Figure 10).

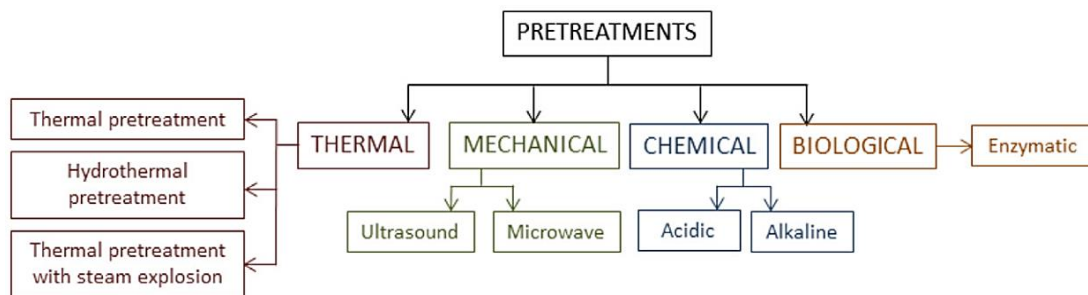

Figure 10. Pretreatment stages for improving biomethane production (Passos et al., 2014)

The effectiveness for microalgae cell disruption depends on the thermal and mechanical pretreatments. Thermal pretreatment has been the most widely studied, already in continuous reactors and leading to a positive net energy production (Passos and Ferrer, 2015; Schwede et al., 2013). Lee et al., (2012) showed that mechanical pretreatment was less dependent on the microalgae species but needed higher energy input in comparison with chemical, thermal and biological methods. Mendez et al., (2013) confirmed that chemical pretreatment methods were more successful, particularly when combined with heat. However, the use of chemical elements probably contaminates the products. Enzymatic pretreatment is a promising method due to its low energy involvement and the improvement in the microalgal hydrolysis (Ehimen et al., 2013).

#### 3.4.2.2 Anaerobic digestion

The anaerobic digestion process takes place in four stages: hydrolysis, fermentation, acetogenesis and methanogenesis (Figure 11). In the hydrolysis, the complex organic matter of microalgae such as proteins, carbohydrates and fats are broken down into soluble organic compounds like sugars, amino acids, and fatty acids. Then fermentative bacteria convert these soluble compounds into alcohols, acetic acid, and the mixture of volatile fatty acids (VFAs) as well as the higher chain VFAs like propionic, butyric and valeric acids. Then, these VFAs are continuously converted to acetic acid in the acetogenesis step. Acetic acid is converted to methane during methanogenesis. Finally, hydrogen and

carbon dioxide, which are released during fermentation and acetogenesis stage, react to form methane.

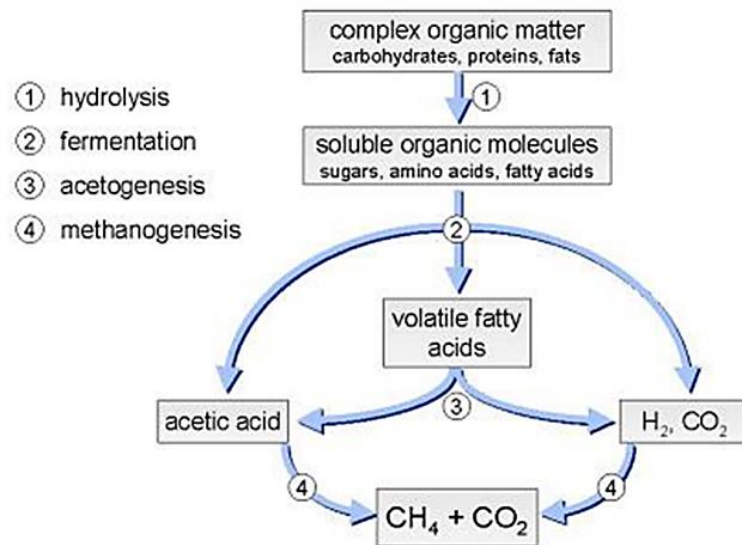

Figure 11. Biomethane production in an anaerobic digestion process (Diltz and Pullammanappallil, 2013)

However, there are some factors that affect the efficiency of anaerobic digestion such as environmental (temperature, pH, alkalinity, redox production, etc.) and operation parameters (C/N ratio, the presence of essential micronutrients, etc.) (Diltz and Pullammanappallil, 2013). Waste papers can be used to achieve a significant increase in methanol production. Yen and Brune, (2007) obtained double the methane production rate (1.17 ml/day with 0.57 ml/day) by using a waste paper/algae biomass ratio of 1:1 in comparison with anaerobic digestion of pure algal biomass. A remark is that high protein content can also increase ammonium production, which inhibits anaerobic digestion process.

### 3.4.3 Bioethanol production

Microalgae have an abundant amount of carbohydrates (in the form of glucose, starch, and other polysaccharides) and proteins that can be used as carbon sources for fermentation to produce bioethanol under specific conditions (Harun et al., 2010). There are four major operations which are pretreatment, hydrolysis, fermentation and distillation (product recovery) (Figure 12). A qualified bioethanol requires a complete sequence of all four stages, however, such third generation fuel would be considerably expensive.

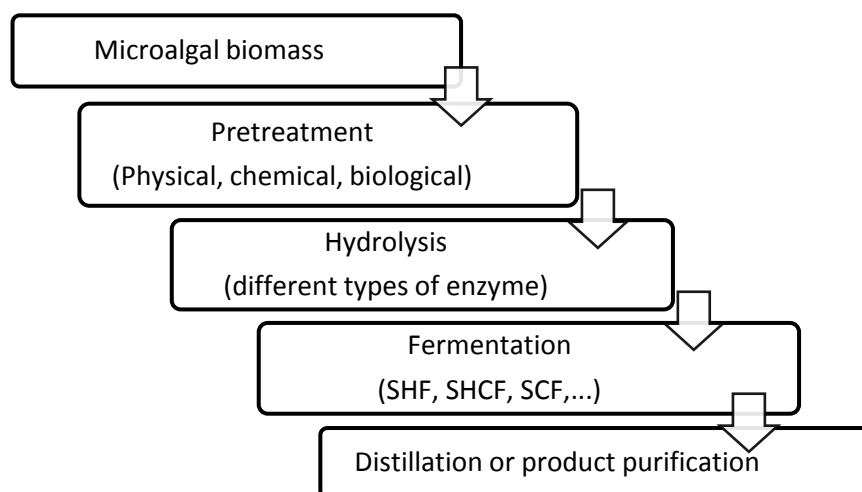

Figure 12. General process of bioethanol production from microalgal biomass

#### 3.4.3.1 Pretreatment for bioethanol production

Appears to be the most important and expensive step in bioethanol production from microalgae, pretreatment accounts for 33 % of the total cost (Talebnia et al., 2010). The objectives are obtaining sugars directly, preventing loss from degrading biomass, limiting the toxic materials, which inhibit the bioethanol production, reducing energy input requirements and minimizing the operational cost. There are four pretreatment techniques: physical (e.g. milling and grinding), chemical (e.g. steam explosion), physicochemical and biological pretreatment (Hill et al., 2006) (Figure 12).

Mechanical comminution is a combination of chipping, milling and grinding to reduce the particle sizes of the microalgal biomass and increase the specific surface by reducing cellulose crystallinity. For example, chipping is used when the particle size of 10-30 mm is required while milling and grinding are for more fine particles (0.2-2 mm) (Alvira et al., 2010).

Steam explosion method is a technique that provides accessibility to the degradation of cellulose. This method consists of the heating of biomass under high-pressure steam (20-50 bar, 160-270 °C) for a few minutes, then the reaction is stopped when the pressure conditions reach the atmospheric conditions (Balat et al., 2008).

Biological treatment is considered as the most environmentally friendly method since it avoids using chemical elements, consumes less energy effort, does not required specific reactors that are resistant to corrosion and pressure, and minimum inhibitor formation (Keller et al., 2003). Various types of fungi can be used to degrade biomass into lignin, hemicellulose, and cellulose partially.

#### 3.4.3.2 Hydrolysis

Saccharification is the critical step for bioethanol production in which complex carbohydrates are converted to simple monomers. The two major hydrolysis methods are acid hydrolysis (with dilute

and concentrated acids) and enzymatic hydrolysis (Saha et al., 2005). The use of acid hydrolysis is limited due to high cost, corrosion of containment material and formation of inhibiting compounds (Sun and Cheng, 2002).

Enzymatic hydrolysis employs enzymes, which can be obtained from bacteria and fungi, to ferment sugars. The method requires less energy, occurs at a mild temperature, has a variable pH range (e.g., pH 4.5-5 with temperature ranges from 40-50 °C) and avoids corrosion problem (Sanchez et al., 2004). Though, expensive enzymes for pretreatment drives the cost of bioethanol several folds higher. Cellulose hydrolysis is catalyzed by a class of enzymes called cellulases (Talebnia et al., 2010). Cellulase degrades cellulose to sugars which later are fermented to become ethanol. This process occurs through adsorption, biodegradation and desorption steps (Talebnia et al., 2010). The fermentable sugars are produced according to the reaction (5).

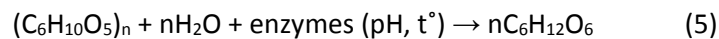

#### 3.4.3.3 Fermentation

Fermentation is done based on the disciplines of chemistry, biochemistry, and microbiology, in which fermentable sugars are converted to ethanol by microorganisms (Almodares and Hadi, 2009). This process consists of a conversion of glucose to alcohol and carbon dioxide.

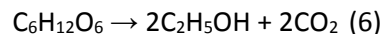

Fermentation can be done using different strategies such as separate hydrolysis and fermentation (SHF), simultaneous saccharification and fermentation (SSF), separate hydrolysis and co-fermentation (SHCF), simultaneous saccharification and co-fermentation (SSCF) and consolidated bioprocessing (CBP) (Danquah et al., 2011) (Figure 12). The first two methods are most commonly implemented.

#### 3.4.4 Biodiesel production

Among all the fuels, biodiesel is a commonly studied derivative because of its potentials to replace completely the petroleum in transportation. Most commonly, biodiesel is produced by transesterification, which is a chemical conversion of triglycerides into methyl esters using solvent and catalyst (Meher et al., 2006). The production of biodiesel from microalgae has been mainly performed in two phases: lipid extraction and transesterification. Besides, biodiesel also can be produced through direct transesterification.

#### 3.4.4.1 Lipid extraction

This is an important step in which oil is extracted as feedstock for biodiesel. The lipid extraction techniques could be divided into four main types that are chemical solvents, supercritical CO<sub>2</sub>, physicochemical and biochemical.

- **Chemical solvents extraction**

Using chemical solvents is the most common method since microalgal cells are easily disrupted by a chemical such as acids, alkalis, and surfactants. These chemicals degrade the chemical linkages on the cell cover or osmotic pressure. The main advantages of this method are that it does not require a much heat or energy (Kim et al., 2013). However, it is not effective when biomass is wet (Samori et al., 2010).

- **Supercritical carbon dioxide extraction**

The method utilizes pressurized carbon dioxide to accomplish the lipid extraction. The extraction is allowed to take place in room temperature environments, thus, purer and less thermally decomposed extract is generated. Supercritical CO<sub>2</sub> has the advantages of being not toxic, easy to recover and usable at low temperature (less than 40 °C) (Andrich et al., 2005). However, this technique requires expensive equipment (Perrut, 2000) and a large amount of energy to reach high pressure (Tan and Lee, 2011). Unlike chemical solvent extraction, supercritical CO<sub>2</sub> lipid extraction can be stimulated by the presence of water in the blend of microalgae.

- **Physicochemical extraction**

Some physicochemical techniques like microwave, autoclaving, osmotic shock, bead beating, homogenization, freeze-drying, grinding and sonication can be used for microalgal cell disruption (Cooney et al., 2009; Lee et al., 2010, 1998). Among the choices, microwave seems to be the most promising technique to increase the lipid yield (Lee et al., 2010). The method utilizes electromagnetic radiation within a specific frequency range to heat the cells and increase the internal pressure. As the cells rupture, a rapid explosion of the cell constituents quickly diffuses lipids (Bahadar and Bilal Khan, 2013).

- **Biochemical extraction**

The option demonstrates biological degradations of the cell envelopes using enzymes. Its advantages are mild reaction conditions and the highly selective enzymatic mechanism as a specific chemical linkage is accurately cut down. However, a drawback of this method is the high cost of enzymes.

### 3.4.4.2 Transesterification

In transesterification process, triglycerides will react with a short-chain alcohol in the presence of catalysts such as acid, alkali or lipase enzymes to create biodiesel, which possesses short-chain alkyl (methyl, ethyl or propyl) esters. Transesterification includes three consecutive steps where triglycerides are first converted to diglycerides, monoglycerides and esters (biodiesel) respectively and by-product (glycerol). The transesterification reaction can be described in Figure 13, with R1, R2 and R3 are long-chain hydrocarbons, also known as fatty acids (Mata et al., 2010).

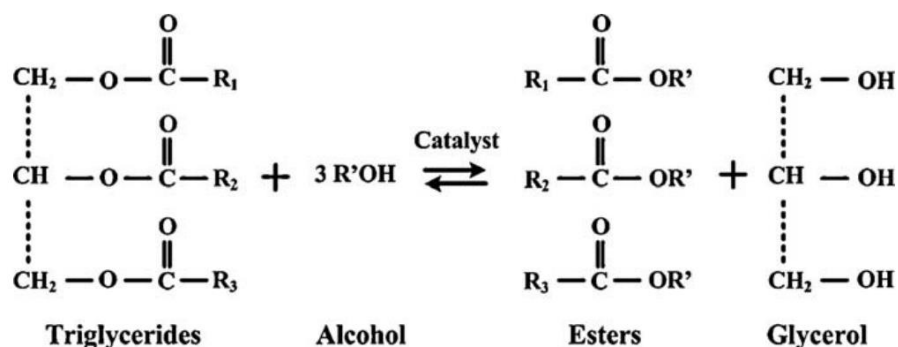

Figure 13. Biodiesel production through transesterification of triglycerides (Mata et al., 2010)

In transesterification, the reaction reaches an equilibrium where each mole of triglyceride requires 3 moles of alcohol to produce 1 mole of glycerol and 3 moles of methyl esters (Figure 13). For industrial scale, up to 6 moles of methanol is used excessively for every mole of triglyceride (Fukuda et al., 2001) to guarantee the rightward direction of the reaction i.e. towards biodiesel. Fukuda et al., (2001) showed that the yield of methyl esters exceeded 98 % on a weight basis. Alcoholic solvents are often used including the short-chain class such as methanol, ethanol, and isopropanol (Ghadge and Raheman, 2006).

In application, methanol and alkali catalyst (NaOH or KOH) are most commonly used because the cost of methanol is the least expensive and alkali catalyst is useful to increase the reaction rate. According to Fukuda et al., (2001), alkali-catalyzed transesterification is about 4000 times faster than an acid catalyst. However, the use of lipase enzymes catalyst is not feasible because of its high cost.

Microalgal biodiesel and by-products must be separated after the reaction. There are various choices for separation such as hot water (50 °C) (Li et al., 2007), organic solvents like hexane (Halim et al., 2011; Wiltshire et al., 2000) and water organic solvent for a liquid-liquid separation (Couto et al., 2010; Lewis et al., 2000; Samori et al., 2010). When using a non-polar co-solvent for transesterification, only water is added for the separation (Johnson and Wen, 2009).

#### 3.4.4.3 Direct transesterification

Direct transesterification or in-situ transesterification is a combination of lipid extraction and biodiesel conversion. In this method, biodiesel is produced directly when lipid extraction by alcohol and transesterification occur simultaneously. Microalgal biomass, alcohol, and catalyst are mixed together and heated to high temperature. The process does not require the separation of lipid from the extractive solvents or the supercritical carbon dioxide so that it can reduce the energy consumed. Direct transesterification using heterogeneous catalyst can be more effective if coupling with microwave heating. Additionally, the technique requires dry biomass for an effective operation.

## 4. Application and Conclusion

In order to transform microalgae and cyanobacteria into potential green energy sources, it is a must to commercialize the production. The very early large-scale production of algal biomass has been studied since World War II to derive new principal supplement for the consumption of humans (Chaumont, 1993). Shortly after, microalgae were suggested as a source for biofuels. Until now, billions of dollars have been invested in the research of algae-based technologies. Singh and Gu, (2010) showed that most of the companies contributing to the development of algal biofuel drive are based in America and Europe. Furthermore, they listed several projects which were funded to develop the technologies to convert biofuels from microalgae. The biggest algae investment in the EU, which was £26 million, was implemented by Algae Biofuels Challenge in 2009. BioMara project, which was funded €6 million by the Scottish government, aimed at not just single-celled algae species but also larger seaweed species. The \$92 million-worth partnership between the Spanish company Aurantia and Green Fuel Tech of Massachusetts (USA) was formed to target the goal of producing 25,000 tons/year of algal biomass. Currently, there are many companies worldwide which are concentrating on producing renewable fuels such as Transalgae (Israel), AlgaEnergy (Spain), Algae Systems, Algaenol (USA), Aquafuel (Britain), IHI NeoG Algae (Japan), Muradel (Australia), Pond Biofuels (Canada), etc. A new concept in which companies produce a wide range of products including nutrition, cosmetics and fuels is adopted largely and globally such as AlgaeEnergy (Spain), Univerre (Israel), Euglena (Japan) (Lane, 2015; Leichman, 2016). Recently, the two companies majoring in biofuel production from microalgae Joule and Cellana (USA) have been nominated in the “Hottest 40 Companies in the Biobased Economy for 2015-2016” released in ABLC NEXT 2015 conference. The tribute has marked a significant milestone in the progress towards green energy based on microalgae.

In conclusion, the review validates that microalgae and cyanobacteria offer great potential as promising feedstocks and the production of third generation biofuels is feasible and sustainable. However, the obstacles existing in scaling up technologies in biomass generation, harvesting, and oil

extraction are the reasons that make large-scale biofuel production expensive. Primary enhancements should be conducted to optimize the efficiency through technological innovation and genetically modification. Utilizing the photobioreactor engineering will further lower the cost of production. Referring to the current growth of microalgal fuel market, it appears to be promising that the microalgal fuel industry is becoming strongly invested and more effective commercial strategies of the biofuel from microalgae are being adopted.



## References

- [Adams, M.W., 1990. The structure and mechanism of iron-hydrogenases. \*Biochim. Biophys. Acta\* 1020, 115–145. doi:10.1016/0005-2728\(90\)90044-5](#)
- [Almodares, A., Hadi, M.R., 2009. Production of bioethanol from sweet sorghum: A review. \*Afr. J. Agric. Res.\* 4, 772–780.](#)
- [Alvira, P., Tomás-Pejó, E., Ballesteros, M., Negro, M.J., 2010. Pretreatment technologies for an efficient bioethanol production process based on enzymatic hydrolysis: A review. \*Bioresour. Technol.\* 101, 4851–4861. doi:10.1016/j.biortech.2009.11.093](#)
- [Andrich, G., Nesti, U., Venturi, F., Zinnai, A., Fiorentini, R., 2005. Supercritical fluid extraction of bioactive lipids from the microalga \*Nannochloropsis\* sp. \*Eur. J. Lipid Sci. Technol.\* 107, 381–386. doi:10.1002/ejlt.200501130](#)
- [Anemaet, I.G., Bekker, M., Hellingwerf, K.J., 2010. Algal Photosynthesis as the Primary Driver for a Sustainable Development in Energy, Feed, and Food Production. \*Mar. Biotechnol. N. Y.\* 12, 619–629. doi:10.1007/s10126-010-9311-1](#)
- [Bahadar, A., Bilal Khan, M., 2013. Progress in energy from microalgae: A review. \*Renew. Sustain. Energy Rev.\* 27, 128–148. doi:10.1016/j.rser.2013.09.029](#)
- [Balat, M., Balat, H., Öz, C., 2008. Progress in bioethanol processing. \*Prog. Energy Combust. Sci.\* 34, 551–573. doi:10.1016/j.pecs.2007.11.001](#)
- [Barbosa, M.J., Albrecht, M., Wijffels, R.H., 2003. Hydrodynamic stress and lethal events in sparged microalgae cultures. \*Biotechnol. Bioeng.\* 83, 112–120. doi:10.1002/bit.10657](#)
- [Berg, H.C., Brown, D.A., 1972. Chemotaxis in \*Escherichia coli\* analysed by three-dimensional tracking. \*Nature\* 239, 500–504.](#)
- [Bosma, R., van Spronsen, W.A., Tramper, J., Wijffels, R.H., 2003. Ultrasound, a new separation technique to harvest microalgae. \*J. Appl. Phycol.\* 15, 143–153. doi:10.1023/A:1023807011027](#)
- [Brennan, L., Owende, P., 2010. Biofuels from microalgae—A review of technologies for production, processing, and extractions of biofuels and co-products. \*Renew. Sustain. Energy Rev.\* 14, 557–577. doi:10.1016/j.rser.2009.10.009](#)
- [Bronnenmeier, R., Märkl, H., 1982. Hydrodynamic stress capacity of microorganisms. \*Biotechnol. Bioeng.\* 24, 553–578. doi:10.1002/bit.260240304](#)
- [Camacho, F.G., Gómez, A.C., Sobczuk, T.M., Grima, E.M., 2000. Effects of mechanical and hydrodynamic stress in agitated, sparged cultures of \*Porphyridium cruentum\*. \*Process Biochem.\* 35, 1045–1050. doi:10.1016/S0032-9592\(00\)00138-2](#)
- [Carvalho, A.P., Meireles, L.A., Malcata, F.X., 2006. Microalgal reactors: a review of enclosed system designs and performances. \*Biotechnol. Prog.\* 22, 1490–1506. doi:10.1021/bp060065r](#)
- [Chaumont, D., 1993. Biotechnology of algal biomass production: a review of systems for outdoor mass culture. \*J. Appl. Phycol.\* 5, 593–604. doi:10.1007/BF02184638](#)
- [Chisti, Y., 2016. Large-Scale Production of Algal Biomass: Raceway Ponds, in: Bux, F., Chisti, Y. \(Eds.\), \*Algae Biotechnology\*. Springer International Publishing, Cham, pp. 21–40.](#)
- [Chisti, Y., 2013. Raceways-based Production of Algal Crude Oil. \*Green\* 3, 195–216. doi:10.1515/green-2013-0018](#)
- [Chisti, Y., 2007. Biodiesel from microalgae. \*Biotechnol. Adv.\* 25, 294–306. doi:10.1016/j.biotechadv.2007.02.001](#)
- [Cooney, M., Maynard, N., Cannizzaro, C., Benemann, J., 2007. Two-phase anaerobic digestion for production of hydrogen–methane mixtures. \*Bioresour. Technol.\* 98, 2641–2651. doi:10.1016/j.biortech.2006.09.054](#)
- [Cooney, M., Young, G., Nagle, N., 2009. Extraction of Bio-oils from Microalgae. \*Sep. Purif. Rev.\* 38, 291–325. doi:10.1080/15422110903327919](#)
- [Costa, J.A.V., de Moraes, M.G., 2011. The role of biochemical engineering in the production of biofuels from microalgae. \*Bioresour. Technol.\* 102, 2–9. doi:10.1016/j.biortech.2010.06.014](#)

- [Couto, R.M., Simões, P.C., Reis, A., Da Silva, T.L., Martins, V.H., Sánchez-Vicente, Y., 2010. Supercritical fluid extraction of lipids from the heterotrophic microalga \*Cryptocodinium cohnii\*. Eng. Life Sci. NA–NA. doi:10.1002/elsc.200900074](#)
- [Danquah, M., Liu, B., Haru, R., 2011. Analysis of process configurations for bioethanol production from microalgal biomass, in: Shaukat, S. \(Ed.\), Progress in Biomass and Bioenergy Production. InTech.](#)
- [Diltz, R., Pullammanappallil, P., 2013. Biofuels from Algae, in: Fang, Z. \(Ed.\), Liquid, Gaseous and Solid Biofuels - Conversion Techniques. InTech.](#)
- [Ehimen, E.A., Holm-Nielsen, J.-B., Poulsen, M., Boelsmand, J.E., 2013. Influence of different pre-treatment routes on the anaerobic digestion of a filamentous algae. Renew. Energy 50, 476–480. doi:10.1016/j.renene.2012.06.064](#)
- [Fukuda, H., Kondo, A., Noda, H., 2001. Biodiesel fuel production by transesterification of oils. J. Biosci. Bioeng. 92, 405–416. doi:10.1016/S1389-1723\(01\)80288-7](#)
- [Ghadge, S.V., Raheman, H., 2006. Process optimization for biodiesel production from mahua \(\*Madhuca indica\*\) oil using response surface methodology. Bioresour. Technol. 97, 379–384. doi:10.1016/j.biortech.2005.03.014](#)
- [Gouveia, L., 2011. Microalgae as a Feedstock for Biofuels. Springer Berlin Heidelberg, Berlin, Heidelberg.](#)
- [Gouveia, L., Oliveira, A.C., 2009. Microalgae as a raw material for biofuels production. J. Ind. Microbiol. Biotechnol. 36, 269–274. doi:10.1007/s10295-008-0495-6](#)
- [Grobelaar, J.U., 2003. Algal Nutrition – Mineral Nutrition, in: Richmond, A. \(Ed.\), Handbook of Microalgal Culture. Blackwell Publishing Ltd, pp. 95–115.](#)
- [Halim, R., Gladman, B., Danquah, M.K., Webley, P.A., 2011. Oil extraction from microalgae for biodiesel production. Bioresour. Technol. 102, 178–185. doi:10.1016/j.biortech.2010.06.136](#)
- [Hallenbeck, P.C., Benemann, J.R., 2002. Biological hydrogen production; fundamentals and limiting processes. Int. J. Hydrog. Energy 27, 1185–1193.](#)
- [Harun, R., Danquah, M.K., Forde, G.M., 2009. Microalgal biomass as a fermentation feedstock for bioethanol production. J. Chem. Technol. Biotechnol. n/a–n/a. doi:10.1002/jctb.2287](#)
- [Harun, R., Singh, M., Forde, G.M., Danquah, M.K., 2010. Bioprocess engineering of microalgae to produce a variety of consumer products. Renew. Sustain. Energy Rev. 14, 1037–1047. doi:10.1016/j.rser.2009.11.004](#)
- [Hill, J., Nelson, E., Tilman, D., Polasky, S., Tiffany, D., 2006. Environmental, economic, and energetic costs and benefits of biodiesel and ethanol biofuels. Proc. Natl. Acad. Sci. 103, 11206–11210.](#)
- [Hu, Q., Kurano, N., Kawachi, M., Iwasaki, I., Miyachi, S., 1998. Ultrahigh-cell-density culture of a marine green alga \*Chlorococcum littorale\* in a flat-plate photobioreactor. Appl. Microbiol. Biotechnol. 49, 655–662. doi:10.1007/s002530051228](#)
- [Johnson, M.B., Wen, Z., 2009. Production of Biodiesel Fuel from the Microalga \*Schizochytrium limacinum\* by Direct Transesterification of Algal Biomass. Energy Fuels 23, 5179–5183. doi:10.1021/ef900704h](#)
- [Kaiwan-arporn, P., Hai, P.D., Thu, N.T., Annachhatre, A.P., 2012. Cultivation of cyanobacteria for extraction of lipids. Biomass Bioenergy 44, 142–149. doi:10.1016/j.biombioe.2012.04.017](#)
- [Kapdi, S.S., Vijay, V.K., Rajesh, S.K., Prasad, R., 2005. Biogas scrubbing, compression and storage: perspective and prospectus in Indian context. Renew. Energy 30, 1195–1202. doi:10.1016/j.renene.2004.09.012](#)
- [Keller, F.A., Hamilton, J.E., Nguyen, Q.A., 2003. Microbial pretreatment of biomass. Appl. Biochem. Biotechnol. 105, 27–41.](#)
- [Kim, J., Yoo, G., Lee, H., Lim, J., Kim, K., Kim, C.W., Park, M.S., Yang, J.-W., 2013. Methods of downstream processing for the production of biodiesel from microalgae. Biotechnol. Adv. 31, 862–876. doi:10.1016/j.biotechadv.2013.04.006](#)

- Lane, J., 2015. What's Up with the Algae Biofuels Industry? [WWW Document]. URL <http://www.renewableenergyworld.com/articles/2015/07/what-s-up-with-the-algae-biofuels-industry.html>(accessed 7.27.16).
- Lee, A.K., Lewis, D.M., Ashman, P.J., 2012. Disruption of microalgal cells for the extraction of lipids for biofuels: Processes and specific energy requirements. *Biomass Bioenergy* 46, 89–101. doi:10.1016/j.biombioe.2012.06.034
- Lee, J.-Y., Yoo, C., Jun, S.-Y., Ahn, C.-Y., Oh, H.-M., 2010. Comparison of several methods for effective lipid extraction from microalgae. *Bioresour. Technol.* 101, S75–S77. doi:10.1016/j.biortech.2009.03.058
- Lee, S.J., Yoon, B.-D., Oh, H.-M., 1998. Rapid method for the determination of lipid from the green alga *Botryococcus braunii*. *Biotechnol. Tech.* 12, 553–556. doi:10.1023/A:1008811716448
- Leichman, A.K., 2016. Is 2016 the year of algae? [WWW Document]. Israel21c. URL <http://www.israel21c.org/is-2016-the-year-of-the-algae/> (accessed 7.27.16).
- Lewis, T., Nichols, P.D., McMeekin, T.A., 2000. Evaluation of extraction methods for recovery of fatty acids from lipid-producing microheterotrophs. *J. Microbiol. Methods* 43, 107–116.
- Li, X., Xu, H., Wu, Q., 2007. Large-scale biodiesel production from microalga *Chlorella protothecoides* through heterotrophic cultivation in bioreactors. *Biotechnol. Bioeng.* 98, 764–771. doi:10.1002/bit.21489
- Luo, H.-P., Al-Dahhan, M.H., 2012. Airlift column photobioreactors for *Porphyridium* sp. culturing: part I. effects of hydrodynamics and reactor geometry. *Biotechnol. Bioeng.* 109, 932–941. doi:10.1002/bit.24361
- Lürling, M., Eshetu, F., Faassen, E.J., Kosten, S., Huszar, V.L.M., 2013. Comparison of cyanobacterial and green algal growth rates at different temperatures: *Temperature and phytoplankton growth rates*. *Freshw. Biol.* 58, 552–559. doi:10.1111/j.1365-2427.2012.02866.x
- Madamwar, D., Garg, N., Shah, V., 2001. Cyanobacterial hydrogen production. *World J. Microbiol. Biotechnol.* 16, 757–767. doi:10.1023/A:1008919200103
- Mata, T.M., Martins, A.A., Caetano, N.S., 2010. Microalgae for biodiesel production and other applications: A review. *Renew. Sustain. Energy Rev.* 14, 217–232. doi:10.1016/j.rser.2009.07.020
- Meher, L., Vidyasagar, D., Naik, S., 2006. Technical aspects of biodiesel production by transesterification—a review. *Renew. Sustain. Energy Rev.* 10, 248–268. doi:10.1016/j.rser.2004.09.002
- Mendez, L., Mahdy, A., Timmers, R.A., Ballesteros, M., González-Fernández, C., 2013. Enhancing methane production of *Chlorella vulgaris* via thermochemical pretreatments. *Bioresour. Technol.* 149, 136–141. doi:10.1016/j.biortech.2013.08.136
- Mirón, A.S., García, M.C.C., Gómez, A.C., Camacho, F.G., Grima, E.M., Chisti, Y., 2003. Shear stress tolerance and biochemical characterization of *Phaeodactylum tricorutum* in quasi steady-state continuous culture in outdoor photobioreactors. *Biochem. Eng. J.* 16, 287–297. doi:10.1016/S1369-703X(03)00072-X
- Molina Grima, E., Fernández, F.G.A., García Camacho, F., Chisti, Y., 1999. Photobioreactors: light regime, mass transfer, and scaleup. *J. Biotechnol.* 70, 231–247. doi:10.1016/S0168-1656(99)00078-4
- Nyomi Uduman, Ying Qi, 2010. Dewatering of microalgal cultures: A major bottleneck to algae-based fuels. doi:10.1063/1.3294480
- Paris Hongley Chen, William J. Oswald, 1998. Thermochemical treatment for algal fermentation.pdf. *Environ. Int.* 24, 889–897. doi:10.1016/S0160-4120(98)00080-4
- Passos, F., Ferrer, I., 2015. Influence of hydrothermal pretreatment on microalgal biomass anaerobic digestion and bioenergy production. *Water Res.* 68, 364–373. doi:10.1016/j.watres.2014.10.015
- Passos, F., Uggetti, E., Carrère, H., Ferrer, I., 2014. Pretreatment of microalgae to improve biogas production: A review. *Bioresour. Technol.* 172, 403–412. doi:10.1016/j.biortech.2014.08.114

- [Perrut, M., 2000. Supercritical Fluid Applications: Industrial Developments and Economic Issues. \*Ind. Eng. Chem. Res.\* 39, 4531–4535. doi:10.1021/ie000211c](#)
- [Quintana, N., Van der Kooy, F., Van de Rhee, M.D., Voshol, G.P., Verpoorte, R., 2011. Renewable energy from Cyanobacteria: energy production optimization by metabolic pathway engineering. \*Appl. Microbiol. Biotechnol.\* 91, 471–490. doi:10.1007/s00253-011-3394-0](#)
- [Saha, B.C., Iten, L.B., Cotta, M.A., Wu, Y.V., 2005. Dilute acid pretreatment, enzymatic saccharification and fermentation of wheat straw to ethanol. \*Process Biochem.\* 40, 3693–3700. doi:10.1016/j.procbio.2005.04.006](#)
- [Samorì, C., Torri, C., Samorì, G., Fabbri, D., Galletti, P., Guerrini, F., Pistocchi, R., Tagliavini, E., 2010. Extraction of hydrocarbons from microalga \*Botryococcus braunii\* with switchable solvents. \*Bioresour. Technol.\* 101, 3274–3279. doi:10.1016/j.biortech.2009.12.068](#)
- [Sanchez, G., Pilcher, L., Roslander, C., Modig, T., Galbe, M., Liden, G., 2004. Dilute-acid hydrolysis for fermentation of the Bolivian straw material Paja Brava. \*Bioresour. Technol.\* 93, 249–256. doi:10.1016/j.biortech.2003.11.003](#)
- [Sánchez Pérez, J.A., Rodríguez Porcel, E.M., Casas López, J.L., Fernández Sevilla, J.M., Chisti, Y., 2006. Shear rate in stirred tank and bubble column bioreactors. \*Chem. Eng. J.\* 124, 1–5. doi:10.1016/j.cej.2006.07.002](#)
- [Saragosti, J., Silberzan, P., Buguin, A., 2012. Modeling \*E. coli\* tumbles by rotational diffusion. Implications for chemotaxis. \*PloS One\* 7, e35412. doi:10.1371/journal.pone.0035412](#)
- [Scarsella, M., Torzillo, G., Cicci, A., Belotti, G., De Filippis, P., Bravi, M., 2012. Mechanical stress tolerance of two microalgae. \*Process Biochem.\* 47, 1603–1611. doi:10.1016/j.procbio.2011.07.002](#)
- [Schenk, P.M., Thomas-Hall, S.R., Stephens, E., Marx, U.C., Mussnug, J.H., Posten, C., Kruse, O., Hankamer, B., 2008. Second Generation Biofuels: High-Efficiency Microalgae for Biodiesel Production. \*BioEnergy Res.\* 1, 20–43. doi:10.1007/s12155-008-9008-8](#)
- [Schwede, S., Rehman, Z.-U., Gerber, M., Theiss, C., Span, R., 2013. Effects of thermal pretreatment on anaerobic digestion of \*Nannochloropsis salina\* biomass. \*Bioresour. Technol.\* 143, 505–511. doi:10.1016/j.biortech.2013.06.043](#)
- [Singh, J., Gu, S., 2010. Commercialization potential of microalgae for biofuels production. \*Renew. Sustain. Energy Rev.\* 14, 2596–2610.](#)
- [Sobczuk, T.M., Camacho, F.G., Grima, E.M., Chisti, Y., 2006. Effects of agitation on the microalgae \*Phaeodactylum tricornutum\* and \*Porphyridium cruentum\*. \*Bioprocess Biosyst. Eng.\* 28, 243–250. doi:10.1007/s00449-005-0030-3](#)
- [Solomon, T.H., Weeks, E.R., Swinney, H.L., 1994. Chaotic advection in a two-dimensional flow: Lévy flights and anomalous diffusion. \*Phys. Nonlinear Phenom.\* 76, 70–84. doi:10.1016/0167-2789\(94\)90251-8](#)
- [Spolaore, P., Joannis-Cassan, C., Duran, E., Isambert, A., 2006. Commercial applications of microalgae. \*J. Biosci. Bioeng.\* 101, 87–96. doi:10.1263/jbb.101.87](#)
- [Sun, Y., Cheng, J., 2002. Hydrolysis of lignocellulosic materials for ethanol production: a review. \*Bioresour. Technol.\* 83, 1–11. doi:10.1016/S0960-8524\(01\)00212-7](#)
- [Talebna, F., Karakashev, D., Angelidaki, I., 2010. Production of bioethanol from wheat straw: An overview on pretreatment, hydrolysis and fermentation. \*Bioresour. Technol.\* 101, 4744–4753. doi:10.1016/j.biortech.2009.11.080](#)
- [Tan, K.T., Lee, K.T., 2011. A review on supercritical fluids \(SCF\) technology in sustainable biodiesel production: Potential and challenges. \*Renew. Sustain. Energy Rev.\* 15, 2452–2456. doi:10.1016/j.rser.2011.02.012](#)
- [Ugwu, C.U., Aoyagi, H., Uchiyama, H., 2008. Photobioreactors for mass cultivation of algae. \*Bioresour. Technol.\* 99, 4021–4028. doi:10.1016/j.biortech.2007.01.046](#)
- [Vourc’h, T., Leopoldes, J., Meajeun, A., Peerhossaini, H., 2016. Motion of active fluids: diffusion dynamics of cyanobacteria, in: FEDSM2016-7526. Presented at the Proceedings of the ASME 2016 Fluids Engineering Division Summer Meeting, Washington, DC, USA.](#)

- [Wang, B., Li, Y., Wu, N., Lan, C.Q., 2008. CO<sub>2</sub> bio-mitigation using microalgae. \*Appl. Microbiol. Biotechnol.\* 79, 707–718. doi:10.1007/s00253-008-1518-y](#)
- Wen, Z., Johnson, M.B., 2009. Microalgae as a Feedstock for Biofuel Production | Publications and Educational Resources | Virginia Tech [WWW Document]. URL <https://pubs.ext.vt.edu/442/442-886/442-886.html> (accessed 7.26.16).
- [Wiltshire, K.H., Boersma, M., Möller, A., Buhtz, H., 2000. Extraction of pigments and fatty acids from the green alga \*Scenedesmus obliquus\* \(Chlorophyceae\). \*Aquat. Ecol.\* 34, 119–126.](#)
- [Yen, H., Brune, D., 2007. Anaerobic co-digestion of algal sludge and waste paper to produce methane. \*Bioresour. Technol.\* 98, 130–134. doi:10.1016/j.biortech.2005.11.010](#)
- [Zaburdaev, V., Biais, N., Schmiedeberg, M., Eriksson, J., Jonsson, A.-B., Sheetz, M.P., Weitz, D.A., 2014. Uncovering the mechanism of trapping and cell orientation during \*Neisseria gonorrhoeae\* twitching motility. \*Biophys. J.\* 107, 1523–1531. doi:10.1016/j.bpj.2014.07.061](#)