

IoT Implementation in Remote Measuring Laboratory VMLab Analyses

**Tibor Vince, Matej Bereš, Irena Kováčová, Ján Molnár, Branislav Fecko
Jozef Dziak, Iveta Tomčíková, Milan Guzan**

(Department of Theoretical and Industrial Electrical Engineering, FEI TU Košice, Slovakia,
tibor.vince@tuke.sk, matej.beres@tuke.sk, irena.kovacova@tuke.sk, jan.molnar@tuke.sk,
branislav.fecko@tuke.sk, jozef.dziak@tuke.sk, iveta.tomcikova@tuke.sk,
milan.guzan@tuke.sk)

Abstract: The paper presents analyses of the implementation of IoT in the patent technology of the remote measuring laboratory (VMLab). The technology allows to create a new electrical connection between different devices, where the connection diagram was not defined before. This may be done remotely around the world. To begin with, an application of this technology as a remote measuring laboratory is presented and described. Analyses of the possible application of IoT technology in the Remote Measurement Laboratory (VMLAB) with a final design are also presented. The research focuses on an efficient way to retrieve measured values synchronized over the Internet from multiple measuring devices and controllable devices, without an Ethernet or Wi-Fi interface from the manufacturer. The analyses may also be useful when implementing an additional IoT approach to existing systems.

Keywords: Computer aided engineering, Engineering education, Laboratories, IoT, Telemetry
Categories: B.4.2, B.4.3, B.7.0, C.2.2, C.2.4, C.5.m, L.2

1 Introduction

Remote laboratory can be generally introduced as a very useful educational tool, especially in distance learning in secondary schools or at universities. It can be applied especially in engineering or physics courses. The remote laboratory with limited functions can be assigned even as a student project in automation or measurement classes. [Bonavolontà, 19]. The Department of Theoretical and Industrial Electrical Engineering (DTIEE) at the Technical University of Košice, Faculty of Electrical Engineering and Informatics is focused on the education of young engineers and research in the field of industrial electrical engineering, but not only. Knowledge and experiences with electrical circuits and measurements are required for electrical engineering students but also for students of informatics at the university. The academic community is greatly influenced by the innovation process improvement and the results of the specific research projects. When we want to keep up with the recent modern systems, innovations, and technologies, we have to realize that we are facing several problems in the educational process. We have usually limited time and lack of teaching. The typical situation in the class is when one teacher guides 12-15 students during the lesson in the laboratory. The Common task of students is to build an electrical circuit and measure some parameters of the circuit. Due to lack of time, equipment, and staff per task, only few students get chance to build the entire electrical circuit. Most of the students are just in a role of observers. The capacity of the laboratories and number of

the professionals do not allow every student out of several hundred to create their own circuit and get experienced. Another problem that requires relatively great effort is to conduct this type of courses within the distance learning, especially e-Learning. These days, the Internet is commonly used to provide educational materials in electronic form. The e-Learning term, used earlier in the definition of education methods containing electronic aids has been used as an equivalent for Internet-based distance learning. Internet connectivity and communication allow the worldwide distribution of the resources (software, hardware, knowledge or data) and get to the workers or students in their home's environment. Even the technology is originally intended to be used within the education process or in the academic field, it can also be used in the production field of area. [Kováč, 16]. This issue is of particular importance in times of pandemic (Covid-19) when the full-time form of study is severely limited.

The prototype of the Remote Measurement Laboratory VMLab has been designed [Kováč, 09] and implemented [Vince, 11]. However, the prototype was focused on the technology only. Other features have been neglected. The prototype uses deprecated interfaces like LPT, RS232, etc. To further maintain and expand this prototype, it is essential to keep up with the times. This means applying a new approach to the system of remote measurement laboratory VMLab.

The term Internet of Things (IoT) became widely used in the 1990s. It starts with several technologies associated with the sensors development and automation connected to the web pages. Wireless sensor network development has resulted in an expansion of IoT applications in different areas such are homes, healthcare and also industry. There are a lot of opportunities with IoT technologies by providing effective, real-time Internet operations. There are many problems in integrating many stand-alone IoT systems associated with measurement and instrumentation practices to make sure required accuracy in the application environment is reached. [Jardim-Goncalves, 19]. The IoT-GSI (Global Standards Initiative on the Internet of Things) from 2014 defines IoT as “the infrastructure of the information society”. IoT created the technology by integrating the physical world with computer systems. It includes machine and human and machine to machine interconnection via smart devices such as actuators, sensors, software and electronics. The IoT technology has become more widespread in nearly all areas of smart cities or automation. Environments with Internet connection expects to handle large quantities of data from many places. The efficiency has to be taken into account. The IoT has been developed into one of the platforms in the energy or smart city Internet. [Theera-Umpon, 18] but also in different forms of smart services such as the Industry 4.0, smart medical care, etc. [Lin, 18].

This paper shows possibilities to upgrade existing systems based on sensors and actuators using different interfaces like RS232 and others to IoT system.

2 Variable conductive connections technology

One of the main advantages of such a variable conductive connection technology solutions lies on the variability and adaptability which will guarantee competitiveness and greater production efficiency. Because the production process as well as its modification can be automated for other activities, the subjective human factor often responsible for errors could be suppressed.

2.1 Variable electrical connections structure

The structure of such variable connection technology is shown in the Figure 1. The entire technology consists of the following components: electrical connection lines, switches cards and electrical components.

Electrical components are e.g. devices with ability to communicate with PC, any non-sophisticated components like electrical resistor, coil, capacitor and special impedance component up to the microcontrollers, various power sources (AC, DC) or measurement devices like voltmeter, ammeter, wattmeter or more sophisticated devices like oscilloscope, analyzers etc. Each electrical circuit can vary in number of the electrical components as well as in number of the terminals. Most of the components have 2 terminals – impedances, voltmeters, power sources, etc. Some of them might have more connectors like wattmeter, complex impedance, or logical electrical circuits.

Each terminal (connector) of electrical component is connected to the one of switches card. Switches card is a special electrical equipment which can connect the terminal of the electrical component with specific electrical connection line. For each connection line there is one single pole single throw switch (relay) on the switches card.

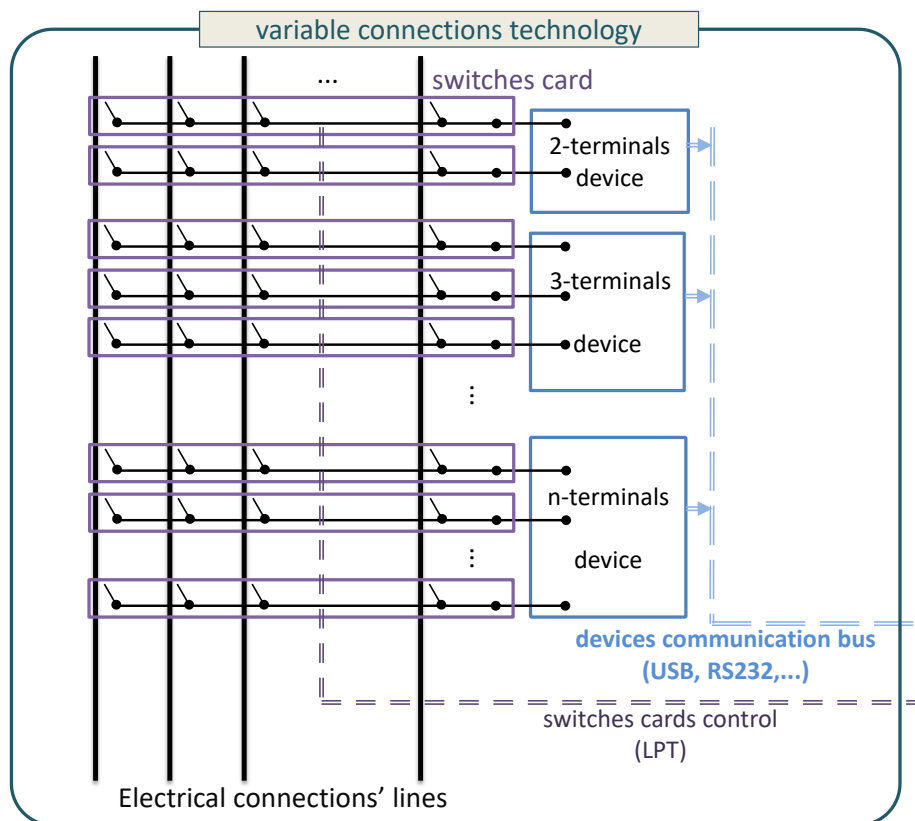

Figure 1: Variable electrical connections structure

If two or more different terminals of various device needs to be connected, the terminals will be connected on single electrical line using specific switches on each card. The terminals, which should not be connected, needs to be attached to different connection lines or should not be attached to any electrical connection line at all - depending on current connection configuration.

2.2 Existing prototype description

This technology was used at the Department of Theoretical and Industrial Electrical Engineering, at the FEI of the TUKE to build a remote measurement laboratory. The remote measurement laboratory is used as a part of industrial engineering e-learning possibility. Abbreviation VMLab is an acronym from the Slovak title "Vzdialene Meracie Laboratorium". The laboratory allows users to create basic electrical circuits and to measure its parameters in a remote way. Students can design electrical circuits themselves and measure specified parameters according to the task. Remote measurement does not make simulations; it helps to build the designed circuit and it provides real measured data. Of course, the devices have set limits like maximal current in power sources so the devices will not be damaged in case of a wrong circuit structure containing short circuit.

This existing prototype has 16 connection lines and 64 switches cards. Therefore, it can connect 32 2-terminal devices or up to 21 3-terminal devices, etc. Various terminal number devices can be used as well. The limitation is the total number of the terminals. It is possible to create up to 16 different connections between devices. This limitation is just a limitation of the prototype. It is possible to build a functional unit with different number of the connection lines or different number of the switches cards as it was mentioned above.

Real existing connection lines used in the Remote measurement laboratory are shown in the Figure 2. Electrical connection lines are connected with the switches card using a DB-37 connector which is commonly used in RS-422 communication. Remote measurement laboratory is using 16 electrical connection lines. By using the DB-37 connector each connection line could be double-pinned. It allows to increase a maximum electric current limitation. Existing connection lines can handle up to 10A.

Switches card used in Remote Measurement Laboratory system is shown in the Figure 3. On the switches card you can see two connectors: the DB-37 to reach electrical connection lines as it was written above and a DB-25 for switches card control. The DB-25 port is well known as a LPT port.

2.3 VMLab devices

Devices connected to the cards can be seen in the Figure 4, Hardware part of the VMLab. Switches cards are located on the top of the devices and the electrical elements, as can be seen in the figure. Devices and electrical elements placed on the shelves are connected to the proposed switches cards. There are several devices like digital multimeters (DMM) UT803 as voltmeters and ammeters, manageable AC power sources (AC250K1D), DC power sources (BK Precision 9122), Power Analyzer (Lutron DW-9020). All these devices are using RS232 interface. Various resistors and loads with specific impedances are used as well. List of connected devices corresponds to the main focus of the remote laboratory – basic AC and DC electrical circuit

education. It is not a restriction and can be changed for different laboratory focus with different devices.

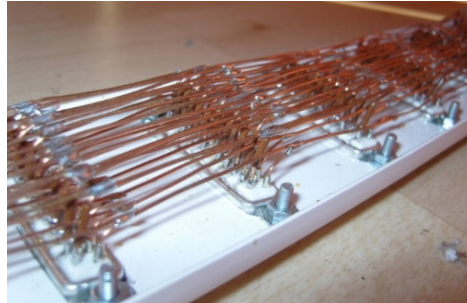

Figure 2: Created Electrical connection lines used in VMLab

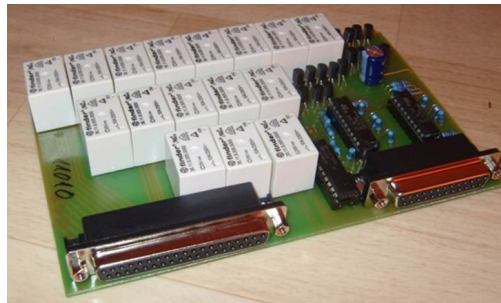

Figure 3: VMLab switching card



Figure 4: Hardware part of the VMLab

3 Original VMLab control solution

3.1 VMLab system structure

The VMLab as a system consist of three main parts as shown in the Figure 5. The main parts are VMLab client, VMLab server and VMLab hardware part. The VMLab client is used by users to design electrical circuit and control the measuring process by setting the power sources voltage level and reading measured values. The VMLab server is responsible for providing necessary data to client and control VMLab hardware part according to the client requests. The VMLab hardware part consists of special hardware (switching cards, electric lines etc.) and devices like measuring devices, power sources as well as electrical components like resistors coils, capacitors other electrical components used in the proposed electric schema.

First, the VMLab client gets a list of connected devices in the VMLab. Then the client starts to create own electrical circuits using devices specified by the VMLab server. Multiple clients at one moment can get the VMLab connected devices list and build an own electrical circuit. However, only one client at the time can proceed in measure process. Other clients have to wait while the server is occupied in the measuring process. The VMLab client during the measuring process can change the voltage value of power supplies used in the electrical circuit.

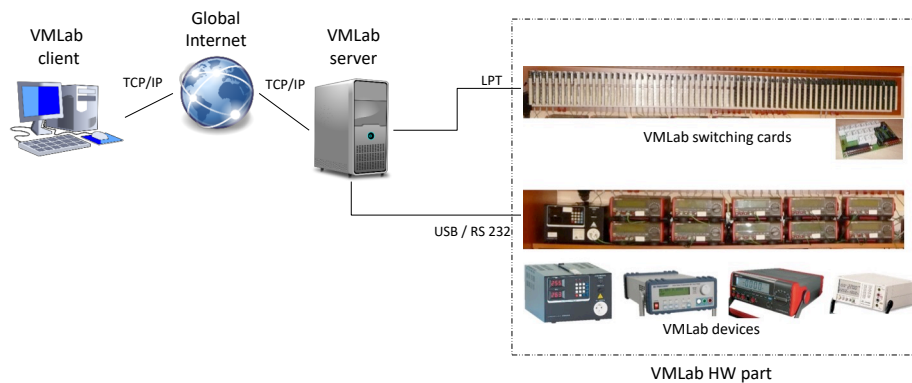

Figure 5: The original control of VMLab schematic

The client gets values of all measuring devices - voltmeter, ammeter, or power meter used in an electrical circuit. The VMLab client during the measuring process is shown in the Figure 6. The VMLab client communicates with the VMLab server directly by custom messages over TCP/IP protocol. All messages are in non-encrypted form, only authentication credentials is encrypted by MD5 algorithm.

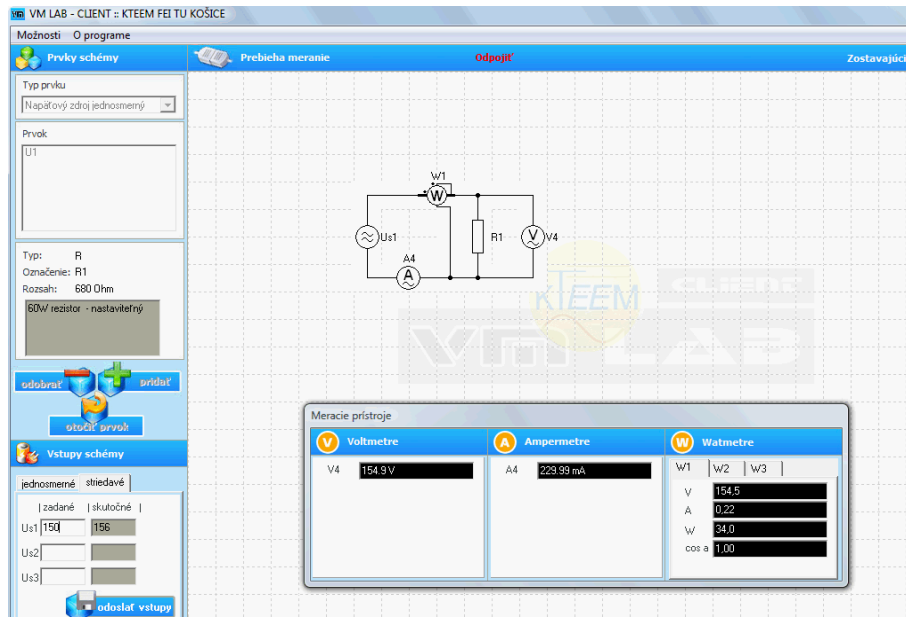

Figure 6: VMLab client screenshot

3.2 VMLab server control mechanism

The VMLab server builds custom electrical circuit designed by VMLab client. The circuit is built using switching cards and relays on the card as shown in the Figure 1. The VMLab server controls switching cards (Figure 3) by parallel digital signals using LPT port. Three values are sent over LPT: an address, an upper byte, and a lower byte. The address specifies card's relays will be changed. Next two bytes determine, which relays will be activated. Already built VMLab prototype supports up to 16 different electrical connections determined by Electrical connection lines (see the Figure 1). Lower byte affects 8 relays connected to Electrical connection lines 0..7 and upper byte affects another 8 relays connected to electrical connection lines 8..15.

All measuring devices (voltmeters, ammeters and wattmeters) and controllable power supplies used in the VMLab support the RS232 communication interface. The VMLab prototype contains over 15 digital meters and 5 power supplies. Communication with all controllable devices in the original control solution is made by a chain of USB hubs and USB/RS232 converters.

3.3 Original VMLab control system upgrade challenges

The prototype was focused to solve technical challenges related to variable electrical connections. The original VMLab control solution has several security and technical weaknesses.

First of all, the security weaknesses have to be solved. Unencrypted communication between the client and the server is high risk and not acceptable nowadays. The VMLab server is technically protected against the damage by power

source maximum set current limitation –shortcut protected etc. But the attacker could be able easily steal identity of authorized users or disrupt the measuring process. Also, MD5 algorithm could not be considered as a secure one [Gillela, 19].

Another potential security risk is in the direct accessing to the VMLab server from the global network. The direct access can expose the server into various vulnerabilities that can lead to different cyberattacks. Therefore, high demands on security and monitoring services must be considered. [Sood, 12], [Apiecionek, 15], [Shatilin, 18].

There are also technical challenges that must be solved especially two of them. The first is related to the switching card control system. In current version the LPT port is used. The LPT port was quite common port firstly intended as a simple printer interface. The LPT also presented an easy way to generate digital signal directly from PC. Therefore, it was also often used for controlling different devices like plotters, CNC machines etc. Now the LPT port belongs to the legacy ports and was replaced by the USB port. Also, in the OS Windows XP and newer, the direct access to the LPT pins are complicated. [Axelson, 02], [Semerenko, 05]. The VMLab is using 8 data signals and 3 control signals (Strobe, Linefeed, Initialize). The control signals specify, if data signals determine the address of switching card or LOW or HIGH byte of 16 bit value - which relay has to be activated.

Another technical challenge that has to be solved is that the relatively huge number of the devices communicate via the serial ports. The VMLab prototype needs to communicate with 20 devices via RS232 interface. The original control solution creates chain of the USB hubs and USB/RS232 converters. Such solution presents a cheap way of increasing the number of RS232 interfaces. On the other hand, this solution becomes unstable when multiple devices try to communicate with PC at ones. Experiences show that an actual solution become unstable when over 6 devices communicate at ones with steady data stream. This number could vary according communication baud rate and communication intensity. There exist solutions like special HW cards to extend the number of RS232 ports, but such a solution is quite expensive and reliable on a driver support from a manufacturer. Such a special hardware is often sensitive for Operation System (OS) updates or upgrades.

4 IoT VMLab implementation analysis

The maintenance, actual weaknesses described in chapter 3.3 and future expansion of the VMLab prototype requires technological upgrade of the communication system of the VMLab. The VMLab could be considered as a system of sensors (multimeters, power meters, etc.) and actuators (power sources and switching cards). Taking it to the account actual trends, IoT approach in VMLab communication system seems to be as an effective solution.

The optimal situation is, when the IoT approach is implemented into the system from the design. But there are situations, when the IoT has to be implemented into already existing systems. The effective additional implementation means that the implementation of the new or upgraded parts of the system should cause minimal changes of the rest part of the system.

4.1 RS232 to Internet

As it was mentioned in chapter 3.3, the one of the most important technical challenges is to solve a problem with multiple device communication over RS232 simultaneously. One of the solutions would be to apply the IoT for each device. There are already many solutions working as an interface between RS232 and Internet protocols [USR IOT, 20]. Such solution would not be an effective, especially when using a wireless connection. Such a number Wi-Fi clients in a small area could cause an interference problem and could have an influence on measuring circuits as an EMC problem. Therefore, more effective way would be in creating groups of devices, where each group would send data over one Wi-Fi client – IoT device. There are also the commercial solutions like [Perle, 20], but these solutions are extremely expensive – thousand euros.

Most similar interface to the RS232 is UART - Universal asynchronous receiver-transmitter. The significant difference is a voltage level of logical signals. The RS232 uses the positive and the negative voltage values from 3V up to 25V, where the most PCs swing signals from -12V to 12V and logical high (1) is represented by negative voltage [Lindblom, 10]. Such a high voltage logic level differential makes RS232 more resistant to interference. The UART is using positive voltage level only, where logic LOW (0) is represented by 0V and logic high (1) 3.3V or 5V. There are also differences in RS232 HW control signals. UART uses data pins Rx and Tx only. RS232 can optionally use additional signals like CTS (Clear to Send), RTS (Request to Send), DTR (Data Terminal Ready) etc. All microcontroller units (MCU) including IoT MCUs support UART communication. There are several ways to interconnect RS232 and UART interface. From simple logic level converters [Picsprojects, 09] to special integrated circuits (IC) where the most used is MAX232. MAX232 supports 2 signals pair converting for each direction [Instruments, 04]. First pair means to be data signals Rx and Tx. The other pair can be used for control signals like CTS and RTS. If no HW control signal needed, the second pair can be used for other data signal. This way the one MAX232 can convert simultaneously two different communication connections between the RS232 and the UART. A module with converting of four different RS232 using two MAX232 was designed and implemented. The module prototype is microcontroller independent. It can be connected to any controller suitable to handle four different UART communication. Already created 4xRS232-UART interface module is shown in Figure 7.

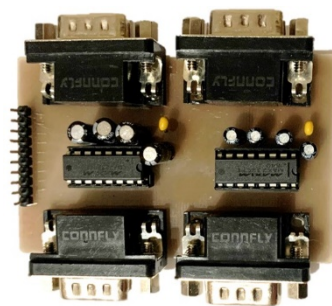

Figure 7: 4x RS232 - UART interface module

Among often used common IoT microcontroller in prototype projects is an ESP8266. The ESP8266 provides efficient power usage thanks to highly integrated SoC solution. Reliable performance for advance purposes and compact design makes the microcontroller suitable for the Internet of Things industry field. The microcontroller itself is capable to act as a server performing as a standalone application or act as a client connected to another server. Therefore, the MCU (Micro Controller Unit) ESP8266 can be used for various purposes without changing or buying expensive modules. In addition to the ESP module consist of another enhanced 32-bit processor (Tensilica's L106 Diamond) [Espressif, 18]. Default CPU clock speed is 80 MHz, but with overlocking and more power consumption the CPU clock speed can be set up to 160Mhz [AI-Thinker, 17]. The ESP8266 chips are made by various vendors like Ai-Thinker, Espressif Systems and DOIT. The differences between the vendors chips are in flash memory size, dimensions, thermal tolerance, number of pins, antenna shape and size, etc. Manufacturers proposed and created development boards which provides much easier access and usability for developers. The first development board which was using the ESP8266 chip was made in 2014. The big advantage of such a development board is in open-source platform. That brings to market various shape and sizes development boards with the ESP modules on it. Almost all of them are for programming using a USB-TTL bridge which are for many users much more convenient than an external programmer. For instance, most of them are using a CP1202 or CH340 USB-TTL converter. Another common thing that various ESP development boards have is a SIL header connection. However, the ESP chips itself are SMD only. Except of digital pins the newest development boards can handle analog signals from 0-1.0V up to 0-3.3V [NodeMCU, 15]. The ESP module and the development board NodeMCU are illustrated in the Figure 8.

The ESP8266 is also fully compatible with an MQTT standard. The MQTT (Message Queuing Telemetry Transport) is a light messaging transport protocol based on publish/subscribe messaging and works on top of the TCP/IP commonly used in machine to machine (M2M) communication. Advantages of the MQTT are describe in [Lin, 18]. The main disadvantage using the ESP8266 microcontroller as a RS232-Wi-Fi is that the ESP8266 has only one full hardware UART interface.

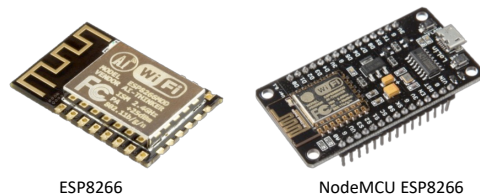

Figure 8: ESP8266 and development board NodeMCU ESP8266

There is also the second UART, but it is for sending debug data only. This technical problem can be partially solved by the UART software solution. Limitation of such solution is that even multiple software serial interfaces can be defined, only one of the software serial interfaces can read data at once [Arduino, 19]. It means The ESP8266 has to switch the devices to read from. VMLab does not require real-time measurement or control where reaction in milliseconds would be required. Any change in topology or power source output values are a matter of seconds. For steady state measurements

sequential communication with the devices like multimeters or power sources would be also sufficient. The block schema of such connection is shown in the Figure 9.

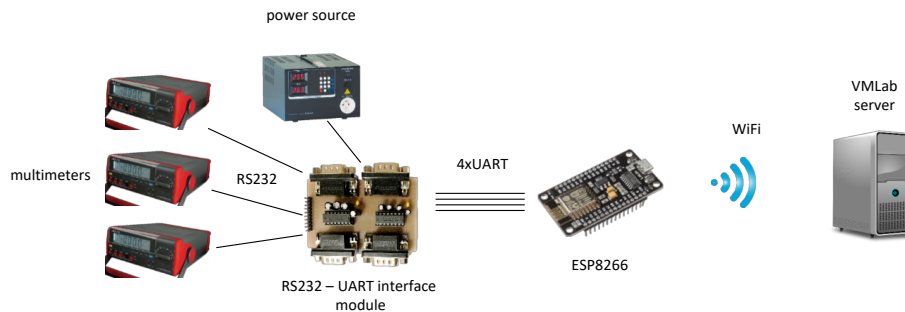

Figure 9: ESP8266 RS232 IoT solution for serial communication

In some cases, simultaneous communication with all connected devices could be required. In the measurement process by the VMLab it would be required if the measurement of transients would be applied or signal wave should be captured – oscilloscope. In such case a microcontroller with multiple hardware UART would be required. One of the solutions would be to use well known ATmega2560 supporting 4 UART interfaces and it would send the data to the ESP8266 via another interface like SPI, I2C or a SoftwareSerial. The more powerful solution would be in using microcontroller with higher number of UART interfaces and Internet connection capability. One of such a microcontroller could be STM32F746ZG. The STM32 microcontrollers are 32-bit microcontrollers with high-speed processor core type of ARM Cortex-M7 which operates at 216MHz. That could provide fast and precision operations. The microcontroller contains two memory types – SRAM (512 kB) and Flash memory (1MB). [STMicroelectronics, 20]. Microcontroller STM32F746ZG and Nucleo-144 Developing Board is shown in Figure 10.

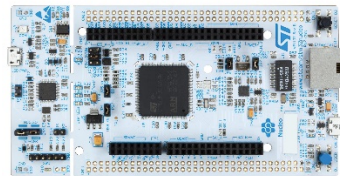

Figure 10: Microcontroller STM32F746ZG and Nucleo-144 Developing Board

The microcontroller has 4 USART (can be used as UART) and another 4 UART interfaces and 10/100 Ethernet port also. Using this ARM microcontroller with DSP instructions would be more effective, especially when real-time measurement would be required or when Wi-Fi EMC issues would be expected from the nature of the measurement. The block schema of STM32 solution is shown in Figure 11.

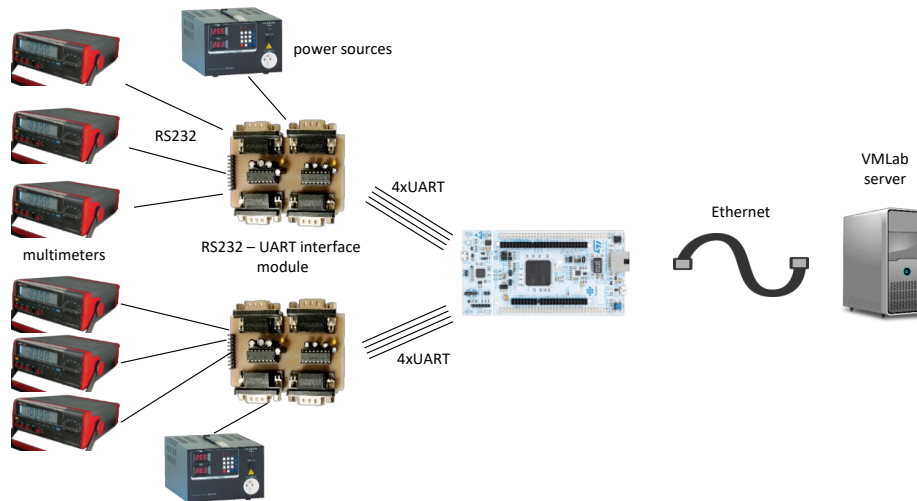

Figure 11: STM32 RS232 IoT solution

4.2 IoT alternative to LPT implementation

As it was mentioned in the chapter 3.3, another technical problem to solve is in finding alternatives for a deprecated LPT port. The LPT port is used in the VMLab to generate parallel signals controlling the VMLab switching cards (Figure 3). As it was mentioned in the chapter 3.2, the VMLab uses 11 digital signals - 8 data and 3 control pins. Additionally, another 3 signals are originally used to control the power of the whole VMLab device table. When certain time period no client is connected to the server, the VMLab device table is turned off as a “stand by” mode for energy and devices saving reasons. During the server startup, while hardware is initialized, few time digital signal value of LPT pins is changed in a short period. To avoid short time power switching of the whole VMLab table, a specific combination of 3 digital signals is used to turn on the power of the VMLab device table. The VMLab server for this function originally uses additional LPT port. That means, 14 digital signals are required to control VMLab device table including the power management.

The LPT port uses 5V signals so it can be replaced much easier with the microcontroller compared to the RS232 interface. From this point of view, any controller which can handle 14 GPIOs could replace such a function. From the datasheet [Espressif, 18], the ESP8266 has officially 16 GPIOs, but the use of multiple pins is limited and cannot be used as the regular GPIO pins [Snrpl, 20]. Alternative to ESP8266 is more powerful an ESP32 microcontroller, ESP32 showed in the Figure 12.

The ESP32 generally provides same features as the ESP8266 with dual-mode Bluetooth, data rates up to 150Mbps and antenna output power of 20 dBm in addition. The ESP32 modules are made in two versions. The one with the 160 MHz clock speed and the second with the 240 MHz clock speed. Both versions consist of dual-core or single-core CPUs where the SRAM can vary. In most cases the SRAM size is 520 kB. Another advantage of the ESP32 is in flash memory size, which is mostly 4MB, but in some versions the flash memory size can be up to 16 MB. [Espressif, 20].

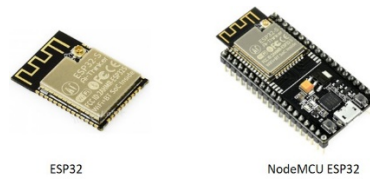

Figure 12: ESP32 and development board NodeMCU ESP32

The ESP32 has officially 38 GPIOs. It also has multiple pins use limitation [Santos, 18], but there are sufficient number of regular GPIO pins. A block scheme of the solution where the ESP32 is used is shown in the Figure 13.

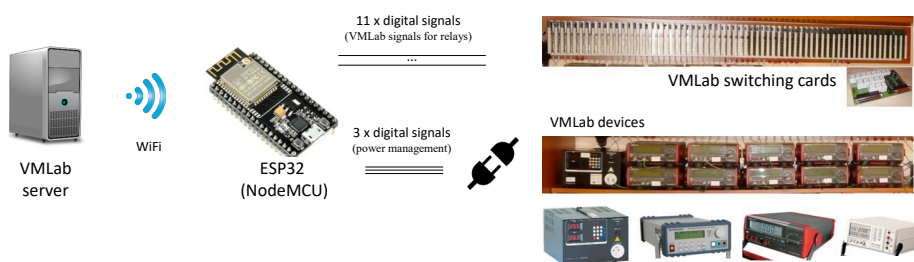

Figure 13: ESP32 parallel signals IoT solution (LPT replacement)

Another interesting alternative would be to replace the whole VMLab server with the microcomputer with dedicated number of GPIO pins. An example of such microcomputer could be a single board computer Raspberry Pi or like a Banana Pi, Orange Pi, etc. The advantage of such microcomputer is that most of them support Wi-Fi and Ethernet connections so used connection type can be changed without any problem if necessary. For instance, Raspberry Pi 4 is based on Broadcom BCM2711, Quad core Cortex-A72 (ARM v8) 64-bit SoC 1.5GHz processor, 2 – 8 GB SDRAM (depending on the model) with standard 40 pin GPIO header [Jain, 14]. VMLab server is not based on simulation calculations so it does not require high computer computing power. The core function of the VMLab server is the VMLab client authenticating service, manage IO signals to the VMLab table, the control power sources, according the client requirements and forward all measured data to the client. All these core functions could be also achieved by a single board computer. The single board computer would not just replace parallel data communication interface (LPT port), but it could replace the whole VMLab server as a computer. There are also additional functions like the VMLab management interface, logging of connected users, created schemas, power source values and statistical outputs. Also, these additional functions should be able to run on single board computer, but versions with more RAM available and higher memory card capacity would be required. The block scheme of the solution where the single computer board is used is shown in the Figure 14.

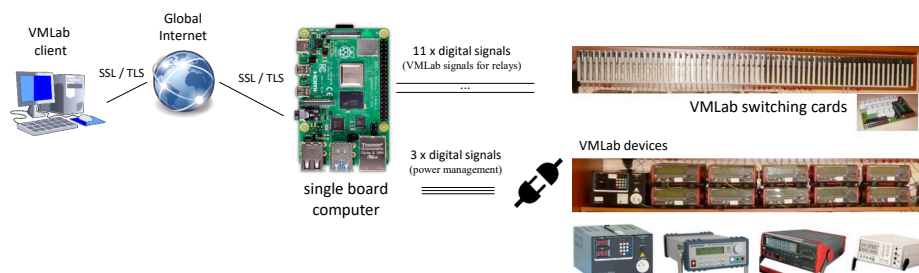

Figure 14: Single computer board parallel signals IoT solution (VMLab server replacement)

Mentioned solution alternatives do not replace the PC parallel port (LPT) generally as a system port to make run old software and hardware again. There are many projects using LPT as an IO signals communication interface or a signal generator, for instance [Szabó, 13] or [Lunca, 15]. The solutions described above could be used in these types of projects.

5 VMLab software solution

5.1 Original software solution

Typically, the client/server software application are typically used in remote laboratory systems. The server application which directly interfaces to the physical laboratory equipment is situated near laboratory system itself. It provides more than just communication between a client application and laboratory equipment. The client app installed on users' computers via Internet provides supervisory of measurement and automation process consisting of several individual tasks. The server as well as the client application can be implemented with the help of advance software tools. The advance software tools include functions that can handle communication via TCP/IP protocols to remote systems. These functions can be found in different software environments. [Bonavolontà, 19].

The original VMLab software solution Client and Server was implemented in Delphi were clients and server communicated directly by TCP messages. Communication procedure was already briefly described in the chapter 3.1. The server uses two different ports.

First port allows multiple clients and serve to send a list of all available devices or server status on request. The server can respond with two different stages status: Free and Busy. The Free means the server is prepared to accept client for measuring process. The Busy stage means that the server is already in measuring process with another client. From the client side there is also the 3rd server stage: The offline when the server does not respond on client connection request. The communication on the first port does not require authentication.

The second port is used for measuring process. It allows only one connection at the time. After approving correct credentials, the client sends the server first the circuit scheme to build. Then the client sends the value of power sources used in the scheme.

The server sends back to the client all measured value in the circuit on a regular basis, approximately every five seconds. The client sends new values of the power sources every time when the user updates the values. During the measuring process the circuits remain unchanged. After the measuring process is finished, the user can change the circuit topology and connect to the server again.

5.2 Updated VMLab software solution

The original architecture of the VMLab is shown in the Figure 5. A significant change from the original solution was made in 2016 where another part – remote database in WEB/DB server was implemented and VMLab became a distributed system. All data provided and required by server were moved to the MySQL database and PHP scripts providing access to the data were created. The updated VMLab scheme is shown in the Figure 15. The client and the server communicate directly only with the Web server and read and update data in the database via posting data to the called PHP scripts using the HTTP protocol. The client authentication process is now made by the WEB server. The WEB server is also responsible to ensure that only one client at the time can proceed measuring process by creating unique “measurement token”. All configuration settings – list of connected devices, mapping the device terminals with switching card (see the chapter 2.1), list of users’ credentials are now stored in the remote database. All these data are load by the VMLab server on startup. The VMLab server handles measuring process only now.

VMLab server load the current circuits’ scheme from the database and according to the configuration settings (mapped device terminals and switching card) sends instruction to the specific switching cards, set the value of the power sources from the DB updated by the client, read measuring devices and update measured values to the DB. Measured values are read by the client calling PHP script on a regular basis. Only the client with a valid measurement token can send circuit scheme, set wish value of power sources and read measured data.

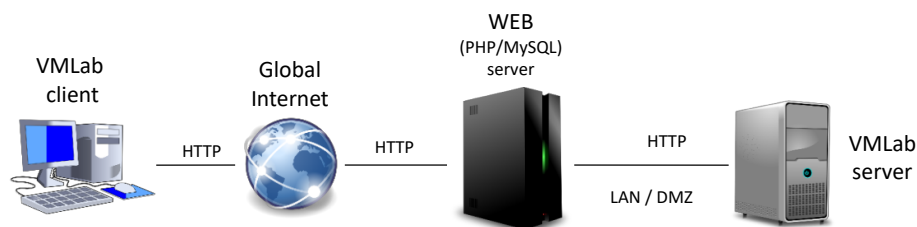

Figure 15: Updated VMLab architecture

Creating additional part of the VMLab system by using the web server had brought several benefits. The first, moving all data to remote databases, new possibilities for remote managing the server was created with the possibility for user-friendly by simple web portal (PHP) instead of editing configuration files in the text editors as was done in the original solution. The second, the VMLab server has been relieved of multiple tasks, resulting in lower server hardware requirements. The VMLab server as a computer can be easily replaced by a single board computer or even a microcontroller

(see chapter 4.2). The third, but one of the most important new possibilities is much easier replacing VMLab client application by the web application running on the web server. The users would use only web browser on their computer instead of downloading and installing the application (windows supported only).

5.3 VMLab software IoT implementation design

The chapter 4 presented various possibilities for implementing the IoT microcontrollers, where the ESP, the Nucleo (STM) microcontrollers and the single board computer were taken into the account and several scenarios were presented.

The VMLab could be considered as a system of sensors and actuators. It does not require real-time reaction like various industrial processes. In this case there are various existing system optimized for smart homes, like systems based on the MQTT. The MQTT allows faster, secure and authenticated communication and it is much energy efficient compared to the HTTPS [Stephen, 12]. So, one of the possible solutions could be implementing the MQTT system. On the other hand, the MQTT is system of publishers and subscriber where the VMLab is not fully publish/subscribe system. Implementing of the MQTT would cause adding additional software part – the MQTT broker and fully rebuilds the whole communication system from the base. All VMLab components are powered up from the power line and the response time does not require real-time reaction so the least complicated solution seems to be using standard HTTPS protocols.

From the scenarios described in the chapter 4.1, the scenario with the ESP8266 (Figure 9) should be sufficient. It is more modular and partially tested solution. There could be also combined solution with the STM32F746ZG if necessary, where the STM microcontroller would handle UART communication with the devices and ESP8266 could be used as a communication interface with the server if real-time measuring data stream would be required in the future.

For LPT port replacement described in the chapter 4.2, as a more robust solution seems to be the alternative based on the single board computer (Figure 14). The main advantage against the ESP32 solution is not only that it can implement the WEB server part, but there could also be easily implemented various management and diagnostic tools. For the security reason [Sood, 12], it is more reliable to keep the VMLab hardware hidden from the WAN, so the clients would use official web server and would not connect directly the VMLab single board computer. Data transfer between the VMLab server (single board computer) and the WEB/DB server would be based data exchange based on the HTTPS.

From the above text, resulting design of the VMLab IoT implementing design in shown in Figure 16.

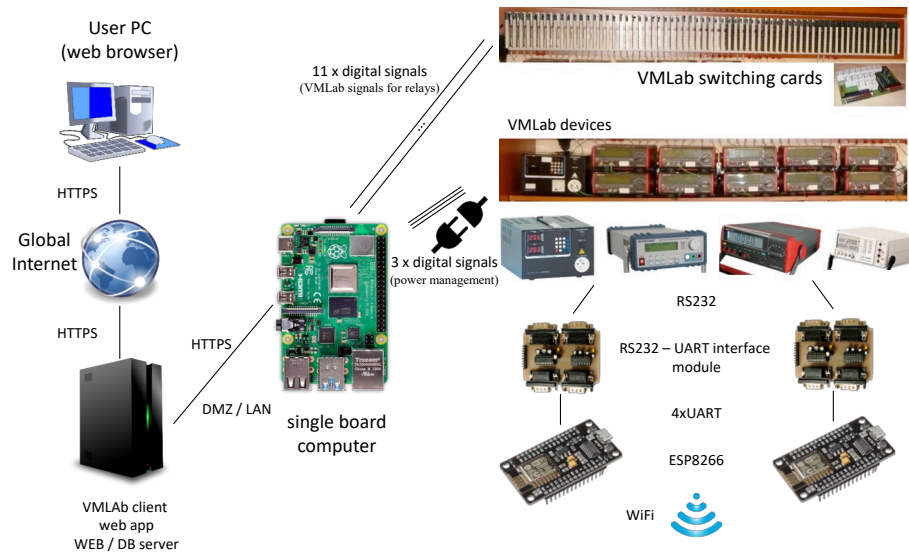

Figure 16: Final architecture design

6 Conclusions

The IoT has become the one of the platform for the smart homes, smart cities, but also form of intelligent services such as the Industry 4.0. There are many special valuable technological projects were designed using deprecated technology in these days. Deprecated technology limits future extensions and reduces compatibility with new technologies. One of such a project is unique patented remote measuring laboratory VMLab at the Technical University of Košice. In this paper was described the current technological solution of the VMLab and the problems and weaknesses of the prototype were identified. Then the analyses of the possible solution have been performed and described. From the analyses, the final design of a new architecture based on the IoT components has been made. Even the analyses were performed on the VMLab technology, the scenarios described in the paper can be valuable information for similar projects based on deprecated interfaces like the RS232 or the LPT.

Implementation of the new architecture will allow to expand the VMLab technology to a new level and easily integrate it into more complex systems compatible with smart home, smart city or systems used in the Industrial 4.0.

7 Future Work

The future work is defined by The VMLab new architecture design implementation described in the paper. Some of the proposed solutions were successfully tested in the smaller projects, especially the issue of communication between devices equipped with the RS232 interface like multimeters and different IoT microcontrollers. As a most

complicated part of the new architecture seems to build the whole new VMLab client as a web application.

After implementing a designed architecture, new features have to be implemented like to observe measured signals with the oscilloscope, transient action by changing the topology during the measuring process. There should be also implemented the VMLab condition monitoring processes like an environment monitoring in case of the overheating malfunction device, develop and implement methods of the self-diagnostic.

References

- [AI-Thinker, 17] AI-Thinker, "ESP-01/07/12 Series Modules User's Manual", user manual v1.1, 2017, online:
http://wiki.ai-thinker.com/_media/esp8266/esp8266_series_modules_user_manual_v1.1.pdf
- [Apiecionek, 15] Apiecionek, L., Czerniak, J. M., Dobrosielski, W. T.: "Quality of services method as a DDoS protection tool." *Intelligent Systems' 2014*. Springer, Cham, 2015. 225-234.
- [Apiecionek, 19] Apiecionek, L., Großmann, M., & Krieger, U. R. (2019). Harmonizing IoT-Architectures with Advanced Security Features-A Survey and Case Study. *J. UCS*, 25(6), 571-590.
- [Arduino, 19] Arduino. (2019). SoftwareSerial library. available online: <http://arduino.cc/en/Reference/SoftwareSerial>.(Dec, 2019).
- [Axelson, 02] Axelson, J.: *Parallel Port Complete: Programming, Interfacing & Using the PC'S Parallel Printer Port*. Lakeview Research. (2002), ISBN 9780965081962
- [Bhatt, 12] Bhatt, D. V., Du Toit, D., Hancke, G. P.: Design of a controller for a universal input/output port. In *2012 IEEE International Instrumentation and Measurement Technology Conference Proceedings* (pp. 647-652). (2012, May). IEEE.
- [Bonavolontà, 19] Bonavolontà, F., D'Arco, M., Liccardo, A., & Tamburis, O. (2019). Remote laboratory design and implementation as a measurement and automation experiential learning opportunity. *IEEE Instrumentation & Measurement Magazine*, 22(6), 62-67.
- [Espressif, 18] Espressif Systems, "ESP8266EX Datasheet", technical documentation v6.0, 2018 online:
https://www.espressif.com/sites/default/files/documentation/0a-esp8266ex_datasheet_en.pdf
- [Espressif, 18] Espressif Systems (2018), "ESP8266EX Datasheet", technical documentation v6.0, 2018 online:
https://www.espressif.com/sites/default/files/documentation/0a-esp8266ex_datasheet_en.pdf
- [Espressif, 20] Espressif Systems, ESP32 Module, available online:
<https://www.espressif.com/en/products/modules/esp32> (April, 2020)
- [Gillela, 19] Gillela, M., Prenosil, V., & Ginja, V. R.: Parallelization of brute-force attack on MD5 hash algorithm on FPGA. In *2019 32nd International Conference on VLSI Design and 2019 18th International Conference on Embedded Systems (VLSID)* (pp. 88-93). (2019, January), IEEE.
- [Instruments, 04] Instruments, Texas. "Data sheet max232." Online Document 15 (2004).
- [Jacko, 19] Jacko, P., & Kravets, O. (2019, September). Spectral Analysis by STM32 Microcontroller of the Mixed Signal. In *2019 IEEE International Conference on Modern Electrical and Energy Systems (MEES)* (pp. 342-345). IEEE.

- [Jacko, 18] P. Jacko, D. Kováč: The DMA controller description and configuration of the STM32 microcontrollers, In. JIEE - Journal of Industrial Electrical Engineering, Vol: 2, Issue 1.
- [Jain, 14] Jain, S., Vaibhav, A., & Goyal, L. (2014, February). Raspberry Pi based interactive home automation system through E-mail. In 2014 International Conference on Reliability Optimization and Information Technology (ICROIT) (pp. 277-280). IEEE.
- [Jardim-Goncalves, 19] Jardim-Goncalves, R. (2019). Guest editorial: Instrumentation and measurement in the Internet-of-Things. IEEE Instrumentation & Measurement Magazine, 22(6), 3-3.
- [Kováč, 09] Kováč, D., Vince, T., Kováčová, I., Molnar, J. "Zapojenie na automatizované a variabilné zapájanie elektrických prvkov a zariadení do elektrických obvodov", SK Patent SK288241B6, issued February 2, 2009.
- [Kováč, 16] Kováč, D., Kováčová, I., Vince, T., Molnar, J., Perduľák, J., Bereš, M., & Dziak, J. (2016). An automated measuring laboratory (VMLab) in education. The International journal of engineering education, 32(5), 2250-2259.
- [Lin, 18] Lin, C. Y., Liao, K. H., & Chang, C. H. (2018). An Experimental System for MQTT/CoAP-based IoT Applications in IPv6 over Bluetooth Low Energy. J. UCS, 24(9), 1170-1191.
- [Lindblom, 10] Lindblom, J. (2010). RS-232 vs. TTL Serial Communication. available online: <https://www.sparkfun.com/tutorials/215> (November, 2010)
- [Lunca, 15] Lunca, E., Ursache, S., & Vasniuc, A. (2015, May). Temperature monitoring system based on multiple TMP75 digital sensors and the PC's parallel port. In 2015 9th International Symposium on Advanced Topics in Electrical Engineering (ATEE) (pp. 15-18). IEEE.
- [Pavlík, 19] Pavlík, M. (2019). Compare of shielding effectiveness for building materials. Przegląd Elektrotechniczny, 95(5), 137-140. ISSN 0033-2097
- [Medved', 18] Medved', D., Pavlík, M., & Zbojovský, J. (2018, November). Computer modeling of electromagnetic field around the 22 kV high voltage overhead lines. In 2018 International IEEE Conference and Workshop in Óbuda on Electrical and Power Engineering (CANDO-EPE) (pp. 000289-000294). IEEE.
- [NodeMCU, 15] NodeMCU," NODE MCU DEVKIT V1.0", schematic v1.0, 2015, online: https://www.electrodragon.com/w/images/3/3b/NODEMCU_DEVKIT_V1.0.PDF
- [Perle, 20] Perle (2020). Serial to WiFi Device Servers available online: <https://www.perle.com/lp/serial-to-wifi.shtml> (May, 2020)
- [Picprojects, 09] Picprojects: "Simple RS232 to logic level converter", 2009, available online: <http://picprojects.org.uk/projects/simpleSIO/ssio.htm>
- [Santos, 18] Santos, S. (2018), ESP32 Pinout Reference: Which GPIO pins should you use? available online: <https://randomnerdtutorials.com/esp32-pinout-reference-gpios/> (October, 2018)
- [Semerenko, 05] Semerenko, Y. A.: Interfacing the instrumental GPIB with a personal computer through the LPT port. Instruments and Experimental Techniques, 48(5), (2005), 608-610.
- [Shatilin, 18] Shatilin, I.: The dangers of public IPs, 2018, <https://www.kaspersky.com/blog/public-ip-dangers/24745/>
- [Snrpl, 20] Snrpl (2020), ESP8266 ESP-201 module - freeing up GPIO9 and GPIO10, available online: <http://smarpl.com/content/esp8266-esp-201-module-freeing-gpio9-and-gpio10> (April, 2020)

[Sood, 12] Sood, A. K., Enbody, R. J.: Targeted cyberattacks: a superset of advanced persistent threats." *IEEE security & privacy* 11.1 (2012): 54-61.

[Stephen, 12] Stephen N. (2012), Power Profiling: HTTPS Long Polling vs. MQTT with SSL, on Android, available online: <https://stephendnicholas.com/posts/power-profiling-mqtt-vs-https>

[STMicroelectronics, 20] STMicroelectronics (2020). STM32F746ZG – STMicroelectronics. available online: <https://www.st.com/en/microcontrollers-microprocessors/stm32f746zg.html> (May, 2020)

[Szabó, 13] Szabó, R., & Gontean, A. (2013, October). Programmable interface for a signal generator and logic analyzer system. In 2013 IEEE 19th International Symposium for Design and Technology in Electronic Packaging (SIITME) (pp. 231-235). IEEE.

[Theera-Umpon, 18] Theera-Umpon, N., Han, K. H., Bae, W. S., Lee, S., & Van Huy Pham. (2018). Verifying Secure Authentication Protocol for Communication between IoT-based Medical Devices. *J. UCS*, 24(9), 1258-1270.

[USR IOT, 20] USR IOT (2020). USR-WIFI232-602-V2, RS232 WiFi Converter available online: <https://www.usriot.com/products/rs232-wifi-converter.html> (May, 2020)

[Vince, 11] Vince, T., & Molnar, J. (2011, January). Remote measurements of variable topology system. In *Annals of DAAAM for 2011 & Proceedings of the 22nd International DAAAM Symposium on " Intelligent Manufacturing & Automation: Power of Knowledge and Creativity* (pp. 1179-1180).

[Zagirnyak, 14] Zagirnyak, M., Mamchur, D., & Kalinov, A. (2014, March). Induction motor diagnostic system based on spectra analysis of current and instantaneous power signals. In *IEEE SOUTHEASTCON 2014* (pp. 1-7). IEEE.