



## TOTAL PROTECTION IN GRAPHS

**Abel Cabrera Martínez**

**ADVERTIMENT.** L'accés als continguts d'aquesta tesi doctoral i la seva utilització ha de respectar els drets de la persona autora. Pot ser utilitzada per a consulta o estudi personal, així com en activitats o materials d'investigació i docència en els termes establerts a l'art. 32 del Text Refós de la Llei de Propietat Intel·lectual (RDL 1/1996). Per altres utilitzacions es requereix l'autorització prèvia i expressa de la persona autora. En qualsevol cas, en la utilització dels seus continguts caldrà indicar de forma clara el nom i cognoms de la persona autora i el títol de la tesi doctoral. No s'autoritza la seva reproducció o altres formes d'explotació efectuades amb finalitats de lucre ni la seva comunicació pública des d'un lloc aliè al servei TDX. Tampoc s'autoritza la presentació del seu contingut en una finestra o marc aliè a TDX (framing). Aquesta reserva de drets afecta tant als continguts de la tesi com als seus resums i índexs.

**ADVERTENCIA.** El acceso a los contenidos de esta tesis doctoral y su utilización debe respetar los derechos de la persona autora. Puede ser utilizada para consulta o estudio personal, así como en actividades o materiales de investigación y docencia en los términos establecidos en el art. 32 del Texto Refundido de la Ley de Propiedad Intelectual (RDL 1/1996). Para otros usos se requiere la autorización previa y expresa de la persona autora. En cualquier caso, en la utilización de sus contenidos se deberá indicar de forma clara el nombre y apellidos de la persona autora y el título de la tesis doctoral. No se autoriza su reproducción u otras formas de explotación efectuadas con fines lucrativos ni su comunicación pública desde un sitio ajeno al servicio TDR. Tampoco se autoriza la presentación de su contenido en una ventana o marco ajeno a TDR (framing). Esta reserva de derechos afecta tanto al contenido de la tesis como a sus resúmenes e índices.

**WARNING.** Access to the contents of this doctoral thesis and its use must respect the rights of the author. It can be used for reference or private study, as well as research and learning activities or materials in the terms established by the 32nd article of the Spanish Consolidated Copyright Act (RDL 1/1996). Express and previous authorization of the author is required for any other uses. In any case, when using its content, full name of the author and title of the thesis must be clearly indicated. Reproduction or other forms of for profit use or public communication from outside TDX service is not allowed. Presentation of its content in a window or frame external to TDX (framing) is not authorized either. These rights affect both the content of the thesis and its abstracts and indexes.



UNIVERSITAT  
ROVIRA i VIRGILI

## **Total protection in graphs**

---

ABEL CABRERA MARTINEZ

DOCTORAL THESIS

2021







Abel Cabrera Martínez

TOTAL PROTECTION IN GRAPHS

DOCTORAL THESIS

Supervised by Dr. Juan Alberto Rodríguez Velázquez and  
Dr. Rafael Orlando Ramírez Inostroza  
Departament d'Enginyeria Informàtica i Matemàtiques



UNIVERSITAT  
ROVIRA i VIRGILI

Tarragona  
2021





WE STATE that the present study, entitled “Total protection in graphs”, presented by Abel Cabrera Martínez for the award of the degree of Doctor, has been carried out under our supervision at the “Departament d’Enginyeria Informàtica i Matemàtiques” of this university, and that it fulfils all the requirements to be eligible for the International Doctorate Award.

Tarragona, May, 2021

Doctoral Thesis Supervisors:

Dr. Juan A. Rodríguez Velázquez

Dr. Rafael O. Ramírez Inostroza





## Agradecimientos

Ante todo, agradezco a mis Directores de Tesis. Gracias de corazón por compartir conmigo sus experiencias en la investigación y sus conocimientos matemáticos. Gracias por apoyarme siempre de manera incondicional tanto a nivel profesional como personal. **You are the best!!!**

Agradezco a Ismael. Infinitamente agradecido por confiar en mí. Sin su apoyo y ayuda no hubiera sido posible llegar al final del inicio. Gracias “Isma”. **You are the best too!!!**

Agradezco a Alberto y Cristina. A Alberto, por compartir conmigo su sabiduría y por los fantásticos “maratones” interminables, principalmente durante el confinamiento; y a Cristina, por su amabilidad y paciencia para con nosotros.

Agradezco al “Departament d’Enginyeria Informàtica i Matemàtiques” de la “Universitat Rovira i Virgili” por concederme la beca para realizar mis estudios doctorales.

Agradezco a la “Universitat Rovira i Virgili” y al Banco Santander por concederme la beca para realizar la estancia en Acapulco, México.

Agradezco a Alejandro, Frank, Montejano y Suitberto por sus colaboraciones en algunos trabajos.

Agradezco a mi familia cubana, española y mexicana. A todos, gracias por siempre apoyarme.

Y muy muy muy en especial, agradezco a mis princesas Sophy y Gaby; y a mi esposa y reina Karem Yali. *El sugbrafo inducido por nosotros es isomorfo a  $K_4$* . Hijas, a ustedes va dedicada esta Tesis. Amor, gracias por estar siempre a mi lado, por aguantar mis maratones y madrugadas de trabajo; gracias por ser mi musa. Mi reina, a tí también dedico esta Tesis.



## Abstracts

Suppose that one or more entities are stationed at some of the vertices of a simple graph and that an entity at a vertex can deal with a problem at any vertex in its closed neighbourhood. In general, an entity could consist of a robot, an observer, a legion, a guard, and so on. Informally, we say that a graph is protected under a given placement of entities if there exists at least one entity available to handle a problem at any vertex. Various strategies (or rules for entities placements) have been considered, under each of which the graph is deemed protected. These strategies for the protection of graphs are framed within the theory of domination in graphs, or in the theory of secure domination in graphs.

In this thesis, we introduce the study of (secure)  $w$ -domination in graphs, which is a unified approach to the idea of protection of graphs, that encompasses known variants of (secure) domination in graphs and introduces new ones. The thesis is structured as a compendium of ten papers which have been published in JCR-indexed journals. The first one is devoted to the study of  $w$ -domination, the fifth one is devoted to the study of secure  $w$ -domination, while the other papers are devoted to particular cases of total protection strategies. As we can expect, the minimum number of entities required for protection under each strategy is of interest. In general, we obtain closed formulas or tight bounds on the studied parameters.



# Contents

<b>Introduction</b>	<b>1</b>
<b>1 From Italian domination in lexicographic product graphs to <math>w</math>-domination in graphs</b>	<b>6</b>
<b>2 Total domination in rooted product graphs</b>	<b>31</b>
<b>3 Total Roman <math>\{2\}</math>-domination in graphs</b>	<b>43</b>
<b>4 Double domination in lexicographic product graphs</b>	<b>67</b>
<b>5 Secure <math>w</math>-domination in graphs</b>	<b>85</b>
<b>6 Total weak Roman domination in graphs</b>	<b>97</b>
<b>7 On the secure total domination number of graphs</b>	<b>118</b>
<b>8 Secure total domination in rooted product graphs</b>	<b>131</b>
<b>9 Total protection of lexicographic product graphs</b>	<b>146</b>
<b>10 From (secure) <math>w</math>-domination in graphs to protection of lexicographic product graphs</b>	<b>165</b>
<b>Conclusions</b>	<b>185</b>
<b>References</b>	<b>194</b>



# Introduction

Domination theory is a well-established topic in graph theory, as well as one of the most active research areas. Domination was first defined as a graph-theoretical concept in 1958. This area experienced rapid growth resulting in over 1200 papers published by the late 1990s. The explosive growth has continued and today more than 4500 papers have been published on domination in graphs. The increasing interest in this area is partly explained by the diversity of applications to real-world problems, such as facility location problems, computer and social networks, monitoring communication, coding theory, algorithm design, among others. We refer to [24, 25, 26] for theoretical results and practical applications.

In a graph, a vertex dominates itself and its neighbours. A set of vertices of a graph is said to be a *dominating set* if it dominates every vertex of the graph. The solution of different real-world problems using dominating sets has allowed new and interesting domination models to be defined. The notion of protection of graphs is closely related to the idea of domination. Recently, many authors have considered the following approach to the problem of protecting a graph [2, 11, 12, 16, 18, 28, 38]: suppose that one or more “entities” are stationed at some of the vertices of a (simple) graph and that an entity at a vertex can deal with a problem at any vertex in its closed neighbourhood. In general, an entity could consist of a robot, an observer, a legion, a guard, and so on. Informally, we say that a graph  $G$  is protected under a given placement of entities if there exists at least one entity available to handle a problem at any vertex of  $G$ . Various strategies (or rules for entities placements) have been considered, under each of which the graph is deemed protected. As we can expect, the minimum number of entities required for protection under each strategy is of interest.

The simplest strategies of graph protection are the strategy of domination and the strategy of total domination. In such cases, the sets of vertices containing the entities are dominating sets and total dominating sets, respectively. Among other studied strategies, we can cite, for instance, multiple (total) domination, (total)



Italian domination, secure (total) domination, (total) weak Roman domination. In this thesis we propose to unify these strategies under the following approach.

Let  $\mathbb{Z}^+ = \{1, 2, 3, \dots\}$  and  $\mathbb{N} = \mathbb{Z}^+ \cup \{0\}$  be the sets of positive and nonnegative integers, respectively. Let  $G$  be a graph,  $l \in \mathbb{Z}^+$  and  $f : V(G) \rightarrow \{0, \dots, l\}$  a function, where  $f(v)$  is the number of entities stationed at vertex  $v$ . Let  $V_i = \{v \in V(G) : f(v) = i\}$  for every  $i \in \{0, \dots, l\}$ . We identify  $f$  with the subsets  $V_0, \dots, V_l$  associated with it, and thus we use the unified notation  $f(V_0, \dots, V_l)$  for the function and these associated subsets. The weight of  $f$  is defined to be

$$\omega(f) = f(V(G)) = \sum_{i=1}^l i|V_i|.$$

Let  $w = (w_0, \dots, w_l) \in \mathbb{Z}^+ \times \mathbb{N}^l$ . A function  $f(V_0, \dots, V_l)$  is a  $w$ -dominating function on a graph  $G$  if  $f(N(v)) \geq w_i$  for every vertex  $v \in V_i$  and  $i \in \{0, \dots, l\}$ . The  $w$ -domination number of  $G$ , denoted by  $\gamma_w(G)$ , is the minimum weight among all  $w$ -dominating functions. For simplicity, a  $w$ -dominating function  $f$  of weight  $\omega(f) = \gamma_w(G)$  is called a  $\gamma_w(G)$ -function. A similar agreement will be assumed when referring to optimal sets associated to other parameters used in the thesis.

As mentioned above, this unified approach allows us to encompass the definition of several well-known domination parameters, and also introduce new ones. For instance, we highlight the following particular cases of known domination parameters, which we define here in terms of  $w$ -domination.

- The *domination number* of  $G$  is defined to be  $\gamma(G) = \gamma_{(1,0)}(G) = \gamma_{(1,0,0)}(G)$ . Obviously, every  $\gamma_{(1,0,0)}(G)$ -function  $f(V_0, V_1, V_2)$  satisfies that  $V_2 = \emptyset$  and  $V_1$  is a dominating set of cardinality  $|V_1| = \gamma(G)$ . For more information on domination in graphs we suggest the books [24, 26].
- The *total domination number* of a graph  $G$  with no isolated vertex is defined to be  $\gamma_t(G) = \gamma_{(1,1)}(G) = \gamma_{(1,1,w_2,\dots,w_l)}(G)$ , for every  $w_2, \dots, w_l \in \{0, 1\}$ . Notice that every  $\gamma_{(1,1,w_2,\dots,w_l)}(G)$ -function  $f(V_0, \dots, V_l)$  satisfies that  $V_i = \emptyset$  for every  $i \in \{2, \dots, l\}$  and  $V_1$  is a total dominating set of cardinality  $|V_1| = \gamma_t(G)$ . For more information on total domination we suggest the book [31] or the survey [27].
- Given a positive integer  $k$ , the  *$k$ -domination number* of a graph  $G$  is defined to be  $\gamma_k(G) = \gamma_{(k,0)}(G)$ . In this case,  $V_1$  is a  $k$ -dominating set of cardinality  $|V_1| = \gamma_k(G)$ . The study of  $k$ -domination in graphs was introduced in [22].

- Given a positive integer  $k$ , the  $k$ -tuple domination number of a graph  $G$  of minimum degree  $\delta(G) \geq k - 1$  is defined to be  $\gamma_{\times k}(G) = \gamma_{(k,k-1)}(G)$ . In this case,  $V_1$  is a  $k$ -tuple dominating set of cardinality  $|V_1| = \gamma_{\times k}(G)$ . In particular,  $\gamma_{\times 1}(G) = \gamma(G)$  and  $\gamma_{\times 2}(G)$  is known as the *double domination number* of  $G$ . This parameter was introduced in [23].
- Given a positive integer  $k$ , the  $k$ -tuple total domination number of a graph  $G$  of minimum degree  $\delta(G) \geq k$  is defined to be  $\gamma_{\times k,t}(G) = \gamma_{(k,k)}(G)$ . In particular,  $\gamma_{\times 1,t}(G) = \gamma_t(G)$  and  $\gamma_{\times 2,t}(G)$  is known as the *double total domination number*, and  $V_1$  is a double total dominating set of cardinality  $|V_1| = \gamma_{\times 2,t}(G)$ . The  $k$ -tuple total domination number was introduced in [29].
- The *Italian domination number* of  $G$  is defined to be  $\gamma_t(G) = \gamma_{(2,0,0)}(G)$ . This parameter was introduced by Chellali et al. in [15] under the name of Roman  $\{2\}$ -domination number. The concept was studied further in [30, 34].
- The *total Italian domination number* of a graph  $G$  with no isolated vertex is defined to be  $\gamma_{tI}(G) = \gamma_{(2,1,1)}(G)$ . This parameter was introduced in this thesis, and independently by Abdollahzadeh Ahangar et al. in [1], under the name of total Roman  $\{2\}$ -domination number. The total Italian domination number of lexicographic product graphs was studied in [7].
- The  $\{k\}$ -domination number of  $G$  is defined as  $\gamma_{\{k\}}(G) = \gamma_{(k,k-1,\dots,0)}(G)$ . This parameter was introduced by Domke et al. in [20] and studied further in [4, 32, 37].

Observe that the concept of  $w$ -domination does not include the cases in which the graph is deemed protected under a placement of entities, and also protected under the new placement of entities obtained from the previous one, when an entity moves to a neighbour vertex to deal with a problem. For instance, this is the case of secure (total) domination and (total) weak Roman domination. The general approach for these cases will be called secure  $w$ -domination.

For any function  $f(V_0, \dots, V_l)$  and any pair of adjacent vertices  $v \in V_0$  and  $u \in V(G) \setminus V_0$ , the function  $f_{u \rightarrow v}$  is defined by  $f_{u \rightarrow v}(v) = 1$ ,  $f_{u \rightarrow v}(u) = f(u) - 1$  and  $f_{u \rightarrow v}(x) = f(x)$  whenever  $x \in V(G) \setminus \{u, v\}$ . We say that a  $w$ -dominating function  $f(V_0, \dots, V_l)$  is a *secure  $w$ -dominating function* if for every  $v \in V_0$  there exists  $u \in N(v) \setminus V_0$  such that  $f_{u \rightarrow v}$  is a  $w$ -dominating function as well. The *secure  $w$ -domination number* of  $G$ , denoted by  $\gamma_w^s(G)$ , is the minimum weight among all

secure  $w$ -dominating functions. For simplicity, a secure  $w$ -dominating function  $f$  of weight  $\omega(f) = \gamma_w^s(G)$  is called a  $\gamma_w^s(G)$ -function.

This approach to the theory of secure domination covers the different versions of secure domination known so far. For instance, we emphasize the following cases of known parameters that we define here in terms of secure  $w$ -domination.

- The *secure domination number* of  $G$  is defined to be  $\gamma_s(G) = \gamma_{(1,0)}^s(G)$ . In this case, for any secure  $(1,0)$ -dominating function  $f(V_0, V_1)$ , the set  $V_1$  is known as a *secure dominating set*. This concept was introduced by Cockayne et al. [18] and studied further in several papers (e.g., [3, 5, 14, 17, 33, 35, 40]).
- The *secure total domination number* of a graph  $G$  of minimum degree at least one is defined to be  $\gamma_{st}(G) = \gamma_{(1,1)}^s(G)$ . In this case, for any secure  $(1,1)$ -dominating function  $f(V_0, V_1)$ , the set  $V_1$  is known as a *secure total dominating set* of  $G$ . This concept was introduced by Benecke et al. [2] and studied further in several papers (e.g., [11, 12, 21, 35, 36]).
- The *weak Roman domination number* of a graph  $G$  is defined to be  $\gamma_r(G) = \gamma_{(1,0,0)}^s(G)$ . This concept was introduced by Henning and Hedetniemi [28] and studied further in several papers (e.g., [10, 14, 17, 39]).
- The *total weak Roman domination number* of a graph  $G$  of minimum degree at least one is defined to be  $\gamma_{tr}(G) = \gamma_{(1,1,1)}^s(G)$ . This concept was introduced in this thesis.
- The *secure Italian domination number* of a graph  $G$  is defined to be  $\gamma_i^s(G) = \gamma_{(2,0,0)}^s(G)$ . This parameter was introduced by Dettlaff et al. [19].

Observe that the word “total” is used whenever a  $w$ -dominating function  $f$  satisfies the restriction  $f(N(v)) \geq 1$  for every vertex  $v \in V(G)$ . Most of the results of this thesis are focused on these strategies of protection of graphs, which will be called *total protection strategies*.

This thesis is structured as a compendium of ten papers which have been published in JCR-indexed journals. These papers are presented in separated chapters.

In Chapter 1 we introduce the study of  $w$ -domination in graphs, and provide general results on the  $w$ -domination number.

## *Introduction*

---

The next three chapters are dedicated to the study of total protection strategies, associated to the  $w$ -domination in graphs. The first one, deal with the problem of finding the total domination number for the case of rooted product graphs. This covers a gap in the theory of total domination in graphs, since there are more than 580 published papers on this topic, among which at least 50 concern the case of product graphs, and none of these papers discusses the case of rooted product graphs. Chapters 3 and 4 are devoted to total Italian domination in graphs. In the first one, we introduce this parameter and then we study its combinatorial and computational properties. The second one deals with the case of lexicographic product graphs and, in particular, we show that the total Italian domination number and the double domination number coincide for this class of graphs.

In Chapter 5 we introduce the study of secure  $w$ -domination in graphs, we provide general results on the secure  $w$ -domination number and propose the challenge of conducting a detailed study of the topic.

The next four chapters are devoted to the study of two total protection strategies, associated to secure  $w$ -domination in graphs. Chapter 6 introduces the study of the total weak Roman domination number of a graph. For this parameter, we study combinatorial and computational properties. In Chapter 7 we obtain new relationships between the secure total domination number and other graph parameters. Some of these results are tight bounds that improve some well-known results. Chapter 8 considers the secure total domination number for the particular case of rooted product graphs. Finally, Chapter 9 deals with the case of lexicographic product graphs, where we show that the secure total domination number and the total weak Roman domination number coincide for this class of graphs, and we obtain closed formulas and tight bounds for these parameters.

In Chapter 10 we show how the secure (total) domination number and the (total) weak Roman domination number of lexicographic product graphs  $G \circ H$  are related to  $\gamma_w^s(G)$  or  $\gamma_w(G)$ . For the case of the secure domination number and the weak Roman domination number, the decision on whether  $w$  takes specific components will depend on the value of  $\gamma_{(1,0)}^s(H)$ , while in the case of the total version of these parameters, the decision will depend on the value of  $\gamma_{(1,1)}^s(H)$ .

In Chapter Conclusions, we present some concluding remarks, summarize the contributions of the thesis, and give a list of future works. Finally, we present the references.

# Chapter 1

## From Italian domination in lexicographic product graphs to $w$ -domination in graphs

This chapter includes a complete copy of the following paper.

A. Cabrera Martínez, A. Estrada-Moreno, J.A. Rodríguez-Velázquez. From Italian domination in lexicographic product graphs to  $w$ -domination in graphs, *ARS Math. Contemp.* In press.

URL: <https://doi.org/10.26493/1855-3974.2318.fb9>

Quality indicators:

2019 JCR Impact factor: 0.642, Q3 (217/325), Mathematics.



ISSN 1855-3966 (printed edn.), ISSN 1855-3974 (electronic edn.)  
ARS MATHEMATICA CONTEMPORANEA  
<https://doi.org/10.26493/1855-3974.2318.fb9>  
(Also available at <http://amc-journal.eu>)

# From Italian domination in lexicographic product graphs to $w$ -domination in graphs\*

Abel Cabrera Martínez, Alejandro Estrada-Moreno,  
Juan Alberto Rodríguez-Velázquez

*Universitat Rovira i Virgili, Departament d'Enginyeria Informàtica i Matemàtiques,  
Av. Països Catalans 26, 43007 Tarragona, Spain*

Received 23 April 2020, accepted 9 May 2021

---

## Abstract

In this paper, we show that the Italian domination number of every lexicographic product graph  $G \circ H$  can be expressed in terms of five different domination parameters of  $G$ . These parameters can be defined under the following unified approach, which encompasses the definition of several well-known domination parameters and introduces new ones.

Let  $N(v)$  denote the open neighbourhood of  $v \in V(G)$ , and let  $w = (w_0, w_1, \dots, w_l)$  be a vector of nonnegative integers such that  $w_0 \geq 1$ . We say that a function  $f : V(G) \rightarrow \{0, 1, \dots, l\}$  is a  $w$ -dominating function if  $f(N(v)) = \sum_{u \in N(v)} f(u) \geq w_i$  for every vertex  $v$  with  $f(v) = i$ . The weight of  $f$  is defined to be  $\omega(f) = \sum_{v \in V(G)} f(v)$ . The  $w$ -domination number of  $G$ , denoted by  $\gamma_w(G)$ , is the minimum weight among all  $w$ -dominating functions on  $G$ .

Specifically, we show that  $\gamma_I(G \circ H) = \gamma_w(G)$ , where  $w \in \{2\} \times \{0, 1, 2\}^l$  and  $l \in \{2, 3\}$ . The decision on whether the equality holds for specific values of  $w_0, \dots, w_l$  will depend on the value of the domination number of  $H$ . This paper also provides preliminary results on  $\gamma_w(G)$  and raises the challenge of conducting a detailed study of the topic.

*Keywords:* Italian domination,  $w$ -domination,  $k$ -domination,  $k$ -tuple domination, lexicographic product graph.

*Math. Subj. Class. (2020):* 05C69, 05C76

---

---

\*The authors would thank the anonymous reviewers for their generous time in providing detailed comments and suggestions that helped us to improve the paper.

*E-mail addresses:* [abel.cabrera@urv.cat](mailto:abel.cabrera@urv.cat) (Abel Cabrera Martínez), [alejandro.estrada@urv.cat](mailto:alejandro.estrada@urv.cat) (Alejandro Estrada-Moreno), [juanalberto.rodriguez@urv.cat](mailto:juanalberto.rodriguez@urv.cat) (Juan Alberto Rodríguez-Velázquez)

## 1 Introduction

Let  $G$  be a graph,  $l$  a positive integer, and  $f : V(G) \rightarrow \{0, \dots, l\}$  a function. For every  $i \in \{0, \dots, l\}$ , we define  $V_i = \{v \in V(G) : f(v) = i\}$ . We will identify  $f$  with the subsets  $V_0, \dots, V_l$  associated with it, and so we will use the unified notation  $f(V_0, \dots, V_l)$  for the function and these associated subsets. The weight of  $f$  is defined to be

$$\omega(f) = f(V(G)) = \sum_{i=1}^l i|V_i|.$$

An *Italian dominating function* (IDF) on a graph  $G$  is a function  $f(V_0, V_1, V_2)$  satisfying that  $f(N(v)) = \sum_{u \in N(v)} f(u) \geq 2$  for every  $v \in V_0$ , where  $N(v)$  denotes the open neighbourhood of  $v$ . Hence,  $f(V_0, V_1, V_2)$  is an IDF if  $N(v) \cap V_2 \neq \emptyset$  or  $|N(v) \cap V_1| \geq 2$  for every  $v \in V_0$ . The *Italian domination number*, denoted by  $\gamma_I(G)$ , is the minimum weight among all IDFs on  $G$ . This concept was introduced by Chellali et al. in [6] under the name of Roman  $\{2\}$ -domination. The term ‘‘Italian domination’’ comes from a subsequent paper by Henning and Klostermeyer [13].

In this paper we show that the Italian domination number of every lexicographic product graph  $G \circ H$  can be expressed in terms of five different domination parameters of  $G$ . These parameters can be defined under the following unified approach.

Let  $w = (w_0, \dots, w_l)$  be a vector of nonnegative integers such that  $w_0 \geq 1$ . We say that  $f(V_0, \dots, V_l)$  is a *w-dominating function* if  $f(N(v)) \geq w_i$  for every  $v \in V_i$ . The *w-domination number* of  $G$ , denoted by  $\gamma_w(G)$ , is the minimum weight among all *w-dominating functions* on  $G$ . For simplicity, a *w-dominating function*  $f$  of weight  $\omega(f) = \gamma_w(G)$  will be called a  $\gamma_w(G)$ -function.

This unified approach allows us to encompass the definition of several well-known domination parameters and introduce new ones. For instance, we would highlight the following particular cases of known domination parameters that we define here in terms of *w-domination*.

- The *domination number* of  $G$  is defined to be  $\gamma(G) = \gamma_{(1,0)}(G) = \gamma_{(1,0,0)}(G)$ . Obviously, every  $\gamma_{(1,0,0)}(G)$ -function  $f(V_0, V_1, V_2)$  satisfies that  $V_2 = \emptyset$  and  $V_1$  is a dominating set of cardinality  $|V_1| = \gamma(G)$ , i.e.,  $V_1$  is a  $\gamma(G)$ -set.
- The *total domination number* of a graph  $G$  with no isolated vertex is defined to be  $\gamma_t(G) = \gamma_{(1,1)}(G) = \gamma_{(1,1,w_2,\dots,w_l)}(G)$ , for every  $w_2, \dots, w_l \in \{0, 1\}$ . Notice that there exists a  $\gamma_{(1,1,w_2,\dots,w_l)}(G)$ -function  $f(V_0, V_1, \dots, V_l)$  such that  $V_i = \emptyset$  for every  $i \in \{2, \dots, l\}$  and  $V_1$  is a total dominating set of cardinality  $|V_1| = \gamma_t(G)$ , i.e.,  $V_1$  is a  $\gamma_t(G)$ -set.
- Given a positive integer  $k$ , the *k-domination number* of a graph  $G$  is defined to be  $\gamma_k(G) = \gamma_{(k,0)}(G)$ . In this case,  $V_1$  is a *k-dominating set* of cardinality  $|V_1| = \gamma_k(G)$ , i.e.,  $V_1$  is a  $\gamma_k(G)$ -set. The study of *k-domination* in graphs was initiated by Fink and Jacobson [8] in 1984.
- Given a positive integer  $k$ , the *k-tuple domination number* of a graph  $G$  of minimum degree  $\delta \geq k - 1$  is defined to be  $\gamma_{\times k}(G) = \gamma_{(k,k-1)}(G)$ . In this case,  $V_1$  is a *k-tuple dominating set* of cardinality  $|V_1| = \gamma_{\times k}(G)$ , i.e.,  $V_1$  is a  $\gamma_{\times k}(G)$ -set. In particular,  $\gamma_{\times 1}(G) = \gamma(G)$  and  $\gamma_{\times 2}(G)$  is known as the *double domination number* of  $G$ . This parameter was introduced by Harary and Haynes in [9].

- Given a positive integer  $k$ , the  $k$ -tuple total domination number of a graph  $G$  of minimum degree  $\delta \geq k$  is defined to be  $\gamma_{\times k,t}(G) = \gamma_{(k,k)}(G)$ . In particular,  $\gamma_{\times 1,t}(G) = \gamma_t(G)$  and  $\gamma_{\times 2,t}(G)$  is known as the *double total domination number*, and  $V_1$  is a double total dominating set of cardinality  $|V_1| = \gamma_{\times 2,t}(G)$ , i.e.,  $V_1$  is a  $\gamma_{\times 2,t}(G)$ -set. The  $k$ -tuple total domination number was introduced by Henning and Kazemi in [12].
- The *Italian domination number* of  $G$  is defined to be  $\gamma_I(G) = \gamma_{(2,0,0)}(G)$ . As mentioned earlier, this parameter was introduced by Chellali et al. in [6] under the name of Roman  $\{2\}$ -domination number. The concept was studied further in [13, 16].
- The *total Italian domination number* of a graph  $G$  with no isolated vertex is defined to be  $\gamma_{tI}(G) = \gamma_{(2,1,1)}(G)$ . This parameter was introduced by Cabrera et al. in [4], and independently by Abdollahzadeh Ahangar et al. in [1], under the name of total Roman  $\{2\}$ -domination number. The total Italian domination number of lexicographic product graphs was studied in [5].
- The  $\{k\}$ -domination number of  $G$  is defined to be  $\gamma_{\{k\}}(G) = \gamma_{(k,k-1,\dots,1,0)}(G)$ . This parameter was introduced by Domke et al. in [7] and studied further in [3, 15, 17].

Notice that the concept of  $Y$ -dominating function introduced by Bange et.al. [2] is quite different from the concept of  $w$ -dominating function introduced in this paper. Given a set  $Y$  of real numbers, a function  $f : V(G) \rightarrow Y$  is a  $Y$ -dominating function if  $f(N[v]) = f(v) + \sum_{u \in N(v)} f(u) \geq 1$  for every  $v \in V(G)$ . The  $Y$ -domination number, denoted by  $\gamma_Y(G)$ , is the minimum weight among all  $Y$ -dominating functions on  $G$ . Hence, if  $Y = \{0, 1, \dots, l\}$ , then  $\gamma_Y(G) = \gamma_{(1,0,\dots,0)}(G) = \gamma(G)$ .

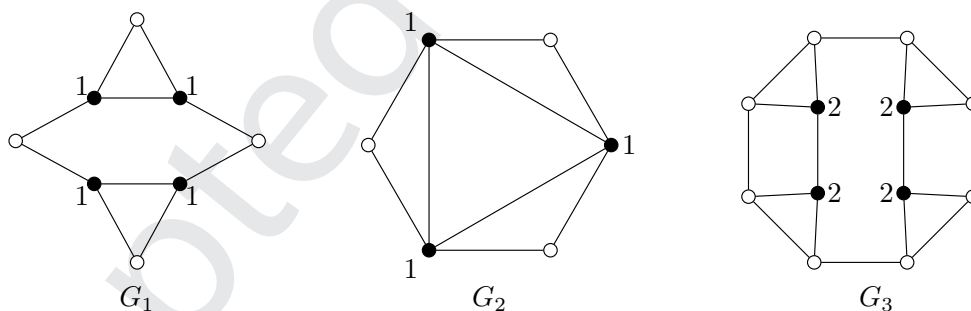

Figure 1: The labels of black-coloured vertices describe a  $\gamma_{(2,1,0)}(G_1)$ -function, a  $\gamma_{(2,2,0)}(G_2)$ -function and a  $\gamma_{(2,2,2)}(G_3)$ -function, respectively.

For the graphs shown in Figure 1 we have the following values.

- $\gamma_I(G_1) = \gamma_{(2,1,0)}(G_1) = \gamma_{(2,2,0)}(G_1) = 4 < 6 = \gamma_{(2,2,1)}(G_1) = \gamma_{(2,2,2)}(G_1)$ .
- $\gamma_I(G_2) = \gamma_{(2,1,0)}(G_2) = \gamma_{(2,2,0)}(G_2) = \gamma_{(2,2,1)}(G_2) = \gamma_{(2,2,2)}(G_2) = 3$ .
- $\gamma_I(G_3) = \gamma_{(2,1,0)}(G_3) = 6 < 8 = \gamma_{(2,2,0)}(G_3) = \gamma_{(2,2,1)}(G_3) = \gamma_{(2,2,2)}(G_3)$ .

The remainder of the paper is organized as follows. In Section 2 we show that for any graph  $G$  with no isolated vertex and any nontrivial graph  $H$  with  $\gamma(H) \neq 3$  or  $\gamma_I(H) \neq 3$ ,



the Italian domination number of  $G \circ H$  equals one of the following parameters:  $\gamma_{(2,1,0)}(G)$ ,  $\gamma_{(2,2,0)}(G)$ ,  $\gamma_{(2,2,1)}(G)$  or  $\gamma_{(2,2,2)}(G)$ . The specific value  $\gamma_I(G \circ H)$  takes depends on the value of  $\gamma(H)$ . For the cases where  $\gamma_I(H) = \gamma(H) = 3$ , we show that  $\gamma_I(G \circ H) = \gamma_{(2,2,2,0)}(G)$ . Section 3 is devoted to providing some preliminary results on  $w$ -domination. We first describe some general properties of  $\gamma_w(G)$  and then dedicate a subsection to each of the specific cases declared of interest in Section 2.

We assume that the reader is familiar with the basic concepts, notation and terminology of domination in graph. If this is not the case, we suggest the textbooks [10, 11, 14]. For the remainder of the paper, definitions will be introduced whenever a concept is needed.

## 2 Italian domination in lexicographic product graphs

The *lexicographic product* of two graphs  $G$  and  $H$  is the graph  $G \circ H$  whose vertex set is  $V(G \circ H) = V(G) \times V(H)$  and  $(u, v)(x, y) \in E(G \circ H)$  if and only if  $ux \in E(G)$  or  $u = x$  and  $vy \in E(H)$ .

Notice that for any  $u \in V(G)$  the subgraph of  $G \circ H$  induced by  $\{u\} \times V(H)$  is isomorphic to  $H$ . For simplicity, we will denote this subgraph by  $H_u$ . Moreover, the neighbourhood of  $(x, y) \in V(G) \times V(H)$  will be denoted by  $N(x, y)$  instead of  $N((x, y))$ . Analogously, for any function  $f$  on  $G \circ H$ , the image of  $(x, y)$  will be denoted by  $f(x, y)$  instead of  $f((x, y))$ .

**Lemma 2.1.** *For any graph  $G$  with no isolated vertex and any nontrivial graph  $H$  with  $\gamma_I(H) \neq 3$  or  $\gamma(H) \neq 3$ , there exists a  $\gamma_I(G \circ H)$ -function  $f$  satisfying that  $f(V(H_u)) \leq 2$  for every  $u \in V(G)$ .*

*Proof.* Given an IDF  $f$  on  $G \circ H$ , we define the set  $R_f = \{x \in V(G) : f(V(H_x)) \geq 3\}$ . Let  $f$  be a  $\gamma_I(G \circ H)$ -function such that  $|R_f|$  is minimum among all  $\gamma_I(G \circ H)$ -functions. Suppose that  $|R_f| \geq 1$ . Let  $u \in R_f$  such that  $f(V(H_u))$  is maximum among all vertices belonging to  $R_f$ . Suppose that  $f(V(H_u)) > \gamma_I(H)$ . In this case we take a  $\gamma_I(H)$ -function  $h$  and construct an IDF  $g$  defined on  $G \circ H$  as  $g(u, y) = h(y)$  for every  $y \in V(H)$  and  $g(x, y) = f(x, y)$  for every  $x \in V(G) \setminus \{u\}$  and  $y \in V(H)$ . Obviously,  $\omega(g) < \omega(f)$ , which is a contradiction. Thus,  $3 \leq f(V(H_u)) \leq \gamma_I(H_u) = \gamma_I(H)$ . Now, we analyse the following two cases.

Case 1.  $f(V(H_u)) \geq 4$ . Let  $u' \in N(u)$  and  $v \in V(H)$ . We define a function  $f'$  on  $G \circ H$  as  $f'(u, v) = f'(u', v) = 2$ ,  $f'(u, y) = f'(u', y) = 0$  for every  $y \in V(H) \setminus \{v\}$ , and  $f'(x, y) = f(x, y)$  for every  $x \in V(G) \setminus \{u, u'\}$  and  $y \in V(H)$ . Notice that  $f'$  is an IDF on  $G \circ H$  with  $\omega(f') \leq \omega(f)$  and  $|R_{f'}| < |R_f|$ , which is a contradiction.

Case 2.  $f(V(H_u)) = 3$ . Suppose that  $\gamma_I(H) \neq 3$ . Since  $\gamma_I(H) \geq 4$ , there exist  $u' \in N(u)$  and  $v \in V(H)$  such that  $f(u', v) \geq 1$ . Hence, the function  $f'$  defined in Case 1 is an IDF on  $G \circ H$  with  $\omega(f') \leq \omega(f)$  and  $|R_{f'}| < |R_f|$ , which is again a contradiction.

Thus,  $\gamma_I(H) = 3$ , and so  $\gamma(H) \neq 3$ , which implies that  $\gamma(H) = 2$ . Let  $\{v_1, v_2\}$  be a  $\gamma(H)$ -set. Let  $u' \in N(u)$  and  $v' \in V(H)$  such that  $f(u', v') = \max\{f(u', y) : y \in V(H)\}$ . Consider the function  $f'$  defined as  $f'(u, v_1) = f'(u, v_2) = 1$ ,  $f'(u, y) = 0$  for every  $y \in V(H) \setminus \{v_1, v_2\}$ ,  $f'(u', v') = \min\{2, f(u', v') + 1\}$ ,  $f'(u', y) = 0$  for every  $y \in V(H) \setminus \{v'\}$ , and  $f'(x, y) = f(x, y)$  for every  $x \in V(G) \setminus \{u, u'\}$  and  $y \in V(H)$ . Notice that  $f'$  is an IDF on  $G \circ H$  with  $\omega(f') \leq \omega(f)$  and  $|R_{f'}| < |R_f|$ , which is a contradiction.

Therefore,  $R_f = \emptyset$ , and the result follows.  $\square$

**Theorem 2.2.** *The following statements hold for any graph  $G$  with no isolated vertex and any nontrivial graph  $H$  with  $\gamma_I(H) \neq 3$  or  $\gamma(H) \neq 3$ .*

- (i) *If  $\gamma(H) = 1$ , then  $\gamma_I(G \circ H) = \gamma_{(2,1,0)}(G)$ .*
- (ii) *If  $\gamma_2(H) = \gamma(H) = 2$ , then  $\gamma_I(G \circ H) = \gamma_{(2,2,0)}(G)$ .*
- (iii) *If  $\gamma_2(H) > \gamma(H) = 2$ , then  $\gamma_I(G \circ H) = \gamma_{(2,2,1)}(G)$ .*
- (iv) *If  $\gamma(H) \geq 3$ , then  $\gamma_I(G \circ H) = \gamma_{(2,2,2)}(G)$ .*

*Proof.* Let  $f(V_0, V_1, V_2)$  be a  $\gamma_I(G \circ H)$ -function which satisfies Lemma 2.1. Let  $f'(X_0, X_1, X_2)$  be the function defined on  $G$  by  $X_1 = \{x \in V(G) : f(V(H_x)) = 1\}$  and  $X_2 = \{x \in V(G) : f(V(H_x)) = 2\}$ . Notice that  $\gamma_I(G \circ H) = \omega(f) = \omega(f')$ . We claim that  $f'$  is a  $\gamma_{(w_0, w_1, w_2)}(G)$ -function. In order to prove this and find the values of  $w_0, w_1$  and  $w_2$ , we differentiate the following three cases.

Case 1.  $\gamma(H) = 1$ . Assume that  $x \in X_0$ . Since  $f(V(H_x)) = 0$ , for any  $y \in V(H)$  we have that  $f(N(x, y) \setminus V(H_x)) \geq 2$ . Thus,  $f'(N(x)) \geq 2$ . Now, assume that  $x \in X_1$ , and let  $(x, y) \in V_1$  be the only vertex in  $V(H_x)$  such that  $f(x, y) > 0$ . Since  $\gamma(H) = 1$ , for any  $z \in V(H) \setminus \{y\}$ , we have that  $f(N(x, z) \setminus V(H_x)) \geq 1$ , which implies that  $f'(N(x)) \geq 1$ . Therefore,  $f'$  is a  $(2, 1, 0)$ -dominating function on  $G$  and, as a consequence,  $\gamma_I(G \circ H) = \omega(f) = \omega(f') \geq \gamma_{(2,1,0)}(G)$ .

Now, for any  $\gamma_{(2,1,0)}(G)$ -function  $g(W_0, W_1, W_2)$  and any universal vertex  $v$  of  $H$ , the function  $g'(W'_0, W'_1, W'_2)$ , defined by  $W'_2 = W_2 \times \{v\}$  and  $W'_1 = W_1 \times \{v\}$ , is an IDF on  $G \circ H$ . Therefore,  $\gamma_I(G \circ H) \leq \omega(g') = \omega(g) = \gamma_{(2,1,0)}(G)$ .

Case 2.  $\gamma(H) = 2$ . As in Case 1 we conclude that  $f'(N(x)) \geq 2$  for every  $x \in X_0$ . Now, assume that  $x \in X_1$ , and let  $(x, y) \in V_1$  be the only vertex in  $V(H_x)$  such that  $f(x, y) > 0$ . Since  $\gamma(H) = 2$ , there exists a vertex  $z \in V(H)$  such that  $(x, z) \in V_0 \setminus N(x, y)$ . Hence,  $f(N(x, z) \setminus V(H_x)) \geq 2$ , which implies that  $f'(N(x)) \geq 2$ . Therefore,  $f'$  is a  $(2, 2, 0)$ -dominating function on  $G$  and, as a consequence,  $\gamma_I(G \circ H) = \omega(f) = \omega(f') \geq \gamma_{(2,2,0)}(G)$ .

Now, if  $\gamma_2(H) > \gamma(H) = 2$ , then for every  $x \in X_2$ , there exists  $y \in V(H)$  such that  $(x, y) \in V_0$  and  $f(N(x, y) \cap V(H_x)) \leq 1$ , which implies that  $f(N(x, y) \setminus V(H_x)) \geq 1$ , and so  $f'(N(x)) \geq 1$ . Hence,  $f'$  is a  $(2, 2, 1)$ -dominating function on  $G$  and, as a consequence,  $\gamma_I(G \circ H) = \omega(f) = \omega(f') \geq \gamma_{(2,2,1)}(G)$ .

On the other side, if  $\gamma_2(H) = 2$ , then for any  $\gamma_{(2,2,0)}(G)$ -function  $g(W_0, W_1, W_2)$  and any  $\gamma_2(H)$ -set  $S = \{v_1, v_2\}$ , the function  $g'(W'_0, W'_1, W'_2)$ , defined by  $W'_1 = (W_1 \times \{v_1\}) \cup (W_2 \times S)$  and  $W'_2 = \emptyset$ , is an IDF on  $G \circ H$ . Therefore,  $\gamma_I(G \circ H) \leq \omega(g') = \omega(g) = \gamma_{(2,2,0)}(G)$ .

Finally, if  $\gamma_2(H) > \gamma(H) = 2$  then we take a  $\gamma_{(2,2,1)}(G)$ -function  $h(Y_0, Y_1, Y_2)$  and a  $\gamma(H)$ -set  $S' = \{v'_1, v'_2\}$ , and construct a function  $h'(Y'_0, Y'_1, Y'_2)$  on  $G \circ H$  by making  $Y'_1 = (Y_1 \times \{v'_1\}) \cup (Y_2 \times S')$  and  $Y'_2 = \emptyset$ . Obviously,  $h'$  is an IDF on  $G \circ H$ , and so we can conclude that  $\gamma_I(G \circ H) \leq \omega(h') = \omega(h) = \gamma_{(2,2,1)}(G)$ .

Case 3.  $\gamma(H) \geq 3$ . In this case, for every  $x \in V(G)$ , there exists  $y \in V(H)$  such that  $f(N[(x, y)] \cap V(H_x)) = 0$ . Hence,  $f(N(x, y) \setminus V(H_x)) \geq 2$ , which implies that  $f'(N(x)) \geq 2$  for every  $x \in V(G)$ . Therefore,  $f'$  is a  $(2, 2, 2)$ -dominating function on  $G$  and, as a consequence,  $\gamma_I(G \circ H) = \omega(f) = \omega(f') \geq \gamma_{(2,2,2)}(G)$ .

On the other side, for any  $\gamma_{(2,2,2)}(G)$ -function  $g(W_0, W_1, W_2)$  and any  $v \in V(H)$ , the function  $g'(W'_0, W'_1, W'_2)$ , defined by  $W'_2 = W_2 \times \{v\}$  and  $W'_1 = W_1 \times \{v\}$ , is an IDF on  $G \circ H$ . Hence,  $\gamma_I(G \circ H) \leq \omega(g') = \omega(g) = \gamma_{(2,2,2)}(G)$ .

According to the three cases above, the result follows.  $\square$

The following result considers the case  $\gamma_I(H) = \gamma(H) = 3$ .

**Theorem 2.3.** *If  $H$  is a graph with  $\gamma_I(H) = \gamma(H) = 3$ , then for any graph  $G$ ,*

$$\gamma_I(G \circ H) = \gamma_{(2,2,2,0)}(G).$$

*Proof.* Let  $f(V_0, V_1, V_2)$  be a  $\gamma_I(G \circ H)$ -function, and  $f'(X_0, X_1, X_2, X_3)$  the function defined on  $G$  by  $X_1 = \{x \in V(G) : f(V(H_x)) = 1\}$ ,  $X_2 = \{x \in V(G) : f(V(H_x)) = 2\}$  and  $X_3 = \{x \in V(G) : f(V(H_x)) \geq 3\}$ . We claim that  $f'$  is a  $(2, 2, 2, 0)$ -dominating function on  $G$ .

Let  $x \in X_0 \cup X_1 \cup X_2$ . Since  $f(V(H_x)) \leq 2$  and  $\gamma(H) = 3$ , there exists  $y \in V(H)$  such that  $f(N[(x, y)] \cap V(H_x)) = 0$ . Thus,  $f'(N(x)) \geq 2$  for every  $x \in X_0 \cup X_1 \cup X_2$ , which implies that  $f'$  is a  $(2, 2, 2, 0)$ -dominating function on  $G$ . Therefore,  $\gamma_I(G \circ H) = \omega(f) \geq \omega(f') \geq \gamma_{(2,2,2,0)}(G)$ .

On the other side, let  $h(Y_0, Y_1, Y_2, Y_3)$  be a  $\gamma_{(2,2,2,0)}(G)$ -function,  $h_1$  a  $\gamma_I(H)$ -function and  $v \in V(H)$ . We define a function  $g$  on  $G \circ H$  by  $g(x, v) = h(x)$  for every  $x \in V(G) \setminus Y_3$ ,  $g(x, y) = 0$  for every  $x \in V(G) \setminus Y_3$  and  $y \in V(H) \setminus \{v\}$ , and  $g(x, y) = h_1(y)$  for every  $(x, y) \in Y_3 \times V(H)$ . A simple case analysis shows that  $g$  is an IDF on  $G \circ H$ . Therefore,  $\gamma_I(G \circ H) \leq \omega(g) = \omega(h) = \gamma_{(2,2,2,0)}(G)$ .  $\square$

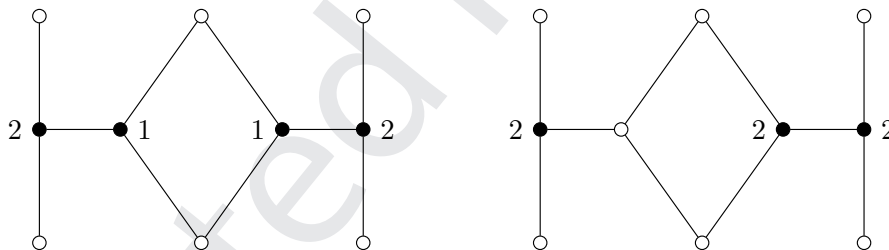

Figure 2: This figure shows two  $\gamma_{(2,2,0)}(G)$ -functions on the same graph. The function on the left is also a  $\gamma_{(2,2,1)}(G)$ -function.

The graph shown in Figure 2 satisfies  $6 = \gamma_{(2,2,0)}(G) = \gamma_{(2,2,1)}(G) < 7 = \gamma_{(2,2,2,0)}(G) < \gamma_{(2,2,2)}(G) = 8$ .

### 3 Preliminary results on $w$ -domination

In this section, we fix the notation  $\mathbb{Z}^+ = \{1, 2, 3, \dots\}$  and  $\mathbb{N} = \mathbb{Z}^+ \cup \{0\}$  for the sets of positive and nonnegative integers, respectively.

Throughout this section, we will repeatedly apply, without explicit mention, the following necessary and sufficient condition for the existence of a  $w$ -dominating function.

**Remark 3.1.** Let  $G$  be a graph of minimum degree  $\delta$  and let  $w = (w_0, \dots, w_l) \in \mathbb{Z}^+ \times \mathbb{N}^l$ . If  $w_0 \geq \dots \geq w_l$ , then there exists a  $w$ -dominating function on  $G$  if and only if  $w_l \leq l\delta$ .

*Proof.* Let  $w = (w_0, \dots, w_l) \in \mathbb{Z}^+ \times \mathbb{N}^l$  such that  $w_0 \geq \dots \geq w_l$ . If  $w_l \leq l\delta$ , then the function  $f$ , defined by  $f(v) = l$  for every  $v \in V(G)$ , is a  $w$ -dominating function on  $G$ , as  $V_l = V(G)$  and for any  $x \in V_l$ ,  $f(N(x)) \geq l\delta \geq w_l$ .

Now, suppose that  $w_l > l\delta$ . If  $g$  is a  $w$ -dominating function on  $G$ , then for any vertex  $v$  of degree  $\delta$  we have  $g(N(v)) \leq \delta l < w_l \leq w_{l-1} \leq \dots \leq w_0$ , which is a contradiction. Therefore, the result follows.  $\square$

We will show that in general the  $w$ -domination numbers satisfy a certain monotonicity. Given two integer vectors  $w = (w_0, \dots, w_l)$  and  $w' = (w'_0, \dots, w'_l)$ , we say that  $w \prec w'$  if  $w_i \leq w'_i$  for every  $i \in \{0, \dots, l\}$ . With this notation in mind, we can state the next remark which is direct consequence of the definition of  $w$ -domination number.

**Remark 3.2.** Let  $G$  be a graph of minimum degree  $\delta$  and let  $w = (w_0, \dots, w_l), w' = (w'_0, \dots, w'_l) \in \mathbb{Z}^+ \times \mathbb{N}^l$  such that  $w_i \geq w_{i+1}$  and  $w'_i \geq w'_{i+1}$  for every  $i \in \{0, \dots, l-1\}$ . If  $w \prec w'$  and  $w'_l \leq l\delta$ , then every  $w'$ -dominating function is a  $w$ -dominating function and, as a consequence,

$$\gamma_w(G) \leq \gamma_{w'}(G).$$

We would emphasize the following remark on the specific cases of domination parameters considered in Section 2. Obviously, when we write  $\gamma_{(2,2,2)}(G)$  or  $\gamma_{(2,2,1)}(G)$ , we are assuming that  $G$  has minimum degree  $\delta \geq 1$ .

**Remark 3.3.** The following statements hold.

- (i)  $\gamma_I(G) = \gamma_{(2,0,0)}(G) \leq \gamma_{(2,1,0)}(G) \leq \gamma_{(2,2,0)}(G) \leq \gamma_{(2,2,1)}(G) \leq \gamma_{(2,2,2)}(G)$ .
- (ii) If  $w_2 \in \{1, 2\}$ , then  $\gamma_{(1,0,w_2)}(G) = \gamma_{(1,0,0)}(G) = \gamma(G)$  and  $\gamma_{(1,1,w_2)}(G) = \gamma_{(1,1,0)}(G) = \gamma_t(G)$ .
- (iii) For any integer  $k \geq 3$ , there exists an infinite family  $\mathcal{H}_k$  of graphs such that for every graph  $G \in \mathcal{H}_k$ ,  $\gamma_I(G) = \gamma_{(2,0,0)}(G) = \gamma_{(2,1,0)}(G) = \gamma_{(2,2,0)}(G) = \gamma_{(2,2,1)}(G) = \gamma_{(2,2,2)}(G) = k$ .
- (iv) There exists an infinite family of graphs such that  $\gamma_I(G) < \gamma_{(2,1,0)}(G) < \gamma_{(2,2,0)}(G) < \gamma_{(2,2,1)}(G) < \gamma_{(2,2,2)}(G)$ .

In order to see that the remark above holds, we just have to construct families of graphs satisfying (iii) and (iv), as (i) is a particular case of Remark 3.2 and (ii) is derived from the definition of  $(w_0, w_1, w_2)$ -domination number. In the case of (iii), we construct a family  $\mathcal{H}_k = \{G_{k,r} : r \in \mathbb{Z}^+\}$  as follows. Let  $k \geq 3$  be an integer, and let  $N_r$  be the empty graph of order  $r$ . For any positive integer  $r$  we construct a graph  $G_{k,r} \in \mathcal{H}_k$  from a complete graph  $K_k$  and  $\binom{k}{2}$  copies of  $N_r$ , in such way that for each pair of different vertices  $\{x, y\}$  of  $K_k$  we choose one copy of  $N_r$  and connect every vertex of  $N_r$  with  $x$  and  $y$ , making  $x$  and  $y$  vertices of degree  $(k-1)(r+1)$  in  $G_{k,r}$ . For instance, the graph  $G_{3,1}$  is isomorphic to the graph  $G_2$  shown in Figure 1. It is readily seen that  $\gamma_I(G_{k,r}) = \gamma_{(2,2,2)}(G_{k,r}) = k$ . On the other hand, in the case of (iv), we consider the family of cycles of order  $n \geq 10$  with  $n \equiv 1 \pmod{3}$ . For these graphs we have that  $\gamma_I(C_n) < \gamma_{(2,1,0)}(C_n) < \gamma_{(2,2,0)}(C_n) < \gamma_{(2,2,1)}(C_n) < \gamma_{(2,2,2)}(C_n)$ . The specific values of  $\gamma_{(w_0, w_1, w_2)}(C_n)$  will be given in Subsections 3.1, ..., 3.4.

Next we show a class of graphs where  $\gamma_{(w_0, \dots, w_l)}(G) = w_0 \gamma(G)$  whenever  $l \geq w_0 \geq \dots \geq w_l$ . To this end, we need to introduce some additional notation and terminology.

Given two graphs  $G_1$  and  $G_2$ , the *corona product graph*  $G_1 \odot G_2$  is the graph obtained from  $G_1$  and  $G_2$ , by taking one copy of  $G_1$  and  $|V(G_1)|$  copies of  $G_2$  and joining by an edge every vertex from the  $i^{\text{th}}$ -copy of  $G_2$  with the  $i^{\text{th}}$ -vertex of  $G_1$ . For every  $x \in V(G_1)$ , the copy of  $G_2$  in  $G_1 \odot G_2$  associated to  $x$  will be denoted by  $G_{2,x}$ . It is well known that  $\gamma(G_1 \odot G_2) = |V(G_1)|$  and, if  $G_1$  does not have isolated vertices, then  $\gamma_t(G_1 \odot G_2) = \gamma(G_1 \odot G_2) = |V(G_1)|$ .

**Theorem 3.4.** *Let  $G \cong G_1 \odot G_2$  be a corona graph where  $G_1$  does not have isolated vertices, and let  $w = (w_0, \dots, w_l) \in \mathbb{Z}^+ \times \mathbb{N}^l$ . If  $l \geq w_0 \geq \dots \geq w_l$  and  $|V(G_2)| \geq w_0$ , then*

$$\gamma_w(G) = w_0 \gamma(G).$$

*Proof.* Since  $G_1$  does not have isolated vertices, the upper bound  $\gamma_w(G) \leq w_0 |V(G_1)| = w_0 \gamma(G)$  is straightforward, as the function  $f$ , defined by  $f(x) = w_0$  for every vertex  $x \in V(G_1)$  and  $f(x) = 0$  for every  $x \in V(G) \setminus V(G_1)$ , is a  $w$ -dominating function on  $G$ .

On the other hand, let  $f$  be a  $\gamma_w(G)$ -function and suppose that there exists  $x \in V(G_1)$  such that  $f(V(G_{2,x})) + f(x) \leq w_0 - 1$ . In such a case,  $f(N[y]) \leq w_0 - 1$  for every  $y \in V(G_{2,x})$ , which is a contradiction, as  $|V(G_2)| \geq w_0$ . Therefore,  $\gamma_w(G) = \omega(f) \geq w_0 |V(G_1)| = w_0 \gamma(G)$ .  $\square$

**Proposition 3.5.** *Let  $G$  be a graph of order  $n$ . Let  $w = (w_0, \dots, w_l) \in \mathbb{Z}^+ \times \mathbb{N}^l$  such that  $w_0 \geq \dots \geq w_l$ . If  $G'$  is a spanning subgraph of  $G$  with minimum degree  $\delta' \geq \frac{w_l}{l}$ , then*

$$\gamma_w(G) \leq \gamma_w(G').$$

*Proof.* Let  $E^- = \{e_1, \dots, e_k\}$  be the set of all edges of  $G$  not belonging to the edge set of  $G'$ . Let  $G'_0 = G$  and, for every  $i \in \{1, \dots, k\}$ , let  $X_i = \{e_1, \dots, e_i\}$  and  $G'_i = G - X_i$ , the edge-deletion subgraph of  $G$  induced by  $E(G) \setminus X_i$ . Since any  $w$ -dominating function on  $G'_i$  is a  $w$ -dominating function on  $G'_{i-1}$ , we can conclude that  $\gamma_w(G'_{i-1}) \leq \gamma_w(G'_i)$ . Hence,  $\gamma_w(G) = \gamma_w(G'_0) \leq \gamma_w(G'_1) \leq \dots \leq \gamma_w(G'_k) = \gamma_w(G')$ .  $\square$

From Proposition 3.5 we obtain the following result.

**Corollary 3.6.** *Let  $G$  be a graph of order  $n$  and  $w = (w_0, \dots, w_l) \in \mathbb{Z}^+ \times \mathbb{N}^l$  such that  $w_0 \geq \dots \geq w_l$ .*

- *If  $G$  is a Hamiltonian graph and  $w_l \leq 2l$ , then  $\gamma_w(G) \leq \gamma_w(C_n)$ .*
- *If  $G$  has a Hamiltonian path and  $w_l \leq l$ , then  $\gamma_w(G) \leq \gamma_w(P_n)$ .*

In order to derive lower bounds on the  $w$ -domination number, we need to state the following useful lemma.

**Lemma 3.7.** *Let  $G$  be a graph with no isolated vertex, maximum degree  $\Delta$  and order  $n$ . For any  $w$ -dominating function  $f(V_0, \dots, V_l)$  on  $G$  such that  $w_0 \geq \dots \geq w_l$ ,*

$$\Delta \omega(f) \geq w_0 n + \sum_{i=1}^l (w_i - w_0) |V_i|.$$

*Proof.* The result follows from the simple fact that the contribution of any vertex  $x \in V(G)$  to the sum  $\sum_{x \in V(G)} f(N(x))$  equals  $\deg(x)f(x)$ , where  $\deg(x)$  denotes the degree of  $x$ .

Hence,

$$\begin{aligned} \Delta\omega(f) &= \Delta \sum_{x \in V(G)} f(x) \\ &\geq \sum_{x \in V(G)} \deg(x)f(x) \\ &= \sum_{x \in V(G)} f(N(x)) \\ &\geq w_0|V_0| + \sum_{i=1}^l w_i|V_i| \\ &= w_0n + \sum_{i=1}^l (w_i - w_0)|V_i|. \end{aligned}$$

Therefore, the result follows.  $\square$

**Corollary 3.8.** *The following statements hold for  $k, l \in \mathbb{Z}^+$  and a graph  $G$  with minimum degree  $\delta \geq 1$ , maximum degree  $\Delta$  and order  $n$ .*

- (i) *If  $k \leq l\delta + 1$  and  $w = (\underbrace{k+l-1, k+l-2, \dots, k-1}_{l+1})$ , then  $\gamma_w(G) \geq \left\lceil \frac{(k+l-1)n}{\Delta+1} \right\rceil$*
- (ii) *If  $k \leq l\delta$  and  $w = (\underbrace{k, \dots, k}_{l+1})$ , then  $\gamma_w(G) \geq \left\lceil \frac{kn}{\Delta} \right\rceil$*
- (iii) *If  $k \leq l\delta + 1$  and  $w = (\underbrace{k, k-1, \dots, k-1}_{l+1})$ , then  $\gamma_w(G) \geq \left\lceil \frac{kn}{\Delta+1} \right\rceil$*
- (iv) *Let  $w = (w_0, \dots, w_l)$  with  $w_0 \geq \dots \geq w_l$ . If  $l\delta \geq w_l$ , then  $\gamma_w(G) \geq \left\lceil \frac{w_0n}{\Delta+w_0} \right\rceil$ .*

In the next subsections we shall show that lower bounds above are tight. Corollary 3.8 implies the following known bounds.

$$\begin{aligned} \gamma(G) &\geq \left\lceil \frac{n}{\Delta+1} \right\rceil, \quad \gamma_t(G) \geq \left\lceil \frac{n}{\Delta} \right\rceil, \quad \gamma_I(G) \geq \left\lceil \frac{2n}{\Delta+2} \right\rceil, \quad \gamma_{tI}(G) \geq \left\lceil \frac{2n}{\Delta+1} \right\rceil, \\ \gamma_k(G) &\geq \left\lceil \frac{kn}{\Delta+k} \right\rceil, \quad \gamma_{\times k}(G) \geq \left\lceil \frac{kn}{\Delta+1} \right\rceil, \quad \gamma_{\{k\}} \geq \left\lceil \frac{kn}{\Delta+1} \right\rceil \quad \text{and} \quad \gamma_{\times k, t}(G) \geq \left\lceil \frac{kn}{\Delta} \right\rceil. \end{aligned}$$

It is readily seen that  $\gamma_{(w_0, \dots, w_l)}(G) = 1$  if and only if  $w_0 = 1, w_1 = 0$  and  $\gamma(G) = 1$ . Next we characterize the graphs with  $\gamma_{(w_0, \dots, w_l)}(G) = 2$ .

**Theorem 3.9.** *Let  $w = (w_0, \dots, w_l) \in \mathbb{Z}^+ \times \mathbb{N}^l$  such that  $w_0 \geq \dots \geq w_l$ . For a graph  $G$  of order at least three,  $\gamma_{(w_0, \dots, w_l)}(G) = 2$  if and only if one of the following conditions holds.*

- (i)  $w_2 = 0$ ,  $\gamma(G) = 1$  and either  $w_0 = 2$  or  $w_0 = w_1 = 1$ .
- (ii)  $w_0 = 1$ ,  $w_1 = 0$  and  $\gamma(G) = 2$ .
- (iii)  $w_0 = 1$ ,  $w_1 = 1$  and  $\gamma_t(G) = 2$ .
- (iv)  $w_0 = 2$ ,  $w_1 = 0$  and  $\gamma_2(G) = 2$ .
- (v)  $w_0 = 2$ ,  $w_1 = 1$  and  $\gamma_{\times 2}(G) = 2$ .

*Proof.* Assume first that  $\gamma_{(w_0, \dots, w_l)}(G) = 2$  and let  $f(V_0, \dots, V_l)$  be a  $\gamma_{(w_0, \dots, w_l)}(G)$ -function. Notice that  $w_0 \in \{1, 2\}$  and  $|V_2| \in \{0, 1\}$ . If  $|V_2| = 1$ , then  $w_2 = 0$  and  $V_i = \emptyset$  for every  $i \neq 0, 2$ . Hence,  $\gamma(G) = 1$  and either  $w_0 = 2$  or  $w_0 = w_1 = 1$ . Therefore, (i) follows.

Now we consider the case  $V_2 = \emptyset$ . Notice that  $V_1$  is a dominating set of cardinality two,  $w_1 \in \{0, 1\}$  and  $V_i = \emptyset$  for every  $i \neq 0, 1$ .

Assume first that  $w_0 = 1$  and  $w_1 = 0$ . If  $\gamma(G) = 1$ , then  $\gamma_{(w_0, \dots, w_l)}(G) = 1$ , which is a contradiction. Hence,  $\gamma(G) = 2$  and so (ii) follows. For  $w_0 + w_1 \geq 2$  we have the following possibilities.

If  $w_0 = w_1 = 1$ , then  $V_1$  is a total dominating set of cardinality two, and so  $\gamma_t(G) = 2$ . Therefore, (iii) follows.

If  $w_0 = 2$  and  $w_1 = 0$ , then  $V_1$  is a 2-dominating set of cardinality two, which implies that  $\gamma_2(G) = 2$ . Therefore, (iv) follows.

If  $w_0 = 2$  and  $w_1 = 1$ , then  $V_1$  is a double dominating set of cardinality two, and this implies that  $\gamma_{\times 2}(G) = 2$ . Therefore, (v) follows.

Conversely, if one of the five conditions holds, then it is easy to check that  $\gamma_{(w_0, \dots, w_l)}(G) = 2$ , which completes the proof.  $\square$

In order to establish the following result, we need to define the following parameter.

$$\nu_{(w_0, \dots, w_l)}(G) = \max\{|V_0| : f(V_0, \dots, V_l) \text{ is a } \gamma_{(w_0, \dots, w_l)}(G)\text{-function.}\}$$

In particular, for  $l = 1$  and a graph  $G$  of order  $n$ , we have that  $\nu_{(w_0, w_1)}(G) = n - \gamma_{(w_0, w_1)}(G)$ .

**Theorem 3.10.** *Let  $G$  be a graph of minimum degree  $\delta$  and order  $n$ . The following statements hold for any  $(w_0, \dots, w_l) \in \mathbb{Z}^+ \times \mathbb{N}^l$  with  $w_0 \geq \dots \geq w_l$ .*

- (i) *If there exists  $i \in \{1, \dots, l-1\}$  such that  $i\delta \geq w_i$ , then*

$$\gamma_{(w_0, \dots, w_l)}(G) \leq \gamma_{(w_0, \dots, w_i)}(G).$$

- (ii) *If  $l \geq i + 1 \geq w_0$ , then*

$$\gamma_{(w_0, \dots, w_i, 0, \dots, 0)}(G) \leq (i + 1)\gamma(G).$$

- (iii) *Let  $k, i \in \mathbb{Z}^+$  such that  $l \geq ki$ , and let  $(w'_0, w'_1, \dots, w'_i) \in \mathbb{Z}^+ \times \mathbb{N}^i$ . If  $i\delta \geq w'_i$  and  $w_{kj} = kw'_j$  for every  $j \in \{0, 1, \dots, i\}$ , then*

$$\gamma_{(w_0, \dots, w_l)}(G) \leq k\gamma_{(w'_0, \dots, w'_i)}(G).$$

A. Cabrera Martínez et al.: From Italian domination in lexicographic product graphs to ... 11

(iv) Let  $k \in \mathbb{Z}^+$  and  $\beta_1, \dots, \beta_k \in \mathbb{Z}^+$ . If  $l\delta \geq k + w_l > k$  and  $w_0 + k \geq \beta_1 \geq \dots \geq \beta_k \geq w_1 + k$ , then

$$\gamma_{(w_0+k, \beta_1, \dots, \beta_k, w_1+k, \dots, w_l+k)}(G) \leq \gamma_{(w_0, \dots, w_l)}(G) + k(n - \nu_{(w_0, \dots, w_l)}(G)).$$

(v) If  $l\delta \geq w_l \geq l \geq 2$ , then

$$\gamma_{(w_0, \dots, w_l)}(G) \leq l\gamma_{(w_0-l+1, w_l-l+1)}(G).$$

(vi) If  $\delta \geq 1$ ,  $w_0 \leq l - 1$  and  $w_{l-1} \geq 1$ , then

$$\gamma_{(w_0, \dots, w_{l-2}, 1)}(G) \leq \gamma_{(w_0, \dots, w_{l-1}, 0)}(G).$$

*Proof.* If there exists  $i \in \{1, \dots, l-1\}$  such that  $i\delta \geq w_i$ , then for any  $\gamma_{(w_0, \dots, w_l)}(G)$ -function  $f(V_0, \dots, V_l)$  we define a  $(w_0, \dots, w_l)$ -dominating function  $g(W_0, \dots, W_l)$  by  $W_j = V_j$  for every  $j \in \{0, \dots, i\}$  and  $W_j = \emptyset$  for every  $j \in \{i+1, \dots, l\}$ . Hence,  $\gamma_{(w_0, \dots, w_l)}(G) \leq \omega(g) = \omega(f) = \gamma_{(w_0, \dots, w_l)}(G)$ . Therefore, (i) follows.

Now, assume  $l \geq i+1 \geq w_0$ . Let  $S$  be a  $\gamma(G)$ -set. Let  $f$  be the function defined by  $f(v) = i+1$  for every  $v \in S$  and  $f(v) = 0$  for the remaining vertices. Since  $f$  is a  $(w_0, \dots, w_i, 0, \dots, 0)$ -dominating function, we conclude that  $\gamma_{(w_0, \dots, w_i, 0, \dots, 0)}(G) \leq \omega(f) = (i+1)|S| = (i+1)\gamma(G)$ , which implies that (ii) follows.

In order to prove (iii), assume that  $l \geq ki$ ,  $i\delta \geq w'_i$  and  $w_{kj} = kw'_j$  for every  $j \in \{0, \dots, i\}$ . Let  $f'(V'_0, \dots, V'_i)$  be a  $\gamma_{(w'_0, \dots, w'_i)}(G)$ -function. We construct a function  $f(V_0, \dots, V_l)$  as  $f(v) = kf'(v)$  for every  $v \in V(G)$ . Hence,  $V_{kj} = V'_j$  for every  $j \in \{0, \dots, i\}$ , while  $V_j = \emptyset$  for the remaining cases. Thus, for every  $v \in V_{kj}$  with  $j \in \{0, \dots, i\}$  we have that  $f(N(v)) = kf'(N(v)) \geq kw'_j = w_{kj}$ , which implies that  $f$  is a  $(w_0, \dots, w_l)$ -dominating function, and so  $\gamma_{(w_0, \dots, w_l)}(G) \leq \omega(f) = k\omega(f') = k\gamma_{(w'_0, \dots, w'_i)}(G)$ . Therefore, (iii) follows.

Now, assume that  $l\delta \geq k + w_l > k$  and  $w_0 + k \geq \beta_1 \geq \dots \geq \beta_k \geq w_1 + k$ . Let  $g(W_0, \dots, W_l)$  be a  $\gamma_{(w_0, \dots, w_l)}(G)$ -function. We construct a function  $f(V_0, \dots, V_{l+k})$  as  $f(v) = g(v) + k$  for every  $v \in V(G) \setminus W_0$  and  $f(v) = 0$  for every  $v \in W_0$ . Hence,  $V_{j+k} = W_j$  for every  $j \in \{1, \dots, l\}$ ,  $V_0 = W_0$  and  $V_j = \emptyset$  for the remaining cases. Thus, if  $v \in V_{j+k}$  and  $j \in \{1, \dots, l\}$ , then  $f(N(v)) \geq g(N(v)) + k \geq w_j + k$ , and if  $v \in V_0$ , then  $f(N(v)) \geq g(N(v)) + k \geq w_0 + k$ . This implies that  $f$  is a  $(w_0 + k, \beta_1, \dots, \beta_k, w_1 + k, \dots, w_l + k)$ -dominating function, and so  $\gamma_{(w_0+k, \beta_1, \dots, \beta_k, w_1+k, \dots, w_l+k)}(G) \leq \omega(f) = \omega(g) + k \sum_{j=1}^l |W_j| = \gamma_{(w_0, \dots, w_l)}(G) + k(n - |W_0|) \leq \gamma_{(w_0, \dots, w_l)}(G) + k(n - \nu_{(w_0, \dots, w_l)}(G))$ . Therefore, (iv) follows.

Furthermore, if  $l\delta \geq w_l \geq l \geq 2$ , then by applying (iv) for  $k = l - 1$ , we deduce that

$$\gamma_{(w_0, \dots, w_l)}(G) \leq \gamma_{(w_0-l+1, w_l-l+1)}(G) + (l-1)(n - \nu_{(w_0-l+1, w_l-l+1)}(G)) = l\gamma_{(w_0-l+1, w_l-l+1)}(G).$$

Therefore, (v) follows.

From now on, let  $\delta \geq 1$ ,  $w_0 \leq l - 1$  and  $w_{l-1} \geq 1$ . Let  $f(V_0, \dots, V_l)$  be a  $\gamma_{(w_0, \dots, w_{l-1}, 0)}(G)$ -function. Assume first  $V_l = \emptyset$ . Since  $w_{l-1} \geq 1$ , we have that  $f$  is a  $(w_0, \dots, w_{l-2}, 1)$ -dominating function on  $G$ , which implies that (vi) follows. Assume now that there exists  $v \in V_l$ . If  $f(N(v)) \geq l - 1$ , then the function  $f'$ , defined by  $f'(v) = l - 1$  and  $f'(x) = f(x)$  for every  $x \in V(G) \setminus \{v\}$ , is a  $(w_0, \dots, w_{l-1}, 0)$ -dominating function with  $\omega(f') < \omega(f)$ , which is a contradiction. Hence,  $f(N(v)) \leq l - 2$  for every  $v \in V_l$ .



Since  $\delta \geq 1$ , for each vertex  $x \in V_l$ , we fix one vertex  $x' \in N(x)$  and we form a set  $S$  from them such that  $|S| \leq |V_l|$ . Let  $g$  be the function defined by  $g(x) = f(x) + 1$  for any  $x \in S$ ,  $g(y) = l - 1$  for any  $y \in V_l$ , and  $g(z) = f(z)$  for the remaining vertices of  $G$ . Since  $g(N(x)) \geq l - 1 \geq w_i$  for every  $x \in S$  and  $i \in \{0, \dots, l - 2\}$ ,  $g(N(y)) \geq 1$  for every  $y \in V_{l-1} \cup V_l$ , and  $g(N(z)) \geq w_i$  for every  $z \in V_i \setminus (S \cup V_{l-1} \cup V_l)$  and  $i \in \{0, \dots, l - 2\}$ , we conclude that  $g$  is a  $(w_0, \dots, w_{l-2}, 1)$ -dominating function on  $G$ . Therefore,  $\gamma_{(w_0, \dots, w_{l-2}, 1)}(G) \leq \omega(g) \leq \omega(f) = \gamma_{(w_0, \dots, w_{l-1}, 0)}(G)$ , which completes the proof of (vi).  $\square$

In the next subsections we consider several applications of Theorem 3.10 where we show that the bounds are tight. For instance, the following particular cases will be of interest.

**Corollary 3.11.** *Let  $G$  be a graph of minimum degree  $\delta$ , and let  $k, l, w_2, \dots, w_l \in \mathbb{Z}^+$  with  $k \geq w_2 \geq \dots \geq w_l$ .*

- (i) *If  $\delta \geq k$  and  $w = (k + 1, k, w_2, \dots, w_l)$ , then  $\gamma_w(G) \leq \gamma_{\times k}(G)$ .*
- (ii) *If  $\delta \geq k$  and  $w = (k, k, w_2, \dots, w_l)$ , then  $\gamma_w(G) \leq \gamma_{\times k, t}(G)$ .*
- (iii) *If  $l\delta \geq k \geq l \geq 2$  and  $w = (\underbrace{k + 1, k, \dots, k}_{l+1})$ , then  $\gamma_w(G) \leq l\gamma_{\times(k-l+2)}(G)$ .*
- (iv) *If  $l\delta \geq k \geq l \geq 2$  and  $w = (\underbrace{k, k, \dots, k}_{l+1})$ , then  $\gamma_w(G) \leq l\gamma_{\times(k-l+1), t}(G)$ .*
- (v) *If  $l \geq k$ ,  $\delta \geq 1$  and  $w = (\underbrace{k, \dots, k}_{l+1})$ , then  $\gamma_w(G) \leq k\gamma_t(G)$ .*

*Proof.* If  $\delta \geq k$ , then by Theorem 3.10 (i) we conclude that (i) and (ii) follows.

If  $l\delta \geq k \geq l \geq 2$ , then by Theorem 3.10 (v) we deduce that

$$\gamma_{(\underbrace{k+1, k, \dots, k}_{l+1})}(G) \leq l\gamma_{(k-l+2, k-l+1)}(G) = l\gamma_{\times(k-l+2)}(G).$$

Hence, (iii) follows. By analogy we derive (iv), as  $\gamma_{(k-l+1, k-l+1)}(G) = l\gamma_{\times(k-l+1), t}(G)$ .

Finally, if  $l \geq k$  and  $\delta \geq 1$ , then by Theorem 3.10 (iii) we deduce that

$$\gamma_{(\underbrace{k, \dots, k}_{l+1})}(G) \leq k\gamma_{(1, 1)}(G) = k\gamma_t(G).$$

Therefore, (v) follows.  $\square$

### 3.1 Preliminary results on $(2, 2, 2)$ -domination

**Theorem 3.12.** *For any graph  $G$  with no isolated vertex, order  $n$  and maximum degree  $\Delta$ ,*

$$\left\lceil \frac{2n}{\Delta} \right\rceil \leq \gamma_{(2, 2, 2)}(G) \leq 2\gamma_t(G).$$

*Furthermore, if  $G$  has minimum degree  $\delta \geq 2$ , then*

$$\gamma_{(2, 2, 2)}(G) \leq \gamma_{\times 2, t}(G).$$

*Proof.* From Corollary 3.8 we deduce the lower bound. The upper bound  $\gamma_{(2,2,2)}(G) \leq 2\gamma_t(G)$  follows by Corollary 3.11 (v), while, if  $\delta \geq 2$ , then we apply Corollary 3.11 (ii) to deduce that  $\gamma_{(2,2,2)}(G) \leq \gamma_{\times 2,t}(G)$ . Therefore, the result follows.  $\square$

The bounds above are tight. For instance, for the graphs  $G_2$  and  $G_3$  shown in Figure 1 we have that  $\lceil \frac{2n}{\Delta} \rceil = \gamma_{(2,2,2)}(G_2) = \gamma_{\times 2,t}(G_2) = 3$  and  $\gamma_{(2,2,2)}(G_3) = 2\gamma_t(G_3) = 8$ . Notice that every graph  $G_{k,r}$  belonging to the infinite family  $\mathcal{H}_k$  constructed after Remark 3.3 satisfies the equality  $\gamma_{(2,2,2)}(G_{k,r}) = \gamma_{\times 2,t}(G_{k,r}) = k$ . Furthermore, from Theorem 3.4 we have that for any corona graph  $G \cong G_1 \odot G_2$ , where  $G_1$  does not have isolated vertices,  $\gamma_{(2,2,2)}(G) = 2\gamma(G) = 2\gamma_t(G)$ .

Notice that by theorem 3.12 we have that  $\gamma_{(2,2,2)}(G) \geq \lceil \frac{2n}{\Delta} \rceil \geq 3$  for every graph  $G$  with no isolated vertex. Next we characterize all graphs with  $\gamma_{(2,2,2)}(G) = 3$ . To this end, we need to establish the following lemma.

**Lemma 3.13.** *For a graph  $G$ , the following statements are equivalent.*

- (i)  $\gamma_{(2,2,2)}(G) = \gamma_{\times 2,t}(G)$ .
- (ii) *There exists a  $\gamma_{(2,2,2)}(G)$ -function  $f(V_0, V_1, V_2)$  such that  $V_2 = \emptyset$ .*

*Proof.* If  $\gamma_{(2,2,2)}(G) = \gamma_{\times 2,t}(G)$ , then for any  $\gamma_{\times 2,t}(G)$ -set  $D$ , the function  $g(W_0, W_1, W_2)$ , defined by  $W_1 = D$  and  $W_0 = V(G) \setminus D$ , is a  $\gamma_{(2,2,2)}(G)$ -function. Therefore, (ii) follows.

Conversely, if there exists a  $\gamma_{(2,2,2)}(G)$ -function  $f(V_0, V_1, V_2)$  such that  $V_2 = \emptyset$ , then  $V_1$  is a double total dominating set of  $G$ , and so  $\gamma_{\times 2,t}(G) \leq |V_1| = \omega(f) = \gamma_{(2,2,2)}(G)$ . Therefore, Theorem 3.12 leads to  $\gamma_{(2,2,2)}(G) = \gamma_{\times 2,t}(G)$ .  $\square$

**Theorem 3.14.** *For a graph  $G$ , the following statements are equivalent.*

- (i)  $\gamma_{(2,2,2)}(G) = 3$ .
- (ii)  $\gamma_{\times 2,t}(G) = 3$ .

*Proof.* Assume first that  $\gamma_{(2,2,2)}(G) = 3$ , and let  $f(V_0, V_1, V_2)$  be a  $\gamma_{(2,2,2)}(G)$ -function. Suppose that there exists  $u \in V_2$ . Since  $f(N(u)) \geq 2$ , we deduce that  $\gamma_{(2,2,2)}(G) \geq 4$ , which is a contradiction. Hence,  $V_2 = \emptyset$  and by Lemma 3.13 we conclude that  $\gamma_{\times 2,t}(G) = 3$ .

Conversely, if  $\gamma_{\times 2,t}(G) = 3$ , then  $G$  has minimum degree  $\delta \geq 2$  and so Theorem 3.12 leads to  $3 \leq \lceil \frac{2n}{\Delta} \rceil \leq \gamma_{(2,2,2)}(G) \leq \gamma_{\times 2,t}(G) = 3$ . Therefore,  $\gamma_{(2,2,2)}(G) = 3$ .  $\square$

Next we consider the case of graphs with  $\gamma_{(2,2,2)}(G) = 4$ .

**Theorem 3.15.** *For a graph  $G$ ,  $\gamma_{(2,2,2)}(G) = 4$  if and only if at least one of the following conditions holds.*

- (i)  $\gamma_{\times 2,t}(G) = 4$ .
- (ii)  $\gamma_t(G) = 2$  and  $G$  has minimum degree  $\delta = 1$ .
- (iii)  $\gamma_t(G) = 2$  and  $\gamma_{\times 2,t}(G) \geq 4$ .

*Proof.* Assume  $\gamma_{(2,2,2)}(G) = 4$ . Notice that  $G$  does not have isolated vertices. Let  $f(V_0, V_1, V_2)$  be a  $\gamma_{(2,2,2)}(G)$ -function. If  $V_2 = \emptyset$ , then by Lemma 3.13 we obtain that  $\gamma_{\times 2,t}(G) = \gamma_{(2,2,2)}(G) = 4$ , and so (i) follows.

From now on, assume that  $|V_2| \in \{1, 2\}$ . If  $|V_2| = 2$ , then  $V_1 = \emptyset$  and, as a result,  $V_2$  is a total dominating set of  $G$ , which implies that  $\gamma_t(G) = 2$ . On the other side, if  $|V_2| = 1$ , then  $|V_1| = 2$  and both vertices belonging to  $V_1$  are adjacent to the vertex of weight two, and every  $v \in V_0$  satisfies  $N(v) \cap V_2 \neq \emptyset$  or  $V_1 \subseteq N(v)$ . This implies that the union of  $V_2$  with a singleton subset of  $V_1$  forms a total dominating set of  $G$ , and again  $\gamma_t(G) = 2$ . Now, if  $\delta \geq 2$ , then Theorem 3.12 leads to  $4 = \gamma_{(2,2,2)}(G) \leq \gamma_{\times 2,t}(G)$ . Hence, by Theorem 3.14 we conclude that either  $\delta = 1$  or  $\gamma_{\times 2,t}(G) \geq 4$ . Therefore, either (ii) or (iii) holds.

Conversely, if  $\gamma_{\times 2,t}(G) = 4$ , then  $G$  has minimum degree  $\delta \geq 2$  and by Theorem 3.12 we have that  $3 \leq \gamma_{(2,2,2)}(G) \leq 4$ . Hence, by Theorem 3.14 we deduce that  $\gamma_{(2,2,2)}(G) = 4$ . Finally, if  $\gamma_t(G) = 2$ , then Theorem 3.12 leads to  $3 \leq \gamma_{(2,2,2)}(G) \leq 4$ . Therefore, if  $\delta = 1$  or  $\gamma_{\times 2,t}(G) \geq 4$ , then Theorem 3.14 leads to  $\gamma_{(2,2,2)}(G) = 4$ .  $\square$

Theorem 3.12 implies the next result.

**Corollary 3.16.** *For any integer  $n \geq 3$ ,*

$$\gamma_{(2,2,2)}(C_n) = n.$$

In order to give the value of  $\gamma_{(2,2,2)}(P_n)$ , we recall the following well-known result.

**Proposition 3.17.** [14] *For any integer  $n \geq 3$ ,*

$$\gamma_t(P_n) = \begin{cases} \frac{n}{2} & \text{if } n \equiv 0 \pmod{4}, \\ \frac{n+1}{2} & \text{if } n \equiv 1, 3 \pmod{4}, \\ \frac{n}{2} + 1 & \text{if } n \equiv 2 \pmod{4}. \end{cases}$$

**Lemma 3.18.** *If  $P_n = u_1 u_2 \dots u_n$  is a path of order  $n \geq 6$ , then there exists a  $\gamma_{(2,2,2)}(P_n)$ -function  $f$  such that  $f(u_n) = f(u_{n-3}) = 0$  and  $f(u_{n-1}) = f(u_{n-2}) = 2$ .*

*Proof.* Let  $f(V_0, V_1, V_2)$  be a  $\gamma_{(2,2,2)}(P_n)$ -function such that  $|V_2|$  is maximum. Since  $u_n$  is a leaf,  $f(u_{n-1}) = 2$ . Notice that  $f(u_n) + f(u_{n-2}) \geq 2$ . Hence, we can assume that  $f(u_{n-2}) = 2$  and  $f(u_n) = 0$ . Now, if  $f(u_{n-3}) > 0$ , then we can define a  $(2, 2, 2)$ -dominating function  $f'$  by  $f'(u_{n-3}) = 0$ ,  $f'(u_{n-5}) = \min\{2, f(u_{n-5}) + f(u_{n-3})\}$  and  $f'(u_i) = f(u_i)$  for the remaining cases. Since  $\omega(f') \leq \omega(f) = \gamma_{(2,2,2)}(P_n)$ , either  $f'$  is a  $\gamma_{(2,2,2)}(P_n)$ -function with  $f'(u_{n-3}) = 0$  or  $f(u_{n-3}) = 0$ . In both cases the result follows.  $\square$

**Proposition 3.19.** *For any integer  $n \geq 3$ ,*

$$\gamma_{(2,2,2)}(P_n) = 2\gamma_t(P_n) = \begin{cases} n & \text{if } n \equiv 0 \pmod{4}, \\ n + 1 & \text{if } n \equiv 1, 3 \pmod{4}, \\ n + 2 & \text{if } n \equiv 2 \pmod{4}. \end{cases}$$

*Proof.* Since Theorem 3.12 leads to  $\gamma_{(2,2,2)}(P_n) \leq 2\gamma_t(P_n)$ , we only need to prove that  $\gamma_{(2,2,2)}(P_n) \geq 2\gamma_t(P_n)$ . We proceed by induction on  $n$ . It is easy to check that  $\gamma_{(2,2,2)}(P_n) = 2\gamma_t(P_n)$  for  $n = 3, 4, 5, 6$ . This establishes the base case. Now, we assume that  $n \geq 7$  and  $\gamma_{(2,2,2)}(P_k) \geq 2\gamma_t(P_k)$  for  $k < n$ . Let  $f(V_0, V_1, V_2)$  be a  $\gamma_{(2,2,2)}(P_n)$ -function which satisfies Lemma 3.18, and let  $f'$  be the restriction of  $f$  to  $V(P_{n-4})$ , where

$P_n = u_1 u_2 \dots u_n$  and  $P_{n-4} = u_1 u_2 \dots u_{n-4}$ . Hence, by applying the induction hypothesis,

$$\gamma_{(2,2,2)}(P_n) = \omega(f) = \omega(f') + 4 \geq \gamma_{(2,2,2)}(P_{n-4}) + 4 \geq 2\gamma_t(P_{n-4}) + 4 \geq 2\gamma_t(P_n).$$

To conclude the proof we apply Proposition 3.17.  $\square$

### 3.2 Preliminary results on $(2, 2, 1)$ -domination

**Theorem 3.20.** For any graph  $G$  with no isolated vertex, order  $n$  and maximum degree  $\Delta$ ,

$$\left\lceil \frac{2n + \gamma_t(G)}{\Delta + 1} \right\rceil \leq \gamma_{(2,2,1)}(G) \leq \min\{3\gamma(G), 2\gamma_t(G)\}.$$

Furthermore, if  $G$  has minimum degree  $\delta \geq 2$ , then

$$\gamma_{(2,2,1)}(G) \leq \gamma_{\times 2,t}(G).$$

*Proof.* In order to prove the upper bound  $\gamma_{(2,2,1)}(G) \leq 2\gamma_t(G)$ , we apply Remark 3.2 and Theorem 3.12, i.e.,  $\gamma_{(2,2,1)}(G) \leq \gamma_{(2,2,2)} \leq 2\gamma_t(G)$ .

Now, let  $S$  be a  $\gamma(G)$ -set. Since  $G$  does not have isolated vertex, for each vertex  $x \in S$  such that  $N(x) \cap S = \emptyset$ , we fix one vertex  $x' \in N(x)$  and we form a set  $S'$  from them. Hence,  $S \cup S'$  is a total dominating set and  $|S \cup S'| = |S| + |S'| \leq 2\gamma(G)$ . Notice that the function  $g(X_0, X_1, X_2)$  defined by  $X_2 = S$  and  $X_1 = S'$ , is a  $(2, 2, 1)$ -dominating function on  $G$ . Thus,  $\gamma_{(2,2,1)}(G) \leq \omega(g) = 2|S| + |S'| \leq 3\gamma(G)$ , and so  $\gamma_{(2,2,1)}(G) \leq \min\{2\gamma_t(G), 3\gamma(G)\}$ .

On the other side, if  $G$  has minimum degree  $\delta \geq 2$ , then by Corollary 3.11 (ii) we have that  $\gamma_{(2,2,1)}(G) \leq \gamma_{\times 2,t}(G)$ .

In order to prove the lower bound, let  $f(V_0, V_1, V_2)$  be a  $\gamma_{(2,2,1)}(G)$ -function. Since  $V_1 \cup V_2$  is a total dominating set,  $\gamma_t(G) \leq |V_1| + |V_2|$ . Furthermore, from Lemma 3.7 we have,  $2n - |V_2| \leq \Delta\gamma_{(2,2,1)}(G)$ , which implies that  $2n + \gamma_t(G) \leq 2n + |V_1| + |V_2| \leq \Delta\gamma_{(2,2,1)}(G) + |V_1| + 2|V_2| = (\Delta + 1)\gamma_{(2,2,1)}(G)$ . Therefore, the lower bound follows.  $\square$

The bounds above are tight. For instance, the graph shown in Figure 3 satisfies  $\gamma_{(2,2,1)}(G) = 3\gamma(G) = 9$ . Next we show that the remaining two bounds are also achieved.

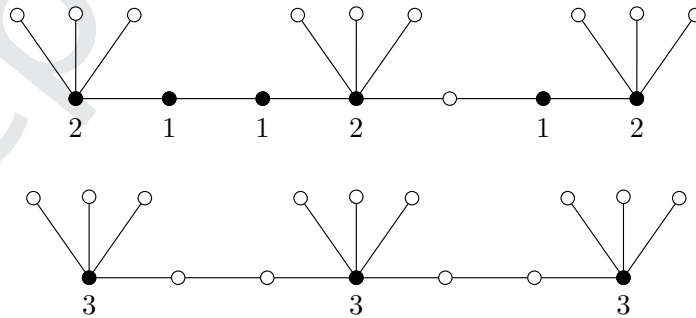

Figure 3: This figure shows a  $\gamma_{(2,2,1)}(G)$ -function and a  $\gamma_{(2,2,2,0)}(G)$ -function on the same graph.

**Corollary 3.21.** *Let  $G$  be a graph with no isolated vertex, order  $n$  and maximum degree  $\Delta$ . If  $\gamma_t(G) < \frac{n+\Delta+1}{\Delta+1/2}$ , then*

$$\gamma_{(2,2,1)}(G) = 2\gamma_t(G) \quad \text{or} \quad \gamma_{(2,2,1)}(G) = \left\lceil \frac{2n + \gamma_t(G)}{\Delta + 1} \right\rceil.$$

*Proof.* If  $\gamma_{(2,2,1)}(G) \neq \left\lceil \frac{2n+\gamma_t(G)}{\Delta+1} \right\rceil$  and  $\gamma_{(2,2,1)}(G) \neq 2\gamma_t(G)$ , then by Theorem 3.20 we deduce that  $\left\lceil \frac{2n+\gamma_t(G)}{\Delta+1} \right\rceil + 1 \leq \gamma_{(2,2,1)}(G) \leq 2\gamma_t(G) - 1$ , which implies that  $\gamma_t(G) \geq \frac{n+\Delta+1}{\Delta+1/2}$ . Therefore, the result follows.  $\square$

For the graphs  $G_2$  and  $G_3$  illustrated in Figure 1 we have that  $\gamma_t(G_2) = 2 < \frac{22}{9} = \frac{n+\Delta+1}{\Delta+1/2}$  and  $\gamma_t(G_3) = 4 < \frac{32}{7} = \frac{n+\Delta+1}{\Delta+1/2}$ . Notice that,  $\gamma_{(2,2,1)}(G_2) = 3 = \left\lceil \frac{2n+\gamma_t(G_2)}{\Delta+1} \right\rceil$  and  $\gamma_{(2,2,1)}(G_3) = 8 = 2\gamma_t(G_3)$ .

Below we characterize the graphs with  $\gamma_{(2,2,1)}(G) = 3$ .

**Theorem 3.22.** *For a graph  $G$  with no isolated vertex, the following statements are equivalent.*

- (i)  $\gamma_{(2,2,1)}(G) = 3$ .
- (ii)  $\gamma(G) = 1$  or  $\gamma_{\times 2,t}(G) = 3$ .

*Proof.* Assume first that  $\gamma_{(2,2,1)}(G) = 3$ , and let  $f(V_0, V_1, V_2)$  be a  $\gamma_{(2,2,1)}(G)$ -function. If  $V_2 \neq \emptyset$ , then  $V_2$  is a dominating set of cardinality one. Hence,  $\gamma(G) = 1$ . Now, if  $V_2 = \emptyset$ , then  $V_1$  is a double total dominating set of cardinality three. Thus,  $\gamma_{\times 2,t}(G) = 3$ .

On the other side, by Theorem 3.20 we have that  $3 \leq \left\lceil \frac{2n+\gamma_t(G)}{\Delta+1} \right\rceil \leq \gamma_{(2,2,1)}(G) \leq 3\gamma(G)$ . Hence, if  $\gamma(G) = 1$ , then  $\gamma_{(2,2,1)}(G) = 3$ . Now, if  $\gamma_{\times 2,t}(G) = 3$ , then  $G$  has minimum degree  $\delta \geq 2$  and by Theorem 3.20 we have that  $\gamma_{(2,2,1)}(G) \leq \gamma_{\times 2,t}(G) = 3$ . Therefore,  $\gamma_{(2,2,1)}(G) = 3$ .  $\square$

Next we consider the case of graphs with  $\gamma_{(2,2,1)}(G) = 4$ .

**Theorem 3.23.** *For a graph  $G$ , the following statements are equivalent.*

- (i)  $\gamma_{(2,2,1)}(G) = 4$ .
- (ii)  $\gamma_t(G) = \gamma(G) = 2$  or  $\gamma_{\times 2,t}(G) = 4$ .

*Proof.* Assume  $\gamma_{(2,2,1)}(G) = 4$ . Notice that  $G$  does not have isolated vertices and, by Theorem 3.20, we have that  $\gamma(G) \geq 2$ . Let  $f(V_0, V_1, V_2)$  be a  $\gamma_{(2,2,1)}(G)$ -function. If  $V_2 = \emptyset$ , then  $V_1$  is a double total dominating set of cardinality four. Hence,  $3 \leq \gamma_{\times 2,t}(G) \leq |V_1| = 4$ , and Theorem 3.22 implies that  $\gamma_{\times 2,t}(G) = 4$ .

From now on, assume that  $|V_2| \in \{1, 2\}$ . If  $|V_2| = 2$ , then  $V_1 = \emptyset$  and, as a result,  $V_2$  is a total dominating set of  $G$ , which implies that  $\gamma_t(G) = \gamma(G) = 2$ . Now, if  $|V_2| = 1$ , then  $|V_1| = 2$  and both vertices belonging to  $V_1$  are adjacent to the vertex of weight two, and every  $v \in V_0$  satisfies  $N(v) \cap V_2 \neq \emptyset$  or  $V_1 \subseteq N(v)$ . This implies that the union of  $V_2$  with a singleton subset of  $V_1$  forms a total dominating set of  $G$ , and again  $\gamma_t(G) = \gamma(G) = 2$ .

Conversely, if  $\gamma_{\times 2,t}(G) = 4$ , then  $G$  has minimum degree  $\delta \geq 2$  and by Theorem 3.20 we have that  $3 \leq \gamma_{(2,2,1)}(G) \leq \gamma_{\times 2,t}(G) = 4$ . Hence, by Theorem 3.22 we deduce that  $\gamma_{(2,2,1)}(G) = 4$ . Finally, if  $\gamma_t(G) = 2$ , then Theorem 3.20 leads to  $3 \leq \gamma_{(2,2,1)}(G) \leq 4$ . Therefore, if  $\gamma(G) = 2$  then by Theorem 3.22 we conclude that  $\gamma_{(2,2,1)}(G) = 4$ .  $\square$

**Lemma 3.24.** For any integer  $n \geq 3$ ,

$$\gamma_{(2,2,1)}(P_n) \leq \begin{cases} n - \lfloor \frac{n}{7} \rfloor + 1 & \text{if } n \equiv 1, 2 \pmod{7}, \\ n - \lfloor \frac{n}{7} \rfloor & \text{otherwise.} \end{cases}$$

*Proof.* First we show how to construct a  $(2, 2, 1)$ -dominating function  $f$  on  $P_n$  for  $n \in \{2, \dots, 8\}$ .

- $n = 2$ :  $f(u_1) = 2$  and  $f(u_2) = 1$ .
- $n = 3$ :  $f(u_1) = 0$ ,  $f(u_2) = 2$  and  $f(u_3) = 1$ .
- $n = 4$ :  $f(u_1) = f(u_4) = 0$  and  $f(u_2) = f(u_3) = 2$ .
- $n = 5$ :  $f(u_1) = f(u_5) = 0$ ,  $f(u_2) = f(u_4) = 2$  and  $f(u_3) = 1$ .
- $n = 6$ :  $f(u_1) = f(u_6) = 0$ ,  $f(u_2) = f(u_5) = 2$  and  $f(u_3) = f(u_4) = 1$ .
- $n = 7$ :  $f(u_1) = f(u_4) = f(u_7) = 0$ ,  $f(u_2) = f(u_6) = 2$  and  $f(u_3) = f(u_5) = 1$ .
- $n = 8$ :  $f(u_1) = f(u_4) = f(u_8) = 0$ ,  $f(u_2) = f(u_6) = f(u_7) = 2$ ,  $f(u_3) = f(u_5) = 1$ .

We now proceed to describe the construction of  $f$  for any  $n = 7q + r$ , where  $q \geq 1$  and  $0 \leq r \leq 6$ . We partition  $V(P_n) = \{u_1, \dots, u_n\}$  into  $q$  sets of cardinality 7 and for  $r \geq 1$  one additional set of cardinality  $r$ , in such a way that the subgraph induced by all these sets are paths.

For any  $r \neq 1$ , the restriction of  $f$  to each of these  $q$  paths of length 7 corresponds to the weights associated above with  $P_7$ , while for the path of length  $r$  (if any) we take the weights associated above with  $P_r$ . The case  $r = 1$  and  $q \geq 2$  is slightly different, as for the first  $q - 1$  paths of length 7 we take the weights associated above with  $P_7$  and for the last 8 vertices of  $P_n$  we take the weights associated above with  $P_8$ .

Notice that, for  $n \equiv 1, 2 \pmod{7}$ , we have that  $\gamma_{(2,2,1)}(P_n) \leq \omega(f) = 6q + r + 1 = n - \lfloor \frac{n}{7} \rfloor + 1$ , while for  $n \not\equiv 1, 2 \pmod{7}$  we have  $\gamma_{(2,2,1)}(P_n) \leq \omega(f) = 6q + r = n - \lfloor \frac{n}{7} \rfloor$ . Therefore, the result follows.  $\square$

**Lemma 3.25.** Let  $P_7 = x_1 \dots x_7$  be a subgraph of  $C_n$  and  $X = \{x_1, \dots, x_7\}$ . If  $f$  is a  $(2, 2, 1)$ -dominating function on  $C_n$ , then

$$f(X) \geq 6.$$

*Proof.* Notice that  $f(\{x_1, x_2, x_3\}) \geq 2$  and  $f(\{x_4, x_5, x_6, x_7\}) \geq 3$  as  $f$  is a  $(2, 2, 1)$ -dominating function. If  $f(\{x_1, x_2, x_3\}) \geq 3$ , then we are done. Hence, we assume that  $f(\{x_1, x_2, x_3\}) = 2$ . In this case, it is not difficult to deduce that  $f(\{x_4, x_5, x_6, x_7\}) \geq 4$ , which implies that  $f(X) \geq 6$ , as desired. Therefore, the proof is complete.  $\square$

**Lemma 3.26.** For any integer  $n \geq 3$ ,

$$\gamma_{(2,2,1)}(C_n) \geq \begin{cases} n - \lfloor \frac{n}{7} \rfloor + 1 & \text{if } n \equiv 1, 2 \pmod{7}, \\ n - \lfloor \frac{n}{7} \rfloor & \text{otherwise.} \end{cases}$$

*Proof.* It is easy to check that  $\gamma_{(2,2,1)}(C_n) = n$  for every  $n \in \{3, 4, 5, 6\}$ . Now, let  $n = 7q + r$ , with  $0 \leq r \leq 6$  and  $q \geq 1$ . Let  $f(V_0, V_1, V_2)$  be a  $\gamma_{(2,2,1)}(C_n)$ -function.

If  $r = 0$ , then by Lemma 3.25 we have that  $\omega(f) \geq 6q = n - \lfloor \frac{n}{7} \rfloor$ . From now on we assume that  $r \geq 1$ . By Proposition 3.5 and Lemma 3.24 we deduce that  $\gamma_{(2,2,1)}(C_n) \leq \gamma_{(2,2,1)}(P_n) < n$ , which implies that  $V_2 \neq \emptyset$ , otherwise there exists  $u \in V(C_n) = V_0 \cup V_1$  such that  $N(u) \cap V_0 \neq \emptyset$  and so  $|N(u) \cap V_1| \leq 1$ , which is a contradiction. Let  $x \in V_2$  and, without loss of generality, we can label the vertices of  $C_n$  in such a way that  $x = u_1$ , and  $u_2 \in V_1 \cup V_2$  whenever  $r \geq 2$ . We partition  $V(C_n)$  into  $X = \{u_1, \dots, u_r\}$  and  $Y = \{u_{r+1}, \dots, u_n\}$ . Notice that Lemma 3.25 leads to  $f(Y) \geq 6q$ .

Now, if  $r \in \{1, 2\}$ , then  $f(X) \geq r + 1$ , which implies that  $\omega(f) \geq r + 1 + 6q = n - \lfloor \frac{n}{7} \rfloor + 1$ . Analogously, if  $r = 3$ , then  $f(X) \geq r$  and so  $\omega(f) \geq r + 6q = n - \lfloor \frac{n}{7} \rfloor$ .

Finally, if  $r \in \{4, 5, 6\}$ , then as  $f$  is a  $(2, 2, 1)$ -dominating function we deduce that  $f(X) \geq r$ , which implies that  $\omega(f) \geq r + 6q = n - \lfloor \frac{n}{7} \rfloor$ .  $\square$

The following result is a direct consequence of Proposition 3.5 and Lemmas 3.24 and 3.26.

**Proposition 3.27.** *For any integer  $n \geq 3$ ,*

$$\gamma_{(2,2,1)}(C_n) = \gamma_{(2,2,1)}(P_n) = \begin{cases} n - \lfloor \frac{n}{7} \rfloor + 1 & \text{if } n \equiv 1, 2 \pmod{7}, \\ n - \lfloor \frac{n}{7} \rfloor & \text{otherwise.} \end{cases}$$

### 3.3 Preliminary results on $(2, 2, 0)$ -domination

**Theorem 3.28.** *For any graph  $G$  with no isolated vertex, order  $n$  and maximum degree  $\Delta$ ,*

$$\left\lceil \frac{2n}{\Delta + 1} \right\rceil \leq \gamma_{(2,2,0)}(G) \leq 2\gamma(G).$$

Furthermore, if  $G$  has minimum degree  $\delta \geq 2$ , then

$$\gamma_{(2,2,0)}(G) \leq \gamma_{\times 2,t}(G).$$

*Proof.* The upper bound  $\gamma_{(2,2,0)}(G) \leq \omega(g) = 2\gamma(G)$  is derived by we applying Theorem 3.10 (ii) for  $i = 1$  and  $l = 2$ . Furthermore, if  $G$  has minimum degree  $\delta \geq 2$ , then by Corollary 3.11 (ii) we have that  $\gamma_{(2,2,0)}(G) \leq \gamma_{\times 2,t}(G)$ .

Now, let  $f(V_0, V_1, V_2)$  be a  $\gamma_{(2,2,0)}(G)$ -function. From Lemma 3.7 we deduce that  $2(n - |V_2|) \leq \Delta \gamma_{(2,2,0)}(G)$ , which implies that  $2n \leq 2n + |V_1| \leq (\Delta + 1)\gamma_{(2,2,0)}(G)$ . Therefore, the result follows.  $\square$

Theorem 3.28 implies that, if  $\gamma(G) = \frac{n}{\Delta+1}$ , then  $\gamma_{(2,2,0)}(G) = \frac{2n}{\Delta+1}$ . It is easy to see that a graph satisfies  $\gamma(G) = \frac{n}{\Delta+1}$  if and only if there exists a  $\gamma(G)$ -set  $S$  which is a 2-packing<sup>1</sup> and every vertex in  $S$  has degree  $\Delta$ . The upper bound  $\gamma_{(2,2,0)}(G) \leq 2\gamma(G)$  is achieved for the graph  $G$  shown in Figure 2, which satisfies  $\gamma_{(2,2,0)}(G) = 2\gamma(G) = 6$ . Furthermore, by Theorem 3.4 we have that for any corona graph  $G \cong G_1 \odot G_2$ , where  $G_1$  does not have isolated vertices,  $\gamma_{(2,2,0)}(G) = 2\gamma(G)$ .

As shown in Theorem 3.9, for a graph  $G$ ,  $\gamma_{(2,2,0)}(G) = 2$  if and only if  $\gamma(G) = 1$ . Now we consider the case  $\gamma_{(2,2,0)}(G) = 3$ .

<sup>1</sup>A set  $S \subseteq V(G)$  is a 2-packing if  $N[u] \cap N[v] = \emptyset$  for every pair of different vertices  $u, v \in S$ .

**Theorem 3.29.** For a graph  $G$ ,  $\gamma_{(2,2,0)}(G) = 3$  if and only if  $\gamma_{\times 2,t}(G) = \gamma(G) + 1 = 3$ .

*Proof.* Assume  $\gamma_{(2,2,0)}(G) = 3$ . By Theorem 3.9 we have that  $\gamma(G) \geq 2$ . Let  $f(V_0, V_1, V_2)$  be a  $\gamma_{(2,2,0)}(G)$ -function. If  $|V_2| = 1$  then  $|V_1| = 1$ , and as  $f$  is a  $(2, 2, 0)$ -dominating function we deduce that  $N[V_2] = V(G)$ , i.e.,  $\gamma(G) = 1$ , which is a contradiction. Thus,  $V_2 = \emptyset$  and  $|V_1| = 3$ . Notice that  $V_1$  is a double total dominating set and since  $\gamma(G) \geq 2$ , it follows that  $3 \leq \gamma(G) + 1 \leq \gamma_{\times 2,t}(G) \leq |V_1| = 3$ . Hence,  $\gamma_{\times 2,t}(G) = \gamma(G) + 1 = 3$ , as required.

Conversely, assume  $\gamma_{\times 2,t}(G) = \gamma(G) + 1 = 3$ . Since  $G$  has minimum degree at least two, Theorem 3.28 leads to  $2 \leq \gamma_{(2,2,0)}(G) \leq \gamma_{\times 2,t}(G) = 3$ , and so Theorem 3.9 implies that  $\gamma_{(2,2,0)}(G) = 3$ , which completes the proof.  $\square$

**Theorem 3.30.** For a graph  $G$ ,  $\gamma_{(2,2,0)}(G) = 4$  if and only if one of the following conditions holds.

- (i)  $G \cong K_1 \cup G_1$ , where  $G_1$  is a graph with  $\gamma(G_1) = 1$ .
- (ii)  $\gamma_{\times 2,t}(G) = 4$ .
- (iii)  $\gamma(G) = 2$  and  $G$  has minimum degree one.
- (iv)  $\gamma(G) = 2$  and  $\gamma_{\times 2,t}(G) \geq 4$ .

*Proof.* If  $K_1$  is a component of  $G$ , then by Theorem 3.9 we conclude that  $\gamma_{(2,2,0)}(G) = 4$  if and only if  $G \cong K_1 \cup G_1$ , where  $G_1$  is a graph with  $\gamma(G_1) = 1$ .

From now on, we consider the case where  $G$  is a graph with no isolated vertex. Assume  $\gamma_{(2,2,0)}(G) = 4$  and let  $f(V_0, V_1, V_2)$  be a  $\gamma_{(2,2,0)}(G)$ -function. If  $V_2 = \emptyset$ , then  $V_1$  is a double total dominating set of  $G$ . In this case,  $G$  has minimum degree  $\delta \geq 2$  and by Theorem 3.28 we have that  $\gamma_{\times 2,t}(G) \leq |V_1| = 4 = \gamma_{(2,2,0)}(G) \leq \gamma_{\times 2,t}(G)$ . Hence (ii) follows.

Now, assume that  $|V_2| \in \{1, 2\}$ . If  $|V_2| = 2$ , then  $V_1 = \emptyset$ , and so  $\gamma(G) \leq 2$ . Now, if  $|V_2| = 1$ , then  $|V_1| = 2$  and both vertices belonging  $V_1$  are adjacent to the vertex of weight two, and every  $v \in V_0$  satisfies  $N(v) \cap V_2 \neq \emptyset$  or  $V_1 \subseteq N(v)$ . This implies that the union of  $V_2$  with a singleton subset of  $V_1$  forms a dominating set of  $G$ , and again  $\gamma(G) \leq 2$ . Thus, from Theorem 3.9 we deduce that  $\gamma(G) = 2$ . Furthermore, if  $\delta \geq 2$ , then by Theorem 3.28 we have that  $\gamma_{\times 2,t}(G) \geq \gamma_{(2,2,0)}(G) = 4$ . Therefore, either (iii) or (iv) holds.

Conversely, if  $\gamma_{\times 2,t}(G) = 4$ , then Theorem 3.28 leads to  $2 \leq \gamma_{(2,2,0)}(G) \leq \gamma_{\times 2,t}(G) = 4$ . Hence, by Theorems 3.9 and 3.29 we deduce that  $\gamma_{(2,2,0)}(G) = 4$ . Analogously, if  $\gamma(G) = 2$  and  $\delta \geq 1$ , then Theorem 3.28 leads to  $2 \leq \gamma_{(2,2,0)}(G) \leq 2\gamma(G) = 4$ . Thus, by Theorem 3.9 we have that  $3 \leq \gamma_{(2,2,0)}(G) \leq 4$ . In particular, if  $\delta = 1$  or  $\gamma_{\times 2,t}(G) \geq 4$ , then Theorem 3.29 leads to  $\gamma_{(2,2,0)}(G) = 4$ , which completes the proof.  $\square$

**Lemma 3.31.** For a graph  $G$ , the following statements are equivalent.

- (i)  $\gamma_{(2,2,0)}(G) = 2\gamma(G)$ .
- (ii) There exists a  $\gamma_{(2,2,0)}(G)$ -function  $f(V_0, V_1, V_2)$  such that  $V_1 = \emptyset$ .

*Proof.* First, we assume that  $\gamma_{(2,2,0)}(G) = 2\gamma(G)$  and let  $D$  be a  $\gamma(G)$ -set. Hence, the function  $f(V_0, V_1, V_2)$ , defined by  $V_2 = D$  and  $V_0 = V(G) \setminus D$ , is a  $\gamma_{(2,2,0)}(G)$ -function which satisfies (ii), as desired.

Finally, we assume that there exists a  $\gamma_{(2,2,0)}(G)$ -function  $f(V_0, V_1, V_2)$  such that  $V_1 = \emptyset$ . This implies that  $V_2$  is a dominating set of  $G$ . Hence,  $\gamma_{(2,2,0)}(G) \leq 2|V_2| = 2\gamma(G)$ , and the desired equality holds, which completes the proof.  $\square$



The following result provides the  $(2, 2, 0)$ -domination number of paths and cycles.

**Proposition 3.32.** *For any integer  $n \geq 3$ ,*

$$\gamma_{(2,2,0)}(P_n) = \gamma_{(2,2,0)}(C_n) = 2 \left\lceil \frac{n}{3} \right\rceil.$$

*Proof.* We first prove that  $\gamma_{(2,2,0)}(C_n) \geq 2 \left\lceil \frac{n}{3} \right\rceil$ . Let  $f(V_0, V_1, V_2)$  be a  $\gamma_{(2,2,0)}(C_n)$ -function. If  $V_1 = \emptyset$ , then by Lemma 3.31 it follows that  $\gamma_{(2,2,0)}(C_n) = 2\gamma(C_n) = 2 \left\lceil \frac{n}{3} \right\rceil$ . If  $V_1 \neq \emptyset$ , then  $1 + 2|V_2| \leq |V_1| + 2|V_2| = \gamma_{(2,2,0)}(C_n) \leq 2\gamma(C_n) = 2 \left\lceil \frac{n}{3} \right\rceil$ , which leads to  $|V_2| \leq \left\lceil \frac{n}{3} \right\rceil - 1$ . By Lemma 3.7 we have that  $\gamma_{(2,2,0)}(C_n) \geq n - |V_2| \geq n - \left\lceil \frac{n}{3} \right\rceil + 1 \geq 2 \left\lceil \frac{n}{3} \right\rceil$ , as desired.

Therefore, by the inequality above, Proposition 3.5 and Theorem 3.28 we deduce that  $2 \left\lceil \frac{n}{3} \right\rceil \leq \gamma_{(2,2,0)}(C_n) \leq \gamma_{(2,2,0)}(P_n) \leq 2\gamma(P_n) = 2 \left\lceil \frac{n}{3} \right\rceil$ . Thus, we have equalities in the inequality chain above, which implies that the result follows.  $\square$

### 3.4 Preliminary results on $(2, 1, 0)$ -domination

Given a graph  $G$ , we use the notation  $L(G)$  and  $S(G)$  for the sets of leaves and support vertices, respectively.

**Theorem 3.33.** *For any graph  $G$  with no isolated vertex, order  $n$  and maximum degree  $\Delta$ ,*

$$\left\lceil \frac{2n}{\Delta + 1} \right\rceil \leq \gamma_{(2,1,0)}(G) \leq \min\{\gamma_{\times 2}(G) - |L(G)| + |S(G)|, 2\gamma(G)\}.$$

*Proof.* If  $f(V_0, V_1, V_2)$  is a  $\gamma_{(2,1,0)}(G)$ -function, then from Lemma 3.7 we conclude that  $2n - |V_1| - 2|V_2| \leq \Delta\gamma_{(2,1,0)}(G)$ . Hence,  $2n \leq \Delta\gamma_{(2,1,0)}(G) + \omega(f) = (\Delta + 1)\gamma_{(2,1,0)}(G)$ . Therefore, the lower bound follows.

Let  $D$  be a  $\gamma_{\times 2}(G)$ -set. Notice that  $S(G) \cup L(G) \subseteq D$ . Since  $|N[v] \cap D| \geq 2$  for every  $v \in V(G)$ , the function  $g(V_0, V_1, V_2)$  defined by  $V_1 = D \setminus (L(G) \cup S(G))$  and  $V_2 = S(G)$ , is a  $(2, 1, 0)$ -dominating function. Hence,  $\gamma_{(2,1,0)}(G) \leq \omega(g) = \gamma_{\times 2}(G) - |L(G)| + |S(G)|$ .

By Remark 3.2,  $\gamma_{(2,1,0)}(G) \leq \gamma_{(2,2,0)}(G)$ , hence the upper bound  $\gamma_{(2,1,0)}(G) \leq 2\gamma(G)$  is derived from Theorem 3.28. Therefore,  $\gamma_{(2,1,0)}(G) \leq \min\{\gamma_{\times 2}(G) - |L(G)| + |S(G)|, 2\gamma(G)\}$ .  $\square$

The bounds above are tight. For instance, for the graph  $G_1$  shown in Figure 1 we have that  $\gamma_{(2,1,0)}(G_1) = \left\lceil \frac{2n}{\Delta + 1} \right\rceil = \gamma_{\times 2}(G_1) = 2\gamma(G_1) = 4$ . As an example of graph of minimum degree one where  $\gamma_{(2,1,0)}(G) = \gamma_{\times 2}(G) - |L(G)| + |S(G)|$  we take the graph  $G$  obtained from a star graph  $K_{1,r}$ ,  $r \geq 3$ , by subdividing one edge just once. In such a case,  $\gamma_{(2,1,0)}(G) = 4 = \gamma_{\times 2}(G) - |L(G)| + |S(G)|$ . Another example is the graph shown in Figure 2 which satisfies  $\gamma_{(2,1,0)}(G) = \gamma_{\times 2}(G) - |L(G)| + |S(G)| = 6$ .

Notice that  $\gamma_{(2,1,0)}(G) \geq \left\lceil \frac{2n}{\Delta + 1} \right\rceil \geq 2$ . As shown in Theorem 3.9,  $\gamma_{(2,1,0)}(G) = 2$  if and only if  $\gamma(G) = 1$ . Next we characterize the graph satisfying  $\gamma_{(2,1,0)}(G) = 3$ .

**Theorem 3.34.** *For a graph  $G$ ,  $\gamma_{(2,1,0)}(G) = 3$  if and only if  $\gamma_{\times 2}(G) = \gamma(G) + 1 = 3$ .*

*Proof.* Assume  $\gamma_{(2,1,0)}(G) = 3$ . By Theorem 3.9 we have that  $\gamma(G) \geq 2$ . Let  $f(V_0, V_1, V_2)$  be a  $\gamma_{(2,1,0)}(G)$ -function. If  $|V_2| = 1$  then  $N[V_2] = V(G)$ , i.e.,  $\gamma(G) = 1$ , which is a contradiction. Thus,  $V_2 = \emptyset$  and  $|V_1| = 3$ , which implies that  $V_1$  is a double dominating set. Hence,  $3 \leq \gamma(G) + 1 \leq \gamma_{\times 2}(G) \leq |V_1| = 3$ . Therefore,  $\gamma_{\times 2}(G) = \gamma(G) + 1 = 3$ .

Conversely, assume  $\gamma_{\times 2}(G) = \gamma(G) + 1 = 3$ . Notice that  $G$  has minimum degree  $\delta \geq 1$  and so by Theorems 3.9 and 3.33 we have that  $3 \leq \gamma_{(2,1,0)}(G) \leq \gamma_{\times 2}(G) = 3$ , which implies that  $\gamma_{(2,1,0)}(G) = 3$ .  $\square$

Next we consider the case of graphs with  $\gamma_{(2,1,0)}(G) = 4$ .

**Theorem 3.35.** *For a graph  $G$ ,  $\gamma_{(2,1,0)}(G) = 4$  if and only if one of the following conditions is satisfied.*

- (i)  $G \cong K_1 \cup G_1$ , where  $G_1$  is a graph with  $\gamma(G_1) = 1$ .
- (ii)  $\gamma_{\times 2}(G) = 4$ .
- (iii)  $\gamma(G) = 2$  and  $\gamma_{\times 2}(G) \geq 4$ .

*Proof.* If  $K_1$  is a component of  $G$ , then by Theorem 3.9 we conclude that  $\gamma_{(2,1,0)}(G) = 4$  if and only if  $G \cong K_1 \cup G_1$ , where  $G_1$  is a graph with  $\gamma(G_1) = 1$ .

From now on, we consider the case where  $G$  is a graph with no isolated vertex. Assume  $\gamma_{(2,1,0)}(G) = 4$ . By Theorem 3.33 we deduce that  $\gamma_{\times 2}(G) \geq 4$  and  $\gamma(G) \geq 2$ . Let  $f(V_0, V_1, V_2)$  be a  $\gamma_{(2,1,0)}(G)$ -function. If  $V_2 = \emptyset$ , then  $V_1$  is a double dominating set of  $G$ , which implies that  $\gamma_{\times 2}(G) \leq |V_1| = 4$ . Hence, (ii) follows. From now on, assume  $|V_2| \in \{1, 2\}$ . If  $|V_2| = 2$ , then  $V_1 = \emptyset$  and so,  $V_2$  is a dominating set of  $G$ , which implies that  $\gamma(G) = 2$ . If  $|V_2| = 1$ , then for every  $v \in V_1$  we have that  $V_2 \cup \{v\}$  is a dominating set of  $G$ . Hence,  $\gamma(G) = 2$ . Therefore, (iii) follows.

Conversely, if (ii) or (iii) holds, then by Theorems 3.33 we have that  $2 \leq \gamma_{(2,1,0)}(G) \leq 4$ . Therefore, by Theorems 3.9 and 3.34 we deduce that  $\gamma_{(2,1,0)}(G) = 4$ , which completes the proof.  $\square$

The formulas on the  $\{k\}$ -dominating number of cycles and paths were obtained in [17]. We present here the particular case of  $k = 2$ , as  $\gamma_{\{2\}}(G) = \gamma_{(2,1,0)}(G)$ .

**Proposition 3.36.** [17] *For any integer  $n \geq 3$ ,*

$$\gamma_{\{2\}}(C_n) = \left\lceil \frac{2n}{3} \right\rceil \quad \text{and} \quad \gamma_{\{2\}}(P_n) = 2 \left\lceil \frac{n}{3} \right\rceil.$$

### 3.5 Preliminary results on $(2, 2, 2, 0)$ -domination

The following result is a direct consequence of Theorem 3.10 (i), (ii) and (vi).

**Corollary 3.37.** *For any graph  $G$  with no isolated vertex,*

$$\gamma_{(2,2,1)}(G) \leq \gamma_{(2,2,2,0)}(G) \leq \min\{3\gamma(G), \gamma_{(2,2,2)}(G)\}.$$

The bounds above are tight. For instance, every graph  $G_{k,r}$  belonging to the infinite family  $\mathcal{H}_k$  constructed after Remark 3.3 satisfies the equalities  $\gamma_{(2,2,1)}(G_{k,r}) = \gamma_{(2,2,2)}(G_{k,r}) = \gamma_{(2,2,2,0)}(G_{k,r}) = k$ . In contrast, the graph shown in Figure 2 satisfies  $\gamma_{(2,2,1)}(G) = 6 < 7 = \gamma_{(2,2,2,0)}(G) < 8 = \gamma_{(2,2,2)}(G)$ . Moreover, Figure 3 illustrates a graph  $G$  with  $\gamma_{(2,2,1)}(G) = \gamma_{(2,2,2,0)}(G) = 3\gamma(G) = 9$ .

In order to characterize the graphs with  $\gamma_{(2,2,2,0)}(G) \in \{3, 4\}$ , we need to establish the following lemma.

**Lemma 3.38.** *For a graph  $G$ , the following statements are equivalent.*

- (i)  $\gamma_{(2,2,2,0)}(G) = \gamma_{(2,2,2)}(G)$ .
- (ii) *There exists a  $\gamma_{(2,2,2,0)}(G)$ -function  $f(V_0, V_1, V_2, V_3)$  such that  $V_3 = \emptyset$ .*

*Proof.* If  $\gamma_{(2,2,2,0)}(G) = \gamma_{(2,2,2)}(G)$ , then for any  $\gamma_{(2,2,2)}(G)$ -function  $f(V_0, V_1, V_2)$ , there exists a  $\gamma_{(2,2,2,0)}(G)$ -function  $g(W_0, W_1, W_2, W_3)$  defined by  $W_0 = V_0, W_1 = V_1, W_2 = V_2$  and  $W_3 = \emptyset$ . Therefore, (i) implies (ii).

Conversely, if there exists a  $\gamma_{(2,2,2,0)}(G)$ -function  $f(V_0, V_1, V_2, V_3)$  such that  $V_3 = \emptyset$ , then the function  $g(W_0, W_1, W_2)$ , defined by  $W_0 = V_0, W_1 = V_1$  and  $W_2 = V_2$ , is a  $(2, 2, 2)$ -dominating function on  $G$ , and so  $\gamma_{(2,2,2)}(G) \leq \omega(g) = \omega(f) = \gamma_{(2,2,2,0)}(G)$ . Therefore, Corollary 3.37 leads to  $\gamma_{(2,2,2,0)}(G) = \gamma_{(2,2,2)}(G)$ , which completes the proof.  $\square$

**Theorem 3.39.** *For a graph  $G$ , the following statements are equivalent.*

- (i)  $\gamma_{(2,2,2,0)}(G) = 3$ .
- (ii)  $\gamma(G) = 1$  or  $\gamma_{\times 2,t}(G) = 3$ .

*Proof.* Assume first that  $\gamma_{(2,2,2,0)}(G) = 3$ , and let  $f(V_0, V_1, V_2, V_3)$  be a  $\gamma_{(2,2,2,0)}(G)$ -function. Notice that  $|V_3| \in \{0, 1\}$ . If  $|V_3| = 1$ , then  $V_1 \cup V_2 = \emptyset$ , which implies that  $V_3$  is a dominating set of cardinality one. Hence,  $\gamma(G) = 1$ .

If  $V_3 = \emptyset$ , then by Lemma 3.38 we have that  $\gamma_{(2,2,2)}(G) = \gamma_{(2,2,2,0)}(G) = 3$ , and by Theorem 3.14 we deduce that  $\gamma_{\times 2,t}(G) = 3$ .

Conversely, if  $\gamma(G) = 1$ , then Corollary 3.37 leads to  $3 \leq \gamma_{(2,2,2,0)}(G) \leq 3\gamma(G) = 3$ . Moreover, if  $\gamma_{\times 2,t}(G) = 3$ , then  $G$  has minimum degree  $\delta \geq 2$  and so Theorem 3.10 (i) leads to  $3 \leq \gamma_{(2,2,2,0)}(G) \leq \gamma_{(2,2,2)}(G) \leq \gamma_{\times 2,t}(G) = 3$ . Therefore,  $\gamma_{(2,2,2,0)}(G) = 3$ .  $\square$

**Theorem 3.40.** *For a graph  $G$ ,  $\gamma_{(2,2,2,0)}(G) = 4$  if and only if at least one of the following conditions holds.*

- (i)  $\gamma_{\times 2,t}(G) = 4$ .
- (ii)  $\gamma(G) = \gamma_t(G) = 2$  and  $G$  has minimum degree  $\delta = 1$ .
- (iii)  $\gamma(G) = \gamma_t(G) = 2$  and  $\gamma_{\times 2,t}(G) \geq 4$ .

*Proof.* Assume  $\gamma_{(2,2,2,0)}(G) = 4$ . Let  $f(V_0, V_1, V_2, V_3)$  be a  $\gamma_{(2,2,2,0)}(G)$ -function. Hence,  $|V_3| \in \{0, 1\}$ . If  $|V_3| = 1$ , then  $V_3$  is a dominating set of cardinality one. Hence,  $\gamma(G) = 1$ , which is a contradiction with Theorem 3.39. Hence,  $V_3 = \emptyset$ , and so, Lemma 3.38 leads to  $\gamma_{(2,2,2)}(G) = \gamma_{(2,2,2,0)}(G) = 4$ . Thus, by Theorems 3.15 and 3.39 we deduce (i)-(iii).

Conversely, if conditions (i)-(iii) hold, then by Theorem 3.14 we have that  $\gamma_{(2,2,2)}(G) = 4$ . Corollary 3.37 leads to  $3 \leq \gamma_{(2,2,2,0)}(G) \leq \gamma_{(2,2,2)}(G) = 4$ . Notice that if  $\delta \geq 2$ , then  $\gamma(G) \geq 2$  and  $\gamma_{\times 2,t}(G) \geq 4$ . Hence, Theorem 3.39 leads to  $\gamma_{(2,2,2,0)}(G) = 4$ .  $\square$

**Proposition 3.41.** *For any integer  $n \geq 3$ ,*

$$\gamma_{(2,2,2,0)}(C_n) = n.$$

*Proof.* By Corollaries 3.16 and 3.37 we have that  $\gamma_{(2,2,2,0)}(C_n) \leq \gamma_{(2,2,2)}(C_n) = n$ . We only need to prove that  $\gamma_{(2,2,2,0)}(C_n) \geq n$ . Let  $f(V_0, V_1, V_2, V_3)$  be a  $\gamma_{(2,2,2,0)}(G)$ -function such that  $|V_3|$  is minimum. If  $V_3 = \emptyset$ , then by Lemma 3.38 and Corollary 3.16 we conclude that  $\gamma_{(2,2,2,0)}(C_n) = n$ . Assume  $V_3 \neq \emptyset$ . If  $v \in V_3$ , then  $N(v) \subseteq V_0$  as otherwise, by choosing one vertex  $u \in N(v) \setminus V_0$ , the function  $f'$  defined by  $f'(v) = 2$ ,  $f'(u) = \min\{2, f(u) + 1\}$  and  $f'(x) = f(x)$  for the remaining vertices, is a  $(2, 2, 2, 0)$ -dominating function with  $\omega(f') \leq \omega(f)$  and  $|V'_3| < |V_3|$ , which is a contradiction. Hence,  $\sum_{x \in V_3} f(N[x]) = 3|V_3|$ . Now, we observe that

$$2 \sum_{x \in V(C_n) \setminus N[V_3]} f(x) \geq \sum_{x \in V(C_n) \setminus N[V_3]} \left( \sum_{u \in N(x)} f(u) \right) \geq 2(n - 3|V_3|).$$

Therefore,

$$\gamma_{(2,2,2,0)}(C_n) = \omega(f) = \sum_{x \in V_3} f(N[x]) + \sum_{x \in V(C_n) \setminus N[V_3]} f(x) \geq 3|V_3| + (n - 3|V_3|) = n,$$

and the result follows.  $\square$

**Proposition 3.42.** For any integer  $n \geq 3$ ,

$$\gamma_{(2,2,2,0)}(P_n) = \begin{cases} 6 & \text{if } n = 5, \\ n & \text{otherwise.} \end{cases}$$

*Proof.* It is easy to check that  $\gamma_{(2,2,2,0)}(P_n) = n$  for  $n = 3, 4, 6, 7, 8$ , and also  $\gamma_{(2,2,2,0)}(P_5) = 6$ . From now on, assume  $n \geq 9$ . By Propositions 3.5 and 3.41 we have that  $n = \gamma_{(2,2,2,0)}(C_n) \leq \gamma_{(2,2,2,0)}(P_n)$ . Hence, we only need to prove that  $\gamma_{(2,2,2,0)}(P_n) \leq n$ . To this end, we proceed to construct a  $(2, 2, 2, 0)$ -dominating function  $f(V_0, V_1, V_2, V_3)$  on  $P_n = v_1 v_2 \dots v_n$  such that  $\omega(f) = n$ .

- If  $n \equiv 0 \pmod{3}$ , then we set  $V_3 = \bigcup_{i=1}^{n/3} \{v_{3i-1}\}$  and  $V_0 = V(G) \setminus V_3$ .
- If  $n \equiv 1 \pmod{3}$ , then we set  $V_3 = \bigcup_{i=1}^{(n-4)/3} \{v_{3i-1}\}$ ,  $V_2 = \{v_{n-2}, v_{n-1}\}$  and  $V_0 = V(G) \setminus (V_2 \cup V_3)$ .
- If  $n \equiv 2 \pmod{3}$ , then we set  $V_3 = \bigcup_{i=1}^{(n-8)/3} \{v_{3i-1}\}$ ,  $V_2 = \{v_{n-6}, v_{n-5}, v_{n-2}, v_{n-1}\}$  and  $V_1 = \emptyset$ .

Notice that in the three cases above,  $f$  is a  $(2, 2, 2, 0)$ -dominating function of weight  $\omega(f) = n$ , as required. Therefore, the proof is complete.  $\square$

## References

- [1] H. Abdollahzadeh Ahangar, M. Chellali, S. M. Sheikholeslami and J. C. Valenzuela-Tripodoro, Total Roman  $\{2\}$ -dominating functions in graphs, *Discuss. Math. Graph Theory. In press* (2020), <https://doi.org/10.7151/dmgt.2316>.

- [2] D. W. Bange, A. E. Barkauskas, L. H. Host and P. J. Slater, Generalized domination and efficient domination in graphs, *Discrete Math.* **159** (1996), 1–11.
- [3] B. Brešar, M. A. Henning and S. Klavžar, On integer domination in graphs and vizing-like problems, *Taiwanese J. Math.* **10** (5) (2006), 1317–1328.
- [4] S. Cabrera García, A. Cabrera Martínez, F. A. Hernández Mira and I. G. Yero, Total Roman  $\{2\}$ -domination in graphs, *Quaest. Math.* *In press* (2019), <https://doi.org/10.2989/16073606.2019.1695230>.
- [5] A. Cabrera Martínez, S. Cabrera García and J. A. Rodríguez-Velázquez, Double domination in lexicographic product graphs, *Discrete Appl. Math.* **284** (2020), 290–300.
- [6] M. Chellali, T. W. Haynes, S. T. Hedetniemi and A. A. McRae, Roman  $\{2\}$ -domination, *Discrete Appl. Math.* **204** (2016), 22–28.
- [7] G. S. Domke, S. T. Hedetniemi, R. C. Laskar and G. H. Fricke, Relationships between integer and fractional parameters of graphs, in: Y. Alavi, G. Chartrand, O. R. Oellermann and A. J. Schwenk (eds.), *Graph theory, combinatorics, and applications: proceedings of the Sixth Quadrennial International Conference on the Theory and Applications of Graphs, Western Michigan University*, John Wiley & Sons Inc., volume 2, 1991 pp. 371–387.
- [8] J. F. Fink and M. S. Jacobson,  $n$ -domination in graphs, in: *Graph theory with applications to algorithms and computer science*, Wiley, New York, Wiley-Intersci. Publ., pp. 283–300, 1985.
- [9] F. Harary and T. W. Haynes, Double domination in graphs, *Ars Combin.* **55** (2000), 201–213.
- [10] T. Haynes, S. Hedetniemi and P. Slater, *Domination in Graphs: Volume 2: Advanced Topics*, Chapman & Hall/CRC Pure and Applied Mathematics, Taylor & Francis, 1998.
- [11] T. W. Haynes, S. T. Hedetniemi and P. J. Slater, *Fundamentals of Domination in Graphs*, Chapman and Hall/CRC Pure and Applied Mathematics Series, Marcel Dekker, Inc. New York, 1998.
- [12] M. A. Henning and A. P. Kazemi,  $k$ -tuple total domination in graphs, *Discrete Appl. Math.* **158** (2010), 1006–1011, doi:<http://dx.doi.org/10.1016/j.dam.2010.01.009>.
- [13] M. A. Henning and W. F. Klostermeyer, Italian domination in trees, *Discrete Appl. Math.* **217** (2017), 557 – 564,
- [14] M. A. Henning and A. Yeo, *Total Domination in Graphs*, Springer Monographs in Mathematics, Springer New York, 2013.
- [15] X. Hou and Y. Lu, On the  $\{k\}$ -domination number of cartesian products of graphs, *Discrete Math.* **309** (10) (2009), 3413–3419.
- [16] W. F. Klostermeyer and G. MacGillivray, Roman, Italian, and 2-domination, *J. Combin. Math. Combin. Comput.* **108** (2019), 125–146.
- [17] C.-M. Lee and M.-S. Chang, Variations of  $Y$ -dominating functions on graphs, *Discrete Math.* **308** (2008), 4185–4204.

## Chapter 2

# Total domination in rooted product graphs

This chapter includes a complete copy of the following paper.

A. Cabrera Martínez, J.A. Rodríguez-Velázquez. Total domination in rooted product graphs, *Symmetry* (2020) 12(11), 1929.

URL: <https://doi.org/10.3390/sym12111929>

Quality indicators:

2019 JCR Impact factor: 2.645, Q2 (29/71), Multidisciplinary, Sciences.



Article

# Total Domination in Rooted Product Graphs

Abel Cabrera Martínez and Juan A. Rodríguez-Velázquez \*

Departament d'Enginyeria Informàtica i Matemàtiques, Universitat Rovira i Virgili, Av. Països Catalans 26, 43007 Tarragona, Spain; abel.cabrera@urv.cat

\* Correspondence: juanalberto.rodriguez@urv.cat

Received: 2 October 2020; Accepted: 20 November 2020; Published: 23 November 2020



**Abstract:** During the last few decades, domination theory has been one of the most active areas of research within graph theory. Currently, there are more than 4400 published papers on domination and related parameters. In the case of total domination, there are over 580 published papers, and 50 of them concern the case of product graphs. However, none of these papers discusses the case of rooted product graphs. Precisely, the present paper covers this gap in the theory. Our goal is to provide closed formulas for the total domination number of rooted product graphs. In particular, we show that there are four possible expressions for the total domination number of a rooted product graph, and we characterize the graphs reaching these expressions.

**Keywords:** total domination; domination; rooted product graph

Let  $G$  be a graph. The open neighborhood of a vertex  $v \in V(G)$  is defined to be  $N(v) = \{u \in V(G) : u \text{ is adjacent to } v\}$ . A set  $S \subseteq V(G)$  is a dominating set of  $G$  if  $N(v) \cap S \neq \emptyset$  for every vertex  $v \in V(G) \setminus S$ . Let  $\mathcal{D}(G)$  be the set of dominating sets of  $G$ . The domination number of  $G$  is defined to be,

$$\gamma(G) = \min\{|S| : S \in \mathcal{D}(G)\}.$$

A set  $S \subseteq V(G)$  is a total dominating set, TDS, of a graph  $G$  without isolated vertices if every vertex  $v \in V(G)$  is adjacent to at least one vertex in  $S$ . Let  $\mathcal{D}_t(G)$  be the set of total dominating sets of  $G$ .

The total domination number of  $G$  is defined to be,

$$\gamma_t(G) = \min\{|S| : S \in \mathcal{D}_t(G)\}.$$

By definition,  $\mathcal{D}_t(G) \subseteq \mathcal{D}(G)$ , so that  $\gamma(G) \leq \gamma_t(G)$ .

We define a  $\gamma_t(G)$ -set as a set  $S \in \mathcal{D}_t(G)$  with  $|S| = \gamma_t(G)$ . The same agreement will be assumed for optimal parameters associated with other characteristic sets defined in the paper. For instance, a  $\gamma(G)$ -set will be a set  $S \in \mathcal{D}(G)$  with  $|S| = \gamma(G)$ .

The theory of domination in graphs has been extensively studied. For instance, there are more than 4400 papers already published on domination and related parameters. In particular, we cite the following books [1,2]. In the case of total domination, there are over 580 published papers and one book [3]. Among these papers on total domination in graphs, there are over 50 which concern the case of product graphs. Surprisingly, none of these papers discusses the case of rooted product graphs. The present paper covers that gap in the theory.

In order to present our results, we need to introduce some additional notation and terminology. The closed neighborhood of  $v \in V(G)$  is defined to be  $N[v] = N(v) \cup \{v\}$ . A vertex  $v \in V(G)$  is universal if  $N[v] = V(G)$ , while it is a leaf if  $|N(v)| = 1$ . The set of leaves of  $G$  will be denoted by  $\mathcal{L}(G)$ . A support vertex is a vertex  $v$  with  $N(v) \cap \mathcal{L}(G) \neq \emptyset$ . The set of support vertices of  $G$  will be denoted by  $\mathcal{S}(G)$ . If  $v$  is a vertex of a graph  $G$ , then the vertex-deletion subgraph  $G - \{v\}$  is the

subgraph of  $G$  induced by  $V(G) \setminus \{v\}$ . By analogy, we define the subgraph  $G - S$  for an arbitrary subset  $S \subseteq V(G)$ .

The concept of rooted product graph was introduced in 1978 by Godsil and McKay [4]. Given a graph  $G$  of order  $n(G)$  and a graph  $H$  with root vertex  $v$ , the rooted product graph  $G \circ_v H$  is defined as the graph obtained from  $G$  and  $H$  by taking one copy of  $G$  and  $n(G)$  copies of  $H$  and identifying the  $i^{\text{th}}$  vertex of  $G$  with the root vertex  $v$  in the  $i^{\text{th}}$  copy of  $H$  for every  $i \in \{1, 2, \dots, n(G)\}$ . If  $H$  or  $G$  is a trivial graph, then  $G \circ_v H$  is equal to  $G$  or  $H$ , respectively. In this sense, hereafter we will only consider graphs  $G$  and  $H$  with no isolated vertex.

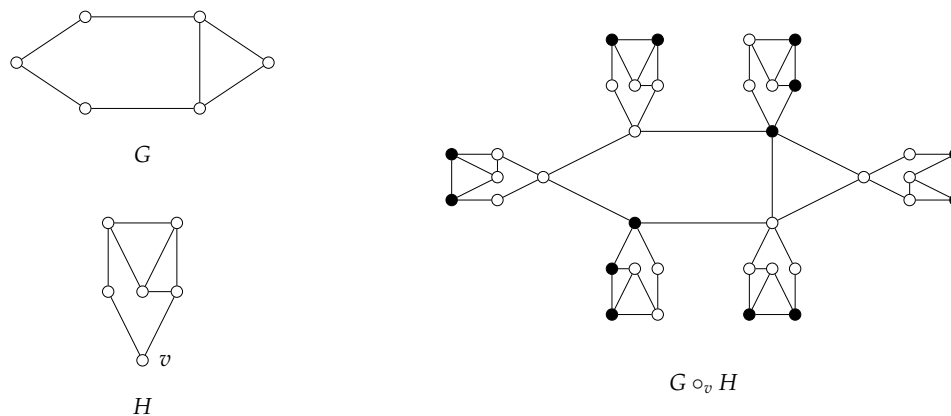

Figure 1. The set of black-coloured vertices forms a  $\gamma_t(G \circ_v H)$ -set.

Figure 1 shows an example of a rooted product graph. In this case, the set of black-coloured vertices forms a TDS of  $G \circ_v H$  and  $\gamma_t(G \circ_v H) = 14 = \gamma(G) + n(G)(\gamma_t(H) - 1)$ .

For every  $x \in V(G)$ ,  $H_x \cong H$  will denote the copy of  $H$  in  $G \circ_v H$  containing  $x$ . The restriction of any set  $S \subseteq V(G \circ_v H)$  to  $V(H_x)$  will be denoted by  $S_x$ , and the restriction to  $V(H_x - \{x\})$  will be denoted by  $S_x^-$ ; i.e.,  $S_x = S \cap V(H_x)$  and  $S_x^- = S_x \setminus \{x\}$ . In some cases, we will need to define  $S \subseteq V(G \circ_v H)$  from the sets  $S_x \subseteq V(H_x)$  as  $S = \cup_{x \in V(G)} S_x$ .

Since  $V(G \circ_v H) = \cup_{x \in V(G)} V(H_x)$ , we have that for every set  $S \subseteq V(G \circ_v H)$ ,

$$|S| = \sum_{x \in V(G)} |S_x| = \sum_{x \in V(G)} |S_x^-| + |S \cap V(G)|. \tag{1}$$

A basic problem in the study of product graphs consists of finding closed formulas or sharp bounds for specific invariants of the product of two graphs and expressing these in terms of parameters of the graphs involved in the product. In this sense, for recent results on rooted product graphs, we cite the following works [5–19]. As we can expect, the products of graphs are not alien to applications in other fields. In particular, in [5] the authors show that several important classes of chemical graphs can be expressed as rooted product graphs, and as described in [20], there exist a number of molecular graphs of high-tech interest that can be generated using the rooted product of graphs.

### 1. Closed Formulas for the Total Domination Number

The following three lemmas will be the main tools to deduce our results.

**Lemma 1.** Given a graph  $H$  with no isolated vertex and any  $v \in V(H) \setminus S(H)$ , the following statements hold.

- (i)  $\gamma_t(H - \{v\}) \geq \gamma_t(H) - 1$ .
- (ii) If  $\gamma_t(H - \{v\}) = \gamma_t(H) - 1$ , then the following statements hold.
  - (a)  $N(v) \cap S = \emptyset$  for every  $\gamma_t(H - \{v\})$ -set  $S$ .



- (b) There exists a  $\gamma_t(H)$ -set  $S$  such that  $v \notin S$ .
- (iii) If  $\gamma_t(H - \{v\}) > \gamma_t(H)$ , then  $v \in S$  for every  $\gamma_t(H)$ -set  $S$ .

**Proof.** Let  $v \in V(H) \setminus S(H)$  and  $S$  a  $\gamma_t(H - \{v\})$ -set. For every  $u \in N(v)$  we have that  $S \cup \{u\}$  is a TDS of  $H$ , which implies that  $\gamma_t(H) \leq |S \cup \{u\}| \leq \gamma_t(H - \{v\}) + 1$ . Therefore, (i) follows.

Now, in order to prove (ii), we assume that  $|S| = \gamma_t(H) - 1$ . If there exists a vertex  $y \in N(v) \cap S$ , then  $S$  is also a TDS of  $H$ , which is a contradiction. Therefore,  $N(v) \cap S = \emptyset$  and so (a) follows. In addition, for any  $y \in N(v)$ , the set  $S \cup \{y\}$  is a  $\gamma_t(H)$ -set not containing  $v$ . Therefore, (b) also follows.

Finally, we proceed to prove (iii). If there exists a  $\gamma_t(H)$ -set  $D$  such that  $v \notin D$ , then  $D$  is also a TDS of  $H - \{v\}$ , and so  $\gamma_t(H - \{v\}) \leq |D| = \gamma_t(H)$ . Therefore, we conclude that if  $\gamma_t(H - \{v\}) > \gamma_t(H)$ , then  $v \in D$  for every  $\gamma_t(H)$ -set  $D$ , which completes the proof.  $\square$

**Lemma 2.** Let  $H$  be a graph and  $v \in V(H)$ . If  $v$  is not a universal vertex and  $H - N[v]$  does not have isolated vertices, then

$$\gamma_t(H - N[v]) \geq \gamma_t(H) - 2.$$

Furthermore, if  $\gamma_t(H - \{v\}) = \gamma_t(H) - 1$ , then

$$\gamma_t(H) - 2 \leq \gamma_t(H - N[v]) \leq \gamma_t(H) - 1.$$

**Proof.** Assume that  $v$  is not a universal vertex and  $H - N[v]$  does not have isolated vertices. Let  $S$  be a  $\gamma_t(H - N[v])$ -set and  $u \in N(v)$ . Since  $S \cup \{u, v\}$  is a TDS of  $H$ , we have that  $\gamma_t(H) \leq |S \cup \{u, v\}| = \gamma_t(H - N[v]) + 2$ , as required.

Now, assume  $\gamma_t(H - \{v\}) = \gamma_t(H) - 1$ . In this case, by Lemma 1 (ii) we have that  $N(v) \cap D = \emptyset$  for every  $\gamma_t(H - \{v\})$ -set  $D$ , which implies that  $D$  is a TDS of  $H - N[v]$ , and so  $\gamma_t(H - N[v]) \leq |D| = \gamma_t(H - \{v\}) = \gamma_t(H) - 1$ . Therefore, the result follows.  $\square$

**Lemma 3.** Given a  $\gamma_t(G \circ_v H)$ -set  $S$  and a vertex  $x \in V(G)$ , the following statements hold.

- (i)  $|S_x| \geq \gamma_t(H) - 1$ .
- (ii) If  $|S_x| = \gamma_t(H) - 1$ , then  $N(x) \cap S_x = \emptyset$ .

**Proof.** Let  $x \in V(G)$ . Notice that every vertex in  $V(H_x) \setminus \{x\}$  is adjacent to some vertex in  $S_x$ . For any  $y \in N(x) \cap V(H_x)$ , the set  $S_x \cup \{y\}$  is a TDS of  $H_x$ , and so  $\gamma_t(H) = \gamma_t(H_x) \leq |S_x \cup \{y\}| = |S_x| + 1$ . Therefore, (i) follows.

Finally, assume that  $|S_x| = \gamma_t(H) - 1$ . If there exists a vertex  $y \in N(x) \cap S_x$ , then  $S_x$  is a TDS of  $H_x$ , which is a contradiction. Therefore,  $N(x) \cap S_x = \emptyset$ , and so (ii) follows.  $\square$

Given a  $\gamma_t(G \circ_v H)$ -set  $S$ , we define the following subsets of  $V(G)$  associated with  $S$ .

$$\mathcal{A}_S = \{x \in V(G) : |S_x| \geq \gamma_t(H)\} \text{ and } \mathcal{B}_S = \{x \in V(G) : |S_x| = \gamma_t(H) - 1\}.$$

These sets will play an important role in the inference results. By Lemma 3,  $V(G) = \mathcal{A}_S \cup \mathcal{B}_S$ . In particular, if  $\mathcal{A}_S = \emptyset$ , then  $\gamma_t(G \circ_v H) = n(G)(\gamma_t(H) - 1)$ , and as we will show in the proof of Theorem 2, if  $\mathcal{B}_S = \emptyset$ , then  $\gamma_t(G \circ_v H) = n(G)\gamma_t(H)$ . As we can expect, these are the extreme values of  $\gamma_t(G \circ_v H)$ .

**Theorem 1.** For any graphs  $G$  and  $H$  with no isolated vertex and any  $v \in V(H)$ ,

$$n(G)(\gamma_t(H) - 1) \leq \gamma_t(G \circ_v H) \leq n(G)\gamma_t(H).$$

Furthermore, if  $\gamma_t(H - \{v\}) = \gamma_t(H) - 1$ , then

$$\gamma_t(G \circ_v H) \leq \gamma_t(G) + n(G)(\gamma_t(H) - 1).$$

**Proof.** The lower bound follows from Lemma 3, as for any  $\gamma_t(G \circ_v H)$ -set  $S$ ,

$$\gamma_t(G \circ_v H) = |S| = \sum_{x \in V(G)} |S_x| \geq n(G)(\gamma_t(H) - 1).$$

Now, we proceed to prove the upper bound. Let  $D \subseteq V(G \circ_v H)$  such that  $D_x$  is a  $\gamma_t(H_x)$ -set for every  $x \in V(G)$ . It is readily seen that  $D$  is a TDS of  $G \circ_v H$ . Hence,

$$\gamma_t(G \circ_v H) \leq |D| = \sum_{x \in V(G)} |D_x| = \sum_{x \in V(G)} \gamma_t(H_x) = n(G)\gamma_t(H).$$

From now on, assume  $\gamma_t(H - \{v\}) = \gamma_t(H) - 1$ . Notice that, by assumption,  $H - \{v\}$  does not have isolated vertices.

Let  $W \subseteq V(G \circ_v H)$  such that  $W_x^- = W_x \setminus \{x\}$  is a  $\gamma_t(H_x - \{x\})$ -set for every  $x \in V(G)$  and  $W \cap V(G)$  is a  $\gamma_t(G)$ -set. Clearly,  $W$  is a TDS of  $G \circ_v H$ , which implies that

$$\gamma_t(G \circ_v H) \leq |W \cap V(G)| + \sum_{x \in V(G)} |W_x^-| = \gamma_t(G) + \sum_{x \in V(G)} \gamma_t(H_x - \{x\}) = \gamma_t(G) + n(G)(\gamma_t(H) - 1).$$

Therefore, the result follows.  $\square$

The following lemma is another important tool for determining all possible values of  $\gamma_t(G \circ_v H)$ .

**Lemma 4.** Given a  $\gamma_t(G \circ_v H)$ -set  $S$  with  $\mathcal{B}_S \neq \emptyset$ , the following statements hold.

- (i) If  $\mathcal{B}_S \cap S \neq \emptyset$ , then  $\gamma_t(G \circ_v H) = n(G)(\gamma_t(H) - 1)$ .
- (ii) If  $\mathcal{B}_S \cap S = \emptyset$ , then  $\gamma_t(H - \{v\}) = \gamma_t(H) - 1$ , and as a consequence,

$$\gamma(G) + n(G)(\gamma_t(H) - 1) \leq \gamma_t(G \circ_v H) \leq \gamma_t(G) + n(G)(\gamma_t(H) - 1).$$

**Proof.** First, we proceed to prove (i). Given a fixed  $x' \in \mathcal{B}_S \cap S$ , let  $D \subseteq V(G \circ_v H)$  such that for every  $x \in V(G)$  the set  $D_x$  is induced by  $S_{x'}$ . Obviously,  $D$  is a TDS of  $G \circ_v H$ . Hence,  $\gamma_t(G \circ_v H) \leq |D| = \sum_{x \in V(G)} |D_x| = n(G)|S_{x'}| = n(G)(\gamma_t(H) - 1)$ . Therefore, Theorem 1 leads to  $\gamma_t(G \circ_v H) = n(G)(\gamma_t(H) - 1)$ .

In order to prove (ii), assume that  $\mathcal{B}_S \cap S = \emptyset$ , and let  $x \in \mathcal{B}_S$ . By Lemma 3 we have that  $N[x] \cap S_x = \emptyset$ . So,  $x \notin S(H_x)$  and  $S_x$  is a TDS of  $H_x - \{x\}$ . Hence,  $\gamma_t(H - \{v\}) = \gamma_t(H_x - \{x\}) \leq |S_x| = \gamma_t(H) - 1$ , and so Lemma 1 leads to  $\gamma_t(H - \{v\}) = \gamma_t(H) - 1$ . Therefore, by Theorem 1 we have that  $\gamma_t(G \circ_v H) \leq \gamma_t(G) + n(G)(\gamma_t(H) - 1)$ .

Moreover, since  $N[x] \cap S_x = \emptyset$  for every  $x \in \mathcal{B}_S$ , we have that  $\mathcal{A}_S$  is a dominating set of  $G$ . Hence,

$$\begin{aligned} \gamma_t(G \circ_v H) &= \sum_{x \in \mathcal{A}_S} |S_x| + \sum_{x \in \mathcal{B}_S} |S_x| \\ &\geq |\mathcal{A}_S| \gamma_t(H) + |\mathcal{B}_S| (\gamma_t(H) - 1) \\ &\geq |\mathcal{A}_S| + n(G)(\gamma_t(H) - 1) \\ &\geq \gamma(G) + n(G)(\gamma_t(H) - 1). \end{aligned}$$

Therefore, the result follows.  $\square$

Next we give one of the main results of this section, which states the four possible values of  $\gamma_t(G \circ_v H)$ .

**Theorem 2.** Let  $G$  and  $H$  be two graphs with no isolated vertex. For any  $v \in V(H)$ ,

$$\gamma_t(G \circ_v H) \in \{n(G)(\gamma_t(H) - 1), \gamma(G) + n(G)(\gamma_t(H) - 1), \gamma_t(G) + n(G)(\gamma_t(H) - 1), n(G)\gamma_t(H)\}.$$

**Proof.** Let  $S$  be a  $\gamma_t(G \circ_v H)$ -set and consider the subsets  $\mathcal{A}_S, \mathcal{B}_S \subseteq V(G)$  associated with  $S$ . We distinguish the following cases.

Case 1.  $\mathcal{B}_S = \emptyset$ . In this case, for any  $x \in V(G)$  we have that  $|S_x| \geq \gamma_t(H)$ , and as a consequence,  $\gamma_t(G \circ_v H) = \sum_{x \in V(G)} |S_x| \geq n(G)\gamma_t(H)$ . Thus, Theorem 1 leads to the equality  $\gamma_t(G \circ_v H) = n(G)\gamma_t(H)$ .

Case 2.  $\mathcal{B}_S \neq \emptyset$ . If  $\mathcal{B}_S \cap S \neq \emptyset$ , then from Lemma 4 (i) we have that  $\gamma_t(G \circ_v H) = n(G)(\gamma_t(H) - 1)$ . From now on we assume that  $\mathcal{B}_S \cap S = \emptyset$ . Hence, Lemma 4 (ii) leads to

$$\gamma(G) + n(G)(\gamma_t(H) - 1) \leq \gamma_t(G \circ_v H) \leq \gamma_t(G) + n(G)(\gamma_t(H) - 1).$$

We only need to prove that  $\gamma_t(G \circ_v H)$  only can take the extreme values. To this end, we shall need to introduce the following notation. Let  $\mathcal{A}'_S = \{x \in \mathcal{A}_S : |S_x| = \gamma_t(H)\}$  and  $\mathcal{A}''_S = \mathcal{A}_S \setminus \mathcal{A}'_S$ .

Subcase 2.1. There exists  $x' \in \mathcal{A}'_S$  such that  $S_{x'}$  is a  $\gamma_t(H_{x'})$ -set containing  $x'$ . From a fixed vertex  $y \in \mathcal{B}_S$  and any  $\gamma(G)$ -set  $D$ , we can construct a set  $W \subseteq V(G \circ_v H)$  as follows. If  $x \in D$ , then  $W_x$  is induced by  $S_{x'}$ , while if  $x \in V(G) \setminus D$ , then  $W_x$  is induced by  $S_y$ . Notice that  $W$  is a TDS of  $G \circ_v H$ , which implies that  $\gamma_t(G \circ_v H) \leq |W| = \gamma(G) + n(G)(\gamma_t(H) - 1)$ . Therefore,  $\gamma_t(G \circ_v H) = \gamma(G) + n(G)(\gamma_t(H) - 1)$ .

Subcase 2.2.  $\mathcal{A}'_S = \emptyset$  or for any  $x \in \mathcal{A}'_S$ , either  $S_x$  is not a  $\gamma_t(H_x)$ -set or  $x \notin S_x$ . If  $\mathcal{A}'_S \neq \emptyset$ , then every vertex  $x \in \mathcal{A}'_S$  satisfies one of the following conditions.

- (a)  $S_x$  is a  $\gamma_t(H_x)$ -set such that  $x \notin S_x$ .
- (b)  $S_x$  is not a TDS of  $H_x$  and  $x \in S_x$ .

Notice that we do not consider the case where  $S_x$  is not a TDS of  $H_x$  and  $x \notin S_x$ , as in this case we can replace  $S$  with the  $\gamma_t(G \circ_v H)$ -set  $(S \setminus S_x) \cup S'_x$  for some  $\gamma_t(H_x)$ -set  $S'_x$ . In such a case, if  $x \in S'_x$ , then we proceed as in Subcase 2.1, while if  $x \notin S'_x$ , then  $x$  satisfies (a).

Let us construct a TDS  $X$  of  $G$  as follows.

- $\mathcal{A}_S \subseteq X$ .
- For any  $x \in \mathcal{A}'_S$  which satisfies condition (a) and  $N(x) \cap S \cap V(G) = \emptyset$ , we choose one vertex  $y \in N(x) \cap V(G)$  and set  $y \in X$ .
- For any  $x \in \mathcal{A}''_S$  with  $N(x) \cap S \cap V(G) = \emptyset$ , we choose one vertex  $y \in N(x) \cap V(G)$  and set  $y \in X$ .

We proceed to show that  $X$  is a TDS of  $G$ . If  $x \in V(G) \setminus X$ , then either  $x \in \mathcal{B}_S$  or  $x \in \mathcal{A}'_S \setminus S$ . If  $x \in \mathcal{B}_S$ , then  $N(x) \cap S \cap \mathcal{A}_S \neq \emptyset$ , which implies that  $N(x) \cap X \neq \emptyset$ . Obviously, if  $x \in \mathcal{A}'_S \setminus S$ , then  $N(x) \cap X \neq \emptyset$ , by definition of  $X$ . Now, let  $x \in X$ . If  $x \in \mathcal{A}''_S \cup (\mathcal{A}'_S \setminus S)$ , then  $N(x) \cap X \neq \emptyset$  by definition. If  $x \in \mathcal{A}'_S \cap S$ , then  $x$  satisfies condition (b). This implies that  $N(x) \cap S_x = \emptyset$ . Hence, there exists a vertex  $y \in N(x) \cap V(G) \cap S \subseteq X$ , as desired.

Therefore,  $X$  is a TDS of  $G$ , which implies that  $\gamma_t(G) \leq |X| \leq 2|\mathcal{A}''_S| + |\mathcal{A}'_S|$ . Thus,

$$\begin{aligned} \gamma_t(G \circ_v H) &\geq \sum_{x \in \mathcal{A}''_S} |S_x| + \sum_{x \in \mathcal{A}'_S} |S_x| + \sum_{x \in \mathcal{B}_S} |S_x| \\ &\geq |\mathcal{A}''_S|(\gamma_t(H) + 1) + |\mathcal{A}'_S|\gamma_t(H) + |\mathcal{B}_S|(\gamma_t(H) - 1) \\ &\geq (2|\mathcal{A}''_S| + |\mathcal{A}'_S|) + n(G)(\gamma_t(H) - 1) \\ &\geq \gamma_t(G) + n(G)(\gamma_t(H) - 1), \end{aligned}$$

which completes the proof.  $\square$

Later on, we will characterize the graphs that reach each of the previous expressions. However, we have to admit that when applying some of these characterizations we will need to calculate the total domination number of  $H - \{v\}$  or  $H - N[v]$  which may not be easy. Before giving the above

mentioned characterizations, we shall show a simple example in which we can observe that these expressions of  $\gamma_t(G \circ_v H)$  are realizable.

**Example 1.** Let  $G$  be a graph with no isolated vertex. If  $H$  is one of the graphs shown in Figure 2, then the resulting values of  $\gamma_t(G \circ_v H)$  for some specific roots are described below.

- $\gamma_t(G \circ_{v'} H_2) = 3n(G) = n(G)(\gamma_t(H_2) - 1)$ .
- $\gamma_t(G \circ_v H_2) = \gamma(G) + 3n(G) = \gamma(G) + n(G)(\gamma_t(H_2) - 1)$ .
- $\gamma_t(G \circ_v H_1) = \gamma_t(G) + 2n(G) = \gamma_t(G) + n(G)(\gamma_t(H_1) - 1)$ .
- $\gamma_t(G \circ_{v'} H_1) = \gamma_t(G \circ_{v''} H_1) = 3n(G) = n(G)\gamma_t(H_1)$ .

For these cases, it is not difficult to construct a  $\gamma_t(G \circ_v H)$ -set. For instance, a  $\gamma_t(G \circ_v H_2)$ -set  $S$  can be formed as follows. Given a fixed  $\gamma(G)$ -set  $X$ , we take  $S$  in such a way that the set  $S_x$  is induced by  $\{a, b, v', v\}$  for every  $x \in X$ , and induced by  $\{a, b, c\}$  for every  $x \in V(G) \setminus X$ .

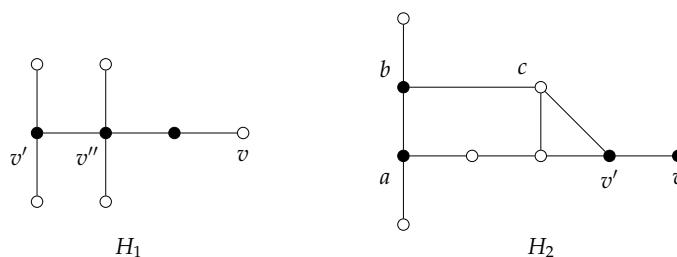

**Figure 2.** The set of black-coloured vertices forms a  $\gamma_t(H_i)$ -set for  $i \in \{1, 2\}$ . The set  $\{v', v''\}$  forms a  $\gamma_t(H_1 - \{v\})$ -set, while  $\{a, b, c\}$  forms a  $\gamma_t(H_2 - \{v\})$ -set.

As we have observed in Lemma 2, if  $v \in V(H)$  is not a universal vertex and  $H - N[v]$  does not have isolated vertices, then  $\gamma_t(H - N[v]) \geq \gamma_t(H) - 2$ . Next we show that the extreme case  $\gamma_t(H - N[v]) = \gamma_t(H) - 2$  characterizes the graphs with  $\gamma_t(G \circ_v H) = n(G)(\gamma_t(H) - 1)$ .

**Theorem 3.** Given two graphs  $G$  and  $H$  with no isolated vertex and  $v \in V(H)$ , the following statements are equivalent.

- (i)  $\gamma_t(G \circ_v H) = n(G)(\gamma_t(H) - 1)$ .
- (ii)  $v$  is a universal vertex of  $H$  or  $\gamma_t(H - N[v]) = \gamma_t(H) - 2$ .

**Proof.** First, assume that (i) holds. Let  $S$  be a  $\gamma_t(G \circ_v H)$ -set. If  $v$  is a universal vertex of  $H$ , then we are done. Assume that  $v \in V(H)$  is not a universal vertex. In this case, Lemma 3 leads to  $\mathcal{B}_S = V(G)$  and  $N(x) \cap S_x = \emptyset$  for every  $x \in \mathcal{B}_S$ . Thus,  $\mathcal{B}_S \cap S$  is a dominating set of  $G$  and for any  $x \in \mathcal{B}_S \cap S$  we have that  $H_x - N[x]$  does not have isolated vertices and  $S_x \setminus \{x\}$  is a TDS of  $H_x - N[x]$ , which implies that  $\gamma_t(H - N[v]) = \gamma_t(H_x - N[x]) \leq |S_x \setminus \{x\}| = \gamma_t(H) - 2$ . Hence, Lemma 2 leads to  $\gamma_t(H - N[v]) = \gamma_t(H) - 2$ . Therefore, (ii) follows.

Conversely, assume that (ii) holds. If  $v$  is a universal vertex of  $H$ , then  $V(G)$  is a TDS of  $G \circ_v H$ , which implies that  $\gamma_t(G \circ_v H) \leq |V(G)| = n(G) = n(G)(\gamma_t(H) - 1)$ . Thus, by Theorem 1 we conclude that  $\gamma_t(G \circ_v H) = n(G)(\gamma_t(H) - 1)$ .

From now on, we assume that  $v$  is not a universal vertex. For any  $x \in V(G)$ , let  $D'_x$  be a  $\gamma_t(H_x - N[x])$ -set and  $D_x = D'_x \cup \{x\}$ . Observe that  $D = \cup_{x \in V(G)} D_x$  is a TDS of  $G \circ_v H$ , which implies that  $\gamma_t(G \circ_v H) \leq |D| = n(G)(\gamma_t(H - N[v]) + 1) = n(G)(\gamma_t(H) - 1)$ . By Theorem 1 we conclude that  $\gamma_t(G \circ_v H) = n(G)(\gamma_t(H) - 1)$ , which completes the proof.  $\square$

**Lemma 5.** Let  $G$  and  $H$  be two graphs with no isolated vertex and  $v \in V(H) \setminus \mathcal{S}(H)$ . If  $\gamma_t(H - \{v\}) \geq \gamma_t(H)$ , then

$$\gamma_t(G \circ_v H) \in \{n(G)\gamma_t(H), n(G)(\gamma_t(H) - 1)\}.$$

**Proof.** By Theorem 1 we have that  $\gamma_t(G \circ_v H) \leq n(G)\gamma_t(H)$ . Let  $S$  be a  $\gamma_t(G \circ_v H)$ -set. If  $|S| = n(G)\gamma_t(H)$ , then we are done. Suppose that  $|S| < n(G)\gamma_t(H)$ . Hence, there exists  $x \in V(G)$  such that  $|S_x| < \gamma_t(H)$ , which implies that  $x \in \mathcal{B}_S$  by Lemma 3. Since  $\gamma_t(H - \{v\}) \geq \gamma_t(H)$ , Lemma 4 (ii) leads to  $x \in S$ , and by Lemma 4 (i) we deduce that  $\gamma_t(G \circ_v H) = n(G)(\gamma_t(H) - 1)$ .  $\square$

**Lemma 6.** Let  $G$  and  $H$  be two graphs with no isolated vertex and  $v \in V(H)$ . If  $v$  belongs to every  $\gamma_t(H)$ -set, then

$$\gamma_t(G \circ_v H) \in \{n(G)\gamma_t(H), n(G)(\gamma_t(H) - 1)\}.$$

**Proof.** We first consider the case where  $v \in V(H) \setminus \mathcal{S}(H)$ . By Lemma 1 we deduce that  $\gamma_t(H - \{v\}) \geq \gamma_t(H)$ , and so Lemma 5 leads to the result. Now, assume that  $v \in \mathcal{S}(H)$  and let  $S$  be a  $\gamma_t(G \circ_v H)$ -set. If  $\gamma_t(G \circ_v H) = n(G)\gamma_t(H)$ , then we are done. Thus, we assume that  $\gamma_t(G \circ_v H) < n(G)\gamma_t(H)$ . In such a case, there exists  $x \in \mathcal{B}_S$ , and since  $x \in \mathcal{S}(H_x)$ , it follows that  $x \in \mathcal{S}(G \circ H)$ . Therefore,  $x \in S$ , and by Lemma 4 (i) we deduce that  $\gamma_t(G \circ_v H) = n(G)(\gamma_t(H) - 1)$ , which completes the proof.  $\square$

We are now ready to characterize the graphs with  $\gamma_t(G \circ_v H) = \gamma(G) + n(G)(\gamma_t(H) - 1)$ .

**Theorem 4.** Let  $G$  and  $H$  be two graphs with no isolated vertex and  $v \in V(H)$ . The following statements are equivalent.

- (i)  $\gamma_t(G \circ_v H) = \gamma(G) + n(G)(\gamma_t(H) - 1)$ .
- (ii)  $\gamma_t(H - N[v]) = \gamma_t(H - \{v\}) = \gamma_t(H) - 1$ , and in addition,  $\gamma_t(G) = \gamma(G)$  or there exists a  $\gamma_t(H)$ -set  $D$  such that  $v \in D$ .

**Proof.** First, assume that (i) holds. Since  $1 \leq \gamma(G) < n(G)$ , by Lemma 6,  $v \notin \mathcal{S}(H)$ , so that from Lemma 5 we deduce that  $\gamma_t(H - \{v\}) \leq \gamma_t(H) - 1$  and Lemma 1 leads to  $\gamma_t(H - \{v\}) = \gamma_t(H) - 1$ . Hence, by Lemma 2 it follows that  $\gamma_t(H - N[v]) \in \{\gamma_t(H) - 2, \gamma_t(H) - 1\}$  and by Theorem 3 we obtain that  $\gamma_t(H - N[v]) = \gamma_t(H) - 1$ .

Now, let  $S$  be a  $\gamma_t(G \circ_v H)$ -set. Since  $1 \leq \gamma(G) < n(G)$ , Lemma 3 leads to  $\mathcal{A}_S \neq \emptyset$  and  $\mathcal{B}_S \neq \emptyset$ . Additionally, by Lemma 4 we deduce that  $\mathcal{B}_S \cap S = \emptyset$ , and by Lemma 3 we have that  $N(x) \cap S_x = \emptyset$  for every  $x \in \mathcal{B}_S$ . Hence,  $\mathcal{A}_S$  is a dominating set of  $G$  and  $\mathcal{A}_S \cap S \neq \emptyset$ . Thus,  $\gamma_t(G \circ_v H) \geq |\mathcal{A}_S| + n(G)(\gamma_t(H) - 1) \geq \gamma(G) + n(G)(\gamma_t(H) - 1) = \gamma_t(G \circ_v H)$ , which implies that  $\mathcal{A}_S$  is a  $\gamma(G)$ -set and for every  $x \in \mathcal{A}_S \cap S$  we have that  $|S_x| = \gamma_t(H)$ . Therefore, there exists  $x \in \mathcal{A}_S \cap S$  such that  $S_x$  is a  $\gamma_t(H_x)$ -set or  $\mathcal{A}_S$  is a  $\gamma_t(G)$ -set, which implies that (ii) holds.

Conversely, assume that (ii) holds. As above, let  $S$  be a  $\gamma_t(G \circ_v H)$ -set. Since  $\gamma_t(H - \{v\}) = \gamma_t(H) - 1$ , by Theorem 1,  $\gamma_t(G \circ_v H) \leq \gamma(G) + n(G)(\gamma_t(H) - 1)$ .

Suppose that  $\mathcal{B}_S = \emptyset$ . In such a case,  $\gamma_t(G \circ_v H) = n(G)\gamma_t(H)$ , which implies that  $\gamma(G) < \gamma_t(G) = n(G)$ , and so  $G \cong \cup K_2$ . Let  $A \cup B = V(G)$  be the bipartition of the vertex set of  $G$ , i.e., every edge has one endpoint in  $A$  and the other one in  $B$ . Thus, for every  $x \in V(G)$  we define a subset  $Y_x \subseteq V(H_x)$  as follows. If  $x \in A$ , then  $Y_x$  is a  $\gamma_t(H_x)$ -set which contains  $x$ , while if  $x \in B$ , then  $Y_x$  is a  $\gamma_t(H_x - \{x\})$ -set. Hence,  $Y = \cup_{x \in V(G)} Y_x$  is a TDS of  $G \circ_v H$  and so  $\gamma_t(G \circ_v H) \leq |Y| = n(G)\gamma_t(H) - \frac{n(G)}{2} < n(G)\gamma_t(H)$ , which is a contradiction. From now on we assume that  $\mathcal{B}_S \neq \emptyset$ .

If there exists a vertex  $x \in \mathcal{B}_S \cap S$ , then by Lemma 3 we have that  $N(x) \cap S_x = \emptyset$ , which implies that  $S_x \setminus \{x\}$  is a TDS of  $H_x - N[x]$ . Hence,  $\gamma_t(H - N[v]) = \gamma_t(H_x - N[x]) \leq |S_x \setminus \{x\}| = \gamma_t(H) - 2$ , which is a contradiction with the assumption  $\gamma_t(H - N[v]) = \gamma_t(H) - 1$ . Therefore,  $\mathcal{B}_S \cap S = \emptyset$ , and by Lemma 4 we deduce that  $\gamma_t(G \circ_v H) \geq \gamma(G) + n(G)(\gamma_t(H) - 1)$ .

It is still necessary to prove that  $\gamma_t(G \circ_v H) \leq \gamma(G) + n(G)(\gamma_t(H) - 1)$ . If  $\gamma(G) = \gamma_t(G)$ , then we are done. Assume  $\gamma(G) < \gamma_t(G)$ . Now we take a  $\gamma(G)$ -set  $X$  and for every  $x \in V(G)$  we define a set  $Z_x \subseteq V(H_x)$  as follows. If  $x \in X$ , then  $Z_x$  is a  $\gamma_t(H_x)$ -set such that  $x \in Z_x$ , while if  $x \in V(G) \setminus X$ , then  $Z_x$  is a  $\gamma_t(H_x - \{x\})$ -set. Notice that  $Z = \cup_{x \in V(G)} Z_x$  is a TDS of  $G \circ_v H$ . Therefore,  $\gamma_t(G \circ_v H) \leq |Z| = \gamma(G) + n(G)(\gamma_t(H) - 1)$ , as required.  $\square$

Next we proceed to characterize the graphs with  $\gamma_t(G \circ_v H) = \gamma_t(G) + n(G)(\gamma_t(H) - 1)$ . Notice that it is excluded the case  $G \cong \cup K_2$ . In such a case,  $\gamma_t(G) = n(G)$ , and so  $\gamma_t(G) + n(G)(\gamma_t(H) - 1) = n(G)\gamma_t(H)$ , which implies that the characterization of this particular case can be derived by elimination from Theorems 3 and 4. Analogously, the case  $\gamma(G) = \gamma_t(G)$  is excluded, as it was discussed in Theorem 4.

**Theorem 5.** Let  $G \not\cong \cup K_2$  and  $H$  be two graphs with no isolated vertex such that  $\gamma(G) < \gamma_t(G)$ , and let  $v \in V(H)$ . The following statements are equivalent.

- (i)  $\gamma_t(G \circ_v H) = \gamma_t(G) + n(G)(\gamma_t(H) - 1)$ .
- (ii)  $\gamma_t(H - \{v\}) = \gamma_t(H) - 1$  and  $v \notin D$  for every  $\gamma_t(H)$ -set  $D$ .

**Proof.** First, assume that (i) holds. Since,  $G \not\cong \cup K_2$ , we have that  $\gamma_t(G) < n(G)$ . Thus, by Lemma 6,  $v \notin \mathcal{S}(H)$  and then by Lemma 5 we deduce that  $\gamma_t(H - \{v\}) \leq \gamma_t(H) - 1$  and Lemma 1 leads to  $\gamma_t(H - \{v\}) = \gamma_t(H) - 1$ .

Suppose that there exists a  $\gamma_t(H)$ -set containing  $v$ . Let  $X$  be a  $\gamma(G)$ -set. For every  $x \in V(G)$  we define a set  $Z_x \subseteq V(H_x)$  as follows. If  $x \in X$ , then  $Z_x$  is a  $\gamma_t(H_x)$ -set such that  $x \in Z_x$ , while if  $x \in V(G) \setminus X$ , then  $Z_x$  is a  $\gamma_t(H_x - \{x\})$ -set. Notice that  $Z = \cup_{x \in V(G)} Z_x$  is a TDS of  $G \circ_v H$ . Therefore,  $\gamma_t(G \circ_v H) \leq |Z| = \gamma(G) + n(G)(\gamma_t(H) - 1)$ , which is a contradiction, as  $\gamma_t(G) > \gamma(G)$ . Therefore,  $v \notin D$  for every  $\gamma_t(H)$ -set  $D$ , which implies that (ii) follows.

Conversely, assume that (ii) holds. Since  $\gamma_t(H - \{v\}) = \gamma_t(H) - 1$ , by Theorem 1 we have that  $\gamma_t(G \circ_v H) \leq \gamma_t(G) + n(G)(\gamma_t(H) - 1)$ . Let  $S$  be a  $\gamma_t(G \circ_v H)$ -set. If  $\mathcal{B}_S = \emptyset$ , then  $\gamma_t(G \circ_v H) = n(G)\gamma_t(H)$ , and so  $\gamma_t(G) = n(G)$ , which is a contradiction, as  $G \not\cong \cup K_2$ . Hence, from now on we assume that  $\mathcal{B}_S \neq \emptyset$ .

If there exists a vertex  $x \in \mathcal{B}_S \cap S$ , then for any vertex  $y \in N(v) \cap V(H_x)$ , the set  $S_x \cup \{y\}$  is a  $\gamma_t(H_x)$ -set, which is a contradiction. Thus,  $\mathcal{B}_S \cap S = \emptyset$ , and so by Lemma 3,  $\mathcal{A}_S$  is a dominating set of  $G$ . Moreover, by Lemma 4 and Theorem 2 we deduce that either  $\gamma_t(G \circ_v H) = \gamma(G) + n(G)(\gamma_t(H) - 1)$  or  $\gamma_t(G \circ_v H) = \gamma_t(G) + n(G)(\gamma_t(H) - 1)$ . Now, let  $\mathcal{A}_S = A^- \cup A^+$  where  $x \in A^-$  if  $x \in \mathcal{A}_S$  and  $N(x) \cap \mathcal{A}_S = \emptyset$ . Let  $B \subseteq \mathcal{B}_S$  such that  $|B| \leq |A^-|$  and  $N(x) \cap B \neq \emptyset$  for every  $x \in A^-$ . Obviously,  $B \cup A^+$  is a total dominating set of  $G$ , and so  $\gamma_t(G) + n(G)(\gamma_t(H) - 1) \leq |B \cup A^+| + n(G)(\gamma_t(H) - 1) \leq |A_S| + n(G)(\gamma_t(H) - 1) \leq \gamma_t(G \circ_v H)$ . Therefore, the result follows.  $\square$

From Theorem 2 we learned that there are four possible expressions for  $\gamma_t(G \circ_v H)$ . In the case of the first three expressions, the graphs (and the root) reaching the equality were characterized in Theorems 3–5. In the case of the expression  $\gamma_t(G \circ_v H) = n(G)\gamma_t(H)$ , the corresponding characterization can be derived by elimination from the previous results, although it must be recognized that the formulation of such a characterization is somewhat cumbersome. To conclude this section, we will just give a couple of examples where this expression is obtained.

The following result shows an example where  $\gamma_t(G \circ_v H) = n(G)\gamma_t(H)$ , which covers the cases in which  $v$  is a neighbor of a support vertex, excluding the case where  $v$  is the only leaf adjacent to its support.

**Proposition 1.** Let  $G$  and  $H$  be two graphs with no isolated vertex and  $v \in V(H)$ . If there exists  $u \in N(v)$  such that  $N(u) \cap (\mathcal{L}(H) \setminus \{v\}) \neq \emptyset$ , then

$$\gamma_t(G \circ_v H) = n(G)\gamma_t(H).$$

**Proof.** Assume first that  $v \notin \mathcal{S}(H)$ . Let  $D$  be a  $\gamma_t(H - \{v\})$ -set. Since  $u \in \mathcal{S}(H - \{v\})$ , we have that  $u \in D$ . Hence,  $D$  is a TDS of  $H$ , and so  $\gamma_t(H - \{v\}) = |D| \geq \gamma_t(H)$ . Therefore, Lemma 5 leads to  $\gamma_t(G \circ_v H) = n(G)\gamma_t(H)$  or  $\gamma_t(G \circ_v H) = n(G)(\gamma_t(H) - 1)$ . Now, suppose that  $\gamma_t(G \circ_v H) = n(G)(\gamma_t(H) - 1)$ . Let  $S$  be a  $\gamma_t(G \circ_v H)$ -set. By Lemma 3,  $\mathcal{B}_S = V(G)$  and  $N(x) \cap S_x = \emptyset$

for every  $x \in \mathcal{B}_S$ , which is a contradiction, as  $N(x) \cap \mathcal{S}(H_x) \neq \emptyset$  and  $\mathcal{S}(H_x) \subseteq S_x$ . Therefore,  $\gamma_t(G \circ_v H) = n(G)\gamma_t(H)$ .

Now, if  $v \in \mathcal{S}(H)$ , then  $u, v \in \mathcal{S}(G \circ_v H)$ . Hence, for every  $\gamma_t(G \circ_v H)$ -set  $S$  and every vertex  $x \in V(G)$ , we have that  $S_x$  is a TDS of  $H_x$ . Thus,  $\mathcal{B}_S = \emptyset$ , which implies that  $\gamma_t(G \circ_v H) = n(G)\gamma_t(H)$ , as required.  $\square$

We next consider another example where  $\gamma_t(G \circ_v H) = n(G)\gamma_t(H)$ .

**Proposition 2.** Let  $G$  and  $H$  be two graphs with no isolated vertex and  $v \in V(H) \setminus \mathcal{S}(H)$ . If  $\gamma_t(H - \{v\}) \geq \gamma_t(H)$  and  $v$  does not belong to any  $\gamma_t(H)$ -set, then

$$\gamma_t(G \circ_v H) = n(G)\gamma_t(H).$$

**Proof.** If  $\gamma_t(H - \{v\}) \geq \gamma_t(H)$ , then by Lemma 5 we have that  $\gamma_t(G \circ_v H) = n(G)\gamma_t(H)$  or  $\gamma_t(G \circ_v H) = n(G)(\gamma_t(H) - 1)$ . Now, assume that  $v$  does not belong to any  $\gamma_t(H)$ -set. If  $\gamma_t(G \circ_v H) = n(G)(\gamma_t(H) - 1)$ , then  $\mathcal{B}_S = V(G)$ . Hence, by Lemma 4 (ii) there exists  $x \in \mathcal{B}_S \cap S$ , which is a contradiction as from any  $x' \in N(x) \cap V(H_x)$  the set  $S_x \cup \{x'\}$  is a  $\gamma_t(H_x)$ -set containing  $x$ . Therefore,  $\gamma_t(G \circ_v H) = n(G)\gamma_t(H)$ .  $\square$

## 2. An Observation on the Domination Number

It was shown in [15] that there are two possibilities for the domination number of a rooted product graph. Since the graphs reaching these expressions have not been characterized, we consider that it is appropriate to derive a result in this direction. Specifically, we will provide a characterization in Theorem 7.

**Theorem 6.** [15] For any nontrivial graphs  $G$  and  $H$  and any  $v \in V(H)$ ,

$$\gamma(G \circ_v H) \in \{n(G)\gamma(H), \gamma(G) + n(G)(\gamma(H) - 1)\}.$$

In order to derive our result, we need to introduce the following two lemmas.

**Lemma 7.** [21] Let  $H$  be a graph. For any vertex  $v \in V(H)$ ,

$$\gamma(H - \{v\}) \geq \gamma(H) - 1.$$

**Lemma 8.** For any  $\gamma(G \circ_v H)$ -set  $D$  and any vertex  $x \in V(G)$ ,

$$|D_x| \geq \gamma(H) - 1.$$

Furthermore, if  $|D_x| = \gamma(H) - 1$ , then  $N[x] \cap D_x = \emptyset$ .

**Proof.** Let  $x \in V(G)$ . Notice that every vertex in  $V(H_x) \setminus \{x\}$  is adjacent to some vertex in  $D_x$ . Since  $D_x \cup \{x\}$  is a dominating set of  $H_x$ , we have that  $\gamma(H) = \gamma(H_x) \leq |D_x \cup \{x\}| \leq |D_x| + 1$ , as required.

Now, assume that  $|D_x| = \gamma(H) - 1$ . If  $N[x] \cap D_x \neq \emptyset$ , then  $D_x$  is a dominating set of  $H_x$ , which is a contradiction as  $|D_x| = \gamma(H_x) - 1$ . Therefore, the result follows.  $\square$

**Theorem 7.** For any pair of nontrivial graphs  $G$  and  $H$ , and any  $v \in V(H)$ ,

$$\gamma(G \circ_v H) = \begin{cases} \gamma(G) + n(G)(\gamma(H) - 1) & \text{if } \gamma(H - \{v\}) = \gamma(H) - 1, \\ n(G)\gamma(H) & \text{otherwise.} \end{cases}$$

**Proof.** By Theorem 6 we only need to prove that  $\gamma(G \circ_v H) = \gamma(G) + n(G)(\gamma(H) - 1)$  if and only if  $\gamma(H - \{v\}) = \gamma(H) - 1$ .

We first assume  $\gamma(H - \{v\}) = \gamma(H) - 1$ . Let  $D \subseteq V(G \circ_v H)$  such that  $D_x^- = D_x \setminus \{x\}$  is a  $\gamma(H_x - \{x\})$ -set for every  $x \in V(G)$ , and  $D \cap V(G)$  is a  $\gamma(G)$ -set. It is readily seen that  $D$  is a dominating set of  $G \circ_v H$ , which implies that  $\gamma(G \circ_v H) \leq |D| = \gamma(G) + \sum_{x \in V(G)} |D_x^-| = \gamma(G) + n(G)(\gamma(H) - 1)$ , and by Theorem 6 we conclude that the equality holds.

Conversely, assume  $\gamma(G \circ_v H) = \gamma(G) + n(G)(\gamma(H) - 1)$ . Let  $S$  be a  $\gamma(G \circ_v H)$ -set. Since  $|S| < n(G)\gamma(H)$ , there exists  $x \in V(G)$  such that  $|S_x| < \gamma(H)$ . Hence, by Lemma 8,  $|S_x| = \gamma(H) - 1$  and  $N[x] \cap S_x = \emptyset$ . This implies that  $S_x$  is a dominating set of  $H_x - \{x\}$ , and so  $\gamma(H - \{v\}) = \gamma(H_x - \{x\}) \leq |S_x| = \gamma(H) - 1$ . By Lemma 7 we conclude that  $\gamma(H - \{v\}) = \gamma(H) - 1$ , which completes the proof.  $\square$

**Author Contributions:** All authors contributed equally to this work. All authors have read and agreed to the published version of the manuscript

**Funding:** This research received no external funding.

**Conflicts of Interest:** The authors declare no conflict of interest.

## References

1. Haynes, T.W.; Hedetniemi, S.T.; Slater, P.J. *Domination in Graphs: Advanced Topics*; Chapman and Hall/CRC Pure and Applied Mathematics Series; Marcel Dekker, Inc.: New York, NY, USA, 1998.
2. Haynes, T.W.; Hedetniemi, S.T.; Slater, P.J. *Fundamentals of Domination in Graphs*; Chapman and Hall/CRC Pure and Applied Mathematics Series; Marcel Dekker, Inc.: New York, NY, USA, 1998.
3. Henning, M.; Yeo, A. *Total Domination in Graphs*. Springer Monographs in Mathematics; Springer: New York, NY, USA, 2013.
4. Godsil, C.D.; McKay, B.D. A new graph product and its spectrum *Bull. Austral. Math. Soc.* **1978**, *18*, 21–28. [[CrossRef](#)]
5. Azari, M.; Iranmanesh, A. Chemical Graphs Constructed from Rooted Product and Their Zagreb Indices. *MATCH Commun. Math. Comput. Chem.* **2013**, *70*, 901–919.
6. Cabrera Martínez, A. Double outer-independent domination number of graphs. *Quaest. Math.* **2020**. [[CrossRef](#)]
7. Cabrera Martínez, A.; Cabrera García, S.; Carrión García, A.; Hernández Mira, F.A. Total Roman domination number of rooted product graphs. *Mathematics* **2020**, *8*, 1850. [[CrossRef](#)]
8. Cabrera Martínez, A.; Cabrera García, S.; Carrión García, A.; Grisales del Rio, A.M. On the outer-independent Roman domination in graphs. *Symmetry* **2020**, *12*, 1846. [[CrossRef](#)]
9. Cabrera Martínez, A.; Estrada-Moreno, A.; Rodríguez-Velázquez, J.A. Secure total domination in rooted product graphs. *Mathematics* **2020**, *8*, 600. [[CrossRef](#)]
10. Cabrera Martínez, A.; Montejano, L.P.; Rodríguez-Velázquez, J.A. Total weak Roman domination in graphs. *Symmetry* **2019**, *11*, 831. [[CrossRef](#)]
11. Chris Monica, M.; Santhakumar, S. Partition dimension of rooted product graphs. *Discrete Appl. Math.* **2019**, *262*, 138–147. [[CrossRef](#)]
12. Hernández-Ortiz, R.; Montejano, L.P.; Rodríguez-Velázquez, J.A. Italian domination in rooted product graphs. *Bull. Malays. Math. Sci. Soc.* **2020**. [[CrossRef](#)]
13. Hernández-Ortiz, R.; Montejano, L.P.; Rodríguez-Velázquez, J.A. Secure domination in rooted product graphs. *J. Comb. Optim.* to appear.
14. Klavžar, S.; Yero, I.G. The general position problem and strong resolving graphs. *Open Math.* **2019**, *17*, 1126–1135. [[CrossRef](#)]
15. Kuziak, D.; Lemanska, M.; Yero, I.G. Domination-Related parameters in rooted product graphs. *Bull. Malays. Math. Sci. Soc.* **2019**, *39*, 199–217. [[CrossRef](#)]
16. Kuziak, D.; Yero, I.G.; Rodríguez-Velázquez, J.A. Strong metric dimension of rooted product graphs. *Int. J. Comput. Math.* **2016**, *93*, 1265–1280. [[CrossRef](#)]



17. Jakovac, M. The k-path vertex cover of rooted product graphs. *Discrete Appl. Math.* **2015**, *187*, 111–119. [[CrossRef](#)]
18. Lou, Z.; Huang, Q.; Huang, X. On the construction of Q-controllable graphs. *Electron. J. Linear Algebra* **2017**, *32*, 365–379. [[CrossRef](#)]
19. Yang, Y.; Klein, D.J. Resistance distances in composite graphs. *J. Phys. A* **2014**, *47*, 375203. [[CrossRef](#)]
20. Farrell, E.J.; Rosenfeld, V.R. Block and articulation node polynomials of the generalized rooted product of graphs. *J. Math. Sci. India* **2000**, *11*, 35–47.
21. Sampathkumar, E.; Neeralagi, P.S. Domination and neighbourhood critical, fixed, free and totally free points. *Sankhya* **1992**, *54*, 403–407.

**Publisher’s Note:** MDPI stays neutral with regard to jurisdictional claims in published maps and institutional affiliations.



© 2020 by the authors. Licensee MDPI, Basel, Switzerland. This article is an open access article distributed under the terms and conditions of the Creative Commons Attribution (CC BY) license (<http://creativecommons.org/licenses/by/4.0/>).

## Chapter 3

# Total Roman $\{2\}$ -domination in graphs

This chapter includes a complete copy of the following paper.

S. Cabrera García, A. Cabrera Martínez, F.A. Hernández Mira, I.G. Yero. Total Roman  $\{2\}$ -domination in graphs, *Quaest. Math.* (2021) 44(3), 411–434.

URL: <https://doi.org/10.2989/16073606.2019.1695230>

Quality indicators:

2019 JCR Impact factor: 1.049, Q2 (105/325), Mathematics.

## Total Roman $\{2\}$ -domination in graphs \*

Suitberto Cabrera García<sup>(1)</sup>, Abel Cabrera Martínez<sup>(2)</sup>,  
Frank A. Hernández Mira <sup>(3)</sup>, Ismael G. Yero <sup>(4)</sup>

<sup>(1)</sup> Universitat Politècnica de Valencia

Departamento de Estadística e Investigación Operativa Aplicadas y Calidad  
Camino de Vera s/n, 46022 Valencia, Spain.  
suicabga@eio.upv.es

<sup>(2)</sup> Universitat Rovira i Virgili

Departament d'Enginyeria Informàtica i Matemàtiques  
Av. Països Catalans 26, 43007 Tarragona, Spain.  
abel.cabrera@urv.cat

<sup>(3)</sup> Universidad Autónoma de Guerrero

Facultad de Matemáticas, Carlos E. Adame 5, La Garita, 39350 Acapulco, Mexico  
fmira8906@gmail.com

<sup>(4)</sup> Universidad de Cádiz, Departamento de Matemáticas

Av. Ramón Puyol s/n, 11202 Algeciras, Spain.  
ismael.gonzalez@uca.es

### Abstract

Given a graph  $G = (V, E)$ , a function  $f : V \rightarrow \{0, 1, 2\}$  is a total Roman  $\{2\}$ -dominating function if

- every vertex  $v \in V$  for which  $f(v) = 0$  satisfies that  $\sum_{u \in N(v)} f(u) \geq 2$ , where  $N(v)$  represents the open neighborhood of  $v$ , and
- every vertex  $x \in V$  for which  $f(x) \geq 1$  is adjacent to at least one vertex  $y \in V$  such that  $f(y) \geq 1$ .

---

\*This is an original manuscript of an article published by Taylor & Francis in *Quaestiones Mathematicae*, available online: <http://www.tandfonline.com/10.2989/16073606.2019.1695230>.

The weight of the function  $f$  is defined as  $\omega(f) = \sum_{v \in V} f(v)$ . The total Roman  $\{2\}$ -domination number, denoted by  $\gamma_{t\{R2\}}(G)$ , is the minimum weight among all total Roman  $\{2\}$ -dominating functions on  $G$ . In this article we introduce the concepts above and begin the study of its combinatorial and computational properties. For instance, we give several closed relationships between this parameter and other domination related parameters in graphs. In addition, we prove that the complexity of computing the value  $\gamma_{t\{R2\}}(G)$  is NP-hard, even when restricted to bipartite or chordal graphs.

*Mathematics Subject Classification (2010):* 05C69, 05C75.

*Key words:* Total Roman  $\{2\}$ -domination, Roman  $\{2\}$ -domination, total Roman domination, total domination.

## 1 Introduction

Throughout this article we only consider simple graphs  $G$  with vertex set  $V(G)$  and edge set  $E(G)$ . That is, graphs that are finite, undirected, and without loops or multiple edges. Given a vertex  $v$  of  $G$ ,  $N_G(v)$  denotes the *open neighborhood* of  $v$  in  $G$ :  $N_G(v) = \{u \in V(G) : uv \in E(G)\}$ . The *closed neighborhood*, denoted by  $N_G[v]$ , equals  $N_G(v) \cup \{v\}$ . Whenever possible, we shall skip the subindex  $G$  in the notations above.

A function  $f : V(G) \rightarrow \{0, 1, 2, \dots\}$  on  $G$  is said to be a *dominating function* if for every vertex  $v$  such that  $f(v) = 0$ , there exists a vertex  $u \in N(v)$ , such that  $f(u) > 0$ ; furthermore,  $f$  is said to be a *total dominating function* (TDF) if for every vertex  $v$ , there exists a vertex  $u \in N(v)$ , such that  $f(u) > 0$ . The *weight* of a function  $f$  on a set  $S \subseteq V(G)$  is  $f(S) = \sum_{v \in S} f(v)$ . If particularly  $S = V(G)$ , then  $f(V(G))$  will be represented as  $\omega(f)$ .

Recently, (total) dominating functions in domination theory have received much attention. A purely theoretic motivation is given by the fact that the (total) dominating function problem can be seen, in some sense, as a proper generalization of the classical (total) domination problem. That is, a set  $S \subseteq V(G)$  is a *(total) dominating set* if there exists a (total) dominating function  $f$  such that  $f(x) > 0$  if and only if  $x \in S$ . The *(total) domination number* of  $G$ , denoted by  $(\gamma_t(G))$   $\gamma(G)$ , is the minimum cardinality among all (total) dominating sets of  $G$ , or equivalently, the minimum weight among all (total) dominating functions on  $G$ . Domination in graphs is a classical topic, and nowadays, one of the most active areas of research in graph theory. For more information on domination and total domination see the books [13, 14, 17] and the survey [15].

From now on, we restrict ourselves to the case of functions  $f : V(G) \rightarrow \{0, 1, 2\}$ . Let  $V_i = \{v \in V(G) : f(v) = i\}$  for every  $i \in \{0, 1, 2\}$ . We will identify  $f$  with the three subsets of  $V(G)$  induced by  $f$  and write  $f(V_0, V_1, V_2)$ . Notice that the weight of  $f$  satisfies  $\omega(f) = \sum_{i=0}^2 i|V_i| = 2|V_2| + |V_1|$ . We shall also write  $V_{0,2} = \{v \in V_0 : N(v) \cap V_2 \neq \emptyset\}$  and  $V_{0,1} = V_0 \setminus V_{0,2}$ .

We now define some types of (total) dominating functions, which are obtained by imposing certain restrictions, and introduce a new one, in order to begin with the exposition of our results.

A *Roman  $\{2\}$ -dominating function* (R2DF) is a dominating function  $f(V_0, V_1, V_2)$  satisfying the condition that for every vertex  $v \in V_0$ ,  $f(N(v)) \geq 2$ . The *Roman  $\{2\}$ -domination number*

of  $G$ , denoted by  $\gamma_{\{R2\}}(G)$ , is the minimum weight among all R2DFs on  $G$ . A R2DF of weight  $\gamma_{\{R2\}}(G)$  is called a  $\gamma_{\{R2\}}(G)$ -function. This concept was introduced by Chellali et al. in [8]. It was also further studied in [16], where it was called *Italian domination number*.

A *total Roman dominating function* (TRDF) on a graph  $G$  is a TDF  $f(V_0, V_1, V_2)$  on  $G$  satisfying that for every vertex  $v \in V_0$  there exists a vertex  $u \in N(v) \cap V_2$ . The *total Roman domination number*, denoted by  $\gamma_{tR}(G)$ , is the minimum weight among all TRDFs on  $G$ . A TRDF of weight  $\gamma_{tR}(G)$  is called a  $\gamma_{tR}(G)$ -function. This concept was introduced by Liu and Chang [18]. For recent results on the total Roman domination in graphs we cite [1, 2, 6].

A set  $S \subseteq V(G)$  is a *double dominating set* of  $G$  if for every vertex  $v \in V(G)$ ,  $|N[v] \cap S| \geq 2$ . The *double domination number* of  $G$ , denoted by  $\gamma_{\times 2}(G)$ , is the minimum cardinality among all double dominating sets of  $G$ . This graph parameter was introduced in [12] by Harary and Haynes, and it was also studied, for example, in [3, 7, 11].

In this article we introduce the study of total Roman  $\{2\}$ -domination in graphs. We define a *total Roman  $\{2\}$ -dominating function* (TR2DF) to be a R2DF on  $G$  which is a TDF as well. The *total Roman  $\{2\}$ -domination number*, denoted by  $\gamma_{t\{R2\}}(G)$ , is the minimum weight among all TR2DFs on  $G$ .

In particular, we can define a *double dominating function* (DDF) to be a TR2DF  $f(V_0, V_1, V_2)$  in which  $V_2 = \emptyset$ . Obviously  $f(V_0, V_1, \emptyset)$  is a DDF if and only if  $V_1$  is a double dominating set of  $G$ .

To illustrate the definitions above, we consider the graph shown in Figure 1.

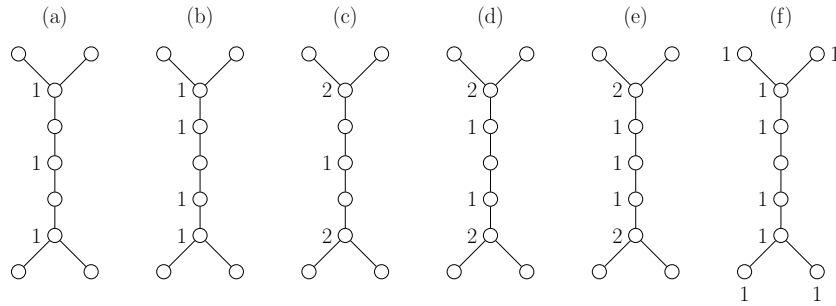

Figure 1: Graph  $G$  with different labelings (vertices with no drawn label have label zero) to show the values of several parameters:  $\gamma(G) = 3$  (a),  $\gamma_t(G) = 4$  (b),  $\gamma_{\{R2\}}(G) = 5$  (c),  $\gamma_{t\{R2\}}(G) = 6$  (d),  $\gamma_{tR}(G) = 7$  (e) and  $\gamma_{\times 2}(G) = 8$  (f).

The article is organized as follows. Section 2 introduces general combinatorial results which show the close relationship that exists between the total Roman  $\{2\}$ -domination number and other domination parameters. Also, we obtain general bounds and discuss the extreme cases. Finally, in Section 3 we show that the problem of deciding if a graph has a TR2DF of a given weight is NP-complete, even when restricted to bipartite graphs or chordal graphs.

## 1.1 Terminology and Notation

Given a graph  $G$ , we denote by  $\delta_G(v) = |N_G(v)|$  the *degree* of a vertex  $v$  of  $G$ . Also,  $\delta(G) = \min_{v \in V(G)} \{\delta_G(v)\}$  and  $\Delta(G) = \max_{v \in V(G)} \{\delta_G(v)\}$ . We say that a vertex  $v \in V(G)$  is *universal* if  $N_G[v] = V(G)$ . For a set  $S \subseteq V(G)$ , its open neighborhood is the set  $N_G(S) = \cup_{v \in S} N_G(v)$ , and its closed neighborhood is the set  $N_G[S] = N_G(S) \cup S$ .

The *private neighborhood*  $pn_G(v, S)$  of  $v \in S \subseteq V(G)$  is defined by  $pn_G(v, S) = \{u \in V(G) : N_G(u) \cap S = \{v\}\}$ . Each vertex in  $pn_G(v, S)$  is called a *private neighbor* of  $v$  with respect to  $S$ . The *external private neighborhood*  $epn_G(v, S)$  consists of those private neighbors of  $v$  in  $V(G) \setminus S$ . Hence,  $epn_G(v, S) = pn_G(v, S) \cap (V(G) \setminus S)$ .

For any two vertices  $u$  and  $v$ , the *distance*  $d_G(u, v)$  between  $u$  and  $v$  is the minimum length of a  $u - v$  path. The *diameter* of  $G$ , denoted by  $diam(G)$ , is the maximum distance among pairs of vertices of  $G$ . A *diametral path* in  $G$  is a shortest path whose length equals the diameter of the graph. Thus, a diametral path in  $G$  is a shortest path joining two vertices that are at distance  $diam(G)$  from each other (such vertices are called diametral vertices). From now on, we shall skip the subindex  $G$  in all the notations above, whenever the graph  $G$  is clear from the context.

Given a set of vertices  $S \subseteq V(G)$ , by  $G - S$  we denote the graph obtained from  $G$  by removing all the vertices of  $S$  and all the edges incident with a vertex in  $S$  (if  $S = \{v\}$ , for some vertex  $v$ , then we simply write  $G - v$ ).

A *leaf* vertex of  $G$  is a vertex of degree one. A *support* vertex of  $G$  is a vertex adjacent to a leaf vertex, a *strong support* vertex is a support vertex adjacent to at least two leaves, a *strong leaf* vertex is a leaf vertex adjacent to a strong support vertex, and a *semi-support* vertex is a vertex adjacent to a support vertex that is not a leaf. The set of leaves is denoted by  $L(G)$ ; the set of support vertices is denoted by  $S(G)$ ; the set of strong support vertices is denoted by  $S_s(G)$ ; the set of strong leaves is denoted by  $L_s(G)$ ; and the set of semi-support vertices is denoted by  $SS(G)$ .

A *tree*  $T$  is an acyclic connected graph. A *rooted tree*  $T$  is a tree with a distinguished special vertex  $r$ , called the root. For each vertex  $v \neq r$  of  $T$ , the *parent* of  $v$  is the neighbor of  $v$  on the unique  $r - v$  path, while a *child* of  $v$  is any other neighbor of  $v$ . A *descendant* of  $v$  is a vertex  $u \neq v$  such that the unique  $r - u$  path contains  $v$ . Thus, every child of  $v$  is a descendant of  $v$ . The set of descendants of  $v$  is denoted by  $D(v)$ , and we define  $D[v] = D(v) \cup \{v\}$ . The *maximal subtree* at  $v$  is the subtree of  $T$  induced by  $D[v]$ , and is denoted by  $T_v$ .

We will use the notation  $K_n$ ,  $N_n$ ,  $K_{1,n-1}$ ,  $P_n$  and  $C_n$  for complete graphs, empty graphs, star graphs, path graphs and cycle graphs of order  $n$ , respectively. Given two graphs  $G$  and  $H$ , the *corona product*  $G \odot H$  is defined as the graph obtained from  $G$  and  $H$  by taking one copy of  $G$  and  $|V(G)|$  copies of  $H$ , and joining by an edge each vertex of the  $i^{th}$ -copy of  $H$  with the  $i^{th}$ -vertex of  $G$ . For the remainder of the article, definitions will be introduced whenever a concept is needed.

## 2 Combinatorial results

We begin this section with two inequality chains relating the domination number, the total domination number, the total Roman domination number, the Roman  $\{2\}$ -domination number, the double domination number and the total Roman  $\{2\}$ -domination number. We must remark that the last inequality in the first item is a well known result (see [1]). We include it in the result to have a complete vision of the relationship between our parameter and the total domination number.

**Proposition 2.1.** *The following inequalities hold for any graph  $G$  without isolated vertices.*

- (i)  $\gamma_t(G) \leq \gamma_{t\{R2\}}(G) \leq \gamma_{tR}(G) \leq 2\gamma_t(G)$ , ( $\gamma_{tR}(G) \leq 2\gamma_t(G)$  is from [1]).
- (ii)  $\gamma_{\{R2\}}(G) \leq \gamma_{t\{R2\}}(G) \leq \gamma_{\times 2}(G)$ .

*Proof.* It was shown in [1] that  $\gamma_{tR}(G) \leq 2\gamma_t(G)$ . To conclude the proof of (i), we only need to observe that any TR2DF is a TDF, which implies that  $\gamma_t(G) \leq \gamma_{t\{R2\}}(G)$ , and any TRDF is a TR2DF, which implies that  $\gamma_{t\{R2\}}(G) \leq \gamma_{tR}(G)$ .

Now, to prove (ii), we only need to observe that any DDF is a TR2DF, which implies that  $\gamma_{t\{R2\}}(G) \leq \gamma_{\times 2}(G)$  and any TR2DF is a R2DF, which implies that  $\gamma_{\{R2\}}(G) \leq \gamma_{t\{R2\}}(G)$ .  $\square$

The following result provides equivalent conditions for the graphs where the left hand side inequality of Proposition 2.1 (i) is achieved. Note that it has a simple proof, but we however prefer include it to have a more complete exposition.

**Remark 2.2.** *For any graph  $G$ , the following statements are equivalent.*

- (a)  $\gamma_{t\{R2\}}(G) = \gamma_t(G)$ .
- (b)  $\gamma_{\times 2}(G) = \gamma_t(G)$ .

*Proof.* Suppose that (a) holds and let  $f(V_0, V_1, V_2)$  be a  $\gamma_{t\{R2\}}(G)$ -function. Since  $f$  is a TDF,  $\gamma_t(G) \leq |V_1 \cup V_2| = |V_1| + |V_2| \leq |V_1| + 2|V_2| = \gamma_{t\{R2\}}(G) = \gamma_t(G)$ . So  $V_2 = \emptyset$ , which implies that  $f$  is a DDF of weight  $\omega(f) = \gamma_t(G)$ . Hence, (b) holds. Finally, it is straightforward to observe that (b) implies (a).  $\square$

We continue by showing a simple relationship between the total Roman  $\{2\}$ -domination number, the domination number and the total domination number. Since  $\gamma(G) \leq \gamma_t(G)$  for any graph  $G$ , we notice that the following result improves the last upper bound of Proposition 2.1 (i).

**Theorem 2.3.** *For any graph  $G$  without isolated vertices,  $\gamma_{t\{R2\}}(G) \leq \gamma_t(G) + \gamma(G)$ .*

*Proof.* Let  $D$  be a  $\gamma_t(G)$ -set and let  $S$  be a  $\gamma(G)$ -set. We define the function  $f(V_0, V_1, V_2)$  on  $G$ , where  $V_2 = D \cap S$  and  $V_1 = (D \cup S) \setminus V_2$ . Notice that  $f$  is a TR2DF on  $G$  of weight  $\omega(f) = 2|V_2| + |V_1| = |D| + |S| = \gamma_t(G) + \gamma(G)$ . Therefore, the result follows.  $\square$

The following result is an immediate consequence of the remark above and the well-know inequality  $\gamma_t(G) \leq 2\gamma(G)$  (see [15]).

**Corollary 2.4.** *For any graph  $G$  without isolated vertices,  $\gamma_{t\{R2\}}(G) \leq 3\gamma(G)$ .*

We remark that the upper bound of Theorem 2.3 is sharp. For example, for an integer  $s \geq 1$ , let  $H_s$  be the graph obtained from  $P_3$  and  $N_1$  by taking one copy of  $N_1$  and  $s$  copies of  $P_3$ , and joining by an edge the support vertex of each copy of  $P_3$  with the vertex of  $N_1$ . It is easy to check that  $\gamma(H_s) = s$ ,  $\gamma_t(H_s) = s + 1$  and  $\gamma_{t\{R2\}}(H_s) = 2s + 1 = \gamma_t(H_s) + \gamma(H_s)$ . The graph  $H_3$ , for example, is illustrated in Figure 2.

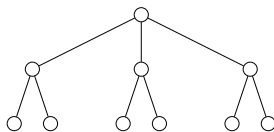

Figure 2: The graph  $H_3$ .

From Proposition 2.1 and Theorem 2.3, we immediately obtain that  $\gamma_t(G) = \gamma(G)$  is a necessary condition for a graph  $G$  to satisfy  $\gamma_{t\{R2\}}(G) = 2\gamma_t(G)$ . However, this condition is not sufficient, for example, the cycle graph  $C_4$  satisfies that  $\gamma_t(C_4) = \gamma(C_4) = 2$  and  $\gamma_{t\{R2\}}(C_4) = 3 < 4 = 2\gamma_t(C_4)$ .

The following result provides an equivalent condition for the graphs  $G$  which satisfy the equality  $\gamma_{t\{R2\}}(G) = 2\gamma_t(G)$ . Before we shall need the following known result.

**Theorem 2.5.** [1] *If  $G$  is a graph with no isolated vertex, then  $2\gamma(G) \leq \gamma_{tR}(G)$ .*

**Theorem 2.6.** *Let  $G$  be a graph. Then  $\gamma_{t\{R2\}}(G) = 2\gamma_t(G)$  if and only if  $\gamma_{tR}(G) = \gamma_{tR}(G)$  and  $\gamma_t(G) = \gamma(G)$ .*

*Proof.* Assume that  $\gamma_{t\{R2\}}(G) = 2\gamma_t(G)$ . Hence, Proposition 2.1 leads to  $\gamma_{t\{R2\}}(G) = \gamma_{tR}(G)$ . Also, by Theorem 2.3 and the known inequality  $\gamma(G) \leq \gamma_t(G)$ , we obtain that  $2\gamma_t(G) = \gamma_{t\{R2\}}(G) \leq \gamma_t(G) + \gamma(G) \leq 2\gamma_t(G)$ . Therefore, we must have equality throughout the inequality chain above. In particular,  $\gamma_t(G) = \gamma(G)$ .

On the other hand, we assume that  $\gamma_{t\{R2\}}(G) = \gamma_{tR}(G)$  and  $\gamma_t(G) = \gamma(G)$ . By the equalities above, Theorem 2.5 and Proposition 2.1, we obtain that  $2\gamma_t(G) = 2\gamma(G) \leq \gamma_{tR}(G) = \gamma_{t\{R2\}}(G) \leq 2\gamma_t(G)$ . Therefore  $\gamma_{t\{R2\}}(G) = 2\gamma_t(G)$ .  $\square$

Notice that the inequality  $\gamma_{t\{R2\}}(G) \leq 3\gamma(G)$  can be also deduced from the following result.

**Theorem 2.7.** *For any graph  $G$  without isolated vertices,  $\gamma_{t\{R2\}}(G) \leq \gamma_{\{R2\}}(G) + \gamma(G)$ .*

*Proof.* Let  $f(V_0, V_1, V_2)$  be a  $\gamma_{\{R2\}}(G)$ -function and let  $S$  be a  $\gamma(G)$ -set. Now, we consider the function  $f'(V'_0, V'_1, V'_2)$  defined as follows.



- (a) For every  $x \in (V_1 \cup V_2) \cap S$ , choose a vertex  $u \in (V_0 \cap N(x)) \setminus S$  if it exists, and label it as  $f'(u) = 1$ .
- (b) For every vertex  $x \in V_0 \cap S$ ,  $f'(x) = 1$ .
- (c) For any other vertex  $u$  not previously labelled,  $f'(u) = f(u)$ .

Since  $f$  is a R2DF, by definition,  $f'$  is a R2DF as well. Observe that  $f'$  is also a TDF on  $G$ . Thus,  $f'$  is a TR2DF on  $G$ , and therefore,  $\gamma_{t\{R2\}}(G) \leq \omega(f') \leq \gamma_{\{R2\}}(G) + \gamma(G)$ .  $\square$

The bound above is tight. For instance, it is achieved for the star graph  $K_{1,n-1}$ , where  $n \geq 3$ .

**Corollary 2.8.** *For any graph  $G$  without isolated vertices,  $\gamma_{t\{R2\}}(G) \leq 2\gamma_{\{R2\}}(G)$ . Furthermore, if  $\gamma_{\{R2\}}(G) > \gamma(G)$ , then  $\gamma_{t\{R2\}}(G) \leq 2\gamma_{\{R2\}}(G) - 1$ .*

In connection with the sharpness of the latter bound of the corollary above, we observe that every graph  $G$  having exactly one universal vertex satisfies that  $\gamma_{t\{R2\}}(G) = 2\gamma_{\{R2\}}(G) - 1$ .

The next result establishes the existence of a  $\gamma_{t\{R2\}}(G)$ -function which satisfies a useful property.

**Proposition 2.9.** *For any graph  $G$  without isolated vertices, there exists a  $\gamma_{t\{R2\}}(G)$ -function  $f(V_0, V_1, V_2)$  such that either  $V_2 = \emptyset$  or every vertex of  $V_2$  has at least two private neighbors in  $V_0$  with respect to the set  $V_1 \cup V_2$ .*

*Proof.* Let  $f(V_0, V_1, V_2)$  be a  $\gamma_{t\{R2\}}(G)$ -function satisfying that  $|V_2|$  is minimum. Clearly, if  $|V_2| = 0$ , then we are done. Hence, let  $v \in V_2$ . If  $epn(v, V_1 \cup V_2) = \emptyset$ , then the function  $f'$ , defined by  $f'(v) = 1$  and  $f'(x) = f(x)$  whenever  $x \in V(G) \setminus \{v\}$ , is a TR2DF on  $G$ , which is a contradiction, and so,  $epn(v, V_1 \cup V_2) \neq \emptyset$ . If  $epn(v, V_1 \cup V_2) = \{u\}$ , then the function  $f''$ , defined by  $f''(v) = f''(u) = 1$  and  $f''(x) = f(x)$  whenever  $x \in V(G) \setminus \{v, u\}$ , is a TR2DF on  $G$ , which is a contradiction as well. Thus,  $|epn(v, V_1 \cup V_2)| \geq 2$ , which completes the proof.  $\square$

**Corollary 2.10.** *For every graph  $G$  without isolated vertices and maximum degree  $\Delta(G) \leq 2$ ,*

$$\gamma_{t\{R2\}}(G) = \gamma_{\times 2}(G).$$

From Corollary 2.10, and the following values of  $\gamma_{\times 2}(P_n)$  and  $\gamma_{\times 2}(C_n)$  obtained in [3] and [12] respectively, we obtain our next result.

$$\gamma_{\times 2}(P_n) = \begin{cases} 2 \lceil \frac{n}{3} \rceil + 1, & \text{if } n \equiv 0 \pmod{3}, \\ 2 \lceil \frac{n}{3} \rceil, & \text{otherwise.} \end{cases} \quad \text{and} \quad \gamma_{\times 2}(C_n) = \left\lceil \frac{2n}{3} \right\rceil.$$

**Remark 2.11.** *For any positive integer  $n \geq 2$ ,*

$$(i) \quad \gamma_{t\{R2\}}(P_n) = \begin{cases} 2 \lceil \frac{n}{3} \rceil + 1, & \text{if } n \equiv 0 \pmod{3}, \\ 2 \lceil \frac{n}{3} \rceil, & \text{otherwise.} \end{cases}$$

$$(ii) \quad \gamma_{t\{R2\}}(C_n) = \lceil \frac{2n}{3} \rceil.$$

Our next contribution shows another relationship between our parameter and the total domination number, but we now also use the order of the graph.

**Theorem 2.12.** *For any graph  $G$  of order  $n$  and  $\delta(G) \geq 2$ ,*

$$\gamma_{t\{R2\}}(G) \leq \left\lfloor \frac{\gamma_t(G) + n}{2} \right\rfloor.$$

*Proof.* Let  $D$  be a  $\gamma_t(G)$ -set, let  $I$  be the set of isolated vertices in  $\langle V(G) \setminus D \rangle$  and let  $S$  be a  $\gamma(\langle V(G) \setminus (D \cup I) \rangle)$ -set. In addition, let  $f(V_0, V_1, \emptyset)$  be a function defined by  $V_1 = D \cup S$  and  $V_0 = V(G) \setminus V_1$ . Since  $D$  is a TDS of  $G$ , we have that  $V_1 = D \cup S$  is a TDS as well. Furthermore, every vertex  $u \in V(G) \setminus (D \cup S)$  is dominated by at least two vertices of  $V_1$ . Hence,  $V_1$  is a double dominating set of  $G$ , which implies that  $f$  is a TR2DF on  $G$ . Thus,  $\gamma_{t\{R2\}}(G) \leq |V_1| = |D \cup S| = |D| + |S|$ . Now, since  $\langle V(G) \setminus (D \cup I) \rangle$  is a graph without isolated vertices, we have that  $|S| = \gamma(\langle V(G) \setminus (D \cup I) \rangle) \leq \frac{|V(G) \setminus (D \cup I)|}{2} \leq \frac{|V(G) \setminus D|}{2} = \frac{n - \gamma_t(G)}{2}$ . Therefore,  $\gamma_{t\{R2\}}(G) \leq \lfloor \frac{\gamma_t(G) + n}{2} \rfloor$ , which completes the proof.  $\square$

To see the tightness of the bound above we consider for instance the Cartesian product graph  $P_2 \square P_3$ . Also, a consequence of such theorem above is next stated. This is also based on the fact that for any graph  $G$  with  $\delta(G) \geq 3$ ,  $\gamma_t(G) \leq \frac{|V(G)|}{2}$ .

**Proposition 2.13.** *For any graph  $G$  of order  $n$  and  $\delta(G) \geq 3$ ,*

$$\gamma_{t\{R2\}}(G) \leq \frac{3n}{4}.$$

Given a graph  $G$  and an edge  $e \in E(G)$ , the graph obtained from  $G$  by removing the edge  $e$  will be denoted by  $G - e$ . Notice that any  $\gamma_{t\{R2\}}(G - e)$ -function is a TR2DF on  $G$ . Therefore, the following basic result follows.

**Observation 2.14.** *If  $H$  is a spanning subgraph (without isolated vertices) of a graph  $G$ , then  $\gamma_{t\{R2\}}(G) \leq \gamma_{t\{R2\}}(H)$ .*

From Remark 2.11 and Observation 2.14, we obtain the following result.

**Proposition 2.15.** *Let  $G$  be a graph of order  $n$ .*

- *If  $G$  is a Hamiltonian graph, then  $\gamma_{t\{R2\}}(G) \leq 2 \lceil \frac{n}{3} \rceil$ .*
- *If  $G$  has a Hamiltonian path, then  $\gamma_{t\{R2\}}(G) \leq 2 \lceil \frac{n}{3} \rceil + 1$ .*

Clearly, the bounds above are tight, as they are achieved for  $C_n$  and  $P_n$  with  $n \equiv 0 \pmod{3}$ , respectively.

We now proceed to characterize all graphs achieving the limit cases of the trivial bounds  $2 \leq \gamma_{t\{R2\}}(G) \leq n$ . For this purpose, we shall need the following theorem.

**Theorem 2.16.** [12] *Let  $G$  be a graph without isolated vertices. Then  $\gamma_{\times 2}(G) = 2$  if and only if  $G$  has two universal vertices.*

**Theorem 2.17.** *Let  $G$  be a graph without isolated vertices. Then  $\gamma_{t\{R2\}}(G) = 2$  if and only if  $G$  has two universal vertices.*

*Proof.* Notice that  $\gamma_{t\{R2\}}(G) = 2$  directly implies  $\gamma_{\times 2}(G) = 2$ . Hence, by Theorem 2.16,  $G$  has two universal vertices. The other hand it is straightforward to see.  $\square$

We next proceed to characterize all graphs  $G$  with  $\gamma_{t\{R2\}}(G) = 3$ . For this purpose, we consider the next family of graphs. Let  $\mathcal{H}$  be the family of graphs  $H$  of order  $n \geq 3$  such that the subgraph induced by three vertices of  $H$  is  $P_3$  or  $C_3$  and the remaining  $n - 3$  vertices have minimum degree two and they induce an empty graph.

**Theorem 2.18.** *Let  $G$  be a connected graph of order  $n$ . Then  $\gamma_{t\{R2\}}(G) = 3$  if and only if there exists  $H \in \mathcal{H} \cup \{K_{1,n-1}\}$  which is a spanning subgraph of  $G$  and  $G$  has as most one universal vertex.*

*Proof.* We first suppose that  $\gamma_{t\{R2\}}(G) = 3$ . Let  $f(V_0, V_1, V_2)$  be a  $\gamma_{t\{R2\}}(G)$ -function. By Theorem 2.17,  $G$  has at most one universal vertex. If  $|V_2| = 1$ , then  $|V_1| = 1$ . Let  $V_1 = \{v\}$  and  $V_2 = \{w\}$ . Notice that  $v$  and  $w$  are adjacent vertices. Since  $f$  is a TR2DF, any vertex must be adjacent to  $w$ , concluding that  $K_{1,n-1}$  is a spanning subgraph of  $G$ . Now, if  $|V_2| = 0$ , then  $|V_1| = 3$ . As  $V_1$  is a TDS, the subgraph induced by  $V_1$  is  $P_3$  or  $C_3$ . Since  $f$  is a TR2DF, we observe that  $|N(x) \cap V_1| \geq 2$  for every  $x \in V_0$ . Hence, in this case,  $G$  contains a spanning subgraph belonging to  $\mathcal{H}$ .

Conversely, let  $G$  be a connected graph of order  $n$  containing a graph  $H \in \mathcal{H} \cup \{K_{1,n-1}\}$  as a spanning subgraph. Notice that we can construct a TR2DF  $g$  satisfying that  $\omega(g) = 3$ . Hence  $\gamma_{t\{R2\}}(G) \leq \omega(g) = 3$ . Moreover, since  $G$  has at most one universal vertex, by Theorem 2.17 we have that  $\gamma_{t\{R2\}}(G) \geq 3$ , which completes the proof.  $\square$

**Theorem 2.19.** *Let  $G$  be a connected graph of order  $n$ . Then  $\gamma_{t\{R2\}}(G) = n$  if and only if  $G$  is  $P_3$  or  $H \odot N_1$  for some connected graph  $H$ .*

*Proof.* If  $G$  is  $P_3$  or  $H \odot N_1$  for some connected graph  $H$ , then it is straightforward to see that  $\gamma_{t\{R2\}}(G) = n$ . From now on we assume that  $G$  is a connected graph such that  $\gamma_{t\{R2\}}(G) = n$ . If  $n = 2$ , then  $G \cong P_2 \cong N_1 \odot N_1$ , and if  $n = 3$ , then  $G \cong P_3$ . Hence, we consider that  $n \geq 4$ . Suppose there exists a vertex  $v \notin L(G) \cup S(G)$ . Notice that the function  $f$ , defined by  $f(v) = 0$  and  $f(x) = 1$  whenever  $x \in V(G) \setminus \{v\}$ , is a TR2DF of weight  $\omega(f) = n - 1$ , which is a contradiction. Thus  $V(G) = L(G) \cup S(G)$ .

Now, suppose there exists a vertex  $u \in S_s(G)$  and let  $h_1, h_2$  be two leaves adjacent to  $u$ . We consider the function  $g$  defined by  $g(h_1) = g(h_2) = 0$ ,  $g(u) = 2$  and  $g(x) = 1$  whenever  $x \in V(G) \setminus \{u, h_1, h_2\}$ . Hence,  $g$  is a TR2DF of weight  $\omega(g) = n - 1$ , which is again a contradiction. Thus  $S_s(G) = \emptyset$  and, as a consequence,  $G \cong H \odot N_1$  for some connected graph  $H$ .  $\square$

Based on the trivial bound  $2 \leq \gamma_{t\{R2\}}(G) \leq n$  and the characterizations above, it is natural to think into the existence of graphs achieving all the other possible values in the range given by such bounds for  $\gamma_{t\{R2\}}(G)$ . That is made in our next result, and for it, we need two previous observations that appear first.

**Observation 2.20.** *For any connected graph  $G$  containing two adjacent support vertices  $v$  and  $w$ , there exists a  $\gamma_{t\{R2\}}(G)$ -function  $f$  satisfying  $f(v) = f(w) = 2$ .*

**Observation 2.21.** *Let  $G$  be a connected graph different from a star graph. If  $v \in S_s(G)$ , then there exists a  $\gamma_{t\{R2\}}(G)$ -function ( $\gamma_{tR}(G)$ -function)  $f$  satisfying that  $f(v) = 2$  and  $f(N(v) \cap L(G)) = 0$ .*

**Proposition 2.22.** *For any integers  $r, n$  with  $3 < r < n$ , there exists a graph  $F_{r,n}$  of order  $n$  such that  $\gamma_{t\{R2\}}(F_{r,n}) = r$ .*

*Proof.* If  $r$  is even, then we consider a graph  $F_{r,n}$  constructed as follows. We begin with a corona product graph  $H \odot N_1$  of order  $|V(H \odot N_1)| = r$  and  $n - r$  isolated vertices. To obtain  $F_{r,n}$ , we join (by an edge) one vertex  $v$  of  $H$  to each one of the  $n - r$  isolated vertices. Notice that  $F_{r,n}$  has order  $n$ . By Observation 2.20, the function  $f$ , defined by  $f(x) = 2$  if  $x \in V(H)$  and  $f(x) = 0$  if  $x \in V(F_{r,n}) \setminus V(H)$ , is a  $\gamma_{t\{R2\}}(F_{r,n})$ -function and so,  $\gamma_{t\{R2\}}(F_{r,n}) = \omega(f) = r$ .

On the other hand, if  $r$  is odd, we construct a graph  $F_{r,n}$  as follows. We begin with a corona product graph  $H \odot N_1$  of order  $|V(H \odot N_1)| = r - 3$  and a star graph  $K_{1,n-r+2}$ . To obtain  $F_{r,n}$ , we join (by an edge) one vertex  $v$  of  $H$  to one leaf, namely  $h$ , of the star  $K_{1,n-r+2}$ . Hence,  $F_{r,n}$  has order  $n$ . Now, we consider the function  $f$ , defined by  $f(h) = 1$ ,  $f(x) = 2$  if  $x \in S(F_{r,n})$  and  $f(x) = 0$  otherwise. Notice that  $f$  is a TR2DF on  $F_{r,n}$  and so,  $\gamma_{t\{R2\}}(F_{r,n}) \leq \omega(f) = r$ .

Let  $v$  be the support vertex of  $K_{1,n-r+2}$ . Since  $|V(K_{1,n-r+2})| \geq 4$ ,  $v \in S_s(F_{r,n})$ . By Observation 2.21, there exists a  $\gamma_{t\{R2\}}(F_{r,n})$ -function  $g(V_0, V_1, V_2)$  such that  $g(v) = 2$  and  $g(x) = 0$  if  $x \in N(v) \cap L(F_{r,n})$ . Hence  $g(h) \geq 1$  because  $V_1 \cup V_2$  is a TDS of  $F_{r,n}$ . Moreover, notice that the function  $g$  restricted to  $V(H \odot N_1)$ , say  $g'$ , is a TR2DF on  $H \odot N_1$ . So, by statement above and Theorem 2.19,  $\omega(g') \geq \gamma_{t\{R2\}}(H \odot N_1) = r - 3$ . Therefore,  $\gamma_{t\{R2\}}(F_{r,n}) = \omega(g) = g(N[v]) + \omega(g') \geq 3 + r - 3 = r$ . Consequently, it follows that  $\gamma_{t\{R2\}}(F_{r,n}) = r$  and the proof is complete.  $\square$

## 2.1 Trees $T$ with $\gamma_{t\{R2\}}(T) = \gamma_{tR}(T)$

We begin this subsection with a theoretical characterization of the graphs  $G$  satisfying the equality  $\gamma_{t\{R2\}}(G) = \gamma_{tR}(G)$ .

**Theorem 2.23.** *Let  $G$  be a graph. Then  $\gamma_{t\{R2\}}(G) = \gamma_{tR}(G)$  if and only if there exists a  $\gamma_{t\{R2\}}(G)$ -function  $f(V_0, V_1, V_2)$  such that  $V_{0,1} = \emptyset$ .*

*Proof.* Suppose that  $\gamma_{t\{R2\}}(G) = \gamma_{tR}(G)$ . Let  $f(V_0, V_1, V_2)$  be a  $\gamma_{tR}(G)$ -function. Since every TRDF is a TR2DF,  $f$  is a  $\gamma_{t\{R2\}}(G)$ -function as well, and satisfies that  $V_{0,1} = \emptyset$ . Conversely, suppose there exists a  $\gamma_{t\{R2\}}(G)$ -function  $f'(V'_0, V'_1, V'_2)$  such that  $V'_{0,1} = \emptyset$ . So,  $V'_0 = V'_{0,2}$ , which

implies that  $f'$  is a TRDF on  $G$ . Thus,  $\gamma_{tR}(G) \leq \omega(f') = \gamma_{t\{R2\}}(G)$ . Hence, Proposition 2.1 leads to  $\gamma_{t\{R2\}}(G) = \gamma_{tR}(G)$ .  $\square$

The characterization above clearly lacks of usefulness since it precisely depends on finding a  $\gamma_{t\{R2\}}(G)$ -function which satisfies a specific condition. In that sense, it appears an open problem to characterize the graphs  $G$  which satisfy the equality  $\gamma_{t\{R2\}}(G) = \gamma_{tR}(G)$ . In this subsection we give a partial solution to this problem for the particular case of trees. To this end, we require the next results and extra definitions.

**Observation 2.24.** *Let  $G$  be a connected graph. If  $v \in S_s(G)$ , then there exists a  $\gamma_{t\{R2\}}(G)$ -function ( $\gamma_{tR}(G)$ -function)  $f$  satisfying that  $f(v) = 2$  and  $f(h) = 0$  for some vertex  $h \in N(v) \cap L(G)$ .*

**Observation 2.25.** *If  $T'$  is a subtree of a tree  $T$ , then  $\gamma_{t\{R2\}}(T') \leq \gamma_{t\{R2\}}(T)$  and  $\gamma_{tR}(T') \leq \gamma_{tR}(T)$ .*

By an *isolated support vertex* of  $G$  we mean an isolated vertex of the subgraph induced by the support vertices of  $G$ . The set of non isolated support vertices of  $G$  is denoted by  $S_{adj}(G)$ .

The set of support vertices of  $G$  labelled with two by some  $\gamma_{tR}(G)$ -function is denoted by  $S_{tR,2}(G)$ . The set of leaves of  $G$  labelled with one by some  $\gamma_{tR}(G)$ -function is denoted by  $L_{tR,1}(G)$ . The set of vertices of  $G$  labelled with zero by all  $\gamma_{t\{R2\}}(G)$ -functions is denoted by  $W_0(G)$ . The set of support vertices of  $G$  labelled with one by all  $\gamma_{t\{R2\}}(G)$ -functions is denoted by  $S_1(G)$ .

For an integer  $r \geq 1$ , the graph  $R_r$  is defined as the graph obtained from  $P_4$  and  $N_1$  by taking one copy of  $N_1$  and  $r$  copies of  $P_4$  and joining by an edge one support vertex of each copy of  $P_4$  with the vertex of  $N_1$ . In Figure 3 we show the example of  $R_3$ .

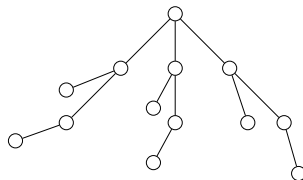

Figure 3: The structure of the tree  $R_3$ .

A *near total Roman  $\{2\}$ -dominating function relative to a vertex  $v$* , abbreviated near-TR2DF relative to  $v$ , on a graph  $G$ , is a function  $f(V_0, V_1, V_2)$  satisfying the following.

- For each vertex  $u \in V_0$ , if  $u = v$ , then  $\sum_{u \in N(v)} f(u) \geq 1$ , while if  $u \neq v$ , then  $\sum_{u \in N(v)} f(u) \geq 2$ .
- The subgraph induced by  $V_1 \cup V_2$  has no isolated vertex.

The weight of a near-TR2DF relative to  $v$  on  $G$  is the value  $f(V(G)) = \sum_{u \in V(G)} f(u)$ . The minimum weight of a near-TR2DF relative to  $v$  on  $G$  is called the *near total Roman  $\{2\}$ -domination number relative to  $v$  of  $G$* , which we denote as  $\gamma_{t\{R2\}}^n(G; v)$ . Since every TR2DF is a near-TR2DF, we note that  $\gamma_{t\{R2\}}^n(G; v) \leq \gamma_{t\{R2\}}(G)$  for any vertex  $v$  of  $G$ . We define a vertex  $v \in V(G)$  to be a *near stable vertex* of  $G$  if  $\gamma_{t\{R2\}}^n(G; v) = \gamma_{t\{R2\}}(G)$ . For example, every leaf of any star  $K_{1,n-1}$  with  $n \geq 4$ , is a near stable vertex. We remark that the terminology of “near” style parameters is a commonly used technique in domination theory. In order to simply mention a recently published example where this was used, we can for instance refer to [16].

Now on, in order to provide a constructive characterization for the trees which achieve the stated equality in Theorem 2.23, we consider the next family of trees. Let  $\mathcal{F}$  be the family of trees  $T$  that can be obtained from a sequence of trees  $T_0, \dots, T_k$ , where  $k \geq 0$ ,  $T_0 \cong P_2$  and  $T \cong T_k$ . Furthermore, if  $k \geq 1$ , then for each  $i \in \{1, \dots, k\}$ , the tree  $T_i$  can be obtained from the tree  $T' \cong T_{i-1}$  by one of the following operations  $F_1, F_2, F_3, F_4, F_5, F_6$  or  $F_7$ . In such operations, by a join of two vertices we mean adding an edge between these two vertices.

**Operation  $F_1$ :** Add a tree  $R_r$  with semi-support vertex  $u$ , and join  $u$  to an arbitrary vertex  $v$  of  $T'$ .

**Operation  $F_2$ :** Add a new vertex  $u$  to  $T'$  and join  $u$  to a vertex  $v \in S_{tR,2}(T')$ .

**Operation  $F_3$ :** Add a new vertex  $u$  to  $T'$  and join  $u$  to a vertex  $v \in S_1(T')$ .

**Operation  $F_4$ :** Add a path  $P_2$  and join a leaf to a vertex  $v \in S_{adj}(T')$ .

**Operation  $F_5$ :** Add a path  $P_3$  with support vertex  $u$ , and identify  $u$  with a vertex  $v \in L_{tR,1}(T')$ .

**Operation  $F_6$ :** Add a path  $P_2$ , and join a leaf to a near stable vertex  $v \in L(T') \cup SS(T')$ .

**Operation  $F_7$ :** Add a path  $P_3$ , and join a leaf to a vertex  $v \in W_0(T')$ .

We next show that every tree  $T$  in the family  $\mathcal{F}$  satisfies that  $\gamma_{t\{R2\}}(T) = \gamma_{tR}(T)$ .

**Theorem 2.26.** *If  $T \in \mathcal{F}$ , then  $\gamma_{t\{R2\}}(T) = \gamma_{tR}(T)$ .*

*Proof.* We proceed by induction on the number  $r(T)$  of operations required to construct the tree  $T$ . If  $r(T) = 0$ , then  $T \cong P_2$  and satisfies that  $\gamma_{t\{R2\}}(T) = 2 = \gamma_{tR}(T)$ . This establishes the base case. Hence, we now assume that  $k \geq 1$  is an integer and that each tree  $T' \in \mathcal{F}$  with  $r(T') < k$  satisfies that  $\gamma_{t\{R2\}}(T') = \gamma_{tR}(T')$ . Let  $T \in \mathcal{F}$  be a tree with  $r(T) = k$ . Then,  $T$  can be obtained from a tree  $T' \in \mathcal{F}$  with  $r(T') = k - 1$  by one of the seven operations above. We shall prove that  $T$  satisfies that  $\gamma_{t\{R2\}}(T) = \gamma_{tR}(T)$ . We consider seven cases, depending on which operation is used to construct the tree  $T$  from  $T'$ .

**Case 1.**  $T$  is obtained from  $T'$  by Operation  $F_1$ . Assume  $T$  is obtained from  $T'$  by adding a tree  $R_r$ , being  $u$  the semi-support vertex, and the edge  $uv$  where  $v$  is an arbitrary vertex of  $T'$ .

Observe that, from any TRDF on  $T'$ , we can obtain a TRDF on  $T$  by assigning the weight two to each support vertex and zero to another vertices of  $R_r$ . Hence, by Proposition 2.1, statement above and inductive hypothesis, we obtain

$$\gamma_{t\{R2\}}(T) \leq \gamma_{tR}(T) \leq \gamma_{tR}(T') + 4r = \gamma_{t\{R2\}}(T') + 4r. \quad (1)$$

Since  $S(R_r) = S_{adj}(R_r)$ , by using Observation 2.20, there exists a  $\gamma_{t\{R2\}}(T)$ -function  $f$  satisfying that  $f(x) = 2$  for every  $x \in S(R_r)$ . As a consequence,  $f(h) = 0$  for every vertex  $h \in L(R_r)$ .

If  $f(u) = 0$ , then  $f$  restricted to  $V(T')$  is a TR2DF on  $T'$ , implying that  $\gamma_{t\{R2\}}(T') \leq f(V(T')) = \omega(f) - f(V(R_r)) = \gamma_{t\{R2\}}(T) - 4r$ , and by the inequality chain (1) it follows that  $\gamma_{t\{R2\}}(T) = \gamma_{tR}(T)$ .

Let  $w \in N(v) \setminus \{u\}$  be a vertex such that  $f(w) = \max\{f(x) : x \in N(v) \setminus \{u\}\}$ . If  $f(u) > 0$ , then the function  $g$ , defined by  $g(v) = \max\{f(v), f(v)f(w) + 1\}$ , (note that in any possibility, this maximum expression can never take a value larger than two),  $g(w) = \max\{1, f(w)\}$ ,  $g(u) = 0$  and  $g(x) = f(x)$  whenever  $x \in V(T) \setminus \{v, w, u\}$ , is a TR2DF on  $T$  with weight  $\omega(g) = \omega(f) = \gamma_{t\{R2\}}(T)$ . So,  $g$  is a  $\gamma_{t\{R2\}}(T)$ -function as well. As  $g(u) = 0$ ,  $g$  restricted to  $V(T')$  is a TR2DF on  $T'$  and, by using a similar reasoning as in the previous case ( $f(u) = 0$ ), we obtain that  $\gamma_{t\{R2\}}(T) = \gamma_{tR}(T)$ .

**Case 2.**  $T$  is obtained from  $T'$  by Operation  $F_2$ . Assume  $T$  is obtained from  $T'$  by adding a new vertex  $u$  and the edge  $uv$ , where  $v \in S_{tR,2}(T')$ . Hence, there exists a  $\gamma_{tR}(T')$ -function  $f$  satisfying that  $f(v) = 2$ . Notice that  $f$  can be extended to a TRDF on  $T$  by assigning the weight 0 to  $u$ , which implies that  $\gamma_{tR}(T) \leq \gamma_{tR}(T')$ . By using Proposition 2.1, inequality above, inductive hypothesis and Observation 2.25, we obtain  $\gamma_{t\{R2\}}(T) \leq \gamma_{tR}(T) \leq \gamma_{tR}(T') = \gamma_{t\{R2\}}(T') \leq \gamma_{t\{R2\}}(T)$ . Therefore, we must have equality throughout the inequality chain above. In particular,  $\gamma_{t\{R2\}}(T) = \gamma_{tR}(T)$ .

**Case 3.**  $T$  is obtained from  $T'$  by Operation  $F_3$ . Assume  $T$  is obtained from  $T'$  by adding a new vertex  $u$  and the edge  $uv$ , where  $v \in S_1(T')$ . Since  $v$  is a support of  $T'$ ,  $v$  is a strong support of  $T$ . So, by Observation 2.24, there exists a  $\gamma_{t\{R2\}}(T)$ -function  $g$  satisfying that  $g(v) = 2$  and  $g(u) = 0$ . Hence,  $g$  restricted to  $V(T')$  is a TR2DF on  $T'$  with weight  $\omega(g) = \gamma_{t\{R2\}}(T)$ , but it is not a  $\gamma_{t\{R2\}}(T')$ -function because  $v \in S_1(T')$ . So,  $\gamma_{t\{R2\}}(T') \leq \gamma_{t\{R2\}}(T) - 1$ .

Moreover, let  $f$  be a  $\gamma_{tR}(T')$ -function. Since  $\gamma_{t\{R2\}}(T') = \gamma_{tR}(T')$  and  $v \in S_1(T')$ , we obtain that  $f(v) = 1$ . Hence,  $f$  can be extended to a TRDF on  $T$  by assigning the weight 1 to  $u$ . Thus,  $\gamma_{tR}(T) \leq \gamma_{tR}(T') + 1$ . By using Proposition 2.1, inequalities above and inductive hypothesis, we obtain that  $\gamma_{t\{R2\}}(T) \leq \gamma_{tR}(T) \leq \gamma_{tR}(T') + 1 = \gamma_{t\{R2\}}(T') + 1 \leq \gamma_{t\{R2\}}(T)$ .

Therefore, we must have equality throughout the inequality chain above. In particular,  $\gamma_{t\{R2\}}(T) = \gamma_{tR}(T)$ .

**Case 4.**  $T$  is obtained from  $T'$  by Operation  $F_4$ . Assume  $T$  is obtained from  $T'$  by adding a path  $uu_1$  and the edge  $uv$ , where  $v \in S_{adj}(T')$ . Notice that every TRDF on  $T'$  can be extended

to a TRDF on  $T$  by assigning the weight 1 to  $u$  and  $u_1$ . Hence, by Proposition 2.1, the statement above and the inductive hypothesis, we obtain

$$\gamma_{\{R2\}}(T) \leq \gamma_{tR}(T) \leq \gamma_{tR}(T') + 2 = \gamma_{\{R2\}}(T') + 2. \quad (2)$$

We now show that  $\gamma_{\{R2\}}(T') \leq \gamma_{\{R2\}}(T) - 2$ . Let  $w \in N(v) \cap S(T')$ . By Observation 2.20, there exists a  $\gamma_{\{R2\}}(T)$ -function  $f$  such that  $f(v) = f(w) = f(u) = 2$  and  $f(u_1) = 0$ . Hence,  $f$  restricted to  $V(T')$  is a TR2DF on  $T'$ , which implies that  $\gamma_{\{R2\}}(T') \leq f(V(T')) = \gamma_{\{R2\}}(T) - 2$ , as desired. In consequence, we must have equality throughout the inequality chain (2). In particular,  $\gamma_{\{R2\}}(T) = \gamma_{tR}(T)$ .

**Case 5.**  $T$  is obtained from  $T'$  by Operation  $F_5$ . Assume  $T$  is obtained from  $T'$  by identifying the vertex  $u$  of path  $u_1uu_2$  and the vertex  $v$ , where  $v \in L_{tR,1}(T')$ . Notice that there exists a  $\gamma_{tR}(T')$ -function  $g$  satisfying that  $g(v) = 1$ . So,  $g$  can be extended to a TRDF on  $T$  by assigning the weight 2 to  $u$  and the weight 0 to  $u_1$  and  $u_2$ . Therefore, by Proposition 2.1, the statement above and the hypothesis, we obtain  $\gamma_{\{R2\}}(T) \leq \gamma_{tR}(T) \leq \gamma_{tR}(T') + 1 = \gamma_{\{R2\}}(T') + 1$ .

Moreover, by Observation 2.21, there exists a  $\gamma_{\{R2\}}(T)$ -function  $f$  satisfying that  $f(v) = 2$  and  $f(u_1) = f(u_2) = 0$ . Notice that the function  $f'$ , defined by  $f'(v) = 1$  and  $f'(x) = f(x)$  whenever  $x \in V(T') \setminus \{v\}$ , is a TR2DF on  $T'$ . So  $\gamma_{\{R2\}}(T') \leq \omega(f') = \gamma_{\{R2\}}(T) - 1$ . As a consequence, we must have equality throughout the inequality chain above. In particular,  $\gamma_{\{R2\}}(T) = \gamma_{tR}(T)$ .

**Case 6.**  $T$  is obtained from  $T'$  by Operation  $F_6$ . Assume  $T$  is obtained from  $T'$  by adding a path  $uu_1$  and the edge  $uv$ , where  $v$  is a near stable vertex belonging to  $L(T') \cup SS(T')$ . Let  $s$  be a support vertex adjacent to  $v$  in  $T'$ . Again, notice that every TRDF on  $T'$  can be extended to a TRDF on  $T$  by assigning the weight 1 to  $u$  and  $u_1$ . Hence, by the statement above, Proposition 2.1 and the inductive hypothesis, we obtain the inequality chain (2). We now show that  $\gamma_{\{R2\}}(T') \leq \gamma_{\{R2\}}(T) - 2$ . For this, we consider the next two cases.

*Case 6.1.*  $v \in L(T')$ . Since  $u \in S(T)$  and  $\delta_T(v) = \delta_T(u) = 2$ , there exists a  $\gamma_{\{R2\}}(T)$ -function  $f$  satisfying that  $f(u) = f(u_1) = 1$ ,  $f(v) = 0$  and  $f(s) > 0$ . If  $f$  restricted to  $V(T')$  is a TR2DF on  $T'$ , then  $\gamma_{\{R2\}}(T') \leq f(V(T')) = \gamma_{\{R2\}}(T) - 2$ . Conversely, suppose that  $f$  restricted to  $V(T')$  is not a TR2DF on  $T'$ . So,  $f$  restricted to  $V(T')$  is a near-TR2DF relative to  $v$  on  $T'$ . Thus, as  $v$  is a near stable vertex of  $T'$ , and so,  $\gamma_{\{R2\}}(T') = \gamma_{\{R2\}}^n(T'; v) \leq f(V(T')) = \gamma_{\{R2\}}(T) - 2$ , as desired.

*Case 6.2.*  $v \in SS(T')$ . Let  $f$  be a  $\gamma_{\{R2\}}(T)$ -function such that  $f(u_1)$  is minimum. Hence  $f(u) + f(u_1) = 2$  and  $f(s) > 0$  since  $s$  is a support of  $T$ . If  $f$  restricted to  $V(T')$  is a TR2DF on  $T'$ , then  $\gamma_{\{R2\}}(T') \leq f(V(T')) = \gamma_{\{R2\}}(T) - 2$ . Conversely, suppose that  $f$  restricted to  $V(T')$  is not a TR2DF on  $T'$ . Hence  $f(v) = 0$ , implying that  $f$  restricted to  $V(T')$  is a near-TR2DF relative to  $v$  on  $T'$ . Also, as  $v$  is a near stable vertex of  $T'$ , it follows that  $\gamma_{\{R2\}}(T') = \gamma_{\{R2\}}^n(T'; v) \leq f(V(T')) = \gamma_{\{R2\}}(T) - 2$ , as desired.

In consequence, we must have equality throughout the inequality chain (2). In particular,



$$\gamma_{t\{R2\}}(T) = \gamma_{tR}(T).$$

**Case 7.**  $T$  is obtained from  $T'$  by Operation  $F_7$ . Assume  $T$  is obtained from  $T'$  by adding a path  $uu_1u_2$  and the edge  $uv$ , where  $v \in W_0(T')$ . Let  $g$  be a  $\gamma_{tR}(T')$ -function. Hence,  $g$  can be extended to a TRDF on  $T$  by assigning the weight 1 to  $u$ ,  $u_1$  and  $u_2$ . Therefore, by Proposition 2.1, the statement above and the hypothesis, we obtain

$$\gamma_{t\{R2\}}(T) \leq \gamma_{tR}(T) \leq \gamma_{tR}(T') + 3 = \gamma_{t\{R2\}}(T') + 3. \quad (3)$$

We now show that  $\gamma_{t\{R2\}}(T') \leq \gamma_{t\{R2\}}(T) - 3$ . Let  $f(V_0, V_1, V_2)$  be a  $\gamma_{t\{R2\}}(T)$ -function such that  $|V_2|$  is minimum. Hence  $f(u_1) + f(u_2) = 2$ . If  $f(u) = 0$ , then  $f(v) > 0$  and also,  $f$  restricted to  $V(T')$  is a TR2DF on  $T'$ . As  $v \in W_0(T')$ ,  $f$  is not a  $\gamma_{t\{R2\}}(T')$ -function. Hence,  $\gamma_{t\{R2\}}(T') \leq f(V(T')) - 1 \leq \gamma_{t\{R2\}}(T) - 3$ , as desired.

Now, we suppose that  $f(u) > 0$ . In this case, we observe that  $f(u) = 1$  since  $|V_2|$  is minimum. If  $f(v) = 0$ , then the function  $f'$ , defined by  $f'(v) = f(u)$  and  $f'(x) = f(x)$  whenever  $x \in V(T') \setminus \{v\}$ , is a TR2DF on  $T'$  such that  $\omega(f') \leq \gamma_{t\{R2\}}(T) - 2$ . On the other hand, if  $f(v) > 0$ , then observe that  $f(N(v) \setminus \{u\}) = 0$ . Otherwise, if there exists  $z \in N(v) \setminus \{u\}$  such that  $f(z) > 0$ , then  $f(u) = 0$ , which is a contradiction. Now, notice that the function  $f''$ , defined by  $f''(w) = f(u) = 1$  for some  $w \in N(v) \setminus \{u\}$  and  $f''(x) = f(x)$  whenever  $x \in V(T') \setminus \{w\}$ , is a TR2DF on  $T'$  such that  $\omega(f'') \leq \gamma_{t\{R2\}}(T) - 2$ . Again, as  $v \in W_0(T')$ ,  $f'$  and  $f''$  are not  $\gamma_{t\{R2\}}(T')$ -functions. Hence,  $\gamma_{t\{R2\}}(T') \leq \gamma_{t\{R2\}}(T) - 3$ , as desired.

In consequence, we must have equality throughout the inequality chain (3). In particular,  $\gamma_{t\{R2\}}(T) = \gamma_{tR}(T)$ .  $\square$

We now turn our attention to the opposite direction concerning the theorem above. That is, we show that if a tree  $T$  satisfies  $\gamma_{t\{R2\}}(T) = \gamma_{tR}(T)$ , then it belongs to the family  $\mathcal{F}$ .

**Theorem 2.27.** *Let  $T$  be a tree. If  $\gamma_{t\{R2\}}(T) = \gamma_{tR}(T)$ , then  $T \in \mathcal{F}$ .*

*Proof.* First, we say that a tree  $T$  belongs to the family  $\mathcal{T}$  if  $\gamma_{t\{R2\}}(T) = \gamma_{tR}(T)$ . We proceed by induction on the order  $n \geq 2$  of the trees  $T \in \mathcal{T}$ . If  $T$  is a star, then  $\gamma_{t\{R2\}}(T) = \gamma_{tR}(T)$ . Thus,  $T$  can be obtained from  $P_2$  by first applying Operation  $F_3$ , thereby producing a path  $P_3$  and then doing repeated applications of Operation  $F_2$ . Therefore,  $T \in \mathcal{F}$ . This establishes the base case. We assume now that  $k \geq 3$  is an integer and that each tree  $T' \in \mathcal{T}$  with  $|V(T')| < k$  satisfies that  $T' \in \mathcal{F}$ . Let  $T \in \mathcal{T}$  be a tree with  $|V(T)| = k$  and we may assume that  $diam(T) \geq 3$ .

First, suppose that  $diam(T) = 3$ . Therefore,  $T$  is a double star  $S_{x,y}$  for some integers  $x \geq y \geq 1$ . If  $T \cong P_4$ , then  $T$  can be obtained from a path  $P_2$  by applying Operation  $F_4$ . If  $T \cong S_{x,y}$  with  $x \geq y \geq 1$  ( $T \not\cong P_4$ ), then  $T$  can be obtained from a path  $P_2$  by first applying Operation  $F_4$ , thereby producing a path  $P_4$  and then doing repeated applications of Operation  $F_2$  in both support vertices of  $P_4$ . Therefore,  $T \in \mathcal{F}$ .

We may now assume that  $diam(T) \geq 4$ , and we root the tree  $T$  at a vertex  $r$  located at the end of a longest path in  $T$ . Let  $h$  be a vertex at maximum distance from  $r$ . Notice that, necessarily,  $r$  and  $h$  are leaves (and diametral vertices). Let  $s$  be the parent of  $h$ ; let  $v$  be the

parent of  $s$ ; let  $w$  be the parent of  $v$ ; and let  $z$  be the parent of  $w$ . Notice that all these vertices exist since  $\text{diam}(T) \geq 4$ , and it could happen  $z = r$ . Since  $h$  is a vertex at maximum distance from the root  $r$ , every child of  $s$  is a leaf. We proceed further with the following claims.

**Claim I.** If  $\delta_T(s) \geq 4$ , then  $T \in \mathcal{F}$ .

**Proof.** Suppose that  $\delta_T(s) \geq 4$  and let  $T' = T - h$ . Hence,  $\delta_{T'}(s) \geq 3$  and consequently,  $s \in S_s(T')$ , since every child of  $s$  is a leaf vertex. Therefore, by Observation 2.24, there exists a  $\gamma_{t\{R2\}}(T')$ -function, that assigns the weight 2 to  $s$ . The function above can be extended to a TR2DF on  $T$  by assigning the weight 0 to  $h$ , implying that  $\gamma_{t\{R2\}}(T) \leq \gamma_{t\{R2\}}(T')$ . Thus, by Proposition 2.1, Observation 2.25, hypothesis and inequality above, we obtain  $\gamma_{t\{R2\}}(T) \leq \gamma_{tR}(T') \leq \gamma_{tR}(T) = \gamma_{t\{R2\}}(T) \leq \gamma_{t\{R2\}}(T')$ . Thus, we must have equality throughout this inequality chain. In particular  $\gamma_{t\{R2\}}(T) = \gamma_{tR}(T')$ . Applying the inductive hypothesis to  $T'$ , it follows that  $T' \in \mathcal{F}$ . Since  $s \in S_s(T')$ , by using Observation 2.24, we deduce that  $s \in S_{tR,2}(T')$ . Therefore,  $T$  can be obtained from  $T'$  by applying Operation  $F_2$ , and consequently,  $T \in \mathcal{F}$ . ( $\square$ )

By Claim I, we may henceforth assume that  $|N(x) \cap L(T)| = 2$  for every strong support vertex  $x$  of  $T$ .

**Claim II.** If  $\delta_T(s) = 3$  and  $\delta_T(v) \geq 3$ , then  $T \in \mathcal{F}$ .

**Proof.** Suppose that  $\delta_T(s) = 3$  and  $\delta_T(v) \geq 3$ . Thus,  $s$  is a strong support vertex and has two leaf neighbors, say  $h, h_1$ . Moreover, observe that  $v$  has at least one child, say  $s'$ , different from  $s$ , and also,  $s'$  is either a leaf vertex or a support vertex of  $T$ . By using Theorem 2.23, there exists a  $\gamma_{t\{R2\}}(T)$ -function  $f(V_0, V_1, V_2)$  with  $V_{0,1} = \emptyset$ , and without loss of generality, we assume that  $|V_2|$  is maximum. Notice that  $f$  is a  $\gamma_{tR}(T)$ -function as well. Now, we differentiate the following cases.

*Case 1.*  $s' \in L(T)$ . In such situation,  $v \in S(T)$ , and so,  $f(v) = f(s) = 2$  and  $f(s') = f(h) = f(h_1) = 0$ . Let  $T' = T - h$ . Since  $v, s \in S_{adj}(T')$ , by Observation 2.20, there exists a  $\gamma_{t\{R2\}}(T')$ -function  $g$  satisfying that  $g(v) = g(s) = 2$ . So,  $g$  can be extended to a TR2DF on  $T$  by assigning the weight 0 to  $h$ . Hence  $\gamma_{t\{R2\}}(T) \leq \gamma_{t\{R2\}}(T')$ . Consequently, by inequality above, Proposition 2.1, Observation 2.25 and hypothesis, we obtain  $\gamma_{t\{R2\}}(T) \leq \gamma_{t\{R2\}}(T') \leq \gamma_{tR}(T') \leq \gamma_{tR}(T) = \gamma_{t\{R2\}}(T)$ . Therefore, we must have equality throughout this inequality chain. In particular,  $\gamma_{t\{R2\}}(T) = \gamma_{tR}(T')$ . Applying the inductive hypothesis to  $T'$ , it follows that  $T' \in \mathcal{F}$ .

As another consequence of the equality chain above, we obtain that  $\gamma_{tR}(T') = \gamma_{tR}(T)$ . This implies that  $f$  restricted to  $V(T')$  is a  $\gamma_{tR}(T')$ -function, which means  $s \in S_{tR,2}(T')$ . Therefore,  $T$  can be obtained from  $T'$  by applying Operation  $F_2$ , and consequently,  $T \in \mathcal{F}$ . ( $\square$ )

*Case 2.*  $s' \in S_s(T)$ . Observe that  $f(s') = f(s) = 2$ ,  $f(h) = 0$  and  $f(v) > 0$ . Let  $T' = T - h$ . Since  $s' \in S_s(T')$ , by Observation 2.24, there exists a  $\gamma_{t\{R2\}}(T')$ -function  $g$  satisfying that  $g(s') = 2$ . So, without loss of generality, we can assume that  $g(v) > 0$ , implying that  $g(s) = 2$  and

$g(h_1) = 0$ . Thus,  $g$  can be extended to a TR2DF on  $T$  by assigning the weight 0 to  $h$ . Hence  $\gamma_{t\{R2\}}(T) \leq \gamma_{t\{R2\}}(T')$ . Consequently, by the inequality above, Proposition 2.1, Observation 2.25 and the hypothesis, we obtain  $\gamma_{t\{R2\}}(T) \leq \gamma_{t\{R2\}}(T') \leq \gamma_{tR}(T') \leq \gamma_{tR}(T) = \gamma_{t\{R2\}}(T)$ . Therefore, we must have equality throughout this inequality chain. In particular,  $\gamma_{t\{R2\}}(T') = \gamma_{tR}(T')$ . Applying the inductive hypothesis to  $T'$ , it follows that  $T' \in \mathcal{F}$ .

As another consequence of equality chain above, we obtain that  $\gamma_{tR}(T') = \gamma_{tR}(T)$ . This implies that  $f$  restricted to  $V(T')$  is a  $\gamma_{tR}(T')$ -function, and so,  $s \in S_{tR,2}(T')$ . Therefore,  $T$  can be obtained from  $T'$  by applying Operation  $F_2$ , which leads to  $T \in \mathcal{F}$ . ( $\square$ )

*Case 3.*  $s' \in S(T) \setminus S_s(T)$ . Notice that  $T_{s'} \cong P_2$  and let  $T' = T - T_{s'}$ . Since  $v \in SS(T') \cap N(S_s(T'))$ ,  $f$  restricted to  $V(T')$  is a TRDF on  $T'$  and also  $f(V(T_{s'})) = 2$ . Hence  $\gamma_{tR}(T') \leq \gamma_{tR}(T) - 2$ . Moreover, any TR2DF on  $T'$  we can extended to a TR2DF on  $T$  by assigning the weight 1 to  $s'$  and its leaf-neighbor. Thus  $\gamma_{t\{R2\}}(T) \leq \gamma_{t\{R2\}}(T') + 2$ . So, by these previous inequalities, Proposition 2.1 and the hypothesis, we deduce  $\gamma_{t\{R2\}}(T) \leq \gamma_{t\{R2\}}(T') + 2 \leq \gamma_{tR}(T') + 2 \leq \gamma_{tR}(T) = \gamma_{t\{R2\}}(T)$ . Therefore, we must have equality throughout this inequality chain. In particular,  $\gamma_{t\{R2\}}(T') = \gamma_{tR}(T')$ . Applying the inductive hypothesis to  $T'$ , it follows that  $T' \in \mathcal{F}$ .

Moreover, as  $v$  is adjacent to the support vertex  $s$ , every near-TR2DF relative to  $v$  on  $T'$  can be extended to a TR2DF on  $T$  by assigning the weight 1 to  $s'$  and to its leaf-neighbor. So,  $\gamma_{t\{R2\}}(T) \leq \gamma_{t\{R2\}}^n(T'; v) + 2$ . In addition, if  $v$  is not a near stable vertex of  $T'$ , then  $\gamma_{t\{R2\}}^n(T'; v) < \gamma_{t\{R2\}}(T')$ , implying that  $\gamma_{t\{R2\}}(T) \leq \gamma_{t\{R2\}}^n(T'; v) + 2 < \gamma_{t\{R2\}}(T') + 2$ , which is a contradiction with the related equality noticed above. Therefore, the semi-support vertex  $v$  is a near stable vertex of  $T'$ , and therefore,  $T$  can be obtained from  $T'$  by applying Operation  $F_6$ , which means  $T \in \mathcal{F}$ . ( $\square$ )

**Claim III.** If  $\delta_T(s) = 3$  and  $\delta_T(v) = 2$ , then  $T \in \mathcal{F}$ .

**Proof.** Suppose that  $\delta_T(s) = 3$  and  $\delta_T(v) = 2$ . Thus,  $s$  is a strong support vertex and has two leaf neighbors, say  $h, h_1$ . By Observation 2.21, there exists a  $\gamma_{tR}(T)$ -function  $f$  such that  $f(s) = 2$  and  $f(h) = f(h_1) = 0$ , which implies that  $f(v) > 0$ . Let  $T' = T - \{h, h_1\}$ . Notice that the function  $f'$ , defined by  $f'(s) = 1$  and  $f'(x) = f(x)$  whenever  $x \in V(T') \setminus \{s\}$ , is a TRDF on  $T'$ . Hence  $\gamma_{tR}(T') \leq \omega(f') = \gamma_{tR}(T) - 1$ . Moreover, as  $v \in S(T')$  and  $\delta_{T'}(v) = 2$ , there exists a  $\gamma_{t\{R2\}}(T')$ -function  $g$  satisfying that  $g(s) = g(v) = 1$ . So,  $g$  can be extended to a TR2DF on  $T$  by assigning the weight 2 to  $s$  and the weight 0 to  $h$  and  $h_1$ , implying that  $\gamma_{t\{R2\}}(T) \leq \gamma_{t\{R2\}}(T') + 1$ . Thus, by Proposition 2.1, the hypothesis and the inequalities above, we obtain that  $\gamma_{t\{R2\}}(T) \leq \gamma_{tR}(T') \leq \gamma_{tR}(T) - 1 = \gamma_{t\{R2\}}(T) - 1 \leq \gamma_{t\{R2\}}(T')$ . Therefore, we must have equality throughout this inequality chain. In particular,  $\gamma_{t\{R2\}}(T') = \gamma_{tR}(T')$ . Applying the inductive hypothesis to  $T'$ , it follows that  $T' \in \mathcal{F}$ .

Moreover, by the equality noted before, we deduce that  $f'$  is a  $\gamma_{tR}(T')$ -function. Thus  $s \in L_{tR,1}(T')$ . Therefore,  $T$  can be obtained from  $T'$  by applying Operation  $F_5$ , and consequently,  $T \in \mathcal{F}$ . ( $\square$ )

**Claim IV.** If  $\delta_T(s) = 2$  and  $\delta_T(v) = 2$ , then  $T \in \mathcal{F}$ .

**Proof.** Suppose that  $\delta_T(s) = 2$  and  $\delta_T(v) = 2$ . By Theorem 2.23, there exists a  $\gamma_{\{R2\}}(T)$ -function  $f$  with  $V_{0,1} = \emptyset$  and, without loss of generality, we assume that  $|V_2|$  is minimum. Notice that  $f$  is a  $\gamma_{tR}(T)$ -function as well, and also  $f(s) + f(h) = 2$ .

First, we suppose that  $f(w) > 0$ . Let  $T' = T - T_s = T - \{s, h\}$ . Notice that  $f$  restricted to  $V(T')$  is a TRDF on  $T'$ . Hence  $\gamma_{tR}(T') \leq f(V(T')) = \gamma_{tR}(T) - 2$ . Moreover, any TR2DF on  $T'$  can be extended to a TR2DF on  $T$  by assigning the weight 1 to  $s$  and  $h$ , implying that  $\gamma_{\{R2\}}(T) \leq \gamma_{\{R2\}}(T') + 2$ . So, by the inequalities above, Proposition 2.1 and the hypothesis, we obtain that  $\gamma_{\{R2\}}(T) \leq \gamma_{\{R2\}}(T') + 2 \leq \gamma_{tR}(T') + 2 \leq \gamma_{tR}(T) = \gamma_{\{R2\}}(T)$ . Therefore, we must have equality throughout this inequality chain. In particular,  $\gamma_{\{R2\}}(T') = \gamma_{tR}(T')$ . Applying the inductive hypothesis to  $T'$ , it follows that  $T' \in \mathcal{F}$ .

Moreover, a minimum weight near-TR2DF relative to  $v$  on  $T'$  can be extended to a TR2DF on  $T$  by assigning to  $s$  and  $h$  the weight 1. Hence  $\gamma_{\{R2\}}(T) \leq \gamma_{\{R2\}}^n(T'; v) + 2$ . If  $v$  is not a near stable vertex of  $T'$ , then  $\gamma_{\{R2\}}^n(T'; v) < \gamma_{tR}(T')$ , implying that  $\gamma_{\{R2\}}(T) \leq \gamma_{\{R2\}}^n(T'; v) + 2 < \gamma_{tR}(T') + 2$ , which is a contradiction with the related equality noted before. Therefore,  $v$  is both a near stable vertex and a leaf of  $T'$ . Thus,  $T$  can be obtained from the tree  $T'$  by applying Operation  $F_6$ , and consequently,  $T \in \mathcal{F}$ .

From now on, we suppose that  $f(w) = 0$ . Hence  $f(v) = f(s) = f(h) = 1$ . We consider the tree  $T'' = T - T_v = T - \{v, s, h\}$ . Notice that any TR2DF on  $T''$  can be extended to a TR2DF on  $T$  by assigning the weight 1 to  $v$ ,  $s$  and  $h$ , implying that  $\gamma_{\{R2\}}(T) \leq \gamma_{\{R2\}}(T'') + 3$ .

On the other hand, notice that  $f$  restricted to  $V(T'')$  is a TRDF on  $T''$ . Hence  $\gamma_{tR}(T'') \leq f(V(T'')) = \gamma_{tR}(T) - 3$ . Consequently, by the previous inequalities, Proposition 2.1 and the hypothesis, we obtain that  $\gamma_{\{R2\}}(T) \leq \gamma_{\{R2\}}(T'') + 3 \leq \gamma_{tR}(T'') + 3 \leq \gamma_{tR}(T) = \gamma_{\{R2\}}(T)$ . Therefore, we must have equality throughout this inequality chain. In particular,  $\gamma_{\{R2\}}(T'') = \gamma_{tR}(T'')$ . Also, note that  $\gamma_{\{R2\}}(T) = \gamma_{\{R2\}}(T'') + 3$ . Applying the inductive hypothesis to  $T''$ , it follows that  $T'' \in \mathcal{F}$ .

Moreover, we suppose there exists a  $\gamma_{\{R2\}}(T'')$ -function  $g$  satisfying that  $g(w) > 0$ . Observe that  $g$  can be extended to a TR2DF on  $T$  by assigning the weight 0 to  $v$  and the weight 1 to  $s$  and  $h$ . Hence  $\gamma_{\{R2\}}(T) \leq \omega(g) + 2 = \gamma_{\{R2\}}(T'') + 2$ , which is a contradiction with the related equality noticed above. Therefore  $w \in W_0(T'')$  and so,  $T$  can be obtained from the tree  $T''$  by applying Operation  $F_7$ . Consequently,  $T \in \mathcal{F}$ . ( $\square$ )

**Claim V.** If  $\delta_T(s) = 2$  and  $\delta_T(v) \geq 3$ , then  $T \in \mathcal{F}$ .

**Proof.** Suppose that  $\delta_T(s) = 2$  and  $\delta_T(v) \geq 3$ . Clearly,  $v$  has at least one child, say  $s'$ , different from  $s$ , implying that  $s'$  is either a support vertex or a leaf vertex of  $T$ . Now, we differentiate the following cases.

*Case 1.*  $s' \in S(T)$ . By Theorem 2.23, there exists a  $\gamma_{\{R2\}}(T)$ -function  $f$  with  $V_{0,1} = \emptyset$  and, without loss of generality, we assume that  $|V_2|$  is maximum. Notice that  $f$  is a  $\gamma_{tR}(T)$ -function

as well, and also,  $f(s) + f(h) = 2$ . As  $s' \in S(T)$ ,  $f$  restricted to  $T' = T - \{s, h\}$  is a TRDF on  $T'$ . Hence  $\gamma_{tR}(T') \leq \gamma_{tR}(T) - 2$ . Moreover, any TR2DF on  $T'$  can be extended to a TR2DF on  $T$  by assigning the weight 1 to  $s$  and  $h$ . Hence  $\gamma_{t\{R2\}}(T) \leq \gamma_{t\{R2\}}(T') + 2$ . Therefore, by the inequalities above, Proposition 2.1 and the hypothesis, we obtain  $\gamma_{t\{R2\}}(T) \leq \gamma_{t\{R2\}}(T') + 2 \leq \gamma_{tR}(T') + 2 \leq \gamma_{tR}(T) = \gamma_{t\{R2\}}(T)$ . Thus, we must have equality throughout this inequality chain. In particular,  $\gamma_{t\{R2\}}(T') = \gamma_{tR}(T')$ . Applying the inductive hypothesis to  $T'$ , it follows that  $T' \in \mathcal{F}$ .

If  $v \in S(T')$ , then  $v \in S_{adj}(T')$ . So  $T$  can be obtained from  $T'$  by applying Operation  $F_4$ , and consequently,  $T \in \mathcal{F}$ .

If  $v \notin S(T')$ , then  $v \in SS(T')$ . Now, we prove that  $v$  is a near stable vertex of  $T'$ . Notice that a minimum weight near-TR2DF relative to  $v$  on  $T'$  can be extended to a TR2DF on  $T$  by assigning to  $s$  and  $h$  the weight 1. So  $\gamma_{t\{R2\}}(T) \leq \gamma_{t\{R2\}}^n(T'; v) + 2$ . If  $v$  is not a near stable vertex of  $T'$ , then  $\gamma_{t\{R2\}}^n(T'; v) < \gamma_{t\{R2\}}(T')$ , implying that  $\gamma_{t\{R2\}}(T) \leq \gamma_{t\{R2\}}^n(T'; v) + 2 < \gamma_{t\{R2\}}(T') + 2$ , which is a contradiction with the related equality noted before. Therefore,  $v$  is a near stable vertex of  $T'$ , as desired. Thus,  $T$  can be obtained from  $T'$  by applying Operation  $F_6$ , and consequently,  $T \in \mathcal{F}$ . ( $\square$ )

By the case above, we may henceforth assume that every child of  $v$  is a leaf of  $T$ .

*Case 2.*  $s' \in L(T)$  and  $v \in S_s(T)$ . We consider the tree  $T' = T - s'$ . Notice that  $v \in S_{adj}(T')$ . Hence, by Observation 2.20, there exists a  $\gamma_{t\{R2\}}(T')$ -function  $f$  such that  $f(v) = f(s) = 2$ . So,  $f$  can be extended to a TR2DF on  $T$  by assigning the weight 0 to  $s'$ . Thus  $\gamma_{t\{R2\}}(T) \leq \gamma_{t\{R2\}}(T')$  and by using Proposition 2.1, Observation 2.25 and the hypothesis, we obtain  $\gamma_{t\{R2\}}(T) \leq \gamma_{t\{R2\}}(T') \leq \gamma_{tR}(T') \leq \gamma_{tR}(T) = \gamma_{t\{R2\}}(T)$ . Therefore, we must have equality throughout this inequality chain. In particular,  $\gamma_{t\{R2\}}(T') = \gamma_{tR}(T')$ . Applying the inductive hypothesis to  $T'$ , it follows that  $T' \in \mathcal{F}$ . As another consequence of equality chain above, we obtain  $\gamma_{tR}(T') = \gamma_{tR}(T)$ . By Observation 2.21, there exists a  $\gamma_{tR}(T)$ -function  $g$  such that  $g(v) = 2$  and  $g(s') = 0$ . Since  $\gamma_{tR}(T') = \gamma_{tR}(T)$ ,  $g$  restricted to  $V(T')$  is a  $\gamma_{tR}(T')$ -function. Hence  $v \in S_{tR,2}(T')$ . Therefore,  $T$  can be obtained from  $T'$  by applying Operation  $F_2$ , and consequently,  $T \in \mathcal{F}$ . ( $\square$ )

*Case 3.*  $s' \in L(T)$  and  $v \in S(T) \setminus S_s(T)$ . First, we suppose that  $w \in S(T)$ . Let  $T' = T - T_s = T - \{s, h\}$ . By using a similar procedure as in Case 1 of Claim V ( $v \in S(T')$ ), we obtain  $\gamma_{t\{R2\}}(T') = \gamma_{tR}(T')$  and  $v \in S_{adj}(T')$ . Hence, by applying the inductive hypothesis to  $T'$ , it follows that  $T' \in \mathcal{F}$ . Therefore,  $T$  can be obtained from  $T'$  by Operation  $F_4$ , and consequently,  $T \in \mathcal{F}$ .

From now on, we assume that  $w \notin S(T)$ . Let  $f(V_0, V_1, V_2)$  be a  $\gamma_{tR}(T)$ -function such that  $f(w)$  is minimum among all  $\gamma_{tR}(T)$ -functions which satisfy that  $|S(T) \cap V_2|$  and  $|L_s(T) \cap V_0|$  are maximum. Hence  $f(v) = f(s) = 2$ . Next, we analyse the two possible scenarios.

*Subcase 3.1.*  $f(w) > 0$ . Since  $N(w) \setminus \{z\} \subset S(T) \cup SS(T)$  and  $f(v) = 2$ , it is easy to check that  $f(w) = 1$  and  $N(w) \cap S_s(T) \neq \emptyset$ . Let  $v' \in N(w) \cap S_s(T)$ ,  $N(v') \cap L(T) = \{h_1, h_2\}$  and

$$T'' = T - \{h_1, h_2\}.$$

Notice that the function  $f'$ , defined by  $f'(v') = 1$  and  $f'(x) = f(x)$  whenever  $x \in V(T'') \setminus \{v'\}$ , is a TRDF on  $T''$ . Hence  $\gamma_{tR}(T'') \leq \omega(f') = \gamma_{tR}(T) - 1$ . Moreover, as  $v \in S(T'')$  and  $N(w) \setminus \{z, v'\} \subset S(T'') \cup SS(T'')$ , there exists a  $\gamma_{t\{R2\}}(T'')$ -function  $g$  such that  $g(w) = g(v') = 1$ . So,  $g$  can be extended to a TR2DF on  $T$  by re-assigning the weight 2 to  $v'$  and by assigning the weight 0 to  $h_1$  and  $h_2$ , which implies that  $\gamma_{t\{R2\}}(T) \leq \gamma_{t\{R2\}}(T'') + 1$ .

Thus, by Proposition 2.1, the inequalities above and the hypothesis, we obtain  $\gamma_{t\{R2\}}(T'') \leq \gamma_{tR}(T'') \leq \gamma_{tR}(T) - 1 = \gamma_{t\{R2\}}(T) - 1 \leq \gamma_{t\{R2\}}(T'')$ . Therefore, we must have equality throughout this inequality chain. In particular,  $\gamma_{t\{R2\}}(T'') = \gamma_{tR}(T'')$ . Applying the inductive hypothesis to  $T''$ , it follows that  $T'' \in \mathcal{F}$ . Also, by the equality noted before, we deduce that  $f'$  is a  $\gamma_{tR}(T'')$ -function. Thus  $v' \in L_{tR,1}(T'')$ . Therefore,  $T$  can be obtained from  $T''$  by applying Operation  $F_5$ , and consequently,  $T \in \mathcal{F}$ . ( $\square$ )

*Subcase 3.2.*  $f(w) = 0$ . Notice that  $N(w) \cap S_s(T) = \emptyset$ . Now, we consider that  $w$  has a child, say  $v'$ , different from  $v$ . First, we suppose that  $S_s(T) \cap V(T_{v'}) \neq \emptyset$ . Let  $x \in S_s(T) \cap V(T_{v'})$ ,  $h_x \in N(x) \cap L(T)$  and  $T''' = T - h_x$ . Again, by using a similar procedure as in Case 2 of Claim V, we obtain  $\gamma_{t\{R2\}}(T''') = \gamma_{tR}(T''')$  and  $x \in S_{tR,2}(T''')$ . Hence, by applying the inductive hypothesis to  $T'''$ , it follows that  $T''' \in \mathcal{F}$ . Therefore,  $T$  can be obtained from  $T'''$  by applying Operation  $F_2$ , and consequently,  $T \in \mathcal{F}$ .

Thus, we may assume that  $S_s(T) \cap V(T_w) = \emptyset$ . If  $T_{v'}$  is isomorphic to  $P_2$  or  $P_3$ , then, by using a similar reasoning as in Case 1 of Claim V ( $v \in SS(T')$ ) or Claim IV ( $f(w) = 0$ ), respectively, we obtain that  $T'' = T - T_{v'} \in \mathcal{F}$ . Therefore,  $T$  can be obtained from  $T''$  by applying Operation  $F_6$  or Operation  $F_7$ , respectively. Consequently,  $T \in \mathcal{F}$ .

Hence, we may assume that for every child  $x$  of  $w$ , the tree  $T_x$  is not isomorphic to  $P_2$  or  $P_3$ . Thus, it is easy to check that  $T_w \cong R_r$ . Let  $T'''' = T - T_w$ . Since  $f(w) = 0$  and  $w \notin S(T)$ , the function  $f$  restricted to  $V(T''')$  is a TRDF on  $T'''$ . So,  $\gamma_{tR}(T''') \leq f(V(T''')) = \gamma_{tR}(T) - 4r$ . Moreover, any TR2DF on  $T'''$  can be extended to a TR2DF on  $T$  by assigning the weight 2 to every support vertex and the weight 0 to another vertices of  $T_w$ . Thus,  $\gamma_{t\{R2\}}(T) \leq \gamma_{t\{R2\}}(T''') + 4r$ , and by using the inequalities above, Proposition 2.1 and the hypothesis, we obtain  $\gamma_{t\{R2\}}(T) \leq \gamma_{t\{R2\}}(T''') + 4r \leq \gamma_{tR}(T''') + 4r \leq \gamma_{tR}(T) = \gamma_{t\{R2\}}(T)$ . Therefore, we must have equality throughout this inequality chain. In particular,  $\gamma_{t\{R2\}}(T''') = \gamma_{tR}(T''')$ . Applying the inductive hypothesis to  $T'''$ , it follows that  $T'''' \in \mathcal{F}$ . Therefore,  $T$  can be obtained from  $T''''$  by applying Operation  $F_1$ , and consequently,  $T \in \mathcal{F}$ , which completes the proof. ( $\square$ )

As an immediate consequence of Theorems 2.26 and 2.27, we have the following characterization.

**Theorem 2.28.** *A tree  $T$  of order  $n \geq 2$  satisfies that  $\gamma_{t\{R2\}}(T) = \gamma_{tR}(T)$  if and only if  $T \in \mathcal{F}$ .*

To conclude this subsection, we next give a characterization of trees  $T$  with  $\gamma_{t\{R2\}}(T) = 2\gamma_t(T)$ . In [10], a family  $\mathcal{T}$  of trees  $T$  with  $\gamma_t(T) = \gamma(T)$  were characterized. Hence, as a consequence of the statement above and Theorems 2.6 and 2.28, the next characterization follows.

**Theorem 2.29.** *A tree  $T$  of order  $n \geq 2$  satisfies that  $\gamma_{t\{R2\}}(T) = 2\gamma_t(T)$  if and only if  $T \in \mathcal{F} \cap \mathcal{T}$ .*

We must remark that our characterization is strongly based on the computability of the sets  $S_{tR,2}(T_i)$ ,  $W_0(T_i)$ ,  $S_1(T_i)$  and  $L_{tR,1}(T_i)$ , for a given tree  $T_i$ , in order to construct a new element  $T_{i+1}$  of the family  $\mathcal{F}$ . It is probably hard to find such sets for the tree  $T_i$  regardless which is the operation made to construct such  $T_i$ . In this sense, as a continuation of this work, it would be desirable a future discussion on how one of these sets can be obtained for a given tree  $T_i$ , and on whether a connection between such set in  $T_i$  and the corresponding one in  $T_{i+1}$  exists.

### 3 Computational results

In order to present our complexity results we need to introduce the following construction. Given a graph  $G$  of order  $n$  and  $n$  copies of the star graph  $K_{1,4}$ , the graph  $H_G$  is constructed by adding edges between the  $i^{\text{th}}$ -vertex of  $G$  and one leaf vertex of the  $i^{\text{th}}$ -copy of  $K_{1,4}$ . See Figure 4 for an example.

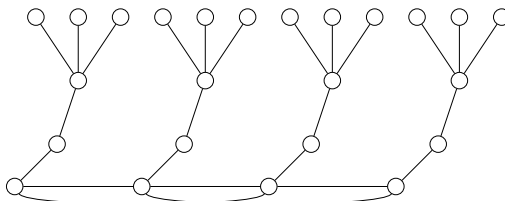

Figure 4: The graph  $H_G$  where  $G$  is a complete graph minus one edge.

It is well-known that the domination Problem is NP-complete, even when restricted to bipartite graphs (see Dewdney [9]) or chordal graphs (see Booth [5] and Booth and Johnson [4]). We use this result to prove the main result of this section, which is the complexity analysis of the following decision problem (total Roman  $\{2\}$ -dominating function Problem (TR2DF-Problem for short)). To this end, we will demonstrate a polynomial time reduction of the domination Problem to our TR2DF-Problem.

---

TR2DF-Problem

Instance: A non trivial graph  $H$  and a positive integer  $j \leq |V(H)|$ .

Question: Does  $H$  have a TR2DF of weight  $j$  or less?

---

**Observation 3.1.** *Let  $G$  be a graph different from a star graph. If  $v \in S_s(G)$  such that  $|N(v) \cap L(G)| \geq 3$ , then  $f(v) = 2$  for every  $\gamma_{t\{R2\}}(G)$ -function  $f$ .*

**Theorem 3.2.** *TR2DF-Problem is NP-complete, even when restricted to bipartite or chordal graphs.*

*Proof.* The problem is clearly in NP since verifying that a given function is indeed a TR2DF can be done in polynomial time.

We consider a graph  $G$  without isolated vertices of order  $n$  and construct the graph  $H_G$ . It is easy to see that this construction can be accomplished in polynomial time. Also, notice that if the graph  $G$  is a bipartite or chordal graph, then so too is  $H_G$ .

We next prove that  $\gamma_{t\{R2\}}(H_G) = \gamma(G) + 3|V(G)|$ . For this, we first consider the function  $f'(V'_0, V'_1, V'_2)$  defined by  $V'_1 = A \cup SS(H_G)$  and  $V'_2 = S(H_G)$ , where  $A$  is a  $\gamma(G)$ -set. Notice that  $f'$  is a TR2DF on  $H_G$ . So  $\gamma_{t\{R2\}}(H_G) \leq |A \cup SS(H_G)| + 2|S(H_G)| = \gamma(G) + 3|V(G)|$ .

On the other hand, let  $v \in V(G) \subset V(H_G)$ , and by  $K_{1,4}^v$  we denote the copy of  $K_{1,4}$  added to  $v$ . Let  $s_v$  and  $u_v$  be the support vertex and semi-support vertex of  $H_G$  respectively, belonging to the copy  $K_{1,4}^v$ . Let  $f(V_0, V_1, V_2)$  be a  $\gamma_{t\{R2\}}(G)$ -function satisfying that  $|V_2|$  is minimum. Since  $H_G$  is different from a star, and every support vertex is adjacent to three leaves, by Observation 3.1, we obtain that  $f(S(H_G)) = 2|S(H_G)|$ . Consequently,  $f(s_v) = 2$  and  $f(V(K_{1,4}^v)) \geq 3$ . Hence, we can assume that  $f(u_v) > 0$ . If  $f(u_v) = 2$ , then the function  $f''(V''_0, V''_1, V''_2)$ , defined by  $f''(u_v) = 1$ ,  $f''(v) = \min\{f(v) + 1, 2\}$  and  $f''(x) = f(x)$  whenever  $x \in V(H_G) \setminus \{u_v, v\}$ , is a TR2DF on  $H_G$  of weight  $\gamma_{t\{R2\}}(H_G)$  and  $|V''_2| < |V_2|$ , which is a contradiction. Hence  $f(u_v) = 1$  for every  $v \in V(G)$ .

Notice that each vertex  $v \in V(G)$  is adjacent to exactly one semi-support vertex of  $H_G$ . As  $SS(H_G) \subseteq V_1$ , it follows that  $V(G) \subseteq V_0 \cup V_1$  and also,  $V_1 \cap V(G)$  is a dominating set of  $G$ . Thus,  $\gamma_{t\{R2\}}(H_G) = \omega(f) = |V_1 \cap V(G)| + |SS(H_G)| + 2|S(H_G)| \geq \gamma(G) + 3|V(G)|$ . As a consequence, it follows that  $\gamma_{t\{R2\}}(H_G) = \gamma(G) + 3|V(G)|$ , as required.

Now, for  $j = k + 3|V(G)|$ , it is readily seen that  $\gamma_{t\{R2\}}(H_G) \leq j$  if and only if  $\gamma(G) \leq k$ , which completes the proof.  $\square$

As a consequence of the result above we conclude that finding the total Roman  $\{2\}$ -domination number of graphs is NP-hard.

## References

- [1] H. Abdollahzadeh Ahangar, M.A. Henning, V. Samodivkin, and I.G. Yero, Total Roman domination in graphs, *Appl. Anal. Discrete Math.* **10** (2016) 501–517.
- [2] J. Amjadi, S.M. Sheikholeslami and M. Soroudi, On the total Roman domination in trees, *Discuss. Math. Graph Theory* **39** (2019) 519–532.
- [3] M. Blidia, M. Chellali, T.W. Haynes and M.A. Henning, Independent and double domination in trees, *Util. Math.* **70** (2006) 159–173.
- [4] K.S. Booth, J.H. Johnson, Dominating sets in chordal graphs, *SIAM J. Comput.* **11** (1982) 191–199.
- [5] S. Booth, Dominating sets in chordal graphs, Research Report CS-80-34, University of Waterloo, 1980.



- [6] N. Campanelli, D. Kuziak, Total Roman domination in the lexicographic product of graphs, *Discrete Appl. Math.* **263** (2019) 88–95.
- [7] M. Chellali, T.W. Haynes, On paired and double domination in graphs, *Util. Math.* **67** (2005) 161–171.
- [8] M. Chellali, T.W. Haynes, S.T. Hedetniemi, A. McRae, Roman  $\{2\}$ -domination, *Discrete Appl. Math.* **204** (2016) 22–28.
- [9] K. Dewdney, Fast Turing reductions between problems in NP 4, Report 71, University of Western Ontario, 1981.
- [10] M. Dorfling, W. Goddard, M.A. Henning, C.M. Mynhardt, Construction of trees and graphs with equal domination parameters, *Discrete Math.* **306** (2006) 2647–2654.
- [11] J. Harant and M.A. Henning, On double domination in graphs, *Discuss. Math. Graph Theory* **25** (2005) 29–34.
- [12] F. Harary, T.W. Haynes, Double domination in graphs, *Ars. Combin.* **55** (2000) 201–213.
- [13] T.W. Haynes, S.T. Hedetniemi, P.J. Slater, *Domination in Graphs: Volume 2: Advanced Topics*, Chapman & Hall/CRC Pure and Applied Mathematics, Taylor & Francis, 1998.
- [14] T.W. Haynes, S.T. Hedetniemi, P.J. Slater, *Fundamentals of Domination in Graphs*, Chapman and Hall/CRC Pure and Applied Mathematics Series, Marcel Dekker, Inc. New York, 1998.
- [15] M.A. Henning, A survey of selected recent results on total domination in graphs, *Discrete Math.* **309** (2009) 32–63.
- [16] M.A. Henning and W. Klostermeyer, Italian domination in trees, *Discrete Appl. Math.* **217** (2017) 557–564.
- [17] M.A. Henning and A. Yeo, *Total domination in graphs*. Springer, New York, USA, 2013.
- [18] C.-H. Liu and G.J. Chang, Roman domination on strongly chordal graphs. *J. Comb. Optim.* **26** (2013), 608–619.

## Chapter 4

# Double domination in lexicographic product graphs

This chapter includes a complete copy of the following paper.

A. Cabrera Martínez, S. Cabrera García, J.A. Rodríguez-Velázquez. Double domination in lexicographic product graphs, *Discrete Appl. Math.* (2020) 284, 290–300.

URL: <https://doi.org/10.1016/j.dam.2020.03.045>

Quality indicators:

2019 JCR Impact factor: 1.041, Q3 (150/261), Mathematics, Applied.

# Double domination in lexicographic product graphs

A. Cabrera Martínez<sup>(1)</sup>, S. Cabrera García<sup>(2)</sup>, J. A. Rodríguez-Velázquez<sup>(1)</sup>

<sup>(1)</sup>Universitat Rovira i Virgili

Departament d'Enginyeria Informàtica i Matemàtiques

Av. Països Catalans 26, 43007 Tarragona, Spain.

abel.cabrera@urv.cat, juanalberto.rodriguez@urv.cat

<sup>(2)</sup>Universitat Politècnica de Valencia

Departamento de Estadística e Investigación Operativa Aplicadas y Calidad

Camino de Vera s/n, 46022 Valencia, Spain.

suicabga@eio.upv.es

## Abstract

In a graph  $G$ , a vertex dominates itself and its neighbours. A subset  $S \subseteq V(G)$  is said to be a double dominating set of  $G$  if  $S$  dominates every vertex of  $G$  at least twice. The minimum cardinality among all double dominating sets of  $G$  is the double domination number. In this article, we obtain tight bounds and closed formulas for the double domination number of lexicographic product graphs  $G \circ H$  in terms of invariants of the factor graphs  $G$  and  $H$ .

*Keywords:* Double domination; total domination; total Roman  $\{2\}$ -domination; lexicographic product

## 1 Introduction

In a graph  $G$ , a vertex dominates itself and its neighbours. A subset  $S \subseteq V(G)$  is said to be a *dominating set* of  $G$  if  $S$  dominates every vertex of  $G$ , while  $S$  is said to be a *double dominating set* of  $G$  if  $S$  dominates every vertex of  $G$  at least twice. A subset  $S \subseteq V(G)$  is said to be a *total dominating set* of  $G$  if every vertex  $v \in V(G)$  is dominated by at least one vertex in  $S \setminus \{v\}$ . The minimum cardinality among all dominating sets of  $G$  is the *domination number*, denoted by  $\gamma(G)$ . The *double domination number* and the *total domination number* of  $G$  are defined by analogy, and are denoted by  $\gamma_{\times 2}(G)$  and  $\gamma_t(G)$ , respectively. The domination number and the total domination number have been extensively studied. For instance, we cite the following books [19, 20, 21]. The double domination number, which has been less studied, was introduced in [18] by Harary and Haynes, and studied further in a number of works including [4, 10, 15, 17, 23].

Let  $f : V(G) \rightarrow \{0, 1, 2\}$  be a function. For any  $i \in \{0, 1, 2\}$  we define the subsets of vertices  $V_i = \{v \in V(G) : f(v) = i\}$  and we identify  $f$  with the three subsets of  $V(G)$  induced by  $f$ .

Thus, in order to emphasize the notation of these sets, we denote the function by  $f(V_0, V_1, V_2)$ . Given a set  $X \subseteq V(G)$ , we define  $f(X) = \sum_{v \in X} f(v)$ , and the *weight* of  $f$  is defined to be  $\omega(f) = f(V(G)) = |V_1| + 2|V_2|$ .

A function  $f(V_0, V_1, V_2)$  is a *total Roman dominating function* (TRDF) on a graph  $G$  if  $V_1 \cup V_2$  is a total dominating set and  $N(v) \cap V_2 \neq \emptyset$  for every vertex  $v \in V_0$ , where  $N(v)$  denotes the *open neighbourhood* of  $v$ . This concept was introduced by Liu and Chang [24]. For recent results on total Roman domination in graphs we cite [1, 2, 7, 9].

A function  $f(V_0, V_1, V_2)$  is a *total Roman  $\{2\}$ -dominating function* (TR2DF) if  $V_1 \cup V_2$  is a total dominating set and  $f(N(v)) \geq 2$  for every vertex  $v \in V_0$ . This concept was recently introduced in [6]. Notice that  $S \subseteq V(G)$  is a double dominating set of  $G$  if and only if there exists a TR2DF  $f(V_0, V_1, V_2)$  such that  $V_1 = S$  and  $V_2 = \emptyset$ .

The *total Roman domination number*, denoted by  $\gamma_R(G)$ , is the minimum weight among all TRDFs on  $G$ . By analogy, we define the *total Roman  $\{2\}$ -domination number*, which is denoted by  $\gamma_{\{R2\}}(G)$ .

Notice that, by definition,  $\gamma_{\times 2}(G) \geq \gamma_{\{R2\}}(G)$ . As an example of graph  $G$  for which  $\gamma_{\times 2}(G) > \gamma_{\{R2\}}(G)$  we consider a star graph  $K_{1,r}$  for  $r \geq 3$ . In this case,  $\gamma_{\times 2}(K_{1,r}) = r + 1 > 3 = \gamma_{\{R2\}}(K_{1,r})$ . We would point out that the problem of characterizing all graphs with  $\gamma_{\times 2}(G) = \gamma_{\{R2\}}(G)$  remains open. In this paper we show that the values of these two parameters coincide for any lexicographic product graph  $G \circ H$  in which graph  $G$  has no isolated vertices and graph  $H$  is not trivial. Furthermore, we obtain tight bounds and closed formulas for  $\gamma_{\times 2}(G \circ H)$  in terms of invariants of the factor graphs  $G$  and  $H$ .

## 1.1 Additional concepts, notation and tools

All graphs considered in this paper are finite and undirected, without loops or multiple edges. As usual, the *closed neighbourhood* of a vertex  $v \in V(G)$  is denoted by  $N[v] = N(v) \cup \{v\}$ . We say that a vertex  $v \in V(G)$  is a *universal vertex* of  $G$  if  $N[v] = V(G)$ . By analogy with the notation used for vertices, for a set  $S \subseteq V(G)$ , its *open neighbourhood* is the set  $N(S) = \cup_{v \in S} N(v)$ , and its *closed neighbourhood* is the set  $N[S] = N(S) \cup S$ . The subgraph induced by  $S \subseteq V(G)$  will be denoted by  $\langle S \rangle$ , while the graph obtained from  $G$  by removing all the vertices in  $S \subseteq V(G)$  (and all the edges incident with a vertex in  $S$ ) will be denoted by  $G - S$ .

We will use the notation  $K_n, K_{1,n-1}, C_n, N_n, P_n$  and  $K_{n,n-r}$  for complete graphs, star graphs, cycle graphs, empty graphs, path graphs and complete bipartite graphs of order  $n$ , respectively. A double star  $S_{n_1, n_2}$  is the graph obtained by joining the center of two stars  $K_{1, n_1}$  and  $K_{1, n_2}$  with an edge.

Given two graphs  $G$  and  $H$ , the *lexicographic product* of  $G$  and  $H$  is the graph  $G \circ H$  whose vertex set is  $V(G \circ H) = V(G) \times V(H)$  and  $(u, v)(x, y) \in E(G \circ H)$  if and only if  $ux \in E(G)$  or  $u = x$  and  $vy \in E(H)$ . Notice that for any vertex  $u \in V(G)$  the subgraph of  $G \circ H$  induced by  $\{u\} \times V(H)$  is isomorphic to  $H$ . For simplicity, we will denote this subgraph by  $H_u$ . For basic properties of lexicographic product graphs we suggest the books [16, 22]. In particular, we cite the following works on domination theory of lexicographic product graphs: standard domination [25, 27, 31], Roman domination [28], total Roman domination [9], weak Roman domination [30], rainbow domination [29],  $k$ -rainbow independent domination [5], super domination [13], twin domination [26], power domination [14] and doubly connected domination [3].

For simplicity, for any  $(u, v) \in V(G) \times V(H)$  and any TR2DF  $f$  on  $G \circ H$  we write  $N(u, v)$  and  $f(u, v)$  instead of  $N((u, v))$  and  $f((u, v))$ , respectively.

For the remainder of the paper, definitions will be introduced whenever a concept is needed.

Now we present some tools that will be very useful throughout the work.

**Proposition 1.1.** [6] *The following inequalities hold for any graph  $G$  with no isolated vertex.*

- (i)  $\gamma_t(G) \leq \gamma_{t\{R2\}}(G) \leq \gamma_R(G) \leq 2\gamma_t(G)$ .
- (ii)  $\gamma_{t\{R2\}}(G) \leq \gamma_{\times 2}(G)$ .

A double dominating set of cardinality  $\gamma_{\times 2}(G)$  will be called a  $\gamma_{\times 2}(G)$ -set. A similar agreement will be assumed when referring to optimal sets (and functions) associated to other parameters used in the article.

**Theorem 1.2.** *If  $\gamma_{\times 2}(G) = \gamma_t(G)$ , then for any  $\gamma_{\times 2}(G)$ -set  $D$  there exists an integer  $k \geq 1$  such that  $\langle D \rangle \cong \cup_{i=1}^k K_2$ .*

*Proof.* Let  $D$  be a  $\gamma_{\times 2}(G)$ -set and suppose that  $\langle D \rangle$  has a component  $G'$  which is not isomorphic to  $K_2$ . Let  $v \in V(G')$  be a vertex of minimum degree in  $G'$ . Notice that the set  $D \setminus \{v\}$  is a total dominating set of  $G$ . Hence,  $\gamma_t(G) \leq |D \setminus \{v\}| < |D| = \gamma_{\times 2}(G)$ , which is a contradiction. Therefore, the result follows.  $\square$

**Theorem 1.3.** [6] *The following statements are equivalent.*

- $\gamma_{t\{R2\}}(G) = 2\gamma_t(G)$ .
- $\gamma_{t\{R2\}}(G) = \gamma_R(G)$  and  $\gamma_t(G) = \gamma(G)$ .

The following theorem merges two results obtained in [6] and [18].

**Theorem 1.4** ([6] and [18]). *The following statements are equivalent.*

- $\gamma_{t\{R2\}}(G) = 2$ .
- $\gamma_{\times 2}(G) = 2$ .
- $G$  has at least two universal vertices.

It is readily seen that if  $G'$  is a spanning subgraph of  $G$ , then any  $\gamma_{\times 2}(G')$ -set is a double dominating set of  $G$ . Therefore, the following result is immediate.

**Theorem 1.5.** *If  $G'$  is a spanning subgraph of  $G$  with no isolated vertex, then*

$$\gamma_{\times 2}(G) \leq \gamma_{\times 2}(G').$$

In Proposition 4.7 we will show some cases of lexicographic product graphs for which the equality above holds.

**Remark 1.6.** *For any integer  $n \geq 3$ ,*

- (i)  $\gamma_{\{R2\}}(P_n) \stackrel{[6]}{=} \gamma_{\times 2}(P_n) \stackrel{[4]}{=} \begin{cases} 2 \lceil \frac{n}{3} \rceil + 1, & \text{if } n \equiv 0 \pmod{3}, \\ 2 \lceil \frac{n}{3} \rceil, & \text{otherwise.} \end{cases}$
- (ii)  $\gamma_{\{R2\}}(C_n) \stackrel{[6]}{=} \gamma_{\times 2}(C_n) \stackrel{[18]}{=} \lceil \frac{2n}{3} \rceil$ .

The next theorem merges two results obtained in [28] and [31].

**Theorem 1.7** ([28] and [31]). *For any graph  $G$  with no isolated vertex and any nontrivial graph  $H$ ,*

$$\gamma(G \circ H) = \begin{cases} \gamma(G), & \text{if } \gamma(H) = 1, \\ \gamma_t(G), & \text{if } \gamma(H) \geq 2. \end{cases}$$

**Theorem 1.8.** [8] *For any graph  $G$  with no isolated vertex and any nontrivial graph  $H$ ,*

$$\gamma_t(G \circ H) = \gamma_t(G).$$

## 2 Main results on lexicographic product graphs

Our first result shows that the double domination number and the total Roman  $\{2\}$ -domination number coincide for lexicographic product graphs.

**Theorem 2.1.** *For any graph  $G$  with no isolated vertex and any nontrivial graph  $H$ ,*

$$\gamma_{\times 2}(G \circ H) = \gamma_{\{R2\}}(G \circ H).$$

*Proof.* Proposition 1.1 (ii) leads to  $\gamma_{\times 2}(G \circ H) \geq \gamma_{\{R2\}}(G \circ H)$ . Let  $f(V_0, V_1, V_2)$  be a  $\gamma_{\{R2\}}(G \circ H)$ -function such that  $|V_2|$  is minimum. Suppose that  $\gamma_{\times 2}(G \circ H) > \gamma_{\{R2\}}(G \circ H)$ . In such a case,  $V_2 \neq \emptyset$  and we can differentiate two cases for a fixed vertex  $(u, v) \in V_2$ .

Case 1.  $N(u, v) \cap (V_1 \cup V_2) \subseteq V(H_u)$ . In this case, for any  $(u', v') \in N(u) \times V(H)$  we define the function  $g(V'_0, V'_1, V'_2)$  where  $V'_0 = V_0 \setminus \{(u', v')\}$ ,  $V'_1 = V_1 \cup \{(u, v), (u', v')\}$  and  $V'_2 = V_2 \setminus \{(u, v)\}$ . Observe that  $V'_1 \cup V'_2$  is a total dominating set of  $G \circ H$  and every vertex  $w \in V'_0 \subseteq V_0$  satisfies that  $g(N(w)) \geq 2$ . Hence,  $g$  is a  $\gamma_{\{R2\}}(G \circ H)$ -function and  $|V'_2| = |V_2| - 1$ , which is a contradiction.

Case 2.  $N(u) \times V(H) \cap (V_1 \cup V_2) \neq \emptyset$ . If  $f(u, v') > 0$  for every vertex  $v' \in V(H)$ , then the function  $g$ , defined by  $g(u, v) = 1$  and  $g(x, y) = f(x, y)$  whenever  $(x, y) \in V(G \circ H) \setminus \{(u, v)\}$ , is a TR2DF on  $G \circ H$  and  $\omega(g) = \omega(f) - 1$ , which is a contradiction. Hence, there exists a vertex  $v' \in V(H)$  such that  $f(u, v') = 0$ . In this case, we define the function  $g(V'_0, V'_1, V'_2)$  where  $V'_0 = V_0 \setminus \{(u, v')\}$ ,  $V'_1 = V_1 \cup \{(u, v), (u, v')\}$  and  $V'_2 = V_2 \setminus \{(u, v)\}$ . Notice that  $V'_1 \cup V'_2$  is a total dominating set of  $G \circ H$  and every vertex  $w \in V'_0 \subseteq V_0$  satisfies that  $g(N(w)) \geq 2$ . Hence,  $g$  is a  $\gamma_{\{R2\}}(G \circ H)$ -function and  $|V'_2| = |V_2| - 1$ , which is a contradiction again.

According to the two cases above, we deduce that  $V_2 = \emptyset$ . Therefore,  $V_1$  is a  $\gamma_{\times 2}(G \circ H)$ -set and so  $\gamma_{\times 2}(G \circ H) = \gamma_{\{R2\}}(G \circ H)$ .  $\square$

From now on, the main goal is to obtain tight bounds or closed formulas for  $\gamma_{\times 2}(G \circ H)$  and express them in terms of invariants of  $G$  and  $H$ .

A set  $X \subseteq V(G)$  is called a *2-packing* if  $N[u] \cap N[v] = \emptyset$  for every pair of different vertices  $u, v \in X$ , [20]. The *2-packing number*  $\rho(G)$  is the maximum cardinality among all 2-packing sets of  $G$ . As usual, a 2-packing of cardinality  $\rho(G)$  is called a  $\rho(G)$ -set.

**Theorem 2.2.** *For any graph  $G$  with no isolated vertex and any nontrivial graph  $H$ ,*

$$\max\{\gamma_t(G), 2\rho(G)\} \leq \gamma_{\times 2}(G \circ H) \leq 2\gamma_t(G).$$

*Proof.* By Proposition 1.1 (i) and Theorem 1.8 we deduce that

$$\gamma_t(G) = \gamma_t(G \circ H) \leq \gamma_{\times 2}(G \circ H) \leq 2\gamma_t(G \circ H) = 2\gamma_t(G).$$

Now, for any  $\rho(G)$ -set  $X$  and any  $\gamma_{\times 2}(G \circ H)$ -set  $D$  we have that

$$\gamma_{\times 2}(G \circ H) = |D| = \sum_{u \in V(G)} |D \cap V(H_u)| \geq \sum_{u \in X} \sum_{w \in N[u]} |D \cap V(H_w)| \geq 2|X| = 2\rho(G).$$

Therefore, the proof is complete.  $\square$

We would point out that the upper bound  $\gamma_{\times 2}(G \circ H) \leq \min\{2\gamma_t(G), \gamma(G)\gamma_{\times 2}(H)\}$  was proposed in [12] for the particular case in which  $G$  and  $H$  are connected. Obviously, the connectivity is not needed, and the bound  $\gamma_{\times 2}(G \circ H) \leq \gamma(G)\gamma_{\times 2}(H)$  also holds for any graph  $G$  (even if  $G$  is empty) and any graph  $H$  with no isolated vertices.

In Theorem 2.4 we will show cases in which  $\gamma_{\times 2}(G \circ H) = 2\gamma_t(G)$ , while in Theorem 2.8 (i) and (ii) we will show cases in which  $\gamma_{\times 2}(G \circ H) = 2\rho(G)$  or  $\gamma_{\times 2}(G \circ H) = \gamma_t(G)$ .

**Corollary 2.3.** *If  $\gamma(G) = 1$ , then for any nontrivial graph  $H$ ,*

$$2 \leq \gamma_{\times 2}(G \circ H) \leq 4.$$

In Section 3 we characterize the graphs with  $\gamma_{\times 2}(G \circ H) \in \{2, 3\}$ . Hence, by Corollary 2.3 the graphs with  $\gamma_{\times 2}(G \circ H) = 4$  will be automatically characterized whenever  $\gamma(G) = 1$ .

**Theorem 2.4.** *If  $G$  is a graph with no isolated vertex and  $H$  is a nontrivial graph, then the following statements are equivalent.*

- (a)  $\gamma_{\times 2}(G \circ H) = 2\gamma_t(G)$ .
- (b)  $\gamma_{\times 2}(G \circ H) = \gamma_{tR}(G \circ H)$  and  $(\gamma_t(G) = \gamma(G) \text{ or } \gamma(H) \geq 2)$ .

*Proof.* Assume that  $\gamma_{\times 2}(G \circ H) = 2\gamma_t(G)$ . By Theorems 1.8 and 2.1 we deduce that

$$\gamma_{\{R2\}}(G \circ H) = \gamma_{\times 2}(G \circ H) = 2\gamma_t(G) = 2\gamma_t(G \circ H).$$

Hence, by Theorem 1.3 we have that  $\gamma_{\times 2}(G \circ H) = \gamma_{tR}(G \circ H)$  and  $\gamma(G \circ H) = \gamma_t(G \circ H) = \gamma_t(G)$ . Notice that  $\gamma_t(G \circ H) = \gamma_t(G)$  if and only if  $\gamma_t(G) = \gamma(G)$  or  $\gamma(H) \geq 2$ , by Theorem 1.7. Therefore, (b) follows.

Conversely, assume that (b) holds. By Theorem 2.1 we have that

$$\gamma_{\{R2\}}(G \circ H) = \gamma_{\times 2}(G \circ H) = \gamma_R(G \circ H). \quad (1)$$

Now, if  $\gamma(G) = \gamma(H)$  or  $\gamma(H) \geq 2$ , by Theorems 1.7 and 1.8 we deduce that

$$\gamma(G \circ H) = \gamma(G) = \gamma(G \circ H). \quad (2)$$

Hence, Theorem 1.3 and equations (1) and (2) lead to  $\gamma_{\times 2}(G \circ H) = \gamma_{\{R2\}}(G \circ H) = 2\gamma(G \circ H) = 2\gamma(G)$ , as required.  $\square$

It was shown in [11] that for any connected graph  $G$  of order  $n \geq 3$ ,  $\gamma(G) \leq \frac{2n}{3}$ . Hence, Proposition 1.1 (i) and Theorem 2.1 lead to the following result.

**Theorem 2.5.** *For any connected graph  $G$  of order  $n \geq 3$  and any graph  $H$ ,*

$$\gamma_{\times 2}(G \circ H) \leq 2 \left\lfloor \frac{2n}{3} \right\rfloor.$$

In order to show that the bound above is tight, we consider the case of rooted product graphs. Given a graph  $G$  and a graph  $H$  with root  $v \in V(H)$ , the rooted product  $G \bullet_v H$  is defined as the graph obtained from  $G$  and  $H$  by taking one copy of  $G$  and  $|V(G)|$  copies of  $H$  and identifying the  $i^{\text{th}}$  vertex of  $G$  with vertex  $v$  in the  $i^{\text{th}}$  copy of  $H$  for every  $i \in \{1, \dots, |V(G)|\}$ . For instance, the graph  $P_5 \bullet_v P_3$  where  $v$  is a leaf, is shown in Figure 1. Later, when we read Lemma 4.3, it will be easy to see that for  $n = |V(G \bullet_v P_3)| = 3|V(G)|$  we have that  $\gamma_{\times 2}((G \bullet_v P_3) \circ H) = 4|V(G)| = 2 \lfloor \frac{2n}{3} \rfloor$  whenever  $\gamma(H) \geq 3$ .

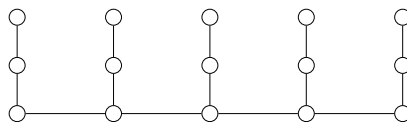

Figure 1: The graph  $P_5 \bullet_v P_3$

**Lemma 2.6.** *For any graph  $G$  with no isolated vertex and any nontrivial graph  $H$ , there exists a  $\gamma_{\times 2}(G \circ H)$ -set  $S$  such that  $|S \cap V(H_u)| \leq 2$ , for every  $u \in V(G)$ .*

*Proof.* Given a double dominating set  $S$  of  $G \circ H$ , we define the set  $S_3 = \{x \in V(G) : |S \cap V(H_x)| \geq 3\}$ . Let  $S$  be a  $\gamma_{\times 2}(G \circ H)$ -set such that  $|S_3|$  is minimum among all  $\gamma_{\times 2}(G \circ H)$ -sets. If  $|S_3| = 0$ , then we are done. Hence, we suppose that there exists  $u \in S_3$  and let  $(u, v) \in S$ . We assume that  $|S \cap V(H_u)|$  is minimum among all vertices in  $S_3$ . It is readily seen that if there exists  $u' \in N(u)$  such that  $|S \cap V(H_{u'})| \geq 2$ , then  $S' = S \setminus \{(u, v)\}$  is a double dominating set of  $G \circ H$ , which is a contradiction. Hence, if  $u' \in N(u)$ , then  $|S \cap V(H_{u'})| \leq 1$ , and in this case it is not difficult to check that for  $(u', v') \notin S$  the set  $S'' = (S \setminus \{(u, v)\}) \cup \{(u', v')\}$  is a  $\gamma_{\times 2}(G \circ H)$ -set such that  $|S''|$  is minimum among all  $\gamma_{\times 2}(G \circ H)$ -sets. If  $|S''| < |S|$ , then we obtain a contradiction, otherwise  $u \in S''$  and  $|S'' \cap V(H_u)|$  is minimum among all vertices in  $S''$ , so that we can successively repeat this process, until obtaining a contradiction. Therefore, the result follows.  $\square$



**Theorem 2.7.** *Let  $G$  be a graph with no isolated vertex and let  $H$  be a nontrivial graph.*

- (i) *If  $\gamma(H) = 1$ , then  $\gamma_{\times 2}(G \circ H) \leq \gamma_{t\{R2\}}(G)$ .*
- (ii) *If  $H$  has at least two universal vertices, then  $\gamma_{\times 2}(G \circ H) \leq 2\gamma(G)$ .*
- (iii) *If  $H$  has exactly one universal vertex, then  $\gamma_{\times 2}(G \circ H) = \gamma_{t\{R2\}}(G)$ .*
- (iv) *If  $\gamma(H) \geq 2$ , then  $\gamma_{\times 2}(G \circ H) \geq \gamma_{t\{R2\}}(G)$ .*

*Proof.* Let  $f$  be a  $\gamma_{t\{R2\}}(G)$ -function and let  $v$  be a universal vertex of  $H$ . Let  $f'$  be the function defined by  $f'(u, v) = f(u)$  for every  $u \in V(G)$  and  $f'(x, y) = 0$  whenever  $x \in V(G)$  and  $y \in V(H) \setminus \{v\}$ . It is readily seen that  $f'$  is a TR2DF on  $G \circ H$ . Hence, by Theorem 2.1 we conclude that  $\gamma_{\times 2}(G \circ H) = \gamma_{t\{R2\}}(G \circ H) \leq \omega(f') = \omega(f) = \gamma_{t\{R2\}}(G)$  and (i) follows.

Let  $D$  be a  $\gamma(G)$ -set and let  $y_1, y_2$  be two universal vertices of  $H$ . It is not difficult to see that  $S = D \times \{y_1, y_2\}$  is a double dominating set of  $G \circ H$ . Therefore,  $\gamma_{\times 2}(G \circ H) \leq |S| = 2\gamma(G)$  and (ii) follows.

From now on, let  $S$  be a  $\gamma_{\times 2}(G \circ H)$ -set that satisfies Lemma 2.6 and assume that either  $\gamma(H) \geq 2$  or  $H$  has exactly one universal vertex. Let  $g(V_0, V_1, V_2)$  be the function defined by  $g(u) = |S \cap V(H_u)|$  for every  $u \in V(G)$ . We claim that  $g$  is a TR2DF on  $G$ . It is clear that every vertex in  $V_1$  has to be adjacent to some vertex in  $V_1 \cup V_2$  and, if  $\gamma(H) \geq 2$  or  $H$  has exactly one universal vertex, then by Theorem 1.4 we have that  $\gamma_{\times 2}(H) \geq 3$ , which implies that every vertex in  $V_2$  has to be adjacent to some vertex in  $V_1 \cup V_2$ . Hence,  $V_1 \cup V_2$  is a total dominating set of  $G$ . Now, if  $x \in V_0$ , then  $S \cap V(H_x) = \emptyset$ , and so  $|N(V(H_x)) \cap S| \geq 2$ . Thus,  $g(N(x)) \geq 2$ , which implies that  $g$  is TR2DF on  $G$  and so  $\gamma_{t\{R2\}}(G) \leq \omega(g) = |S| = \gamma_{\times 2}(G \circ H)$ . Therefore, (iii) and (iv) follow.  $\square$

The following result is a direct consequence of Theorems 2.2 and 2.7. Recall that  $\gamma_{\times 2}(H) = 2$  if and only if  $H$  has at least two universal vertices (see Theorem 1.4).

**Theorem 2.8.** *Let  $G$  be a graph with no isolated vertex and let  $H$  be a nontrivial graph.*

- (i) *If  $\gamma(G) = \rho(G)$  and  $\gamma_{\times 2}(H) = 2$ , then  $\gamma_{\times 2}(G \circ H) = 2\gamma(G)$ .*
- (ii) *If  $\gamma_{t\{R2\}}(G) \in \{\gamma_t(G), 2\rho(G)\}$  and  $\gamma(H) = 1$ , then  $\gamma_{\times 2}(G \circ H) = \gamma_{t\{R2\}}(G)$ .*
- (iii) *If  $\gamma_{t\{R2\}}(G) = 2\gamma_t(G)$  and  $\gamma(H) \geq 2$ , then  $\gamma_{\times 2}(G \circ H) = \gamma_{t\{R2\}}(G)$ .*

It is well known that  $\gamma(T) = \rho(T)$  for any tree  $T$ . Hence, the following corollary is a direct consequence of Theorem 2.8.

**Corollary 2.9.** *For any tree  $T$  and any graph  $H$  with  $\gamma_{\times 2}(H) = 2$ ,*

$$\gamma_{\times 2}(T \circ H) = 2\gamma(T).$$

A *double total dominating set* of a graph  $G$  is a set  $S$  of vertices of  $G$  such that every vertex in  $V(G)$  is adjacent to at least two vertices in  $S$  [21]. The *double total domination number* of  $G$ , denoted by  $\gamma_{2,t}(G)$ , is the minimum cardinality among all double total dominating sets.

**Theorem 2.10.** [30] *If  $G$  is a graph of minimum degree greater than or equal to two, then for any graph  $H$ ,*

$$\gamma_{2,t}(G \circ H) \leq \gamma_{2,t}(G).$$

**Theorem 2.11.** *Let  $G$  be a graph of minimum degree greater than or equal to two and order  $n$ . The following statements hold.*

- (i) *For any graph  $H$ ,  $\gamma_{\times 2}(G \circ H) \leq \gamma_{2,t}(G)$ .*
- (ii) *For any graph  $H$ ,  $\gamma_{\times 2}(G \circ H) \leq n$ .*

*Proof.* Since every double total dominating set is a double dominating set, we deduce that  $\gamma_{\times 2}(G \circ H) \leq \gamma_{2,t}(G \circ H)$ . Hence, from Theorem 2.10 we deduce (i). Finally, since  $\gamma_{2,t}(G) \leq n$ , from (i) we deduce (ii).  $\square$

The following family  $\mathcal{H}_k$  of graphs was shown in [30]. A graph  $G$  belongs to  $\mathcal{H}_k$  if and only if it is constructed from a cycle  $C_k$  and  $k$  empty graphs  $N_{s_1}, \dots, N_{s_k}$  of order  $s_1, \dots, s_k$ , respectively, and joining by an edge each vertex from  $N_{s_i}$  with the vertices  $v_i$  and  $v_{i+1}$  of  $C_k$ . Here we are assuming that  $v_i$  is adjacent to  $v_{i+1}$  in  $C_k$ , where the subscripts are taken modulo  $k$ . Figure 2 shows a graph  $G$  belonging to  $\mathcal{H}_k$ , where  $k = 4$ ,  $s_1 = s_3 = 3$  and  $s_2 = s_4 = 2$ .

Notice that  $\gamma_{t\{R2\}}(G) = \gamma_{2,t}(G)$ , for every  $G \in \mathcal{H}_k$ . Hence, from Theorems 2.7 (iv) and 2.11 (i) we deduce that  $\gamma_{\times 2}(G \circ H) = \gamma_{2,t}(G)$  for any  $G \in \mathcal{H}_k$  and any graph  $H$  such that  $\gamma(H) \geq 2$ .

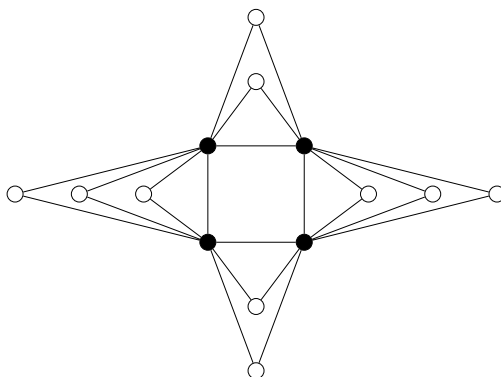

Figure 2: The set of black-coloured vertices is a  $\gamma_{2,t}(G)$ -set.

### 3 Small values of $\gamma_{\times 2}(G \circ H)$

First, we characterize the graphs with  $\gamma_{\times 2}(G \circ H) = 2$ .

**Theorem 3.1.** *For any nontrivial graph  $G$  and any graph  $H$ , the following statements are equivalent.*

- (i)  $\gamma_{\times 2}(G \circ H) = 2$ .
- (ii)  $\gamma(G) = \gamma(H) = 1$  and  $(\gamma_{\times 2}(G) = 2$  or  $\gamma_{\times 2}(H) = 2)$ .

*Proof.* Notice that  $G \circ H$  has at least two universal vertices if and only if  $\gamma(G) = \gamma(H) = 1$ , and also  $G$  has at least two universal vertices or  $H$  has at least two universal vertices. Hence, by Theorem 1.4 we conclude that (i) and (ii) are equivalent.  $\square$

Next, we characterize the graphs that satisfying  $\gamma_{\times 2}(G \circ H) = 3$ . Before we shall need the following definitions. For a set  $S \subseteq V(G \circ H)$  we define the following subsets of  $V(G)$ .

$$\mathcal{A}_S = \{v \in V(G) : |S \cap V(H_v)| \geq 2\};$$

$$\mathcal{B}_S = \{v \in V(G) : |S \cap V(H_v)| = 1\};$$

$$\mathcal{C}_S = \{v \in V(G) : S \cap V(H_v) = \emptyset\}.$$

**Theorem 3.2.** *For any nontrivial graphs  $G$  and  $H$ ,  $\gamma_{\times 2}(G \circ H) = 3$  if and only if one of the following conditions is satisfied.*

- (i)  $G \cong P_2$  and  $\gamma(H) = 2$ .
- (ii)  $G \not\cong P_2$  has at least two universal vertices and  $\gamma(H) \geq 2$ .
- (iii)  $G$  has exactly one universal vertex and either  $\gamma(H) = 2$  or  $H$  has exactly one universal vertex.
- (iv)  $G$  has exactly one universal vertex,  $\gamma_{2,t}(G) = 3$  and  $\gamma(H) \geq 3$ .
- (v)  $\gamma(G) = 2$  and  $\gamma_{2,t}(G) = 3$ .
- (vi)  $\gamma(G) = 2$ ,  $\gamma_{\times 2}(G) = 3 < \gamma_{2,t}(G)$  and  $\gamma(H) = 1$ .

*Proof.* Notice that with the above premises,  $G$  does not have isolated vertices. Let  $S$  be a  $\gamma_{\times 2}(G \circ H)$ -set that satisfies Lemma 2.6 and assume that  $|S| = 3$ . By Theorems 1.8 and 1.2 we have that  $3 = \gamma_{\times 2}(G \circ H) > \gamma(G \circ H) = \gamma(G) \geq 2$ , which implies that  $\gamma(G) = 2$  and so  $\gamma(G) \in \{1, 2\}$ . We differentiate two cases.

Case 1.  $\gamma(G) = 1$ . In this case, Theorem 3.1 leads to  $\gamma_{\times 2}(H) \geq 3$ . Now, we consider the following subcases.

Subcase 1.1.  $G \cong P_2$ . Notice that Theorem 3.1 leads to  $\gamma(H) \geq 2$ . Suppose that  $\gamma(H) \geq 3$  and let  $V(G) = \{u, w\}$ . Observe that  $S \cap V(H_u) \neq \emptyset$  and  $S \cap V(H_w) \neq \emptyset$ . Without loss of generality, let  $S \cap V(H_u) = \{(u, v_1), (u, v_2)\}$  and  $|S \cap V(H_w)| = 1$ . Since  $\gamma(H) \geq 3$ , we have that  $\{v_1, v_2\}$  is not a dominating set of  $H$ , which implies that no vertex in  $\{u\} \times (V(H) \setminus (N(v_1) \cup N(v_2)))$  has two neighbours in  $S$ , which is a contradiction. Hence  $\gamma(H) = 2$ . Therefore, (i) follows.

Subcase 1.2.  $G \not\cong P_2$  has at least two universal vertices. In this case,  $\gamma_{\times 2}(G) = 2$  and by Theorem 3.1 we deduce that  $\gamma(H) \geq 2$ . Thus, (ii) follows.

Subcase 1.3.  $G$  has exactly one universal vertex. If  $\gamma(H) \leq 2$ , then by Theorem 3.1 we deduce that either  $\gamma(H) = 2$  or  $H$  has exactly one universal vertex, so that (iii) follows. Assume

that  $\gamma(H) \geq 3$ . Recall that  $|S \cap V(H_x)| \leq 2$  for every  $x \in V(G)$ . Now, if there exist two vertices  $u, w \in V(G)$  and two vertices  $v_1, v_2 \in V(H)$  such that  $S \cap V(H_u) = \{(u, v_1), (u, v_2)\}$  and  $|S \cap V(H_w)| = 1$ , then we deduce that no vertex in  $\{u\} \times (V(H) \setminus (N(v_1) \cup N(v_2)))$  has two neighbours in  $S$ , which is a contradiction. Therefore,  $\mathcal{A}_S = \emptyset$  and  $\mathcal{B}_S$  has to be a  $\gamma_{2,t}(G)$ -set, as every vertex  $x \in V(G)$  satisfies  $|N(x) \cap \mathcal{B}_S| \geq 2$ . Therefore, (iv) follows.

Case 2.  $\gamma(G) = 2$ . In this case, Theorem 1.4 leads to  $\gamma_{\times 2}(G) \geq 3$ . If there exist two vertices  $u, w \in V(G)$  such that  $\mathcal{A}_S = \{u\}$  and  $\mathcal{B}_S = \{w\}$ , then  $\{u, w\}$  is a  $\gamma_t(G)$ -set, and so for any  $x \in N(w) \setminus N[u]$  we have that no vertex in  $V(H_x)$  has two neighbours in  $S$ , which is a contradiction. Therefore,  $\mathcal{A}_S = \emptyset$  and  $|\mathcal{B}_S| = 3$ , which implies that  $\mathcal{B}_S$  is a  $\gamma_{\times 2}(G)$ -set. Notice that either  $\langle \mathcal{B}_S \rangle \cong C_3$  or  $\langle \mathcal{B}_S \rangle \cong P_3$ . In the first case,  $\mathcal{B}_S$  is a  $\gamma_{2,t}(G)$ -set and (v) follows. Now, assume that  $\langle \mathcal{B}_S \rangle \cong P_3$ . If  $\gamma(H) \geq 2$ , then for any vertex  $x$  of degree one in  $\langle \mathcal{B}_S \rangle$  we have that  $V(H_x)$  have vertices which do not have two neighbours in  $S$ , which is a contradiction. Therefore,  $\gamma(H) = 1$  and if  $\gamma_{\times 2}(G) = \gamma_{2,t}(G)$ , then  $G$  satisfies (v), otherwise  $G$  satisfies (vi), by Theorem 2.11.

Conversely, notice that if  $G$  and  $H$  satisfy one of the six conditions above, then Theorem 3.1 leads to  $\gamma_{\times 2}(G \circ H) \geq 3$ . To conclude that  $\gamma_{\times 2}(G \circ H) = 3$ , we proceed to show how to define a double dominating set  $D$  of  $G \circ H$  of cardinality three for each of the six conditions.

- (i) Let  $\{v_1, v_2\}$  be a  $\gamma(H)$ -set and  $V(G) = \{u, w\}$ . In this case,  $D = \{(u, v_1), (u, v_2), (w, v_1)\}$ .
- (ii) Let  $u, w \in V(G)$  be two universal vertices,  $z \in V(G) \setminus \{u, w\}$  and  $v \in V(H)$ . In this case,  $D = \{(u, v), (w, v), (z, v)\}$ .
- (iii) Let  $u$  be a universal vertex of  $G$  and  $w \in V(G) \setminus \{u\}$ . If  $\{v_1, v_2\}$  is a  $\gamma(H)$ -set or  $v_1$  is a universal vertex of  $H$  and  $v_2 \in V(H) \setminus \{v_1\}$ , then we set  $D = \{(u, v_1), (u, v_2), (w, v_1)\}$ .
- (iv) Let  $X$  be a  $\gamma_{2,t}(G)$ -set and  $v \in V(H)$ . In this case,  $D = X \times \{v\}$ .
- (v) Let  $X$  be a  $\gamma_{2,t}(G)$ -set and  $v \in V(H)$ . In this case,  $D = X \times \{v\}$ .
- (vi) Let  $X$  be a  $\gamma_{\times 2}(G)$ -set and  $v$  a universal vertex of  $H$ . In this case,  $D = X \times \{v\}$ .

It is readily seen that in all cases  $D$  is a double dominating set of  $G \circ H$ . Therefore,  $\gamma_{\times 2}(G \circ H) = 3$ .  $\square$

The following result, which is a direct consequence of Theorems 2.2, 3.1 and 3.2, shows the cases when  $G$  is isomorphic to a complete graph or a star graph.

**Proposition 3.3.** *Let  $H$  be a nontrivial graph. For any integer  $n \geq 3$ , the following statements hold.*

- (i)  $\gamma_{\times 2}(K_n \circ H) = \begin{cases} 2 & \text{if } \gamma(H) = 1, \\ 3 & \text{otherwise.} \end{cases}$
- (ii)  $\gamma_{\times 2}(K_{1,n-1} \circ H) = \begin{cases} 2 & \text{if } \gamma_{\times 2}(H) = 2, \\ 3 & \text{if } \gamma_{\times 2}(H) \geq 3 \text{ and } \gamma(H) \leq 2, \\ 4 & \text{otherwise.} \end{cases}$

We now consider the cases in which  $G$  is a double star graph or a complete bipartite graph. The following result is a direct consequence of Theorems 2.2, 3.1 and 3.2.

**Proposition 3.4.** *Let  $H$  be a graph. For any integers  $n_2 \geq n_1 \geq 2$ , the following statements hold.*

- (i)  $\gamma_{\times 2}(S_{n_1, n_2} \circ H) = 4$ .
- (ii)  $\gamma_{\times 2}(K_{n_1, n_2} \circ H) = \begin{cases} 3 & \text{if } n_1 = 2 \text{ and } \gamma(H) = 1; \\ 4 & \text{otherwise.} \end{cases}$

## 4 All cases where $G \cong P_n$ or $G \cong C_n$

### 4.1 Cases where $\gamma(H) = 1$

**Proposition 4.1.** *Let  $n \geq 3$  be an integer and let  $H$  be a nontrivial graph. If  $\gamma(H) = 1$ , then*

$$\gamma_{\times 2}(P_n \circ H) = \begin{cases} 2 \lceil \frac{n}{3} \rceil + 1, & \text{if } \gamma_{\times 2}(H) \geq 3 \text{ and } n \equiv 0 \pmod{3}, \\ 2 \lceil \frac{n}{3} \rceil, & \text{otherwise.} \end{cases}$$

*Proof.* If  $\gamma_{\times 2}(H) = 2$ , then by Corollary 2.9 we deduce that  $\gamma_{\times 2}(P_n \circ H) = 2\gamma(P_n)$ . Now, if  $\gamma_{\times 2}(H) \geq 3$ , then  $H$  has exactly one universal vertex and by Theorem 2.7 (iii) we deduce that  $\gamma_{\times 2}(G \circ H) = \gamma_{\{R2\}}(P_n)$ .  $\square$

From now on we assume that  $V(C_n) = \{u_1, \dots, u_n\}$ , where the subscripts are taken modulo  $n$  and consecutive vertices are adjacent.

**Proposition 4.2.** *Let  $n \geq 3$  be an integer and let  $H$  be a graph. If  $\gamma(H) = 1$ , then*

$$\gamma_{\times 2}(C_n \circ H) = \lceil \frac{2n}{3} \rceil.$$

*Proof.* If  $H$  is a trivial graph, then we are done, by Remark 1.6. From now on we assume that  $H$  has at least two vertices. If  $\gamma(H) = 1$ , then by combining Theorem 2.7 (i) and Remark 1.6 (ii), we deduce that  $\gamma_{\times 2}(C_n \circ H) \leq \lceil \frac{2n}{3} \rceil$ .

Now, let  $S$  be a  $\gamma_{\times 2}(C_n \circ H)$ -set. Notice that for any  $i \in \{1, \dots, n\}$  we have that

$$\left| S \cap \left( \bigcup_{j=0}^2 V(H_{u_{i+j}}) \right) \right| \geq 2.$$

Hence,

$$3\gamma_{\times 2}(C_n \circ H) = 3|S| = \sum_{i=1}^n \left| S \cap \left( \bigcup_{j=0}^2 V(H_{u_{i+j}}) \right) \right| \geq 2n.$$

Therefore,  $\gamma_{\times 2}(C_n \circ H) \geq \lceil \frac{2n}{3} \rceil$ , and the result follows.  $\square$

## 4.2 Cases where $\gamma(H) = 2$

To begin this subsection we need to state the following four lemmas.

**Lemma 4.3.** *Let  $G$  be a nontrivial connected graph and let  $H$  be a graph. The following statements hold for every  $\gamma_{\times 2}(G \circ H)$ -set  $S$  that satisfies Lemma 2.6.*

(i) *If  $\gamma(H) \geq 2$  and  $x \in \mathcal{B}_S \cup \mathcal{C}_S$ , then  $\sum_{u \in N(x)} |S \cap V(H_u)| \geq 2$ .*

(ii) *If  $\gamma(H) = 2$  and  $x \in \mathcal{A}_S$ , then  $\sum_{u \in N(x)} |S \cap V(H_u)| \geq 1$ .*

(iii) *If  $\gamma(H) \geq 3$  and  $x \in V(G)$ , then  $\sum_{u \in N(x)} |S \cap V(H_u)| \geq 2$ .*

*Proof.* First, we suppose that  $\gamma(H) = 2$ . If there exists either a vertex  $x \in \mathcal{B}_S \cup \mathcal{C}_S$  such that  $\sum_{u \in N(x)} |S \cap V(H_u)| \leq 1$  or a vertex  $x \in \mathcal{A}_S$  such that  $\sum_{u \in N(x)} |S \cap V(H_u)| = 0$ , then there exists a vertex in  $V(H_x) \setminus S$  which does not have two neighbours in  $S$ . Therefore, (ii) follows, and (i) follows for  $\gamma(H) = 2$ . Now, let  $x \in V(G)$ . Since  $S$  satisfies Lemma 2.6, if  $\gamma(H) \geq 3$ , then there exists a vertex in  $V(H_x) \setminus S$  which does not have neighbours in  $S \cap V(H_x)$ , which implies that  $\sum_{u \in N(x)} |S \cap V(H_u)| \geq 2$  and so (i) and (iii) follows. Therefore, the proof is complete.  $\square$

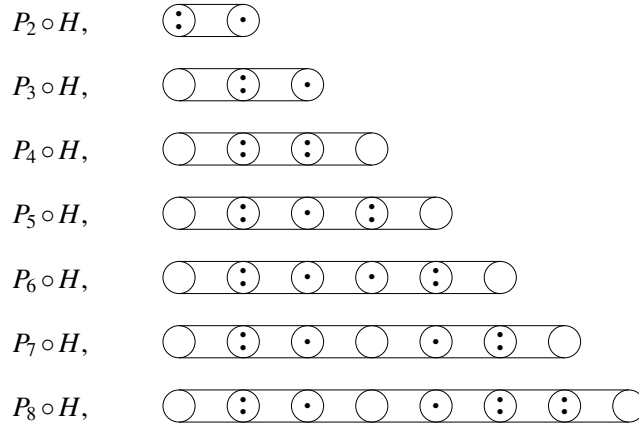

Figure 3: The scheme used in the proof of Lemma 4.4.

**Lemma 4.4.** *For any integer  $n \geq 3$  and any graph  $H$  with  $\gamma(H) = 2$ ,*

$$\gamma_{\times 2}(P_n \circ H) \leq \begin{cases} n - \lfloor \frac{n}{7} \rfloor + 1 & \text{if } n \equiv 1, 2 \pmod{7}, \\ n - \lfloor \frac{n}{7} \rfloor & \text{otherwise.} \end{cases}$$

*Proof.* In Figure 3 we show how to construct a double dominating set  $S$  of  $P_n \circ H$  for  $n \in \{2, \dots, 8\}$ . In this scheme, the circles represent the copies of  $H$  in  $P_n \circ H$ , two dots in a circle represent two vertices belonging to  $S$ , which form a dominating set of the corresponding copy of  $H$ , while a single dot in a circle represents one vertex belonging to  $S$ .

We now proceed to describe the construction of  $S$  for any  $n = 7q + r$ , where  $q \geq 1$  and  $0 \leq r \leq 6$ . We partition  $V(P_n) = \{u_1, \dots, u_n\}$  into  $q$  sets of cardinality 7 and for  $r \geq 1$  one additional set of cardinality  $r$ , in such a way that the subgraph induced by all these sets are paths. For any  $r \neq 1$ , the restriction of  $S$  to each of these  $q$  paths of length 7 corresponds to the scheme associated with  $P_7 \circ H$  in Figure 3, while for the path of length  $r$  (if any) we take the scheme associated with  $P_r \circ H$ . The case  $r = 1$  and  $q \geq 2$  is slightly different, as for the first  $q - 1$  paths of length 7 we take the scheme associated with  $P_7 \circ H$  and for the path associated with the last 8 vertices of  $P_n$  we take the scheme associated with  $P_8 \circ H$ .

Notice that, for  $n \equiv 1, 2 \pmod{7}$ , we have that  $\gamma_{\times 2}(P_n \circ H) \leq |S| = 6q + r + 1 = n - \lfloor \frac{n}{7} \rfloor + 1$ , while for  $n \not\equiv 1, 2 \pmod{7}$  we have  $\gamma_{\times 2}(P_n \circ H) \leq |S| = 6q + r = n - \lfloor \frac{n}{7} \rfloor$ . Therefore, the result follows.  $\square$

**Lemma 4.5.** *Let  $P_7 = w_1, \dots, w_7$  be a subgraph of  $C_n$ . Let  $H$  be a graph such that  $\gamma(H) = 2$  and  $W = \{w_1, \dots, w_7\} \times V(H)$ . If  $S$  is a double dominating set of  $C_n \circ H$  which satisfies Lemma 2.6, then*

$$|S \cap W| \geq 6.$$

*Proof.* By Lemma 4.3 (i) and (ii) we have that  $|S \cap (\{w_1, w_2, w_3\} \times V(H))| \geq 2$  and  $|S \cap (\{w_4, w_5, w_6, w_7\} \times V(H))| \geq 3$ . If  $|S \cap (\{w_1, w_2, w_3\} \times V(H))| \geq 3$ , then we are done. Hence, we assume that  $|S \cap (\{w_1, w_2, w_3\} \times V(H))| = 2$ . In this case, and by applying again Lemma 4.3 (i) and (ii) we deduce that  $|S \cap (\{w_4, w_5, w_6, w_7\} \times V(H))| \geq 4$ , which implies that  $|S \cap W| \geq 6$ , as desired. Therefore, the proof is complete.  $\square$

**Lemma 4.6.** *For any integer  $n \geq 3$  and any graph  $H$  with  $\gamma(H) = 2$ ,*

$$\gamma_{\times 2}(C_n \circ H) \geq \begin{cases} n - \lfloor \frac{n}{7} \rfloor + 1 & \text{if } n \equiv 1, 2 \pmod{7}, \\ n - \lfloor \frac{n}{7} \rfloor & \text{otherwise.} \end{cases}$$

*Proof.* It is easy to check that  $\gamma_{\times 2}(C_n \circ H) = n$  for every  $n \in \{3, 4, 5, 6\}$ . Now, let  $n = 7q + r$ , with  $0 \leq r \leq 6$  and  $q \geq 1$ . Let  $S$  be a  $\gamma_{\times 2}(C_n \circ H)$ -set that satisfies Lemma 2.6.

If  $r = 0$ , then by Lemma 4.5 we have that  $|S| \geq 6q = n - \lfloor \frac{n}{7} \rfloor$ . From now on we assume that  $r \geq 1$ . By Theorem 1.5 and Lemma 4.4 we deduce that  $\gamma_{\times 2}(C_n \circ H) \leq \gamma_{\times 2}(P_n \circ H) < n$ , which implies that  $\mathcal{A}_S \neq \emptyset$ , otherwise there exists  $u \in V(C_n)$  such that  $N(u) \cap \mathcal{C}_S \neq \emptyset$  and so  $|N(u) \cap \mathcal{B}_S| \leq 1$ , which is a contradiction. Let  $x \in \mathcal{A}_S$  and, without loss of generality, we can label the vertices of  $C_n$  in such a way that  $x = u_1$ , and  $u_2 \in \mathcal{A}_S \cup \mathcal{B}_S$  whenever  $r \geq 2$ . We partition  $V(C_n)$  into  $X = \{u_1, \dots, u_r\}$  and  $Y = \{u_{r+1}, \dots, u_n\}$ . Notice that Lemma 4.5 leads to  $|S \cap (Y \times V(H))| \geq 6q$ .

Now, if  $r \in \{1, 2\}$ , then  $|S \cap (X \times V(H))| \geq r + 1$ , which implies that  $|S| \geq r + 1 + 6q = n - \lfloor \frac{n}{7} \rfloor + 1$ . Analogously, if  $r = 3$ , then  $|S \cap (X \times V(H))| \geq r$  and so  $|S| \geq r + 6q = n - \lfloor \frac{n}{7} \rfloor$ .

Finally, if  $r \in \{4, 5, 6\}$ , then by Lemma 4.3 (i) and (ii) we deduce that  $|S \cap (X \times V(H))| \geq r$ , which implies that  $|S| \geq r + 6q = n - \lfloor \frac{n}{7} \rfloor$ .  $\square$

The following result is a direct consequence of Theorem 1.5 and Lemmas 4.4 and 4.6.

**Proposition 4.7.** *For any integer  $n \geq 3$  and any graph  $H$  with  $\gamma(H) = 2$ ,*

$$\gamma_{\times 2}(C_n \circ H) = \gamma_{\times 2}(P_n \circ H) = \begin{cases} n - \lfloor \frac{n}{7} \rfloor + 1 & \text{if } n \equiv 1, 2 \pmod{7}, \\ n - \lfloor \frac{n}{7} \rfloor & \text{otherwise.} \end{cases}$$

### 4.3 Cases where $\gamma(H) \geq 3$

To begin this subsection we need to recall the following well-known result.

**Remark 4.8.** [21] *For any integer  $n \geq 3$ ,*

$$\gamma(P_n) = \gamma(C_n) = \begin{cases} \frac{n}{2} & \text{if } n \equiv 0 \pmod{4}, \\ \frac{n+1}{2} & \text{if } n \equiv 1, 3 \pmod{4}, \\ \frac{n}{2} + 1 & \text{if } n \equiv 2 \pmod{4}. \end{cases}$$

**Lemma 4.9.** *Let  $P_n = u_1 u_2 \dots u_n$  be a path of order  $n \geq 6$ , where consecutive vertices are adjacent, and let  $H$  be a graph. If  $\gamma(H) \geq 3$ , then there exists a  $\gamma_{\times 2}(P_n \circ H)$ -set  $S$  such that  $u_n, u_{n-3} \in \mathcal{C}_S$  and  $u_{n-1}, u_{n-2} \in \mathcal{A}_S$ .*

*Proof.* Let  $S$  be a  $\gamma_{\times 2}(P_n \circ H)$ -set that satisfies Lemma 2.6 such that  $|\mathcal{A}_S|$  is maximum. First, we observe that  $u_{n-1} \in \mathcal{A}_S$  by Lemma 4.3. Now, by applying again Lemma 4.3, we have that  $|S \cap V(H_{u_n})| + |S \cap V(H_{u_{n-2}})| \geq 2$ . Hence, without loss of generality we can assume that  $u_{n-2} \in \mathcal{A}_S$  and  $u_n \in \mathcal{C}_S$  as  $|\mathcal{A}_S|$  is maximum. If  $u_{n-3} \in \mathcal{C}_S$ , then we are done. On the other hand, if  $u_{n-3} \notin \mathcal{C}_S$ , then as every vertex of  $V(H_{u_{n-3}})$  has two neighbours in  $S \cap V(H_{u_{n-2}})$ , we can redefine  $S$  by replacing the vertices in  $S \cap V(H_{u_{n-3}})$  with vertices in  $V(H_{u_{n-4}}) \cup V(H_{u_{n-5}})$  and obtain a new  $\gamma_{\times 2}(P_n \circ H)$ -set  $S$  satisfying that  $u_{n-3} \in \mathcal{C}_S$ , as desired. Therefore, the result follows.  $\square$

**Proposition 4.10.** *Let  $n \geq 3$  be an integer and let  $H$  be a graph. If  $\gamma(H) \geq 3$ , then*

$$\gamma_{\times 2}(P_n \circ H) = 2\gamma(P_n) = \begin{cases} n & \text{if } n \equiv 0 \pmod{4}, \\ n+1 & \text{if } n \equiv 1, 3 \pmod{4}, \\ n+2 & \text{if } n \equiv 2 \pmod{4}. \end{cases}$$

*Proof.* Since Proposition 1.1 leads to  $\gamma_{\times 2}(P_n \circ H) \leq 2\gamma(P_n)$ , we only need to prove that  $\gamma_{\times 2}(P_n \circ H) \geq 2\gamma(P_n)$ . We proceed by induction on  $n$ . By Propositions 3.3 and 3.4 we obtain that  $\gamma_{\times 2}(P_n \circ H) = 2\gamma(P_n)$  for  $n = 3, 4$ . By Lemma 4.3 it is easy to see that  $\gamma_{\times 2}(P_5 \circ H) = 2\gamma(P_5)$ . This establishes the base case. Now, we assume that  $n \geq 6$  and that  $\gamma_{\times 2}(P_k \circ H) \geq 2\gamma(P_k)$  for  $k < n$ . Let  $S$  be a  $\gamma_{\times 2}(P_n \circ H)$ -set that satisfies Lemma 4.9. Let  $D = V(P_n \circ H) \setminus (\cup_{i=0}^3 V(H_{u_{n-i}}))$ . Notice that  $S \cap D$  is a double dominating set of  $(P_n \circ H) - D \cong P_{n-4} \circ H$ . Hence, by applying the induction hypothesis,

$$\gamma_{\times 2}(P_n \circ H) \geq \gamma_{\times 2}(P_{n-4} \circ H) + 4 \geq 2\gamma(P_{n-4}) + 4 \geq 2\gamma(P_n),$$

as desired. To conclude the proof we apply Remark 4.8.  $\square$



**Proposition 4.11.** *Let  $n \geq 3$  be an integer and let  $H$  be a graph. If  $\gamma(H) \geq 3$ , then*

$$\gamma_{\times 2}(C_n \circ H) = n.$$

*Proof.* From Theorem 2.11 we know that  $\gamma_{\times 2}(C_n \circ H) \leq n$ . We only need to prove that  $\gamma_{\times 2}(C_n \circ H) \geq n$ . Let  $S$  be a  $\gamma_{\times 2}(G \circ H)$ -set that satisfies Lemma 2.6. Since  $\gamma(H) \geq 3$ , by Lemma 4.3 (iii) we deduce that

$$2\gamma_{\times 2}(C_n \circ H) = 2|S| = \sum_{x \in V(C_n)} \sum_{u \in N(x)} |S \cap V(H_u)| \geq 2n.$$

Therefore, the result follows. □

## References

- [1] H. Abdollahzadeh Ahangar, M. A. Henning, V. Samodivkin, I. G. Yero, Total Roman domination in graphs, *Appl. Anal. Discrete Math.* **10** (2016) 501–517.
- [2] J. Amjadi, S. M. Sheikholeslami, M. Soroudi, On the total Roman domination in trees, *Discuss. Math. Graph Theory* **39** (2019) 519–532.
- [3] B. H. Arriola, S. R. Canoy, Jr., Doubly connected domination in the corona and lexicographic product of graphs, *Appl. Math. Sci.* **8** (29-32) (2014) 1521–1533.
- [4] M. Blidia, M. Chellali, T. W. Haynes, M. A. Henning, Independent and double domination in trees, *Util. Math.* **70** (2006) 159–173.
- [5] S. Brezovnik, T.K. Šumenjak, Complexity of k-rainbow independent domination and some results on the lexicographic product of graphs. *Appl. Math. Comput.* **349** (2019) 214–220.
- [6] S. Cabrera García, A. Cabrera Martínez, F. A. Hernández Mira, I.G. Yero, Total Roman  $\{2\}$ -domination in graphs, *Quaestiones Mathematicae*. In press with DOI: 10.2989/16073606.2019.1695230
- [7] A. Cabrera Martínez, S. Cabrera García, A. Carrión García, Further results on the total Roman domination in graphs, *Mathematics* **8**(3) (2020) 349.
- [8] A. Cabrera Martínez and J.A. Rodríguez-Velázquez, Total protection of lexicographic product graphs. Submitted.
- [9] N. Campanelli, D. Kuziak, Total Roman domination in the lexicographic product of graphs, *Discrete Appl. Math.* **263** (2019) 88–95.
- [10] M. Chellali, T. Haynes, On paired and double domination in graphs, *Util. Math.* **67** (2005) 161–171.
- [11] E. J. Cockayne, R. M. Dawes, S. T. Hedetniemi, Total domination in graphs, *Networks* **10** (3) (1980) 211–219.

- [12] A. M. Cuivillas, S. R., Jr. Canoy, Double domination in graphs under some binary operations, *Appl. Math. Sci.* **8** (2014) 2015–2024.
- [13] M. Dettlaff, M. Lemańska, J. A. Rodríguez-Velázquez, R. Zuazua, On the super domination number of lexicographic product graphs, *Discrete Appl. Math.* **263** (2019) 118–129.
- [14] P. Dorbec, M. Mollard, S. Klavžar, S. Špacapan, Power domination in product graphs, *SIAM J. Discrete Math.* **22** (2) (2008) 554–567.
- [15] M. Hajiana, N. J. Rad, A new lower bound on the double domination number of a graph, *Discrete Appl. Math.* **254** (2019) 280–282.
- [16] R. Hammack, W. Imrich, S. Klavzar, Handbook of product graphs, Discrete Mathematics and its Applications, 2nd ed., CRC Press, 2011.
- [17] J. Harant, M. A. Henning, On double domination in graphs, *Discuss. Math. Graph Theory* **25** (2005) 29–34.
- [18] F. Harary, T.W. Haynes, Double domination in graphs, *Ars. Combin.* **55** (2000) 201–213.
- [19] T. Haynes, S. Hedetniemi, P. Slater, Domination in Graphs: Volume 2: Advanced Topics, Chapman & Hall/CRC Pure and Applied Mathematics, Taylor & Francis, 1998.
- [20] T. W. Haynes, S. T. Hedetniemi, P. J. Slater, Fundamentals of Domination in Graphs, Chapman and Hall/CRC Pure and Applied Mathematics Series, Marcel Dekker, Inc. New York, 1998.
- [21] M.A. Henning, A. Yeo, Total domination in graphs. Springer, New York, USA, 2013.
- [22] W. Imrich, S. Klavzar, Product graphs, structure and recognition, Wiley-Interscience series in discrete mathematics and optimization, Wiley, 2000.
- [23] S. Khelifi, M. Chellali, Double domination critical and stable graphs upon vertex removal, *Discuss. Math. Graph Theory* **32** (4) (2012) 643–657.
- [24] C.-H. Liu, G. J. Chang, Roman domination on strongly chordal graphs. *J. Comb. Optim.* **26** (2013) 608–619.
- [25] J. Liu, X. Zhang, J. Meng, Domination in lexicographic product digraphs, *Ars Combin.* **120** (2015) 23–32.
- [26] H. Ma, J. Liu, The twin domination number of lexicographic product of digraphs. *J. Nat. Sci. Hunan Norm. Univ.* **39** (6) (2016) 80–84.
- [27] R. J. Nowakowski, D. F. Rall, Associative graph products and their independence, domination and coloring numbers, *Discuss. Math. Graph Theory* **16** (1996) 53–79.
- [28] T. K. Šumenjak, P. Pavlič, A. Tepeh, On the Roman domination in the lexicographic product of graphs, *Discrete Appl. Math.* **160** (13) (2012) 2030–2036.

- [29] T. K. Šumenjak, D. F. Rall, A. Tepeh, Rainbow domination in the lexicographic product of graphs, *Discrete Appl. Math.* **161** (13-14) (2013) 2133–2141.
- [30] M. Valveny, H. Pérez-Rosés, J. A. Rodríguez-Velázquez, On the weak Roman domination number of lexicographic product graphs, *Discrete Appl. Math.* **263** (2019) 257–270.
- [31] X. Zhang, J. Liu, J. Meng, Domination in lexicographic product graphs, *Ars Combin.* **101** (2011) 251–256.

## Chapter 5

# Secure $w$ -domination in graphs

This chapter includes a complete copy of the following paper.

A. Cabrera Martínez, A. Estrada-Moreno, J. A. Rodríguez-Velázquez. Secure  $w$ -domination in graphs, *Symmetry* (2020) 12(12), 1948.

URL: <https://doi.org/10.3390/sym12121948>

Quality indicators:

2019 JCR Impact factor: 2.645, Q2 (29/71), Multidisciplinary, Sciences.



Article

# Secure $w$ -Domination in Graphs

Abel Cabrera Martínez , Alejandro Estrada-Moreno \* and Juan A. Rodríguez-Velázquez

Departament d'Enginyeria Informàtica i Matemàtiques, Universitat Rovira i Virgili, Av. Països Catalans 26, 43007 Tarragona, Spain; abel.cabrera@urv.cat (A.C.M.); juanalberto.rodriguez@urv.cat (J.A.R.-V.)

\* Correspondence: alejandro.estrada@urv.cat

Received: 31 October 2020; Accepted: 23 November 2020; Published: 25 November 2020



**Abstract:** This paper introduces a general approach to the idea of protection of graphs, which encompasses the known variants of secure domination and introduces new ones. Specifically, we introduce the study of secure  $w$ -domination in graphs, where  $w = (w_0, w_1, \dots, w_l)$  is a vector of nonnegative integers such that  $w_0 \geq 1$ . The secure  $w$ -domination number is defined as follows. Let  $G$  be a graph and  $N(v)$  the open neighborhood of  $v \in V(G)$ . We say that a function  $f : V(G) \rightarrow \{0, 1, \dots, l\}$  is a  $w$ -dominating function if  $f(N(v)) = \sum_{u \in N(v)} f(u) \geq w_i$  for every vertex  $v$  with  $f(v) = i$ . The weight of  $f$  is defined to be  $\omega(f) = \sum_{v \in V(G)} f(v)$ . Given a  $w$ -dominating function  $f$  and any pair of adjacent vertices  $v, u \in V(G)$  with  $f(v) = 0$  and  $f(u) > 0$ , the function  $f_{u \rightarrow v}$  is defined by  $f_{u \rightarrow v}(v) = 1, f_{u \rightarrow v}(u) = f(u) - 1$  and  $f_{u \rightarrow v}(x) = f(x)$  for every  $x \in V(G) \setminus \{u, v\}$ . We say that a  $w$ -dominating function  $f$  is a secure  $w$ -dominating function if for every  $v$  with  $f(v) = 0$ , there exists  $u \in N(v)$  such that  $f(u) > 0$  and  $f_{u \rightarrow v}$  is a  $w$ -dominating function as well. The secure  $w$ -domination number of  $G$ , denoted by  $\gamma_w^s(G)$ , is the minimum weight among all secure  $w$ -dominating functions. This paper provides fundamental results on  $\gamma_w^s(G)$  and raises the challenge of conducting a detailed study of the topic.

**Keywords:** secure domination; secure Italian domination; weak roman domination;  $w$ -domination

## 1. Introduction

Let  $\mathbb{Z}^+ = \{1, 2, 3, \dots\}$  and  $\mathbb{N} = \mathbb{Z}^+ \cup \{0\}$  be the sets of positive and nonnegative integers, respectively. Let  $G$  be a graph,  $l \in \mathbb{Z}^+$  and  $f : V(G) \rightarrow \{0, \dots, l\}$  a function. Let  $V_i = \{v \in V(G) : f(v) = i\}$  for every  $i \in \{0, \dots, l\}$ . We identify  $f$  with the subsets  $V_0, \dots, V_l$  associated with it, and thus we use the unified notation  $f(V_0, \dots, V_l)$  for the function and these associated subsets. The weight of  $f$  is defined to be

$$\omega(f) = f(V(G)) = \sum_{i=1}^l i|V_i|.$$

Let  $w = (w_0, \dots, w_l) \in \mathbb{Z}^+ \times \mathbb{N}^l$  such that  $w_0 \geq 1$ . As defined in [1], a function  $f(V_0, \dots, V_l)$  is a  $w$ -dominating function if  $f(N(v)) \geq w_i$  for every  $v \in V_i$ . The  $w$ -domination number of  $G$ , denoted by  $\gamma_w(G)$ , is the minimum weight among all  $w$ -dominating functions. For simplicity, a  $w$ -dominating function  $f$  of weight  $\omega(f) = \gamma_w(G)$  is called a  $\gamma_w(G)$ -function. For fundamental results on the  $w$ -domination number of a graph, we refer the interested readers to the paper by Cabrera et al. [1], where the theory of  $w$ -domination in graphs is introduced.

The definition of  $w$ -domination number encompasses the definition of several well-known domination parameters and introduces new ones. For instance, we highlight the following particular cases of known domination parameters that we define here in terms of  $w$ -domination: the domination number  $\gamma(G) = \gamma_{(1,0)}(G) = \gamma_{(1,0,\dots,0)}(G)$ , the total domination number  $\gamma_t(G) = \gamma_{(1,1)}(G) = \gamma_{(1,\dots,1)}(G)$ , the  $k$ -domination number  $\gamma_k(G) = \gamma_{(k,0)}(G)$ , the  $k$ -tuple domination number  $\gamma_{\times k}(G) = \gamma_{(k,k-1)}(G)$ , the  $k$ -tuple total domination number  $\gamma_{\times k,t}(G) = \gamma_{(k,k)}(G)$ , the Italian domination number

$\gamma_I(G) = \gamma_{(2,0,0)}(G)$ , the total Italian domination number  $\gamma_{II}(G) = \gamma_{(2,1,1)}(G)$ , and the  $\{k\}$ -domination number  $\gamma_{\{k\}}(G) = \gamma_{(k,k-1,\dots,0)}(G)$ . In these definitions, the appropriate restrictions on the minimum degree of  $G$  are assumed, when needed.

For any function  $f(V_0, \dots, V_l)$  and any pair of adjacent vertices  $v \in V_0$  and  $u \in V(G) \setminus V_0$ , the function  $f_{u \rightarrow v}$  is defined by  $f_{u \rightarrow v}(v) = 1$ ,  $f_{u \rightarrow v}(u) = f(u) - 1$  and  $f_{u \rightarrow v}(x) = f(x)$  whenever  $x \in V(G) \setminus \{u, v\}$ .

We say that a  $w$ -dominating function  $f(V_0, \dots, V_l)$  is a *secure  $w$ -dominating function* if for every  $v \in V_0$  there exists  $u \in N(v) \setminus V_0$  such that  $f_{u \rightarrow v}$  is a  $w$ -dominating function as well. The *secure  $w$ -domination number* of  $G$ , denoted by  $\gamma_w^s(G)$ , is the minimum weight among all secure  $w$ -dominating functions. For simplicity, a secure  $w$ -dominating function  $f$  of weight  $\omega(f) = \gamma_w^s(G)$  is called a  $\gamma_w^s(G)$ -function. This approach to the theory of secure domination covers the different versions of secure domination known so far. For instance, we emphasize the following cases of known parameters that we define here in terms of secure  $w$ -domination.

- The *secure domination number* of  $G$  is defined to be  $\gamma_s(G) = \gamma_{(1,0)}^s(G)$ . In this case, for any secure  $(1,0)$ -dominating function  $f(V_0, V_1)$ , the set  $V_1$  is known as a *secure dominating set*. This concept was introduced by Cockayne et al. [2] and studied further in several papers (e.g., [3–9]).
- The *secure total domination number* of a graph  $G$  of minimum degree at least one is defined to be  $\gamma_{st}(G) = \gamma_{(1,1)}^s(G)$ . In this case, for any secure  $(1,1)$ -dominating function  $f(V_0, V_1)$ , the set  $V_1$  is known as a *secure total dominating set* of  $G$ . This concept was introduced by Benecke et al. [10] and studied further in several papers (e.g., [7,11–14]).
- The *weak Roman domination number* of a graph  $G$  is defined to be  $\gamma_r(G) = \gamma_{(1,0,0)}^s(G)$ . This concept was introduced by Henning and Hedetniemi [15] and studied further in several papers (e.g., [5,6,16,17]).
- The *total weak Roman domination number* of a graph  $G$  of minimum degree at least one is defined to be  $\gamma_{tr}(G) = \gamma_{(1,1,1)}^s(G)$ . This concept was introduced by Cabrera et al. in [12] and studied further in [18].
- The *secure Italian domination number* of  $G$  is defined to be  $\gamma_I^s(G) = \gamma_{(2,0,0)}^s(G)$ . This parameter was introduced by Dettlaff et al. [19].

For the graphs shown in Figure 1, we have the following:

- $\gamma_{(1,1)}^s(G_1) = \gamma_{(2,0)}^s(G_1) = \gamma_{(2,1)}^s(G_1) = \gamma_{(2,0)}(G_1) = \gamma_{(2,1)}(G_1) = \gamma_{(1,1,0)}^s(G_1) = \gamma_{(1,1,1)}^s(G_1) = \gamma_{(2,0,0)}^s(G_1) = \gamma_{(2,1,0)}^s(G_1) = \gamma_{(2,0,0)}(G_1) = \gamma_{(2,1,0)}(G_1) = \gamma_{(2,2,0)}(G_1) = \gamma_{(2,2,1)}(G_1) = \gamma_{(2,2,2)}(G_1) = 4$  and  $\gamma_{(2,2)}^s(G_1) = \gamma_{(2,2)}(G_1) = \gamma_{(2,2,0)}^s(G_1) = \gamma_{(2,2,1)}^s(G_1) = \gamma_{(2,2,2)}^s(G_1) = \gamma_{(3,0,0)}^s(G_1) = \gamma_{(3,1,0)}^s(G_1) = \gamma_{(3,1,1)}^s(G_1) = \gamma_{(3,2,0)}^s(G_1) = \gamma_{(3,2,1)}^s(G_1) = \gamma_{(3,2,2)}^s(G_1) = \gamma_{(3,0,0)}(G_1) = \gamma_{(3,1,0)}(G_1) = \gamma_{(3,1,1)}(G_1) = \gamma_{(3,2,0)}(G_1) = \gamma_{(3,2,1)}(G_1) = \gamma_{(3,2,2)}(G_1) = 6$ .
- $\gamma_{(1,1)}^s(G_2) = \gamma_{(1,1,0)}^s(G_2) = \gamma_{(1,1,1)}^s(G_2) = \gamma_{(2,2,0)}(G_2) = \gamma_{(2,2,1)}(G_2) = \gamma_{(2,2,2)}(G_2) = 3$ .
- $\gamma_{(1,1)}^s(G_3) = \gamma_{(1,1,0)}^s(G_3) = \gamma_{(1,1,1)}^s(G_3) = \gamma_{(2,1,0)}(G_3) = \gamma_{(3,0,0)}(G_3) = 3 < 4 = \gamma_{(2,0,0)}^s(G_3) = \gamma_{(2,1,0)}^s(G_3) = \gamma_{(3,1,0)}^s(G_3) = \gamma_{(2,2,0)}(G_3) = \gamma_{(2,2,1)}(G_3) = \gamma_{(2,2,2)}(G_3) = \gamma_{(3,2,0)}(G_3) < 5 = \gamma_{(2,2,0)}^s(G_3) = \gamma_{(3,2,0)}^s(G_3) = \gamma_{(2,2,1)}^s(G_3) = \gamma_{(2,2,2)}^s(G_3) = \gamma_{(3,1,1)}^s(G_3) = \gamma_{(3,2,1)}^s(G_3) = \gamma_{(3,2,1)}(G_3) = \gamma_{(3,2,2)}(G_3) < 6 = \gamma_{(3,2,2)}^s(G_3)$ .

This paper is devoted to providing general results on secure  $w$ -domination. We assume that the reader is familiar with the basic concepts, notation, and terminology of domination in graph. If this is not the case, we suggest the textbooks [20,21]. For the remainder of the paper, definitions are introduced whenever a concept is needed.

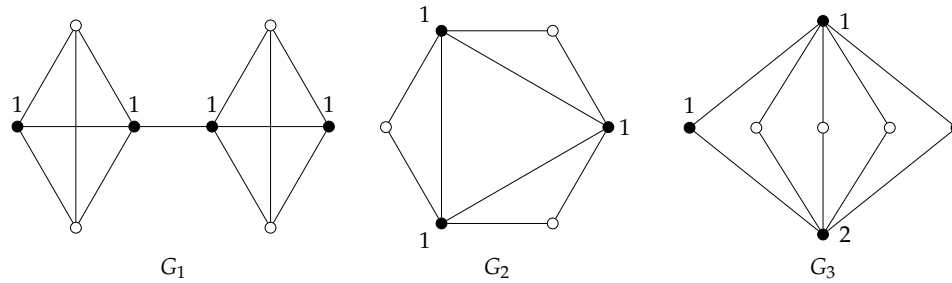

**Figure 1.** The labels of black-colored vertices describe the positive weights of a  $\gamma_{(2,1,0)}^s(G_1)$ -function, a  $\gamma_{(1,1,1)}^s(G_2)$ -function, and a  $\gamma_{(2,2,2)}^s(G_3)$ -function, respectively.

## 2. General Results on Secure $w$ -Domination

Given a  $w$ -dominating function  $f(V_0, \dots, V_l)$ , we introduce the following notation.

- Given  $v \in V_0$ , we define  $M_f(v) = \{u \in V(G) \setminus V_0 : f_{u \rightarrow v} \text{ as a } w\text{-dominating function}\}$ .
- $\mathcal{M}_f(G) = \bigcup_{v \in V_0} M_f(v)$ .
- Given  $u \in \mathcal{M}_f(G)$ , we define  $D_f(u) = \{v \in V_0 : u \in M_f(v)\}$ .
- Given  $u \in \mathcal{M}_f(G)$ , we define  $T_f(u) = \{v \in V_0 : u \in M_f(v) \text{ and } f(N(v)) = w_0\}$ .

Obviously, if  $f$  is a secure  $w$ -dominating function, then  $M_f(v) \neq \emptyset$  for every  $v \in V_0$ .

**Lemma 1.** Let  $f$  be a secure  $w$ -dominating function on a graph  $G$ , and let  $u \in \mathcal{M}_f(G)$ . If  $T_f(u) \neq \emptyset$ , then each vertex belonging to  $T_f(u)$  is adjacent to every vertex in  $D_f(u)$  and, in particular,  $G[T_f(u)]$  is a clique.

**Proof.** Since  $T_f(u) \subseteq D_f(u)$ , we only need to suppose the existence of two non-adjacent vertices  $v \in T_f(u)$  and  $v' \in D_f(u)$  with  $v \neq v'$ . In such a case,  $f_{u \rightarrow v'}(N(v)) < w_0$ , which is a contradiction. Therefore, the result follows.  $\square$

**Remark 1** ([1]). Let  $G$  be a graph of minimum degree  $\delta$  and let  $w = (w_0, w_1, \dots, w_l) \in \mathbb{Z}^+ \times \mathbb{N}^l$ . If  $w_0 \geq w_1 \geq \dots \geq w_l$ , then there exists a  $w$ -dominating function on  $G$  if and only if  $w_l \leq l\delta$ .

Throughout this section, we repeatedly apply, without explicit mention, the following necessary and sufficient condition for the existence of a secure  $w$ -dominating function on  $G$ .

**Remark 2.** Let  $G$  be a graph of minimum degree  $\delta$  and let  $w = (w_0, w_1, \dots, w_l) \in \mathbb{Z}^+ \times \mathbb{N}^l$ . If  $w_0 \geq w_1 \geq \dots \geq w_l$ , then there exists a secure  $w$ -dominating function on  $G$  if and only if  $w_l \leq l\delta$ .

**Proof.** If  $f$  is a secure  $w$ -dominating function on  $G$ , then  $f$  is a  $w$ -dominating function, and by Remark 1 we conclude that  $w_l \leq l\delta$ .

Conversely, if  $w_l \leq l\delta$ , then the function  $f$ , defined by  $f(v) = l$  for every  $v \in V(G)$ , is a secure  $w$ -dominating function. Therefore, the result follows.  $\square$

It was shown by Cabrera et al. [1] that the  $w$ -domination numbers satisfy a certain monotonicity. Given two integer vectors  $w = (w_0, \dots, w_l)$  and  $w' = (w'_0, \dots, w'_l)$ , we say that  $w' \prec w$  if  $w'_i \leq w_i$  for every  $i \in \{0, \dots, l\}$ . With this notation in mind, we can state the next remark which is a direct consequence of the definition of  $w$ -dominating function.

**Remark 3.** [1] Let  $G$  be a graph of minimum degree  $\delta$  and let  $w = (w_0, \dots, w_l), w' = (w'_0, \dots, w'_l) \in \mathbb{Z}^+ \times \mathbb{N}^l$  such that  $w_i \geq w_{i+1}$  and  $w'_i \geq w'_{i+1}$  for every  $i \in \{0, \dots, l-1\}$ . If  $w' \prec w$  and  $w_l \leq l\delta$ , then every  $w$ -dominating function is a  $w'$ -dominating function and, as a consequence,

$$\gamma_{w'}(G) \leq \gamma_w(G).$$

The monotonicity also holds for the case of secure  $w$ -domination.

**Remark 4.** Let  $G$  be a graph of minimum degree  $\delta$  and let  $w = (w_0, \dots, w_l), w' = (w'_0, \dots, w'_l) \in \mathbb{Z}^+ \times \mathbb{N}^l$  such that  $w_i \geq w_{i+1}$  and  $w'_i \geq w'_{i+1}$  for every  $i \in \{0, \dots, l-1\}$ . If  $w' \prec w$  and  $w_l \leq l\delta$ , then every secure  $w$ -dominating function is a secure  $w'$ -dominating function and, as a consequence,

$$\gamma_{w'}^s(G) \leq \gamma_w^s(G).$$

**Proof.** For any  $\gamma_w^s(G)$ -function  $f$  and any  $v \in V(G)$  with  $f(v) = 0$ , there exists  $u \in M_f(v)$ . Since  $f$  and  $f_{u \rightarrow v}$  are  $w$ -dominating functions, by Remark 3, we conclude that, if  $w' \prec w$  and  $w_l \leq l\delta$ , then both  $f$  and  $f_{u \rightarrow v}$  are  $w'$ -dominating functions. Therefore,  $f$  is a secure  $w'$ -dominating function and, as a consequence,  $\gamma_{w'}^s(G) \leq \omega(f) = \gamma_w^s(G)$ .  $\square$

From the following equality chain, we obtain examples of equalities in Remark 4. Graph  $G_1$  is illustrated in Figure 1.

$$\gamma_{(3,0,0)}^s(G_1) = \gamma_{(3,1,0)}^s(G_1) = \gamma_{(3,2,0)}^s(G_1) = \gamma_{(3,2,1)}^s(G_1) = \gamma_{(3,2,2)}^s(G_1).$$

**Theorem 1.** Let  $G$  be a graph of minimum degree  $\delta$ , and let  $w = (w_0, \dots, w_l) \in \mathbb{Z}^+ \times \mathbb{N}^l$  such that  $w_i \geq w_{i+1}$  for every  $i \in \{0, \dots, l-1\}$ . If  $l\delta \geq w_l$ , then the following statements hold.

- (i)  $\gamma_w(G) \leq \gamma_w^s(G)$ .
- (ii) If  $k \in \mathbb{Z}^+$ , then  $\gamma_{(k+1, k=w_1, \dots, w_l)}(G) \leq \gamma_{(k, k=w_1, \dots, w_l)}^s(G)$ .

**Proof.** Since every secure  $w$ -dominating function on  $G$  is a  $w$ -dominating function on  $G$ , (i) follows. Let  $f(V_0, \dots, V_l)$  be a  $\gamma_{(k, k=w_1, \dots, w_l)}^s(G)$ -function. Since  $f$  is a  $(k, k = w_1, \dots, w_l)$ -dominating function,  $f(N(v)) \geq w_i$  for every  $v \in V_i$  with  $i \in \{1, \dots, l\}$  and  $w_1 = k$ . If  $V_0 = \emptyset$ , then  $f$  is a  $(k+1, k = w_1, \dots, w_l)$ -dominating function, which implies that  $\gamma_{(k+1, k=w_1, \dots, w_l)}(G) \leq \omega(f) = \gamma_{(k, k=w_1, \dots, w_l)}^s(G)$ . Assume  $V_0 \neq \emptyset$ . Let  $v \in V_0$  and  $u \in M_f(v)$ . If  $f(N(v)) = k$ , then  $f_{u \rightarrow v}(N(v)) = f(N(v)) - 1 = k - 1$ , which is a contradiction. Thus,  $f(N(v)) \geq k + 1$ , which implies that  $f$  is a  $(k+1, k = w_1, \dots, w_l)$ -dominating function. Therefore,  $\gamma_{(k+1, k=w_1, \dots, w_l)}(G) \leq \omega(f) = \gamma_{(k, k=w_1, \dots, w_l)}^s(G)$ , and (ii) follows.  $\square$

The inequalities above are tight. For instance, for any integers  $n, n' \geq 4$ , we have that  $\gamma_{(2,2,2)}(K_n + N_{n'}) = \gamma_{(2,2,2)}^s(K_n + N_{n'}) = 3$  and  $\gamma_{(3,2,2)}(K_{2n}) = \gamma_{(2,2,2)}^s(K_{2n}) = 5$ .

**Corollary 1.** Let  $G$  be a graph of minimum degree  $\delta$  and order  $n$ . Let  $w = (w_0, \dots, w_l) \in \mathbb{Z}^+ \times \mathbb{N}^l$  such that  $w_i \geq w_{i+1}$  for every  $i \in \{0, \dots, l-1\}$  and  $l\delta \geq w_l$ . The following statements hold.

- (i) If  $n > w_0$ , then  $\gamma_w^s(G) \geq w_0$ .
- (ii) If  $n > w_0 = w_1$ , then  $\gamma_w^s(G) \geq w_0 + 1$ .

**Proof.** Assume  $n > w_0$ . By Theorem 1, we have that  $\gamma_w^s(G) \geq \gamma_w(G)$ . Now, if  $\gamma_w(G) \leq w_0 - 1 < n - 1$ , then for any  $\gamma_w(G)$ -function  $f$  there exists at least one vertex  $x \in V(G)$  such that  $f(x) = 0$  and  $f(N(x)) \leq \omega(f) < w_0$ , which is a contradiction. Thus,  $\gamma_w^s(G) \geq \gamma_w(G) \geq w_0$ .



Analogously, if  $w_0 = w_1$ , then Theorem 1 leads to  $\gamma_w^s(G) \geq \gamma_{(w_0+1, w_1, \dots, w_1)}(G)$ . In this case, if  $\gamma_{(w_0+1, w_1, \dots, w_1)}(G) \leq w_0 < n$ , then for any  $\gamma_{(w_0+1, w_1, \dots, w_1)}(G)$ -function  $f$  there exists at least one vertex  $x \in V(G)$  such that  $f(x) = 0$  and  $f(N(x)) \leq \omega(f) < w_0 + 1$ , which is a contradiction. Therefore,  $\gamma_w^s(G) \geq \gamma_{(w_0+1, w_1, \dots, w_1)}(G) \geq w_0 + 1$ .  $\square$

As the following result shows, the bounds above are tight.

**Proposition 1.** For any integer  $n$  and any  $w = (w_0, \dots, w_l) \in \mathbb{Z}^+ \times \mathbb{N}^l$  such that  $w_l \leq \dots \leq w_0 < n$ ,

$$\gamma_w^s(K_n) = \begin{cases} w_0 + 1 & \text{if } w_0 = w_l, \\ w_0 & \text{otherwise.} \end{cases}$$

**Proof.** Assume  $n > w_0$ . Let  $S \subseteq V(K_n)$  such that  $|S| = w_0 + 1$  if  $w_0 = w_l$  and  $|S| = w_0$  otherwise. In both cases, the function  $f(V_0, \dots, V_l)$ , defined by  $V_l = S$ ,  $V_0 = V(G) \setminus V_l$  and  $V_j = \emptyset$  whenever  $j \notin \{0, l\}$ , is a secure  $w$ -dominating function. Hence,  $\gamma_w^s(K_n) \leq \omega(f) = |S|$ . Therefore, by Corollary 1 the result follows.  $\square$

**Theorem 2.** Let  $G$  be a graph of minimum degree  $\delta$ , and let  $w = (w_0, \dots, w_l), w' = (w'_0, \dots, w'_l) \in \mathbb{Z}^+ \times \mathbb{N}^l$  such that  $l\delta \geq w_l, w_i \geq w_{i+1}$  and  $w'_i \geq w'_{i+1}$  for every  $i \in \{0, \dots, l-1\}$ . If  $w_i \geq w'_{i-1} - 1$  for every  $i \in \{1, \dots, l\}$ , and  $\max\{w_j - 1, 0\} \geq w'_j$  for every  $j \in \{0, \dots, l\}$ , then

$$\gamma_{w'}^s(G) \leq \gamma_w(G).$$

**Proof.** Assume that  $w_i \geq w'_{i-1} - 1$  for every  $i \in \{1, \dots, l\}$  and  $\max\{w_j - 1, 0\} \geq w'_j$  for every  $j \in \{0, \dots, l\}$ . Let  $f(V_0, \dots, V_l)$  be a  $\gamma_w(G)$ -function. We claim that  $f$  is a secure  $w'$ -dominating function. Since  $f(N(x)) \geq w_i \geq w'_i$  for every  $x \in V_i$  with  $i \in \{0, \dots, l\}$ , we deduce that  $f$  is a  $w'$ -dominating function. Now, let  $v \in V_0$  and  $u \in N(v) \cap V_i$  with  $i \in \{1, \dots, l\}$ . We differentiate the following cases for  $x \in V(G)$ .

Case 1.  $x = v$ . In this case,  $f_{u \rightarrow v}(v) = 1$  and  $f_{u \rightarrow v}(N(v)) = f(N(v)) - 1 \geq w_0 - 1 \geq \max\{w_1 - 1, 0\} \geq w'_1$ .

Case 2.  $x = u$ . In this case,  $f_{u \rightarrow v}(u) = f(u) - 1 = i - 1$  and  $f_{u \rightarrow v}(N(u)) = f(N(u)) + 1 \geq w_i + 1 \geq w'_{i-1}$ .

Case 3.  $x \in V(G) \setminus \{u, v\}$ . Assume  $x \in V_j$ . Notice that  $f_{u \rightarrow v}(x) = f(x) = j$ . Now, if  $x \notin N(u)$  or  $x \in N(u) \cap N(v)$ , then  $f_{u \rightarrow v}(N(x)) = f(N(x)) \geq w_j \geq w'_j$ , while if  $x \in N(u) \setminus N[v]$ , then  $f_{u \rightarrow v}(N(x)) = f(N(x)) - 1 \geq \max\{w_j - 1, 0\} \geq w'_j$ .

According to the three cases above,  $f_{u \rightarrow v}$  is a  $w'$ -dominating function. Therefore,  $f$  is a secure  $w'$ -dominating function, and so  $\gamma_{w'}^s(G) \leq \omega(f) = \gamma_w(G)$ .  $\square$

The inequality above is tight. For instance,  $\gamma_{(1,1,1)}^s(K_{n,n'}) = \gamma_{(2,2,2)}(K_{n,n'}) = 4$  for  $n, n' \geq 4$ .

From Theorems 1 and 2, we derive the next known inequality chain, where  $G$  has minimum degree  $\delta \geq 1$ , except in the last inequality in which  $\delta \geq 2$ .

$$\gamma_s(G) \leq \gamma_2(G) \leq \gamma_{\times 2}(G) \leq \gamma_{st}(G) \leq \gamma_{\times 2,t}(G).$$

The following result is a particular case of Theorem 2.

**Corollary 2.** Let  $G$  be a graph of minimum degree  $\delta$ , and let  $w = (w_0, \dots, w_l) \in \mathbb{Z}^+ \times \mathbb{N}^l$  and  $\mathbf{1} = (1, \dots, 1)$ . If  $0 \leq w_{j-1} - w_j \leq 2$  for every  $j \in \{1, \dots, l\}$ , where  $1 \leq i \leq l$  and  $l\delta \geq w_l + 1$ , then

$$\gamma_{(w_0, \dots, w_l, 0, \dots, 0)}^s(G) \leq \gamma_{(w_0+1, \dots, w_l+1, 0, \dots, 0)}(G) \leq \gamma_{w+\mathbf{1}}(G).$$

For Graph  $G_2$  illustrated in Figure 1, we have that  $\gamma_{(1,1)}^s(G_2) = \gamma_{(1,1,0)}^s(G_2) = \gamma_{(2,2,0)}(G_2) = \gamma_{(1,1,1)}^s(G_2) = \gamma_{(2,2,2)}(G_2) = 3$ . Notice that  $\gamma_w^s(G_2) = \gamma_{w+1}(G_2)$  for  $w = \mathbf{1} = (1, 1, 1)$ .

Next, we show a class of graphs where  $\gamma_w(G) = \gamma_{w+1}(G)$ . To this end, we need to introduce some additional notation and terminology. Given the two Graphs  $G_1$  and  $G_2$ , the *corona product graph*  $G_1 \odot G_2$  is the graph obtained from  $G_1$  and  $G_2$ , by taking one copy of  $G_1$  and  $|V(G_1)|$  copies of  $G_2$  and joining by an edge every vertex from the  $i$ th copy of  $G_2$  with the  $i$ th vertex of  $G_1$ . For every  $x \in V(G_1)$ , the copy of  $G_2$  in  $G_1 \odot G_2$  associated to  $x$  is denoted by  $G_{2,x}$ .

**Theorem 3 ([1]).** Let  $G_1 \odot G_2$  be a corona graph where  $G_1$  does not have isolated vertices, and let  $w = (w_0, \dots, w_l) \in \mathbb{Z}^+ \times \mathbb{N}^l$ . If  $l \geq w_0 \geq \dots \geq w_l$  and  $|V(G_2)| \geq w_0$ , then

$$\gamma_w(G_1 \odot G_2) = w_0|V(G_1)|.$$

From the result above, we deduce that under certain additional restrictions on  $G_2$  and  $w$  we can obtain  $\gamma_w^s(G_1 \odot G_2) = \gamma_{w+1}(G_1 \odot G_2)$ .

**Theorem 4.** Let  $G_1 \odot G_2$  be a corona graph, where  $G_1$  does not have isolated vertices and  $G_2$  is a triangle-free graph. Let  $w = (w_0, \dots, w_l) \in \mathbb{Z}^+ \times \mathbb{N}^l$  such that  $l - 1 \geq w_0 \geq \dots \geq w_l$ . If  $|V(G_2)| \geq w_0 + 2$ , then

$$\gamma_w^s(G_1 \odot G_2) = (w_0 + 1)|V(G_1)| = \gamma_{w+1}(G_1 \odot G_2).$$

**Proof.** Since  $G_1$  does not have isolated vertices, the upper bound  $\gamma_w^s(G_1 \odot G_2) \leq (w_0 + 1)|V(G_1)|$  is straightforward, as the function  $f$ , defined by  $f(x) = w_0 + 1$  for every  $x \in V(G_1)$  and  $f(x) = 0$  for the remaining vertices of  $G_1 \odot G_2$ , is a secure  $w$ -dominating function.

On the other hand, let  $f(V_0, \dots, V_l)$  be a  $\gamma_w^s(G_1 \odot G_2)$ -function and suppose that there exists  $x \in V(G_1)$  such that  $f(V(G_{2,x})) + f(x) \leq w_0$ . Since  $|V(G_{2,x})| \geq w_0 + 2$ , there exist at least two different vertices  $u, v \in V(G_{2,x}) \cap V_0$ . Hence,  $f(N(u)) = f(N(v)) = w_0$ , which implies that  $u$  and  $v$  are adjacent and, since  $G_2$  is a triangle-free graph,  $f(x) = w_0$  and  $f(y) = 0$  for every  $y \in V(G_{2,x})$ . Thus, by Lemma 1, we conclude that  $G_{2,x}$  is a clique, which is a contradiction as  $|V(G_2)| \geq 3$  and  $G_2$  is a triangle-free graph. This implies that  $f(V(G_{2,x})) + f(x) \geq w_0 + 1$  for every  $x \in V(G_1)$ , and so  $\gamma_w^s(G_1 \odot G_2) = \omega(f) \geq (w_0 + 1)|V(G_1)|$ .

Therefore,  $\gamma_w^s(G_1 \odot G_2) = (w_0 + 1)|V(G_1)|$ , and by Theorem 3 we conclude that  $\gamma_{w+1}(G_1 \odot G_2) = (w_0 + 1)|V(G_1)|$ , which completes the proof.  $\square$

**Theorem 5.** Let  $G$  be a graph of minimum degree  $\delta$  and  $l \geq 2$  an integer. For any  $(w_0, \dots, w_{l-1}) \in \mathbb{Z}^+ \times \mathbb{N}^{l-1}$  with  $w_0 \geq \dots \geq w_{l-1}$  and  $l\delta \geq w_{l-1}$ ,

$$\gamma_{(w_0, \dots, w_{l-1}, w_l = w_{l-1})}^s(G) \leq \gamma_{(w_0, \dots, w_{l-1})}(G) + \gamma(G).$$

**Proof.** Let  $f(V_0, \dots, V_{l-1})$  be a  $\gamma_{(w_0, \dots, w_{l-1})}(G)$ -function and  $S$  a  $\gamma(G)$ -set. We define a function  $g(W_0, \dots, W_l)$  as follows. Let  $W_l = V_{l-1} \cap S$ ,  $W_0 = V_0 \setminus S$ , and  $W_i = (V_{i-1} \cap S) \cup (V_i \setminus S)$  for every  $i \in \{1, \dots, l-1\}$ .

We claim that  $g$  is a secure  $(w_0, \dots, w_{l-1}, w_l = w_{l-1})$ -dominating function. First, we observe that, if  $x \in W_i \cap S$  with  $i \in \{1, \dots, l\}$ , then  $x \in V_{i-1}$  and  $g(N(x)) \geq f(N(x)) \geq w_{i-1} \geq w_i$ . Moreover, if  $x \in W_i \setminus S$  with  $i \in \{0, \dots, l-1\}$ , then  $x \in V_i$  and  $g(N(x)) \geq f(N(x)) \geq w_i$ . Hence,  $g$  is a  $(w_0, \dots, w_{l-1}, w_l = w_{l-1})$ -dominating function.

Now, let  $v \in W_0 = V_0 \setminus S$ . Notice that there exists a vertex  $u \in N(v) \cap V_{i-1} \cap S$  with  $i \in \{1, \dots, l\}$ . Hence,  $u \in N(v) \cap W_i$ . We differentiate the following cases for  $x \in V(G)$ .

Case 1.  $x = v$ . In this case,  $g_{u \rightarrow v}(v) = 1$  and, as  $N(v) \cap S \neq \emptyset$ , we obtain that  $g_{u \rightarrow v}(N(v)) = g(N(v)) - 1 \geq f(N(v)) \geq w_0 \geq w_1$ .

Case 2.  $x = u$ . In this case,  $g_{u \rightarrow v}(u) = g(u) - 1 = i - 1$  and  $g_{u \rightarrow v}(N(u)) = g(N(u)) + 1 \geq f(N(u)) + 1 \geq w_{i-1} + 1 > w_{i-1}$ .

Case 3.  $x \in V(G) \setminus \{u, v\}$ . Assume  $x \in W_j$ . Notice that  $g_{u \rightarrow v}(x) = g(x) = j$ . If  $x \notin N(u)$  or  $x \in N(u) \cap N(v)$ , then  $g_{u \rightarrow v}(N(x)) = g(N(x)) \geq f(N(x)) \geq w_j$ .

Moreover, if  $x \in (N(u) \setminus N[v]) \cap S$ , then  $x \in V_{j-1}$  and so  $g_{u \rightarrow v}(N(x)) = g(N(x)) - 1 \geq f(N(x)) \geq w_{j-1} \geq w_j$ . Finally, if  $x \in (N(u) \setminus N[v]) \setminus S$ , then  $x \in V_j$  and therefore  $g_{u \rightarrow v}(N(x)) = g(N(x)) - 1 \geq f(N(x)) \geq w_j$ .

According to the three cases above,  $g_{u \rightarrow v}$  is a  $(w_0, \dots, w_{l-1}, w_l = w_{l-1})$ -dominating function. Therefore,  $f$  is a secure  $(w_0, \dots, w_{l-1}, w_l = w_{l-1})$ -dominating function, and so  $\gamma_{(w_0, \dots, w_{l-1}, w_l = w_{l-1})}^s(G) \leq \omega(g) \leq \omega(f) + |S| = \gamma_{(w_0, \dots, w_{l-1})}(G) + \gamma(G)$ .  $\square$

From Theorem 5, we derive the next known inequalities, which are tight.

**Corollary 3.** For a graph  $G$ , the following statements hold.

- Ref. [15]  $\gamma_r(G) \leq 2\gamma(G)$ .
- Ref. [12]  $\gamma_{tr}(G) \leq \gamma_t(G) + \gamma(G)$ , where  $G$  has minimum degree at least one.
- Ref. [19]  $\gamma_1^s(G) \leq \gamma_2(G) + \gamma(G)$ .

To establish the following result, we need to define the following parameter.

$$v_{(w_0, \dots, w_l)}^s(G) = \max\{|V_0| : f(V_0, \dots, V_l) \text{ is a } \gamma_{(w_0, \dots, w_l)}^s(G)\text{-function.}\}$$

In particular, for  $l = 1$  and a graph  $G$  of order  $n$ , we have that  $v_{(w_0, w_1)}^s(G) = n - \gamma_{(w_0, w_1)}^s(G)$ .

**Theorem 6.** Let  $G$  be a graph of minimum degree  $\delta$  and order  $n$ . The following statements hold for any  $(w_0, \dots, w_l) \in \mathbb{Z}^+ \times \mathbb{N}^l$  with  $w_0 \geq \dots \geq w_l$ .

- (i) If there exists  $i \in \{1, \dots, l-1\}$  such that  $i\delta \geq w_i$ , then  $\gamma_{(w_0, \dots, w_l)}^s(G) \leq \gamma_{(w_0, \dots, w_i)}^s(G)$ .
- (ii) If  $l \geq i + 1 > w_0$ , then  $\gamma_{(w_0, \dots, w_i, 0, \dots, 0)}^s(G) \leq (i + 1)\gamma(G)$ .
- (iii) Let  $k, i \in \mathbb{Z}^+$  such that  $l \geq ki$ , and let  $(w'_0, w'_1, \dots, w'_i) \in \mathbb{Z}^+ \times \mathbb{N}^l$ . If  $i\delta \geq w'_i$  and  $w_{kj} = kw'_j$  for every  $j \in \{0, 1, \dots, i\}$ , then  $\gamma_{(w_0, \dots, w_l)}^s(G) \leq k\gamma_{(w'_0, \dots, w'_i)}^s(G)$ .
- (iv) Let  $k \in \mathbb{Z}^+$  and  $\beta_1, \dots, \beta_k \in \mathbb{Z}^+$ . If  $l\delta \geq k + w_l > k$  and  $w_0 + k \geq \beta_1 \geq \dots \geq \beta_k \geq w_1 + k$ , then  $\gamma_{(w_0+k, \beta_1, \dots, \beta_k, w_1+k, \dots, w_l+k)}^s(G) \leq \gamma_{(w_0, \dots, w_l)}^s(G) + k(n - v_{(w_0, \dots, w_l)}^s(G))$ .
- (v) If  $l\delta \geq w_l \geq l \geq 2$ , then  $\gamma_{(w_0, \dots, w_l)}^s(G) \leq l\gamma_{(w_0-l+1, w_l-l+1)}^s(G)$ .

**Proof.** If there exists  $i \in \{1, \dots, l-1\}$  such that  $i\delta \geq w_i$ , then for any  $\gamma_{(w_0, \dots, w_l)}^s(G)$ -function  $f(V_0, \dots, V_l)$  we define a secure  $(w_0, \dots, w_l)$ -dominating function  $g(W_0, \dots, W_l)$  by  $W_j = V_j$  for every  $j \in \{0, \dots, i\}$  and  $W_j = \emptyset$  for every  $j \in \{i+1, \dots, l\}$ . Hence,  $\gamma_{(w_0, \dots, w_l)}^s(G) \leq \omega(g) = \omega(f) = \gamma_{(w_0, \dots, w_i)}^s(G)$ . Therefore, (i) follows.

Now, assume  $l \geq i + 1 > w_0$ . Let  $S$  be a  $\gamma(G)$ -set. Let  $f$  be the function defined by  $f(v) = i + 1$  for every  $v \in S$  and  $f(v) = 0$  for the remaining vertices. Since  $i + 1 > w_0$ , we can conclude that  $f$  is a secure  $(w_0, \dots, w_i, 0, \dots, 0)$ -dominating function. Therefore,  $\gamma_{(w_0, \dots, w_i, 0, \dots, 0)}^s(G) \leq \omega(f) = (i + 1)|S| = (i + 1)\gamma(G)$ , which implies that (ii) follows.

To prove (iii), assume that  $l \geq ki$ ,  $i\delta \geq w'_i$  and  $w_{kj} = kw'_j$  for every  $j \in \{0, \dots, i\}$ . Let  $f'(V'_0, \dots, V'_i)$  be a  $\gamma^s_{(w'_0, \dots, w'_i)}(G)$ -function. We construct a function  $f(V_0, \dots, V_l)$  as  $f(v) = kf'(v)$  for every  $v \in V(G)$ . Hence,  $V_{kj} = V'_j$  for every  $j \in \{0, \dots, i\}$ , while  $V_j = \emptyset$  for the remaining cases. Thus, for every  $v \in V_{kj}$  with  $j \in \{0, \dots, i\}$  we have that  $f(N(v)) = kf'(N(v)) \geq kw'_j = w_{kj}$ , which implies that  $f$  is a  $(w_0, \dots, w_l)$ -dominating function. Now, for every  $x \in V_0$ , there exists  $y \in M_{f'}(x)$ . Hence, for every  $v \in V_{kj}$  with  $j \in \{0, \dots, i\}$ , we have that  $f_{y \rightarrow x}(N(v)) = kf'_{y \rightarrow x}(N(v)) \geq kw'_j = w_{kj}$ , which implies that  $f_{y \rightarrow x}$  is a  $(w_0, \dots, w_l)$ -dominating function. Therefore,  $f$  is a secure  $(w_0, \dots, w_l)$ -dominating function, and so  $\gamma^s_{(w_0, \dots, w_l)}(G) \leq \omega(f) = k\omega(f') = k\gamma^s_{(w'_0, \dots, w'_i)}(G)$ . Therefore, (iii) follows.

Now, assume that  $l\delta \geq k + w_l > k$  and  $w_0 + k \geq \beta_1 \geq \dots \geq \beta_k \geq w_1 + k$ . Let  $g(W_0, \dots, W_l)$  be a  $\gamma^s_{(w_0, \dots, w_l)}(G)$ -function. We construct a function  $f(V_0, \dots, V_{l+k})$  as  $f(v) = g(v) + k$  for every  $v \in V(G) \setminus W_0$  and  $f(v) = 0$  for every  $v \in W_0$ . Hence,  $V_{j+k} = W_j$  for every  $j \in \{1, \dots, l\}$ ,  $V_0 = W_0$  and  $V_j = \emptyset$  for the remaining cases. Thus, if  $v \in V_{j+k}$  and  $j \in \{1, \dots, l\}$ , then  $f(N(v)) \geq g(N(v)) + k \geq w_j + k$ , and if  $v \in V_0$ , then  $f(N(v)) \geq g(N(v)) + k \geq w_0 + k$ . This implies that  $f$  is a  $(w_0 + k, \beta_1, \dots, \beta_k, w_1 + k, \dots, w_l + k)$ -dominating function. Now, for every  $x \in V_0 = W_0$ , there exists  $y \in M_g(x)$ . Hence, if  $v \in V_{j+k}$  and  $j \in \{1, \dots, l\}$ , then  $f_{y \rightarrow x}(N(v)) \geq g_{y \rightarrow x}(N(v)) + k \geq w_j + k$ , and if  $v \in V_0$ , then  $f_{y \rightarrow x}(N(v)) \geq g_{y \rightarrow x}(N(v)) + k \geq w_0 + k$ . This implies that  $f_{y \rightarrow x}$  is a  $(w_0 + k, \beta_1, \dots, \beta_k, w_1 + k, \dots, w_l + k)$ -dominating function, and so  $f$  is a secure  $(w_0 + k, \beta_1, \dots, \beta_k, w_1 + k, \dots, w_l + k)$ -dominating function. Therefore,  $\gamma^s_{(w_0+k, \beta_1, \dots, \beta_k, w_1+k, \dots, w_l+k)}(G) \leq \omega(f) = \omega(g) + k \sum_{j=1}^l |W_j| = \gamma^s_{(w_0, \dots, w_l)}(G) + k(n - |W_0|) \leq \gamma^s_{(w_0, \dots, w_l)}(G) + k(n - v^s_{(w_0, \dots, w_l)}(G))$ , concluding that (iv) follows.

Furthermore, if  $l\delta \geq w_l \geq l \geq 2$ , then, by applying (iv) for  $k = l - 1$ , we deduce that

$$\gamma^s_{(w_0, \dots, w_l)}(G) \leq \gamma^s_{(w_0-l+1, w_l-l+1)}(G) + (l-1)(n - v^s_{(w_0-l+1, w_l-l+1)}(G)) = l\gamma^s_{(w_0-l+1, w_l-l+1)}(G).$$

Therefore, (v) follows.  $\square$

In the next subsections, we consider several applications of Theorem 6 where we show that the bounds are tight. For instance, the following particular cases is of interest.

**Corollary 4.** Let  $G$  be a graph of minimum degree  $\delta$ , and let  $k, l, w_2, \dots, w_l \in \mathbb{Z}^+$  with  $k \geq w_2 \geq \dots \geq w_l$ .

(i') If  $\delta \geq k$ , then  $\gamma^s_{(k+1, k, w_2, \dots, w_l)}(G) \leq \gamma^s_{(k+1, k)}(G)$ .

(ii') If  $\delta \geq k$ , then  $\gamma^s_{(k, k, w_2, \dots, w_l)}(G) \leq \gamma^s_{(k, k)}(G)$ .

(iii') If  $l\delta \geq k \geq l \geq 2$ , then  $\gamma^s_{(k, k, \dots, k)}(G) \leq l\gamma^s_{(k-l+1, k-l+1)}(G)$ .

(iv') Let  $i \in \mathbb{Z}^+$ . If  $l \geq ki$  and  $\delta \geq 1$ , then  $\gamma^s_{(k, \dots, k)}(G) \leq k\gamma^s_{(1, \dots, 1)}(G)$ .

**Proof.** If  $\delta \geq k$ , then by Theorem 6 (i) we conclude that (i') and (ii') follow. If  $l\delta \geq k \geq l \geq 2$ , then by Theorem 6 (v) we deduce (iii'). Finally, if  $l \geq k$  and  $\delta \geq 1$ , then by Theorem 6 (iii) we deduce that (iv') follows.  $\square$

To show that the inequalities above are tight, we consider the following examples. For (i'), we have  $\gamma^s_{(2,1,1)}(K_1 + (K_2 \cup K_2)) = \gamma^s_{(2,1)}(K_1 + (K_2 \cup K_2)) = 3$ . For (ii') we have  $\gamma^s_{(k,k,w_2,\dots,w_l)}(G) = \gamma^s_{(k,k)}(G) = k + 1$  for every graph  $G$  with  $k + 1$  universal vertices. Finally, for (iii') and (iv'), we take  $l = k = 2$  and  $\gamma^s_{(2,2,2)}(K_2 + N_n) = 2\gamma^s_{(1,1)}(K_2 + N_n) = 4$  for every  $n \geq 2$ .

We already know that  $\gamma_t(G) = \gamma_{(1,1)}(G) = \gamma_{(1,1,w_2,\dots,w_l)}(G)$ , for every  $w_2, \dots, w_l \in \{0,1\}$ . In contrast, the picture is quite different for the case of secure  $(1,1)$ -domination, as there are graphs

where the gap  $\gamma_{(1,1)}^s(G) - \gamma_{(1,\dots,1)}^s(G)$  is arbitrarily large. For instance,  $\lim_{n \rightarrow \infty} \gamma_{(1,1)}^s(K_{1,n-1}) = +\infty$ , while, if  $l \geq 2$ , then  $\lim_{n \rightarrow +\infty} \gamma_{(\underbrace{1,\dots,1}_{l+1})}^s(K_{1,n-1}) = 3$ .

**Proposition 2.** Let  $G$  be a graph of order  $n$ . Let  $w = (w_0, \dots, w_l) \in \mathbb{Z}^+ \times \mathbb{N}^l$  such that  $w_0 \geq \dots \geq w_l$ . If  $G'$  is a spanning subgraph of  $G$  with minimum degree  $\delta' \geq \frac{w_l}{l}$ , then

$$\gamma_w^s(G) \leq \gamma_w^s(G').$$

**Proof.** Let  $E^- = \{e_1, \dots, e_k\}$  be the set of all edges of  $G$  not belonging to the edge set of  $G'$ . Let  $G'_0 = G$  and, for every  $i \in \{1, \dots, k\}$ , let  $X_i = \{e_1, \dots, e_i\}$  and  $G'_i = G - X_i$ , the edge-deletion subgraph of  $G$  induced by  $E(G) \setminus X_i$ .

For any  $\gamma_w^s(G'_i)$ -function  $f$  and any  $v \in V(G'_i) = V(G)$  with  $f(v) = 0$ , there exists  $u \in M_f(v)$ . Since  $f$  and  $f_{u \rightarrow v}$  are  $w$ -dominating functions on  $G'_i$ , both are  $w$ -dominating functions on  $G'_{i-1}$ , and so we can conclude that  $f$  is a secure  $w$ -dominating function on  $G'_{i-1}$ , which implies that  $\gamma_w^s(G'_{i-1}) \leq \gamma_w^s(G'_i)$ . Hence,  $\gamma_w^s(G) = \gamma_w^s(G'_0) \leq \gamma_w^s(G'_1) \leq \dots \leq \gamma_w^s(G'_k) = \gamma_w^s(G')$ .  $\square$

As a simple example of equality in Proposition 2 we can take any graph  $G$  of order  $n$ , having  $n' + 1 \geq 2$  universal vertices. In such a case, for  $n' = w_1 \geq \dots \geq w_l$  we have that

$$\gamma_{(n', n'=w_1, \dots, w_l)}^s(K_n) = \gamma_{(n', n'=w_1, \dots, w_l)}^s(G) = \gamma_{(n', n')}^s(K_n) = \gamma_{(n', n')}^s(G) = n' + 1.$$

From Proposition 2, we obtain the following result.

**Corollary 5.** Let  $G$  be a graph of order  $n$  and  $w = (w_0, \dots, w_l) \in \mathbb{Z}^+ \times \mathbb{N}^l$  such that  $w_0 \geq \dots \geq w_l$ .

- If  $G$  is a Hamiltonian graph and  $w_l \leq 2l$ , then  $\gamma_w^s(G) \leq \gamma_w^s(C_n)$ .
- If  $G$  has a Hamiltonian path and  $w_l \leq l$ , then  $\gamma_w^s(G) \leq \gamma_w^s(P_n)$ .

To derive some lower bounds on  $\gamma_w^s(G)$ , we need to establish the following lemma.

**Lemma 2 ([1]).** Let  $G$  be a graph with no isolated vertex, maximum degree  $\Delta$  and order  $n$ . For any  $w$ -dominating function  $f(V_0, \dots, V_l)$  on  $G$  such that  $w_0 \geq \dots \geq w_l$ ,

$$\Delta \omega(f) \geq w_0 n + \sum_{i=1}^l (w_i - w_0) |V_i|.$$

**Theorem 7.** Let  $G$  be a graph with no isolated vertex, maximum degree  $\Delta$  and order  $n$ . Let  $w = (w_0, \dots, w_l) \in \mathbb{Z}^+ \times \mathbb{N}^l$  such that  $w_0 \geq \dots \geq w_l$  and  $l\delta \geq w_l$ . The following statements hold.

- If  $w_0 = w_1$  and  $w_0 - w_i \leq i$  for every  $i \in \{2, \dots, l\}$ , then  $\gamma_w^s(G) \geq \left\lceil \frac{(w_0+1)n}{\Delta+1} \right\rceil$ .
- If  $w_0 = w_1$ , then  $\gamma_w^s(G) \geq \left\lceil \frac{(w_0+1)n}{\Delta+w_0} \right\rceil$ .
- If  $w_0 = w_1 + 1$  and  $w_0 - w_i \leq i$  for every  $i \in \{2, \dots, l\}$ , then  $\gamma_w^s(G) \geq \left\lceil \frac{w_0 n}{\Delta+1} \right\rceil$ .
- $\gamma_w^s(G) \geq \left\lceil \frac{w_0 n}{\Delta+w_0} \right\rceil$ .

**Proof.** Let  $w_0 = w_1$  and  $w_0 - w_i \leq i$  for every  $i \in \{2, \dots, l\}$ . Let  $f(V_0, \dots, V_l)$  be a  $\gamma_{(w_0+1, w_1, \dots, w_l)}^s(G)$ -function. By Lemma 2, we deduce the following.

$$\begin{aligned} \Delta\omega(f) &\geq (w_0 + 1)n + \sum_{i=1}^l (w_i - w_0)|V_i| \\ &\geq (w_0 + 1)n - \sum_{i=1}^l i|V_i| \\ &= (w_0 + 1)n - \omega(f). \end{aligned}$$

Therefore, Theorem 1 (ii) leads to  $\gamma_w^s(G) \geq \omega(f) \geq \left\lceil \frac{(w_0+1)n}{\Delta+1} \right\rceil$ .

The proof of the remaining items is completely analogous. In the last two cases, we consider that  $f(V_0, \dots, V_l)$  is a  $\gamma_w(G)$ -function, and we apply Theorem 1 (i) instead of (ii).  $\square$

The bounds above are sharp. For instance,  $\gamma_{(1,1,0)}^s(G) \geq \left\lceil \frac{2n}{\Delta+1} \right\rceil$  is achieved by Graph  $G_2$  shown in Figure 1, the bound  $\gamma_{(k,k,0)}^s(G) \geq \left\lceil \frac{(k+1)n}{\Delta+k} \right\rceil$  is achieved by  $G \cong K_n$  for every  $n > k(k-1) > 0$ , the bound  $\gamma_{(2,1,1)}^s(G) \geq \left\lceil \frac{2n}{\Delta+1} \right\rceil$  is achieved by the corona graph  $K_2 \odot K_{n'}$  with  $n' \geq 4$ , while  $\gamma_{(2,0,0)}^s(G) \geq \left\lceil \frac{2n}{\Delta+2} \right\rceil$  is achieved by  $G \cong C_5$ ,  $G \cong K_n$  and  $G \cong K_{n'} \cup K_{n'}$  with  $n \geq 2$  and  $n' \geq 4$ .

To conclude the paper, we consider the problem of characterizing the graphs  $G$  and the vectors  $w$  for which  $\gamma_w^s(G)$  takes small values. It is readily seen that  $\gamma_{(w_0, \dots, w_l)}^s(G) = 1$  if and only if  $w_0 = 1$ ,  $w_1 = 0$  and  $G \cong K_n$ . Next, we consider the case  $\gamma_w^s(G) = 2$ .

**Theorem 8.** Let  $w = (w_0, \dots, w_l) \in \mathbb{Z}^+ \times \mathbb{N}^l$  such that  $w_0 \geq \dots \geq w_l$ . For a graph  $G$  of order at least three,  $\gamma_{(w_0, \dots, w_l)}^s(G) = 2$  if and only if one of the following conditions holds.

(i)  $w_2 = 0$ ,  $\gamma(G) = 1$  and one of the following conditions holds.

- $w_0 = w_1 = 1$ .
- $w_0 = 1$ ,  $w_1 = 0$ , and  $G \not\cong K_n$ .
- $w_0 = 2$ ,  $w_1 \in \{0, 1\}$  and  $G \cong K_n$ .

(ii)  $w_0 = 1$ ,  $w_1 = 0$ , and  $\gamma_{(1,0)}^s(G) = 2$ .

(iii)  $w_0 = w_1 = 1$  and  $\gamma_{(1,1)}^s(G) = 2$ .

(iv)  $w_0 = 2$ ,  $w_1 \in \{0, 1\}$ , and  $G \cong K_n$ .

**Proof.** Assume first that  $\gamma_{(w_0, \dots, w_l)}^s(G) = 2$  and let  $f(V_0, \dots, V_l)$  be a  $\gamma_{(w_0, \dots, w_l)}^s(G)$ -function. Notice that  $(w_0, w_1) \in \{(1, 0), (1, 1), (2, 0), (2, 1)\}$  and  $|V_2| \in \{0, 1\}$ .

Firstly, we consider that  $|V_2| = 1$ , i.e.,  $V_2 = \{u\}$  for some universal vertex  $u \in V(G)$ . In this case,  $w_2 = 0$ ,  $\gamma(G) = 1$ , and  $V_i = \emptyset$  for every  $i \neq 0, 2$ . By Lemma 1, if  $w_0 = 2$ , then  $G[T_f(u)] = G[V(G) \setminus \{u\}]$  is a clique, which implies that  $G \cong K_n$ . Obviously, in such a case,  $w_1 < 2$ . Finally, the case,  $w_0 = 1$  and  $w_1 = 0$  leads to  $G \not\cong K_n$ , as  $\gamma_{(1,0, \dots, 0)}^s(K_n) = 1$ . Therefore, (i) follows.

From now on, assume that  $V_2 = \emptyset$ . Hence,  $V_i = \emptyset$  for every  $i \neq 0, 1$ . If  $w_0 = 1$  and  $w_1 = 0$ , then  $G \not\cong K_n$  and  $V_1$  is a secure dominating set. Therefore, (ii) follows. If  $w_0 = w_1 = 1$ , then  $V_1$  is a secure total dominating set of cardinality two, and so  $\gamma_{(1,1)}^s(G) = 2$ . Therefore, (iii) follows. Finally, assume  $w_0 = 2$ . In this case,  $V_1$  is a double dominating set of cardinality two, and by Lemma 1 we know that  $G[T_f(x)] = G[V(G) \setminus V_1]$  is a clique for any  $x \in V_1$ . Hence,  $G \cong K_n$  and, in such a case,  $w_1 < 2$ . Therefore, (iv) follows.

Conversely, if one of the four conditions holds, then it is easy to check that  $\gamma_{(w_0, \dots, w_l)}^s(G) = 2$ , which completes the proof.  $\square$

**Author Contributions:** All authors contributed equally to this work. Investigation, A.C.M., A.E.-M., and J.A.R.-V.; and Writing—review and editing, A.C.M., A.E.-M., and J.A.R.-V. All authors have read and agreed to the published version of the manuscript.

**Funding:** This research received no external funding.

**Conflicts of Interest:** The authors declare no conflict of interest.

## References

1. Cabrera Martínez, A.; Estrada-Moreno, A.; Rodríguez-Velázquez, J.A. From Italian domination in lexicographic product graphs to  $w$ -domination in graphs. *arXiv* **2020**, arXiv:2011.05371.
2. Cockayne, E.J.; Grobler, P.J.P.; Gründlingh, W.R.; Munganga, J.; van Vuuren, J.H. Protection of a graph. *Util. Math.* **2005**, *67*, 19–32.
3. Boumediene Merouane, H.; Chellali, M. On secure domination in graphs. *Inform. Process. Lett.* **2015**, *115*, 786–790. [[CrossRef](#)]
4. Burger, A.P.; Henning, M.A.; van Vuuren, J.H. Vertex covers and secure domination in graphs. *Quaest. Math.* **2008**, *31*, 163–171. [[CrossRef](#)]
5. Chellali, M.; Haynes, T.W.; Hedetniemi, S.T. Bounds on weak Roman and 2-rainbow domination numbers. *Discret. Appl. Math.* **2014**, *178*, 27–32. [[CrossRef](#)]
6. Cockayne, E.J.; Favaron, O.; Mynhardt, C.M. Secure domination, weak Roman domination and forbidden subgraphs. *Bull. Inst. Combin. Appl.* **2003**, *39*, 87–100.
7. Klostermeyer, W.F.; Mynhardt, C.M. Secure domination and secure total domination in graphs. *Discuss. Math. Graph Theory* **2008**, *28*, 267–284. [[CrossRef](#)]
8. Valveny, M.; Rodríguez-Velázquez, J.A. Protection of graphs with emphasis on Cartesian product graphs. *Filomat* **2019**, *33*, 319–333. [[CrossRef](#)]
9. Klein, D.J.; Rodríguez-Velázquez, J.A. Protection of lexicographic product graphs. *Discuss. Math. Graph Theory* **2019**, in press. [[CrossRef](#)]
10. Benecke, S.; Cockayne, E.J.; Mynhardt, C.M. Secure total domination in graphs. *Util. Math.* **2007**, *74*, 247–259.
11. Cabrera Martínez, A.; Montejano, L.P.; Rodríguez-Velázquez, J.A. On the secure total domination number of graphs. *Symmetry* **2019**, *11*, 1165. [[CrossRef](#)]
12. Cabrera Martínez, A.; Montejano, L.P.; Rodríguez-Velázquez, J.A. Total weak Roman domination in graphs. *Symmetry* **2019**, *11*, 831. [[CrossRef](#)]
13. Duginov, O. Secure total domination in graphs: Bounds and complexity. *Discret. Appl. Math.* **2017**, *222*, 97–108. [[CrossRef](#)]
14. Kulli, V.R.; Chaluvvaraju, B.; Kumara, M. Graphs with equal secure total domination and inverse secure total domination numbers. *J. Inf. Optim. Sci.* **2018**, *39*, 467–473. [[CrossRef](#)]
15. Henning, M.A.; Hedetniemi, S.T. Defending the Roman Empire—A new strategy. *Discret. Math.* **2003**, *266*, 239–251. [[CrossRef](#)]
16. Cabrera Martínez, A.; Yero, I.G. Constructive characterizations concerning weak Roman domination in trees. *Discret. Appl. Math.* **2020**, *284*, 384–390. [[CrossRef](#)]
17. Valveny, M.; Pérez-Rosés, H.; Rodríguez-Velázquez, J.A. On the weak Roman domination number of lexicographic product graphs. *Discret. Appl. Math.* **2019**, *263*, 257–270. [[CrossRef](#)]
18. Cabrera Martínez, A.; Rodríguez-Velázquez, J.A. Total protection of lexicographic product graphs. *Discuss. Math. Graph Theory* **2020**, in press. [[CrossRef](#)]
19. Dettlaff, M.; Lemańska, M.; Rodríguez-Velázquez, J.A. Secure Italian domination in graphs. *J. Comb. Optim.* **2020**, in press. [[CrossRef](#)]
20. Haynes, T.W.; Hedetniemi, S.T.; Slater, P.J. *Domination in Graphs: Advanced Topics*; Chapman and Hall/CRC Pure and Applied Mathematics Series; Marcel Dekker, Inc.: New York, NY, USA, 1998.
21. Haynes, T.W.; Hedetniemi, S.T.; Slater, P.J. *Fundamentals of Domination in Graphs*; Chapman and Hall/CRC Pure and Applied Mathematics Series; Marcel Dekker, Inc.: New York, NY, USA, 1998.

**Publisher’s Note:** MDPI stays neutral with regard to jurisdictional claims in published maps and institutional affiliations.



© 2020 by the authors. Licensee MDPI, Basel, Switzerland. This article is an open access article distributed under the terms and conditions of the Creative Commons Attribution (CC BY) license (<http://creativecommons.org/licenses/by/4.0/>).

## Chapter 6

# Total weak Roman domination in graphs

This chapter includes a complete copy of the following paper.

A. Cabrera Martínez, L.P. Montejano, J.A. Rodríguez-Velázquez. Total weak Roman domination in graphs, *Symmetry* (2019) 11(6), 831.

URL: <https://doi.org/10.3390/sym11060831>

Quality indicators:

2019 JCR Impact factor: 2.645, Q2 (29/71), Multidisciplinary, Sciences.





Article

# Total Weak Roman Domination in Graphs

Abel Cabrera Martínez <sup>1,\*</sup>, Luis P. Montejano <sup>2</sup> and Juan A. Rodríguez-Velázquez <sup>1</sup>

<sup>1</sup> Departament d'Enginyeria Informàtica i Matemàtiques, Universitat Rovira i Virgili, Av. Països Catalans 26, 43007 Tarragona, Spain; juanalberto.rodriguez@urv.cat

<sup>2</sup> CONACYT Research Fellow—Centro de Investigación en Matemáticas, 36023 Guanajuato, GTO, Mexico; luis.montejano@cimat.mx

\* Correspondence: abel.cabrera@urv.cat

Received: 17 May 2019; Accepted: 19 June 2019; Published: 24 June 2019



**Abstract:** Given a graph  $G = (V, E)$ , a function  $f : V \rightarrow \{0, 1, 2, \dots\}$  is said to be a total dominating function if  $\sum_{u \in N(v)} f(u) > 0$  for every  $v \in V$ , where  $N(v)$  denotes the open neighbourhood of  $v$ . Let  $V_i = \{x \in V : f(x) = i\}$ . We say that a function  $f : V \rightarrow \{0, 1, 2\}$  is a total weak Roman dominating function if  $f$  is a total dominating function and for every vertex  $v \in V_0$  there exists  $u \in N(v) \cap (V_1 \cup V_2)$  such that the function  $f'$ , defined by  $f'(v) = 1$ ,  $f'(u) = f(u) - 1$  and  $f'(x) = f(x)$  whenever  $x \in V \setminus \{u, v\}$ , is a total dominating function as well. The weight of a function  $f$  is defined to be  $w(f) = \sum_{v \in V} f(v)$ . In this article, we introduce the study of the total weak Roman domination number of a graph  $G$ , denoted by  $\gamma_{tr}(G)$ , which is defined to be the minimum weight among all total weak Roman dominating functions on  $G$ . We show the close relationship that exists between this novel parameter and other domination parameters of a graph. Furthermore, we obtain general bounds on  $\gamma_{tr}(G)$  and, for some particular families of graphs, we obtain closed formulae. Finally, we show that the problem of computing the total weak Roman domination number of a graph is NP-hard.

**Keywords:** weak Roman domination; total Roman domination; secure total domination; total domination; NP-hard problem

## 1. Introduction

The theory of domination in (finite) graphs can be developed using functions  $f : V(G) \rightarrow A$ , where  $V(G)$  is the vertex set of a graph  $G$  and  $A$  is a set of nonnegative numbers. With this approach, the different types of domination are obtained by imposing certain restrictions on  $f$ . To begin with, let us consider the two simplest cases:  $f$  is said to be a *dominating function* if for every vertex  $v$  such that  $f(v) = 0$ , there exists a vertex  $u$ , adjacent to  $v$ , such that  $f(u) > 0$ ; furthermore,  $f$  is said to be a *total dominating function* (TDF) if for every vertex  $v$ , there exists a vertex  $u$ , adjacent to  $v$ , such that  $f(u) > 0$ . Analogously, a set  $X \subseteq V(G)$  is a *(total) dominating set* if there exists a (total) dominating function  $f$  such that  $f(x) > 0$  if and only if  $x \in X$ . The *(total) domination number* of  $G$ , denoted by  $(\gamma_t(G)) \gamma(G)$ , is the minimum cardinality among all (total) dominating sets. These two parameters have been extensively studied. While the use of functions is not necessary to reach the concept of (total) domination number, later we will see that this idea helps us to easily introduce other more elaborate concepts.

From now on, we restrict ourselves to the case of functions  $f : V(G) \rightarrow \{0, 1, 2\}$ , which are related to the following approach to protection of a graph described by Cockayne et al. [1]. Suppose that one or more entities are stationed at some of the vertices of a simple graph  $G$  and that an entity at a vertex can deal with a problem at any vertex in its closed neighbourhood. In this context, an entity could consist of a robot, an observer, a guard, a legion, and so on. Consider a function  $f : V(G) \rightarrow \{0, 1, 2\}$

where  $f(v)$  denotes the number of entities stationed at  $v$ , and let  $V_i = \{v \in V(G) : f(v) = i\}$  for every  $i \in \{0, 1, 2\}$ . We will identify the function  $f$  with the partition of  $V(G)$  induced by  $f$  and write  $f(V_0, V_1, V_2)$ . The weight of  $f$  is defined to be  $\omega(f) = f(V(G)) = \sum_{v \in V(G)} f(v) = \sum_i i|V_i|$ . Informally, we say that  $G$  is protected under the function  $f$  if there exists at least one entity available to handle a problem at any vertex. We now define some particular subclasses of protected graphs considered in [1] and introduce a new one. The functions in each subclass protect the graph according to a certain strategy.

A *Roman dominating function* (RDF) is a function  $f(V_0, V_1, V_2)$  such that for every vertex  $v \in V_0$  there exists a vertex  $u \in V_2$  which is adjacent to  $v$ . The *Roman domination number*, denoted by  $\gamma_R(G)$ , is the minimum weight among all RDFs on  $G$ . This concept of protection has historical motivation [2] and was formally proposed by Cockayne et al. in [3]. A Roman dominating function with minimum weight  $\gamma_R(G)$  on  $G$  is called a  $\gamma_R(G)$ -function. A similar agreement will be assumed when referring to optimal functions (and sets) associated to other parameters used in the article.

A *total Roman dominating function* (TRDF) on a graph  $G$  is a RDF on  $G$  with the additional condition of being a TDF. The *total Roman domination number* of  $G$ , denoted by  $\gamma_{tr}(G)$ , was defined by Liu and Chang [4] as the minimum weight among all TRDFs on  $G$ . For recent results on total Roman domination in graphs we cite [5].

The remaining domination parameters considered in this paper are directly related to the following idea of protection of a vertex. A vertex  $v \in V_0$  is said to be (*totally*) *protected* under  $f(V_0, V_1, V_2)$  if there exists a vertex  $u \in V_1 \cup V_2$ , adjacent to  $v$ , such that the function  $f'$ , defined by  $f'(v) = 1$ ,  $f'(u) = f(u) - 1$  and  $f'(x) = f(x)$  whenever  $x \in V(G) \setminus \{u, v\}$ , is a (total) dominating function. In such a case, if it is necessary to emphasize the role of  $u$ , then we will say that  $v$  is (*totally*) *protected by  $u$*  under  $f$ .

A *weak Roman dominating function* (WRDF) is a function  $f(V_0, V_1, V_2)$  such that every vertex in  $V_0$  is protected under  $f$ . The *weak Roman domination number*, denoted by  $\gamma_r(G)$ , is the minimum weight among all WRDFs on  $G$ . This concept of protection was introduced by Henning and Hedetniemi [6] and studied further in [7–9].

A *secure dominating function* is a WRDF function  $f(V_0, V_1, V_2)$  in which  $V_2 = \emptyset$ . In this case, it is convenient to define this concept of protection by the properties of  $V_1$ . Obviously  $f(V_0, V_1, \emptyset)$  is a secure dominating function if and only if  $V_1$  is a dominating set and for every  $v \in V_0$  there exists  $u \in V_1$  which is adjacent to  $v$  and  $(V_1 \setminus \{u\}) \cup \{v\}$  is a dominating set as well. In such a case,  $V_1$  is said to be a *secure dominating set*. The *secure domination number*, denoted by  $\gamma_s(G)$ , is the minimum cardinality among all secure dominating sets. This concept of protection was introduced by Cockayne et al. in [1], and studied further in [7,8,10–13].

A set  $X \subseteq V(G)$  is said to be a *secure total dominating set* of  $G$  if it is a total dominating set and for every vertex  $v \notin X$  there exists  $u \in X$  which is adjacent to  $v$  and  $(X \setminus \{u\}) \cup \{v\}$  is a total dominating set as well. The *secure total domination number*, denoted by  $\gamma_{st}(G)$ , is the minimum cardinality among all secure total dominating sets. This concept of protection was introduced by Benecke et al. in [14].

In this article we introduce the study of total weak Roman domination in graphs. We define a *total weak Roman dominating function* (TWRDF) to be a TDF  $f(V_0, V_1, V_2)$  such that every vertex in  $V_0$  is totally protected under  $f$ . The *total weak Roman domination number*, denoted by  $\gamma_{tr}(G)$ , is the minimum weight among all TWRDFs on  $G$ . In particular, we can define a *secure total dominating function* (STDF) to be a TWRDF  $f(V_0, V_1, V_2)$  in which  $V_2 = \emptyset$ . Obviously  $f(V_0, V_1, \emptyset)$  is a STDF if and only if  $V_1$  is a secure total dominating set.

Figure 1 shows a graph  $G$  satisfying  $\gamma_t(G) < \gamma_R(G) < \gamma_{tr}(G) < \gamma_{tr}(G)$  and  $\gamma_r(G) < \gamma_R(G) < \gamma_{tr}(G) < \gamma_{st}(G)$ .

The remainder of this paper is structured as follows. Section 2 will briefly cover some notation and terminology which have not been stated yet. Section 3 introduces basic results which show the close relationship that exists between the total weak Roman domination number and other domination parameters. In Section 4 we obtain general bounds and discuss the extreme cases, while in Section 5

we restrict ourselves to the case of rooted product graphs. Finally, we show that the problem of finding the total weak Roman domination number of a graph is NP-hard.

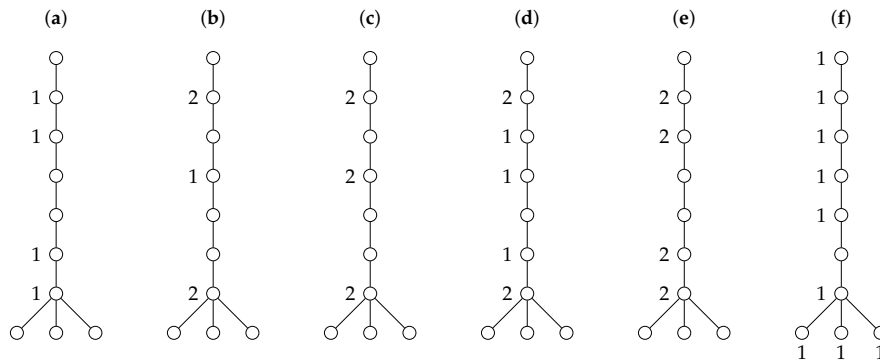

**Figure 1.** Graph  $G$  which satisfies  $\gamma_t(G) = 4$  (a),  $\gamma_r(G) = 5$  (b),  $\gamma_R(G) = 6$  (c),  $\gamma_{tr}(G) = 7$  (d),  $\gamma_{tR}(G) = 8$  (e) and  $\gamma_{st}(G) = 9$  (f).

## 2. Notation

Throughout the paper, we will use the following notation. We consider finite, undirected, and simple graphs  $G$  with vertex set  $V(G)$  and edge set  $E(G)$ . Given a vertex  $v$  of  $G$ ,  $N(v)$  will denote the open neighbourhood of  $v$  in  $G$ , while the closed neighbourhood will be denoted by  $N[v]$ . We say that a vertex  $v \in V(G)$  is universal if  $N[v] = V(G)$ .

We denote the minimum degree of  $G$  by  $\delta(G) = \min_{v \in V(G)} \{|N(v)|\}$  and the maximum degree by  $\Delta(G) = \max_{v \in V(G)} \{|N(v)|\}$ . For a set  $S \subseteq V(G)$ , its open neighbourhood is the set  $N(S) = \cup_{v \in S} N(v)$ , and its closed neighbourhood is the set  $N[S] = N(S) \cup S$ .

The graph obtained from  $G$  by removing all the vertices in  $S \subseteq V(G)$  and all the edges incident with a vertex in  $S$  will be denoted by  $G - S$ . Analogously, the graph obtained from  $G$  by removing all the edges in  $U \subseteq E(G)$  will be denoted by  $G - U$ . If  $H$  is a graph, then we say that  $G$  is  $H$ -free if  $G$  does not contain a copy of  $H$  as an induced subgraph.

Given a set  $S \subseteq V(G)$  and a vertex  $v \in S$ , the external private neighbourhood of  $v$  with respect to  $S$  is defined to be  $epn(v, S) = \{u \in V(G) \setminus S : N(u) \cap S = \{v\}\}$ .

The set of leaves, support vertices and strong support vertices of a graph  $G$ , will be denoted by  $L(G)$ ,  $S(G)$  and  $S_s(G)$ , respectively.

We will use the notation  $N_n$ ,  $K_n$ ,  $K_{1,n-1}$ ,  $P_n$ ,  $C_n$ , and  $K_{r,n-r}$  for empty graphs, complete graphs, star graphs, path graphs, cycle graphs and complete bipartite graphs of order  $n$ , respectively. A subdivided star graph, denoted by  $K_{1,(n-1)/2}^*$ , is a graph of order  $n$  (odd) obtained from a star graph  $K_{1,(n-1)/2}$  by subdividing every edge exactly once.

Let  $G$  and  $H$  be two graphs, respectively. The corona product  $G \odot H$  is defined as the graph obtained from  $G$  and  $H$  by taking one copy of  $G$  and  $|V(G)|$  copies of  $H$  and joining by an edge each vertex from the  $i$ th-copy of  $H$  with the  $i$ th-vertex of  $G$ .

From now on, definitions will be introduced whenever a concept is needed.

## 3. General Results

We begin with two inequality chains relating several domination parameters.

**Proposition 1.** The following inequalities hold for any graph  $G$  with no isolated vertex.

- (i)  $\gamma(G) \leq \gamma_r(G) \leq \gamma_{tr}(G) \leq \gamma_{tR}(G) \leq 2\gamma_t(G)$ .
- (ii)  $\gamma_t(G) \leq \gamma_{tr}(G) \leq \gamma_{st}(G)$ .

**Proof.** It was shown in [5] that  $\gamma_{tr}(G) \leq 2\gamma_t(G)$ , and in [6] that  $\gamma(G) \leq \gamma_r(G)$ . To conclude the proof of (i), we only need to observe that any TWRDF is a WRDF, which implies that  $\gamma_r(G) \leq \gamma_{tr}(G)$ , and any TRDF is a TWRDF, which implies that  $\gamma_{tr}(G) \leq \gamma_{tr}(G)$ .

Now, to prove (ii), we only need to observe that any TWRDF is a TDF, which implies that  $\gamma_t(G) \leq \gamma_{tr}(G)$ , and any STDF is a TWRDF, which implies that  $\gamma_{tr}(G) \leq \gamma_{st}(G)$ .  $\square$

From Proposition 1 we immediately derive the following problem.

**Problem 1.** In each of the following cases, characterize the graphs satisfying the equality.

- (i)  $\gamma_{tr}(G) = \gamma_t(G)$ .
- (ii)  $\gamma_{tr}(G) = \gamma_r(G)$ .
- (iii)  $\gamma_{tr}(G) = \gamma_{st}(G)$ .
- (iv)  $\gamma_{tr}(G) = \gamma_{tr}(G)$ .

The solution of Problem 1 (i) can be found in Theorem 20. While we will give some examples of graphs satisfying the remaining equalities, these problems remain open.

**Theorem 1.** Let  $G$  be a graph. The following statements are equivalent.

- (a)  $\gamma_{tr}(G) = \gamma_r(G)$ .
- (b) There exists a  $\gamma_r(G)$ -function  $f(V_0, V_1, V_2)$  such that  $V_1 = \emptyset$  and  $V_2$  is a total dominating set.
- (c)  $\gamma_r(G) = 2\gamma_t(G)$ .

**Proof.** Suppose that  $\gamma_{tr}(G) = \gamma_r(G)$  and let  $f(V_0, V_1, V_2)$  be a  $\gamma_{tr}(G)$ -function. Notice that  $f$  is a  $\gamma_r(G)$ -function and  $V_1 \cup V_2$  is a total dominating set. Now, suppose that there exists  $u \in V_1$ . Since every vertex in  $V_0$  has at least one neighbour in  $V_2$  or at least two neighbours in  $V_1$ , we can conclude that the function  $g$ , defined by  $g(u) = 0$  and  $g(x) = f(x)$  whenever  $x \in V(G) \setminus \{u\}$ , is a WRDF of weight  $\omega(g) = \omega(f) - 1 = \gamma_r(G) - 1$ , which is a contradiction. Thus,  $V_1 = \emptyset$  and consequently  $V_2$  is a total dominating set.

Now, if there exists a  $\gamma_r(G)$ -function  $f(V_0, V_1, V_2)$  such that  $V_1 = \emptyset$  and  $V_2$  is a total dominating set, then  $2\gamma_t(G) \leq 2|V_2| = \gamma_r(G)$ , and Proposition 1 (i) leads to  $\gamma_r(G) = 2\gamma_t(G)$ .

Finally, if  $\gamma_r(G) = 2\gamma_t(G)$ , then for any  $\gamma_t(G)$ -set  $A$ , there exists a  $\gamma_r(G)$ -function  $f'(V'_0, V'_1, V'_2)$  such that  $V'_1 = \emptyset$  and  $V'_2 = A$ , which is a TWRDF. Hence,  $\gamma_{tr}(G) \leq \omega(f') = \gamma_r(G)$  and Proposition 1 (i) leads to  $\gamma_{tr}(G) = \gamma_r(G)$ .  $\square$

From the theorem above and Proposition 1 we deduce the following result.

**Theorem 2.** For any graph  $G$  with no isolated vertex,

$$\gamma_{tr}(G) \geq \gamma(G) + 1.$$

The bound above is tight. For instance, if  $G$  is a graph having two universal vertices, then  $\gamma_{tr}(G) = \gamma(G) + 1 = 2$ . Another example is shown in Figure 2.

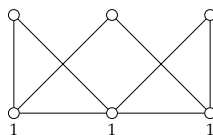

**Figure 2.** A graph  $G$  with  $\gamma_{tr}(G) = \gamma(G) + 1$ .

**Theorem 3.** *The following statements are equivalent.*

- (i)  $\gamma_{tr}(G) = \gamma(G) + 1$ .
- (ii)  $\gamma_{st}(G) = \gamma(G) + 1$ .

**Proof.** First, suppose that (i) holds. Let  $f(V_0, V_1, V_2)$  be a  $\gamma_{tr}(G)$ -function. Since  $V_1 \cup V_2$  is a total dominating set,  $|V_1| + 2|V_2| = \gamma_{tr}(G) = \gamma(G) + 1 \leq \gamma_t(G) + 1 \leq |V_1| + |V_2| + 1$ . Thus,  $|V_2| \leq 1$ . Suppose that  $V_2 = \{u\}$  and let  $v \in N(u) \cap V_1$ . Notice that in this case  $V_1 \cup V_2$  is a  $\gamma(G)$ -set. Now, since  $v$  does not have external private neighbours with respect to  $V_1 \cup V_2$ , we have that  $(V_1 \cup V_2) \setminus \{v\}$  is a dominating set, which is a contradiction. Hence,  $V_2 = \emptyset$  and so  $f$  is a  $\gamma_{st}(G)$ -function. Therefore,  $\gamma_{st}(G) = \omega(f) = \gamma(G) + 1$  and (ii) follows.

Conversely, if (ii) holds, then by Proposition 1 and Theorem 2 we have that  $\gamma(G) + 1 = \gamma_{st}(G) \geq \gamma_{tr}(G) \geq \gamma(G) + 1$ . Therefore,  $\gamma_{tr}(G) = \gamma(G) + 1$  and (i) follows.  $\square$

We continue our analysis by showing another family of graphs satisfying that  $\gamma_{tr}(G) = \gamma_{st}(G)$ , where  $K_{1,3} + e$  is the graph obtained by adding an edge to  $K_{1,3}$ .

**Theorem 4.** *For any  $\{K_{1,3}, K_{1,3} + e\}$ -free graph  $G$  with no isolated vertex,*

$$\gamma_{tr}(G) = \gamma_{st}(G).$$

**Proof.** Let  $f(V_0, V_1, V_2)$  be a  $\gamma_{tr}(G)$ -function such that  $|V_2|$  is minimum. We suppose that  $\gamma_{tr}(G) < \gamma_{st}(G)$ . In such a case,  $V_2 \neq \emptyset$  and we fix a vertex  $v \in V_2$ . Notice that there exist  $y \in N(v) \cap V_0$  and  $z \in N(v) \cap (V_1 \cup V_2)$ . We consider the function  $f'(V'_0, V'_1, V'_2)$  defined by  $f'(v) = 1$ ,  $f'(y) = 1$  and  $f'(x) = f(x)$  whenever  $x \in V(G) \setminus \{v, y\}$ . We claim that  $f'$  is a TWRDF on  $G$ . First, we observe that, by construction,  $f'$  is a TDF on  $G$ . Now, let  $w \in V'_0 \subseteq V_0$  and consider the following two cases.

Case 1.  $w$  is not adjacent to  $v$ . Since  $f$  is a TWRDF on  $G$ ,  $w$  is totally protected under  $f$  and, since  $w \notin N(v)$ ,  $w$  is also totally protected under  $f'$ .

Case 2.  $w$  is adjacent to  $v$ . Notice that  $w \neq y$ . In order to show that  $w$  is totally protected under  $f'$ , we define  $f''(V''_0, V''_1, V''_2)$  by  $f''(v) = 0$ ,  $f''(w) = 1$  and  $f''(x) = f'(x)$  whenever  $x \in V(G) \setminus \{v, w\}$ . Clearly, every vertex  $x \in V(G) \setminus N(v)$  is adjacent to some vertex in  $V''_1 \cup V''_2$ . Now, we fix  $u \in N(v)$  and let  $D$  be the set of vertices formed by  $v$ ,  $u$  and two vertices in  $\{w, y, z\} \setminus \{u\}$ . As  $G$  is a  $\{K_{1,3}, K_{1,3} + e\}$ -free graph, it follows that at least one vertex in  $D \setminus \{v\}$  is adjacent to the another two vertices in  $D$ . Since  $w, y, z \in V''_1 \cup V''_2$ , we have that  $u \in N(V''_1 \cup V''_2)$  and so  $f''$  is a TDF on  $G$ , as desired.

Thus  $f'$  is a TWRDF on  $G$  with  $\omega(f') = \omega(f)$  and  $|V'_2| < |V_2|$ , which is a contradiction. Consequently, we conclude that  $\gamma_{tr}(G) = \gamma_{st}(G)$ .  $\square$

We would emphasize that the equality  $\gamma_{tr}(G) = \gamma_{st}(G)$  is not restrictive to  $\{K_{1,3}, K_{1,3} + e\}$ -free graphs. To see this, we can take  $G \cong C_3 \square P_3$  (see Figure 4).

As a direct consequence of the result above we have that any graph  $G$  obtained as the disjoint union of paths and/or cycles satisfies that  $\gamma_{tr}(G) = \gamma_{st}(G)$ .

**Corollary 1.** *For any graph  $G$  with no isolated vertex and maximum degree  $\Delta(G) \leq 2$ ,*

$$\gamma_{tr}(G) = \gamma_{st}(G).$$

From Corollary 1 and the values of  $\gamma_{st}(P_n)$  and  $\gamma_{st}(C_n)$  obtained in [14], we derive the following result.

**Remark 1.** For any path  $P_n$  and any cycle  $C_n$ ,

- (i)  $\gamma_{tr}(P_n) = \gamma_{st}(P_n) \stackrel{[14]}{=} \left\lceil \frac{5(n-2)}{7} \right\rceil + 2.$
- (ii)  $\gamma_{tr}(C_n) = \gamma_{st}(C_n) \stackrel{[14]}{=} \left\lceil \frac{5n}{7} \right\rceil.$

Our next result will become a useful tool to study the total weak Roman domination number.

**Proposition 2.** If  $H$  is a spanning subgraph (with no isolated vertex) of a graph  $G$ , then

$$\gamma_{tr}(G) \leq \gamma_{tr}(H).$$

**Proof.** Let  $E^- = \{e_1, \dots, e_k\}$  be the set of all edges of  $G$  not belonging to the edge set of  $H$ . Let  $H_0 = G$  and, for every  $i \in \{1, \dots, k\}$ , let  $X_i = \{e_1, \dots, e_i\}$  and  $H_i = G - X_i$ . Since any TWRDF on  $H_i$  is a TWRDF on  $H_{i-1}$ , we can conclude that  $\gamma_{tr}(H_{i-1}) \leq \gamma_{tr}(H_i)$ . Hence,  $\gamma_{tr}(G) = \gamma_{tr}(H_0) \leq \gamma_{tr}(H_1) \leq \dots \leq \gamma_{tr}(H_k) = \gamma_{tr}(H)$ .  $\square$

From Remark 1 and Proposition 2 we obtain the following result.

**Corollary 2.** Let  $G$  be a graph of order  $n$ .

- If  $G$  is a Hamiltonian graph, then  $\gamma_{tr}(G) \leq \left\lceil \frac{5n}{7} \right\rceil.$
- If  $G$  has a Hamiltonian path, then  $\gamma_{tr}(G) \leq \left\lceil \frac{5(n-2)}{7} \right\rceil + 2.$

The bounds above are tight, as they are achieved for  $C_n$  and  $P_n$ , respectively.

A 2-packing of a graph  $G$  is a set  $X \subseteq V(G)$  such that  $N[u] \cap N[v] = \emptyset$  for every pair of different vertices  $u, v \in X$ . The 2-packing number  $\rho(G)$  is defined as the maximum cardinality among all 2-packings of  $G$ . It is well known that for any graph  $G$ ,  $\gamma(G) \geq \rho(G)$  (see for instance [15]). Furthermore, Meir and Moon [16] showed in 1975 that  $\gamma(T) = \rho(T)$  for every tree  $T$ .

**Theorem 5.** For any graph  $G$  with no isolated vertex,

$$\gamma_{tr}(G) \geq 2\rho(G).$$

Furthermore, for any tree  $T$ ,

$$\gamma_{tr}(T) \geq 2\gamma(T).$$

**Proof.** Let  $f$  be a  $\gamma_{tr}(G)$ -function and  $S$  a  $\rho(G)$ -set. Since  $f(N[v]) \geq 2$  for every vertex  $v \in V(G)$ , and  $N[x] \cap N[y] = \emptyset$  for every pair of different vertices  $x, y \in S$ ,

$$\gamma_{tr}(G) \geq \sum_{v \in S} f(N[v]) \geq 2|S| = 2\rho(G).$$

Therefore, the result follows.  $\square$

To show that the bound above is tight we can consider the case of corona graphs (see Theorem 30).

**Theorem 6.** For any graph  $G$  with no isolated vertex,

$$\gamma_{tr}(G) \leq \gamma_t(G) + \gamma(G).$$

**Proof.** Let  $D$  be a  $\gamma_t(G)$ -set and  $S$  a  $\gamma(G)$ -set. We define the function  $f(V_0, V_1, V_2)$  on  $G$ , where  $V_2 = D \cap S$  and  $V_1 = (D \cup S) \setminus V_2$ . We claim that  $f$  is a TWRDF on  $G$ . First, notice that  $f$  is a TDF on  $G$ . Now, let  $v \in V_0$ . If  $v$  has a neighbour in  $V_2$ , then  $v$  is totally protected under

f. If  $v$  has no neighbour in  $V_2$ , then  $v$  has a neighbour  $x \in D \setminus V_2$  and a neighbour  $y \in S \setminus V_2$ . Consider the function  $f'$  defined by  $f'(v) = 1, f'(y) = 0$ , and  $f'(x) = f(x)$  whenever  $x \in V(G) \setminus \{v, y\}$ . Since  $D$  is a total dominating set of  $G$ ,  $f'$  is a TDF on  $G$ . Hence,  $f$  is a TWRDF on  $G$  of weight  $\omega(f) = 2|V_2| + |V_1| = |D| + |S| = \gamma_t(G) + \gamma(G)$ . Therefore, the result follows.  $\square$

Notice that for any graph  $G$  of order  $n$ , minimum degree  $\delta(G) \geq 1$  and maximum degree  $\Delta(G) \geq n - 2$ , we have that  $\gamma_t(G) = 2$ . Therefore, Theorem 6 leads to the following result.

**Corollary 3.** For any graph  $G$  of order  $n$ , minimum degree  $\delta(G) \geq 1$  and maximum degree  $\Delta(G) \geq n - 2$ ,

$$\gamma_{tr}(G) \leq 4.$$

It is not difficult to check that the bound above is achieved for any graph  $G$  constructed by joining with an edge the vertex of a trivial graph  $N_1$  and a leaf of a star graph  $K_{1,n-2}$ , where  $n \geq 4$ .

If a graph  $G$  has diameter two, then for any vertex  $v \in V(G)$  the open neighbourhood  $N(v)$  is a dominating set and the closed neighbourhood  $N[v]$  is a total dominating set. Hence, the following result is derived from Theorem 6.

**Corollary 4.** If  $G$  is a graph of diameter two and minimum degree  $\delta(G)$ , then

$$\gamma_{tr}(G) \leq 2\delta(G) + 1.$$

The bound above is tight. For instance, it is achieved for any star graph  $K_{1,n-1}$  with  $n \geq 3$ .

As shown in [17], if  $G$  is a planar graph of diameter two, then  $\gamma_t(G) \leq 3$ , and  $\gamma(G) \leq 2$  or  $G$  is the graph shown in Figure 3. Hence, from these inequalities and Theorem 6 we derive the following tight bound.

**Theorem 7.** If  $G$  is a planar graph of diameter two, then  $\gamma_{tr}(G) \leq 5$ .

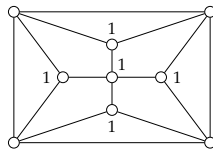

Figure 3. A planar graph of diameter two with  $\gamma_{tr}(G) = 5$ .

We already know that  $\gamma_{tr}(G) \leq 2\gamma_t(G)$  (Proposition 1 (i)). Hence, as a direct consequence of this inequality and Theorems 1 and 6 we deduce the following result.

**Theorem 8.** Let  $G$  be a graph. If  $\gamma_{tr}(G) = \gamma_r(G)$ , then  $\gamma_t(G) = \gamma(G)$ .

In general,  $\gamma_t(G) = \gamma(G)$  does not imply that  $\gamma_{tr}(G) = \gamma_r(G)$ . For instance, see the graph shown in Figure 4.

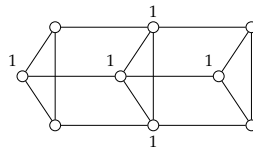

Figure 4. The graph  $C_3 \square P_3$  satisfies  $\gamma_{tr}(C_3 \square P_3) = 5 > 3 = \gamma_r(C_3 \square P_3)$ , while  $\gamma_t(C_3 \square P_3) = \gamma(C_3 \square P_3) = 3$ .

**Theorem 9** ([5]). *If  $G$  is a graph with no isolated vertex, then  $\gamma_{tR}(G) \leq 3\gamma(G)$ . Furthermore, if  $\gamma_{tR}(G) = 3\gamma(G)$ , then every  $\gamma(G)$ -set is a 2-packing of  $G$ .*

The following result is a direct consequence of combining Proposition 1 (i) and Theorems 6 and 9.

**Theorem 10.** *For any graph  $G$  with no isolated vertex,*

$$\gamma_{tr}(G) \leq 3\gamma(G).$$

*Furthermore, if  $\gamma_{tr}(G) = 3\gamma(G)$  then  $\gamma_t(G) = 2\gamma(G)$  and every  $\gamma(G)$ -set is a 2-packing of  $G$ .*

Notice that the inequality  $\gamma_{tr}(G) \leq 3\gamma(G)$  can be also deduced from the following result.

**Theorem 11.** *For any graph  $G$  with no isolated vertex,*

$$\gamma_{tr}(G) \leq \gamma_r(G) + \gamma(G).$$

**Proof.** Let  $f(V_0, V_1, V_2)$  be a  $\gamma_r(G)$ -function such that  $|V_2|$  is maximum among all  $\gamma_r(G)$ -functions and let  $S$  be a  $\gamma(G)$ -set. Now, we consider the function  $f'(V'_0, V'_1, V'_2)$  defined as follows.

- (a) For every  $x \in V_2 \cap S$ , choose a vertex  $u \in (V_0 \cap N(x)) \setminus S$  if it exists, and label it as  $f'(u) = 1$ .
- (b) For every  $x \in V_1 \cap S$ , choose a vertex  $u \in \text{epn}(x, V_1 \cup V_2) \setminus S$  if it exists, otherwise choose a vertex  $u \in (V_0 \cap N(x)) \setminus S$  (if exists) and label it as  $f'(u) = 1$ .
- (c) For every vertex  $x \in V_0 \cap S$ ,  $f'(x) = 1$ .
- (d) For any other vertex  $u$  not previously labelled,  $f'(u) = f(u)$ .

We claim that  $f'$  is a TWRDF on  $G$ . Firstly, observe that  $f'$  is a TDF on  $G$ . Let  $v \in V'_0 \subseteq V_0$ . If there exists a vertex  $u \in N(v) \cap V_2 \subseteq V'_2$ , then  $v$  is totally protected under  $f'$ . Now, suppose that  $N(v) \cap V_2 = \emptyset$  and let  $u \in N(v) \cap V_1 \subseteq V'_1$  such that  $v$  is protected by  $u$  under  $f$ . In order to show that  $v$  is totally protected under  $f'$ , we consider the function  $f''(V''_0, V''_1, V''_2)$  defined by  $f''(v) = 1$ ,  $f''(u) = 0$  and  $f''(x) = f'(x)$  whenever  $x \in V(G) \setminus \{v, u\}$ . We only need to show that  $f''$  is a TDF on  $G$ . By definition of  $f''$ , every vertex in  $V(G) \setminus N(u)$  is adjacent to some vertex in  $V''_1 \cup V''_2$ . Hence, we differentiate the following cases for any  $w \in N(u)$ .

Case 1.  $w \in (V_1 \cup V_2) \setminus \{u\}$ . If  $w$  has degree one, then  $f(w) = f(u) = 1$  and we can construct a  $\gamma_r(G)$ -function where the number of vertices with label two is greater than  $|V_2|$ , which is a contradiction. Hence,  $N(w) \cap (V_1 \cup V_2) \setminus \{u\} \neq \emptyset$  or  $N(w) \cap V_0 \neq \emptyset$ . In the first case, we conclude that  $w$  is adjacent to some vertex in  $(V_1 \cup V_2) \setminus \{u\} \subseteq V'_1 \cup V'_2$ . If this case does not occur, then by (b) and (c) in the definition of  $f'$ , there exists  $y \in N(w) \cap V_0$  satisfying that  $y \in V'_1 \setminus \{u\} \subseteq V'_1$ .

Case 2.  $w \in V_0$ . If  $w \notin \text{epn}(u, V_1 \cup V_2)$  then it is adjacent to some vertex in  $(V_1 \cup V_2) \setminus \{u\} \subseteq V'_1 \cup V'_2$ . From now on, suppose that  $w \in \text{epn}(u, V_1 \cup V_2)$ . If  $v \neq w$ , then  $w$  must be adjacent to  $v \in V'_1$ , as  $v$  is protected by  $u$  under  $f$ . Now, if  $v = w$  and  $u \notin S$ , then  $w$  is adjacent to some vertex in  $S \subseteq V'_1 \cup V'_2$ . Finally, if  $v = w$  and  $u \in S$ , then by (b) in the definition of  $f'$  we have that  $f'(v) = 1$ , which is a contradiction.

From the two cases above we can conclude that  $f''$  is a TDF on  $G$ , as required. Therefore,  $f'$  is a TWRDF and, as a consequence,  $\gamma_{tr}(G) \leq \omega(f') \leq \gamma_r(G) + \gamma(G)$ .  $\square$

**Corollary 5.** *For any graph  $G$  with no isolated vertex,*

$$\gamma_{tr}(G) \leq 2\gamma_r(G).$$

*Furthermore, if  $\gamma_r(G) > \gamma(G)$ , then  $\gamma_{tr}(G) \leq 2\gamma_r(G) - 1$ .*



In order to derive another consequence of Theorem 11 we need to state the following result.

**Theorem 12 ([12]).** For any connected graph  $G \not\cong C_5$  of order  $n$  and minimum degree  $\delta(G) \geq 2$ ,

$$\gamma_s(G) \leq \left\lfloor \frac{n}{2} \right\rfloor.$$

Since  $\gamma_r(G) \leq \gamma_s(G)$ , from Theorems 11 and 12 we immediately have the next theorem.

**Theorem 13.** For any connected graph  $G$  of order  $n$  and minimum degree  $\delta(G) \geq 2$ ,

$$\gamma_{tr}(G) \leq \left\lfloor \frac{n}{2} \right\rfloor + \gamma(G).$$

The bound above is tight. It is achieved for the graph  $C_5$ .

**Theorem 14.** Let  $G$  be a graph with no isolated vertex. For any  $\gamma_r(G)$ -function  $f(V_0, V_1, V_2)$ ,

$$\gamma_{tr}(G) \leq 2\gamma_r(G) - |V_2|.$$

**Proof.** Let  $g(V_0, V_1, V_2)$  be a  $\gamma_r(G)$ -function such that  $|V_2|$  is maximum, and consider the function  $g'(V'_0, V'_1, V'_2)$  defined on  $G$  as follows.

- For every  $x \in V_2$ , choose a vertex  $u \in V_0 \cap N(x)$  and label it as  $g'(u) = 1$ .
- For every  $x \in V_1$ , choose a vertex  $u \in \text{epn}(x, V_1 \cup V_2)$  if it exists, otherwise choose a vertex  $u \in V_0 \cap N(x)$  (if exists) and label it as  $g'(u) = 1$ .
- For any other vertex  $u$  not previously labelled,  $g'(u) = g(u)$ .

We claim that  $g'$  is a TWRDF on  $G$ . Firstly, observe that  $g'$  is a TDF on  $G$ . Let  $v \in V'_0 \subseteq V_0$ . If there exists a vertex  $u \in N(v) \cap V_2$ , then  $v$  is totally protected under  $g'$ . Now, suppose that  $N(v) \cap V_2 = \emptyset$  and let  $u \in N(v) \cap V_1$  such that  $v$  is protected by  $u$  under  $f$ . In order to show that  $v$  is totally protected under  $g'$ , we consider the function  $g^*(V_0^*, V_1^*, V_2^*)$  defined by  $g^*(v) = 1$ ,  $g^*(u) = 0$  and  $g^*(x) = g'(x)$  if  $x \in V(G) \setminus \{v, u\}$ . We only need to show that  $g^*$  is a TDF on  $G$ .

By definition of  $g^*$ , every vertex in  $V(G) \setminus N(u)$  is adjacent to some vertex in  $V_1^* \cup V_2^*$ . Hence, we differentiate the following two cases for any  $w \in N(u)$ .

Case 1.  $w \in (V_1 \cup V_2) \setminus \{u\}$ . If  $w$  has degree one, then we can construct a  $\gamma_r(G)$ -function where the number of vertices with label two is greater than  $|V_2|$ , which is a contradiction. Hence,  $N(w) \cap (V_1 \cup V_2) \setminus \{u\} \neq \emptyset$  or  $N(w) \cap V_0 \neq \emptyset$ . In the first case, we conclude that  $w$  is adjacent to some vertex in  $(V_1 \cup V_2) \setminus \{u\} \subseteq V_1^* \cup V_2^*$ . If this case does not occur, then by definition of  $g'$  there exists  $y \in N(w) \cap V_0$  satisfying that  $y \in V'_1 \setminus \{u\} \subseteq V_1^*$ .

Case 2.  $w \in V_0$ . If  $w \notin \text{epn}(u, V_1 \cup V_2)$  then it is adjacent to some vertex in  $(V_1 \cup V_2) \setminus \{u\} \subseteq V_1^* \cup V_2^*$ . From now on, we suppose that  $w \in \text{epn}(u, V_1 \cup V_2)$ . If  $w \neq v$ , then  $w$  must be adjacent to  $v \in V_1^*$ , as  $v$  is protected by  $u$  under  $f$ . Now, if  $w = v$ , then by (b) in the definition of  $g'$  and the fact that  $v$  is protected by  $u$  under  $f$  we have that there exists  $y \in V'_1 \cap \text{epn}(u, V_1 \cup V_2) \cap N(v)$ .

From the two cases above we can conclude that,  $g^*$  is a TDF on  $G$ . Thus,  $g'$  is a TWRDF and, as a consequence,  $\gamma_{tr}(G) \leq \omega(g') = |V'_1| + 2|V'_2| \leq |V_1| + 2|V_2| + |V_1| + |V_2| = 2\gamma_r(G) - |V_2|$ . Finally, since  $|V_2|$  is maximum among all  $\gamma_{tr}(G)$ -functions, the result follows.  $\square$

We now proceed to construct a family of graphs  $G_{p,q}$  with  $\gamma_r(G_{p,q}) = p + 1$  and  $\gamma_{tr}(G_{p,q}) = 2p + 1$ , where  $q \geq p \geq 2$  are integers. The graph  $G_{p,q}$  is constructed from the complete bipartite graph  $K_{p,q}$  and the empty graph  $N_p$  by adding  $p$  new edges which form a matching between the vertices of  $N_p$  and the vertices of degree  $q$  in  $K_{p,q}$ . Notice that there exists a  $\gamma_r(G_{p,q})$ -function  $g(V_0, V_1, V_2)$  with  $|V_2| = 1$ . Therefore,  $\gamma_{tr}(G_{p,q}) = 2p + 1 = 2(p + 1) - 1 = 2\gamma_r(G_{p,q}) - 1 = 2\gamma_r(G_{p,q}) - |V_2|$ .

Figure 5 shows the graph  $G_{3,4}$  and a  $\gamma_{tr}(G_{3,4})$ -function  $g(V_0, V_1, V_2)$ , obtained by using the construction of the proof of Theorem 14. One can check that  $\gamma_{tr}(G_{3,4}) = 7$ ,  $\gamma_r(G_{3,4}) = 4$  and  $|V_2| = 1$ , concluding that  $\gamma_{tr}(G_{3,4}) = 2\gamma_r(G_{3,4}) - |V_2|$ .

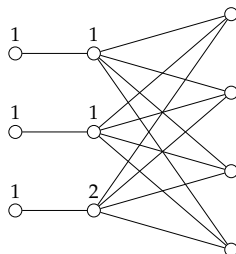

Figure 5. The graph  $G_{3,4}$ .

If  $\gamma_r(G) < \gamma_s(G)$ , then there exists a  $\gamma_r(G)$ -function  $f(V_0, V_1, V_2)$  such that  $V_2 \neq \emptyset$ . Therefore, the following result is a direct consequence of Theorem 14.

**Corollary 6.** Let  $G$  be a graph with no isolated vertex. If  $\gamma_r(G) < \gamma_s(G)$ , then

$$\gamma_{tr}(G) \leq 2\gamma_r(G) - 1.$$

We continue with a result that provides a new relationship between the total weak Roman domination number and the Roman domination number. To this end, we need to state the following known result.

**Theorem 15 ([5]).** If  $G$  is a graph of order  $n$  with no isolated vertex, then  $\gamma_{tR}(G) \leq 2\gamma_R(G) - 1$ . Furthermore,  $\gamma_{tR}(G) = 2\gamma_R(G) - 1$  if and only if  $\Delta(G) = n - 1$ .

**Theorem 16.** For any graph  $G$  of order  $n$  with no isolated vertex,

$$\gamma_{tr}(G) \leq 2\gamma_R(G) - 1.$$

Furthermore,  $\gamma_{tr}(G) = 2\gamma_R(G) - 1$  if and only if  $\gamma_{tr}(G) = 3$  and  $\Delta(G) = n - 1$ .

**Proof.** By Proposition 1 (i) and Theorem 15, the inequality holds. Furthermore, if  $\gamma_{tr}(G) = 2\gamma_R(G) - 1$  then, again by Proposition 1 and Theorem 15,  $\gamma_{tR}(G) = 2\gamma_R(G) - 1$  and this implies that  $\Delta(G) = n - 1$ . Thus,  $\gamma_R(G) = 2$ , and so  $\gamma_{tr}(G) = 3$ . Conversely, if  $\gamma_{tr}(G) = 3$  and  $\Delta(G) = n - 1$ , then  $\gamma_R(G) = 2$  and  $\gamma_{tr}(G) = 2\gamma_R(G) - 1$ .  $\square$

#### 4. General Bounds

Our next two results provide bounds in terms of the order, the minimum degree and the maximum degree of  $G$ .

**Theorem 17.** For any graph  $G$  of order  $n$  with  $\delta(G) \geq 1$ ,

$$\left\lceil \frac{2n}{\Delta(G) + 1} \right\rceil \leq \gamma_{tr}(G) \leq n - \delta(G) + 1.$$

**Proof.** Let  $f(V_0, V_1, V_2)$  be a  $\gamma_{tr}(G)$ -function and let  $V_0^2 = \{x \in V_0 : N(x) \cap V_2 \neq \emptyset\}$  and  $V_0^1 = V_0 \setminus V_0^2$ . Since every vertex in  $V_2$  can have at most  $\Delta(G) - 1$  neighbours in  $V_0^2$ , we obtain that  $|V_0^2| \leq (\Delta(G) - 1)|V_2|$ .

Furthermore, since every vertex in  $V_0^1$  has at least two neighbours in  $V_1$  and every vertex in  $V_1$  has at most  $\Delta(G) - 1$  neighbours in  $V_0^1$ , we deduce that  $2|V_0^1| \leq (\Delta(G) - 1)|V_1|$ . Hence,

$$\begin{aligned} n &= |V_0^1| + |V_0^2| + |V_1| + |V_2| \\ &\leq (\Delta(G) - 1)|V_1|/2 + (\Delta(G) - 1)|V_2| + |V_1| + |V_2| = (\Delta(G) + 1)|V_1|/2 + \Delta(G)|V_2| \\ &\leq (\Delta(G) + 1)|V_1|/2 + \Delta(G)|V_2| + |V_2| \\ &\leq (\Delta(G) + 1)(|V_1|/2 + |V_2|) = (\Delta(G) + 1)\gamma_{tr}(G)/2. \end{aligned}$$

Therefore,  $\gamma_{tr}(G) \geq \left\lceil \frac{2n}{\Delta(G)+1} \right\rceil$ .

The upper bound follows for  $\delta(G) = 1$ , so we assume that  $\delta(G) \geq 2$ . Let  $v \in V(G)$  be a vertex of degree  $\delta(G)$  and  $u \in N(v)$ . It is readily seen that the function  $g$ , defined by  $g(x) = 0$  for every  $x \in N(v) \setminus \{u\}$  and  $g(x) = 1$  otherwise, is a TWRDF on  $G$ . Therefore,  $\gamma_{tr}(G) \leq \omega(g) = n - \delta(G) + 1$ .  $\square$

The bounds above are tight. For instance, they are achieved for any complete nontrivial graph and for the cycles  $C_n$  with  $n \leq 5$ . Furthermore, the wheel graph  $K_1 + C_4$  achieves the upper bound and any corona graph  $K_2 \odot H$  achieves the lower bound, where  $|V(H)| \geq 3$ . Notice that  $\gamma_{tr}(K_2 \odot H) = 4$ . The limit cases  $\gamma_{tr}(G) = 2$  and  $\gamma_{tr}(G) = n$  will be discussed in Theorem 20.

**Theorem 18 ([14]).** *Let  $G$  be a graph of order  $n$ . Then  $\gamma_{st}(G) = n$  if and only if  $V(G) \setminus (L(G) \cup S(G))$  is an independent set.*

**Theorem 19 ([13]).** *If  $G$  is a connected graph, then the following statements are equivalent.*

- $\gamma_{st}(G) = \gamma_t(G)$ .
- $\gamma_{st}(G) = 2$ .
- $G$  has two universal vertices.

We now proceed to characterize all graphs achieving the limit cases of the trivial bounds  $2 \leq \gamma_{tr}(G) \leq n$ .

**Theorem 20.** *Given a connected graph  $G$  of order  $n$ , the following statements hold.*

(i) *The following statements are equivalent.*

- (a)  $\gamma_{tr}(G) = 2$ .
- (b)  $\gamma_{tr}(G) = \gamma_t(G)$ .
- (c)  $\gamma_{st}(G) = \gamma_t(G)$ .
- (d)  $G$  has two universal vertices.

(ii)  $\gamma_{tr}(G) = n$  if and only if  $G$  is  $K_{1,(n-1)/2}^*$  or  $H \odot N_1$  for some connected graph  $H$ .

**Proof.** We first proceed to prove (i). Notice that (a) directly implies (b), as  $2 \leq \gamma_t(G) \leq \gamma_{tr}(G)$ . Now, suppose that (b) holds and let  $f(V_0, V_1, V_2)$  be a  $\gamma_{tr}(G)$ -function. Since  $f$  is a TDF,  $\gamma_t(G) \leq |V_1 \cup V_2| = |V_1| + |V_2| \leq |V_1| + 2|V_2| = \gamma_{tr}(G) = \gamma_t(G)$ , so  $V_2 = \emptyset$  and, as a consequence,  $f$  is a STDF of weight  $\gamma_t(G)$ . Hence, (c) holds. On the other hand, by Theorem 19, (c) implies (d). Finally, it is straightforward that (d) implies (a).

We now proceed to prove (ii). If  $G$  is  $K_{1,(n-1)/2}^*$  or  $H \odot N_1$  for some connected graph  $H$ , then is straightforward that  $\gamma_{tr}(G) = n$ . From now on we assume that  $G$  is a connected graph such that  $\gamma_{tr}(G) = n$ . Since  $\gamma_{tr}(G) \leq \gamma_{st}(G) \leq n$ , we have that  $\gamma_{st}(G) = n$  and so, by Theorem 18,  $V(G) = L(G) \cup S(G) \cup I$ , where  $I$  is an independent set. Moreover, notice that if  $n = 2$  then  $G \cong P_2 \cong N_1 \odot N_1$ , and if  $|S(G)| = 1$  then  $G \cong P_3 \cong K_{1,1}^*$ . So, we assume that  $n \geq 4$  and  $|S(G)| \geq 2$ .

Suppose that  $v \in S_s(G)$  and let  $h_1$  and  $h_2$  be two leaves adjacent to  $v$ . We consider the function  $g$  defined by  $g(h_1) = g(h_2) = 0$ ,  $g(v) = 2$  and  $g(x) = 1$  if  $x \in V(G) \setminus \{v, h_1, h_2\}$ . Hence,  $g$  is a TWRDF on  $G$  and  $\omega(g) = n - 1$ , which is a contradiction. Thus  $S_s(G) = \emptyset$ . We now differentiate two cases.

Case 1.  $I = \emptyset$ . In this case,  $V(G) = L(G) \cup S(G)$  and, since  $G$  is connected, the subgraph  $H$  induced by  $S(G)$  is connected. Furthermore, since  $S_s(G) = \emptyset$ , we have that  $G \cong H \odot N_1$ .

Case 2.  $I \neq \emptyset$ . Suppose that  $S(G)$  is not an independent set. Notice that there exist two adjacent support vertices  $v, w$  and a third vertex  $s \in N(v) \cap I$ . Let  $h \in N(v) \cap L(G)$  and consider the function  $g$  defined by  $g(v) = 2, g(h) = g(s) = 0$  and  $g(x) = 1$  if  $x \in V(G) \setminus \{v, h, s\}$ . Notice that  $g$  is a TWRDF on  $G$  and  $\omega(g) = n - 1$ , which is a contradiction, so  $S(G)$  is an independent set. Now, suppose that  $|I| \geq 2$  and let  $s_1, s_2 \in I$  be two vertices at the shortest possible distance. Since  $S(G)$  and  $I$  are independent sets,  $s_1$  and  $s_2$  are at distance two. Let  $v \in S(G) \cap N(s_1) \cap N(s_2)$ , let  $h \in N(v) \cap L(G)$  and let  $g'$  be a function defined by  $g'(v) = 2, g'(s_1) = g'(h) = 0$ , and  $g'(x) = 1$  if  $x \in V(G) \setminus \{v, s_1, h\}$ . Observe that  $g'$  is a TWRDF on  $G$  and  $\omega(g') = n - 1$ , which is a contradiction. Thus,  $|I| = 1$ . Therefore, since  $S_s(G) = \emptyset$ ,  $S(G)$  is an independent set and  $|I| = 1$ , we conclude that  $G$  is the subdivided star  $K_{1, (n-1)/2}^*$  and this completes the proof.  $\square$

To conclude this section, we proceed to characterize all graphs with  $\gamma_{tr}(G) = 3$ .

**Theorem 21.** *Let  $G$  be a graph and let  $\mathcal{G}$  be the family of graphs  $H$  of order  $n \geq 3$  such that the subgraph induced by three vertices of  $H$  contains a path  $P_3$  and the remaining  $n - 3$  vertices have degree two and they form an independent set. Then  $\gamma_{tr}(G) = 3$  if and only if there exists  $H \in \mathcal{G} \cup \{K_{1, n-1}\}$  which is a spanning subgraph of  $G$  and  $G$  has at most one universal vertex.*

**Proof.** We first suppose that  $\gamma_{tr}(G) = 3$ . Let  $f(V_0, V_1, V_2)$  be a  $\gamma_{tr}(G)$ -function. By Theorem 20 (i),  $G$  has at most one universal vertex. If  $|V_2| = 1$ , then  $|V_1| = 1$ . In such a case, let  $V_1 = \{v\}$  and  $V_2 = \{u\}$ . Notice that  $u$  and  $v$  are adjacent vertices. Since  $f$  is a TWRDF on  $G$ , any vertex must be adjacent to  $u$ , concluding that  $K_{1, n-1}$  is a spanning subgraph of  $G$ . Now, if  $|V_2| = 0$ , then  $|V_1| = 3$ . With this assumption, let  $V_1 = \{u, v, w\}$  and notice that the subgraph of  $G$  induced by  $V_1$  contains a path  $P_3$ , as  $V_1$  is a total dominating set of  $G$ . We may suppose that  $v$  is adjacent to  $u$  and  $w$ . Since  $f$  is a TWRDF on  $G$ , we observe that  $|N(z) \cap V_1| \geq 2$  for every  $z \in V_0$ . Hence, in this case,  $G$  contains a spanning subgraph belonging to  $\mathcal{G}$ .

Conversely, since  $G$  has at most one universal vertex, by Theorem 20 (i) we have that  $\gamma_{tr}(G) \geq 3$ . Moreover, it is readily seen that  $\gamma_{tr}(K_{1, n-1}) = 3$  and  $\gamma_{tr}(H) \leq 3$  for any  $H \in \mathcal{G}$ . Hence, if  $H \in \mathcal{G} \cup \{K_{1, n-1}\}$  is a spanning subgraph of  $G$ , by Proposition 2 it follows that  $\gamma_{tr}(G) \leq 3$ . Therefore,  $\gamma_{tr}(G) = 3$ .  $\square$

### 5. Rooted Product Graphs and Computational Complexity

Let  $G$  and  $H$  be two graphs and let  $v \in V(H)$ . The rooted product graph  $G \circ_v H$  is defined to be the graph obtained from  $G$  and  $H$  by taking one copy of  $G$  and  $|V(G)|$  copies of  $H$  and identifying the  $i$ th-vertex of  $G$  with vertex  $v$  in the  $i$ th-copy of  $H$  for every  $i \in \{1, \dots, |V(G)|\}$ .

For every  $x \in V(G)$ ,  $H_x$  will denote the copy of  $H$  in  $G \circ_v H$  containing  $x$ . The restriction of any  $\gamma_{tr}(G \circ_v H)$ -function  $f$  to  $V(H_x)$  will be denoted by  $f_x$ , and the restriction to  $V(H_x - \{x\})$  will be denoted by  $f_x^-$ . Notice that  $V(G \circ_v H) = \cup_{x \in V(G)} V(H_x)$  and so

$$\gamma_{tr}(G \circ_v H) = \omega(f) = \sum_{x \in V(G)} \omega(f_x) = \sum_{x \in V(G)} \omega(f_x^-) + \sum_{x \in V(G)} f(x).$$

**Lemma 1.** *Let  $f(V_0, V_1, V_2)$  be a  $\gamma_{tr}(G \circ_v H)$ -function. For any  $x \in V(G)$ ,  $\omega(f_x) \geq \gamma_{tr}(H) - 2$ . Furthermore, if  $\omega(f_x) = \gamma_{tr}(H) - 2$ , then  $f(x) = 0$  and  $N(x) \cap V(H_x) \subseteq V_0$ .*

**Proof.** Let  $x \in V(G)$ . Notice that every vertex in  $V_0 \cap V(H_x) \setminus \{x\}$  is totally protected under  $f_x$ . Now, suppose that  $\omega(f_x) \leq \gamma_{tr}(H) - 3$  and let  $y \in N(x) \cap V(H_x)$ . Observe that the function  $g$ , defined by  $g(y) = 2$  and  $g(u) = f_x(u)$  whenever  $u \in V(H_x) \setminus \{y\}$ , is a TWRDF on  $H_x$  of weight  $\omega(g) \leq \gamma_{tr}(H) - 1$ , which is a contradiction as  $H_x \cong H$ . Hence,  $\omega(f_x) \geq \gamma_{tr}(H) - 2$ .

Now, suppose that  $\omega(f_x) = \gamma_{tr}(H) - 2$ . If  $f(x) > 0$  then given a vertex  $y \in N(x) \cap V(H_x)$ , the function  $h$ , defined by  $h(y) = \min\{f_x(y) + 1, 2\}$  and  $h(u) = f_x(u)$  whenever  $u \in V(H_x) \setminus \{y\}$ , is a TWRDF on  $H_x$  of weight  $\omega(h) \leq \gamma_{tr}(H) - 1$ , which is a contradiction. Hence,  $f(x) = 0$ . Now, if there exists a vertex  $y \in N(x) \cap V(H_x) \cap (V_1 \cup V_2)$ , then from  $f_x$  we may define a TWRDF  $f'$  on  $H_x$  with the only difference that  $f'(y) = 2$ , having weight at most  $\gamma_{tr}(H) - 1$ , which is a contradiction again. Therefore,  $N(x) \cap V(H_x) \subseteq V_0$ .  $\square$

**Lemma 2.** Let  $H$  be a graph with no isolated vertex. For any  $v \in V(H) \setminus S(H)$ ,

$$\gamma_{tr}(H - \{v\}) \geq \gamma_{tr}(H) - 2.$$

Furthermore, if  $\gamma_{tr}(H - \{v\}) = \gamma_{tr}(H) - 2$ , then the following statements hold.

- (i)  $f(N(v)) = 0$  for every  $\gamma_{tr}(H - \{v\})$ -function  $f$ .
- (ii) There exists a  $\gamma_{tr}(H)$ -function  $h_0$  such that  $h_0(v) = 0$ .
- (iii) There exists a  $\gamma_{tr}(H)$ -function  $h_1$  such that  $h_1(v) = 1$ .

**Proof.** Let  $f$  be a  $\gamma_{tr}(H - \{v\})$ -function and suppose that  $\omega(f) \leq \gamma_{tr}(H) - 3$ . Let  $y \in N(v)$ . Observe that the function  $g$ , defined by  $g(y) = \min\{f(y) + 1, 2\}$ ,  $g(v) = 1$  and  $g(u) = f(u)$  whenever  $u \in V(H) \setminus \{v, y\}$ , is a TWRDF on  $H$  of weight  $\omega(g) \leq \gamma_{tr}(H) - 1$ , which is a contradiction. Hence,  $\omega(f) \geq \gamma_{tr}(H) - 2$ .

Now, assume that  $\omega(f) = \gamma_{tr}(H) - 2$ . If there exists a vertex  $y \in N(v)$  such that  $f(y) > 0$ , then the function  $f'$ , defined by  $f'(v) = 0$ ,  $f'(y) = 2$  and  $f'(u) = f(u)$  whenever  $u \in V(H) \setminus \{v, y\}$ , is a TWRDF on  $H$  of weight at most  $\gamma_{tr}(H) - 1$ , which is a contradiction again. Therefore,  $f(N(v)) = 0$ .

Furthermore, for any  $y \in N(v)$ , the function  $h_0$ , defined by  $h_0(v) = 0$ ,  $h_0(y) = 2$  and  $h_0(u) = f(u)$  whenever  $u \in V(H) \setminus \{v, y\}$ , is a  $\gamma_{tr}(H)$ -function. Analogously, the function  $h_1$ , defined by  $h_1(v) = 1$ ,  $h_1(y) = 1$  and  $h_1(u) = f(u)$  whenever  $u \in V(H) \setminus \{v, y\}$ , is a  $\gamma_{tr}(H)$ -function as well. Therefore, the result follows.  $\square$

**Corollary 7.** Let  $H$  be a graph with no isolated vertex and  $v \in V(H) \setminus S(H)$ . Then the following statements hold.

- If  $g(v) = 0$  for every  $\gamma_{tr}(H)$ -function  $g$ , then  $\gamma_{tr}(H - \{v\}) \in \{\gamma_{tr}(H), \gamma_{tr}(H) - 1\}$ .
- If  $h(v) > 0$  for every  $\gamma_{tr}(H)$ -function  $h$ , then  $\gamma_{tr}(H - \{v\}) \geq \gamma_{tr}(H) - 1$ .

From Lemma 1 we deduce that any  $\gamma_{tr}(G \circ_v H)$ -function  $f$  induces a partition  $\{\mathcal{A}_f, \mathcal{B}_f, \mathcal{C}_f\}$  of  $V(G)$  as follows.

$$\begin{aligned} \mathcal{A}_f &= \{x \in V(G) : \omega(f_x) \geq \gamma_{tr}(H)\}, \\ \mathcal{B}_f &= \{x \in V(G) : \omega(f_x) = \gamma_{tr}(H) - 1\}, \\ \mathcal{C}_f &= \{x \in V(G) : \omega(f_x) = \gamma_{tr}(H) - 2\}. \end{aligned}$$

**Proposition 3.** Let  $f$  be a  $\gamma_{tr}(G \circ_v H)$ -function. If  $\mathcal{C}_f \neq \emptyset$ , then  $\gamma_{tr}(H - \{v\}) = \gamma_{tr}(H) - 2$ .

**Proof.** By Lemma 1, if  $x \in \mathcal{C}_f$ , then  $f(x) = 0$  and  $f(y) = 0$  for every  $y \in N(x) \cap V(H_x)$ , which implies that  $f_x^-$  is a TWRDF on  $H_x - \{x\}$  of weight  $w(f_x^-) = \gamma_{tr}(H) - 2$ . Hence,  $\gamma_{tr}(H - \{v\}) = \gamma_{tr}(H_x - \{x\}) \leq \gamma_{tr}(H) - 2$ , and by Lemma 2 we conclude the proof.  $\square$

We will show through Theorem 23 that if  $\gamma_{tr}(G) < n$ , then the converse of Proposition 3 holds. An example of graphs where it does not hold is the case of  $G \cong K_2$  and  $H \cong P_3 \odot N_1$ , where  $v$  is a leaf adjacent to a support vertex of degree two.

By Lemma 1 and Proposition 3 we deduce the following result.

**Theorem 22.** Let  $G$  and  $H$  be two graphs with isolated vertex and let  $v \in V(H)$ . If  $\gamma_{tr}(H - \{v\}) \geq \gamma_{tr}(H) - 1$ , then  $\gamma_{tr}(G \circ_v H) \geq n(\gamma_{tr}(H) - 1)$ .

The inequality above is achieved, for instance, for any graph  $G$  with no isolated vertex and  $H \cong C_5$ .

It is readily seen that from any  $\gamma_{tr}(G)$ -function and any  $\gamma_{tr}(H - \{v\})$ -function we can construct a TWRDF on  $G \circ_v H$  of weight  $\gamma_{tr}(G) + n(\gamma_{tr}(H - \{v\}))$ . Therefore, we can state the following useful result.

**Proposition 4.** Let  $G$  and  $H$  be two graphs with no isolated vertex. If  $G$  has order  $n$  and  $v \in V(H) \setminus S(H)$ , then

$$\gamma_{tr}(G \circ_v H) \leq \gamma_{tr}(G) + n\gamma_{tr}(H - \{v\}).$$

**Theorem 23.** Let  $G$  and  $H$  be two graphs with no isolated vertex and let  $v \in V(H)$ . If  $\gamma_{tr}(G) < n$ , then the following statements are equivalent.

- (a)  $\mathcal{C}_f \neq \emptyset$  for any  $\gamma_{tr}(G \circ_v H)$ -function  $f$ .
- (b)  $\gamma_{tr}(H - \{v\}) = \gamma_{tr}(H) - 2$ .

**Proof.** Let  $f$  be a  $\gamma_{tr}(G \circ_v H)$ -function such that  $x \in \mathcal{C}_f$ . By Proposition 3,  $\gamma_{tr}(H - \{v\}) = \gamma_{tr}(H) - 2$ .

Conversely, assume that  $\gamma_{tr}(H - \{v\}) = \gamma_{tr}(H) - 2$  and suppose that  $\mathcal{C}_f = \emptyset$  for some  $\gamma_{tr}(G \circ_v H)$ -function  $f$ . By Lemma 1 and Proposition 4 we deduce that  $n(\gamma_{tr}(H) - 1) \leq \gamma_{tr}(G \circ_v H) \leq \gamma_{tr}(G) + n(\gamma_{tr}(H) - 2)$ , which is a contradiction whenever  $\gamma_{tr}(G) < n$ . Therefore, the result follows.  $\square$

The following result states the intervals in which the total weak Roman domination number of a rooted product graph can be found.

**Theorem 24.** Let  $G$  and  $H$  be two graphs with no isolated vertex. If  $G$  has order  $n$  and  $v \in V(H)$ , then one of the following statements holds.

- (i)  $\gamma_{tr}(G \circ_v H) = n\gamma_{tr}(H)$ .
- (ii)  $n(\gamma_{tr}(H) - 1) \leq \gamma_{tr}(G \circ_v H) \leq \gamma_{tr}(G) + n(\gamma_{tr}(H) - 1)$ .
- (iii)  $2\gamma(G) + n(\gamma_{tr}(H) - 2) \leq \gamma_{tr}(G \circ_v H) \leq \gamma_{tr}(G) + n(\gamma_{tr}(H) - 2)$ .
- (iv)  $\gamma_{tr}(G) + n(\gamma_{tr}(H) - 2) \leq \gamma_{tr}(G \circ_v H) \leq \gamma_{tr}(G) + n(\gamma_{tr}(H) - 2)$ .

**Proof.** Let  $f(V_0, V_1, V_2)$  be a  $\gamma_{tr}(G \circ_v H)$ -function and consider the partition  $\{\mathcal{A}_f, \mathcal{B}_f, \mathcal{C}_f\}$  of  $V(G)$  defined above. We differentiate the following four cases.

Case 1.  $\mathcal{B}_f \cup \mathcal{C}_f = \emptyset$ . In this case, for any  $x \in V(G)$  we have that  $\omega(f_x) \geq \gamma_{tr}(H)$  and, as a consequence,  $\gamma_{tr}(G \circ_v H) \geq n\gamma_{tr}(H)$ . On the other hand, we can extend any  $\gamma_{tr}(H)$ -function to a TWRDF on  $G \circ_v H$  of weight  $n\gamma_{tr}(H)$ . Therefore, (i) follows.

Case 2.  $\mathcal{B}_f \neq \emptyset$  and  $\mathcal{C}_f = \emptyset$ . In this case, for any  $x \in V(G)$  we have that  $\omega(f_x) \geq \gamma_{tr}(H) - 1$  and, as a result,  $\gamma_{tr}(G \circ_v H) \geq n(\gamma_{tr}(H) - 1)$ .

We now proceed to show that  $\gamma_{tr}(G \circ_v H) \leq \gamma_{tr}(G) + n(\gamma_{tr}(H) - 1)$ . From  $f$ , some vertex  $x' \in \mathcal{B}_f$  and any  $\gamma_{tr}(G)$ -function  $h$ , we define a function  $g$  on  $G \circ_v H$  as follows. For every  $x \in V(G)$ , the restriction of  $g$  to  $V(H_x) \setminus \{x\}$  is induced by  $f_{x'}$  and we set  $g(x) = \min\{f(x) + h(x), 2\}$ . It is readily seen that  $g$  is a TWRDF on  $G \circ_v H$  of weight at most  $\gamma_{tr}(G) + n(\gamma_{tr}(H) - 1)$ , concluding that  $\gamma_{tr}(G \circ_v H) \leq \gamma_{tr}(G) + n(\gamma_{tr}(H) - 1)$ .

Case 3.  $\mathcal{B}_f = \emptyset$  and  $\mathcal{C}_f \neq \emptyset$ . From Lemma 1 we deduce that  $\mathcal{A}_f$  is a dominating set of  $G$ . Therefore,  $\gamma_{tr}(G \circ_v H) \geq 2|\mathcal{A}_f| + n(\gamma_{tr}(H) - 2) \geq 2\gamma(G) + n(\gamma_{tr}(H) - 2)$ .

On the other hand, by Proposition 3,  $\gamma_{tr}(H - \{v\}) = \gamma_{tr}(H) - 2$ , and by Proposition 4 we conclude that  $\gamma_{tr}(G \circ_v H) \leq \gamma_{tr}(G) + n(\gamma_{tr}(H) - 2)$ .

Case 4.  $\mathcal{C}_f \neq \emptyset$ . By Propositions 3 and 4 we conclude that  $\gamma_{tr}(G \circ_v H) \leq \gamma_{tr}(G) + n(\gamma_{tr}(H) - 2)$ .

In order to conclude the proof of (iv), let us define a function  $g$  on  $G$  as follows. If  $x \in \mathcal{A}_f$  then we set  $g(x) = 1$  and choose one vertex  $u \in N(x) \cap V(G)$  and label it as  $g(u) = 1$ . For the another vertices not previously labelled, if  $x \in \mathcal{B}_f$  then we set  $g(x) = 1$ , and if  $x \in \mathcal{C}_f$  then we set  $g(x) = 0$ . We will prove that  $g$  is a TDF on  $G$ . Notice that by construction of  $g$ , if  $x \in \mathcal{A}_f$  then  $x$  is dominated by some vertex  $y \in V(G)$  such that  $g(y) = 1$ . Now, by Lemma 1, if  $x \in \mathcal{C}_f$  then  $x$  is totally protected under  $f$  by a vertex  $w \in V(G)$ . Furthermore, since  $f(w) > 0$ , we have that  $g(w) = 1$ , as required. If  $x \in \mathcal{B}_f$ , then it must be adjacent to some vertex  $z \in V(G)$  such that  $f(z) > 0$ , otherwise  $f_x$  is a TWRDF on  $H_x$  and  $\omega(f_x) = \gamma_{tr}(H) - 1$ , which is a contradiction. Hence,  $g(z) = 1$ , as required. Therefore,  $g$  is a TDF on  $G$  and, as a consequence,

$$\begin{aligned} \gamma_{tr}(G \circ_v H) &= \sum_{x \in V(G)} \omega(f_x) \\ &= \sum_{x \in \mathcal{A}_f} \omega(f_x) + \sum_{x \in \mathcal{B}_f} \omega(f_x) + \sum_{x \in \mathcal{C}_f} \omega(f_x) \\ &\geq \sum_{x \in \mathcal{A}_f} (\gamma_{tr}(H) - 2 + g(x)) + \sum_{x \in \mathcal{B}_f} (\gamma_{tr}(H) - 2 + g(x)) + \sum_{x \in \mathcal{C}_f} (\gamma_{tr}(H) - 2 + g(x)) \\ &\geq \sum_{x \in V(G)} g(x) + \sum_{x \in V(G)} (\gamma_{tr}(H) - 2) \\ &= \omega(g) + n(\gamma_{tr}(H) - 2) \\ &\geq \gamma_{tr}(G) + n(\gamma_{tr}(H) - 2). \end{aligned}$$

Therefore, (iv) follows.  $\square$

We now consider some particular cases in which we impose some additional restrictions on  $G$  and  $H$ . To begin with, we consider the case in which  $v$  is a support vertex of  $H$ .

**Theorem 25.** *Let  $G$  and  $H$  be two graphs with no isolated vertex. If  $G$  has order  $n$  and  $v \in S(H)$ , then*

$$\gamma_{tr}(G \circ_v H) \in \{n(\gamma_{tr}(H) - 1), n\gamma_{tr}(H)\}.$$

Furthermore, if  $v \in S(H) \cap N(S(H))$ , then

$$\gamma_{tr}(G \circ_v H) = n\gamma_{tr}(H).$$

**Proof.** Let  $f$  be a  $\gamma_{tr}(G \circ_v H)$ -function and  $x \in V(G)$ . Since  $x \in S(G \circ_v H)$ , we have that  $f(x) > 0$ , so that Lemma 1 leads to  $\mathcal{C}_f = \emptyset$ , and, again by Lemma 1,  $\omega(f_x) \geq \gamma_{tr}(H) - 1$ . Hence,  $\gamma_{tr}(G \circ_v H) \geq n(\gamma_{tr}(H) - 1)$ .

If  $\mathcal{B}_f = \emptyset$ , then by Case 1 of the proof of Theorem 24,  $\gamma_{tr}(G \circ_v H) = n\gamma_{tr}(H)$ . Now, suppose that  $x \in \mathcal{B}_f$ . From  $f$ , we define a function  $h$  on  $G \circ_v H$  as follows. For every  $z \in V(G)$ , the restriction of  $h$  to  $V(H_z)$  is induced from  $f_x$ . It is readily seen that  $h$  is a TWRDF on  $G \circ_v H$  of weight  $n(\gamma_{tr}(H) - 1)$ , which implies that  $\gamma_{tr}(G \circ_v H) = n(\gamma_{tr}(H) - 1)$ .

From now on, suppose that  $v \in S(H) \cap N(S(H))$  and let  $u \in N(x) \cap S(H_x)$  for some  $x \in V(G)$ . To conclude the proof we only need to show that  $\gamma_{tr}(G \circ_v H) \geq n\gamma_{tr}(H)$ . We can assume that  $f(V_0, V_1, V_2)$  is a  $\gamma_{tr}(G \circ_v H)$ -function satisfying that  $|V_2|$  is maximum. As  $x$  and  $u$  are adjacent, and they are support vertices,  $f(x) = f(u) = 2$ , so that  $f_x$  is a TWRDF on  $H_x$  and, as a consequence,  $\omega(f_x) \geq \gamma_{tr}(H)$ . Therefore,  $\gamma_{tr}(G \circ_v H) \geq n\gamma_{tr}(H)$ , as required.  $\square$

We now proceed to discuss some cases in which  $v$  is not a support vertex of  $H$ .

**Theorem 26.** If  $\gamma_{tr}(H - \{v\}) = \gamma_{tr}(H) - 2$  and  $\gamma_{tr}(G) = \gamma_t(G)$ , then

$$\gamma_{tr}(G \circ_v H) = 2 + n(\gamma_{tr}(H) - 2).$$

**Proof.** By Theorem 24, we have that  $\gamma_{tr}(G \circ_v H) \geq \gamma_t(G) + n(\gamma_{tr}(H) - 2)$ . Now, if  $\gamma_{tr}(G) = \gamma_t(G)$ , then Theorem 20 leads to  $\gamma_{tr}(G) = 2$ , and so  $\gamma_{tr}(G \circ_v H) \geq 2 + n(\gamma_{tr}(H) - 2)$ .

On the other hand, if  $\gamma_{tr}(H - \{v\}) = \gamma_{tr}(H) - 2$ , then from Proposition 4 we conclude that  $\gamma_{tr}(G \circ_v H) \leq 2 + n(\gamma_{tr}(H) - 2)$ .  $\square$

Notice that in Theorem 26 we have the hypothesis  $\gamma_{tr}(H - \{v\}) = \gamma_{tr}(H) - 2$  and the conclusion  $\gamma_{tr}(G \circ_v H) = \gamma_{tr}(G) + n(\gamma_{tr}(H) - 2)$ . On the other hand, we would emphasize that in all the examples in which we have observed that the left hand side inequalities of Theorem 24 (iii) or (iv) are achieved, we have that  $\gamma_{tr}(G) = 2\gamma(G)$  or  $\gamma_{tr}(G) = \gamma_t(G)$ , respectively. Hence, in these cases,  $\gamma_{tr}(G \circ_v H) = \gamma_{tr}(G) + n(\gamma_{tr}(H) - 2)$ . After numerous attempts, we have not been able to prove the following conjecture.

**Conjecture.** Let  $G$  and  $H$  be two graphs with no isolated vertex. For any  $v \in V(H)$ ,

$$\gamma_{tr}(G \circ_v H) \geq \gamma_{tr}(G) + n(\gamma_{tr}(H) - 2),$$

where  $n$  is the order of  $G$ . Furthermore,  $\gamma_{tr}(G \circ_v H) = \gamma_{tr}(G) + n(\gamma_{tr}(H) - 2)$  if and only if  $\gamma_{tr}(H - \{v\}) = \gamma_{tr}(H) - 2$ .

In order to study the computational complexity of the problem of computing the total weak Roman domination number of a graph, we need to state the following result.

**Theorem 27.** Let  $G$  and  $H$  be two graphs with no isolated vertex. Let  $n$  be the order of  $G$  and  $v, u \in V(H)$  such that  $u \in L(H) \setminus \{v\}$  and  $N(v) \cap N(u) \neq \emptyset$ . If  $\gamma_{tr}(H - \{v\}) = \gamma_{tr}(H) - 1$ , then

$$\gamma_{tr}(G \circ_v H) = \gamma(G) + n(\gamma_{tr}(H) - 1),$$

otherwise

$$\gamma_{tr}(G \circ_v H) = n\gamma_{tr}(H).$$

**Proof.** If  $v \in S(H)$ , then Theorem 25 leads to  $\gamma_{tr}(G \circ_v H) = n\gamma_{tr}(H)$ . Hence, from now on we assume that  $v \notin S(H)$ . Let  $y \in N(v) \cap N(u)$ . Since  $u$  is a leaf in  $H - \{v\}$  and  $y$  its support vertex, for any  $\gamma_{tr}(H - \{v\})$ -function  $g$  we have that  $g(y) > 0$ . Hence, if  $\gamma_{tr}(H - \{v\}) = \gamma_{tr}(H) - 2$ , then from any  $\gamma_{tr}(H - \{v\})$ -function we can construct a TWRDF on  $H$  of weight at most  $\gamma_{tr}(H) - 1$  by assigning weight 1 to  $v$ , which is a contradiction. Hence,  $\gamma_{tr}(H - \{v\}) \geq \gamma_{tr}(H) - 1$ .

Let  $f(V_0, V_1, V_2)$  be a  $\gamma_{tr}(G \circ_v H)$ -function and consider the partition  $\{\mathcal{A}_f, \mathcal{B}_f, \mathcal{C}_f\}$  of  $V(G)$  defined previously. Notice that, for any  $x \in V(G)$  there exist  $u_x \in L(H_x) \setminus \{x\}$  and  $y_x \in N(x) \cap N(u_x)$ . With these tools in mind, we now proceed to study the structure of  $\mathcal{A}_f, \mathcal{B}_f$  and  $\mathcal{C}_f$ . Since  $u_x$  is a leaf of  $G \circ_v H$  and  $y_x$  its support vertex, we have that  $f(y_x) > 0$ , and since  $y_x \in N(x)$ , Lemma 1 leads to  $\mathcal{C}_f = \emptyset$ . We now differentiate two cases.

Case 1.  $\gamma_{tr}(H - \{v\}) = \gamma_{tr}(H) - 1$ . Suppose that there exists  $x \in \mathcal{B}_f$  with  $f(x) > 0$ . Since  $y_x$  is a support vertex, either  $f(y_x) = 2$  or  $f(y_x) = 1$  and no vertex in  $V(H_x)$  is totally protected by  $y_x$  under  $f$ . In any case, we can conclude that  $f_x$  is a TWRDF on  $H_x$  of weight  $\omega(f_x) = \gamma_{tr}(H) - 1$ , which is a contradiction. Hence,  $\mathcal{B}_f \subseteq V_0$ .



Now, since  $(V_1 \cup V_2) \cap V(G) \subseteq \mathcal{A}_f$ , if there exists  $x \in \mathcal{B}_f$  such that  $N(x) \cap \mathcal{A}_f = \emptyset$ , then  $f_x$  must be a TWRDF on  $H_x$ , which is a contradiction, as  $\omega(f_x) = \gamma_{tr}(H) - 1$ . Thus,  $\mathcal{A}_f$  is a dominating set and so,

$$\begin{aligned} \gamma_{tr}(G \circ_v H) &= \sum_{x \in \mathcal{A}_f \cup \mathcal{B}_f} \omega(f_x) \\ &\geq |\mathcal{A}_f| \gamma_{tr}(H) + |\mathcal{B}_f| (\gamma_{tr}(H) - 1) \\ &= |\mathcal{A}_f| + n(\gamma_{tr}(H) - 1) \\ &\geq \gamma(G) + n(\gamma_{tr}(H) - 1). \end{aligned}$$

On the other hand, since  $v$  is adjacent to a support vertex, from any  $\gamma_{tr}(H - \{v\})$ -function and any  $\gamma(G)$ -function we can construct a TWRDF on  $G \circ_v H$  of weight  $\gamma(G) + n(\gamma_{tr}(H) - 1)$ . Therefore,  $\gamma_{tr}(G \circ_v H) = \gamma(G) + n(\gamma_{tr}(H) - 1)$ .

Case 2.  $\gamma_{tr}(H - \{v\}) \geq \gamma_{tr}(H)$ . If there exists  $x \in \mathcal{B}_f$  with  $f(x) > 0$ , then  $f_x$  is a TWRDF on  $H_x$  of weight  $\omega(f_x) = \gamma_{tr}(H) - 1$ , which is a contradiction. Now, if  $x \in \mathcal{B}_f$  and  $f(x) = 0$ , then  $f_x^-$  is a TWRDF on  $H_x - \{x\}$  of weight  $\omega(f_x^-) = \gamma_{tr}(H) - 1$ , which is a contradiction again. Hence,  $x \in \mathcal{A}_f$ , and so  $\gamma_{tr}(G \circ_v H) \geq n\gamma_{tr}(H)$ . Therefore, by Theorem 24 we conclude that  $\gamma_{tr}(G \circ_v H) = n\gamma_{tr}(H)$ .  $\square$

Recent works have shown that graph operations are useful tools to study problems of computational complexity.

For instance, the authors of [18,19] have shown that results on the (local) metric dimension of corona product graphs enables us to deduce NP-hardness results for the (local) adjacency dimension; while the authors of [20] have shown that the study of lexicographic product graphs is useful to infer an NP-hardness result for the super domination number, based on a well-known result for the independence number. Our next result shows that we can use rooted product graphs to study the problem of finding the total weak Roman domination number of a graph. In this case, the key result is Theorem 27 which involves the domination number. It is well known that the dominating set problem is an NP-complete decision problem [21], i.e., given a positive integer  $k$  and a graph  $G$ , the problem of deciding if  $G$  has a dominating set  $D$  of cardinality  $|D| \leq k$  is NP-complete. Hence, the optimization problem of computing the domination number of a graph is NP-hard.

**Corollary 8.** *The problem of computing the total weak Roman domination number of a graph is NP-hard.*

**Proof.** Let  $G$  be a graph with no isolated vertex and construct the graph  $G \circ_v P_3$ , where  $v$  is a leaf of  $P_3$ . By Theorem 27, it follows that  $\gamma_{tr}(G \circ_v P_3) = \gamma(G) + 2|V(G)|$ . Therefore, the problem of computing the total weak Roman domination has the same computational complexity as the domination number problem.  $\square$

**Theorem 28.** *Let  $G$  and  $H$  be two graphs with no isolated vertex and  $|V(G)| = n$ . Then the following statements hold for every  $v \in V(H)$  such that  $\gamma_{tr}(H - \{v\}) \neq \gamma_{tr}(H) - 1$ .*

- (i) *If  $g(v) = 0$  for every  $\gamma_{tr}(H)$ -function  $g$ , then  $\gamma_{tr}(G \circ_v H) = n\gamma_{tr}(H)$ .*
- (ii) *If  $g(v) > 0$  for every  $\gamma_{tr}(H)$ -function  $g$ , then  $\gamma_{tr}(G \circ_v H) \in \{n\gamma_{tr}(H), n(\gamma_{tr}(H) - 1)\}$ .*

**Proof.** Let  $f(V_0, V_1, V_2)$  be a  $\gamma_{tr}(G \circ_v H)$ -function and consider the partition  $\{\mathcal{A}_f, \mathcal{B}_f, \mathcal{C}_f\}$  of  $V(G)$  previously defined.

With the assumptions of (i) or (ii), Lemma 2 and Proposition 3 lead to  $\mathcal{C}_f = \emptyset$ . Moreover, if  $\mathcal{B}_f = \emptyset$ , then by analogy to Case 1 in the proof of Theorem 24 we deduce that  $\gamma_{tr}(G \circ_v H) = n\gamma_{tr}(H)$ . From now on suppose that  $x \in \mathcal{B}_f$ . If  $f(x) = 0$ , then  $f_x^-$  is a TWRDF on  $H_x - \{x\}$ , so that  $\gamma_{tr}(H - \{v\}) = \gamma_{tr}(H_x - \{x\}) \leq \omega(f_x^-) = \omega(f_x) = \gamma_{tr}(H) - 1$ . From the hypothesis of (i) and (ii)

and Lemma 2 we deduce that  $\gamma_{tr}(H - \{v\}) = \gamma_{tr}(H) - 1$ . Thus, if  $\gamma_{tr}(H - \{v\}) \neq \gamma_{tr}(H) - 1$ , then  $f(x) > 0$ .

We now assume the hypothesis of (i) and take a vertex  $u \in N(x) \cap V(H_x)$ . If  $f(u) = 2$ , then  $f_x$  is a TWRDF on  $H_x$  of weight  $\omega(f_x) = \gamma_{tr}(H) - 1$ , which is a contradiction. Hence,  $f(u) \leq 1$  and we can define a function  $g$  as  $g(u) = f(u) + 1$  and  $g(w) = f(w)$  for every  $w \in V(H_x) \setminus \{u\}$ . Notice that  $g$  is a TWRDF on  $H_x$  of weight  $\gamma_{tr}(H)$ , so  $g$  is a  $\gamma_{tr}(H)$ -function and satisfies that  $g(v) > 0$ , which is a contradiction. Hence,  $\mathcal{B}_f = \emptyset$  and we are done.

We now assume the hypothesis of (ii). By analogy to Case 2 in the proof of Theorem 24 we deduce that  $\gamma_{tr}(G \circ_v H) \geq n(\gamma_{tr}(H) - 1)$ . Now, we proceed to show that  $\gamma_{tr}(G \circ_v H) \leq n(\gamma_{tr}(H) - 1)$ . From  $f$ , we define a function  $h$  on  $G \circ_v H$  as follows. For every  $z \in V(G)$ , the restriction of  $h$  to  $V(H_z)$  is induced from  $f_x$ . It is readily seen that  $h$  is a TWRDF on  $G \circ_v H$  of weight  $n(\gamma_{tr}(H) - 1)$ , which completes the proof.  $\square$

As a particular case of Theorem 28 (i) we have the following result.

**Corollary 9.** *Let  $G$  and  $H$  be two graphs with no isolated vertex. Let  $n$  be the order of  $G$ ,  $v \in L(H)$  and  $u, u' \in S(H)$ . If  $u', v \in N(u)$  and  $|N(u) \cap L(H)| \geq 3$ , then  $\gamma_{tr}(G \circ_v H) = n\gamma_{tr}(H)$ .*

**Theorem 29.** *If  $G$  is a graph of order  $n$  with  $\delta(G) \geq 1$ , then for every graph  $H$  having a universal vertex  $v \in V(H)$ ,*

$$\gamma_{tr}(G \circ_v H) = 2n.$$

**Proof.** The upper bound  $\gamma_{tr}(G \circ_v H) \leq 2n$  is straightforward, as the function  $f$ , defined by  $f(x) = 2$  for every vertex  $x \in V(G)$  and  $f(x) = 0$  for every  $x \in V(G \circ_v H) \setminus V(G)$ , is a TWRDF on  $G \circ_v H$ .

On the other hand, let  $f$  be a  $\gamma_{tr}(G \circ_v H)$ -function and suppose that there exists  $x \in V(G)$  such that  $\omega(f_x) \leq 1$ . In such a case,  $f(N[y]) \leq 1$  for every  $y \in V(H_x) \setminus \{x\}$ , which is a contradiction. Therefore  $\gamma_{tr}(G \circ_v H) = \omega(f) \geq 2n$ .  $\square$

Since any corona graph  $G \odot G'$  is a rooted product graph  $G \circ_v H$  where  $H \cong K_1 + G'$  and  $v$  is the vertex of  $K_1$ , the result above is equivalent to the following theorem.

**Theorem 30.** *If  $G$  is a graph of order  $n$  with no isolated vertex, then for every graph  $G'$ ,*

$$\gamma_{tr}(G \odot G') = 2n.$$

To conclude the analysis, we consider the extreme case in which  $\gamma_{tr}(H) = 2$ .

**Theorem 31.** *If  $G$  is a graph of order  $n$  and  $H$  is a graph with  $\gamma_{tr}(H) = 2$ , then for any  $v \in V(H)$ ,*

$$\gamma_{tr}(G \circ_v H) = 2n.$$

**Proof.** By Theorem 24,  $\gamma_{tr}(G \circ_v H) \leq 2n$ . Now, if  $\gamma_{tr}(G \circ_v H) \leq 2n - 1$ , then for any  $\gamma_{tr}(G \circ_v H)$ -function  $f$ , there exists  $x \in V(G)$  such that  $\omega(f_x) \leq 1$ . Hence,  $f(N[y]) \leq 1$  for every  $y \in V(H_x) \setminus \{x\}$ , which is a contradiction.  $\square$

## 6. Conclusions and Open Problems

This article is a contribution to the theory of total protection of graphs. In particular, we introduced the study of the total weak Roman domination number of a graph. We studied the properties of this novel parameter in order to obtain its exact value or general bounds. Among the main contributions we emphasize the following.

- The work proved several new theorems, thanks to which we have shown the close relationship that exists between the total weak Roman domination number and other domination parameters such

as the (total) domination number, secure (total) domination number, weak Roman domination number, (total) Roman domination number and 2-packing number.

- We obtained general bounds and discussed some extreme cases.
- In a specific section of the paper, we focused on the case of rooted product graphs and we obtained closed formulas and tight bounds for the total weak Roman domination number of these graphs.
- Through the results obtained on rooted product graphs, we have shown that the problem of finding the total weak Roman domination number of a graph is NP-hard.

Among the open problems arising from the analysis, the following should be highlighted.

- (a) We have shown that if  $G$  is a  $\{K_{1,3}, K_{1,3} + e\}$ -free graph with no isolated vertex, then  $\gamma_{tr}(G) = \gamma_{st}(G)$ . We conjecture that these two parameters also coincide for lexicographic product graphs, and we propose the general problem of characterizing all graphs for which the equality holds.
- (b) We have shown that  $\gamma_{tr}(G) = \gamma(G) + 1$  if and only if  $\gamma_{st}(G) = \gamma(G) + 1$ . Therefore, the problem of characterizing all graphs with  $\gamma_{st}(G) = \gamma(G) + 1$  is an open problem, which is a particular case of problem (a).
- (c) We have shown that  $\gamma_{tr}(G) \leq \gamma_t(G) + \gamma(G)$  and  $\gamma_{tr}(G) \leq \gamma_r(G) + \gamma(G)$ . We propose the problem of characterizing all graphs for which these equalities hold; or providing necessary or sufficient conditions for achieving them.
- (d) Since the problem of finding  $\gamma_{tr}(G)$  is NP-hard, we consider the following question. Is there a polynomial-time algorithm for finding  $\gamma_{tr}(T)$  for any tree  $T$  of order  $n$ ?

**Author Contributions:** The results presented in this paper were obtained as a result of collective work sessions involving all authors. The process was organized and led by J.A.R.-V.

**Funding:** This work has been partially supported by the Spanish Ministry of Economy, Industry and Competitiveness, under the grants MTM2016-78227-C2-1-P and MTM2017-90584-REDT, and by the Mexican National Council on Science and Technology (Cátedras-CONACYT).

**Conflicts of Interest:** The authors declare no conflict of interest.

## References

1. Cockayne, E.J.; Grobler, P.J.P.; Gründlingh, W.R.; Munganga, J.; van Vuuren, J.H. Protection of a graph. *Util. Math.* **2005**, *67*, 19–32.
2. Stewart, I. Defend the Roman Empire! *Sci. Am.* **1999**, *281*, 136–138. [[CrossRef](#)]
3. Cockayne, E.J.; Dreyer, P.A., Jr.; Hedetniemi, S.M.; Hedetniemi, S.T. Roman domination in graphs. *Discret. Math.* **2004**, *278*, 11–22. [[CrossRef](#)]
4. Liu, C.-H.; Chang, G.J. Roman domination on strongly chordal graphs. *J. Comb. Optim.* **2013**, *26*, 608–619. [[CrossRef](#)]
5. Abdollahzadeh Ahangar, H.; Henning, M.A.; Samodivkin, V.; Yero, I.G. Total roman domination in graphs. *Appl. Anal. Discret. Math.* **2016**, *10*, 501–517. [[CrossRef](#)]
6. Henning, M.A.; Hedetniemi, S.T. Defending the Roman Empire—A new strategy. *Discret. Math.* **2003**, *266*, 239–251. [[CrossRef](#)]
7. Chellali, M.; Haynes, T.W.; Hedetniemi, S.T. Bounds on weak roman and 2-rainbow domination numbers. *Discret. Appl. Math.* **2014**, *178*, 27–32. [[CrossRef](#)]
8. Cockayne, E.J.; Favaron, O.; Mynhardt, C.M. Secure domination, weak Roman domination and forbidden subgraphs. *Bull. Inst. Combin. Appl.* **2003**, *39*, 87–100.
9. Valveny, M.; Pérez-Rosés, H.; Rodríguez-Velázquez, J.A. On the weak Roman domination number of lexicographic product graphs. *Discret. Appl. Math.* **2019**, *263*, 257–270. [[CrossRef](#)]
10. Valveny, M.; Rodríguez-Velázquez, J.A. Protection of graphs with emphasis on cartesian product graphs. *Filomat* **2019**, *33*, 319–333.
11. Boumediene Merouane, H.; Chellali, M. On secure domination in graphs. *Inform. Process. Lett.* **2015**, *115*, 786–790. [[CrossRef](#)]

12. Burger, A.P.; Henning, M.A.; van Vuuren, J.H. Vertex covers and secure domination in graphs. *Quaest. Math.* **2008**, *31*, 163–171. [[CrossRef](#)]
13. Klostermeyer, W.F.; Mynhardt, C.M. Secure domination and secure total domination in graphs. *Discuss. Math. Graph Theory* **2008**, *28*, 267–284. [[CrossRef](#)]
14. Benecke, S.; Cockayne, E.J.; Mynhardt, C.M. Secure total domination in graphs. *Util. Math.* **2007**, *74*, 247–259.
15. Haynes, T.W.; Hedetniemi, S.T.; Slater, P.J. *Fundamentals of Domination in Graphs*; Chapman and Hall/CRC Pure and Applied Mathematics Series; Marcel Dekker, Inc.: New York, NY, USA, 1998.
16. Meir, A.; Moon, J.W. Relations between packing and covering numbers of a tree. *Pacific J. Math.* **1975**, *61*, 225–233. [[CrossRef](#)]
17. Goddard, W.; Henning, M.A. Domination in planar graphs with small diameter. *J. Graph Theory* **2002**, *40*, 1–25. [[CrossRef](#)]
18. Fernau, H.; Rodríguez Velázquez, J.A. On the (adjacency) metric dimension of corona and strong product graphs and their local variants: Combinatorial and computational results. *Discret. Appl. Math.* **2018**, *236*, 183–202. [[CrossRef](#)]
19. Fernau, H.; Rodríguez-Velázquez, J.A. *Notions of Metric Dimension of Corona Products: Combinatorial and Computational Results*; Springer International Publishing: Cham, Switzerland, 2014; pp. 153–166.
20. Dettlaff, M.; Lemańska, M.; Rodríguez-Velázquez, J.A.; Zuazua, R. On the super domination number of lexicographic product graphs. *Discret. Appl. Math.* **2019**, *263*, 118–129. [[CrossRef](#)]
21. Garey, M.R.; Johnson, D.S. *Computers and Intractability: A Guide to the Theory of NP-Completeness*; W. H. Freeman & Co.: New York, NY, USA, 1979.



© 2019 by the authors. Licensee MDPI, Basel, Switzerland. This article is an open access article distributed under the terms and conditions of the Creative Commons Attribution (CC BY) license (<http://creativecommons.org/licenses/by/4.0/>).

## Chapter 7

# On the secure total domination number of graphs

This chapter includes a complete copy of the following paper.

A. Cabrera Martínez, L.P. Montejano, J.A. Rodríguez-Velázquez. On the secure total domination number of graphs, *Symmetry* (2019) 11(9), 1165.

URL: <https://doi.org/10.3390/sym11091165>

Quality indicators:

2019 JCR Impact factor: 2.645, Q2 (29/71), Multidisciplinary, Sciences.



Article

# On the Secure Total Domination Number of Graphs

Abel Cabrera Martínez<sup>1</sup>, Luis P. Montejano<sup>2,\*</sup> and Juan A. Rodríguez-Velázquez<sup>1</sup> 

<sup>1</sup> Departament d'Enginyeria Informàtica i Matemàtiques, Universitat Rovira i Virgili, Av. Països Catalans 26, 43007 Tarragona, Spain; abel.cabrera@urv.cat (A.C.M.); juanalberto.rodriguez@urv.cat (J.A.R.-V.)

<sup>2</sup> Euncet University Business School, Universitat Politècnica de Catalunya, 08225 Terrassa, Spain

\* Correspondence: luis.pedro.montejano@euncet.es

Received: 14 August 2019; Accepted: 12 September 2019; Published: 15 September 2019

**Abstract:** A total dominating set  $D$  of a graph  $G$  is said to be a secure total dominating set if for every vertex  $u \in V(G) \setminus D$ , there exists a vertex  $v \in D$ , which is adjacent to  $u$ , such that  $(D \setminus \{v\}) \cup \{u\}$  is a total dominating set as well. The secure total domination number of  $G$  is the minimum cardinality among all secure total dominating sets of  $G$ . In this article, we obtain new relationships between the secure total domination number and other graph parameters: namely the independence number, the matching number and other domination parameters. Some of our results are tight bounds that improve some well-known results.

**Keywords:** secure total domination; secure domination; independence number; matching number; domination

**MSC:** 05C69; 05C70

## 1. Introduction

The following approach to the protection of a graph was proposed by Cockayne et al. [1]. Suppose that one or more entities are stationed at some of the vertices of a graph  $G$  and that an entity at a vertex can deal with a problem at any vertex in its closed neighbourhood. In general, an entity could consist of an observer, a robot, a guard, a legion, and so on. Informally, we say that  $G$  is protected under a given placement of entities if there exists at least one entity available to handle a problem at any vertex. The simplest cases of graph protection are those in which you can locate at most one entity per vertex. In such a case, the set of vertices containing the entities is said to be a dominating set.

In a graph  $G = (V(G), E(G))$ , a vertex dominates itself and its neighbours. A subset  $S \subseteq V(G)$  is said to be a *dominating set* of  $G$  if  $S$  dominates every vertex of  $G$ , while  $S$  is said to be a *total dominating set* if every vertex  $v \in V(G)$  is dominated by at least one vertex in  $S \setminus \{v\}$ . As usual, the neighbourhood of a vertex  $v \in V(G)$  will be denoted by  $N(v)$ . Now, a set  $S \subseteq V(G)$  is said to be a *secure (total) dominating set* if  $S$  is a (total) dominating set and for every  $v \in V(G) \setminus S$  there exists  $u \in N(v) \cap S$  such that  $(S \cup \{v\}) \setminus \{u\}$  is a (total) dominating set. In the case of secure (total) domination, the graph is deemed protected by a (total) dominating set and when an entity moves (to deal with a problem) to a neighbour not included in the (total) dominating set, the new set of entities obtained from the movement of the entity is a (total) dominating set which protects the graph as well.

The minimum cardinality among all dominating sets of  $G$  is the *domination number* of  $G$ , denoted by  $\gamma(G)$ . The *total domination number*, the *secure domination number* and the *secure total domination number* of  $G$  are defined by analogy, and are denoted by  $\gamma_t(G)$ ,  $\gamma_s(G)$  and  $\gamma_{st}(G)$ , respectively.

The domination number and the total domination number have been extensively studied. For instance, we cite the following books [2–4]. The secure domination number, which has been less studied, was introduced by Cockayne et al. in [1] and studied further in several works including [5–10], while the secure total domination number was introduced by Benecke et al. in [11] and studied further in [9,12–14].

In this work we study the relationships between the secure total domination number and other graph parameters. The article is organized as follows. In Section 2 we define key terms and additional notation. In Section 3 we show that  $\gamma_{st}(G) \leq \alpha(G) + \gamma(G)$ , where  $\alpha(G)$  denotes the independence number of  $G$ . Since  $\gamma(G) \leq \alpha(G)$ , this result improves the bound  $\gamma_{st}(G) \leq 2\alpha(G)$  obtained in [14]. Section 4 is devoted to the study of relationships between the secure total domination number and other domination parameters. In particular, we outline some known results that become tools to derive new ones. Finally, in Section 5 we obtain several bounds on the secure total domination number in terms of the matching number and other graph parameters.

## 2. Some Additional Concepts and Notation

All graphs considered in this paper are finite and undirected, without loops or multiple edges. The minimum degree of a graph  $G$  will be denoted by  $\delta(G)$  and the maximum degree by  $\Delta(G)$ . As usual, the *closed neighbourhood* of a vertex  $v \in V(G)$  is denoted by  $N[v] = N(v) \cup \{v\}$ . We say that a vertex  $v \in V(G)$  is a *universal vertex* of  $G$  if  $N[v] = V(G)$ . By analogy with the notation used for vertices, for a set  $S \subseteq V(G)$ , its *open neighbourhood* is the set  $N(S) = \cup_{v \in S} N(v)$ , and its *closed neighbourhood* is the set  $N[S] = N(S) \cup S$ . We also define the following sets associated with  $v \in V(G)$ .

- The *internal private neighbourhood* of  $v$  relative to  $S$  is defined by

$$ipn(v, S) = \{u \in S : N(u) \cap S = \{v\}\}.$$

- The *external private neighbourhood* of  $v$  relative to  $S$  is defined by

$$epn(v, S) = \{u \in V(G) \setminus S : N(u) \cap S = \{v\}\}.$$

- The *private neighbourhood* of  $v$  relative to  $S$  is defined by

$$pn(v, S) = ipn(v, S) \cup epn(v, S) = \{u \in V(G) : N(u) \cap S = \{v\}\}.$$

The subgraph induced by  $S \subseteq V(G)$  will be denoted by  $\langle S \rangle$ , while the graph obtained from  $G$  by removing all the vertices in  $S \subseteq V(G)$  (and all the edges incident with a vertex in  $S$ ) will be denoted by  $G - S$ . If  $H$  is a graph, then we say that a graph  $G$  is  $H$ -free if  $G$  does not contain any copy of  $H$  as an induced subgraph.

We denote the set of leaves of a graph  $G$  by  $L(G)$ , and the set of support vertices (vertices adjacent to leaves) by  $S(G)$ . The set of isolated vertices of  $\langle V(G) \setminus (S(G) \cup L(G)) \rangle$  will be denoted by  $I_G$ .

We will use the notation  $C_n$ ,  $N_n$  and  $P_n$  for cycle graphs, empty graphs and path graphs of order  $n$ , respectively.

Let  $f : V(G) \rightarrow \{0, 1, 2\}$  be a function. For any  $i \in \{0, 1, 2\}$  we define the subsets of vertices  $V_i = \{v \in V(G) : f(v) = i\}$  and we identify  $f$  with the three subsets of  $V(G)$  induced by  $f$ . Thus, in order to emphasize the notation of these sets, we denote the function by  $f(V_0, V_1, V_2)$ . Given a set  $X \subseteq V(G)$ , we define  $f(X) = \sum_{v \in X} f(v)$ , and the *weight* of  $f$  is defined to be  $\omega(f) = f(V(G)) = |V_1| + 2|V_2|$ .

A *(total) weak Roman dominating function* is a function  $f(V_0, V_1, V_2)$  satisfying that  $V_1 \cup V_2$  is (total) dominating set and for every vertex  $v \in V_0$  there exists  $u \in N(v) \cap (V_1 \cup V_2)$  such that the function  $f'(V'_0, V'_1, V'_2)$ , defined by  $f'(v) = 1$ ,  $f'(u) = f(u) - 1$  and  $f'(x) = f(x)$  whenever  $x \in V(G) \setminus \{u, v\}$ ,

satisfies that  $V_1' \cup V_2'$  is (total) dominating set. Notice that  $S \subseteq V(G)$  is a secure (total) dominating set if and only if there exists a (total) weak Roman dominating function  $f(V_0, V_1, V_2)$  such that  $V_2 = \emptyset$  and  $V_1 = S$ .

The *weak Roman domination number*, denoted by  $\gamma_r(G)$ , is the minimum weight among all weak Roman dominating functions on  $G$ . By analogy we define the *total weak Roman domination number*, which is denoted by  $\gamma_{tr}(G)$ . The weak Roman domination number was introduced by Henning and Hedetniemi [15] and studied further in several works including [7,8,10,16,17], while the total weak Roman domination number was recently introduced in [12].

A dominating set of cardinality  $\gamma(G)$  will be called a  $\gamma(G)$ -set. A similar agreement will be assumed when referring to optimal sets associated with other parameters used in the article. As usual, we will use the acronyms TDS and STDS to refer to total dominating sets and secure total dominating sets, respectively.

A TDS  $X$  is said to be a *total outer-connected dominating set* if the subgraph induced by  $V(G) \setminus X$  is connected. The *total outer-connected domination number* of  $G$ , denoted by  $\gamma_{toc}(G)$ , is the minimum cardinality among all total outer-connected dominating sets of  $G$ . This parameter was introduced by Cyman in [18] and studied further in [19–21].

An *independent set* of a graph  $G$  is a subset of vertices such that no two vertices in the subset represent an edge of  $G$ . The maximum cardinality among all independent sets is the *independence number* of  $G$ , denoted by  $\alpha(G)$ . Analogously, two edges in a graph  $G$  are independent if they are not adjacent in  $G$ . A set of pairwise independent edges of  $G$  is called a *matching* of  $G$ . The *matching number*  $\alpha'(G)$ , sometimes known as the *edge independence number*, is the maximum cardinality among all matchings of  $G$ .

For the remainder of the paper, definitions will be introduced whenever a concept is needed.

### 3. Secure Total Domination & Independence

Klostermeyer and Mynhardt [9] in 2008, established the following upper bound.

**Theorem 1.** [9] For any graph  $G$  with no isolated vertex,

$$\gamma_{st}(G) \leq 3\alpha(G) - 1.$$

In 2017 Duginov [14] answered the following open question posed by Klostermeyer and Mynhardt [9] p. 282: Is there a graph  $G$  such that  $\gamma_{st}(G) = 3\alpha(G) - 1$ , where  $\alpha(G) \geq 2$ ? Duginov provided a negative answer to this question by confirming the suspicions of Klostermeyer and Mynhardt that  $\gamma_{st}(G) \leq 2\alpha(G)$ .

**Theorem 2.** [14] For any graph  $G$  with no isolated vertex,

$$\gamma_{st}(G) \leq 2\alpha(G).$$

We now proceed to improve the bound above.

**Lemma 1.** For any graph  $G$  and any set  $D \subseteq V(G)$ , there exists an  $\alpha(G)$ -set  $I$  such that for any  $x \in I$ ,  $ipn(x, D \cup I) = \emptyset$ .

**Proof.** Let  $I$  be an  $\alpha(G)$ -set,  $D \subseteq V(G)$  and  $D_I = \{x \in I : ipn(x, D \cup I) \neq \emptyset\}$ . We can assume that we have taken  $I$  in such a way that  $|D_I|$  is minimum among all  $\alpha(G)$ -sets. Suppose that there exists  $u \in D_I$ , and consequently, let  $v \in ipn(u, D \cup I)$ . Observe that  $v \in D \setminus I$  and  $I' = (I \cup \{v\}) \setminus \{u\}$  is an  $\alpha(G)$ -set. Since  $ipn(v, D \cup I') = \emptyset$  and  $ipn(x, D \cup I') = ipn(x, D \cup I)$  for every  $x \in I' \setminus \{v\}$ , we can conclude that  $I'$



is an  $\alpha(G)$ -set satisfying that  $|D_{I'}| < |D_I|$ , which is a contradiction. Therefore,  $D_I = \emptyset$ , which completes the proof.  $\square$

Since  $\gamma(G) \leq \alpha(G)$ , the following result improves Theorem 2.

**Theorem 3.** For any graph  $G$  with no isolated vertex,

$$\gamma_{st}(G) \leq \alpha(G) + \gamma(G).$$

**Proof.** Let  $D$  be a  $\gamma(G)$ -set. By Lemma 1 there exists an  $\alpha(G)$ -set  $I$  such that  $ipn(x, D \cup I) = \emptyset$  for every  $x \in I$ . We define the set  $S \subseteq V(G)$  as follows.

- (a)  $D \cup I \subseteq S$ .
- (b) For every vertex  $x \in D \cap I$ ,
  - if  $epn(x, D \cup I) \neq \emptyset$ , then choose one vertex  $u \in epn(x, D \cup I)$  and set  $u \in S$ .
  - if  $epn(x, D \cup I) = \emptyset$ , then choose one vertex  $u \in N(x) \setminus (D \cup I)$  (if any) and set  $u \in S$ .

It is readily seen that  $S$  is a TDS. Now, let  $v \in V(G) \setminus S$ . Since  $I \subseteq S$  is also a dominating set, there exists a vertex  $u \in N(v) \cap I \subseteq N(v) \cap S$ . To conclude that  $S$  is STDS, we only need to prove that  $S' = (S \setminus \{u\}) \cup \{v\}$  is a TDS. To this end, we differentiate two cases for any  $w \in N(u)$ .

Case 1.  $u \in I \setminus D$ . If  $w \notin D$ , then there exists some vertex in  $D \subseteq S'$  which dominates  $w$ , as  $D$  is a dominating set. If  $w \in D$ , then by Lemma 1 we have that  $w \notin ipn(u, D \cup I)$ . Hence, there exists some vertex in  $(D \cup I) \setminus \{u\} \subseteq S'$  which dominates  $w$ .

Case 2.  $u \in I \cap D$ . If  $w \in D$ , then by Lemma 1 we have that  $w \notin ipn(u, D \cup I)$ , and so there exists some vertex in  $(D \cup I) \setminus \{u\} \subseteq S'$  which dominates  $w$ . From now on, suppose that  $w \notin D$ . If  $w \notin epn(u, D \cup I)$ , then  $w$  is dominated by some vertex in  $(D \cup I) \setminus \{u\} \subseteq S'$ . If  $w \in epn(u, D \cup I)$  then, as all vertices in  $epn(u, D \cup I)$  form a clique and by (b) in the definition of  $S$ ,  $w$  is dominated by some vertex in  $S \setminus \{u\} \subseteq S'$ .

Now, since  $S$  is a TDS, we have that every vertex in  $V(G) \setminus N(u)$  is dominated by some vertex in  $S'$  and, according to the two cases above, we can conclude that  $S'$  is a TDS. Therefore,  $S$  is a STDS and so  $\gamma_{st}(G) \leq |S| \leq \alpha(G) + \gamma(G)$ , which completes the proof.  $\square$

The bound above is tight. For instance, it is achieved for any corona product graph  $G = H_1 \odot H_2$ , where  $H_1$  is an arbitrary graph and  $H_2$  is the disjoint union of  $k$  complete nontrivial graphs. Notice that  $\alpha(G) = k|V(H_1)|$ ,  $\gamma(G) = |V(H_1)|$  and  $\gamma_{st}(G) = (k+1)|V(H_1)| = \alpha(G) + \gamma(G)$ . Another example is the graph  $G$  shown in Figure 2, where  $\gamma_{st}(G) = 8$ ,  $\alpha(G) = 6$  and  $\gamma(G) = 2$ .

#### 4. Secure Total Domination & Other Kinds of Domination

For any graph  $G$  with no isolated vertex,  $V(G)$  is a secure total dominating set, which implies that  $\gamma_{st}(G) \leq |V(G)|$ . All graphs achieving this trivial bound were characterized by Benecke et al. as follows.

**Theorem 4.** [11] Let  $G$  be a graph of order  $n$ . Then  $\gamma_{st}(G) = n$  if and only if  $V(G) \setminus (L(G) \cup S(G))$  is an independent set.

Since every secure total dominating set is a total dominating set, it is clear that  $\gamma_t(G) \leq \gamma_{st}(G)$ . All graphs satisfying the equality were characterized by Klostermeyer and Mynhardt in [9].

**Theorem 5.** [9] If  $G$  is a connected graph, then the following statements are equivalent.

- $\gamma_{st}(G) = \gamma_t(G)$ .
- $\gamma_{st}(G) = 2$ .
- $G$  has two universal vertices.

The result above is an important tool to characterize all graphs with  $\gamma_{st}(G) = 3$ . To begin with, we need to state the following basic tool.

**Proposition 1.** *If  $H$  is a spanning subgraph (with no isolated vertex) of a graph  $G$ , then*

$$\gamma_{st}(G) \leq \gamma_{st}(H).$$

**Proof.** Let  $E^- = \{e_1, \dots, e_k\}$  be the set of all edges of  $G$  not belonging to the edge set of  $H$ . Let  $H_0 = G$  and, for every  $i \in \{1, \dots, k\}$ , let  $X_i = \{e_1, \dots, e_i\}$  and  $H_i = G - X_i$ . Since any STDS of  $H_i$  is a STDS of  $H_{i-1}$ , we can conclude that  $\gamma_{st}(H_{i-1}) \leq \gamma_{st}(H_i)$ . Hence,  $\gamma_{st}(G) = \gamma_{st}(H_0) \leq \gamma_{st}(H_1) \leq \dots \leq \gamma_{st}(H_k) = \gamma_{st}(H)$ .  $\square$

Let  $\mathcal{G}$  be the family of graphs  $H$  of order  $n \geq 3$  such that the subgraph induced by three vertices of  $H$  contains a path  $P_3$  and the remaining  $n - 3$  vertices have degree two and they form an independent set. Figure 1 shows a graph belonging to  $\mathcal{G}$ .

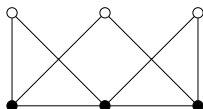

**Figure 1.** A graph  $H$  belonging to  $\mathcal{G}$ . The set of black-coloured vertices forms a  $\gamma_{st}(H)$ -set

**Theorem 6.** *Given a graph  $G$ , the following statements are equivalent.*

- $\gamma_{st}(G) = 3$ .
- $G$  has at most one universal vertex and there exists  $H \in \mathcal{G}$  which is a spanning subgraph of  $G$ .

**Proof.** Let  $D$  be a  $\gamma_{st}(G)$ -set and assume that  $|D| = 3$ . By Theorem 5,  $G$  has at most one universal vertex. Let  $D = \{u, v, w\}$  and notice that  $\langle D \rangle$  contains a path  $P_3$ , as  $D$  is a total dominating set of  $G$ . Since  $D$  is a STDS of  $G$ , we observe that  $|N(z) \cap D| \geq 2$  for every  $z \in V(G) \setminus D$ . Hence, in this case,  $G$  contains a spanning subgraph belonging to  $\mathcal{G}$ .

Conversely, since  $G$  has at most one universal vertex, by Theorem 5 we have that  $\gamma_{st}(G) \geq 3$ . Moreover, it is readily seen that  $\gamma_{st}(H) \leq 3$  for any  $H \in \mathcal{G}$ . Hence, if  $H \in \mathcal{G}$  is a spanning subgraph of  $G$ , by Proposition 1 it follows that  $\gamma_{st}(G) \leq 3$ . Therefore,  $\gamma_{st}(G) = 3$ .  $\square$

We now consider the relationship between  $\gamma_s(G)$  and  $\gamma_{st}(G)$ .

**Theorem 7.** [9] *Let  $G$  be a graph with no isolated vertex.*

- If  $\delta(G) = 1$ , then  $\gamma_s(G) + 1 \leq \gamma_{st}(G)$ .
- If  $\delta(G) \geq 2$ , then  $\gamma_s(G) \leq \gamma_{st}(G) \leq 2\gamma_s(G)$ .

A natural question is if the bound  $\gamma_{st}(G) \leq 2\gamma_s(G)$ , due to Klostermeyer and Mynhardt, can be improved with  $\gamma_{st}(G) \leq \gamma_s(G) + \gamma(G)$ . The example given in Figure 2 shows that, in general, this inequality does not hold.

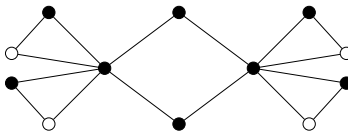

**Figure 2.** A graph  $G$  with  $\gamma_{st}(G) = 8$ ,  $\gamma_s(G) = 5$  and  $\gamma(G) = 2$ . The set of black-coloured vertices forms a  $\gamma_{st}(G)$ -set.

In Theorem 10 we will show some cases in which  $\gamma_{st}(G) \leq \gamma_s(G) + \gamma(G)$ . To this end, we need to outline the following two known results.

**Theorem 8.** [12] *The following inequalities hold for any graph  $G$  with no isolated vertex.*

- (i)  $\gamma_t(G) \leq \gamma_{tr}(G) \leq \gamma_{st}(G)$ .
- (ii)  $\gamma_{tr}(G) \leq \min\{\gamma_t(G), \gamma_r(G)\} + \gamma(G)$ .

Although the problem of characterizing all graphs with  $\gamma_{tr}(G) = \gamma_{st}(G)$  remains open, some particular cases were described in [12].

**Theorem 9.** [12]

- (i)  $\gamma_{st}(G) = \gamma(G) + 1$  if and only if  $\gamma_{tr}(G) = \gamma(G) + 1$ .
- (ii) For any  $\{K_{1,3}, K_{1,3} + e\}$ -free graph  $G$  with no isolated vertex,  $\gamma_{st}(G) = \gamma_{tr}(G)$ .
- (iii) For any graph  $G$  with no isolated vertex and maximum degree  $\Delta(G) \leq 2$ ,  $\gamma_{st}(G) = \gamma_{tr}(G)$ .

From Theorems 8 and 9 (ii), and using the fact that  $\gamma_r(G) \leq \gamma_s(G)$ , we can show that the bound  $\gamma_{st}(G) \leq 2\gamma_s(G)$  established in Theorem 7 can be improved for any  $\{K_{1,3}, K_{1,3} + e\}$ -free graph.

**Theorem 10.** For any  $\{K_{1,3}, K_{1,3} + e\}$ -free graph  $G$  with no isolated vertex,

$$\gamma_{st}(G) \leq \min\{\gamma_t(G), \gamma_r(G)\} + \gamma(G) \leq \gamma_s(G) + \gamma(G).$$

The previous bounds are tight. They are achieved, for instance, for the wheel graph  $G \cong N_1 + C_4$  and for  $G \cong N_2 + P_3$ , which is the join of  $N_2$  and  $P_3$ . For these two graphs we have that  $\gamma_{st}(G) = 3$ ,  $\gamma_s(G) = \gamma_r(G) = \gamma_t(G) = 2$  and  $\gamma(G) = 1$ .

To derive a consequence of Theorem 10 we need to state the following result due to Burger et al. [6].

**Theorem 11.** [6] For any connected graph  $G \not\cong C_5$  of order  $n$  and  $\delta(G) \geq 2$ ,

$$\gamma_s(G) \leq \left\lfloor \frac{n}{2} \right\rfloor.$$

Notice that  $\gamma_{st}(C_5) = 4 = \left\lfloor \frac{5}{2} \right\rfloor + \gamma(C_5)$ . Hence, from Theorems 10 and 11 we immediately have the next result.

**Theorem 12.** For any connected  $\{K_{1,3}, K_{1,3} + e\}$ -free graph  $G$  of order  $n$  and  $\delta(G) \geq 2$ ,

$$\gamma_{st}(G) \leq \left\lfloor \frac{n}{2} \right\rfloor + \gamma(G).$$

The bound above is tight. It is achieved for  $G \cong N_1 + C_4$ ,  $G \cong C_5$  and  $G \cong C_6$ , where  $\gamma_{st}(G)$  equals 3, 4 and 5, respectively.

The following result shows us a relationship between the secure total domination number and the total outer-connected domination number.

**Theorem 13.** *Let  $G$  be a graph of order  $n$ . If  $\gamma_{toc}(G) \leq n - 2$ , then*

$$\gamma_{st}(G) \leq \left\lfloor \frac{\gamma_{toc}(G) + n}{2} \right\rfloor.$$

**Proof.** We assume that  $\gamma_{toc}(G) \leq n - 2$ . Let  $D$  be a  $\gamma_{toc}(G)$ -set and  $S$  a  $\gamma(\langle V(G) \setminus D \rangle)$ -set. Since  $D$  is a TDS of  $G$ ,  $D \cup S$  is a TDS as well. Furthermore, every vertex  $u \in V(G) \setminus (D \cup S)$  is dominated by some vertex  $v \in S$ , and  $D \subseteq (D \cup S \cup \{u\}) \setminus \{v\}$  is a TDS of  $G$ . Hence,  $D \cup S$  is a STDS of  $G$ , which implies that  $\gamma_{st}(G) \leq |D \cup S| = |D| + |S|$ . Now, since  $\langle V(G) \setminus D \rangle$  is a connected nontrivial graph, we have that  $|S| = \gamma(\langle V(G) \setminus D \rangle) \leq \frac{|V(G) \setminus D|}{2} = \frac{n - \gamma_{toc}(G)}{2}$ . Therefore,  $\gamma_{st}(G) \leq \lfloor \frac{\gamma_{toc}(G) + n}{2} \rfloor$ , which completes the proof.  $\square$

The bound above is tight. For instance, it is achieved for the wheel graph  $G \cong N_1 + C_4$  and for  $G \cong N_2 + P_3$ . In both cases  $\gamma_{st}(G) = 3$  and  $\gamma_{toc}(G) = 2$ .

The following result was obtained by Favaron et al. in [20].

**Theorem 14.** [20] *For any graph  $G$  of order  $n$ , diameter  $\text{diam}(G) \leq 2$  and minimum degree  $\delta(G) \geq 3$ ,*

$$\gamma_{toc}(G) \leq \left\lfloor \frac{2n - 2}{3} \right\rfloor.$$

The following result is a direct consequence of combining the result above and Theorem 13.

**Theorem 15.** *For any graph  $G$  of order  $n$ , diameter two and minimum degree  $\delta(G) \geq 3$ ,*

$$\gamma_{st}(G) \leq \left\lfloor \frac{5n - 2}{6} \right\rfloor.$$

The bound above is achieved for the wheel graph  $G \cong N_1 + C_4$  and for  $G \cong N_2 + P_3$ . As we already know, in both cases  $\gamma_{st}(G) = 3$ .

### 5. Secure Total Domination & Matching

To begin this section, we proceed to introduce new definitions and terminology. Given a matching  $\mathcal{M}$  of a graph  $G$ , let  $V_{\mathcal{M}}$  be the set formed by the end-vertices of edges belonging to  $\mathcal{M}$ . Given a vertex  $v \in V_{\mathcal{M}}$ , we say that  $v' \in V_{\mathcal{M}}$  is the *partner* of  $v$  if  $vv' \in \mathcal{M}$ . Observe that if  $v'$  is the partner of  $v$ , then  $v$  is the partner of  $v'$ .

A *maximum matching* is a matching of cardinality  $\alpha'(G)$ . The following lemmas show some properties of maximum matchings.

**Lemma 2.** *Let  $\mathcal{M}$  be a maximum matching of a graph  $G$ . The following statements hold.*

- (i)  $N(u) \subseteq V_{\mathcal{M}}$  for every  $u \in V(G) \setminus V_{\mathcal{M}}$ .
- (ii) If  $u \in V(G) \setminus V_{\mathcal{M}}$  is adjacent to  $v \in V_{\mathcal{M}}$ , then  $N(v') \subseteq V_{\mathcal{M}} \cup \{u\}$ , where  $v'$  is the partner of  $v$ .

**Proof.** Let  $u \in V(G) \setminus V_{\mathcal{M}}$ . If there exists a vertex  $w \in N(u) \cap (V(G) \setminus V_{\mathcal{M}})$ , then the set  $\mathcal{M} \cup \{uw\}$  is a matching of  $G$  of cardinality greater than  $|\mathcal{M}|$ , which is a contradiction. Hence,  $N(u) \subseteq V_{\mathcal{M}}$  and (i) follows.

Now, we suppose that there exists  $u \in V(G) \setminus V_{\mathcal{M}}$  and a vertex  $v \in N(u) \cap V_{\mathcal{M}}$ . Let  $v'$  be the partner of  $v$ . If there exists a vertex  $w \in N(v') \cap (V(G) \setminus (V_{\mathcal{M}} \cup \{u\}))$ , then the set  $\mathcal{M} \setminus \{vv'\} \cup \{uv, v'w\}$  is a matching of  $G$  of cardinality greater than  $|\mathcal{M}|$ , which is a contradiction. Hence,  $N(v') \subseteq V_{\mathcal{M}} \cup \{u\}$  and (ii) follows.  $\square$

**Lemma 3.** For any graph  $G$  with  $L(G) \neq \emptyset$ , there exists a maximum matching  $\mathcal{M}$  such that for each vertex  $x \in S(G)$  there exists  $y \in L(G)$  such that  $xy \in \mathcal{M}$ .

**Proof.** Let  $\mathcal{M}$  be a maximum matching of  $G$  such that  $|V_{\mathcal{M}} \cap L(G)|$  is maximum. It is easy to see that the maximality of  $\mathcal{M}$  leads to  $S(G) \subseteq V_{\mathcal{M}}$ . Suppose that there exists a support vertex  $x$  such that  $xx' \in \mathcal{M}$  and  $x' \notin L(G)$ . Let  $y \in N(x) \cap L(G)$ . Notice that the set  $\mathcal{M}' = \mathcal{M} \setminus \{xx'\} \cup \{xy\}$  is a maximum matching of  $G$  and  $|V_{\mathcal{M}'} \cap L(G)| > |V_{\mathcal{M}} \cap L(G)|$ , which is a contradiction. Therefore, the result follows.  $\square$

The next result provides a relationship between the secure total domination number, the matching number and some special vertices of a graph.

**Theorem 16.** For any graph  $G$  with minimum degree  $\delta(G) = 1$ ,

$$\gamma_{st}(G) \leq 2\alpha'(G) + |L(G)| - |S(G)| + |I_G|.$$

**Proof.** Let  $\mathcal{M}$  be a maximum matching satisfying Lemma 3. Let  $S = V_{\mathcal{M}} \cup L(G) \cup I_G$ . Notice that  $V_{\mathcal{M}} \cap I_G = \emptyset$  and  $S(G) \subseteq V_{\mathcal{M}}$ . Hence,  $|S| = 2\alpha'(G) + |L(G)| - |S(G)| + |I_G|$ .

Notice that  $S$  is a TDS of  $G$ . We shall show that  $S$  is a STDS of  $G$ . Now, let  $v \in V(G) \setminus S$ . Since  $v \notin I_G$  and  $V_{\mathcal{M}}$  is a dominating set of  $G$ , there exists a vertex  $u \in V_{\mathcal{M}} \setminus S(G)$  which is adjacent to  $v$ . Let  $S' = (S \setminus \{u\}) \cup \{v\}$ . We will see that  $S'$  is a TDS of  $G$  as well. Since  $S$  is a TDS of  $G$ , every vertex  $w \in V(G) \setminus N(u)$  is adjacent to some vertex belonging to  $S'$ . Let  $w \in N(u)$  and observe that  $|N(w)| \geq 2$  as  $u \notin S(G)$ .

If  $w \in V(G) \setminus V_{\mathcal{M}}$ , then by Lemma 2 (i) we have that  $N(w) \subseteq V_{\mathcal{M}}$ . Hence there exists a vertex in  $V_{\mathcal{M}} \setminus \{u\} \subseteq S'$  which is adjacent to  $w$ , as  $|N(w)| \geq 2$ . Now, if  $w \in V_{\mathcal{M}} \setminus \{u\}$ , where  $u'$  is the partner of  $u$ , then  $w$  is adjacent to its partner, which belongs to  $S'$ . Finally, if  $w = u'$ , then by Lemma 2 (ii) we have that  $N(w) \subseteq V_{\mathcal{M}} \cup \{v\}$  and since  $|N(w)| \geq 2$  it follows that  $N(w) \subseteq (V_{\mathcal{M}} \setminus \{u\}) \cup \{v\} \subseteq S'$ .

Thus,  $S'$  is a TDS of  $G$ , as desired. Therefore,  $S$  is a STDS and so  $\gamma_{st}(G) \leq |S| = 2\alpha'(G) + |L(G)| - |S(G)| + |I_G|$ .  $\square$

The bound above is tight. For instance, it is achieved for the graph shown in Figure 3. In this case,  $\gamma_{st}(G) = 22$ ,  $\alpha'(G) = 7$ ,  $|L(G)| = 12$ ,  $|S(G)| = 6$  and  $|I_G| = 2$ .

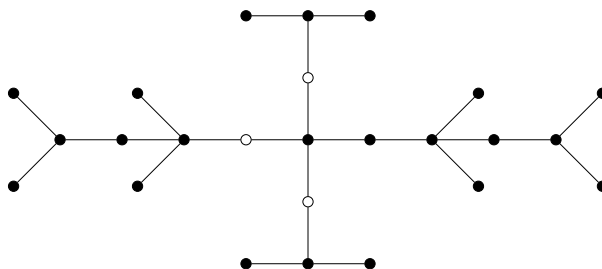

Figure 3. The set of black-coloured vertices forms a  $\gamma_{st}(G)$ -set.

From now on we consider the case of graphs with minimum degree  $\delta(G) \geq 2$ .

**Definition 1.** Given a maximum matching  $\mathcal{M}$  of a graph  $G$  with  $\delta(G) \geq 2$ , we construct a set  $D_{\mathcal{M}} \subseteq V_{\mathcal{M}}$  as follows.

- (i)  $|D_{\mathcal{M}}| = \alpha'(G)$ .
- (ii)  $xy \notin \mathcal{M}$  for all  $x, y \in D_{\mathcal{M}}$ .
- (iii)  $|N(x) \cap (V(G) \setminus V_{\mathcal{M}})| \geq |N(x') \cap (V(G) \setminus V_{\mathcal{M}})|$  for all  $x \in D_{\mathcal{M}}$ , where  $x'$  is the partner of  $x$ .

We proceed to show some properties of  $D_{\mathcal{M}} \subseteq V_{\mathcal{M}}$ .

**Lemma 4.** Let  $\mathcal{M}$  be a maximum matching of a graph  $G$  with  $\delta(G) \geq 2$ . The following statements hold.

- (a) If  $u \in V(G) \setminus V_{\mathcal{M}}$  is adjacent to  $v' \in V_{\mathcal{M}} \setminus D_{\mathcal{M}}$ , then  $u$  is adjacent to  $v \in D_{\mathcal{M}}$ , where  $v$  is the partner of  $v'$ .
- (b)  $D_{\mathcal{M}}$  is a dominating set of  $G$ .
- (c) If  $v \in D_{\mathcal{M}}$ , then its partner  $v' \in V_{\mathcal{M}} \setminus D_{\mathcal{M}}$  satisfies that  $|N(v') \cap V_{\mathcal{M}}| \geq \delta(G) - 1$ .

**Proof.** Let  $u \in V(G) \setminus V_{\mathcal{M}}$ . By Lemma 2 (i) we have that  $N(u) \subseteq V_{\mathcal{M}}$ . If there exists a vertex  $v' \in V_{\mathcal{M}} \setminus D_{\mathcal{M}}$ , then by Lemma 2 (ii) we have that  $N(v) \subseteq V_{\mathcal{M}} \cup \{u\}$  (where  $v \in D_{\mathcal{M}}$  is the partner of  $v'$ ). By item (iii) in the definition of  $D_{\mathcal{M}}$  it follows that  $u \in N(v)$  and (a) holds.

From item (a) we deduce that  $N(u) \cap D_{\mathcal{M}} \neq \emptyset$ . Now, by definition of  $D_{\mathcal{M}}$ , every vertex in  $V_{\mathcal{M}} \setminus D_{\mathcal{M}}$  is dominated by its partner, which belongs to  $D_{\mathcal{M}}$ . Therefore,  $D_{\mathcal{M}}$  is a dominating set of  $G$  and so (b) follows.

Now, let  $z \in D_{\mathcal{M}}$  and  $z'$  its partner. If  $|N(z') \cap V_{\mathcal{M}}| \leq \delta(G) - 2$ , then there exist two vertices  $x, y \in N(z') \cap (V(G) \setminus V_{\mathcal{M}})$ . By Lemma 4 (a) we have that  $x, y \in N(z)$ , which is a contradiction by Lemma 2 (ii). Therefore,  $|N(z') \cap V_{\mathcal{M}}| \geq \delta(G) - 1$  and (c) follows, which completes the proof.  $\square$

**Theorem 17.** For any graph  $G$  with minimum degree  $\delta(G) \geq 2$ ,

$$\gamma_{st}(G) \leq 2\alpha'(G) - \delta(G) + 2.$$

**Proof.** Let  $n$  be the order of  $G$ . Let  $v \in V(G)$  be a vertex of degree  $\delta(G)$  and  $u \in N(v)$ . It is readily seen that the set  $S = (V(G) \setminus N(v)) \cup \{u\}$  is a STDS of  $G$  and, as a consequence,  $\gamma_{st}(G) \leq n - \delta(G) + 1$ . Thus, the inequality holds for  $2\alpha'(G) \in \{n - 1, n\}$ .

From now on we suppose that  $2\alpha'(G) \leq n - 2$ . Let  $\mathcal{M}$  be a maximum matching of  $G$ . Since  $|V_{\mathcal{M}}| = 2\alpha'(G) \leq n - 2$ , there exist two vertices  $x, y \in V(G) \setminus V_{\mathcal{M}}$ . By Lemma 4 (b) we have that  $D_{\mathcal{M}}$  is a dominating set of  $G$ , which implies that there exists a vertex  $v_x \in N(x) \cap D_{\mathcal{M}}$ . Since  $\delta(G) \geq 2$ , by Lemmas 2 and 4 (a), there exists a vertex  $v_y \in N(y) \cap (D_{\mathcal{M}} \setminus \{v_x\})$  and also we deduce that  $N(x) \cup N(y) \subseteq V_{\mathcal{M}}$  and  $N(x) \cap N(y) \subseteq D_{\mathcal{M}}$ . Let  $R = (N(x) \cup N(y)) \cap D_{\mathcal{M}}$ . Hence  $|R| = |N(x) \cap N(y)| + |(N(x) \setminus N(y)) \cap D_{\mathcal{M}}| + |(N(y) \setminus N(x)) \cap D_{\mathcal{M}}| \geq (|N(x)| + |N(y)|)/2 \geq \delta(G)$ . Let  $Z \subseteq R \setminus \{v_x, v_y\}$  such that  $|Z| = \delta(G) - 2$  and let  $Z'$  be the set of partners of the vertices in  $Z$ .

Let  $\mathcal{M}' = (\mathcal{M} \setminus \{v_x v'_x, v_y v'_y\}) \cup \{x v'_x, y v'_y\}$ , where  $v'_x$  and  $v'_y$  are the partners of  $v_x$  and  $v_y$  respectively. Notice that  $\mathcal{M}'$  is a maximum matching of  $G$  and the set  $D_{\mathcal{M}'} = D_{\mathcal{M}} \subseteq V_{\mathcal{M}'}$  satisfies the conditions given in Definition 1.

We will prove that  $S = V_{\mathcal{M}'} \setminus Z'$  is a STDS of  $G$ . By Lemma 4 (b) we have that  $D_{\mathcal{M}}$  is a dominating set of  $G$ , which implies that every vertex in  $V(G) \setminus S$  is dominated by some vertex in  $D_{\mathcal{M}} \subseteq S$ . Also, every vertex in  $Z$  is dominated by either  $x$  or  $y$ , which belong to  $S$ , and every vertex in  $S \setminus Z$  satisfies that its partner belongs to  $S$  as well. Hence  $S$  is a TDS of  $G$ .

Let  $v \in V(G) \setminus S$  and let  $S' = (S \setminus \{v^*\}) \cup \{v\}$ , where either  $v^* = v'$  is the partner of  $v$  if  $v \in Z'$ , or  $v^*$  is a vertex belonging to  $N(v) \cap D_{\mathcal{M}}$  if  $v \in V(G) \setminus V_{\mathcal{M}'}$  (notice that in this case,  $v^*$  exists since  $D_{\mathcal{M}}$

is a dominating set). We only need to prove that  $S'$  is a TDS of  $G$ . Since  $S$  is a TDS of  $G$ , every vertex in  $V(G) \setminus N(v^*)$  has at least one neighbour in  $S'$ . Now, let  $u \in N(v^*)$  and consider the following two cases.

Case 1.  $u \in V(G) \setminus V_{\mathcal{M}'}$ . Since  $|V_{\mathcal{M}'} \cap (V(G) \setminus S')| = \delta(G) - 1$ , by Lemma 2 (i) we deduce that there exists some vertex in  $N(u) \cap S'$ .

Case 2.  $u \in V_{\mathcal{M}'}$ . In this case, we analyse three subcases. If  $u \in Z$ , then  $u$  is dominated by either  $x$  or  $y$ , which belong to  $S'$ . If  $u = v$ , then as  $u \in V_{\mathcal{M}'} \setminus D_{\mathcal{M}'}$ , by Lemma 4 (c) it follows that  $|N(u) \cap V_{\mathcal{M}'}| \geq \delta(G) - 1$ . As in this case  $|V_{\mathcal{M}'} \cap (V(G) \setminus S')| = \delta(G) - 2$ , we deduce that  $N(u) \cap S' \neq \emptyset$ . Finally, if  $u \in V_{\mathcal{M}'} \setminus (Z \cup \{v\})$ , then its partner belongs to  $S'$ .

Hence,  $S'$  is a TDS of  $G$ , as desired. Therefore,  $S$  is a STDS of  $G$  and  $\gamma_{st}(G) \leq |S| = |V_{\mathcal{M}'} \setminus Z'| = 2\alpha'(G) - \delta(G) + 2$ , which completes the proof.  $\square$

The bound above is tight. For instance, it is achieved for the graphs  $G \cong N_2 + P_3$  and  $G \cong N_1 + C_4$ . In both cases  $\gamma_{st}(G) = 3$ ,  $\alpha'(G) = 2$  and  $\delta(G) = 3$ .

Cockayne et al. in [8] obtained the following bound on the secure domination number in terms of the order and the matching number.

**Theorem 18.** [8] *If a graph  $G$  of order  $n$  does not have isolated vertices, then*

$$\gamma_s(G) \leq n - \alpha'(G).$$

Therefore, by Theorems 10 and 18 we deduce the following result.

**Theorem 19.** *For any  $\{K_{1,3}, K_{1,3} + e\}$ -free graph  $G$  with minimum degree  $\delta(G) \geq 1$  and order  $n$ ,*

$$\gamma_{st}(G) \leq n - \alpha'(G) + \gamma(G).$$

The bound above is tight. For instance, it is achieved for the graphs  $G \cong C_6$  and  $G \cong P_6$ , as for these graphs we have  $\gamma_{st}(G) = 5$ ,  $\alpha'(G) = 3$  and  $\gamma(G) = 2$ .

The  $k$ -domination number of  $G$ , denoted by  $\gamma_k(G)$ , is another well-known parameter [3]. The following theorem is a contribution of DeLaViña et al. in [22].

**Theorem 20.** [22] *Let  $k$  be a positive integer. For any graph  $G$  with minimum degree  $\delta(G) \geq 2k - 1$ ,*

$$\gamma_k(G) \leq \alpha'(G).$$

Since every  $\gamma_2(G)$ -set is a secure dominating set of  $G$ , it is immediate that  $\gamma_s(G) \leq \gamma_2(G)$ , and so Theorems 10 and 20 lead to the following result.

**Theorem 21.** *For any  $\{K_{1,3}, K_{1,3} + e\}$ -free graph  $G$  with minimum degree  $\delta(G) \geq 3$ ,*

$$\gamma_{st}(G) \leq \alpha'(G) + \gamma(G).$$

The bound above is tight. For instance, it is achieved for the wheel graph  $G \cong N_1 + C_4$  and for  $G \cong N_2 + P_3$ , as in both cases  $\gamma_{st}(G) = 3$ ,  $\alpha'(G) = 2$  and  $\gamma(G) = 1$ .

## 6. Conclusions

This article is a contribution to the theory of protection of graphs. In particular, it is devoted to the study of the secure total domination number of a graph. We study the properties of this parameter in order to obtain its exact value or general bounds. Among our main contributions we highlight the following.

- We show that  $\gamma_{st}(G) \leq \alpha(G) + \gamma(G)$ . Since  $\gamma(G) \leq \alpha(G)$ , this result improves the bound  $\gamma_{st}(G) \leq 2\alpha(G)$  obtained in [14].
- We characterize the graphs with  $\gamma_{st}(G) = 3$ .
- We show that if  $G$  is a  $\{K_{1,3}, K_{1,3} + e\}$ -free graph  $G$  with no isolated vertex, then  $\gamma_{st}(G) \leq \min\{\gamma_t(G), \gamma_r(G)\} + \gamma(G) \leq \gamma_s(G) + \gamma(G)$ .
- We study the relationship that exists between the secure total domination number and the matching number of a graph. In particular, we obtain the following results.
  - (a)  $\gamma_{st}(G) \leq 2\alpha'(G) + |L(G)| - |S(G)| + |I_G|$  for any graph  $G$  of minimum degree one.
  - (b)  $\gamma_{st}(G) \leq 2\alpha'(G) - \delta(G) + 2$  for every graph  $G$  of minimum degree  $\delta(G) \geq 2$ .
  - (c)  $\gamma_{st}(G) \leq \alpha'(G) + \gamma(G)$  for every  $\{K_{1,3}, K_{1,3} + e\}$ -free graph  $G$  of minimum degree  $\delta(G) \geq 3$ .

All bounds obtained in the paper are tight.

**Author Contributions:** The results presented in this paper were obtained as a result of collective work sessions involving all authors. The process was organized and led by J.A.R.-V.

**Funding:** This work has been partially supported by the Spanish Ministry of Economy, Industry and Competitiveness, under the grants MTM2016-78227-C2-1-P and MTM2017-90584-REDT.

**Conflicts of Interest:** The authors declare no conflict of interest.

## References

1. Cockayne, E.J.; Grobler, P.J.P.; Gründlingh, W.R.; Munganga, J.; van Vuuren, J.H. Protection of a graph. *Util. Math.* **2005**, *67*, 19–32.
2. Haynes, T.W.; Hedetniemi, S.T.; Slater, P.J. *Domination in Graphs: Volume 2: Advanced Topics*; Chapman & Hall/CRC Pure and Applied Mathematics; Taylor & Francis Group: Abingdon, UK, 1998.
3. Haynes, T.W.; Hedetniemi, S.T.; Slater, P.J. *Fundamentals of Domination in Graphs*; Chapman and Hall/CRC Pure and Applied Mathematics Series; Marcel Dekker, Inc.: New York, NY, USA, 1998.
4. Henning, M.A.; Yeo, A. *Total Domination in Graphs, Springer Monographs in Mathematics*; Springer: New York, NY, USA, 2013.
5. Boumediene Merouane, H.; Chellali, M. On secure domination in graphs. *Inform. Process. Lett.* **2015**, *115*, 786–790. [[CrossRef](#)]
6. Burger, A.P.; Henning, M.A.; van Vuuren, J.H. Vertex covers and secure domination in graphs. *Quaest. Math.* **2008**, *31*, 163–171. [[CrossRef](#)]
7. Chellali, M.; Haynes, T.W.; Hedetniemi, S.T. Bounds on weak Roman and 2-rainbow domination numbers. *Discrete Appl. Math.* **2014**, *178*, 27–32. [[CrossRef](#)]
8. Cockayne, E.J.; Favaron, O.; Mynhardt, C.M. Secure domination, weak Roman domination and forbidden subgraphs. *Bull. Inst. Combin. Appl.* **2003**, *39*, 87–100.
9. Klostermeyer, W.F.; Mynhardt, C.M. Secure domination and secure total domination in graphs. *Discuss. Math. Graph Theory* **2008**, *28*, 267–284. [[CrossRef](#)]
10. Valveny, M.; Rodríguez-Velázquez, J.A. Protection of graphs with emphasis on Cartesian product graphs. *Filomat* **2019**, *33*, 319–333.
11. Benecke, S.; Cockayne, E.J.; Mynhardt, C.M. Secure total domination in graphs. *Util. Math.* **2007**, *74*, 247–259.
12. Cabrera Martínez, A.; Montejano, L.P.; Rodríguez-Velázquez, J.A. Total weak Roman domination in graphs. *Symmetry* **2019**, *11*, 831. [[CrossRef](#)]



13. Kulli, V.R.; Chaluvvaraju, B.; Kumara, M. Graphs with equal secure total domination and inverse secure total domination numbers. *J. Inf. Optim. Sci.* **2008**, *39*, 467–473. [[CrossRef](#)]
14. Duginov, O. Secure total domination in graphs: bounds and complexity. *Discrete Appl. Math.* **2017**, *222*, 97–108. [[CrossRef](#)]
15. Henning, M.A.; Hedetniemi, S.T. Defending the Roman Empire—A new strategy. *Discrete Math.* **2003**, *266*, 239–251. [[CrossRef](#)]
16. Pushpam, P.R.L.; Malini Mai, T.N.M. Weak Roman domination in graphs. *Discuss. Math. Graph Theory* **2011**, *31*, 115–128.
17. Valveny, M.; Pérez-Rosés, H.; Rodríguez-Velázquez, J.A. On the weak Roman domination number of lexicographic product graphs. *Discrete Appl. Math.* **2019**, *263*, 257–270. [[CrossRef](#)]
18. Cyman, J. Total outer-connected domination numbers in trees. *Discuss. Math. Graph Theory* **2010**, *30*, 377–383. [[CrossRef](#)]
19. Cyman, J.; Raczek, J. Total outer-connected domination numbers of trees. *Discrete Appl. Math.* **2009**, *157*, 3198–3202. [[CrossRef](#)]
20. Favaron, O.; Karami, H.; Sheikholeslami, S.M. On the total outer-connected domination in graphs. *J. Comb. Optim.* **2014**, *27*, 451–461. [[CrossRef](#)]
21. Hattingh, J.; Joubert, E. A note on total outer-connected domination numbers of a tree. *AKCE J. Graphs Comb.* **2010**, *7*, 223–227.
22. DeLaViña, E.; Goddard, W.; Henning, M.A.; Pepper, R.; Vaughan, E.R. Bounds on the  $k$ -domination number of a graph. *Appl. Math. Lett.* **2011**, *24*, 996–998. [[CrossRef](#)]



© 2019 by the authors. Licensee MDPI, Basel, Switzerland. This article is an open access article distributed under the terms and conditions of the Creative Commons Attribution (CC BY) license (<http://creativecommons.org/licenses/by/4.0/>).

## Chapter 8

# Secure total domination in rooted product graphs

This chapter includes a complete copy of the following paper.

A. Cabrera Martínez, A. Estrada-Moreno, J.A. Rodríguez-Velázquez. Secure total domination in rooted product graphs, *Mathematics* (2020) 8(4), 600.

URL: <https://doi.org/10.3390/math8040600>

Quality indicators:

2019 JCR Impact factor: 1.747, Q1 (28/325), Mathematics.



Article

# Secure Total Domination in Rooted Product Graphs

Abel Cabrera Martínez , Alejandro Estrada-Moreno and Juan A. Rodríguez-Velázquez \*

Departament d'Enginyeria Informàtica i Matemàtiques, Universitat Rovira i Virgili, Av. Països Catalans 26, 43007 Tarragona, Spain; abel.cabrera@urv.cat (A.C.M.); alejandro.estrada@urv.cat (A.E.-M.)

\* Correspondence: juanalberto.rodriguez@urv.cat

Received: 16 March 2020; Accepted: 14 April 2020; Published: 15 April 2020



**Abstract:** In this article, we obtain general bounds and closed formulas for the secure total domination number of rooted product graphs. The results are expressed in terms of parameters of the factor graphs involved in the rooted product.

**Keywords:** secure total domination; total domination; domination; rooted product graph

## 1. Introduction

Recently, many authors have considered the following approach to the problem of protecting a graph [1–7]: suppose that one “entity” is stationed at some of the vertices of a (simple) graph  $G$  and that an entity at a vertex can deal with a problem at any vertex in its closed neighbourhood. In general, an entity could consist of a robot, an observer, a legion, a guard, and so on. Informally, we say that a graph  $G$  is protected under a given placement of entities if there exists at least one entity available to handle a problem at any vertex. Various strategies (or rules for entities placements) have been considered, under each of which the graph is deemed protected. As we can expect, the minimum number of entities required for protection under each strategy is of interest. Among these strategies we cite, for instance, domination [8,9], total domination [10], secure domination [1], secure total domination [2], Roman domination [6,7], Italian domination, [11] and weak Roman domination [5]. The first four strategies are described below.

The simplest strategies of graph protection are the strategy of domination and the strategy of total domination. In such cases, the sets of vertices containing the entities are dominating sets and total dominating sets, respectively. Typically, a vertex in a graph  $G = (V(G), E(G))$  dominates itself and its neighbouring vertices. A set  $S \subseteq V(G)$  is said to be a dominating set of  $G$  if every vertex in  $V(G) \setminus S$  is dominated by at least one vertex in  $S$ , while  $S$  is said to be a total dominating set if every vertex  $v \in V(G)$  is dominated by at least one vertex in  $S \setminus \{v\}$ .

The minimum cardinality among all dominating sets of  $G$  is the domination number of  $G$ , denoted by  $\gamma(G)$ . The total domination number, denoted by  $\gamma_t(G)$ , is defined by analogy. These two parameters have been extensively studied. For instance, we cite the following books, [8–10].

Let  $N(v)$  be the open neighbourhood of  $v \in V(G)$  and let  $S \subseteq V(G)$ . In the case of the secure (total) domination strategy, a vertex  $v \in V(G) \setminus S$  is deemed (totally) protected under  $S \subseteq V(G)$  if  $S$  is a (total) dominating set and there exists  $u \in N(v) \cap S$  such that  $(S \cup \{v\}) \setminus \{u\}$  is a (total) dominating set. In such a case, in order to emphasise the role of vertex  $u$ , we say that  $v$  is (totally) protected by  $u$  under  $S$ . A set  $S \subseteq V(G)$  is said to be a secure (total) dominating set if every vertex in  $v \in V(G) \setminus S$  is (totally) protected under  $S$ .

For instance, let  $G$  be the graph shown in Figure 1, and suppose that an observer is stationed at vertex  $a$  and another one is stationed at  $b$ . In such a case, the graph is under the control of the observers, as its vertices are (i.e.,  $\{a, b\}$  is a dominating set). Now, if the observer stationed at vertex  $a$  moves to any vertex in  $\{c, d, e\}$ , then the graph is under the control of the observers as well. In this

case,  $\{a, b\}$  is a secure dominating set. Furthermore, if there are three observers and they are stationed at  $a, b$ , and  $c$ , then every vertex of the graph (including  $a, b$ , and  $c$ ) is under the control of the observers, and this property is preserved if the observer stationed at  $c$  moves to  $d$  or  $e$ . Hence,  $\{a, b, c\}$  is a secure total dominating set.

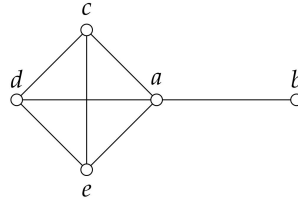

**Figure 1.** In this case,  $\{a\}$  is a dominating set,  $\{a, b\}$  is a total dominating set and also a secure dominating set, while  $\{a, b, c\}$  is a secure total dominating set.

The minimum cardinality among all secure dominating sets of  $G$  is the secure domination number of  $G$ , denoted by  $\gamma_s(G)$ . This domination parameter was introduced by Cockayne et al. in [1] and studied further in a number of works including [12–17]. Now, the minimum cardinality among all secure total dominating sets of  $G$  is the secure total domination number of  $G$ , which is denoted by  $\gamma_{st}(G)$ . This parameter was introduced by Benecke et al. in [2] and studied further in [3,4,16,18,19].

A secure total dominating set of cardinality  $\gamma_{st}(G)$  will be called a  $\gamma_{st}(G)$ -set. A similar agreement will be assumed when referring to optimal sets associated to other parameters used in the article.

The problem of computing  $\gamma_{st}(G)$  is NP-hard [18], even when restricted to chordal bipartite graphs, planar bipartite graphs with arbitrary large girth and maximum degree three, split graphs and graphs of separability at most two. This suggests finding the secure total domination number for special classes of graphs or obtaining tight bounds on this invariant. This is precisely the aim of this article in which we study the case of rooted product graphs.

## 2. Some Notation and Tools

All graphs considered in this paper are finite and undirected, without loops or multiple edges. The minimum degree of a graph  $G$  will be denoted by  $\delta(G)$ , i.e.,  $\delta(G) = \min_{v \in V(G)} |N(v)|$ . As usual, the closed neighbourhood of a vertex  $v \in V(G)$  is denoted by  $N[v] = N(v) \cup \{v\}$ . We say that a vertex  $v \in V(G)$  is a universal vertex if  $N[v] = V(G)$ . By analogy with the notation used for vertices, the open neighbourhood of  $S \subseteq V(G)$  is the set  $N(S) = \cup_{v \in S} N(v)$ , while the closed neighbourhood is the set  $N[S] = N(S) \cup S$ .

A set  $S \subseteq V(G)$  is a double dominating set of  $G$  if  $|N[u] \cap S| \geq 2$  for every  $u \in V(G)$ . The double domination number of  $G$ , denoted by  $\gamma_{\times 2}(G)$ , is the minimum cardinality among all double dominating sets of  $G$ . The  $k$ -domination number of a graph  $G$ , denoted by  $\gamma_k(G)$ , is the cardinality of a smallest set of vertices such that every vertex not in the set is adjacent to at least  $k$  vertices of the set. Such sets are called  $k$ -dominating sets.

**Remark 1.** Every secure total dominating set is a double dominating set and every double dominating set is a 2-dominating set. Therefore, for any graph  $G$  with no isolated vertex,  $\gamma_{st}(G) \geq \gamma_{\times 2}(G) \geq \gamma_2(G)$ .

By Remark 1, for every secure total dominating set  $S$  and every vertex  $v \in S$ , the set  $S \setminus \{v\}$  is a dominating set. Therefore, the following remark holds.

**Remark 2.** For every graph  $G$  with no isolated vertex,  $\gamma_{st}(G) \geq \gamma(G) + 1$ .

A leaf of  $G$  is a vertex of degree one. A support vertex of  $G$  is a vertex which is adjacent to a leaf and a strong support vertex is a support vertex which is adjacent to at least two leaves. A leaf is said to be a

strong leaf if it is adjacent to a strong support vertex, otherwise it is called a weak leaf. The set of leaves, support vertices, strong leaves and weak leaves are denoted by  $\mathcal{L}(G)$ ,  $\mathcal{S}(G)$ ,  $\mathcal{L}_s(G)$ , and  $\mathcal{L}_w(G)$ , respectively.

**Remark 3.** If  $D$  is a secure total dominating set of a graph  $G$ , then  $(\mathcal{S}(G) \cup \mathcal{L}(G)) \subseteq D$  and no vertex of  $G$  is totally protected under  $D$  by vertices in  $\mathcal{S}(G) \cup \mathcal{L}(G)$ .

If  $v$  is a vertex of a graph  $H$ , then the vertex-deletion subgraph  $H - \{v\}$  is the subgraph of  $H$  induced by  $V(H) \setminus \{v\}$ . In Section 3 we will show the importance of  $\gamma_{st}(H - \{v\})$  in the study of the secure total domination number of rooted product graphs. Now we proceed to state some basic tools.

**Lemma 1.** Let  $H$  be a graph with no isolated vertex. If  $v \in V(H) \setminus (\mathcal{L}_w(H) \cup \mathcal{S}(H))$ , then

$$\gamma_{st}(H - \{v\}) \geq \gamma_{st}(H) - 2.$$

Furthermore, if  $\gamma_{st}(H - \{v\}) > \gamma_{st}(H)$ , then  $v$  belongs to every  $\gamma_{st}(H)$ -set.

**Proof.** Assume that  $v \in V(H) \setminus (\mathcal{L}_w(H) \cup \mathcal{S}(H))$  and let  $D$  be a  $\gamma_{st}(H - \{v\})$ -set. Suppose that  $|D| \leq \gamma_{st}(H) - 3$ . If  $|N(v) \cap D| \geq 2$ , then  $D \cup \{v\}$  is a secure total dominating set of  $H$  of cardinality  $|D \cup \{v\}| \leq \gamma_{st}(H) - 2$ , which is a contradiction. Suppose that  $|N(v) \cap D| \leq 1$ . If  $v \notin \mathcal{L}(H)$ , then for every  $y \in N(v) \setminus D$  we have that  $D \cup \{v, y\}$  is a secure total dominating set of  $H$  of cardinality  $|D \cup \{v, y\}| \leq \gamma_{st}(H) - 1$ , which is a contradiction. Now, if  $v \in \mathcal{L}_s(H)$ , then by Remark 3 we can conclude that  $D \cup \{v\}$  is a secure total dominating set of  $H$  of cardinality  $|D \cup \{v\}| \leq \gamma_{st}(H) - 2$ , which is a contradiction again. Hence,  $\gamma_{st}(H - \{v\}) = |D| \geq \gamma_{st}(H) - 2$ .

On the other hand, if there exists a  $\gamma_{st}(H)$ -set  $S$  such that  $v \notin S$ , then  $S$  is a secure total dominating set of  $H - \{v\}$ , and so  $\gamma_{st}(H - \{v\}) \leq |S| = \gamma_{st}(H)$ . Therefore, if  $\gamma_{st}(H - \{v\}) > \gamma_{st}(H)$ , then  $v \in S$  for every  $\gamma_{st}(H)$ -set  $S$ .  $\square$

If  $v$  is a weak leaf of  $H$ , then it could be that  $\gamma_{st}(H) \geq \gamma_{st}(H - \{v\}) + 2$ . For instance, Figure 2 shows the existence of cases in which the gap  $\gamma_{st}(H) - \gamma_{st}(H - \{v\})$  is arbitrarily large. In Remark 4 we highlight this fact.

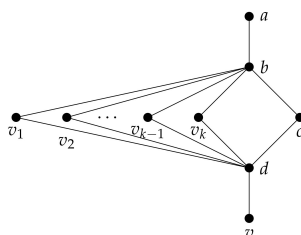

**Figure 2.** A graph  $H$  where  $V(H)$  is the  $\gamma_{st}(H)$ -set. Since  $\{a, b, c, d\}$  forms a  $\gamma_{st}(H - \{v\})$ -set, we have that  $\gamma_{st}(H) - \gamma_{st}(H - \{v\}) = k + 1$  for every integer  $k \geq 1$ .

**Remark 4.** For any integer  $k \geq 1$  there exists a graph  $H$  having a weak leaf vertex  $v$  such that  $\gamma_{st}(H) - \gamma_{st}(H - \{v\}) = k + 1$ .

In contrast to Remark 4, the following result shows the case where  $v$  is a strong leaf.

**Lemma 2.** Let  $H$  be a graph with no isolated vertex. If  $v \in \mathcal{L}_s(H)$ , then

$$\gamma_{st}(H - \{v\}) = \gamma_{st}(H) - 1.$$

**Proof.** Let  $D$  be a  $\gamma_{st}(H)$ -set,  $v \in \mathcal{L}_s(H)$  and  $N(v) = \{s_v\}$ . By Remark 3 we deduce that  $D \setminus \{v\}$  is a secure total dominating set of  $H - \{v\}$  and so  $\gamma_{st}(H - \{v\}) \leq |D \setminus \{v\}| \leq \gamma_{st}(H) - 1$ . Now,

let  $D'$  be a  $\gamma_{st}(H - \{v\})$ -set. Since  $s_v \in \mathcal{S}(H - \{v\})$ , by Remark 3 we have that  $s_v \in D'$  and no vertex of  $H - \{v\}$  is totally protected by  $s_v$  under  $D'$ , which implies that  $D' \cup \{v\}$  is a secure total dominating set of  $H$  and, as a result,  $\gamma_{st}(H) - 1 \leq |D' \cup \{v\}| - 1 = |D'| = \gamma_{st}(H - \{v\})$ . Therefore,  $\gamma_{st}(H - \{v\}) = \gamma_{st}(H) - 1$ .  $\square$

**Lemma 3.** For any graph  $H$  having a universal vertex  $v$ ,

$$\gamma_{st}(H) = \gamma(H - \{v\}) + 1.$$

**Proof.** Let  $D$  be a  $\gamma(H - \{v\})$ -set. Since  $v$  is a universal vertex of  $H$ , it is straightforward that  $D \cup \{v\}$  is a secure total dominating set of  $H$ . Thus,  $\gamma_{st}(H) \leq |D \cup \{v\}| = \gamma(H - \{v\}) + 1$ .

From now on, suppose that  $\gamma_{st}(H) \leq \gamma(H - \{v\})$  and let  $S$  be a  $\gamma_{st}(H)$ -set. We differentiate the following two cases.

Case 1.  $v \in S$ . In this case, as  $|S| \leq \gamma(H - \{v\})$ , we deduce that  $S \setminus \{v\}$  is not a dominating set of  $H - \{v\}$ . Hence, there exists a vertex  $y \in V(H - \{v\})$  such that  $N(y) \cap S = \{v\}$ , which is a contradiction, as  $S$  is a 2-dominating set, by Remark 1.

Case 2.  $v \notin S$ . In this case,  $S$  is a secure total dominating set of  $H - \{v\}$  and so  $\gamma_{st}(H - \{v\}) \leq |S| \leq \gamma(H - \{v\})$ , which is a contradiction with Remark 2.

Therefore, the result follows.  $\square$

### 3. The Case of Rooted Product Graphs

Given a graph  $G$  of order  $n(G)$  and a graph  $H$  with root vertex  $v$ , the rooted product graph  $G \circ_v H$  is defined as the graph obtained from  $G$  and  $H$  by taking one copy of  $G$  and  $n(G)$  copies of  $H$  and identifying the  $i^{\text{th}}$  vertex of  $G$  with the root vertex  $v$  in the  $i^{\text{th}}$  copy of  $H$  for every  $i \in \{1, 2, \dots, n(G)\}$ .

If  $H$  or  $G$  is a trivial graph, then  $G \circ_v H$  is equal to  $G$  or  $H$ , respectively. In this sense, hereafter we will only consider graphs  $G$  and  $H$  of order greater than or equal to two.

For every  $x \in V(G)$ ,  $H_x \cong H$  will denote the copy of  $H$  in  $G \circ_v H$  containing  $x$ . The restriction of any set  $S \subseteq V(G \circ_v H)$  to  $V(H_x)$  will be denoted by  $S_x$ , and the restriction to  $V(H_x - \{x\})$  will be denoted by  $S_x^-$ . Hence,  $V(G \circ_v H) = \cup_{x \in V(G)} V(H_x)$  and for every  $\gamma_{st}(G \circ_v H)$ -set  $S$  we have that

$$\gamma_{st}(G \circ_v H) = |S| = \sum_{x \in V(G)} |S_x| = \sum_{x \in V(G)} |S_x^-| + |S \cap V(G)|.$$

**Theorem 1.** For any graphs  $G$  and  $H$  with no isolated vertex and any  $v \in V(H)$ ,

$$\gamma_{st}(G \circ_v H) \leq n(G)\gamma_{st}(H).$$

Furthermore, if  $v \notin \mathcal{S}(H)$ , then

$$\gamma_{st}(G \circ_v H) \leq \gamma_{st}(G) + n(G)\gamma_{st}(H - \{v\}).$$

**Proof.** Let  $D$  be a  $\gamma_{st}(H)$ -set and  $S \subseteq V(G \circ_v H)$  such that  $S_x$  is the subset of  $V(H_x)$  induced by  $D$  for every  $x \in V(G)$ . Since  $S$  is a secure total dominating set of  $G \circ_v H$ , we deduce that  $\gamma_{st}(G \circ_v H) \leq \sum_{x \in V(G)} |S_x| = n(G)\gamma_{st}(H)$ .

Now, assume that  $v \notin \mathcal{S}(H)$ . Let  $W$  be a  $\gamma_{st}(H - \{v\})$ -set and  $S' \subseteq V(G \circ_v H) \setminus V(G)$  such that  $S'_x$  is the subset of  $V(H_x - \{x\})$  induced by  $W$  for every  $x \in V(G)$ . Since for any  $\gamma_{st}(G)$ -set  $X$ , we have that  $X \cup S'$  is a secure total dominating set of  $G \circ_v H$ , we deduce that  $\gamma_{st}(G \circ_v H) \leq |X \cup S'| = \gamma_{st}(G) + n(G)\gamma_{st}(H - \{v\})$ .  $\square$

We now proceed to analyse three cases in which it is not difficult to give closed formulas for  $\gamma_{st}(G \circ_v H)$ . Specifically, we consider the cases in which the root vertex  $v$  is a support vertex, a strong leaf, or a universal vertex.

**Theorem 2.** *The following statements hold for any graphs  $G$  and  $H$  with no isolated vertex.*

- (i) *If  $v \in \mathcal{S}(H)$ , then  $\gamma_{st}(G \circ_v H) = n(G)\gamma_{st}(H)$ . Furthermore,  $|D_x| = \gamma_{st}(H)$  for every  $\gamma_{st}(G \circ_v H)$ -set  $D$  and every  $x \in V(G)$ .*
- (ii) *If  $v \in V(H)$  is a universal vertex, then  $\gamma_{st}(G \circ_v H) = n(G)\gamma_{st}(H)$ .*
- (iii) *If  $v \in \mathcal{L}_s(H)$ , then  $\gamma_{st}(G \circ_v H) = \gamma(G) + n(G)(\gamma_{st}(H) - 1)$ .*

**Proof.** Let  $D$  be a  $\gamma_{st}(G \circ_v H)$ -set. Let us first consider the case where  $v \in \mathcal{S}(H)$ . Since  $x \in \mathcal{S}(G \circ_v H)$  for every  $x \in V(G)$ , by Remark 3 we deduce that  $D_x$  is a secure total dominating set of  $H_x$ , and as a consequence  $|D_x| \geq \gamma_{st}(H_x)$  for every  $x \in V(G)$ . Hence,  $\gamma_{st}(G \circ_v H) = \sum_{x \in V(G)} |D_x| \geq n(G)\gamma_{st}(H)$ . Now, if  $|D_x| \geq \gamma_{st}(H_x) + 1$  for some  $x \in V(G)$ , then  $\gamma_{st}(G \circ_v H) > n(G)\gamma_{st}(H)$ , which contradicts Theorem 1. Therefore, (i) follows.

Let us now consider the case where  $v \notin \mathcal{S}(H)$  is a universal vertex. Let  $x \in V(G)$ . If  $x \in D_x$ , then  $D_x$  is a secure total dominating set of  $H_x$  and, as a result,  $|D_x| \geq \gamma_{st}(H_x)$ . Now, if  $x \notin D_x$ , then  $D_x^-$  is a secure total dominating set of  $H_x - \{x\}$ , and so Remark 2 and Lemma 3 lead to  $|D_x| \geq \gamma_{st}(H_x - \{x\}) \geq \gamma(H_x - \{x\}) + 1 = \gamma_{st}(H_x)$ . Hence,  $\gamma_{st}(G \circ_v H) = \sum_{x \in V(G)} |D_x| \geq n(G)\gamma_{st}(H)$  and (ii) follows by Theorem 1.

From now on we assume that  $v \in \mathcal{L}_s(H)$ . Let  $s_x \in V(H_x)$  be the support of  $x$  in  $H_x$  for every  $x \in V(G)$ . Since  $x \in \mathcal{L}_s(H_x)$ , we have that  $s_x \in \mathcal{S}(H_x - \{x\}) \cap D$ . Hence, by Remark 3 we deduce that  $D_x^-$  is a secure total dominating set of  $H_x - \{x\}$ , and by Lemma 2 we have that  $|D_x^-| \geq \gamma_{st}(H_x - \{x\}) = \gamma_{st}(H) - 1$ . Moreover, since  $N(x) \cap D_x = \{s_x\}$  for every  $x \in V(G)$ , by Remark 1 it follows that every vertex in  $V(G) \setminus D$  has to have a neighbour in  $V(G) \cap D$ , which implies that  $V(G) \cap D$  is a dominating set of  $G$ . Therefore,  $\gamma_{st}(G \circ_v H) = |D| = |D \cap V(G)| + \left| \bigcup_{x \in V(G)} D_x^- \right| \geq \gamma(G) + n(G)(\gamma_{st}(H) - 1)$ .

It remains to show that  $\gamma_{st}(G \circ_v H) \leq \gamma(G) + n(G)(\gamma_{st}(H) - 1)$ . To this end, let  $X$  be a  $\gamma(G)$ -set,  $Y$  a  $\gamma_{st}(H - \{v\})$ -set, and  $W \subseteq V(G \circ_v H) \setminus V(G)$  such that  $W_x$  is the subset of  $V(H_x - \{x\})$  induced by  $Y$  for every  $x \in V(G)$ . Notice that  $s_x \in W_x$ . In order to show that  $S = X \cup W$  is a secure total dominating set of  $G \circ_v H$ , we only need to observe that every vertex in  $V(G) \setminus S$  is totally protected under  $S$  by any neighbour in  $X$ , while every  $w \in V(H_x) \setminus W_x$  is totally protected under  $S$  by some neighbour in  $W_x$ . Thus,  $\gamma_{st}(G \circ_v H) \leq |S| = \gamma(G) + n(G)\gamma_{st}(H - \{v\})$ , and by Lemma 2 we deduce that  $\gamma_{st}(G \circ_v H) \leq \gamma(G) + n(G)(\gamma_{st}(H) - 1)$ . Therefore, (iii) follows.  $\square$

Given two graphs  $G$  and  $G'$ , the corona graph  $G \odot G'$  can be seen as a rooted product graph  $G \circ_v H$  where  $H$  is the join (The join graph  $G' + G''$  is the graph obtained from  $G'$  and  $G''$  by joining each vertex of  $G'$  to all vertices of  $G''$ ) graph  $K_1 + H$  and  $v$  is the vertex of  $K_1$ . Therefore, Lemma 3 and Theorem 2 (ii) lead to the following result on corona graphs.

**Theorem 3.** *If  $G$  is a graph with no isolated vertex, then for every nontrivial graph  $G'$ ,*

$$\gamma_{st}(G \odot G') = n(G)(\gamma(G') + 1).$$

As we will see later, the behaviour of  $\gamma_{st}(G \circ_v H)$  changes depending on whether the root vertex  $v$  is a weak leaf or not. First we proceed to consider the cases where the root vertex is not a weak leaf.

**Lemma 4.** *Let  $S$  be a  $\gamma_{st}(G \circ_v H)$ -set and  $x \in V(G)$ . If  $v \notin \mathcal{L}_w(H)$ , then the following statements hold.*

- $|S_x| \geq \gamma_{st}(H) - 2$ .
- If  $|S_x| = \gamma_{st}(H) - 2$ , then  $N[x] \cap S_x = \emptyset$ .

**Proof.** Let  $x \in V(G)$ . Notice that every vertex in  $V(H_x) \setminus (S \cup \{x\})$  is totally protected under  $S$  by some vertex in  $S_x$ . Now, suppose that  $|S_x| \leq \gamma_{st}(H) - 3$  and let  $y \in N(x) \cap V(H_x)$ . If  $y \notin S_x$ , then  $S_x \cup \{x, y\}$  is a secure total dominating set of  $H_x$  of cardinality at most  $\gamma_{st}(H) - 1$ , which is a contradiction. Assume that  $N(x) \cap V(H_x) \subseteq S_x$ . If  $N(x) \cap V(H_x) = \{y\}$ , then  $x \in \mathcal{L}_S(H_x)$  and  $y \in S(G \circ_v H)$ . Thus, by Remark 3 no vertex in  $V(H_x)$  is totally protected by  $y$  under  $S$ , and so  $S_x \cup \{x\}$  is a secure total dominating set of  $H_x$  of cardinality at most  $\gamma_{st}(H) - 2$ , which is a contradiction. Finally, if  $|N(x) \cap V(H_x)| \geq 2$ , then  $S_x \cup \{x\}$  is a secure total dominating set of  $H_x$  and, as above, we arrive to a contradiction. Therefore,  $|S_x| \geq \gamma_{st}(H) - 2$ .

Now, assume that  $|S_x| = \gamma_{st}(H) - 2$ . First, suppose that  $x \in S$ . Notice that if  $N(x) \cap V(H_x) \subseteq S_x$ , then  $S_x$  is a secure total dominating set of  $H_x$ , which is a contradiction. Hence, there exists  $y \in (N(x) \cap V(H_x)) \setminus S_x$ , and so  $S_x \cup \{y\}$  is a secure total dominating set of  $H_x$  and  $|S_x \cup \{y\}| = \gamma_{st}(H) - 1$ , which is a contradiction. Thus,  $x \notin S$ . Now, suppose that  $N(x) \cap S_x \neq \emptyset$ . If there exists  $z \in (N(x) \cap V(H_x)) \setminus S_x$ , then  $S_x \cup \{z\}$  is a secure total dominating set of  $H_x$  and  $|S_x \cup \{z\}| = \gamma_{st}(H) - 1$ , which is a contradiction. Now, if  $N(x) \cap V(H_x) \subseteq S_x$ , then one can easily check that  $S_x \cup \{x\}$  is a secure total dominating set of  $H_x$ , which is a contradiction again, as  $|S_x \cup \{x\}| = \gamma_{st}(H) - 1$ . Therefore,  $N(x) \cap V(H_x) \cap S = \emptyset$ .  $\square$

From Lemma 4 we deduce that if  $v \notin \mathcal{L}_w(H)$ , then any  $\gamma_{st}(G \circ_v H)$ -set  $S$  induces a partition  $\{\mathcal{A}_S, \mathcal{B}_S, \mathcal{C}_S\}$  of  $V(G)$  as follows.

$$\begin{aligned} \mathcal{A}_S &= \{x \in V(G) : |S_x| \geq \gamma_{st}(H)\}, \\ \mathcal{B}_S &= \{x \in V(G) : |S_x| = \gamma_{st}(H) - 1\}, \\ \mathcal{C}_S &= \{x \in V(G) : |S_x| = \gamma_{st}(H) - 2\}. \end{aligned}$$

The following corollary is a direct consequence of Theorem 2 (i).

**Corollary 1.** Let  $S$  be a  $\gamma_{st}(G \circ_v H)$ -set. If  $\mathcal{B}_S \cup \mathcal{C}_S \neq \emptyset$ , then  $v \notin \mathcal{S}(H)$ .

**Lemma 5.** Let  $S$  be a  $\gamma_{st}(G \circ_v H)$ -set, where  $v \notin \mathcal{L}_w(H)$ . If  $\mathcal{C}_S \neq \emptyset$ , then  $\gamma_{st}(H - \{v\}) = \gamma_{st}(H) - 2$ .

**Proof.** By Lemma 4, if  $x \in \mathcal{C}_S$ , then  $N[x] \cap S_x = \emptyset$ , which implies that  $S_x^-$  is a secure total dominating set of  $H_x - \{x\}$  of cardinality  $|S_x^-| = |S_x| = \gamma_{st}(H_x) - 2$ . Hence,  $x \notin \mathcal{S}(H_x)$  and  $\gamma_{st}(H_x - \{x\}) \leq |S_x^-| = \gamma_{st}(H_x) - 2$ . Notice that Lemma 2 leads to  $x \notin \mathcal{L}_S(H_x)$ . Thus, by Lemma 1 we conclude that  $\gamma_{st}(H_x - \{x\}) = \gamma_{st}(H_x) - 2$ . Therefore, the result follows.  $\square$

The following result states the intervals in which the secure total domination number of a rooted product graph can be found.

**Theorem 4.** Let  $G$  and  $H$  be two graphs with no isolated vertex. At least one of the following statements holds for every  $v \in V(H) \setminus \mathcal{L}_w(H)$ .

- (i)  $\gamma_{st}(G \circ_v H) = n(G)\gamma_{st}(H)$ .
- (ii)  $n(G)(\gamma_{st}(H) - 1) \leq \gamma_{st}(G \circ_v H) \leq \gamma_{st}(G) + n(G)(\gamma_{st}(H) - 1)$ .
- (iii)  $\gamma_{\times 2}(G) + n(G)(\gamma_{st}(H) - 2) \leq \gamma_{st}(G \circ_v H) \leq \gamma_{st}(G) + n(G)(\gamma_{st}(H) - 2)$ .

**Proof.** Let  $S$  be a  $\gamma_{st}(G \circ_v H)$ -set and consider the partition  $\{\mathcal{A}_S, \mathcal{B}_S, \mathcal{C}_S\}$  of  $V(G)$  defined above. We differentiate the following four cases.

Case 1.  $\mathcal{B}_S \cup \mathcal{C}_S = \emptyset$ . In this case, for any  $x \in V(G)$  we have that  $|S_x| \geq \gamma_{st}(H)$  and, as a consequence,  $\gamma_{st}(G \circ_v H) \geq n(G)\gamma_{st}(H)$ . Thus, Theorem 1 leads to (i).

Case 2.  $\mathcal{B}_S \neq \emptyset$  and  $\mathcal{C}_S = \emptyset$ . In this case, for any  $x \in V(G)$  we have that  $|S_x| \geq \gamma_{st}(H) - 1$  and, as a result,  $\gamma_{st}(G \circ_v H) \geq n(G)(\gamma_{st}(H) - 1)$ .



In order to conclude the proof of (ii), we proceed to show that  $\gamma_{st}(G \circ_v H) \leq \gamma_{st}(G) + n(G)(\gamma_{st}(H) - 1)$ . To this end, we fix  $x' \in \mathcal{B}_S$ ,  $y_{x'} \in V(H_{x'}) \cap N(x')$ , a  $\gamma_{st}(G)$ -set  $D$  and define a subset  $W$  of vertices of  $G \circ_v H$  as follows.

- (a) If  $x' \notin S$ , then for any  $x \in V(G)$  we set  $W \cap V(G) = D$  and  $W_x^-$  is induced by  $S_{x'}^- = S_{x'}$ . It is readily seen that the set  $W$  constructed in this manner is a secure total dominating set of  $G \circ_v H$  and so  $\gamma_{st}(G \circ_v H) \leq |W| = |D| + n(G)|S_{x'}| = \gamma_{st}(G) + n(G)(\gamma_{st}(H) - 1)$ .
- (b) Assume that  $x' \in S$ . If  $x \in V(G) \setminus \mathcal{L}(G)$ , then  $W_x$  is induced by  $S_{x'}$ , while if  $x \in \mathcal{L}(G)$ , then  $W_x$  is induced by  $S_{x'} \cup \{y_{x'}\}$ . It is readily seen that the set  $W$  constructed in this manner is a secure total dominating set of  $G \circ_v H$  and, as a result,  $\gamma_{st}(G \circ_v H) \leq |W| = |\mathcal{L}(G)| + n(G)|S_{x'}| \leq \gamma_{st}(G) + n(G)(\gamma_{st}(H) - 1)$ .

Case 3.  $\mathcal{B}_S = \emptyset$  and  $\mathcal{C}_S \neq \emptyset$ . By Corollary 1,  $v \notin \mathcal{S}(H)$ , and by Lemma 5 we have that  $\gamma_{st}(H - \{v\}) = \gamma_{st}(H) - 2$ . Hence, by Theorem 1 we conclude that  $\gamma_{st}(G \circ_v H) \leq \gamma_{st}(G) + n(G)(\gamma_{st}(H) - 2)$ .

From Lemma 4 we deduce that  $\mathcal{A}_S$  is a 2-dominating set of  $G$ . Hence,  $\gamma_{st}(G \circ_v H) \geq |\mathcal{A}_S|\gamma_{st}(H) + |\mathcal{C}_S|(\gamma_{st}(H) - 2) = 2|\mathcal{A}_S| + n(G)(\gamma_{st}(H) - 2) \geq 2\gamma_2(G) + n(G)(\gamma_{st}(H) - 2) \geq \gamma_{\times 2}(G) + n(G)(\gamma_{st}(H) - 2)$ . Therefore, in this case (iii) holds.

Case 4.  $\mathcal{B}_S \neq \emptyset$  and  $\mathcal{C}_S \neq \emptyset$ . By Corollary 1,  $v \notin \mathcal{S}(H)$ , and by Lemma 5,  $\gamma_{st}(H - \{v\}) = \gamma_{st}(H) - 2$ . Thus, by Theorem 1 we conclude that  $\gamma_{st}(G \circ_v H) \leq \gamma_{st}(G) + n(G)(\gamma_{st}(H) - 2)$ .

In order to conclude that in this case (iii) holds, let us define a double dominating set  $D$  of  $G$  such that  $|D| \leq 2|\mathcal{A}_S| + |\mathcal{B}_S|$ . Set  $D$  has minimum cardinality among the sets satisfying that  $\mathcal{A}_S \cup \mathcal{B}_S \subseteq D$  and for any  $x \in \mathcal{A}_S$ , if  $N(x) \cap \mathcal{C}_S \neq \emptyset$ , then there exists  $x' \in N(x) \cap \mathcal{C}_S \cap D$ . Notice that every vertex in  $\mathcal{A}_S$  is dominated by at least one vertex in  $D$  and, by Lemma 4, every vertex in  $\mathcal{C}_S$  is dominated by at least two vertices in  $\mathcal{A}_S \cup \mathcal{B}_S \subseteq D$ . Furthermore, if there exists one vertex  $x \in \mathcal{B}_S$  such that  $N(x) \cap \mathcal{A}_S \cap \mathcal{B}_S = \emptyset$ , then  $S_x$  is a secure total dominating set of  $H_x$ , which is a contradiction, as  $|S_x| = \gamma_{st}(H_x) - 1$ . Hence,  $D$  is a double dominating set of  $G$ . Therefore,  $\gamma_{st}(G \circ_v H) = |S| \geq |\mathcal{A}_S|\gamma_{st}(H) + |\mathcal{B}_S|(\gamma_{st}(H) - 1) + |\mathcal{C}_S|(\gamma_{st}(H) - 2) \geq |D| + n(G)(\gamma_{st}(H) - 2) \geq \gamma_{\times 2}(G) + n(G)(\gamma_{st}(H) - 2)$ .  $\square$

The bounds given in the previous theorem are tight. To see this, we consider the following examples where  $H_1$  and  $H_2$  are the graphs shown in Figure 3.

- $\gamma_{st}(G \circ_v P_7) = n(G)(\gamma_{st}(P_7) - 1)$ , where  $v$  is the central vertex of  $P_7$  and  $G$  is a graph with  $\delta(G) \geq 2$ .
- $\gamma_{st}(K_r \circ_v H_1) = 2 + r(3 - 1) = \gamma_{st}(K_r) + n(K_r)(\gamma_{st}(H_1) - 1)$ , where  $r \geq 2$ .
- Theorem 5 gives some conditions to achieve the equalities  $\gamma_{st}(G \circ_v H) = \gamma_{st}(G) + n(G)(\gamma_{st}(H) - 2) = \gamma_{\times 2}(G) + n(G)(\gamma_{st}(H) - 2)$ . In this case we can take  $H \cong H_2$ .

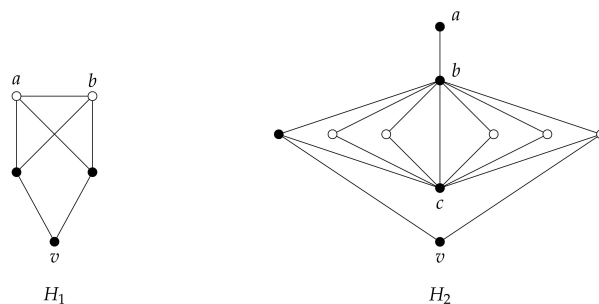

Figure 3. The set of black-coloured vertices forms a  $\gamma_{st}(H_i)$ -set for  $i \in \{1, 2\}$ . The set  $\{a, b\}$  is a  $\gamma_{st}(H_1 - \{v\})$ -set, while  $\{a, b, c\}$  is a  $\gamma_{st}(H_2 - \{v\})$ -set.

We now consider some particular cases in which we impose some additional restrictions on  $G$  and  $H$ . We begin with an immediate consequence of Theorem 4.

**Theorem 5.** Let  $G$  and  $H$  be two graphs with no isolated vertex and  $v \in V(H) \setminus \mathcal{L}_w(H)$ . If  $\gamma_{st}(H - \{v\}) = \gamma_{st}(H) - 2$  and  $\gamma_{st}(G) = \gamma_{\times 2}(G)$ , then

$$\gamma_{st}(G \circ_v H) = \gamma_{st}(G) + n(G)(\gamma_{st}(H) - 2).$$

**Proof.** If  $\gamma_{st}(H - \{v\}) = \gamma_{st}(H) - 2$ , then  $v \notin \mathcal{S}(H)$  and Theorem 1 leads to  $\gamma_{st}(G \circ_v H) \leq \gamma_{st}(G) + n(G)(\gamma_{st}(H) - 2)$ . Thus, by Theorem 4 we conclude that if  $\gamma_{st}(G) = \gamma_{\times 2}(G)$ , then  $\gamma_{st}(G \circ_v H) = \gamma_{st}(G) + n(G)(\gamma_{st}(H) - 2)$ .  $\square$

The following result considers the case in which  $\gamma_{st}(H - \{v\}) \geq \gamma_{st}(H) - 1$ .

**Theorem 6.** Let  $G$  and  $H$  be two graphs with no isolated vertex and  $v \in V(H) \setminus \mathcal{L}_w(H)$ . If  $\gamma_{st}(H - \{v\}) \geq \gamma_{st}(H) - 1$ , then

$$n(G)(\gamma_{st}(H) - 1) \leq \gamma_{st}(G \circ_v H) \leq n(G)\gamma_{st}(H).$$

Now, if  $\delta(G) \geq 2$  and  $\gamma_{st}(H - \{v\}) \geq \gamma_{st}(H)$ , then  $\gamma_{st}(G \circ_v H) = n(G)(\gamma_{st}(H) - 1)$  or  $\gamma_{st}(G \circ_v H) = n(G)\gamma_{st}(H)$ .

**Proof.** Let  $S$  be a  $\gamma_{st}(G \circ_v H)$ -set and assume that  $\gamma_{st}(H - \{v\}) \geq \gamma_{st}(H) - 1$ . By Lemma 5 we have that  $\mathcal{C}_S = \emptyset$ , and so Lemma 4 leads to  $|S_x| \geq \gamma_{st}(H_x) - 1$  for every  $x \in V(G)$ . Thus,  $\gamma_{st}(G \circ_v H) = \sum_{x \in V(G)} |S_x| \geq n(G)(\gamma_{st}(H) - 1)$ . Therefore, Theorem 1 leads to  $n(G)(\gamma_{st}(H) - 1) \leq \gamma_{st}(G \circ_v H) \leq n(G)\gamma_{st}(H)$ .

From now on we assume that  $\delta(G) \geq 2$  and  $\gamma_{st}(H - \{v\}) \geq \gamma_{st}(H)$ . Let us distinguish between two cases, according to whether or not  $\gamma_{st}(H - \{v\}) > \gamma_{st}(H)$ .

Case 1.  $\gamma_{st}(H - \{v\}) > \gamma_{st}(H)$ . We define a set  $D \subseteq V(G \circ_v H)$  as follows. For any  $x \in V(G) \setminus S$  we take  $D \cap V(H_x)$  as a  $\gamma_{st}(H_x)$ -set, while for any  $x \in V(G) \cap S$  we set  $D \cap V(H_x) = S_x$ . Notice that  $D$  is a secure total dominating set of  $G \circ_v H$ . Now, if there exists a vertex  $x \in V(G) \setminus S$ , then the set  $S_x^-$  is a secure total dominating set of  $H_x - \{x\}$ . Hence,  $|S_x| = |S_x^-| \geq \gamma_{st}(H - \{x\}) > \gamma_{st}(H_x) = |D_x|$ , and so  $|D| < |S|$ , which is a contradiction. Thus,  $V(G) \subseteq S$ .

If  $|S_x| \geq \gamma_{st}(H)$  for every  $x \in V(G)$ , then Theorem 1 leads to  $\gamma_{st}(G \circ_v H) = n(G)\gamma_{st}(H)$ . Suppose that there exists a vertex  $x \in V(G)$  such that  $|S_x| \leq \gamma_{st}(H) - 1$ . We define a set  $D' \subseteq V(G \circ_v H)$  as follows. For every  $z \in V(G)$ , the restriction of  $D'$  to  $V(H_z)$  is induced by  $S_x$ . Notice that  $V(G) \subseteq D'$  and, if  $\delta(G) \geq 2$ , then every vertex in  $V(H_z) \setminus D'$  is totally protected under  $D'$  by some vertex in  $D'_z$ , which implies that  $D'$  is a secure total dominating set of  $G \circ_v H$ . Therefore,  $\gamma_{st}(G \circ_v H) \leq |D'| \leq n(G)(\gamma_{st}(H) - 1)$ , concluding that  $\gamma_{st}(G \circ_v H) = n(G)(\gamma_{st}(H) - 1)$ .

Case 2.  $\gamma_{st}(H - \{v\}) = \gamma_{st}(H)$ . First, assume that  $V(G) \cap S = \emptyset$ . Since  $S_x^-$  is a secure total dominating set of  $H_x - \{x\}$  for every  $x \in V(G)$ , we have that  $\gamma_{st}(G \circ_v H) = \sum_{x \in V(G)} |S_x^-| \geq \sum_{x \in V(G)} \gamma_{st}(H - \{x\}) = n(G)\gamma_{st}(H - \{v\}) = n(G)\gamma_{st}(H)$ , and so Theorem 1 leads to  $\gamma_{st}(G \circ_v H) = n(G)\gamma_{st}(H)$ .

Now, assume that there exists  $y \in V(G) \cap S$ . Notice that Lemma 5 leads to  $\mathcal{C}_S = \emptyset$ . Hence,  $y \in \mathcal{A}_S \cup \mathcal{B}_S$ . If  $y \in \mathcal{B}_S$ , we define a set  $D' \subseteq V(G \circ_v H)$  as follows. For every  $z \in V(G)$ , the restriction of  $D'$  to  $V(H_z)$  is induced by  $S_y$ . As in Case 1, we deduce that  $D'$  is a secure total dominating set of  $G \circ_v H$  and so we can conclude that  $\gamma_{st}(G \circ_v H) = |D'| = n(G)(\gamma_{st}(H) - 1)$ . Finally, if  $\mathcal{B}_S = \emptyset$ , then  $V(G) = \mathcal{A}_S$  and by Theorem 1 we conclude that  $\gamma_{st}(G \circ_v H) = |S| = n(G)\gamma_{st}(H)$ .  $\square$

Now, we consider a particular case in which  $\gamma_{st}(H - \{v\}) = \gamma_{st}(H)$ .

**Theorem 7.** Let  $G$  be a graph with no isolated vertex. Let  $H$  be a graph and  $v \in V(H)$  such that  $\gamma_{st}(H - \{v\}) = \gamma_{st}(H)$ . If  $v \notin S$  for every  $\gamma_{st}(H)$ -set  $S$ , then

$$\gamma_{st}(G \circ_v H) = n(G)\gamma_{st}(H).$$

**Proof.** Assume that  $v \notin S$  for every  $\gamma_{st}(H)$ -set  $S$ . Notice that  $v \notin \mathcal{L}(H) \cup \mathcal{S}(H)$ . Let  $D$  be a  $\gamma_{st}(G \circ_v H)$ -set. By Lemma 5 we conclude that  $\mathcal{C}_D = \emptyset$ . Now, if  $\mathcal{B}_D = \emptyset$ , then by analogy to Case 1 in the proof of Theorem 4 it follows that  $\gamma_{st}(G \circ_v H) = n(G)\gamma_{st}(H)$ .

Suppose that there exists a vertex  $x \in \mathcal{B}_D$ . If  $x \notin D$ , then  $D_x^-$  is a secure total dominating set of  $H_x - \{x\}$ , which implies that  $\gamma_{st}(H - \{v\}) = \gamma_{st}(H_x - \{x\}) \leq |D_x^-| = |D_x| = \gamma_{st}(H) - 1$ , which is a contradiction. Hence,  $x \in D$ . Now, if  $N(x) \cap V(H_x) \subseteq D$ , then  $D_x$  is a secure total dominating set of  $H_x$  and so  $\gamma_{st}(H_x) \leq |D_x| = \gamma_{st}(H_x) - 1$ , which is a contradiction. Finally, if there exists  $x' \in N(x) \cap V(H_x) \setminus D$ , then  $D'_x = D_x \cup \{x'\}$  is a secure total dominating set of  $H_x$  of cardinality  $\gamma_{st}(H_x)$  and  $x \in D'_x$ , which is a contradiction again. Therefore,  $\mathcal{B}_D = \emptyset$ , and we are done.  $\square$

*The Case in Which the Root Vertex Is a Weak Leaf*

The first part of this section is devoted to the case in which the support vertex of the root  $v$  has degree greater than or equal to three. From Remark 4 we learned that if  $v \in \mathcal{L}_w(H)$ ,  $N(v) = \{s\}$  and  $|N(s)| \geq 3$ , then the gap  $\gamma_{st}(H) - \gamma_{st}(H - \{v\})$  could be arbitrarily large.

**Remark 5.** Let  $H$  be a graph with no isolated vertex,  $v \in \mathcal{L}_w(H)$  and  $N(v) = \{s\}$ . If  $|N(s)| \geq 3$ , then

$$\gamma_{st}(H) \geq \gamma_{st}(H - \{v\}).$$

**Proof.** Let  $S$  be a  $\gamma_{st}(H)$ -set. By Remark 3, we have that  $v, s \in S$ . If  $N(s) \subseteq S$ , then since  $|N(s)| \geq 3$ , we deduce  $S \setminus \{v\}$  is a secure total dominating set of  $H - \{v\}$ . Hence,  $\gamma_{st}(H - \{v\}) \leq |S \setminus \{v\}| < \gamma_{st}(H)$ . Now, if there exists  $u \in N(s) \setminus S$ , then  $(S \setminus \{v\}) \cup \{u\}$  is also a secure total dominating set of  $H - \{v\}$ . Thus,  $\gamma_{st}(H - \{v\}) \leq |(S \setminus \{v\}) \cup \{u\}| = \gamma_{st}(H)$ . Therefore, the result follows.  $\square$

By Remarks 4 and 5, it seems reasonable to express  $\gamma_{st}(G \circ_v H)$  in terms of  $\gamma_{st}(H - \{v\})$  rather than  $\gamma_{st}(H)$ . To this end, we consider the following lemma.

**Lemma 6.** Let  $S$  be a  $\gamma_{st}(G \circ_v H)$ -set. If  $v \in \mathcal{L}_w(H)$ ,  $N(v) = \{s\}$  and  $|N(s)| \geq 3$ , then  $|S_x| \geq \gamma_{st}(H - \{v\})$  for every  $x \in V(G)$

**Proof.** Let  $x \in V(G)$ . Notice that every vertex in  $V(H_x) \setminus (S \cup \{x\})$  is totally protected under  $S$  by some vertex in  $S_x$ . Now, suppose that  $|S_x| < \gamma_{st}(H - \{v\})$  and let  $N(x) \cap V(H_x) = \{s_x\}$ . If  $x \notin S$ , then  $S_x^-$  is a secure total dominating set of  $H_x - \{x\}$ , which is a contradiction as  $|S_x^-| = |S_x| < \gamma_{st}(H - \{v\}) = \gamma_{st}(H_x - \{x\})$ . Hence,  $x \in S$ . Now, if  $N(s_x) \subseteq S$ , then we set  $S' = (S_x \setminus \{x\}) \cup \{s_x\}$  and otherwise we set  $S' = (S_x \setminus \{x\}) \cup \{w\}$  for any  $w \in N(s_x) \setminus S$ . In both cases,  $S'$  is a secure total dominating set of  $H_x - \{x\}$  and  $\gamma_{st}(H_x - \{x\}) - 1 > |S_x| - 1 \geq |S'| \geq \gamma_{st}(H_x - \{x\})$ , which is a contradiction. Therefore,  $|S_x| \geq \gamma_{st}(H - \{v\})$ .  $\square$

By Theorem 1 and Lemma 6, we deduce the next result.

**Theorem 8.** Let  $G$  and  $H$  be two graphs with no isolated vertex. If  $v \in \mathcal{L}_w(H)$ ,  $N(v) = \{s\}$  and  $|N(s)| \geq 3$ , then

$$n(G)\gamma_{st}(H - \{v\}) \leq \gamma_{st}(G \circ_v H) \leq \min\{n(G)\gamma_{st}(H), \gamma_{st}(G) + n(G)\gamma_{st}(H - \{v\})\}.$$

The following result is an immediate consequence of the theorem above.

**Corollary 2.** Let  $G$  and  $H$  be two graphs with no isolated vertex. Let  $v \in \mathcal{L}_w(H)$  and  $N(v) = \{s\}$ . If  $|N(s)| \geq 3$  and  $\gamma_{st}(H - \{v\}) = \gamma_{st}(H)$ , then

$$\gamma_{st}(G \circ_v H) = n(G)\gamma_{st}(H).$$

**Theorem 9.** Let  $G$  be a graph with  $\delta(G) \geq 2$  and  $H$  a graph with no isolated vertex. Let  $v \in \mathcal{L}_w(H)$  and  $N(v) = \{s\}$ . If  $|N(s)| \geq 3$  and  $N(s) \cap \mathcal{S}(H) \neq \emptyset$ , then the following statements hold.

(i) If  $s \notin D$  for every  $\gamma_{st}(H - \{v\})$ -set  $D$ , then

$$\gamma_{st}(G \circ_v H) = \gamma_{st}(G) + n(G)\gamma_{st}(H - \{v\}).$$

(ii) If there exists a  $\gamma_{st}(H - \{v\})$ -set  $D$  such that  $s \in D$ , then

$$\gamma_{st}(G \circ_v H) \in \{n(G)\gamma_{st}(H - \{v\}), \gamma(G) + n(G)\gamma_{st}(H - \{v\}), \gamma_t(G) + n(G)\gamma_{st}(H - \{v\})\}.$$

**Proof.** Let  $S$  be a  $\gamma_{st}(G \circ_v H)$ -set such that  $|S \cap N[V(G)]|$  is maximum. For any vertex  $x \in V(G)$ , let  $\{s_x\} = N(x) \cap V(H_x)$ . Let  $\{\mathcal{M}_0, \mathcal{M}_1, \mathcal{N}_0, \mathcal{N}_1\}$  be the partition of  $V(G)$  defined as follows.

$$\mathcal{M}_0 = \{x \in V(G) \setminus S : s_x \in S\}, \quad \mathcal{M}_1 = \{x \in V(G) \cap S : s_x \in S\},$$

$$\mathcal{N}_0 = \{x \in V(G) \setminus S : s_x \notin S\}, \quad \mathcal{N}_1 = \{x \in V(G) \cap S : s_x \notin S\}.$$

By Theorem 1 we have that  $\gamma_{st}(G \circ_v H) \leq \gamma_{st}(G) + n(G)\gamma_{st}(H - \{v\})$ . Hence, in order to prove (i) we proceed to show that  $\gamma_{st}(G \circ_v H) \geq \gamma_{st}(G) + n(G)\gamma_{st}(H - \{v\})$ . To this end, we need to estimate the gap  $|S_x| - \gamma_{st}(H - \{v\})$ . Obviously, if  $x \in \mathcal{N}_0$ , then  $|S_x| = \gamma_{st}(H - \{v\})$ . Now, since  $N(s_x) \cap \mathcal{S}(H_x) \neq \emptyset$ , if  $x \in \mathcal{M}_0 \cup \mathcal{M}_1$ , then  $S_x^-$  is a secure total dominating set of  $H_x - \{x\}$ , and so  $|S_x^-| \geq \gamma_{st}(H_x - \{x\}) = \gamma_{st}(H - \{v\})$ . By hypothesis of (i) we deduce that, if  $x \in \mathcal{M}_0$ , then  $|S_x| \geq |S_x^-| > \gamma_{st}(H - \{v\})$ , while if  $x \in \mathcal{M}_1$ , then  $|S_x| > |S_x^-| > \gamma_{st}(H - \{v\})$ . We now consider the case  $x \in \mathcal{N}_1$ . By Lemma 6 we have that  $|S_x| \geq \gamma_{st}(H - \{v\})$ . If  $|S_x| = \gamma_{st}(H - \{v\})$ , then  $S_x^- \cup \{s_x\}$  is a secure total dominating set of  $H_x - \{x\}$  and  $|S_x^- \cup \{s_x\}| = |S_x| = \gamma_{st}(H - \{v\}) = \gamma_{st}(H_x - \{x\})$ , which contradicts the hypothesis of (i). Hence,  $x \in \mathcal{N}_1$  leads to  $|S_x| > \gamma_{st}(H - \{v\})$ .

In summary, we can conclude that if  $x \in \mathcal{N}_0$ , then  $|S_x| = \gamma_{st}(H - \{v\})$ , if  $x \in \mathcal{M}_0 \cup \mathcal{N}_1$ , then  $|S_x| \geq \gamma_{st}(H - \{v\}) + 1$ , while if  $x \in \mathcal{M}_1$ , then  $|S_x| \geq \gamma_{st}(H - \{v\}) + 2$ . We claim that there exists a secure total dominating set  $Z$  of  $G$  such that  $|Z| \leq |\mathcal{N}_1| + |\mathcal{M}_0| + 2|\mathcal{M}_1|$ .

We define  $Z$  as a set of minimum cardinality satisfying that  $\mathcal{N}_1 \cup \mathcal{M}_0 \cup \mathcal{M}_1 \subseteq Z$  and for any  $x \in \mathcal{M}_1$  with  $N(x) \cap \mathcal{N}_0 \neq \emptyset$  there exists  $w_x \in N(x) \cap \mathcal{N}_0 \cap Z$ . Notice that, by definition,  $Z$  is a double dominating set of  $G$  and, since  $\delta(G) \geq 2$ , every vertex in  $\mathcal{M}_1$  has at least two neighbours in  $Z \setminus \mathcal{N}_0$  or one neighbour in  $Z \cap \mathcal{N}_0$ . Let  $x \in V(G) \setminus Z$ . Since  $x \in \mathcal{N}_0$ , there exists  $y \in S \cap V(G) = \mathcal{M}_1 \cap \mathcal{N}_1 \subseteq Z$  such that  $x$  is totally protected under  $S$  by  $y$ . We claim that  $Z' = (Z \setminus \{y\}) \cup \{x\}$  is a total dominating set of  $G$ . Since  $Z$  is a total dominating set of  $G$ , we have that every vertex in  $V(G) \setminus N(y)$  is dominated by some vertex in  $Z'$ . Now, if there exists  $u \in N(y) \cap V(G)$  such that  $N(u) \cap S \cap V(G) = \{y\}$ , then  $u \in \mathcal{M}_1$ , and so  $N(u) \cap Z \cap \mathcal{N}_0 \neq \emptyset$ , concluding that  $Z'$  is a total dominating set of  $G$ . Hence,  $Z$  is a secure total dominating set of  $G$ , and as a consequence,

$$\begin{aligned} \gamma_{st}(G \circ_v H) &= \sum_{x \in V(G)} |S_x| \\ &= \sum_{x \in \mathcal{M}_1} |S_x| + \sum_{x \in \mathcal{M}_0} |S_x| + \sum_{x \in \mathcal{N}_1} |S_x| + \sum_{x \in \mathcal{N}_0} |S_x| \\ &\geq \sum_{x \in \mathcal{M}_1} (\gamma_{st}(H - \{v\}) + 2) + \sum_{x \in \mathcal{M}_0 \cup \mathcal{N}_1} (\gamma_{st}(H - \{v\}) + 1) + \sum_{x \in \mathcal{N}_0} \gamma_{st}(H - \{v\}) \\ &= \sum_{x \in V(G)} \gamma_{st}(H - \{v\}) + (2|\mathcal{M}_1| + |\mathcal{M}_0| + |\mathcal{N}_1|) \\ &\geq \sum_{x \in V(G)} \gamma_{st}(H - \{v\}) + |Z| \\ &\geq n(G)\gamma_{st}(H - \{v\}) + \gamma_{st}(G). \end{aligned}$$

Therefore, proof of (i) is complete.

We now proceed to prove (ii). From Lemma 6 we can consider the partition  $\{R_0, R_1\}$  of  $V(G)$  defined as follows.

$$R_0 = \{x \in V(G) : |S_x| = \gamma_{st}(H - \{v\})\}, \quad R_1 = \{x \in V(G) : |S_x| > \gamma_{st}(H - \{v\})\}.$$

By assumptions, there exists a  $\gamma_{st}(H - \{v\})$ -set  $D$  such that  $s \in D$ . Let  $W \subseteq V(G \circ_v H) \setminus V(G)$  such that  $W_x$  is induced by  $D$  for every vertex  $x \in V(G)$ .

If  $x \in \mathcal{N}_0$ , then  $S' = (S \setminus S_x) \cup W_x$  is a  $\gamma_{st}(G \circ_v H)$ -set with  $|S' \cap N[V(G)]| > |S \cap N[V(G)]|$ , which is a contradiction. Hence,  $\mathcal{N}_0 = \emptyset$ . If  $x \in R_1 \cap \mathcal{N}_1$ , then  $S' = (S \setminus S_x) \cup (W_x \cup \{x\})$  is a  $\gamma_{st}(G \circ_v H)$ -set with  $|S' \cap N[V(G)]| > |S \cap N[V(G)]|$ , which is a contradiction. Hence,  $R_1 \cap \mathcal{N}_1 = \emptyset$ , and so  $\mathcal{N}_1 \subseteq R_0$ . Now, by hypothesis of (ii),  $\mathcal{M}_0 \subseteq R_0$ . Moreover, if  $x \in \mathcal{M}_1$ , then  $S_x^-$  is a secure total dominating set of  $H_x - \{x\}$ , and so  $x \in R_1$ . Therefore,  $R_1 = \mathcal{M}_1$  and  $R_0 = \mathcal{M}_0 \cup \mathcal{N}_1$ .

Now, we suppose that there exists a vertex  $x' \in \mathcal{N}_1$ . Let  $W' \subseteq V(G \circ_v H)$  such that  $W'_x$  is induced by  $S_{x'}$  for every vertex  $x \in V(G)$ . Since  $\delta(G) \geq 2$  we have that  $W'$  is a secure total dominating set of  $G \circ_v H$  of cardinality  $n(G)\gamma_{st}(H - \{v\})$ . Therefore,  $\gamma_{st}(G \circ_v H) \leq n(G)\gamma_{st}(H - \{v\})$  and by Theorem 8, we deduce that  $\gamma_{st}(G \circ_v H) = n(G)\gamma_{st}(H - \{v\})$ .

From now on, we assume that  $\mathcal{N}_1 = \emptyset$ . Hence,  $R_1 = \mathcal{M}_1$  and  $R_0 = \mathcal{M}_0$ . Let  $x \in \mathcal{M}_1$ . As  $N(s_x) \cap S(H_x) \neq \emptyset$ , we have that  $S_x^-$  is a secure total dominating set of  $H_x - \{x\}$ , and by hypothesis of (ii) we deduce that  $|S_x^-| = \gamma_{st}(H - \{v\})$ , which implies that  $|S_x| = \gamma_{st}(H - \{v\}) + 1$ . Hence,  $\gamma_{st}(G \circ_v H) = |\mathcal{M}_1| + n(G)\gamma_{st}(H - \{v\})$ .

Since  $V(G) = \mathcal{M}_0 \cup \mathcal{M}_1$  and  $\mathcal{M}_0 \cap \mathcal{M}_1 = \emptyset$ , by Remark 1, any vertex in  $\mathcal{M}_0$  is dominated by at least one vertex in  $\mathcal{M}_1$ . Hence,  $\mathcal{M}_1$  is a dominating set of  $G$  and we differentiate the following two cases.

Case 1. There exists a  $\gamma_{st}(H - \{v\})$ -set  $D$  containing  $s$ , such that no vertex in  $N(s) \setminus D$  is necessarily totally protected by  $s$  under  $D$ . Let  $W'' \subseteq V(G \circ_v H) \setminus V(G)$  such that  $W''_x$  is induced by  $D$  for every vertex  $x \in V(G)$ . In this case, for every  $\gamma(G)$ -set  $X$  we have that  $X \cup W''$  is a secure total dominating set of  $G \circ_v H$ . Hence  $|\mathcal{M}_1| = \gamma(G)$ , and as a consequence,  $\gamma_{st}(G \circ_v H) = \gamma(G) + n(G)\gamma_{st}(H - \{v\})$ .

Case 2. For every  $\gamma_{st}(H - \{v\})$ -set  $D$  containing  $s$ , there exists a vertex in  $V(H) \setminus D$  that is totally protected uniquely by  $s$  under  $D$ . In this case, any vertex in  $\mathcal{M}_1$  is dominated by another vertex in  $\mathcal{M}_1$ , which implies that  $\mathcal{M}_1$  is a total dominating set of  $G$ . As in Case 1, let  $W'' \subseteq V(G \circ_v H) \setminus V(G)$  such that  $W''_x$  is induced by  $D$  for every vertex  $x \in V(G)$ . In this case, for every  $\gamma_t(G)$ -set  $X$  we have that  $X \cup W''$  is a secure total dominating set of  $G \circ_v H$ . Hence  $|\mathcal{M}_1| = \gamma_t(G)$ . Therefore,  $\gamma_{st}(G \circ_v H) = \gamma_t(G) + n(G)\gamma_{st}(H - \{v\})$ .  $\square$

From now on we consider the case in which the support vertex of the root  $v$  has degree two.

**Lemma 7.** Let  $H$  be a graph with no isolated vertex. If  $v \in \mathcal{L}_w(H)$ ,  $N(v) = \{s\}$  and  $|N(s)| = 2$ , then  $\gamma_{st}(H - \{v\}) \geq \gamma_{st}(H) - 1$ .

**Proof.** Suppose that  $\gamma_{st}(H - \{v\}) \leq \gamma_{st}(H) - 2$  and let  $D$  be a  $\gamma_{st}(H - \{v\})$ -set. Since both  $s$  and its support vertex in  $H - \{v\}$  are included in  $D$ , we have that  $D \cup \{v\}$  is a secure total dominating set of  $H$ . Hence,  $\gamma_{st}(H) \leq |D \cup \{v\}| = \gamma_{st}(H - \{v\}) + 1 \leq \gamma_{st}(H) - 1$ , which is a contradiction. Therefore,  $\gamma_{st}(H - \{v\}) \geq \gamma_{st}(H) - 1$ , which completes the proof.  $\square$

**Theorem 10.** Let  $S$  be a  $\gamma_{st}(G \circ_v H)$ -set. If  $v \in \mathcal{L}_w(H)$ ,  $N(v) = \{s\}$  and  $|N(s)| = 2$ , then for any  $x \in V(G)$ ,

$$\gamma_{st}(H) - 1 \leq |S_x| \leq \gamma_{st}(H).$$

Therefore, with the assumptions above,

$$n(G)(\gamma_{st}(H) - 1) \leq \gamma_{st}(G \circ_v H) \leq n(G)\gamma_{st}(H).$$

**Proof.** We first consider the case in which  $S_x$  is a secure total dominating set of  $H_x$ . Since  $x \in \mathcal{L}(H_x)$  we have that  $x$  belongs to every  $\gamma_{st}(H_x)$ -set. So,  $|S_x| = \gamma_{st}(H_x) = \gamma_{st}(H)$ .

Now, assume that  $S_x$  is not a secure total dominating set of  $H_x$ . Notice that every vertex in  $V(H_x) \setminus (S \cup \{x\})$  is totally protected under  $S$  by some vertex in  $S_x$ . Since  $\{x, s_x\} \cap S_x \neq \emptyset$ , we have that  $S_x \cup \{x, s_x\}$  is a secure total dominating set of  $H_x$ . Hence,  $\gamma_{st}(H) - 1 = \gamma_{st}(H_x) - 1 \leq |S_x \cup \{x, s_x\}|$

$\{x, s_x\} - 1 \leq |S_x|$ . Now, if there exists  $x' \in V(G)$  such that  $|S_{x'}| > \gamma_{st}(H)$ , then for any  $\gamma_{st}(H_{x'})$ -set  $D$ , we have that  $S' = (S \setminus S_{x'}) \cup D$  is a secure total dominating set of  $G \circ_v H$  and  $|S'| < |S|$ , which is a contradiction. Therefore,  $\gamma_{st}(H) - 1 \leq |S_x| \leq \gamma_{st}(H)$  for every  $x \in V(G)$ , and since  $\gamma_{st}(G \circ_v H) = \sum_{x \in V(G)} |S_x|$ , the result follows.  $\square$

We now consider the particular case where  $\delta(G) \geq 2$ . By Lemma 7 we only need to consider two cases according to whether  $\gamma_{st}(H - \{v\}) \geq \gamma_{st}(H)$  or  $\gamma_{st}(H - \{v\}) = \gamma_{st}(H) - 1$ . These two cases are discussed in Theorems 11 and 12, respectively.

**Theorem 11.** *Let  $G$  be a graph with  $\delta(G) \geq 2$  and  $H$  a graph with no isolated vertex. Let  $v \in \mathcal{L}_w(H)$ ,  $N(v) = \{s\}$  and  $|N(s)| = 2$ . If  $\gamma_{st}(H - \{v\}) \geq \gamma_{st}(H)$ , then*

$$\gamma_{st}(G \circ_v H) \in \{n(G)\gamma_{st}(H), n(G)(\gamma_{st}(H) - 1)\}.$$

**Proof.** Let  $S$  be a  $\gamma_{st}(G \circ_v H)$ -set such that  $|S| < n(G)\gamma_{st}(H)$ . For any vertex  $x \in V(G)$ , let  $\{s_x\} = N(x) \cap V(H_x)$  and  $\{s'_x\} = N(s_x) \setminus \{x\}$ . By Theorem 10 there exists a vertex  $y \in V(G)$  such that  $|S_y| = \gamma_{st}(H) - 1$ . If  $y \notin S_y$ , then  $S_y^-$  is a secure total dominating set of  $H_y - \{y\}$  and so  $|S_y^-| = |S_y| = \gamma_{st}(H) - 1 < \gamma_{st}(H - \{v\}) = \gamma_{st}(H_y - \{y\})$ , which is a contradiction. Hence,  $y \in S_y$ .

We suppose that  $s_y \in S_y$ . Since  $|S_y| = \gamma_{st}(H) - 1$ , we deduce that  $s'_y \notin S_y$ . So, the set  $D = (S_y \setminus \{y\}) \cup \{s'_y\}$  is a secure total dominating set of  $H_y - \{y\}$  of cardinality  $|D| = |S_y| = \gamma_{st}(H) - 1 < \gamma_{st}(H - \{v\}) = \gamma_{st}(H_y - \{y\})$ , which is a contradiction. Hence,  $s_y \notin S_y$ , and so  $s'_y \in S_y$ .

Let  $W \subseteq V(G \circ_v H)$  such that  $W_x$  is induced by  $S_y$ , for any  $x \in V(G)$ . Since  $\delta(G) \geq 2$ , we deduce that  $W$  is a secure total dominating set of  $G \circ_v H$ , and, as a result,  $\gamma_{st}(G \circ_v H) \leq |W| = n(G)|S_y| = n(G)(\gamma_{st}(H) - 1)$ . By Theorem 10 we obtain that  $\gamma_{st}(G \circ_v H) = n(G)(\gamma_{st}(H) - 1)$ , which completes the proof.  $\square$

**Theorem 12.** *Let  $G$  be a graph with  $\delta(G) \geq 2$  and  $H$  a graph with no isolated vertex. Let  $v \in \mathcal{L}_w(H)$ ,  $N(v) = \{s\}$  and  $|N(s)| = 2$ . If  $\gamma_{st}(H - \{v\}) = \gamma_{st}(H) - 1$ , then*

$$\gamma_{st}(G \circ_v H) \in \{n(G)(\gamma_{st}(H) - 1), \gamma(G) + n(G)(\gamma_{st}(H) - 1)\}.$$

**Proof.** By Theorem 10 we have that  $\gamma_{st}(G \circ_v H) \geq n(G)(\gamma_{st}(H) - 1)$ . Since  $s \in \mathcal{L}(H - \{v\})$ , any  $\gamma_{st}(H - \{v\})$ -set  $D$  contains  $N[s] \setminus \{v\}$  as a subset. Let  $W \subseteq V(G \circ_v H) \setminus V(G)$  such that  $W_x$  is induced by  $D$  for every vertex  $x \in V(G)$ . As for any  $\gamma(G)$ -set  $X$ , the set  $X \cup W$  is a secure total dominating set of  $G \circ_v H$ , we deduce that  $\gamma_{st}(G \circ_v H) \leq |X \cup W| = \gamma(G) + n(G)\gamma_{st}(H - \{v\}) = \gamma(G) + n(G)(\gamma_{st}(H) - 1)$ .

Let  $S$  be a  $\gamma_{st}(G \circ_v H)$ -set such that  $|S| > n(G)(\gamma_{st}(H) - 1)$ . For any vertex  $x \in V(G)$ , let  $\{s_x\} = N(x) \cap V(H_x)$ . By Theorem 10, we can conclude that the set  $Z = \{z \in V(G) : |S_z| = \gamma_{st}(H)\}$  is not empty. Since there exists a  $\gamma_{st}(H)$ -set containing  $N[s]$ , we can assume, without loss of generality, that  $N[s_z] \subseteq S_z$  for every vertex  $z \in Z$ . We claim that  $Z$  is a dominating set of  $G$ . Let  $x' \in V(G) \setminus Z$  and suppose that  $x' \in S$ . In such a case,  $|S_{x'}| = \gamma_{st}(H) - 1$  and we can define a set  $W' \subseteq V(G \circ_v H)$  such that  $W'_x$  is induced by  $S_{x'}$  for every vertex  $x \in V(G)$ . Notice that  $W$  is a secure total dominating set of  $G \circ_v H$  and  $|W| = n(G)(\gamma_{st}(H) - 1)$ , which is a contradiction. Thus,  $(V(G) \setminus Z) \cap S = \emptyset$ , which implies that  $Z$  is a dominating set of  $G$  and so  $\gamma_{st}(G \circ_v H) = |S| \geq |\cup_{x \in V(G)} S_x| = |Z| + n(G)(\gamma_{st}(H) - 1) \geq \gamma(G) + n(G)(\gamma_{st}(H) - 1)$ , which completes the proof.  $\square$

**Theorem 13.** *Let  $G$  be a graph such that  $\delta(G) \geq 2$  and  $H$  a graph with no isolated vertex. If  $v \in \mathcal{L}_w(H)$ ,  $N(v) = \{s\}$ ,  $|N(s)| = 2$  and  $N(s) \cap \mathcal{S}(H) \neq \emptyset$ , then*

$$\gamma_{st}(G \circ_v H) = n(G)(\gamma_{st}(H) - 1).$$

**Proof.** For any vertex  $x \in V(G)$ , let  $\{s_x\} = N(x) \cap V(H_x)$  and notice that any  $\gamma_{st}(H_x)$ -set  $D_x$  satisfies that  $N[s_x] \subseteq D_x$  and  $D_x \setminus \{x, s_x\}$  is a secure total dominating set of  $H_x - \{x, s_x\}$ . Since  $\delta(G) \geq 2$ , we have that  $D = \bigcup_{x \in V(G)} (D_x \setminus \{s_x\})$  is a secure total dominating set of  $G \circ_v H$ . Hence,  $\gamma_{st}(G \circ_v H) \leq |D| = n(G)(\gamma_{st}(H) - 1)$ . By Theorem 10 we obtain that  $\gamma_{st}(G \circ_v H) = n(G)(\gamma_{st}(H) - 1)$ , which completes the proof.  $\square$

#### 4. Concluding Remarks

It is well-known that the problem of finding the secure total domination number of a graph is NP-hard. This suggests the challenge of finding closed formulas or giving tight bounds for this parameter. In this paper we develop the theory for the class of rooted product graph. The study shows that if the root vertex is strong leaf, a support, or a universal vertex, then there exists a formula for the secure total domination number of the rooted product graph. In the remaining cases, two different behaviours are observed depending on whether the root vertex is a weak leaf or not. Although in a different way, in both cases we were able to give the intervals to which the parameter belongs. The endpoints of these intervals are expressed in terms of other domination parameters of the graphs  $G$  and  $H$  involved in the product, which allows us to obtain closed formulas when certain conditions are imposed on  $G$  or  $H$ .

**Author Contributions:** All authors contributed equally to this work. All authors have read and agreed to the published version of the manuscript.

**Funding:** This research received no external funding.

**Conflicts of Interest:** The authors declare no conflict of interest.

#### References

1. Cockayne, E.J.; Grobler, P.J.P.; Gründlingh, W.R.; Munganga, J.; Van Vuuren, J.H. Protection of a graph. *Util. Math.* **2005**, *67*, 19–32.
2. Benecke, S.; Cockayne, E.J.; Mynhardt, C.M. Secure total domination in graphs. *Util. Math.* **2007**, *74*, 247–259.
3. Cabrera Martínez, A.; Montejano, L.P.; Rodríguez-Velázquez, J.A. On the secure total domination number of graphs. *Symmetry* **2019**, *11*, 1165. [[CrossRef](#)]
4. Cabrera Martínez, A.; Montejano, L.P.; Rodríguez-Velázquez, J.A. Total weak Roman domination in graphs. *Symmetry* **2019**, *11*, 831. [[CrossRef](#)]
5. Henning, M.A.; Hedetniemi, S.T. Defending the Roman Empire—A new strategy. *Discrete Math.* **2003**, *266*, 239–251. [[CrossRef](#)]
6. Cockayne, E.J.; Dreyer, P.A., Jr.; Hedetniemi, S.M.; Hedetniemi, S.T. Roman domination in graphs. *Discrete Math.* **2004**, *278*, 11–22. [[CrossRef](#)]
7. Stewart, I. *Defend the Roman Empire!*. Scientific American: New York, NY, USA, 1999; Volume 281, pp. 136–138.
8. Haynes, T.W.; Hedetniemi, S.T.; Slater, P.J. *Domination in Graphs: Advanced Topics.*; Chapman and Hall/CRC Pure and Applied Mathematics Series; Marcel Dekker, Inc.: New York, NY, USA, 1998.
9. Haynes, T.W.; Hedetniemi, S.T.; Slater, P.J. *Fundamentals of Domination in Graphs.*; Chapman and Hall/CRC Pure and Applied Mathematics Series; Marcel Dekker, Inc.: New York, NY, USA, 1998.
10. Henning, M.; Yeo, A. *Total Domination in Graphs.* Springer Monographs in Mathematics; Springer: New York, NY, USA, 2013.
11. Chellali, M.; Haynes, T.W.; Hedetniemi, S.T.; McRae, A.A. Roman 2-domination. *Discrete Appl. Math.* **2016**, *204*, 22–28. [[CrossRef](#)]
12. Boumediene Merouane, H.; Chellali, M. On secure domination in graphs. *Inform. Process. Lett.* **2015**, *115*, 786–790. [[CrossRef](#)]
13. Burger, A.P.; Henning, M.A.; Van Vuuren, J.H. Vertex covers and secure domination in graphs. *Quaest. Math.* **2008**, *31*, 163–171. [[CrossRef](#)]
14. Chellali, M.; Haynes, T.W.; Hedetniemi, S.T. Bounds on weak Roman and 2-rainbow domination numbers. *Discrete Appl. Math.* **2014**, *178*, 27–32. [[CrossRef](#)]
15. Cockayne, E.J.; Favaron, O.; Mynhardt, C.M. Secure domination, weak Roman domination and forbidden subgraphs. *Bull. Inst. Combin. Appl.* **2003**, *39*, 87–100.

16. Klostermeyer, W.F.; Mynhardt, C.M. Secure domination and secure total domination in graphs. *Discuss. Math. Graph Theory*. **2008**, *28*, 267–284. [[CrossRef](#)]
17. Valveny, M.; Rodríguez-Velázquez, J.A. Protection of graphs with emphasis on Cartesian product graphs. *Filomat* **2019**, *33*, 319–333. [[CrossRef](#)]
18. Duginov, O. Secure total domination in graphs: Bounds and complexity. *Discrete Appl. Math.* **2017**, *222*, 97–108. [[CrossRef](#)]
19. Kulli, V.R.; Chaluvaraju, B.; Kumara, M. Graphs with equal secure total domination and inverse secure total domination numbers. *J. Inf. Optim. Sci.* **2018**, *39*, 467–473. [[CrossRef](#)]



© 2020 by the authors. Licensee MDPI, Basel, Switzerland. This article is an open access article distributed under the terms and conditions of the Creative Commons Attribution (CC BY) license (<http://creativecommons.org/licenses/by/4.0/>).



## Chapter 9

# Total protection of lexicographic product graphs

This chapter includes a complete copy of the following paper.

A. Cabrera Martínez, J.A. Rodríguez-Velázquez. Total protection of lexicographic product graphs, *Discuss. Math. Graph Theory*. In press.

URL: <https://doi.org/10.7151/dmgt.2318>

Quality indicators:

2019 JCR Impact factor: 0.755, Q3 (172/325), Mathematics.

*Discussiones Mathematicae*  
*Graph Theory xx (xxxx) 1–18*  
*doi:10.7151/dmgt.2318*

## TOTAL PROTECTION OF LEXICOGRAPHIC PRODUCT GRAPHS

ABEL CABRERA MARTÍNEZ

AND

JUAN ALBERTO RODRÍGUEZ-VELÁZQUEZ

*Universitat Rovira i Virgili*  
*Departament d'Enginyeria Informàtica i Matemàtiques*  
*Av. Països Catalans 26, 43007 Tarragona, Spain*

**e-mail:** abel.cabrera@urv.cat  
juanalberto.rodriguez@urv.cat

### Abstract

Given a graph  $G$  with vertex set  $V(G)$ , a function  $f : V(G) \rightarrow \{0, 1, 2\}$  is said to be a total dominating function if  $\sum_{u \in N(v)} f(u) > 0$  for every  $v \in V(G)$ , where  $N(v)$  denotes the open neighbourhood of  $v$ . Let  $V_i = \{x \in V(G) : f(x) = i\}$ . A total dominating function  $f$  is a total weak Roman dominating function if for every vertex  $v \in V_0$  there exists a vertex  $u \in N(v) \cap (V_1 \cup V_2)$  such that the function  $f'$ , defined by  $f'(v) = 1$ ,  $f'(u) = f(u) - 1$  and  $f'(x) = f(x)$  whenever  $x \in V(G) \setminus \{u, v\}$ , is a total dominating function as well. If  $f$  is a total weak Roman dominating function and  $V_2 = \emptyset$ , then we say that  $f$  is a secure total dominating function. The weight of a function  $f$  is defined to be  $\omega(f) = \sum_{v \in V(G)} f(v)$ . The total weak Roman domination number (secure total domination number) of a graph  $G$  is the minimum weight among all total weak Roman dominating functions (secure total dominating functions) on  $G$ . In this article, we show that these two parameters coincide for lexicographic product graphs. Furthermore, we obtain closed formulae and tight bounds for these parameters in terms of invariants of the factor graphs involved in the product.

**Keywords:** total weak Roman domination, secure total domination, total domination, lexicographic product.

**2010 Mathematics Subject Classification:** 05C69, 05C76.

1. INTRODUCTION

It is well known that the theory of domination in graphs can be developed using functions  $f : V(G) \rightarrow A$ , where  $V(G)$  is the vertex set of a graph  $G$  and  $A$  is a set of nonnegative numbers. With this approach, the different types of domination are obtained by imposing certain restrictions on  $f$ . For instance,  $f : V(G) \rightarrow \{0, 1, \dots\}$  is said to be a *dominating function* if for every vertex  $v$  such that  $f(v) = 0$ , there exists a vertex  $u \in N(v)$  such that  $f(u) > 0$ , where  $N(v)$  denotes the open neighbourhood of  $v$ . Analogously,  $f : V(G) \rightarrow \{0, 1, \dots\}$  is said to be a *total dominating function* (TDF) if for every vertex  $v$ , there exists  $u \in N(v)$  such that  $f(u) > 0$ .

The *weight* of a function  $f$  is defined to be  $\omega(f) = \sum_{v \in V(G)} f(v)$ . The *(total) domination number* of  $G$ , denoted by  $(\gamma_t(G)) \gamma(G)$ , is the minimum weight among all (total) dominating functions. These two parameters have been extensively studied. For instance, we cite the following books [15, 16, 19]. Although the use of functions is not necessary to reach the concept of (total) domination number, later we will see that this idea helps us to easily introduce other more elaborate concepts. Obviously, a set  $X \subseteq V(G)$  is a *(total) dominating set* if there exists a (total) dominating function  $f$  such that  $X = \{x : f(x) > 0\}$ .

From now on, we restrict ourselves to the case of functions  $f : V(G) \rightarrow \{0, 1, 2\}$ , which are related to the following approach to protection of a graph described by Cockayne *et al.* [12]. Suppose that one or more guards are stationed at some of the vertices of a simple graph  $G$  and that a guard at a vertex can deal with a problem at any vertex in its closed neighbourhood. Consider a function  $f : V(G) \rightarrow \{0, 1, 2\}$  where  $f(v)$  is the number of guards at  $v$ , and let  $V_i = \{v \in V(G) : f(v) = i\}$  for every  $i \in \{0, 1, 2\}$ . We will identify  $f$  with the partition of  $V(G)$  induced by  $f$  and write  $f(V_0, V_1, V_2)$ . Given a set  $S \subseteq V(G)$ ,  $f(S) = \sum_{v \in S} f(v)$ . In this case, the weight of  $f$  is  $\omega(f) = f(V(G)) = |V_1| + 2|V_2|$ .

We now consider some graph protection approaches. The functions in each approach protect the graph according to a certain strategy.

A *Roman dominating function* (RDF) is a function  $f(V_0, V_1, V_2)$  such that for every vertex  $v \in V_0$  there exists a vertex  $u \in V_2$  which is adjacent to  $v$ . The *Roman domination number*, denoted by  $\gamma_R(G)$ , is the minimum weight among all RDFs on  $G$ . This concept of protection has historical motivation [23] and was formally proposed by Cockayne *et al.* in [9]. Many variations and generalizations of Roman domination number like double Roman domination number [1], Italian domination number [17] (also known as Roman 2-domination number [7]), perfect Italian domination number [14] and weak Roman domination number [18] are available in literature.

A *weak Roman dominating function* (WRDF) is defined to be a dominating function  $f(V_0, V_1, V_2)$  satisfying that for every vertex  $v \in V_0$  there exists a vertex

$u \in N(v) \cap (V_1 \cup V_2)$  such that the function  $f'$ , defined by  $f'(v) = 1$ ,  $f'(u) = f(u) - 1$  and  $f'(x) = f(x)$  whenever  $x \in V(G) \setminus \{u, v\}$ , is a dominating function as well. The *weak Roman domination number*, denoted by  $\gamma_r(G)$ , is the minimum weight among all weak Roman dominating functions on  $G$ . This concept of protection was introduced by Henning and Hedetniemi [18] and studied further in [8, 11, 22].

In this paper we will use the following idea of total protection of a vertex. A vertex  $v \in V_0$  is said to be *totally protected* under  $f(V_0, V_1, V_2)$  if  $f$  is a TDF and there exists a vertex  $u \in N(v) \cap (V_1 \cup V_2)$  such that the function  $f'$ , defined by  $f'(v) = 1$ ,  $f'(u) = f(u) - 1$  and  $f'(x) = f(x)$  whenever  $x \in V(G) \setminus \{u, v\}$ , is a TDF as well. In such a case, if it is necessary to emphasize the role of  $u$ , then we will say that  $v$  is *totally protected by  $u$*  under  $f$ . In this context, if  $V_2 = \emptyset$ , then we also say that  $v$  is totally protected by  $u$  under  $V_1$ .

The following concept was introduced in [5]. A *total weak Roman dominating function* (TWRDF) is a TDF  $f(V_0, V_1, V_2)$  such that every vertex in  $V_0$  is totally protected under  $f$ . The *total weak Roman domination number*, denoted by  $\gamma_{tr}(G)$ , is the minimum weight among all total weak Roman dominating functions on  $G$ .

A *secure total dominating function* (STDF) is defined to be a TWRDF  $f(V_0, V_1, V_2)$  in which  $V_2 = \emptyset$ . Obviously,  $f(V_0, V_1, \emptyset)$  is a STDF if and only if  $V_1$  is a total dominating set and for every vertex  $v \in V_0$  there exists  $u \in N(v) \cap V_1$  such that  $(V_1 \setminus \{u\}) \cup \{v\}$  is a total dominating set as well. In such a case,  $V_1$  is said to be a *secure total dominating set* (STDS). The *secure total domination number*, denoted by  $\gamma_{st}(G)$ , is the minimum cardinality among all secure total dominating sets. This concept was introduced by Benecke *et al.* in [2] and studied further in [3, 4, 6, 13, 20].

Given a graph  $G$ , the problem of computing  $\gamma_{tr}(G)$  is NP-hard [5], and the problem of computing  $\gamma_{st}(G)$  is also NP-hard [13]. This suggests finding the total weak Roman domination number and the secure total domination number for special classes of graphs or obtaining good bounds on these invariants. In this article, we show that these two parameters coincide for lexicographic product graphs. Furthermore, we obtain closed formulae and tight bounds for these parameters in terms of invariants of the factor graphs involved in the product.

The lexicographic product of two graphs  $G$  and  $H$  is the graph  $G \circ H$  whose vertex set is  $V(G \circ H) = V(G) \times V(H)$  and  $(u, v)(x, y) \in E(G \circ H)$  if and only if  $ux \in E(G)$  or  $u = x$  and  $vy \in E(H)$ . Notice that for any vertex  $u \in V(G)$  the subgraph of  $G \circ H$  induced by  $\{u\} \times V(H)$  is isomorphic to  $H$ . For simplicity, we will denote this subgraph by  $H_u$ .

Throughout the paper, we will use the notation  $K_n$ ,  $N_n$ ,  $K_{1,n-1}$ ,  $C_n$  and  $P_n$  for complete graphs, empty graphs, star graphs, cycle graphs and path graphs of order  $n$ , respectively. We will use the notation  $G \cong H$  if  $G$  and  $H$  are isomorphic graphs. For a vertex  $v$  of a graph  $G$ , the *closed neighbourhood*, denoted by  $N[v]$ ,

equals  $N(v) \cup \{v\}$ . A vertex  $v \in V(G)$  such that  $N[v] = V(G)$  is said to be a *universal vertex*.

A TWRDF of weight  $\gamma_{tr}(G)$  will be called a  $\gamma_{tr}(G)$ -*function*. A similar agreement will be assumed when referring to optimal functions (and sets) associated to other parameters used in the article. For the remainder of the paper, definitions will be introduced whenever a concept is needed.

## 2. SOME TOOLS

In this short section we collect some tools, which are known results on the (total) weak Roman domination number and the secure total domination number.

**Proposition 1** [5]. *The following inequalities hold for any graph  $G$  with no isolated vertex.*

- (i)  $\gamma(G) \leq \gamma_r(G) \leq \gamma_{tr}(G) \leq 2\gamma_t(G)$ .
- (ii)  $\gamma_t(G) \leq \gamma_{tr}(G) \leq \gamma_{st}(G)$ .
- (iii)  $\gamma(G) + 1 \leq \gamma_{tr}(G)$ .

**Theorem 2** [5]. *Let  $G$  be a graph. The following statements are equivalent.*

- (a)  $\gamma_{tr}(G) = \gamma_r(G)$ .
- (b) *There exists a  $\gamma_r(G)$ -function  $f(V_0, V_1, V_2)$  such that  $V_1 = \emptyset$  and  $V_2$  is a total dominating set.*
- (c)  $\gamma_r(G) = 2\gamma_t(G)$ .

The problem of characterizing the graphs with  $\gamma_{st}(G) = \gamma_t(G)$  was solved by Klostermeyer and Mynhardt [20].

**Theorem 3** [20]. *If  $G$  is a connected graph, then the following statements are equivalent.*

- $\gamma_{st}(G) = \gamma_t(G)$ .
- $\gamma_{st}(G) = 2$ .
- $G$  has at least two universal vertices.

The following result is a direct consequence of Proposition 1(ii) and Theorem 3.

**Theorem 4.** *Let  $G$  be a connected graph. If  $G$  does not have two universal vertices, then*

$$\gamma_{st}(G) \geq \gamma_t(G) + 1.$$

**Remark 5.** For any nontrivial path  $P_n$  and any cycle  $C_n$  of order  $n \geq 4$ ,

- (i)  $\gamma_{tr}(P_n) \stackrel{[5]}{=} \gamma_{st}(P_n) \stackrel{[2]}{=} \left\lceil \frac{5(n-2)}{7} \right\rceil + 2;$   
 (ii)  $\gamma_{tr}(C_n) \stackrel{[5]}{=} \gamma_{st}(C_n) \stackrel{[3]}{=} \left\lceil \frac{5n}{7} \right\rceil.$

A set  $X \subseteq V(G)$  is called a *2-packing* if  $N[u] \cap N[v] = \emptyset$  for every pair of different vertices  $u, v \in X$  [16]. The *2-packing number*  $\rho(G)$  is the maximum cardinality among all 2-packings of  $G$ . A 2-packing of cardinality  $\rho(G)$  is called a  $\rho(G)$ -*set*.

**Theorem 6** [22]. *For any graph  $G$  with no isolated vertex and any noncomplete graph  $H$ ,*

$$\gamma_r(G \circ H) \geq \max\{\gamma_r(G), \gamma_t(G), 2\rho(G)\}.$$

Furthermore, for any graph  $G$  and any integer  $n \geq 1$ ,

$$\gamma_r(G \circ K_n) = \gamma_r(G).$$

**Theorem 7** [22]. *Let  $n \geq 2$  be an integer and let  $H$  be a graph. If  $\gamma(H) \geq 4$ , then*

$$\gamma_r(P_n \circ H) = \begin{cases} n, & n \equiv 0 \pmod{4}, \\ n + 2, & n \equiv 2 \pmod{4}, \\ n + 1, & \text{otherwise.} \end{cases}$$

A *double total dominating set* of a graph  $G$  with minimum degree at least two is a set  $S$  of vertices of  $G$  such that every vertex in  $V(G)$  is adjacent to at least two vertices in  $S$  [19]. The *double total domination number* of  $G$ , denoted by  $\gamma_{2,t}(G)$ , is the minimum cardinality among all double total dominating sets.

**Theorem 8** [22]. *If  $G$  is a graph with minimum degree at least two, then for any graph  $H$ ,*

$$\gamma_{2,t}(G \circ H) \leq \gamma_{2,t}(G).$$

To conclude this section we would recall the following upper bound on the total domination number.

**Theorem 9** [10]. *For any connected graph  $G$  of order  $n \geq 3$ ,*

$$\gamma_t(G) \leq \frac{2n}{3}.$$

### 3. MAIN RESULTS ON LEXICOGRAPHIC PRODUCT GRAPHS

The next theorem shows that the total weak Roman domination number and the secure total domination number coincide for all lexicographic product graphs.

**Theorem 10.** *For any graph  $G$  with no isolated vertex and any nontrivial graph  $H$ , i.e., any graph  $H$  of order greater than one,*

$$\gamma_{tr}(G \circ H) = \gamma_{st}(G \circ H).$$

**Proof.** Proposition 1(ii) leads to  $\gamma_{tr}(G \circ H) \leq \gamma_{st}(G \circ H)$ . Let  $f(V_0, V_1, V_2)$  be a  $\gamma_{tr}(G \circ H)$ -function such that  $|V_2|$  is minimum. We suppose that  $\gamma_{tr}(G \circ H) < \gamma_{st}(G \circ H)$ . In such a case,  $V_2 \neq \emptyset$  and we fix a vertex  $(u, v) \in V_2$ . We differentiate two cases.

*Case 1.*  $(N(u) \times V(H)) \cap (V_1 \cup V_2) \neq \emptyset$ . If  $f(u, v') > 0$  for every  $v' \in V(H)$ , then the function  $g$ , defined by  $g(u, v) = 1$  and  $g(a, b) = f(a, b)$  whenever  $(a, b) \neq (u, v)$ , is a TWRDF on  $G \circ H$  and  $\omega(g) = \omega(f) - 1$ , which is a contradiction. Hence, there exists  $v' \in V(H)$  such that  $f(u, v') = 0$ . In this case, we define the function  $g(V'_0, V'_1, V'_2)$  by  $V'_0 = V_0 \setminus \{(u, v')\}$ ,  $V'_1 = V_1 \cup \{(u, v), (u, v')\}$  and  $V'_2 = V_2 \setminus \{(u, v)\}$ . Now, if a vertex  $w \in V'_0 \subseteq V_0$  is totally protected by  $z \in V_1 \cup V_2 \subseteq V'_1 \cup V'_2$  under  $f$ , then  $w$  is also totally protected under  $g$  by  $z$ , which implies that  $g$  is a  $\gamma_{tr}(G \circ H)$ -function. Notice that  $|V'_2| = |V_2| - 1$ , which is a contradiction again.

*Case 2.*  $N(u, v) \cap (V_1 \cup V_2) \subseteq V(H_u)$ . In this case, for any  $(u', v') \in N(u) \times V(H)$  we define the function  $g(V'_0, V'_1, V'_2)$  by  $V'_0 = V_0 \setminus \{(u', v')\}$ ,  $V'_1 = V_1 \cup \{(u, v), (u', v')\}$  and  $V'_2 = V_2 \setminus \{(u, v)\}$ . As above, if a vertex  $w \in V'_0 \subseteq V_0$  is totally protected by  $z \in V_1 \cup V_2 \subseteq V'_1 \cup V'_2$  under  $f$ , then  $w$  is also totally protected by  $z$  under  $g$ . Hence,  $g$  is a  $\gamma_{tr}(G \circ H)$ -function and  $|V'_2| = |V_2| - 1$ , which is a contradiction.

According to the two cases above we conclude that  $V_2 = \emptyset$ , which implies that  $f$  is a  $\gamma_{st}(G \circ H)$ -function, and so  $\gamma_{tr}(G \circ H) = \gamma_{st}(G \circ H)$ . ■

From now on we proceed to express the value of  $\gamma_{st}(G \circ H)$  (or its bounds) in terms of several parameters of  $G$  and  $H$ . To this end, we need to introduce the following notation. For a set  $S \subseteq V(G \circ H)$  we define the following subsets of  $V(G)$ :

$$\mathcal{A}_S = \{v \in V(G) : |S \cap V(H_v)| \geq 2\};$$

$$\mathcal{B}_S = \{v \in V(G) : |S \cap V(H_v)| = 1\};$$

$$\mathcal{C}_S = \{v \in V(G) : S \cap V(H_v) = \emptyset\}.$$

Surprisingly, we have not been able to find any reference about the following basic result.

**Theorem 11.** *For any graph  $G$  with no isolated vertex and any graph  $H$ ,*

$$\gamma_t(G \circ H) = \gamma_t(G).$$

**Proof.** Let  $D$  be a  $\gamma_t(G)$ -set and let  $v \in V(H)$ . Observe that  $D' = D \times \{v\}$  is a total dominating set of  $G \circ H$ . Hence,  $\gamma_t(G \circ H) \leq |D'| = |D| = \gamma_t(G)$ .

Now, let  $S$  be a  $\gamma_t(G \circ H)$ -set and define  $S' \subseteq V(G)$  as follows.

- For every vertex  $x \in \mathcal{A}_S \cup \mathcal{B}_S$ , set  $x \in S'$ .
- For every vertex  $x \in \mathcal{A}_S$ , choose a vertex  $x' \in N(x) \setminus (\mathcal{A}_S \cup \mathcal{B}_S)$  (if any) and set  $x' \in S'$ .

Since  $G$  does not have isolated vertices,  $S'$  is a total dominating set of  $G$ . Hence,  $\gamma_t(G) \leq |S'| \leq |S| = \gamma_t(G \circ H)$ , which completes the proof. ■

**Theorem 12.** *For any graph  $G$  with no isolated vertex and any nontrivial graph  $H$ ,*

$$\max\{\gamma_r(G), \gamma_t(G), 2\rho(G)\} \leq \gamma_{st}(G \circ H) \leq 2\gamma_t(G).$$

**Proof.** By Proposition 1 and Theorems 10 and 11, we have that

$$\gamma_t(G) = \gamma_t(G \circ H) \leq \gamma_{st}(G \circ H) = \gamma_{tr}(G \circ H) \leq 2\gamma_t(G \circ H) = 2\gamma_t(G).$$

Now, by Proposition 1 and Theorems 6 and 11 we have that

$$\gamma_{st}(G \circ H) = \gamma_{tr}(G \circ H) \geq \gamma_r(G \circ H) \geq \gamma_r(G).$$

Finally, for any  $\rho(G)$ -set  $X$  and any  $\gamma_{st}(G \circ H)$ -set  $S$  we have that

$$\gamma_{st}(G \circ H) = |S| = \sum_{u \in V(G)} |S \cap V(H_u)| \geq \sum_{u \in X} \sum_{w \in N[u]} |S \cap V(H_w)| \geq 2|X| = 2\rho(G).$$

Therefore, the result follows. ■

In Theorem 22 we will characterize the graphs satisfying  $\gamma_{st}(G \circ H) = \gamma_t(G)$  and later we will give some examples of graphs achieving the remaining bounds established in Theorem 12.

**Corollary 13.** *If  $G$  is a nontrivial graph and  $\gamma(G) = 1$ , then for any nontrivial graph  $H$ ,*

$$\gamma_{st}(G \circ H) \leq 4.$$

In Section 4 we characterize the graphs with  $\gamma_{st}(G \circ H) \in \{2, 3\}$ . Hence, by Corollary 13 the graphs with  $\gamma_{st}(G \circ H) = 4$  will be automatically characterized whenever  $\gamma(G) = 1$ .

The following result is a direct consequence of Theorems 2 and 12.

**Theorem 14.** *Let  $G$  be a graph with no isolated vertex and let  $H$  be any graph.*

- (i) *If  $\gamma_{tr}(G) = \gamma_r(G)$ , then  $\gamma_{st}(G \circ H) = 2\gamma_t(G)$ .*
- (ii) *If  $\gamma_t(G) = \frac{1}{2} \max\{\gamma_r(G), 2\rho(G)\}$ , then  $\gamma_{st}(G \circ H) = 2\gamma_t(G)$ .*



**Theorem 15.** *For any graph  $G$  with no isolated vertex and any nontrivial graph  $H$ , the following statements are equivalent.*

- (i)  $\gamma_{st}(G \circ H) = \gamma_r(G \circ H)$ .
- (ii)  $\gamma_r(G \circ H) = 2\gamma_t(G)$ .

**Proof.** The result is obtained by combining Theorems 2, 10 and 11. ■

We now consider the case where  $G$  is a graph of minimum degree at least two.

**Theorem 16.** *Let  $G$  be a graph of minimum degree at least two and order  $n$ . The following statements hold.*

- (i) *For any graph  $H$ ,  $\gamma_{st}(G \circ H) \leq \gamma_{2,t}(G)$ .*
- (ii) *For any graph  $H$ ,  $\gamma_{st}(G \circ H) \leq n$ .*

**Proof.** Since every  $\gamma_{2,t}(G \circ H)$ -set is an STDS of  $G \circ H$ , we deduce that  $\gamma_{st}(G \circ H) \leq \gamma_{2,t}(G \circ H)$ . Hence, from Theorem 8 we deduce (i). Finally, since  $\gamma_{2,t}(G) \leq n$ , from (i) we deduce (ii). ■

Particular cases of graphs where  $\gamma_{st}(G \circ H) = \gamma_{2,t}(G)$  will be shown in Theorem 23(iii) and (v). Moreover, an example of graphs where  $\gamma_{st}(G \circ H) = \gamma_{2,t}(G) = n$  will be shown in Theorem 31.

As shown in [22] there exists a family  $\mathcal{H}_k$  of graphs such that  $\gamma_r(G) = \gamma_{2,t}(G)$ , for every  $G \in \mathcal{H}_k$ . Hence, for any  $G \in \mathcal{H}_k$  and any graph  $H$  we have that  $\gamma_{st}(G \circ H) = \gamma_{2,t}(G)$ . A graph  $G$  belongs to  $\mathcal{H}_k$  if and only if it is constructed from a cycle  $C_k$  and  $k$  empty graphs  $N_{s_1}, \dots, N_{s_k}$  of order  $s_1, \dots, s_k$ , respectively, and joining by an edge each vertex from  $N_{s_i}$  with the vertices  $v_i$  and  $v_{i+1}$  of  $C_k$ . Here we are assuming that  $v_i$  is adjacent to  $v_{i+1}$  in  $C_k$ , where the subscripts are taken modulo  $k$ . Figure 1 shows a graph  $G$  belonging to  $\mathcal{H}_k$ , where  $k = 4$ ,  $s_1 = s_3 = 3$  and  $s_2 = s_4 = 2$ .

Theorems 12 and 9 lead to the following bound which is useful if  $G$  has vertices of degree one.

**Theorem 17.** *For any connected graph  $G$  of order  $n \geq 3$  and any graph  $H$ ,*

$$\gamma_{st}(G \circ H) \leq 2 \left\lfloor \frac{2n}{3} \right\rfloor.$$

As shown in [22] there exists a family of trees  $T_n$ , which we will call *combs*, such that for any graph  $H$  with  $\gamma(H) \geq 4$  we have that  $\gamma_r(T_n \circ H) = 2 \lfloor \frac{2n}{3} \rfloor$ . Therefore, for these graphs,  $\gamma_{st}(T_n \circ H) = 2 \lfloor \frac{2n}{3} \rfloor$ . We now proceed to describe the family of combs. Take a path  $P_k$  of length  $k = \lfloor \frac{n}{3} \rfloor$ , with vertices  $v_1, \dots, v_k$ , and attach a path  $P_3$  to each vertex  $v_1, \dots, v_{k-1}$ , by identifying each  $v_i$  with a leaf of

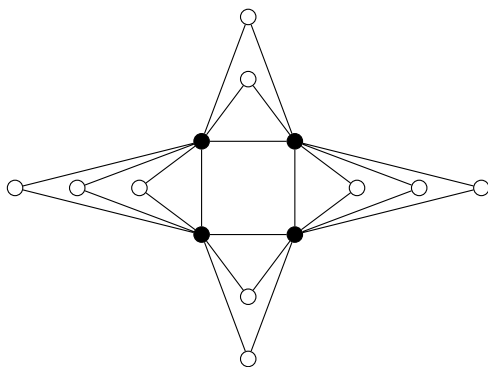

Figure 1. The set of black-coloured vertices is a  $\gamma_{2,t}(G)$ -set.

its corresponding copy of  $P_3$ . Finally, we attach a path of length  $l = n - 3 \lceil \frac{n}{3} \rceil + 2$  to  $v_k$ . Figure 2 shows the construction of  $T_n$  for different values of  $n$ . Notice that the comb of order six is simply  $T_6 \cong P_6$ .

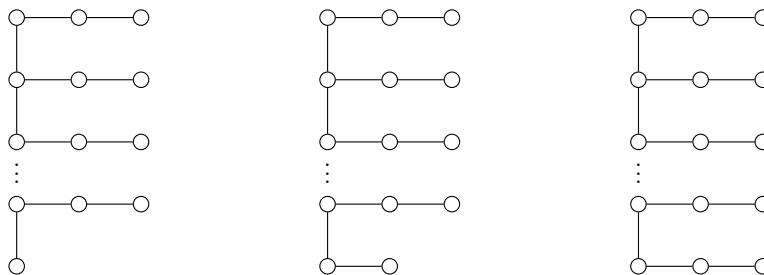

Figure 2.  $T_n$  for  $l = 0, 1, 2$ .

**Lemma 18.** For any graph  $G$  with no isolated vertex and any nontrivial graph  $H$ , there exists a  $\gamma_{st}(G \circ H)$ -set  $S$  such that  $|S \cap V(H_u)| \leq 2$ , for every  $u \in V(G)$ .

**Proof.** Given an STDS  $S$  of  $G \circ H$ , we define  $S_3 = \{x \in V(G) : |S \cap V(H_x)| \geq 3\}$ . Let  $S$  be a  $\gamma_{st}(G \circ H)$ -set such that  $|S_3|$  is minimum among all  $\gamma_{st}(G \circ H)$ -sets. If  $|S_3| = 0$ , then we are done. Hence, we suppose that there exists  $u \in S_3$  and let  $(u, v) \in S$ . We assume that  $|S \cap V(H_u)|$  is minimum among all vertices in  $S_3$ . It is readily seen that if there exists  $u' \in N(u)$  such that  $|S \cap V(H_{u'})| \geq 2$ , then  $S' = S \setminus \{(u, v)\}$  is an STDS of  $G \circ H$ , which is a contradiction. Hence, if  $u' \in N(u)$ , then  $|S \cap V(H_{u'})| \leq 1$ , and in this case it is not difficult to check that for  $(u', v') \notin S$  the set  $S'' = (S \setminus \{(u, v)\}) \cup \{(u', v')\}$  is an STDS of  $G \circ H$ . If  $|S''| < |S|$ , then we obtain a contradiction, otherwise we can repeat this process with  $S''$ , until obtaining a contradiction. Therefore, the result follows. ■

**Theorem 19.** *Let  $G$  be a graph with no isolated vertex and let  $H$  be a nontrivial graph.*

- (i) *If  $\gamma(H) = 1$ , then  $\gamma_{st}(G \circ H) \leq \gamma_{tr}(G)$ .*
- (ii) *If  $H$  has at least two universal vertices, then  $\gamma_{st}(G \circ H) \leq 2\gamma(G)$ .*
- (iii) *If  $\gamma(H) > 2$ , then  $\gamma_{st}(G \circ H) \geq \gamma_{tr}(G)$ .*

**Proof.** Let  $f$  be a  $\gamma_{tr}(G)$ -function and let  $v$  be a universal vertex of  $H$ . Let  $f'$  be the function defined by  $f'(u, v) = f(u)$  for every  $u \in V(G)$  and  $f'(x, y) = 0$  whenever  $x \in V(G)$  and  $y \in V(H) \setminus \{v\}$ . It is readily seen that  $f'$  is a TWRDF on  $G \circ H$ . Hence, by Theorem 10 we conclude that  $\gamma_{st}(G \circ H) = \gamma_{tr}(G \circ H) \leq \omega(f') = \omega(f) = \gamma_{tr}(G)$  and (i) follows.

Let  $D$  be a  $\gamma(G)$ -set and let  $y_1, y_2$  be two universal vertices of  $H$ . It is not difficult to see that  $S = D \times \{y_1, y_2\}$  is an STDS of  $G \circ H$ . Therefore,  $\gamma_{st}(G \circ H) \leq |S| = 2\gamma(G)$  and (ii) follows.

From now on, let  $S$  be a  $\gamma_{st}(G \circ H)$ -set that satisfies Lemma 18 and assume that  $\gamma(H) > 2$ . Let  $g(V_0, V_1, V_2)$  be the function defined by  $g(u) = |S \cap V(H_u)|$  for every  $u \in V(G)$ . We claim that  $g$  is a TWRDF on  $G$ . It is clear that every vertex in  $V_1$  has to be adjacent to some vertex in  $V_1 \cup V_2$  and, if  $\gamma(H) > 2$ , then by Theorem 3 we have that  $\gamma_{st}(H) > 3$ , which implies that every vertex in  $V_2$  has to be adjacent to some vertex in  $V_1 \cup V_2$ . Hence,  $V_1 \cup V_2$  is a total dominating set of  $G$ . Now, if  $x \in V_0$ , then  $S \cap V(H_x) = \emptyset$ , and so there exists a vertex  $(x_1, y_1) \in N(V(H_x)) \cap S$  which totally protects every vertex in  $V(H_x)$ . Hence,  $x$  is totally protected by  $x_1 \in V_1 \cup V_2$  under  $g$ . Thus,  $g$  is a TWRDF on  $G$  and so  $\gamma_{tr}(G) \leq \omega(g) = |S| = \gamma_{st}(G \circ H)$ . Therefore, (iii) follows. ■

The following result is a direct consequence of Theorems 12 and 19. Notice that a graph  $H$  has at least two universal vertices if and only if  $\gamma_{st}(H) = 2$ , by Theorem 3.

**Theorem 20.** *Let  $G$  be a graph with no isolated vertex and let  $H$  be a nontrivial graph.*

- (i) *If  $\gamma(G) = \rho(G)$  and  $\gamma_{st}(H) = 2$ , then  $\gamma_{st}(G \circ H) = 2\gamma(G)$ .*
- (ii) *If  $\gamma_{tr}(G) \in \{\gamma_r(G), \gamma_t(G), 2\rho(G)\}$  and  $\gamma(H) = 1$ , then  $\gamma_{st}(G \circ H) = \gamma_{tr}(G)$ .*
- (iii) *If  $\gamma_{tr}(G) = 2\gamma_t(G)$  and  $\gamma(H) > 2$ , then  $\gamma_{st}(G \circ H) = \gamma_{tr}(G)$ .*

In general, for a graph  $H$  such that  $\gamma(H) \geq 2$ , the equality  $\gamma_{st}(G \circ H) = \gamma_{tr}(G)$  does not imply that  $\gamma_{tr}(G) = 2\gamma_t(G)$ . For instance, the graph  $P_5 \circ P_4$  shown in Figure 3 satisfies  $\gamma_{st}(P_5 \circ P_4) = \gamma_{tr}(P_5) = 5 < 6 = 2\gamma_t(P_5)$ .

It is well known that  $\gamma(T) = \rho(T)$  for any tree  $T$ . Hence, the following corollary is a direct consequence of Theorem 20.

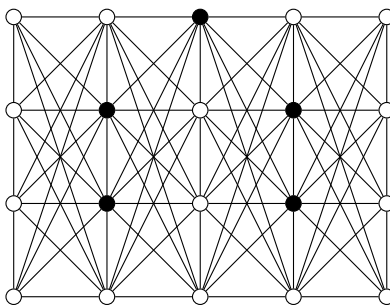

Figure 3. The set of black-coloured vertices is a  $\gamma_{st}(P_5 \circ P_4)$ -set.

**Corollary 21.** For any tree  $T$  of order at least two and any graph  $H$  with  $\gamma_{st}(H) = 2$ ,

$$\gamma_{st}(T \circ H) = 2\gamma(T).$$

#### 4. SMALL VALUES OF $\gamma_{st}(G \circ H)$

We now characterize the graphs with  $\gamma_{st}(G \circ H) \in \{2, 3\}$ .

**Theorem 22.** For any nontrivial connected graph  $G$  and any nontrivial graph  $H$ , the following statements are equivalent.

- (i)  $\gamma_{st}(G \circ H) = \gamma_t(G)$ .
- (ii)  $\gamma_{st}(G \circ H) = 2$ .
- (iii)  $\gamma_{st}(G) = \gamma(G) + 1 = \gamma(H) + 1 = 2$  or  $\gamma_{st}(H) = \gamma(G) + 1 = \gamma(H) + 1 = 2$ .

**Proof.** By Theorems 3 and 11 we conclude that (i) and (ii) are equivalent. Notice that  $G \circ H$  has at least two universal vertices if and only if  $\gamma(G) = \gamma(H) = 1$ , and also  $G$  has at least two universal vertices or  $H$  has at least two universal vertices. Hence, by Theorem 3 we conclude that (ii) and (iii) are equivalent. ■

**Theorem 23.** Let  $G$  be a nontrivial connected graph and  $H$  a graph with no isolated vertex. Then  $\gamma_{st}(G \circ H) = 3$  if and only if one of the following conditions is satisfied.

- (i)  $G \cong P_2$  and  $\gamma(H) = 2$ .
- (ii)  $G$  has exactly one universal vertex and either  $\gamma(H) = 2$  or  $H$  has exactly one universal vertex.
- (iii)  $G$  has exactly one universal vertex,  $\gamma_{2,t}(G) = 3$  and  $\gamma(H) \geq 3$ .
- (iv)  $G \not\cong P_2$  has at least two universal vertices and  $\gamma(H) \geq 2$ .
- (v)  $\gamma(G) = 2$  and  $\gamma_{2,t}(G) = 3$ .

(vi)  $\gamma(G) = 2$ ,  $\gamma_{st}(G) = 3 < \gamma_{2,t}(G)$  and  $\gamma(H) = 1$ .

**Proof.** Let  $S$  be a  $\gamma_{st}(G \circ H)$ -set and assume that  $|S| = 3$ . By Theorems 4 and 11 we have that  $3 = \gamma_{st}(G \circ H) > \gamma_t(G \circ H) = \gamma_t(G) \geq 2$ , which implies that  $\gamma_t(G) = 2$  and so  $\gamma(G) \in \{1, 2\}$ . We differentiate two cases.

*Case 1.*  $\gamma(G) = 1$ . In this case, Theorem 22 leads to  $\gamma_{st}(H) \geq 3$ . Now, we consider the following subcases.

*Subcase 1.1.*  $G \cong P_2$ . Notice that Theorem 22 leads to  $\gamma(H) \geq 2$ . Suppose that  $\gamma(H) \geq 3$  and let  $V(G) = \{u, w\}$ . By Theorem 4 we have  $\gamma_{st}(H) \geq 4$  and so  $S \cap V(H_u) \neq \emptyset$  and  $S \cap V(H_w) \neq \emptyset$ . Without loss of generality, let  $S \cap V(H_u) = \{(u, v_1), (u, v_2)\}$  and  $|S \cap V(H_w)| = 1$ . Since  $\gamma(H) \geq 3$ , we have that  $\{v_1, v_2\}$  is not a dominating set of  $H$ , which implies that no vertex in  $\{u\} \times (V(H) \setminus (N(v_1) \cup N(v_2)))$  is totally protected under  $S$ , which is a contradiction. Hence  $\gamma(H) = 2$ . Therefore, (i) follows.

*Subcase 1.2.*  $G$  has exactly one universal vertex. If  $\gamma(H) \leq 2$ , then by Theorem 22 we deduce that either  $\gamma(H) = 2$  or  $H$  has exactly one universal vertex, and (ii) follows. Assume that  $\gamma(H) \geq 3$ . As in Subcase 1.1, we conclude that  $\gamma_{st}(H) \geq 4$  and so  $|S \cap V(H_x)| \leq 2$  for every  $x \in V(G)$ . Now, if there exist two vertices  $u, w \in V(G)$  and two vertices  $v_1, v_2 \in V(H)$  such that  $S \cap V(H_u) = \{(u, v_1), (u, v_2)\}$  and  $|S \cap V(H_w)| = 1$ , then we deduce that no vertex in  $\{u\} \times (V(H) \setminus (N(v_1) \cup N(v_2)))$  is totally protected under  $S$ , which is a contradiction. Therefore,  $\mathcal{A}_S = \emptyset$  and  $\mathcal{B}_S$  has to be a  $\gamma_{2,t}(G)$ -set, as if there exists  $x \in V(G)$  such that  $|N(x) \cap \mathcal{B}_S| \leq 1$ , then  $V(H_x)$  has vertices which are not totally protected under  $S$ . Therefore, (iii) follows.

*Subcase 1.3.*  $G \not\cong P_2$  has at least two universal vertices. In this case, by Theorem 22 we deduce that  $\gamma(H) \geq 2$ , and so (iv) follows.

*Case 2.*  $\gamma(G) = 2$ . In this case, Theorem 4 leads to  $\gamma_{st}(G) \geq 3$ . If there exist two vertices  $u, w \in V(G)$  such that  $\mathcal{A}_S = \{u\}$  and  $\mathcal{B}_S = \{w\}$ , then  $\{u, w\}$  is a  $\gamma_t(G)$ -set, and so for any  $x \in N(w) \setminus N[u]$  we have that no vertex in  $V(H_x)$  is totally protected under  $S$ , which is a contradiction. Therefore,  $\mathcal{A}_S = \emptyset$  and  $|\mathcal{B}_S| = 3$ , which implies that  $\mathcal{B}_S$  is a  $\gamma_{st}(G)$ -set. Let  $\langle \mathcal{B}_S \rangle$  be the subgraph induced by  $\mathcal{B}_S$ . Notice that either  $\langle \mathcal{B}_S \rangle \cong K_3$  or  $\langle \mathcal{B}_S \rangle \cong P_3$ . In the first case,  $\mathcal{B}_S$  is a  $\gamma_{2,t}(G)$ -set and (v) follows. Now, assume that  $\langle \mathcal{B}_S \rangle \cong P_3$ . If  $\gamma(H) \geq 2$ , then for any vertex  $x$  of degree one in  $\langle \mathcal{B}_S \rangle$  we have that  $V(H_x)$  has vertices which are not totally protected under  $S$ , which is a contradiction. Therefore,  $\gamma(H) = 1$  and if  $\gamma_{st}(G) = \gamma_{2,t}(G)$ , then  $G$  satisfies (v), otherwise  $G$  satisfies (vi), by Theorem 16.

Conversely, notice that if  $G$  and  $H$  satisfy one of the six conditions above, then Theorem 22 leads to  $\gamma_{st}(G \circ H) \geq 3$ . To conclude that  $\gamma_{st}(G \circ H) = 3$ , we proceed to show how to define an STDS  $D$  of  $G \circ H$  of cardinality three for each of the six conditions.

- (i) Let  $\{v_1, v_2\}$  be a  $\gamma(H)$ -set and  $V(G) = \{u, w\}$ . In this case, we define  $D = \{(u, v_1), (u, v_2), (w, v_1)\}$ .
- (ii) Let  $u$  be a universal vertex of  $G$  and  $w \in V(G) \setminus \{u\}$ . If  $\{v_1, v_2\}$  is a  $\gamma(H)$ -set or  $v_1$  is a universal vertex of  $H$  and  $v_2 \in V(H) \setminus \{v_1\}$ , then we set  $D = \{(u, v_1), (u, v_2), (w, v_1)\}$ .
- (iii) Let  $X$  be a  $\gamma_{2,t}(G)$ -set and  $v \in V(H)$ . In this case,  $D = X \times \{v\}$ .
- (iv) Let  $u, w \in V(G)$  be two universal vertices,  $z \in V(G) \setminus \{u, w\}$  and  $v \in V(H)$ . In this case,  $D = \{(u, v), (w, v), (z, v)\}$ .
- (v) Let  $X$  be a  $\gamma_{2,t}(G)$ -set and  $v \in V(H)$ . In this case,  $D = X \times \{v\}$ .
- (vi) Let  $X$  be a  $\gamma_{st}(G)$ -set and  $v$  be a universal vertex of  $H$ . In this case,  $D = X \times \{v\}$ .

It is readily seen that in all cases  $D$  is an STDS of  $G \circ H$ . Therefore,  $\gamma_{st}(G \circ H) = 3$ . ■

**Theorem 24.** *Let  $G$  be a nontrivial connected graph and  $H$  a nontrivial graph with at least one isolated vertex. Then  $\gamma_{st}(G \circ H) = 3$  if and only if at least one of the following conditions is satisfied.*

- (i)  $\gamma(G) = 1$  and  $\gamma(H) = 2$ .
- (ii)  $\gamma_{2,t}(G) = 3$ .

**Proof.** Notice that  $\gamma(H) \geq 2$ , as  $H$  is a nontrivial graph with at least one isolated vertex. Let  $S$  be a  $\gamma_{st}(G \circ H)$ -set that satisfies Lemma 18 and assume that  $|S| = 3$ . Now, we consider two cases.

*Case 1.*  $\mathcal{A}_S \neq \emptyset$ . In this case we have that  $|\mathcal{A}_S| = |\mathcal{B}_S| = 1$ . Let  $u, w \in V(G)$  such that  $\mathcal{A}_S = \{u\}$  and  $\mathcal{B}_S = \{w\}$ . Notice that  $\{u, w\}$  is a  $\gamma_t(G)$ -set and, if there exists  $x \in N(w) \setminus N[u]$ , then no vertex in  $V(H_x)$  is totally protected under  $S$ , which is a contradiction. Hence,  $\gamma(G) = 1$ . Now, since  $H$  has at least one isolated vertex, if  $\gamma(H) > 2$ , then  $H_u$  has at least one vertex which is not totally protected under  $S$ , which is a contradiction. Therefore,  $\gamma(H) = 2$  and (i) follows.

*Case 2.*  $\mathcal{A}_S = \emptyset$ . In this case we have that  $|\mathcal{B}_S| = 3$ , which implies that  $\mathcal{B}_S$  is a  $\gamma_{st}(G)$ -set. Let  $\langle \mathcal{B}_S \rangle$  be the subgraph induced by  $\mathcal{B}_S$ . Notice that either  $\langle \mathcal{B}_S \rangle \cong K_3$  or  $\langle \mathcal{B}_S \rangle \cong P_3$ . Suppose that  $\langle \mathcal{B}_S \rangle \cong P_3$  and let  $x$  be a vertex of degree one in  $\langle \mathcal{B}_S \rangle$ . Since  $H$  has at least one isolated vertex, there exists at least one vertex in  $V(H_x)$  which is not totally protected under  $S$ , which is a contradiction. Hence,  $\langle \mathcal{B}_S \rangle \cong K_3$ , which implies that  $\mathcal{B}_S$  is a  $\gamma_{2,t}(G)$ -set and so (ii) follows.

Conversely, notice that if  $G$  and  $H$  satisfy one of the two conditions above, then Theorem 22 leads to  $\gamma_{st}(G \circ H) \geq 3$ . To conclude that  $\gamma_{st}(G \circ H) = 3$ , we proceed to show how to define an STDS  $D$  of  $G \circ H$  of cardinality three for each of the two conditions.

- (i) Let  $\{u\}$  be a  $\gamma(G)$ -set,  $w \in V(G) \setminus \{u\}$  and  $\{v_1, v_2\}$  be a  $\gamma(H)$ -set. In this case,  $D = \{(u, v_1), (u, v_2), (w, v_1)\}$ .

(ii) Let  $X$  be a  $\gamma_{2,t}(G)$ -set and  $v \in V(H)$ . In this case,  $D = X \times \{v\}$ .

It is readily seen that in both cases  $D$  is an STDS of  $G \circ H$ . Therefore,  $\gamma_{st}(G \circ H) = 3$ . ■

The following result, which is a direct consequence of Theorems 12, 22, 23 and 24, shows the cases when  $G$  is isomorphic to a complete graph or a star graph.

**Proposition 25.** *For any integer  $n \geq 3$ , the following statements hold.*

(i) *If  $H$  is a graph with no isolated vertex, then*

$$\gamma_{st}(K_n \circ H) = \begin{cases} 2, & \text{if } \gamma(H) = 1, \\ 3, & \text{otherwise.} \end{cases}$$

and

$$\gamma_{st}(K_{1,n-1} \circ H) = \begin{cases} 2, & \text{if } \gamma_{st}(H) = 2, \\ 3, & \text{if } \gamma_{st}(H) \geq 3 \text{ and } \gamma(H) \leq 2, \\ 4, & \text{otherwise.} \end{cases}$$

(ii) *If  $H$  is a nontrivial graph with at least one isolated vertex, then*

$$\gamma_{st}(K_n \circ H) = 3$$

and

$$\gamma_{st}(K_{1,n-1} \circ H) = \begin{cases} 3, & \text{if } \gamma(H) = 2, \\ 4, & \text{otherwise.} \end{cases}$$

We now consider the cases in which  $G$  is a double star graph or a complete bipartite graph. Recall that a double star  $S_{n_1, n_2}$  is the graph obtained by joining the center of two stars  $K_{1, n_1}$  and  $K_{1, n_2}$  with an edge. The following result is a direct consequence of Theorems 12, 22, 23 and 24.

**Proposition 26.** *Let  $H$  be a nontrivial graph. For any integers  $n_2 \geq n_1 \geq 2$ , the following statements hold.*

$$\gamma_{st}(S_{n_1, n_2} \circ H) = 4$$

and

$$\gamma_{st}(K_{n_1, n_2} \circ H) = \begin{cases} 3, & \text{if } n_1 = 2 \text{ and } \gamma(H) = 1, \\ 4, & \text{otherwise.} \end{cases}$$

## 5. SPECIAL CASES WHERE $G \cong P_n$ AND $G \cong C_n$

First, we analyse the case where  $G \cong P_n$  and  $\gamma(H) = 1$  or  $\gamma(H) \geq 4$ .

**Theorem 27.** *Let  $n \geq 2$  be an integer and let  $H$  be a graph with  $\gamma(H) = 1$ . If  $\gamma_{st}(H) = 2$ , then*

$$\gamma_{st}(P_n \circ H) = 2 \left\lceil \frac{n}{3} \right\rceil.$$

*Otherwise,  $\gamma_{st}(P_n \circ H) \leq 2 \left\lceil \frac{5(n-2)}{7} \right\rceil + 2$ .*

**Proof.** If  $\gamma_{st}(H) = 2$ , then by Corollary 21 we deduce that  $\gamma_{st}(P_n \circ H) = 2\gamma(P_n)$ . Now, if  $\gamma_{st}(H) \geq 3$ , then by Theorem 19 we deduce  $\gamma_{st}(P_n \circ H) \leq \gamma_{tr}(P_n)$ . ■

As shown in [22], if  $\gamma(H) \geq 4$ , then  $\gamma_r(P_n \circ H) = 2\gamma_t(P_n)$ . Hence, from Proposition 1 and Theorems 12 and 7 we derive the following result.

**Theorem 28.** *Let  $n \geq 2$  be an integer and let  $H$  be a graph. If  $\gamma(H) \geq 4$ , then*

$$\gamma_{st}(P_n \circ H) = \gamma_r(P_n \circ H) = \begin{cases} n, & n \equiv 0 \pmod{4}, \\ n + 2, & n \equiv 2 \pmod{4}, \\ n + 1, & \text{otherwise.} \end{cases}$$

The following result is a direct consequence of Theorems 19 and 20.

**Theorem 29.** *Let  $n \geq 3$  be an integer and let  $H$  be a graph.*

- *If  $H$  has exactly one universal vertex, then  $\gamma_{st}(C_n \circ H) \leq \left\lceil \frac{5n}{7} \right\rceil$ .*
- *If  $H$  has at least two universal vertices, then  $\gamma_{st}(C_n \circ H) \leq 2 \left\lceil \frac{n}{3} \right\rceil$ , and if  $n \equiv 0 \pmod{3}$ , then the equality holds.*

**Lemma 30.** *Let  $G$  be a nontrivial connected graph and let  $H$  be any graph. The following statements hold for every  $\gamma_{st}(G \circ H)$ -set  $S$ .*

- (i) *If  $\gamma(H) \geq 2$  and  $x \in \mathcal{B}_S$ , then  $\sum_{u \in N(x)} |S \cap V(H_u)| \geq 2$ .*
- (ii) *If  $\gamma_t(H) \geq 3$  and  $x \in \mathcal{A}_S$ , then  $\sum_{u \in N(x)} |S \cap V(H_u)| \geq 2$ .*

**Proof.** If  $\gamma(H) \geq 2$  and there exists a vertex  $x \in \mathcal{B}_S$  such that  $\sum_{u \in N(x)} |S \cap V(H_u)| \leq 1$ , then there exists a vertex in  $V(H_x) \setminus S$  which is not totally protected under  $S$ . Therefore, (i) follows.

Now, assume that  $\gamma_t(H) \geq 3$ , and notice that Theorem 4 leads to  $\gamma_{st}(H) \geq 4$ . Suppose that there exists  $x \in \mathcal{A}_S$  such that  $\sum_{u \in N(x)} |S \cap V(H_u)| \leq 1$ . Notice that, in such a case, either  $2 \leq |S \cap V(H_x)| \leq 3$  and  $S \cap (\bigcup_{u \in N(x)} V(H_u)) = \emptyset$  or  $|S \cap V(H_x)| = 2$  and  $|S \cap (\bigcup_{u \in N(x)} V(H_u))| = 1$ , which implies that there exists a vertex in  $V(H_x) \setminus S$  which is not totally protected under  $S$ , as  $\gamma_{st}(H_x) \geq 4$  and  $\gamma_t(H_x) \geq 3$ . Therefore, (ii) follows. ■

**Theorem 31.** *Let  $n \geq 3$  be an integer and let  $H$  be a graph. If  $\gamma_t(H) \geq 3$ , then*

$$\gamma_{st}(C_n \circ H) = n.$$



**Proof.** From Theorem 16 we know that  $\gamma_{st}(C_n \circ H) \leq n$ . We only need to prove that  $\gamma_{st}(C_n \circ H) \geq n$ . Let  $S$  be a  $\gamma_{st}(G \circ H)$ -set that satisfies Lemma 18. If  $\mathcal{C}_S = \emptyset$ , then  $\gamma_{st}(C_n \circ H) = |S| \geq n$ . Thus we assume that  $\mathcal{C}_S \neq \emptyset$ .

Let  $V(C_n) = \{u_i, \dots, u_n\}$ , where the subscripts are taken modulo  $n$  and consecutive vertices are adjacent. We differentiate two cases for  $u_i \in \mathcal{C}_S$ .

*Case 1.*  $u_i$  is not adjacent to any vertex in  $\mathcal{C}_S$ . In this case, by Lemma 30 we have that  $u_{i+2} \in \mathcal{A}_S$  and  $u_{i+1} \in \mathcal{A}_S \cup \mathcal{B}_S$ . Analogously,  $u_{i-2} \in \mathcal{A}_S$  and  $u_{i-1} \in \mathcal{A}_S \cup \mathcal{B}_S$ .

*Case 2.*  $u_{i+1} \in \mathcal{C}_S$ . Since every vertex in  $V(H_{u_i})$  has to be totally protected under  $S$ , we have that  $u_{i-1}, u_{i+2} \in \mathcal{A}_S$  and so Lemma 30(ii) leads to  $u_{i-2}, u_{i+3} \in \mathcal{A}_S$ .

According to the two cases above,  $|\mathcal{A}_S| \geq |\mathcal{C}_S|$ , which implies that  $\gamma_{st}(C_n \circ H) \geq 2|\mathcal{A}_S| + |\mathcal{B}_S| \geq n$ . Therefore, the result follows. ■

### Acknowledgements

This work has been partially supported by the Spanish Ministry of Economy, Industry and Competitiveness, under the grants MTM2016-78227-C2-1-P and MTM2017-90584-REDT.

### REFERENCES

- [1] R.A. Beeler, T.W. Haynes and S.T. Hedetniemi, *Double Roman domination*, Discrete Appl. Math. **211** (2016) 23–29.  
doi:10.1016/j.dam.2016.03.017
- [2] S. Benecke, E.J. Cockayne and C.M. Mynhardt, *Secure total domination in graphs*, Util. Math. **74** (2007) 247–259.
- [3] S. Benecke, E.J. Cockayne and C.M. Mynhardt, *Total protection of a graph*, unpublished manuscript.
- [4] R. Brigham, J. Carrington and R. Vitray, *Connected graphs with maximum total domination number*, J. Combin. Math. Combin. Comput. **34** (2000) 81–96.
- [5] A. Cabrera Martínez, L.P. Montejano and J.A. Rodríguez-Velázquez, *Total weak Roman domination in graphs*, Symmetry **11** (2019) No. 831.  
doi:10.3390/sym11060831
- [6] A. Cabrera Martínez and J.A. Rodríguez-Velázquez, *On the secure total domination number of graphs*, Symmetry **11** (2019) No. 1165.  
doi:10.3390/sym11091165
- [7] M. Chellali, T.W. Haynes, S.T. Hedetniemi and A. McRae, *Roman  $\{2\}$ -domination*, Discrete Appl. Math. **204** (2016) 22–28.  
doi:10.1016/j.dam.2015.11.013

- [8] M. Chellali, T.W. Haynes and S.T. Hedetniemi, *Bounds on weak Roman and 2-rainbow domination numbers*, Discrete Appl. Math. **178** (2014) 27–32.  
doi:10.1016/j.dam.2014.06.016
- [9] E.J. Cockayne, P.A. Dreyer Jr., S.M. Hedetniemi and S.T. Hedetniemi, *Roman domination in graphs*, Discrete Math. **278** (2004) 11–22.  
doi:10.1016/j.disc.2003.06.004
- [10] E.J. Cockayne, R.M. Dawes and S.T. Hedetniemi, *Total domination in graphs*, Networks **10** (1980) 211–219.  
doi:10.1002/net.3230100304
- [11] E.J. Cockayne, O. Favaron and C.M. Mynhardt, *Secure domination, weak Roman domination and forbidden subgraphs*, Bull. Inst. Combin. Appl. **39** (2003) 87–100.
- [12] E.J. Cockayne, P.J.P. Grobler, W.R. Gründlingh, J. Munganga and J.H. van Vuuren, *Protection of a graph*, Util. Math. **67** (2005) 19–32.
- [13] O. Duginov, *Secure total domination in graphs: Bounds and complexity*, Discrete Appl. Math. **222** (2017) 97–108.  
doi:10.1016/j.dam.2016.08.018
- [14] T.W. Haynes and M.A. Henning, *Perfect Italian domination in trees*, Discrete Appl. Math. **260** (2019) 164–177.  
doi:10.1016/j.dam.2019.01.038
- [15] T.W. Haynes, S.T. Hedetniemi and P.J. Slater, *Domination in Graphs: Advanced Topics* (Taylor & Francis, 1998).
- [16] T.W. Haynes, S.T. Hedetniemi and P.J. Slater, *Fundamentals of Domination in Graphs* (Marcel Dekker, Inc., New York, 1998).
- [17] M.A. Henning and W.F. Klostermeyer, *Italian domination in trees*, Discrete Appl. Math. **217** (2017) 557–564.  
doi:10.1016/j.dam.2016.09.035
- [18] M.A. Henning and S.T. Hedetniemi, *Defending the Roman Empire—A new strategy*, Discrete Math. **266** (2003) 239–251.  
doi:10.1016/S0012-365X(02)00811-7
- [19] M.A. Henning and A. Yeo, *Total Domination in Graphs* (Springer, New York, 2013).  
doi:10.1007/978-1-4614-6525-6
- [20] W.F. Klostermeyer and C.M. Mynhardt, *Secure domination and secure total domination in graphs*, Discuss. Math. Graph Theory **28** (2008) 267–284.  
doi:10.7151/dmgt.1405
- [21] A. Meir and J.W. Moon, *Relations between packing and covering numbers of a tree*, Pacific J. Math. **61** (1975) 225–233.  
doi:10.2140/pjm.1975.61.225
- [22] M. Valveny, H. Pérez-Rosés and J.A. Rodríguez-Velázquez, *On the weak Roman domination number of lexicographic product graphs*, Discrete Appl. Math. **263** (2019) 257–270.  
doi:10.1016/j.dam.2018.03.039

18

A. CABRERA MARTÍNEZ AND J.A. RODRÍGUEZ-VELÁZQUEZ

- [23] I. Stewart, *Defend the Roman Empire!*, Sci. Amer. **281** (1999) 136–138.  
doi:10.1038/scientificamerican1299-136

Received 13 June 2019  
Revised 25 March 2020  
Accepted 26 March 2020

## Chapter 10

# From (secure) $w$ -domination in graphs to protection of lexicographic product graphs

This chapter includes a complete copy of the following paper.

A. Cabrera Martínez, A. Estrada-Moreno, J.A. Rodríguez-Velázquez. From (secure)  $w$ -domination in graphs to protection of lexicographic product graphs, *Bull. Malays. Math. Sci. Soc.* To appear.

Quality indicators:

2019 JCR Impact factor: 0.856, Q2 (146/325), Mathematics.

arXiv:2105.05199v1 [math.CO] 11 May 2021

# From (secure) $w$ -domination in graphs to protection of lexicographic product graphs

A. Cabrera Martínez, A. Estrada-Moreno, J. A. Rodríguez-Velázquez

Universitat Rovira i Virgili

Departament d'Enginyeria Informàtica i Matemàtiques

Av. Països Catalans 26, 43007 Tarragona, Spain.

abel.cabrera@urv.cat, alejandro.estrada@urv.cat, juanalberto.rodriguez@urv.cat

## Abstract

Let  $w = (w_0, w_1, \dots, w_l)$  be a vector of nonnegative integers such that  $w_0 \geq 1$ . Let  $G$  be a graph and  $N(v)$  the open neighbourhood of  $v \in V(G)$ . We say that a function  $f : V(G) \rightarrow \{0, 1, \dots, l\}$  is a  $w$ -dominating function if  $f(N(v)) = \sum_{u \in N(v)} f(u) \geq w_i$  for every vertex  $v$  with  $f(v) = i$ . The weight of  $f$  is defined to be  $\omega(f) = \sum_{v \in V(G)} f(v)$ . Given a  $w$ -dominating function  $f$  and any pair of adjacent vertices  $v, u \in V(G)$  with  $f(v) = 0$  and  $f(u) > 0$ , the function  $f_{u \rightarrow v}$  is defined by  $f_{u \rightarrow v}(v) = 1$ ,  $f_{u \rightarrow v}(u) = f(u) - 1$  and  $f_{u \rightarrow v}(x) = f(x)$  for every  $x \in V(G) \setminus \{u, v\}$ . We say that a  $w$ -dominating function  $f$  is a secure  $w$ -dominating function if for every  $v$  with  $f(v) = 0$ , there exists  $u \in N(v)$  such that  $f(u) > 0$  and  $f_{u \rightarrow v}$  is a  $w$ -dominating function as well. The (secure)  $w$ -domination number of  $G$ , denoted by  $\gamma_w^s(G)$   $\gamma_w(G)$ , is defined as the minimum weight among all (secure)  $w$ -dominating functions.

In this paper, we show how the secure (total) domination number and the (total) weak Roman domination number of lexicographic product graphs  $G \circ H$  are related to  $\gamma_w^s(G)$  or  $\gamma_w(G)$ . For the case of the secure domination number and the weak Roman domination number, the decision on whether  $w$  takes specific components will depend on the value of  $\gamma_{(1,0)}^s(H)$ , while in the case of the total version of these parameters, the decision will depend on the value of  $\gamma_{(1,1)}^s(H)$ .

**Keywords:** Secure  $w$ -domination,  $w$ -domination, weak Roman domination, secure domination, lexicographic product.

**MSC2020:** 05C69, 05C76

## 1 Introduction

As usual,  $\mathbb{Z}^+ = \{1, 2, 3, \dots\}$  and  $\mathbb{N} = \mathbb{Z}^+ \cup \{0\}$  denote the sets of positive and nonnegative integers, respectively. Let  $G$  be a graph,  $l \in \mathbb{Z}^+$  an integer, and  $f : V(G) \rightarrow \{0, \dots, l\}$  a function. Let  $V_i = \{v \in V(G) : f(v) = i\}$  for every  $i \in \{0, \dots, l\}$ . We will identify  $f$  with the

subsets  $V_0, \dots, V_l$  associated with it, and so we will use the unified notation  $f(V_0, \dots, V_l)$  for the function and these associated subsets. The *weight* of  $f$  is defined as

$$\omega(f) = f(V(G)) = \sum_{i=1}^l i|V_i|.$$

Let  $w = (w_0, \dots, w_l) \in \mathbb{Z}^+ \times \mathbb{N}^l$  such that  $w_0 \geq 1$ . As defined in [4], a function  $f(V_0, \dots, V_l)$  is a *w-dominating function* if  $f(N(v)) \geq w_i$  for every  $v \in V_i$ . The *w-domination number* of  $G$ , denoted by  $\gamma_w(G)$ , is the minimum weight among all  $w$ -dominating functions. For simplicity, a  $w$ -dominating function  $f$  of weight  $\omega(f) = \gamma_w(G)$  will be called a  $\gamma_w(G)$ -function. For fundamental results on the  $w$ -domination number of a graph, we refer the interested readers to [4]; the paper where the theory of  $w$ -domination in graphs was introduced.

For any function  $f(V_0, \dots, V_l)$  and any pair of adjacent vertices  $v \in V_0$  and  $u \in V(G) \setminus V_0$ , the function  $f_{u \rightarrow v}$  is defined by  $f_{u \rightarrow v}(v) = 1$ ,  $f_{u \rightarrow v}(u) = f(u) - 1$  and  $f_{u \rightarrow v}(x) = f(x)$  whenever  $x \in V(G) \setminus \{u, v\}$ .

The authors of this paper [5] introduced the approach of secure  $w$ -domination as follows. A  $w$ -dominating function  $f(V_0, \dots, V_l)$  is a *secure w-dominating function* if for every  $v \in V_0$  there exists  $u \in N(v) \setminus V_0$  such that  $f_{u \rightarrow v}$  is a  $w$ -dominating function as well. The *secure w-domination number* of  $G$ , denoted by  $\gamma_w^s(G)$ , is the minimum weight among all secure  $w$ -dominating functions. For simplicity, a secure  $w$ -dominating function  $f$  of weight  $\omega(f) = \gamma_w^s(G)$  will be called a  $\gamma_w^s(G)$ -function. This approach to the theory of secure domination covers the different versions of secure domination known so far. For instance, we would emphasize the following cases of known parameters that we define here in terms of secure  $w$ -domination.

- The *secure domination number* of  $G$  is defined to be  $\gamma_s(G) = \gamma_{(1,0)}^s(G)$ . In this case, for any secure  $(1,0)$ -dominating function  $f(V_0, V_1)$ , the set  $V_1$  is known as a *secure dominating set*. This concept was introduced by Cockayne et al. in [12] and studied further in several papers, including among others, [2, 3, 10, 11, 19, 21].
- The *secure total domination number* of a graph  $G$  of minimum degree at least one is defined to be  $\gamma_{st}(G) = \gamma_{(1,1)}^s(G)$ . In this case, for any secure  $(1,1)$ -dominating function  $f(V_0, V_1)$ , the set  $V_1$  is known as a *secure total dominating set* of  $G$ . This concept was introduced by Benecke et al. in [1] and studied further in several papers, including among others, [7, 8, 14, 19, 20].
- The *weak Roman domination number* of a graph  $G$  is defined to be  $\gamma_r(G) = \gamma_{(1,0,0)}^s(G)$ . This concept was introduced by Henning and Hedetniemi [17] and studied further in several papers, including among others, [6, 10, 11, 22].
- The *total weak Roman domination number* of a graph  $G$  of minimum degree at least one is defined to be  $\gamma_{tr}(G) = \gamma_{(1,1,1)}^s(G)$ . This concept was introduced by Cabrera et al. in [8] and studied further in [9].
- The *secure Italian domination number* of  $G$  is defined to be  $\gamma_t^s(G) = \gamma_{(2,0,0)}^s(G)$ . This parameter was introduced by Dettlaff et al. in [13].

In this paper we show how the secure (total) domination number and the (total) weak Roman domination number of lexicographic product graphs  $G \circ H$  are related to  $\gamma_w^s(G)$  or  $\gamma_w(G)$ . For the case of the secure domination number and the weak Roman domination number, the decision on whether  $w$  takes specific components will depend on the value of  $\gamma_{(1,0)}^s(H)$ , while in the case of the total version of these parameters, the decision will depend on the value of  $\gamma_{(1,1)}^s(H)$ .

We assume that the reader is familiar with the basic concepts, notation and terminology of domination in graph. If this is not the case, we suggest the textbooks [15, 16]. For the remainder of the paper, definitions will be introduced whenever a concept is needed.

## 2 Some tools

Given a  $w$ -dominating function  $f(V_0, \dots, V_l)$  and  $v \in V_0$ , we define

$$M_f(v) = \{u \in V(G) \setminus V_0 : f_{u \rightarrow v} \text{ is a } w\text{-dominating function}\}.$$

Obviously, if  $f$  is a secure  $w$ -dominating function, then  $M_f(v) \neq \emptyset$  for every  $v \in V_0$ .

**Theorem 2.1.** [5] *Let  $G$  be a graph of minimum degree  $\delta$ , and let  $w = (w_0, \dots, w_l) \in \mathbb{Z}^+ \times \mathbb{N}^l$  such that  $w_i \geq w_{i+1}$  for every  $i \in \{0, \dots, l-1\}$ . If  $l\delta \geq w_l$ , then following statements hold.*

- (i)  $\gamma_w(G) \leq \gamma_w^s(G)$ .
- (ii) If  $k \in \mathbb{Z}^+$ , then  $\gamma_{(k+1, k=w_1, \dots, w_l)}(G) \leq \gamma_{(k, k=w_1, \dots, w_l)}^s(G)$ .

**Theorem 2.2.** [5] *Let  $G$  be a graph of minimum degree  $\delta$ , and let  $w = (w_0, \dots, w_l), w' = (w'_0, \dots, w'_l) \in \mathbb{Z}^+ \times \mathbb{N}^l$  such that  $l\delta \geq w_l$ ,  $w_i \geq w_{i+1}$  and  $w'_i \geq w'_{i+1}$  for every  $i \in \{0, \dots, l-1\}$ . If  $w_i \geq w'_{i-1} - 1$  for every  $i \in \{1, \dots, l\}$ , and  $\max\{w_j - 1, 0\} \geq w'_j$  for every  $j \in \{0, \dots, l\}$ , then*

$$\gamma_{w'}^s(G) \leq \gamma_w(G).$$

The following result is a particular case of Theorem 2.2.

**Corollary 2.3.** [5] *Let  $G$  be a graph of minimum degree  $\delta$ , and let  $w = (w_0, \dots, w_l) \in \mathbb{Z}^+ \times \mathbb{N}^l$  and  $\mathbf{I} = (1, \dots, 1)$ . If  $0 \leq w_{j-1} - w_j \leq 2$  for every  $j \in \{1, \dots, l\}$ , where  $1 \leq i \leq l$  and  $l\delta \geq w_l + 1$ , then*

$$\gamma_{(w_0, \dots, w_l, 0, \dots, 0)}^s(G) \leq \gamma_{(w_0+1, \dots, w_l+1, 0, \dots, 0)}(G) \leq \gamma_{w+\mathbf{I}}(G).$$

**Proposition 2.4.** [5] *Let  $G$  be a graph of order  $n$ . Let  $w = (w_0, \dots, w_l) \in \mathbb{Z}^+ \times \mathbb{N}^l$  such that  $w_0 \geq \dots \geq w_l$ . If  $G'$  is a spanning subgraph of  $G$  with minimum degree  $\delta' \geq \frac{w_l}{l}$ , then*

$$\gamma_w^s(G) \leq \gamma_w^s(G').$$

### 3 The case of lexicographic product graphs

The *lexicographic product* of two graphs  $G$  and  $H$  is the graph  $G \circ H$  whose vertex set is  $V(G \circ H) = V(G) \times V(H)$  and  $(u, v)(x, y) \in E(G \circ H)$  if and only if  $ux \in E(G)$  or  $u = x$  and  $vy \in E(H)$ .

Notice that for any  $u \in V(G)$  the subgraph of  $G \circ H$  induced by  $\{u\} \times V(H)$  is isomorphic to  $H$ . For simplicity, we will denote this subgraph by  $H_u$ . Moreover, the neighbourhood of  $(x, y) \in V(G) \times V(H)$  will be denoted by  $N(x, y)$  instead of  $N((x, y))$ . Analogously, for any function  $f$  on  $G \circ H$ , the image of  $(x, y)$  will be denoted by  $f(x, y)$  instead of  $f((x, y))$ .

The next subsections are devoted to show how the secure (total) domination number and the (total) weak Roman domination number of lexicographic product graphs  $G \circ H$  are related to  $\gamma_w^s(G)$  or  $\gamma_w(G)$ , for certain vectors  $w$  of three components.

#### 3.1 Secure domination

**Lemma 3.1.** *For any graph  $G$  with no isolated vertex and any nontrivial graph  $H$ , there exists a  $\gamma_{(1,0)}^s(G \circ H)$ -function  $f$  such that  $f(V(H_u)) \leq 2$  for every  $u \in V(G)$ .*

*Proof.* Given a secure  $(1, 0)$ -dominating function  $f$  on  $G \circ H$ , we define

$$R_f = \{x \in V(G) : f(V(H_x)) \geq 3\}.$$

Let  $f$  be a  $\gamma_{(1,0)}^s(G \circ H)$ -function such that  $|R_f|$  is minimum among all  $\gamma_{(1,0)}^s(G \circ H)$ -functions.

Suppose that  $|R_f| \geq 1$ . Let  $u \in R_f$ ,  $u' \in N(u)$  and  $v_1, v_2 \in V(H)$  such that  $f(u, v_1) = f(u, v_2) = 1$ . Now, let  $f' : V(G) \times V(H) \rightarrow \{0, 1\}$  be a function defined as follows.

- $f'(u, v_1) = f'(u, v_2) = 1$  and  $f'(u, y) = 0$  for every  $y \in V(H) \setminus \{v_1, v_2\}$ ;
- $f'(V(H_{u'})) = \min\{2, f(V(H_{u'})) + f(V(H_u)) - 2\}$ ;
- $f'(x, y) = f(x, y)$  for every  $x \in V(G) \setminus \{u, u'\}$  and  $y \in V(H)$ .

It is not difficult to check that  $f'$  is a secure  $(1, 0)$ -dominating function on  $G \circ H$  with  $\omega(f') \leq \omega(f)$  and  $|R_{f'}| < |R_f|$ , which is a contradiction. Therefore,  $R_f = \emptyset$ , and the result follows.  $\square$

We shall need the following two results.

**Theorem 3.2.** [18] *For any graph  $G$  with no isolated vertex and any nontrivial graph  $H$  with  $\gamma_{(1,0)}^s(H) \leq 2$  or  $\gamma_{(1,0,0)}^s(H) \geq 3$ ,*

$$\gamma_{(1,0)}^s(G \circ H) = \gamma_{(1,0,0)}^s(G \circ H).$$

**Proposition 3.3.** [22] *For any graph  $G$  and any integer  $n \geq 1$ ,*

$$\gamma_{(1,0,0)}^s(G \circ K_n) = \gamma_{(1,0,0)}^s(G)$$

The following result shows how the secure domination number of  $G \circ H$  is related to  $\gamma_w^s(G)$  or  $\gamma_w(G)$  for certain vectors  $w$  of three components. The decision on whether the components of  $w$  take specific values will depend on the value of  $\gamma_{(1,0)}^s(H)$  and  $\gamma(H)$ .



**Theorem 3.4.** *For a graph  $G$  with no isolated vertex and a nontrivial graph  $H$ , the following statements hold.*

(i) *If  $\gamma_{(1,0)}^s(H) = 1$ , i.e.,  $H$  is a complete graph, then  $\gamma_{(1,0)}^s(G \circ H) = \gamma_{(1,0,0)}^s(G)$ .*

(ii) *If  $\gamma_{(1,0)}^s(H) = 2$  and  $\gamma(H) = 1$ , then  $\gamma_{(1,0)}^s(G \circ H) = \gamma_{(2,1,0)}(G)$ .*

(iii) *If  $\gamma_{(1,0)}^s(H) \geq 3$  and  $\gamma(H) = 1$ , then  $\gamma_{(1,0)}^s(G \circ H) = \gamma_{(2,1,1)}(G)$ .*

(iv) *If  $\gamma_{(1,0)}^s(H) = \gamma(H) = 2$ , then  $\gamma_{(1,1,0)}^s(G) \leq \gamma_{(1,0)}^s(G \circ H) \leq \gamma_{(2,2,0)}(G)$ .*

(v) *If  $\gamma_{(1,0)}^s(H) > \gamma(H) = 2$ , then  $\gamma_{(1,0)}^s(G \circ H) = \gamma_{(2,2,1)}(G)$ .*

(vi) *If  $\gamma_{(1,0)}^s(H) = \gamma(H) = 3$ , then  $\gamma_{(2,2,1)}(G) \leq \gamma_{(1,0)}^s(G \circ H) \leq \gamma_{(2,2,2)}(G)$ .*

(vii) *If  $\gamma_{(1,0)}^s(H) \geq 4$  and  $\gamma(H) \geq 3$ , then  $\gamma_{(1,0)}^s(G \circ H) = \gamma_{(2,2,2)}(G)$ .*

*Proof.* Let  $f(V_0, V_1)$  be a  $\gamma_{(1,0)}^s(G \circ H)$ -function which satisfies Lemma 3.1. Let  $f'(X_0, X_1, X_2)$  be the function defined on  $G$  by  $X_1 = \{x \in V(G) : f(V(H_x)) = 1\}$  and  $X_2 = \{x \in V(G) : f(V(H_x)) = 2\}$ . Notice that  $\gamma_{(1,0)}^s(G \circ H) = \omega(f) = \omega(f')$ . With this notation in mind, we differentiate the following cases.

Case 1.  $\gamma_{(1,0)}^s(H) = 1$ . In this case,  $H$  is a complete graph. Hence, by Theorem 3.2 and Proposition 3.3 we deduce that  $\gamma_{(1,0)}^s(G \circ H) = \gamma_{(1,0,0)}^s(G \circ H) = \gamma_{(1,0,0)}^s(G)$ .

Case 2.  $\gamma_{(1,0)}^s(H) = 2$  and  $\gamma(H) = 1$ . In this case, if  $x \in X_0$ , then  $f'(N(x)) = f(N(V(H_x)) \setminus V(H_x)) \geq 2$ . Now, since  $\gamma_{(1,0)}^s(H) = 2$ , if  $x \in X_1$ , then  $f'(N(x)) = f(N(V(H_x)) \setminus V(H_x)) \geq 1$ . Therefore,  $f'$  is a  $(2, 1, 0)$ -dominating function on  $G$ , which implies that  $\gamma_{(1,0)}^s(G \circ H) = \omega(f) = \omega(f') \geq \gamma_{(2,1,0)}(G)$ .

On the other side, for any  $\gamma_{(2,1,0)}(G)$ -function  $g(W_0, W_1, W_2)$  and any universal vertex  $v$  of  $H$ , the function  $g'(W'_0, W'_1, W'_2)$ , defined by  $W'_1 = W_1 \times \{v\}$  and  $W'_2 = W_2 \times \{v\}$ , is a  $(2, 1, 0)$ -dominating function on  $G \circ H$ . Hence,  $\gamma_{(2,1,0)}(G \circ H) \leq \omega(g') = \omega(g) = \gamma_{(2,1,0)}(G)$ . Therefore, by Theorem 3.2 and Corollary 2.3 we conclude that  $\gamma_{(1,0)}^s(G \circ H) = \gamma_{(1,0,0)}^s(G \circ H) \leq \gamma_{(2,0,0)}(G \circ H) \leq \gamma_{(2,1,0)}(G \circ H) \leq \gamma_{(2,1,0)}(G)$ .

Case 3.  $\gamma_{(1,0)}^s(H) \geq 3$  and  $\gamma(H) = 1$ . As above, if  $x \in X_0$ , then  $f'(N(x)) = f(N(V(H_x)) \setminus V(H_x)) \geq 2$  and, since  $\gamma_{(1,0)}^s(H) \geq 3$ , if  $x \in X_1 \cup X_2$ , then  $f'(N(x)) = f(N(V(H_x)) \setminus V(H_x)) \geq 1$ . Hence,  $f'$  is a  $(2, 1, 1)$ -dominating function on  $G$ . Therefore,  $\gamma_{(1,0)}^s(G \circ H) = \omega(f) = \omega(f') \geq \gamma_{(2,1,1)}(G)$ .

On the other side, for any  $\gamma_{(2,1,1)}(G)$ -function  $g(W_0, W_1, W_2)$ , any universal vertex  $v$  of  $H$  and any  $v' \in V(H) \setminus \{v\}$ , the function  $g'(W'_0, W'_1)$ , defined by  $W'_1 = W_1 \times \{v\} \cup W_2 \times \{v, v'\}$ , is

a  $(1, 0)$ -dominating function on  $G \circ H$ . Now, for any  $(x, y) \in W'_0$  with  $x \in W_1 \cup W_2$ , we can see that  $g'_{(x,v) \rightarrow (x,y)}$  is a  $(1, 0)$ -dominating function on  $G \circ H$ , while for any  $(x, y) \in W_0 \times V(H)$  there exists  $x' \in W_2 \cap N(x)$  or  $x', x'' \in W_1 \cap N(x)$ , and so  $g'_{(x',v) \rightarrow (x,y)}$  is a  $(1, 0)$ -dominating function on  $G \circ H$ . Therefore,  $g'$  is a secure  $(1, 0)$ -dominating function on  $G \circ H$  and, as a consequence,  $\gamma_{(1,0)}^s(G \circ H) \leq \omega(g') = \omega(g) = \gamma_{(2,1,1)}(G)$ .

Case 4.  $\gamma_{(1,0)}^s(H) = \gamma(H) = 2$ . If  $x \in X_0 \cup X_1$ , then  $f'(N(x)) = f(N(V(H_x)) \setminus V(H_x)) \geq 1$ , which implies that  $f'$  is a  $(1, 1, 0)$ -dominating function on  $G$ . Now, for any  $(x, y) \in X_0 \times V(H)$ , there exists  $(x', y') \in M_f(x, y)$  with  $x' \in N(x) \cap (X_1 \cup X_2)$ . Hence, for any  $u \in X_0 \cup \{x'\}$  we have that  $f'_{x' \rightarrow x}(N(u)) = f_{(x',y') \rightarrow (x,y)}(N(V(H_u)) \setminus V(H_u)) \geq 1$ . Now, if  $u \in X_1$ , then as  $\gamma_{(1,0)}^s(H_u) = 2$  we have that  $f'_{x' \rightarrow x}(N(u)) = f_{(x',y') \rightarrow (x,y)}(N(V(H_u)) \setminus V(H_u)) \geq 1$ . Hence,  $f'$  is a secure  $(1, 1, 0)$ -dominating function on  $G$ . Therefore,  $\gamma_{(1,0)}^s(G \circ H) = \omega(f) = \omega(f') \geq \gamma_{(1,1,0)}^s(G)$ .

On the other side, for any  $\gamma_{(2,2,0)}(G)$ -function  $g(W_0, W_1, W_2)$  and any  $\gamma_{(1,0)}^s(H)$ -function  $h(Y_0, Y_1)$  with  $Y_1 = \{v_1, v_2\}$ , the function  $g'(W'_0, W'_1)$ , defined by  $W'_1 = W_1 \times \{v_1\} \cup W_2 \times Y_1$ , is a  $(1, 0)$ -dominating function on  $G \circ H$ . Now, for any  $(x, y) \in W'_0 \setminus W_2 \times V(H)$  and  $x' \in N(x) \cap (W_1 \cup W_2)$ , we can see that  $g'_{(x',v_1) \rightarrow (x,y)}$  is a  $(1, 0)$ -dominating function on  $G \circ H$ . Furthermore, for every  $(x, y) \in W'_0 \cap W_2 \times V(H)$  there exists  $v_i \in \{Y_1\} \cap M_h(y)$  such that  $g'_{(x,v_i) \rightarrow (x,y)}$  is a  $(1, 0)$ -dominating function on  $G \circ H$ . Therefore,  $\gamma_{(1,0)}^s(G \circ H) \leq \omega(g') = \omega(g) = \gamma_{(2,2,0)}(G)$ .

Case 5.  $\gamma_{(1,0)}^s(H) > \gamma(H) = 2$ . Since  $\gamma_{(1,0)}^s(H) \geq 3$ , if  $x \in X_0 \cup X_1$ , then  $f'(N(x)) = f(N(V(H_x)) \setminus V(H_x)) \geq 2$ , while if  $x \in X_2$ , then  $f'(N(x)) = f(N(V(H_x)) \setminus V(H_x)) \geq 1$ . Hence,  $f'$  is a  $(2, 2, 1)$ -dominating function on  $G$ . Therefore,  $\gamma_{(1,0)}^s(G \circ H) = \omega(f) = \omega(f') \geq \gamma_{(2,2,1)}(G)$ .

In order to prove that  $\gamma_{(1,0)}^s(G \circ H) \leq \gamma_{(2,2,1)}(G)$ , let  $g(W_0, W_1, W_2)$  be a  $\gamma_{(2,2,1)}(G)$ -function. If  $\gamma_{(1,0)}^s(H) > \gamma(H) = 2$ , then for any dominating set  $S = \{v_1, v_2\}$  of  $H$ , the function  $g'(W'_0, W'_1)$ , defined by  $W'_1 = W_1 \times \{v_1\} \cup W_2 \times S$ , is a  $(2, 1)$ -dominating function on  $G \circ H$ . Hence,  $\gamma_{(2,1)}(G \circ H) \leq \omega(g') = \omega(g) = \gamma_{(2,2,1)}(G)$ , and so Corollary 2.3 leads to  $\gamma_{(1,0)}^s(G \circ H) \leq \gamma_{(2,1)}(G \circ H) \leq \gamma_{(2,2,1)}(G)$ .

Case 6.  $\gamma_{(1,0)}^s(H) = \gamma(H) = 3$ . As in Case 5, we deduce that  $\gamma_{(1,0)}^s(G \circ H) \geq \gamma_{(2,2,1)}(G)$ .

In order to prove that  $\gamma_{(1,0)}^s(G \circ H) \leq \gamma_{(2,2,2)}(G)$ , let  $g(W_0, W_1, W_2)$  be a  $\gamma_{(2,2,2)}(G)$ -function and  $S = \{v_1, v_2\} \subseteq V(H)$ . The function  $g'(W'_0, W'_1)$ , defined by  $W'_1 = W_1 \times \{v_1\} \cup W_2 \times S$ , is a  $(2, 2)$ -dominating function on  $G \circ H$ . Hence,  $\gamma_{(2,2)}(G \circ H) \leq \omega(g') = \omega(g) = \gamma_{(2,2,2)}(G)$ . Therefore, Corollary 2.3 leads to  $\gamma_{(1,0)}^s(G \circ H) \leq \gamma_{(1,1)}^s(G \circ H) \leq \gamma_{(2,2)}(G \circ H) \leq \gamma_{(2,2,2)}(G)$ .

Case 7.  $\gamma_{(1,0)}^s(H) \geq 4$  and  $\gamma(H) \geq 3$ . In this case, it is easy to check that  $f'(N(x)) = f(N(V(H_x)) \setminus V(H_x)) \geq 2$  for every  $x \in V(G)$ . Therefore,  $f'$  is a  $(2, 2, 2)$ -dominating function on  $G$ , which implies that  $\gamma_{(1,0)}^s(G \circ H) = \omega(f) = \omega(f') \geq \gamma_{(2,2,2)}(G)$ .

Finally, as in Case 6, we can deduce that  $\gamma_{(2,2)}(G \circ H) \leq \gamma_{(2,2,2)}(G)$ , and so  $\gamma_{(1,0)}^s(G \circ H) \leq \gamma_{(1,1)}^s(G \circ H) \leq \gamma_{(2,2)}(G \circ H) \leq \gamma_{(2,2,2)}(G)$ .  $\square$

In order to show the behaviour of  $\gamma_{(1,0)}^s(G \circ H)$  when  $\gamma_{(1,0)}^s(H) = \gamma(H) = 2$ , we consider the following examples. For the graph  $G$  shown in Figure 1,  $\gamma_{(1,0)}^s(G \circ H) = \gamma_{(1,1,0)}^s(G) = 6 < 8 = \gamma_{(2,2,0)}(G)$ , while  $\gamma_{(1,1,0)}^s(G \cup C_4) = 9 < 10 = \gamma_{(1,0)}^s((G \cup C_4) \circ H) < 12 = \gamma_{(2,2,0)}(G \cup C_4)$  and  $\gamma_{(1,0)}^s(C_4 \circ H) = \gamma_{(2,2,0)}(C_4) = 4 > 3 = \gamma_{(1,1,0)}^s(C_4)$ .

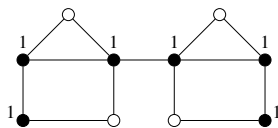

Figure 1: A graph  $G$ , where the labels assigned to the vertices correspond to the positive weights assigned by a  $\gamma_{(1,1,0)}^s(G)$ -function.

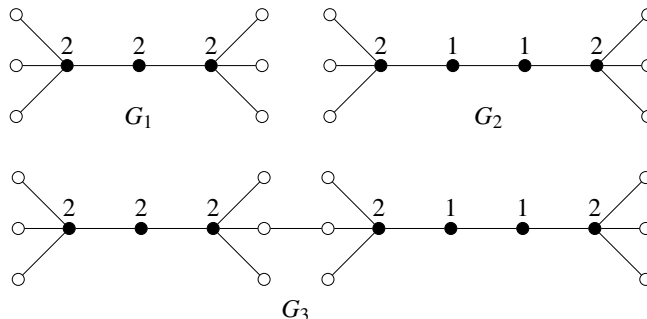

Figure 2: For any  $i \in \{1, 2, 3\}$ , the labels assigned to the vertices of  $G_i$  correspond to the positive weights assigned by a  $\gamma_{(1,0)}^s(G_i \circ H)$ -function to the different copies of  $H$  in  $G_i \circ H$ , where  $H$  is any graph with  $\gamma_{(1,0)}^s(H) = \gamma(H) = 3$ .

Analogously, for the case  $\gamma_{(1,0)}^s(H) = \gamma(H) = 3$ , we consider the graphs  $G_1$ ,  $G_2$  and  $G_3$  illustrated in Figure 2. The weights shown in Figure 2 correspond to the weights assigned by a  $\gamma_{(1,0)}^s(G_i \circ H)$ -function to the different copies of  $H$  in  $G_i \circ H$ . In particular,  $\gamma_{(1,0)}^s(G_1 \circ H) = \gamma_{(2,2,2)}(G_1) = 6$ ,  $\gamma_{(1,0)}^s(G_2 \circ H) = \gamma_{(2,2,1)}(G_2) = 6$  and  $\gamma_{(2,2,1)}(G_3) = 11 < 12 = \gamma_{(1,0)}^s(G_3 \circ H) < 14 = \gamma_{(2,2,2)}(G_3)$ .

We now discuss some particular cases of Theorem 3.4.

**Corollary 3.5.** *The following statements hold for any integers  $n, r \geq 4$  and a nontrivial graph  $H$ .*

- $\gamma_{(1,0)}^s(K_n \circ H) = \begin{cases} 1 & \text{if } H \text{ is a complete graph,} \\ 2 & \text{if } \gamma_{(1,0)}^s(H) > \gamma(H) = 1 \text{ or } \gamma_{(1,0)}^s(H) = \gamma(H) = 2, \\ 3 & \text{otherwise.} \end{cases}$
- $\gamma_{(1,0)}^s(K_{1,n-1} \circ H) = \begin{cases} 2 & \text{if } \gamma_{(1,0)}^s(H) \leq 2, \\ 4 & \text{if } \gamma_{(1,0)}^s(H) \geq 4 \text{ and } \gamma(H) \geq 3, \\ 3 & \text{otherwise.} \end{cases}$

$$\bullet \gamma_{(1,0)}^s(K_{2,n} \circ H) = \begin{cases} 2 & \text{if } H \text{ is a complete graph,} \\ 4 & \text{if } \gamma_{(1,0)}^s(H) \geq 2 \text{ and } \gamma(H) \geq 2, \\ 3 & \text{otherwise.} \end{cases}$$

$$\bullet \gamma_{(1,0)}^s(K_{3,n} \circ H) = \begin{cases} 3 & \text{if } H \text{ is a complete graph,} \\ 4 & \text{otherwise.} \end{cases}$$

$$\bullet \gamma_{(1,0)}^s(K_{n,r} \circ H) = 4.$$

*Proof.* It is not difficult to see that if  $\gamma_{(1,0)}^s(H) = \gamma(H) = 2$ , then  $\gamma_{(1,0)}^s(K_{2,n} \circ H) = \gamma_{(2,2,0)}(K_{2,n}) = 4$ . For the remaining cases, the result follows from Theorem 3.4 by considering the following facts.

$$\bullet \gamma_{(1,0,0)}^s(K_n) = 1, \gamma_{(2,1,0)}(K_n) = \gamma_{(2,1,1)}(K_n) = \gamma_{(1,1,0)}^s(K_n) = \gamma_{(2,2,0)}(K_n) = 2 \text{ and } \gamma_{(2,2,1)}(K_n) = \gamma_{(2,2,2)}(K_n) = 3.$$

$$\bullet \gamma_{(1,0,0)}^s(K_{1,n-1}) = \gamma_{(2,1,0)}(K_{1,n-1}) = \gamma_{(1,1,0)}^s(K_{1,n-1}) = \gamma_{(2,2,0)}(K_{1,n-1}) = 2, \gamma_{(2,1,1)}(K_{1,n-1}) = \gamma_{(2,2,1)}(K_{1,n-1}) = 3 \text{ and } \gamma_{(2,2,2)}(K_{1,n-1}) = 4.$$

$$\bullet \gamma_{(1,0,0)}^s(K_{2,n}) = 2, \gamma_{(2,1,0)}(K_{2,n}) = \gamma_{(2,1,1)}(K_{2,n}) = 3 \text{ and } \gamma_{(2,2,1)}(K_{2,n}) = \gamma_{(2,2,2)}(K_{2,n}) = 4.$$

$$\bullet \gamma_{(1,0,0)}^s(K_{3,n}) = 3 \text{ and } \gamma_{(2,1,0)}(K_{3,n}) = \gamma_{(2,1,1)}(K_{3,n}) = \gamma_{(1,1,0)}^s(K_{3,n}) = \gamma_{(2,2,0)}(K_{3,n}) = \gamma_{(2,2,1)}(K_{3,n}) = \gamma_{(2,2,2)}(K_{3,n}) = 4.$$

$$\bullet \gamma_{(1,0,0)}^s(K_{n,r}) = \gamma_{(2,1,0)}(K_{n,r}) = \gamma_{(1,1,0)}^s(K_{n,r}) = \gamma_{(2,2,0)}(K_{n,r}) = \gamma_{(2,1,1)}(K_{n,r}) = \gamma_{(2,2,1)}(K_{n,r}) = \gamma_{(2,2,2)}(K_{n,r}) = 4.$$

□

Next we consider the particular case when  $G$  is a path. As we will see, this case has been partially studied in previous works.

**Theorem 3.6.** *For any integer  $n \geq 6$  and any nontrivial graph  $H$ , the following statements hold.*

(i) [17] *If  $\gamma_{(1,0)}^s(H) = 1$ , i.e.,  $H$  is a complete graph, then  $\gamma_{(1,0)}^s(P_n \circ H) = \gamma_{(1,0,0)}^s(P_n) = \lceil \frac{3n}{7} \rceil$ .*

(ii) [18] *If  $\gamma_{(1,0)}^s(H) = 2$  and  $\gamma(H) = 1$ , then  $\gamma_{(1,0)}^s(P_n \circ H) = 2 \lceil \frac{n}{3} \rceil$ .*

(iii) [18] *If  $\gamma_{(1,0)}^s(H) \geq 3$  and  $\gamma(H) = 1$ , then  $\gamma_{(1,0)}^s(P_n \circ H) = \begin{cases} \frac{2n}{3} + 1 & \text{if } n \equiv 0 \pmod{3}, \\ 2 \lceil \frac{n}{3} \rceil & \text{otherwise.} \end{cases}$*

(iv) [18] *If  $\gamma_{(1,0)}^s(H) = \gamma(H) = 2$ , then  $\gamma_{(1,0)}^s(P_n \circ H) = 2 \lfloor \frac{n+2}{3} \rfloor$ .*

(v) *If  $\gamma_{(1,0)}^s(H) > \gamma(H) = 2$ , then*

$$\gamma_{(1,0)}^s(P_n \circ H) = \gamma_{(2,2,1)}(P_n) = \begin{cases} n - \lfloor \frac{n}{7} \rfloor + 1 & \text{if } n \equiv 1, 2 \pmod{7}, \\ n - \lfloor \frac{n}{7} \rfloor & \text{otherwise.} \end{cases}$$

(vi) *If  $\gamma_{(1,0)}^s(H) = \gamma(H) = 3$ , then*

$$\gamma_{(1,0)}^s(P_n \circ H) = \begin{cases} n - \lfloor \frac{n}{11} \rfloor + 1 & \text{if } n \equiv 1, 2, 5 \pmod{11}, \\ n - \lfloor \frac{n}{11} \rfloor & \text{otherwise.} \end{cases}$$

(vii) *If  $\gamma_{(1,0)}^s(H) \geq 4$  and  $\gamma(H) \geq 3$ , then*

$$\gamma_{(1,0)}^s(P_n \circ H) = \gamma_{(2,2,2)}(P_n) = \begin{cases} n & \text{if } n \equiv 0 \pmod{4}, \\ n + 1 & \text{if } n \equiv 1, 3 \pmod{4}, \\ n + 2 & \text{if } n \equiv 2 \pmod{4}. \end{cases}$$

*Proof.* The proofs of (v) and (vii) are derived by combining Theorem 3.4 with the values of  $\gamma_{(2,2,1)}(P_n)$  and  $\gamma_{(2,2,2)}(P_n)$  obtained in [4]. It remains to prove (vi).

Assume that  $\gamma_{(1,0)}^s(H) = \gamma(H) = 3$  and let  $f(V_0, V_1)$  be a  $\gamma_{(1,0)}^s(P_n \circ H)$ -function which satisfies Lemma 3.1. Let  $f'(X_0, X_1, X_2)$  be the function defined on  $P_n$  by  $X_1 = \{x \in V(P_n) : f(V(H_x)) = 1\}$  and  $X_2 = \{x \in V(P_n) : f(V(H_x)) = 2\}$ . Notice that  $\gamma_{(1,0)}^s(P_n \circ H) = \omega(f) = \omega(f')$ . Let  $n = 11q + r$  with  $r \in \{0, \dots, 10\}$ . With this notation in mind, we proceed by induction on  $q$ .

It is not difficult to check that the result follows for  $q = 0$  and  $r \in \{6, \dots, 10\}$ . For these cases, possible sequences of weights assigned by  $f'$  to consecutive vertices of  $P_r$  are 021120, 1200220, 02200220, 021012120 and 0210121012, respectively. The result also follows for  $q = 1$  and  $r = 0$ , i.e.,  $n = 11$ . In this case, the only possible sequence of weights assigned by  $f'$  to consecutive vertices of  $P_{11}$  is 02101210120. The certainty that the result holds for  $q = 1$  and  $r \in \{3, 4, 6, \dots, 10\}$  comes from a computer search. For these cases, since  $P_{11+r}$

can be obtained by connecting a leaf of  $P_{11}$  with a leaf  $P_r$ , possible sequences of weights assigned by  $f'$  to consecutive vertices of  $P_{11+r}$  are obtained by concatenating the sequences of weights associated to  $P_{11}$  and  $P_r$ , where the sequences for  $r = 3$  and  $r = 4$  are 120, 0220, respectively. In summary, for any  $r \in \{0, 3, 4, 6, \dots, 10\}$ , we have that  $\gamma_{(1,0)}^s(P_{11+r} \circ H) = 10 + r$ . Analogously, among the possible sequences of weights assigned by  $f'$  to consecutive vertices of  $P_{12}$ ,  $P_{13}$  and  $P_{16}$ , a computer search gives, for instance, 022101200220, 0210210220120 and 0211200220021120, respectively. Thus,  $\gamma_{(1,0)}^s(P_{12} \circ H) = 12$ ,  $\gamma_{(1,0)}^s(P_{13} \circ H) = 13$  and  $\gamma_{(1,0)}^s(P_{16} \circ H) = 16$ , which completes the base case.

Assume that  $q \geq 2$  and the statement holds for any  $q'$  such that  $1 \leq q' \leq q$ . We differentiate two cases.

Case 1.  $r \notin \{1, 2, 5\}$ . In this case,

$$\gamma_{(1,0)}^s(P_{11q+r} \circ H) = 10q + r.$$

Let  $n = 11(q+1) + r$ ,  $k_1 = \gamma_{(1,0)}^s(P_n \circ H)$ ,  $P_n = x_1 x_2 \dots x_n$  and  $k_2 = f'(\{x_1, \dots, x_{11}\})$ . Suppose that  $k_1 < 10(q+1) + r$ . Since 02101210120 is the only possible sequence of weights assigned by  $f'$  to consecutive vertices of  $P_{11}$ , we have that  $k_2 \geq 10$ , and

$$(k_2 - 10) + f'(\{x_{12}, \dots, x_n\}) = k_1 - 10 < 10q + r.$$

Since the function  $g$ , defined as  $g(V(H_{x_{13}})) = f(V(H_{x_{13}})) + k_2 - 10$  and  $g(V(H_{x_i})) = f(V(H_{x_i}))$  for every  $i \in \{12\} \cup \{14, \dots, n\}$ , is a secure  $(1, 0)$ -dominating function on the subgraph of  $P_n \circ H$  induced by  $\{x_{12}, \dots, x_n\} \times V(H)$ , we can conclude that  $\gamma_{(1,0)}^s(P_{11q+r} \circ H) \leq \omega(g) = k_1 - 10 < 10q + r$ , which contradicts the hypothesis. Thus,  $\gamma_{(1,0)}^s(P_n \circ H) \geq 10(q+1) + r$ . To conclude the proof, we only need to observe that  $P_n$  is obtained by connecting a leaf of  $P_{11q+r}$  with a leaf of  $P_{11}$ , and so, by hypothesis,  $\gamma_{(1,0)}^s(P_n \circ H) \leq \gamma_{(1,0)}^s(P_{11q+r} \circ H) + \gamma_{(1,0)}^s(P_{11} \circ H) = 10(q+1) + r$ . Therefore, the proof of this case is complete.

Case 2.  $r \in \{1, 2, 5\}$ . This case is completely analogous to Case 1. The only difference is the induction hypothesis, which states that  $\gamma_{(1,0)}^s(P_{11q+r} \circ H) = 10q + r + 1$ . Hence, we take  $n = 11(q+1) + r$  and following the procedure described above, we deduce that  $\gamma_{(1,0)}^s(P_n \circ H) = 10(q+1) + r + 1$ , which completes the proof.  $\square$

The next result concerns the case when  $G$  is a cycle.

**Theorem 3.7.** *For any integer  $n \geq 6$  and a nontrivial graph  $H$ , the following statements hold.*

- (i) [17] *If  $\gamma_{(1,0)}^s(H) = 1$ , i.e.,  $H$  is a complete graph, then  $\gamma_{(1,0)}^s(C_n \circ H) = \gamma_{(1,0,0)}^s(C_n) = \lceil \frac{3n}{7} \rceil$ .*
- (ii) [18] *If  $\gamma_{(1,0)}^s(H) \geq 2$  and  $\gamma(H) = 1$ , then  $\gamma_{(1,0)}^s(C_n \circ H) = \lceil \frac{2n}{3} \rceil$ .*
- (iii) [18] *If  $\gamma_{(1,0)}^s(H) = \gamma(H) = 2$ , then  $\gamma_{(1,0)}^s(C_n \circ H) = 2 \lfloor \frac{n+2}{3} \rfloor$ .*

(iv) If  $\gamma_{(1,0)}^s(H) > \gamma(H) = 2$ , then

$$\gamma_{(1,0)}^s(C_n \circ H) = \gamma_{(2,2,1)}(C_n) = \begin{cases} n - \lfloor \frac{n}{7} \rfloor + 1 & \text{if } n \equiv 1, 2 \pmod{7}, \\ n - \lfloor \frac{n}{7} \rfloor & \text{otherwise.} \end{cases}$$

(v) If  $\gamma_{(1,0)}^s(H) = \gamma(H) = 3$ , then

$$\gamma_{(1,0)}^s(C_n \circ H) = \begin{cases} n - \lfloor \frac{n}{11} \rfloor + 1 & \text{if } n \equiv 1, 2, 5 \pmod{11}, \\ n - \lfloor \frac{n}{11} \rfloor & \text{otherwise.} \end{cases}$$

(vi) If  $\gamma_{(1,0)}^s(H) \geq 4$  and  $\gamma(H) \geq 3$ , then  $\gamma_{(1,0)}^s(C_n \circ H) = \gamma_{(2,2,2)}(C_n) = n$ .

*Proof.* The proofs of (iv) and (vi) are derived by combining Theorem 3.4 with the values of  $\gamma_{(2,2,1)}(C_n)$  and  $\gamma_{(2,2,2)}(C_n)$  obtained in [4]. It remains to prove (v).

Assume that  $\gamma_{(1,0)}^s(H) = \gamma(H) = 3$  and let  $f(V_0, V_1)$  be a  $\gamma_{(1,0)}^s(C_n \circ H)$ -function which satisfies Lemma 3.1. Let  $f'(X_0, X_1, X_2)$  be the function defined on  $C_n$  by  $X_1 = \{x \in V(C_n) : f(V(H_x)) = 1\}$  and  $X_2 = \{x \in V(C_n) : f(V(H_x)) = 2\}$ . Notice that  $\gamma_{(1,0)}^s(C_n \circ H) = \omega(f) = \omega(f')$ .

Let  $V(C_n) = \{x_0, \dots, x_{n-1}\}$ , where consecutive vertices are adjacent and the addition of subscripts is taken modulo  $n$ . If there exists  $x_i \in V(C_n)$  such that  $f(x_i) = f(x_{i+1}) = 0$ , then  $\gamma_{(1,0)}^s(C_n \circ H) = \gamma_{(1,0)}^s(P_n \circ H)$  and we derive the result by Theorem 3.6. From now on, we assume that for any  $x_i \in X_0$  we have that  $f'(x_{i-1}) > 0$  and  $f'(x_{i+1}) > 0$ , which implies that  $f'(x_{i-2}) + f'(x_{i-1}) \geq 3$  and  $f'(x_{i+1}) + f'(x_{i+2}) \geq 3$ . Now, for any  $x_i \in X_0$  we define  $S_i = \{x_i, x_{i+1}, x_{i+2}\}$  and  $S = V(C_n) \setminus (\cup_{x_i \in X_0} S_i)$ . Notice that  $f(S_i) \geq 3 = |S_i|$  for every  $x_i \in X_0$  and  $f(x_j) > 0$  for every  $x_j \in S$ . Hence, by Proposition 2.4,

$$\gamma_{(1,0)}^s(P_n \circ H) \geq \gamma_{(1,0)}^s(C_n \circ H) = \omega(f') = \sum_{x_i \in X_0} f'(S_i) + f'(S) \geq n.$$

This implies that  $n \in \{6, \dots, 10, 12, 13, 15\}$  and  $\gamma_{(1,0)}^s(C_n \circ H) = n$ . Therefore, the result follows.  $\square$

As a direct consequence of Theorems 3.4, 3.6 and 3.7 we derive the following result.

**Proposition 3.8.** *The following statements hold for any integer  $n \geq 4$ .*

- $\gamma_{(2,1,1)}(P_n) = \begin{cases} \frac{2n}{3} + 1 & \text{if } n \equiv 0 \pmod{3}, \\ 2 \lceil \frac{n}{3} \rceil & \text{otherwise.} \end{cases}$
- $\gamma_{(2,1,1)}(C_n) = \lceil \frac{2n}{3} \rceil$ .

### 3.2 Weak Roman domination

This subsection is devoted to study the weak Roman domination of lexicographic product graphs. To this end, we need the following tools.

**Remark 3.9.** [22] *Given a noncomplete graph  $G$ , the following statements are equivalent.*

- $\gamma_{(1,0,0)}^s(G) = 2$ .
- $\gamma(G) = 1$  or  $\gamma_{(1,0)}^s(G) = 2$ .

**Lemma 3.10.** *For any graph  $G$  with no isolated vertex and any nontrivial graph  $H$  with  $\gamma(H) = 1$ , there exists a  $\gamma_{(1,0,0)}^s(G \circ H)$ -function  $f$  such that  $f(V(H_u)) \leq 2$ , for every  $u \in V(G)$ .*

*Proof.* Given a secure  $(1, 0, 0)$ -dominating function  $f$  on  $G \circ H$ , we define  $R_f = \{x \in V(G) : f(V(H_x)) \geq 3\}$ . Let  $f(V_0, V_1, V_2)$  be a  $\gamma_{(1,0,0)}^s(G \circ H)$ -function such that  $|R_f|$  is minimum among all  $\gamma_{(1,0,0)}^s(G \circ H)$ -functions.

Suppose that  $|R_f| \geq 1$ . Let  $u \in R_f$ ,  $u' \in N(u)$  and  $v$  be a universal vertex of  $H$ . Notice that the function  $f'$  on  $G \circ H$ , defined by  $f'(u, v) = f'(V(H_u)) = 2$ ,  $f'(V(H_{u'})) = \min\{2, f(V(H_{u'})) + 1\}$ , and  $f'(x, y) = f(x, y)$  for every  $x \in V(G) \setminus \{u, u'\}$  and  $y \in V(H)$ , is a secure  $(1, 0, 0)$ -dominating function on  $G \circ H$  with  $\omega(f') \leq \omega(f)$  and  $|R_{f'}| < |R_f|$ , which is a contradiction. Therefore,  $R_f = \emptyset$ , and so the result follows.  $\square$

Our goal is to show how the weak Roman domination number of  $G \circ H$  is related to  $\gamma_w^s(G)$  or  $\gamma_w(G)$  for certain vectors  $w$  of three components. By Theorems 3.2 and 3.4, the outstanding case is when  $\gamma_{(1,0)}^s(H) \geq 3$  and  $\gamma_{(1,0,0)}^s(H) = 2$ , which is equivalent to  $\gamma(H) = 1$  and  $\gamma_{(1,0)}^s(H) \geq 3$ , by Remark 3.9. In fact, we will present the result with the only assumption on  $H$  of being a noncomplete graph with  $\gamma(H) = 1$ .

**Theorem 3.11.** *For any graph  $G$  with no isolated vertex and any noncomplete graph  $H$  with  $\gamma(H) = 1$ ,*

$$\gamma_{(1,0,0)}^s(G \circ H) = \gamma_{(2,1,0)}(G).$$

*Proof.* Let  $H$  be a noncomplete graph with  $\gamma(H) = 1$  and  $f(V_0, V_1, V_2)$  a  $\gamma_{(1,0,0)}^s(G \circ H)$ -function which satisfies Lemma 3.10. Let  $f'(X_0, X_1, X_2)$  be the function defined on  $G$  by  $X_1 = \{x \in V(G) : f(V(H_x)) = 1\}$  and  $X_2 = \{x \in V(G) : f(V(H_x)) = 2\}$ . Since  $\gamma_{(1,0,0)}^s(H) = 2$ , if  $x \in X_0$ , then  $f'(N(x)) = f(N(V(H_x)) \setminus V(H_x)) \geq 2$  and if  $x \in X_1$ , then  $f'(N(x)) = f(N(V(H_x)) \setminus V(H_x)) \geq 1$ . Hence,  $f'$  is a  $(2, 1, 0)$ -dominating function on  $G$ , which implies that  $\gamma_{(1,0,0)}^s(G \circ H) = \omega(f) = \omega(f') \geq \gamma_{(2,1,0)}(G)$ .

Now, we show that  $\gamma_{(1,0,0)}^s(G \circ H) \leq \gamma_{(2,1,0)}(G)$ . Let  $v$  be a universal vertex of  $H$ . For any  $\gamma_{(2,1,0)}(G)$ -function  $g(W_0, W_1, W_2)$ , the function  $g'(W'_0, W'_1, W'_2)$ , defined by  $W'_1 = W_1 \times \{v\}$  and  $W'_2 = W_2 \times \{v\}$ , is a  $(1, 0, 0)$ -dominating function on  $G \circ H$ . Now, for any  $(x, y) \in W'_0 \setminus W_0 \times V(H)$ , we can see that  $g'_{(x,v) \rightarrow (x,y)}$  is a  $(1, 0, 0)$ -dominating function on  $G \circ H$ . Furthermore, for every  $x \in W_0$  there exists  $x' \in W_2 \cap N(x)$  or two vertices  $x', x'' \in W_1 \cap N(x)$ , and so  $g'_{(x',v) \rightarrow (x,y)}$  is a  $(1, 0, 0)$ -dominating function on  $G \circ H$  for every  $(x, y) \in W_0 \times V(H)$ . Therefore,  $g'$  is a secure  $(1, 0, 0)$ -dominating function on  $G \circ H$ , and as a consequence,  $\gamma_{(1,0,0)}^s(G \circ H) \leq \omega(g') = \omega(g) = \gamma_{(2,1,0)}(G)$ .  $\square$



We next present some particular cases of Theorem 3.11.

**Corollary 3.12.** *Let  $n$  and  $r$  be two integers such that  $n \geq r \geq 2$ . If  $H$  is a noncomplete graph with  $\gamma(H) = 1$ , then the following statements hold.*

- $\gamma_{(1,0,0)}^s(K_n \circ H) = 2$ .
- $\gamma_{(1,0,0)}^s(K_{1,n-1} \circ H) = 2$ .
- $\gamma_{(1,0,0)}^s(K_{n,r} \circ H) = \begin{cases} 3 & \text{if } r = 2, \\ 4 & \text{otherwise.} \end{cases}$

*Proof.* Theorem 3.11 leads to the result, as  $\gamma_{(2,1,0)}(K_n) = \gamma_{(2,1,0)}(K_{1,n-1}) = 2$ ,  $\gamma_{(2,1,0)}(K_{n,2}) = 3$  and  $\gamma_{(2,1,0)}(K_{n,r}) = 4$  whenever  $r \geq 3$ .  $\square$

To conclude this section, we would present the following result which shows that the study of the cases  $G \cong P_n$  and  $G \cong C_n$  is complete.

**Theorem 3.13.** [18] *For any integer  $n \geq 3$  and any noncomplete graph with  $\gamma(H) = 1$ ,*

$$\gamma_{(1,0,0)}^s(P_n \circ H) = 2 \left\lceil \frac{n}{3} \right\rceil \quad \text{and} \quad \gamma_{(1,0,0)}^s(C_n \circ H) = \left\lceil \frac{2n}{3} \right\rceil.$$

### 3.3 Secure total domination and total weak Roman domination

It was shown in [9] that for any graph  $G$  with no isolated vertex and any nontrivial graph  $H$  the secure total domination number of  $G \circ H$  equals the total weak Roman domination number.

**Theorem 3.14.** [9] *For any graph  $G$  with no isolated vertex and any nontrivial graph  $H$ ,*

$$\gamma_{(1,1,1)}^s(G \circ H) = \gamma_{(1,1)}^s(G \circ H).$$

According to Theorem 3.14, we can restrict ourselves to study the secure total domination number of  $G \circ H$ . To this end, we shall need the following lemma.

**Lemma 3.15.** [9] *For any graph  $G$  with no isolated vertex and any nontrivial graph  $H$ , there exists a  $\gamma_{(1,1)}^s(G \circ H)$ -function  $f$  satisfying that  $f(V(H_u)) \leq 2$  for every  $u \in V(G)$ .*

The following result shows that the secure total domination number of  $G \circ H$  equals  $\gamma_w^s(G)$  or  $\gamma_w(G)$  for certain vectors  $w$  of three components. As we can expect, the decision on whether the components of  $w$  take specific values will depend on the value of  $\gamma_{(1,1)}^s(H)$  and/or  $\gamma(H)$ .

**Theorem 3.16.** *For a graph  $G$  with no isolated vertex and a nontrivial graph  $H$ , the following statements hold.*

- (i) *If  $\gamma_{(1,1)}^s(H) = 2$ , then  $\gamma_{(1,1)}^s(G \circ H) = \gamma_{(1,1,0)}^s(G)$ .*

(ii) If  $\gamma(H) = 1$  and  $\gamma_{(1,1)}^s(H) \geq 3$ , then  $\gamma_{(1,1)}^s(G \circ H) = \gamma_{(1,1,1)}^s(G)$ .

(iii) If  $\gamma(H) = 2 < \gamma_{(1,1)}^s(H)$ , then  $\gamma_{(1,1)}^s(G \circ H) = \gamma_{(2,2,1)}(G)$ .

(iv) If  $\gamma(H) \geq 3$ , then  $\gamma_{(1,1)}^s(G \circ H) = \gamma_{(2,2,2)}(G)$ .

*Proof.* Let  $f(V_0, V_1)$  be a  $\gamma_{(1,1)}^s(G \circ H)$ -function which satisfies Lemma 3.15. Let  $f'(X_0, X_1, X_2)$  be the function defined on  $G$  by  $X_1 = \{x \in V(G) : f(V(H_x)) = 1\}$  and  $X_2 = \{x \in V(G) : f(V(H_x)) = 2\}$ . With this notation in mind, we differentiate the following four cases.

Case 1.  $\gamma_{(1,1)}^s(H) = 2$ . If  $x \in X_0 \cup X_1$ , then  $f'(N(x)) = f(N(V(H_x)) \setminus V(H_x)) \geq 1$ , which implies that  $f'$  is a  $(1, 1, 0)$ -dominating function on  $G$ . Now, for any  $(x, y) \in X_0 \times V(H)$ , there exists  $(x', y') \in M_f(x, y)$  with  $x' \in N(x) \cap (X_1 \cup X_2)$ . Hence, for any  $u \in X_0 \cup X_1 \cup \{x'\}$  we have that  $f'_{x' \rightarrow x}(N(u)) = f_{(x', y') \rightarrow (x, y)}(N(V(H_u)) \setminus V(H_u)) \geq 1$ , which implies that  $f'$  is a secure  $(1, 1, 0)$ -dominating function on  $G$ . Therefore,  $\gamma_{(1,1)}^s(G \circ H) = \omega(f) = \omega(f') \geq \gamma_{(1,1,0)}^s(G)$ .

On the other side, for any  $\gamma_{(1,1,0)}^s(G)$ -function  $g(W_0, W_1, W_2)$  and any two universal vertices  $v_1, v_2$  of  $H$ , the function  $g'(W'_0, W'_1)$ , defined by  $W'_1 = (W_1 \times \{v_1\}) \cup (W_2 \times \{v_1, v_2\})$ , is a  $(1, 1)$ -dominating function on  $G \circ H$ . Now, for any  $(x, y) \in W'_0 \setminus W_0 \times V(H)$ , we can see that  $g'_{(x, v_1) \rightarrow (x, y)}$  is a  $(1, 1)$ -dominating function on  $G \circ H$ . Furthermore, for every  $x \in W_0$  there exists  $x' \in M_g(x)$ , and so  $g'_{(x', v_1) \rightarrow (x, y)}$  is a  $(1, 1)$ -dominating function on  $G \circ H$  for every  $(x, y) \in W_0 \times V(H)$ . Therefore,  $\gamma_{(1,1)}^s(G \circ H) \leq \omega(g') = \omega(g) = \gamma_{(1,1,0)}^s(G)$ .

Case 2.  $\gamma(H) = 1$  and  $\gamma_{(1,1)}^s(H) \geq 3$ . Since  $f(V(H_x)) \leq 2$  and  $\gamma_{(1,1)}^s(H_x) \geq 3$  for any  $x \in V(G)$ , we have that  $f'(N(x)) = f(N(V(H_x)) \setminus V(H_x)) \geq 1$ . Thus,  $f'$  is a  $(1, 1, 1)$ -dominating function on  $G$ . Now, for any  $(x, y) \in X_0 \times V(H)$ , there exists  $(x', y') \in M_f(x, y)$  with  $x' \in N(x) \cap (X_1 \cup X_2)$ . Hence, for any  $u \in V(G)$  we have that  $f'_{x' \rightarrow x}(N(u)) = f_{(x', y') \rightarrow (x, y)}(N(V(H_u)) \setminus V(H_u)) \geq 1$ , which implies that  $f'$  is a secure  $(1, 1, 1)$ -dominating function on  $G$ . Therefore,  $\gamma_{(1,1)}^s(G \circ H) = \omega(f) = \omega(f') \geq \gamma_{(1,1,1)}^s(G)$ .

Now we show that  $\gamma_{(1,1)}^s(G \circ H) \leq \gamma_{(1,1,1)}^s(G)$ . Let  $v$  be the universal vertex of  $H$ , which is unique, as  $\gamma_{(1,1)}^s(H) \geq 3$ . For any  $\gamma_{(1,1,1)}^s(G)$ -function  $g(W_0, W_1, W_2)$ , the function  $g'(W'_0, W'_1, W'_2)$ , defined by  $W'_1 = W_1 \times \{v\}$  and  $W'_2 = W_2 \times \{v\}$ , is a  $(1, 1, 1)$ -dominating function on  $G \circ H$ . Now, for any  $(x, y) \in W'_0 \setminus W_0 \times V(H)$ , we can see that  $g'_{(x, v) \rightarrow (x, y)}$  is a  $(1, 1, 1)$ -dominating function on  $G \circ H$ . Furthermore, for every  $x \in W_0$  there exists  $x' \in M_g(x)$ , and so  $g'_{(x', v) \rightarrow (x, y)}$  is a  $(1, 1, 1)$ -dominating function on  $G \circ H$  for every  $(x, y) \in W_0 \times V(H)$ . Therefore,  $g'$  is a secure  $(1, 1, 1)$ -dominating function on  $G \circ H$ , and by Theorem 3.14 we deduce that  $\gamma_{(1,1)}^s(G \circ H) = \gamma_{(1,1,1)}^s(G \circ H) \leq \omega(g') = \omega(g) = \gamma_{(1,1,1)}^s(G)$ .

Case 3.  $\gamma(H) = 2 < \gamma_{(1,1)}^s(H)$ . Assume first that  $x \in X_0 \cup X_1$ . Since  $\gamma_{(1,1)}^s(H_x) \geq 3$ , we have that  $f'(N(x)) = f(N(V(H_x)) \setminus V(H_x)) \geq 2$ . Analogously, for any  $x \in X_2$  we deduce that  $f'(N(x)) = f(N(V(H_x)) \setminus V(H_x)) \geq 1$ . Therefore,  $f'$  is a  $(2, 2, 1)$ -dominating function on  $G$  and, as a consequence,  $\gamma_{(1,1)}^s(G \circ H) = \omega(f) = \omega(f') \geq \gamma_{(2,2,1)}(G)$ .

On the other side, for any  $\gamma_{(2,2,1)}(G)$ -function  $g(W_0, W_1, W_2)$  and any  $\gamma(H)$ -set  $\{v_1, v_2\}$ , the function  $g'(W'_0, W'_1)$ , defined by  $W'_1 = (W_1 \times \{v_1\}) \cup (W_2 \times \{v_1, v_2\})$ , is a  $(1, 1)$ -dominating

function on  $G \circ H$ . Now, for any  $(x, y) \in W'_0 \setminus W_2 \times V(H)$  and  $x' \in N(x) \cap (W_1 \cup W_2)$  we have that  $g'_{(x',v_1) \rightarrow (x,y)}(N(u, v)) \geq 1$  for every  $(u, v) \in V(G \circ H)$ . Moreover, for any  $(x, y) \in W'_0 \cap (W_2 \times V(H))$  we have that  $g'_{(x,v_1) \rightarrow (x,y)}(N(u, v)) \geq 1$  or  $g'_{(x,v_2) \rightarrow (x,y)}(N(u, v)) \geq 1$  for every  $(u, v) \in V(G \circ H)$ . Therefore,  $g'$  is a secure  $(1, 1)$ -dominating function on  $G \circ H$ , which implies that  $\gamma_{(1,1)}^s(G \circ H) \leq \omega(g') = \omega(g) = \gamma_{(2,2,1)}(G)$ .

Case 4.  $\gamma(H) \geq 3$ . In this case, for every  $x \in V(G)$ , there exists  $y \in V(H)$  such that  $f(N[(x, y)] \cap V(H_x)) = 0$ . Hence,  $f'(N(x)) = f(N(x, y) \setminus V(H_x)) \geq 2$  for every  $x \in V(G)$ . Therefore,  $f'$  is a  $(2, 2, 2)$ -dominating function on  $G$ , and so  $\gamma_{(1,1)}^s(G \circ H) = \omega(f) = \omega(f') \geq \gamma_{(2,2,2)}(G)$ .

Now, for any  $\gamma_{(2,2,2)}(G)$ -function  $g(W_0, W_1, W_2)$  and any  $v \in V(H)$ , the function  $g'(W'_0, W'_1, W'_2)$ , defined by  $W'_2 = W_2 \times \{v\}$  and  $W'_1 = W_1 \times \{v\}$ , is a secure  $(2, 2, 2)$ -dominating function on  $G \circ H$ . Therefore,  $\gamma_{(2,2,2)}(G \circ H) \leq \omega(g')$ , and by Theorems 2.2 and 3.14 we deduce that  $\gamma_{(1,1)}^s(G \circ H) = \gamma_{(1,1,1)}^s(G \circ H) \leq \gamma_{(2,2,2)}(G \circ H) \leq \omega(g') = \omega(g) = \gamma_{(2,2,2)}(G)$ . According to the cases above, the result follows.  $\square$

The following result is a particular case of Theorem 3.16.

**Corollary 3.17.** *The following statements hold for a nontrivial graph  $H$  and any integers  $n, r$  such that  $n \geq r \geq 2$ .*

- $\gamma_{(1,1)}^s(K_n \circ H) = \begin{cases} 2 & \text{if } \gamma(H) = 1, \\ 3 & \text{otherwise.} \end{cases}$
- $\gamma_{(1,1)}^s(K_{1,n-1} \circ H) = \begin{cases} 2 & \text{if } \gamma_{(1,1)}^s(H) = 2, \\ 4 & \text{if } \gamma(H) \geq 3, \\ 3 & \text{otherwise.} \end{cases}$
- $\gamma_{(1,1)}^s(K_{n,r} \circ H) = \begin{cases} 3 & \text{if } \gamma(H) = 1 \text{ and } r = 2, \\ 4 & \text{otherwise.} \end{cases}$

*Proof.* The result follows from Theorem 3.16 by considering the following facts.

- $\gamma_{(1,1,0)}^s(K_n) = \gamma_{(1,1,1)}^s(K_n) = 2$  and  $\gamma_{(2,2,1)}(K_n) = \gamma_{(2,2,2)}(K_n) = 3$ .
- $\gamma_{(1,1,0)}^s(K_{1,n-1}) = 2$ ,  $\gamma_{(1,1,1)}^s(K_{1,n-1}) = \gamma_{(2,2,1)}(K_{1,n-1}) = 3$  and  $\gamma_{(2,2,2)}(K_{1,n-1}) = 4$ .
- If  $r = 2$ , then  $\gamma_{(1,1,0)}^s(K_{n,r}) = \gamma_{(1,1,1)}^s(K_{n,r}) = 3$ , while if  $r \geq 3$ , then  $\gamma_{(1,1,0)}^s(K_{n,r}) = \gamma_{(1,1,1)}^s(K_{n,r}) = \gamma_{(2,2,1)}(K_{n,r}) = \gamma_{(2,2,2)}(K_{n,r}) = 4$ .

$\square$

By combining Theorem 3.16 and some known results we derive the following results.

**Theorem 3.18.** *The following statements hold for any integer  $n \geq 4$  and any nontrivial graph  $H$ .*

(i) *If  $\gamma_{(1,1)}^s(H) = 2$ , then  $\gamma_{(1,1)}^s(P_n \circ H) = 2 \lceil \frac{n}{3} \rceil$ .*

(ii) *If  $\gamma(H) = 1$  and  $\gamma_{(1,1)}^s(H) \geq 3$ , then  $\gamma_{(1,1)}^s(P_n \circ H) = \gamma_{(1,1,1)}^s(P_n) \stackrel{[8]}{=} \lceil \frac{5(n-2)}{7} \rceil + 2$ .*

(iii) *If  $\gamma(H) = 2 < \gamma_{(1,1)}^s(H)$ , then  $\gamma_{(1,1)}^s(P_n \circ H) = \gamma_{(2,2,1)}^s(P_n) \stackrel{[4]}{=} \begin{cases} n - \lfloor \frac{n}{7} \rfloor + 1 & \text{if } n \equiv 1, 2 \pmod{7}, \\ n - \lfloor \frac{n}{7} \rfloor & \text{otherwise.} \end{cases}$*

(iv) *If  $\gamma(H) \geq 3$ , then  $\gamma_{(1,1)}^s(P_n \circ H) = \gamma_{(2,2,2)}^s(P_n) \stackrel{[4]}{=} \begin{cases} n & \text{if } n \equiv 0 \pmod{4}, \\ n + 1 & \text{if } n \equiv 1, 3 \pmod{4}, \\ n + 2 & \text{if } n \equiv 2 \pmod{4}. \end{cases}$*

*Proof.* As indicated in the statements, we only need to prove (i). In this case, by Theorem 3.16 we know that  $\gamma_{(1,1)}^s(P_n \circ H) = \gamma_{(1,1,0)}^s(P_n)$ . Now, by Theorem 2.1 (ii) and Corollary 2.3 we deduce that  $\gamma_{(2,1,0)}^s(P_n) \leq \gamma_{(1,1,0)}^s(P_n) \leq \gamma_{(2,2,0)}^s(P_n)$ . Moreover, as shown in [4],  $\gamma_{(2,1,0)}^s(P_n) = \gamma_{(2,2,0)}^s(P_n) = 2 \lceil \frac{n}{3} \rceil$ , which completes the proof.  $\square$

By the result above and Theorem 3.16 we deduce the following result.

**Proposition 3.19.** *For any integer  $n \geq 4$ ,*

$$\gamma_{(1,1,0)}^s(P_n) = 2 \lceil \frac{n}{3} \rceil.$$

The following result concerns the case when  $G$  is a cycle.

**Theorem 3.20.** *The following statements hold for any integer  $n \geq 4$  and any nontrivial graph  $H$ .*

(i) *If  $\gamma_{(1,1)}^s(H) = 2$ , then  $\gamma_{(1,1)}^s(C_n \circ H) = \gamma_{(1,1,0)}^s(C_n) = \begin{cases} \lceil \frac{2n}{3} \rceil & \text{if } n = 4, 7, \\ 2 \lceil \frac{n}{3} \rceil & \text{otherwise.} \end{cases}$*

(ii) *If  $\gamma(H) = 1$  and  $\gamma_{(1,1)}^s(H) \geq 3$ , then  $\gamma_{(1,1)}^s(C_n \circ H) = \gamma_{(1,1,1)}^s(C_n) \stackrel{[8]}{=} \lceil \frac{5n}{7} \rceil$ .*

(iii) *If  $\gamma(H) = 2 < \gamma_{(1,1)}^s(H)$ , then*

$$\gamma_{(1,1)}^s(C_n \circ H) = \gamma_{(2,2,1)}^s(C_n) \stackrel{[4]}{=} \begin{cases} n - \lfloor \frac{n}{7} \rfloor + 1 & \text{if } n \equiv 1, 2 \pmod{7}, \\ n - \lfloor \frac{n}{7} \rfloor & \text{otherwise.} \end{cases}$$

(iv) *If  $\gamma(H) \geq 3$ , then  $\gamma_{(1,1)}^s(C_n \circ H) = \gamma_{(2,2,2)}^s(C_n) \stackrel{[4]}{=} n$ .*

*Proof.* As indicated in the statements, we only need to prove (i). In this case, by Theorem 3.16 we know that  $\gamma_{(1,1)}^s(C_n \circ H) = \gamma_{(1,1,0)}^s(C_n)$ . As shown in [4],  $\gamma_{(2,1,0)}(C_n) = \lceil \frac{2n}{3} \rceil$  and  $\gamma_{(2,2,0)}(C_n) = 2 \lceil \frac{n}{3} \rceil$ . Moreover, by Theorem 2.1 (ii) and Corollary 2.3 we deduce that  $\gamma_{(2,1,0)}(C_n) \leq \gamma_{(1,1,0)}^s(C_n) \leq \gamma_{(2,2,0)}(C_n)$ . Therefore,  $\gamma_{(1,1,0)}^s(C_n) \leq 2 \lceil \frac{n}{3} \rceil$  and, if  $n \equiv 0, 2 \pmod{3}$ , then  $\gamma_{(1,1,0)}^s(C_n) = 2 \lceil \frac{n}{3} \rceil$ .

From now on, we consider that  $n \equiv 1 \pmod{3}$  with  $n \geq 10$ , as the cases  $n = 4$  and  $n = 7$  are very easy to check. Let  $f(V_0, V_1, V_2)$  be a  $\gamma_{(1,1,0)}^s(C_n)$ -function and let  $V(C_n) = \{x_0, \dots, x_{n-1}\}$ , where consecutive vertices are adjacent and the addition of subscripts is taken modulo  $n$ . If there exists  $x_i \in V(C_n)$  such that  $f(x_i) = f(x_{i+1}) = 0$ , then  $\gamma_{(1,1,0)}^s(C_n) = \gamma_{(1,1,0)}^s(P_n)$  and we derived the result by Proposition 3.19. Hence, we assume that for any  $x_i \in V_0$  we have that  $f(x_{i-1}) > 0$  and  $f(x_{i+1}) > 0$ . From this fact, and considering that  $f$  is a secure  $(1, 1, 0)$ -dominating function, we deduce that  $f(\{x_j, x_{j+1}, x_{j+2}\}) \geq 2$  for any  $x_j \in V(C_n)$ . Now, we consider the following two cases.

Case 1.  $V_2 \neq \emptyset$ . Without loss of generality, we suppose that  $x_0 \in V_2$  and let  $S_i = \{x_{3i+1}, x_{3i+2}, x_{3i+3}\}$  for  $i \in \{0, \dots, \frac{n-4}{3}\}$ . Notice that  $f(S_i) \geq 2$  for every  $i \in \{0, \dots, \frac{n-4}{3}\}$ , which implies that

$$\gamma_{(1,1,0)}^s(C_n) = \omega(f) \geq \sum_{i=0}^{\frac{n-4}{3}} f(S_i) + f(x_0) \geq \frac{2(n-1)}{3} + 2 = 2 \lceil \frac{n}{3} \rceil.$$

This implies that  $\gamma_{(1,1,0)}^s(C_n) = 2 \lceil \frac{n}{3} \rceil$ .

Case 2.  $V_2 = \emptyset$ . In this case, if there exist four consecutive vertices with weight one, namely without loss of generality  $x_1, x_2, x_3, x_4$ , then we deduce that

$$\gamma_{(1,1,0)}^s(C_n) = \omega(f) \geq \sum_{i=5}^n f(x_i) + f(\{x_1, x_2, x_3, x_4\}) \geq \frac{2(n-4)}{3} + 4 = 2 \lceil \frac{n}{3} \rceil.$$

From now on we assume that for any group of four consecutive vertices, at least one vertex has weight equal to zero. Moreover, notice that  $|V_0| \geq 2$  as  $n \geq 10$  and  $\gamma_{(1,1,0)}^s(C_n) \leq 2 \lceil \frac{n}{3} \rceil$ . Without loss of generality, let  $x_0 \in V_0$ . and suppose that  $x_1 \in M_f(x_0)$ . This implies that  $f(x_1) = f(x_2) = f(x_3) = 1$  and  $f(x_4) = 0$ , and so  $f(x_5) = f(x_6) = 1$ .

If  $f(x_7) = 1$ , then we have that

$$\gamma_{(1,1,0)}^s(C_n) = \omega(f) \geq \sum_{i=8}^n f(x_i) + f(\{x_1, x_2, \dots, x_7\}) \geq \frac{2(n-7)}{3} + 6 = 2 \lceil \frac{n}{3} \rceil,$$

Now, assume that  $f(x_7) = 0$ . Thus,  $n \geq 13$  and  $x_8 \in M_f(x_7)$ , which implies that  $f(x_8) = f(x_9) = f(x_{10}) = 1$ . Hence,

$$\gamma_{(1,1,0)}^s(C_n) = \omega(f) \geq \sum_{i=11}^n f(x_i) + f(\{x_1, x_2, \dots, x_{10}\}) \geq \frac{2(n-10)}{3} + 8 = 2 \lceil \frac{n}{3} \rceil,$$

which completes the proof.  $\square$

## References

- [1] S. Benecke, E. J. Cockayne, C. M. Mynhardt. Secure total domination in graphs. *Util. Math.* 74 (2007) 247–259.
- [2] H. Boumediene Merouane, M. Chellali. On secure domination in graphs. *Inform. Process. Lett.* 115(10) (2015) 786–790.
- [3] A. P. Burger, M. A. Henning, J. H. van Vuuren. Vertex covers and secure domination in graphs. *Quaest. Math.* 31(2) (2008) 163–171.
- [4] A. Cabrera Martínez, A. Estrada-Moreno, J. A. Rodríguez-Velázquez. From Italian domination in lexicographic product graphs to  $w$ -domination in graphs. *Ars Math. Contemp.* To appear. *arXiv:2011.05371*.
- [5] A. Cabrera Martínez, A. Estrada-Moreno, Juan A. Rodríguez-Velázquez. Secure  $w$ -domination in graphs. *Symmetry* 12 (12) (2020) 1948.
- [6] A. Cabrera Martínez, I. G. Yero. Constructive characterizations concerning weak Roman domination in trees. *Discrete Appl. Math.* 284 (2020) 384–390.
- [7] A. Cabrera Martínez, L. P. Montejano, J. A. Rodríguez-Velázquez. On the secure total domination number of graphs. *Symmetry* 11(9) (2019) 1165.
- [8] A. Cabrera Martínez, L. P. Montejano, J. A. Rodríguez-Velázquez. Total weak Roman domination in graphs. *Symmetry* 11(6) (2019) 831.
- [9] A. Cabrera Martínez, J. A. Rodríguez-Velázquez. Total protection of lexicographic product graphs. *Discuss. Math. Graph Theory. In press*, 2020. <https://doi.org/10.7151/dmgt.2318>.
- [10] M. Chellali, T. W. Haynes, S. T. Hedetniemi. Bounds on weak Roman and 2-rainbow domination numbers. *Discrete Appl. Math.* 178 (2014) 27–32.
- [11] E. J. Cockayne, O. Favaron, C. M. Mynhardt. Secure domination, weak Roman domination and forbidden subgraphs. *Bull. Inst. Combin. Appl.* 39 (2003) 87–100.
- [12] E. J. Cockayne, P. J. P. Grobler, W. R. Gründlingh, J. Munganga, J. H. van Vuuren. Protection of a graph. *Util. Math.* 67 (2005) 19–32.
- [13] M. Dettlaff, M. Lemańska, J. A. Rodríguez-Velázquez. Secure Italian domination in graphs. *J. Comb. Optim.* 41 (1) (2021) 56–72.
- [14] O. Duginov. Secure total domination in graphs: bounds and complexity. *Discrete Appl. Math.* 222 (2017) 97–108.
- [15] T. W. Haynes, Stephen T. Hedetniemi, P. J. Slater. *Fundamentals of Domination in Graphs*. Chapman and Hall/CRC Pure and Applied Mathematics Series. Marcel Dekker, Inc. New York, 1998.

- [16] T.W. Haynes, S. Hedetniemi, P. Slater. *Domination in Graphs: Volume 2: Advanced Topics*. Chapman & Hall/CRC Pure and Applied Mathematics. Taylor & Francis, 1998.
- [17] M. A. Henning, S.T. Hedetniemi. Defending the Roman Empire—a new strategy. *Discrete Math.* 266(1-3) (2003) 239–251.
- [18] D. J. Klein, J. A. Rodríguez-Velázquez. Protection of lexicographic product graphs. *Discuss. Math. Graph Theory*. In press. <https://doi.org/10.7151/dmgt.2243>
- [19] W. F. Klostermeyer, C. M. Mynhardt. Secure domination and secure total domination in graphs. *Discuss. Math. Graph Theory* 28(2) (2008) 267–284.
- [20] V. R. Kulli, B. Chaluvraju, M. Kumara. Graphs with equal secure total domination and inverse secure total domination numbers. *J. Inf. Optim. Sci.* 39(2) (2018) 467–473.
- [21] M. Valveny, J. A. Rodríguez-Velázquez. Protection of graphs with emphasis on Cartesian product graphs. *Filomat* 33 (2019) 319–333.
- [22] M. Valveny, H. Pérez-Rosés, J. A. Rodríguez-Velázquez. On the weak Roman domination number of lexicographic product graphs. *Discrete Appl. Math.* 263 (2019) 257–270.

# Conclusions

This doctoral thesis is a part of a wide project which investigates several parameters related to the notion of protection of graphs. Our principal contributions are summarized in 10 papers, which are included in the thesis, and 3 (under review or accepted) papers which are not included. Next, we highlight the main contributions of the thesis.

## Chapter 1: “From Italian domination in lexicographic product graphs to $w$ -domination in graphs”

In this chapter we introduce a unified approach to the idea of protection of graphs, namely  $w$ -domination. Moreover, we show that the Italian domination number of every lexicographic product graph  $G \circ H$  can be expressed in terms of five different domination parameters of  $G$ , which can be defined under this approach. In particular,

- If  $\gamma(H) = 1$ , then  $\gamma_I(G \circ H) = \gamma_{(2,1,0)}(G)$ .
- If  $\gamma_2(H) = \gamma(H) = 2$ , then  $\gamma_I(G \circ H) = \gamma_{(2,2,0)}(G)$ .
- If  $\gamma_2(H) > \gamma(H) = 2$ , then  $\gamma_I(G \circ H) = \gamma_{(2,2,1)}(G)$ .
- If  $\gamma_I(H) \neq 3$  and  $\gamma(H) \geq 3$ , then  $\gamma_I(G \circ H) = \gamma_{(2,2,2)}(G)$ .
- If  $\gamma_I(H) = \gamma(H) = 3$ , then  $\gamma_I(G \circ H) = \gamma_{(2,2,2,0)}(G)$ .

This chapter also provides preliminary results on  $w$ -domination and raises the challenge of conducting a detailed study of the topic. Among the main results we emphasize the following.

- If  $k, l \in \mathbb{Z}^+$  and  $G$  is a graph with minimum degree  $\delta \geq 1$ , maximum degree  $\Delta$  and order  $n$ , then the following statements hold.



(i) If  $k \leq l\delta + 1$  and  $w = \underbrace{(k+l-1, k+l-2, \dots, k-1)}_{l+1}$ , then

$$\gamma_w(G) \geq \left\lceil \frac{(k+l-1)n}{\Delta+1} \right\rceil.$$

(ii) Let  $w = (w_0, \dots, w_l)$  with  $w_0 \geq \dots \geq w_l$ . If  $l\delta \geq w_l$ , then

$$\gamma_w(G) \geq \left\lceil \frac{w_0 n}{\Delta + w_0} \right\rceil.$$

(iii) If  $k \leq l\delta$  and  $w = \underbrace{(k, \dots, k)}_{l+1}$ , then  $\gamma_w(G) \geq \left\lceil \frac{kn}{\Delta} \right\rceil$ .

(iv) If  $k \leq l\delta + 1$  and  $w = \underbrace{(k, k-1, \dots, k-1)}_{l+1}$ , then  $\gamma_w(G) \geq \left\lceil \frac{kn}{\Delta+1} \right\rceil$ .

• If  $G$  is a graph of minimum degree  $\delta$ , then the following statements hold for any  $(w_0, \dots, w_l) \in \mathbb{Z}^+ \times \mathbb{N}^l$  with  $w_0 \geq \dots \geq w_l$ .

(i) If there exists  $i \in \{1, \dots, l-1\}$  such that  $i\delta \geq w_i$ , then

$$\gamma_{(w_0, \dots, w_l)}(G) \leq \gamma_{(w_0, \dots, w_i)}(G).$$

(ii) If  $l \geq i+1 \geq w_0$ , then

$$\gamma_{(w_0, \dots, w_i, 0, \dots, 0)}(G) \leq (i+1)\gamma(G).$$

(iii) Let  $k, i \in \mathbb{Z}^+$  such that  $l \geq ki$ , and let  $(w'_0, w'_1, \dots, w'_i) \in \mathbb{Z}^+ \times \mathbb{N}^i$ . If  $i\delta \geq w'_i$  and  $w_{kj} = kw'_j$  for every  $j \in \{0, 1, \dots, i\}$ , then

$$\gamma_{(w_0, \dots, w_l)}(G) \leq k\gamma_{(w'_0, \dots, w'_i)}(G).$$

(iv) If  $l\delta \geq w_l \geq l \geq 2$ , then

$$\gamma_{(w_0, \dots, w_l)}(G) \leq l\gamma_{(w_0-l+1, w_l-l+1)}(G).$$

(v) If  $\delta \geq 1$ ,  $w_0 \leq l-1$  and  $w_{l-1} \geq 1$ , then

$$\gamma_{(w_0, \dots, w_{l-2}, 1)}(G) \leq \gamma_{(w_0, \dots, w_{l-1}, 0)}(G).$$

## Chapter 2: “Total domination in rooted product graphs”

In this chapter we obtain closed formulas for the total domination number of rooted product graphs. Among the main contributions we highlight the following.

- We show that for any graphs  $G$  and  $H$  with no isolated vertex and any vertex  $v \in V(H)$ ,

$$\gamma_t(G \circ_v H) \in \left\{ \begin{array}{l} n(G)(\gamma_t(H) - 1), \quad \gamma(G) + n(G)(\gamma_t(H) - 1), \\ \gamma_t(G) + n(G)(\gamma_t(H) - 1), \quad n(G)\gamma_t(H) \end{array} \right\}.$$

- We characterize the graphs with  $\gamma_t(G \circ_v H)$  equal to each of the four expressions above.
- We show that for any nontrivial graphs  $G$  and  $H$  and any  $v \in V(H)$ ,

$$\gamma(G \circ_v H) = \begin{cases} \gamma(G) + n(G)(\gamma(H) - 1), & \text{if } \gamma(H - \{v\}) = \gamma(H) - 1, \\ n(G)\gamma(H), & \text{otherwise.} \end{cases}$$

## Chapter 3: “Total Roman $\{2\}$ -domination in graphs”

In this chapter we introduce the study of the total Italian domination number of a graph. Among the main contributions we emphasize the following.

- We study the relationship that exists between the total Italian domination number and other domination parameters in graphs with no isolated vertex. In particular, we highlight the following.

(a)  $\max\{\gamma_t(G), \gamma(G)\} \leq \gamma_I(G) \leq \min\{\gamma_t(G), \gamma(G)\} + \gamma(G).$

(b)  $\gamma_I(G) = \gamma_t(G)$  if and only if  $\gamma_{\times 2}(G) = \gamma_t(G).$

(c)  $\gamma_I(G) \leq \min\{\gamma_R(G), \gamma_{\times 2}(G)\} \leq 2\gamma_t(G).$

(d)  $\gamma_I(G) = 2\gamma_t(G)$  if and only if  $\gamma_I(G) = \gamma_R(G)$  and  $\gamma_t(G) = \gamma(G).$

- We obtain general bounds and characterize some extreme cases.
- We characterize the trees with  $\gamma_I(T) = \gamma_R(T).$
- We show that the problem of computing  $\gamma_I(G)$  is NP-hard, even when restricted to bipartite or chordal graphs.

#### Chapter 4: “Double domination in lexicographic product graphs”

This chapter develops the theory of double domination and total Italian domination numbers for the class of lexicographic product graph. We show that the values of these two parameters coincide, i.e,  $\gamma_I(G \circ H) = \gamma_{\times 2}(G \circ H)$ . Furthermore, we obtain tight bounds and closed formulas for  $\gamma_{\times 2}(G \circ H)$  in terms of invariants of the factor graphs  $G$  and  $H$ . Among the main contributions we emphasize the following.

- $\max\{\gamma_I(G), 2\rho(G)\} \leq \gamma_{\times 2}(G \circ H) \leq 2\gamma_I(G)$ .
- If  $\gamma(H) = 1$ , then  $\gamma_{\times 2}(G \circ H) \leq \gamma_I(G)$ .
- If  $H$  has at least two universal vertices, then  $\gamma_{\times 2}(G \circ H) \leq 2\gamma(G)$ .
- If  $H$  has exactly one universal vertex, then  $\gamma_{\times 2}(G \circ H) = \gamma_I(G)$ .
- If  $\gamma(H) \geq 2$ , then  $\gamma_{\times 2}(G \circ H) \geq \gamma_I(G)$ .
- We characterize the graphs with  $\gamma_{\times 2}(G \circ H) = 2$  and  $\gamma_{\times 2}(G \circ H) = 3$ .

#### Chapter 5: “Secure $w$ -domination in graphs”

In this chapter we introduce a general approach to the idea of protection of graphs, namely secure  $w$ -domination, which encompasses the known variants of secure domination and introduces new ones. In such a sense, we provide fundamental results on this novel parameter. Among the main results we emphasize the following.

- If  $l\delta(G) \geq w_l$  for any graph  $G$  and any  $w = (w_0, \dots, w_l) \in \mathbb{Z}^+ \times \mathbb{N}^l$  such that  $w_i \geq w_{i+1}$  for every  $i \in \{0, \dots, l-1\}$ , then the following hold.
  - (i)  $\gamma_w(G) \leq \gamma_w^s(G)$ .
  - (ii) If  $k \in \mathbb{Z}^+$ , then  $\gamma_{(k+1, k=w_1, \dots, w_l)}(G) \leq \gamma_{(k, k=w_1, \dots, w_l)}^s(G)$ .
- If  $G$  is a graph and  $l \geq 2$  an integer, then for any  $(w_0, \dots, w_{l-1}) \in \mathbb{Z}^+ \times \mathbb{N}^{l-1}$  with  $w_0 \geq \dots \geq w_{l-1}$  and  $l\delta(G) \geq w_{l-1}$ ,

$$\gamma_{(w_0, \dots, w_{l-1}, w_l=w_{l-1})}^s(G) \leq \gamma_{(w_0, \dots, w_{l-1})}(G) + \gamma(G).$$

- If  $G$  is a graph and  $(w_0, \dots, w_l) \in \mathbb{Z}^+ \times \mathbb{N}^l$  with  $w_0 \geq \dots \geq w_l$ , then the following statements hold.
  - (i) If there exists  $i \in \{1, \dots, l-1\}$  such that  $i\delta(G) \geq w_i$ , then  $\gamma_{(w_0, \dots, w_l)}^s(G) \leq \gamma_{(w_0, \dots, w_i)}^s(G)$ .
  - (ii) If  $l \geq i+1 > w_0$ , then  $\gamma_{(w_0, \dots, w_i, 0, \dots, 0)}^s(G) \leq (i+1)\gamma(G)$ .
- If  $G$  is a graph of order  $n$ , maximum degree  $\Delta$  with no isolated vertex and  $w = (w_0, \dots, w_l) \in \mathbb{Z}^+ \times \mathbb{N}^l$  such that  $w_0 \geq \dots \geq w_l$  and  $l\delta \geq w_l$ , then the following statements hold.
  - (i) If  $w_0 = w_1$  and  $w_0 - w_i \leq i$  for every integer  $i \in \{2, \dots, l\}$ , then  $\gamma_w^s(G) \geq \left\lceil \frac{(w_0+1)n}{\Delta+1} \right\rceil$ .
  - (ii) If  $w_0 = w_1$ , then  $\gamma_w^s(G) \geq \left\lceil \frac{(w_0+1)n}{\Delta+w_0} \right\rceil$ .
  - (iii) If  $w_0 = w_1 + 1$  and  $w_0 - w_i \leq i$  for every  $i \in \{2, \dots, l\}$ , then  $\gamma_w^s(G) \geq \left\lceil \frac{w_0 n}{\Delta+1} \right\rceil$ .
  - (iv)  $\gamma_w^s(G) \geq \left\lceil \frac{w_0 n}{\Delta+w_0} \right\rceil$ .

## Chapter 6: “Total weak Roman domination in graphs”

In this chapter we introduce the study of the total weak Roman domination number of a graph. We study the properties of this novel parameter in order to obtain its exact value or general bounds. Among the main contributions we emphasize the following.

- We show the relationship that exists between the total weak Roman domination number and other domination parameters in graphs with no isolated vertex. In particular, we highlight the following.
  - (a)  $\max\{\gamma_t(G), \gamma_r(G)\} \leq \gamma_{tr}(G) \leq \gamma_{tR}(G) \leq 2\gamma_t(G)$ .
  - (b)  $\gamma_{tr}(G) = \gamma_r(G)$  if and only if  $\gamma_r(G) = 2\gamma_t(G)$ .
  - (c)  $\gamma(G) + 1 \leq \gamma_{tr}(G) \leq \gamma_{st}(G)$ .
  - (d)  $\gamma_{tr}(G) = \gamma(G) + 1$  if and only if  $\gamma_{st}(G) = \gamma(G) + 1$ .
  - (e)  $2\rho(G) \leq \gamma_{tr}(G) \leq \min\{\gamma_t(G), \gamma_r(G)\} + \gamma(G)$ .
- We obtain general bounds and discuss some extreme cases.

- In a specific section of the paper, we focus on the case of rooted product graphs and we obtain closed formulas and tight bounds for the total weak Roman domination number of these graphs.
- Through the results obtained on rooted product graphs, we show that the problem of computing the total weak Roman domination number of a graph is NP-hard.

### **Chapter 7: “On the secure total domination number of graphs”**

This chapter is devoted to the study of the secure total domination number of a graph. We study the properties of this parameter in order to obtain its exact value or to provide general bounds. Almost all the results obtained in this chapter have been included in the book “Topics in Domination in Graphs” [25] published recently by Springer. Among our main contributions we highlight the following.

- We show that  $\gamma_{st}(G) \leq \alpha(G) + \gamma(G)$ . Since  $\gamma(G) \leq \alpha(G)$ , this result improves the bound  $\gamma_{st}(G) \leq 2\alpha(G)$  obtained in [21].
- We characterize the graphs with  $\gamma_{st}(G) = 3$ .
- We show that if  $G$  is a  $\{K_{1,3}, K_{1,3} + e\}$ -free graph with no isolated vertex, then  $\gamma_{st}(G) \leq \min\{\gamma_t(G), \gamma_r(G)\} + \gamma(G) \leq \gamma_s(G) + \gamma(G)$ .
- We study the relationship that exists between the secure total domination number and the matching number of a graph. In particular, we obtain the following results.
  - (a)  $\gamma_{st}(G) \leq 2\alpha'(G) + |L(G)| - |S(G)| + |I_G|$  for any graph  $G$  of minimum degree one.
  - (b)  $\gamma_{st}(G) \leq 2\alpha'(G) - \delta(G) + 2$  for every graph  $G$  of minimum degree  $\delta(G) \geq 2$ .
  - (c)  $\gamma_{st}(G) \leq \alpha'(G) + \gamma(G)$  for every  $\{K_{1,3}, K_{1,3} + e\}$ -free graph  $G$  of minimum degree  $\delta(G) \geq 3$ .

### **Chapter 8: “Secure total domination in rooted product graphs”**

This chapter develops the theory of secure total domination for the class of rooted product graphs. Among our main contributions we highlight the following.

- We show that if the root vertex  $v$  of  $H$  is a strong leaf, a support, or a universal vertex, then there exists a formula for  $\gamma_{st}(G \circ_v H)$ , i.e.,
  - (a) If  $v$  is a support vertex, then  $\gamma_{st}(G \circ_v H) = n(G)\gamma_{st}(H)$ .
  - (b) If  $v$  is a universal vertex, then  $\gamma_{st}(G \circ_v H) = n(G)\gamma_{st}(H)$ .
  - (c) If  $v$  is a strong leaf, then  $\gamma_{st}(G \circ_v H) = \gamma(G) + n(G)(\gamma_{st}(H) - 1)$ .
- In the remaining cases, two different behaviours are observed depending on whether the root vertex is a weak leaf or not. Although in a different way, in both cases we were able to give the intervals to which the parameter belongs. The endpoints of these intervals are expressed in terms of other domination parameters of the graphs involved in the product, which allows us to obtain closed formulas when certain conditions are imposed on the factor graphs.

### Chapter 9: “Total protection of lexicographic product graphs”

This chapter is devoted to the study of the secure total domination number and total weak Roman domination number for the class of lexicographic product graphs. We show that the values of these two parameters coincide, i.e.,  $\gamma_{tr}(G \circ H) = \gamma_{st}(G \circ H)$ . Furthermore, we obtain tight bounds and closed formulas for  $\gamma_{st}(G \circ H)$  in terms of invariants of the factor graphs  $G$  and  $H$ . For instance, we deduce the following results.

- $\max\{\gamma_r(G), \gamma_t(G), 2\rho(G)\} \leq \gamma_{st}(G \circ H) \leq 2\gamma_t(G)$ .
- If  $\gamma(H) = 1$ , then  $\gamma_{st}(G \circ H) \leq \gamma_r(G)$ .
- If  $H$  has at least two universal vertices, then  $\gamma_{st}(G \circ H) \leq 2\gamma(G)$ .
- If  $\gamma(H) > 2$ , then  $\gamma_{st}(G \circ H) \geq \gamma_r(G)$ .
- We characterize the graphs with  $\gamma_{st}(G \circ H) \in \{2, 3\}$ .

### Chapter 10: “From (secure) $w$ -domination in graphs to protection of lexicographic product graphs”

In this chapter we show how the secure (total) domination number and the (total) weak Roman domination number of lexicographic product graphs  $G \circ H$  are related to  $\gamma_w(G)$  or  $\gamma_w^s(G)$ . Among our main contributions we highlight the following.

- If  $G$  is a graph with no isolated vertex and  $H$  a nontrivial graph, then the following statements hold.

(i) If  $\gamma_{(1,1)}^s(H) = 2$ , then  $\gamma_{(1,1)}^s(G \circ H) = \gamma_{(1,1,0)}^s(G)$ .

(ii) If  $\gamma(H) = 1$  and  $\gamma_{(1,1)}^s(H) \geq 3$ , then  $\gamma_{(1,1)}^s(G \circ H) = \gamma_{(1,1,1)}^s(G)$ .

(iii) If  $\gamma(H) = 2 < \gamma_{(1,1)}^s(H)$ , then  $\gamma_{(1,1)}^s(G \circ H) = \gamma_{(2,2,1)}(G)$ .

(iv) If  $\gamma(H) \geq 3$ , then  $\gamma_{(1,1)}^s(G \circ H) = \gamma_{(2,2,2)}(G)$ .

## Other contributions

Apart from the contributions included in this thesis, we want to highlight the next papers.

- A. Cabrera Martínez, J.A. Rodríguez-Velázquez. From the strong differential to Italian domination in graphs, *Mediterr. J. Math.* To appear (2019 JCR Impact factor: 1.216, Q1 (79/325), Mathematics).
- A. Cabrera Martínez, J.A. Rodríguez-Velázquez. A note on double domination in graphs, *Discrete Appl. Math.* To appear (2019 JCR Impact factor: 1.041, Q3 (150/261), Mathematics, Applied).
- A. Cabrera Martínez, A. Estrada-Moreno, J.A. Rodríguez-Velázquez. From the quasi-total strong differential to quasi-total Italian domination in graphs, *Submitted*.

## Future works

- Facing the open problems that are exposed in the papers included in this thesis.
- Develop the theory of (secure)  $w$ -domination in graphs, and use the advantages of this approach to study other domination parameters in graphs.

## *Conclusions*

---

- Develop a new theoretical framework on differentials in graphs. As we have seen, the protection strategies can be defined from functions, and some of them assign a weight greater than 1 to some vertices of the graph. Our challenge is to introduce new structures that allow us to investigate these types of domination without the use of functions.
- Some of the contributions of this thesis improve known results concerning the relationships that exist between some domination parameters and other invariants. We consider that such improvement will occur for several of the known domination parameters. This is an interesting challenge in which we intend to improve known results on domination theory.



## References

- [1] H. Abdollahzadeh Ahangar, M. Chellali, S. M. Sheikholeslami, J. C. Valenzuela-Tripodoro, Total Roman  $\{2\}$ -dominating functions in graphs, *Discuss. Math. Graph Theory*. In press.  
URL <https://doi.org/10.7151/dmgt.2316>
- [2] S. Benecke, E. J. Cockayne, C. M. Mynhardt, Secure total domination in graphs, *Util. Math.* 74 (2007) 247–259.
- [3] H. Boumediene Merouane, M. Chellali, On secure domination in graphs, *Inform. Process. Lett.* 115 (10) (2015) 786–790.
- [4] B. Brešar, M. A. Henning, S. Klavžar, On integer domination in graphs and vizing-like problems, *Taiwanese J. Math.* 10(5) (2006) 1317–1328.
- [5] A. P. Burger, M. A. Henning, J. H. van Vuuren, Vertex covers and secure domination in graphs, *Quaest. Math.* 31 (2) (2008) 163–171.
- [6] S. Cabrera García, A. Cabrera Martínez, F. A. Hernández Mira, I. G. Yero, Total Roman  $\{2\}$ -domination in graphs, *Quaest. Math.* 44 (3) (2021) 411–434.
- [7] A. Cabrera Martínez, S. Cabrera García, J. A. Rodríguez-Velázquez, Double domination in lexicographic product graphs, *Discrete Appl. Math.* 284 (2020) 290–300.
- [8] A. Cabrera Martínez, A. Estrada-Moreno, J. A. Rodríguez-Velázquez, From Italian domination in lexicographic product graphs to  $w$ -domination in graphs, *ARS Math. Contemp.* In press.  
URL <https://doi.org/10.26493/1855-3974.2318.fb9>
- [9] A. Cabrera Martínez, A. Estrada-Moreno, J. A. Rodríguez-Velázquez, Secure  $w$ -domination in graphs, *Symmetry* 12 (12) (2020) 1948.

- [10] A. Cabrera Martínez, I. G. Yero, Constructive characterizations concerning weak Roman domination in trees, *Discrete Appl. Math.* 284 (2020) 384–390.
- [11] A. Cabrera Martínez, L. P. Montejano, J. A. Rodríguez-Velázquez, On the secure total domination number of graphs, *Symmetry* 11(9) (2019) 1165.
- [12] A. Cabrera Martínez, L. P. Montejano, J. A. Rodríguez-Velázquez, Total weak Roman domination in graphs, *Symmetry* 11(6) (2019) 831.
- [13] A. Cabrera Martínez, J. A. Rodríguez-Velázquez, Total protection of lexicographic product graphs, *Discuss. Math. Graph Theory*. In press.  
URL <https://doi.org/10.7151/dmgt.2318>
- [14] M. Chellali, T. W. Haynes, S. T. Hedetniemi, Bounds on weak Roman and 2-rainbow domination numbers, *Discrete Appl. Math.* 178 (2014) 27–32.
- [15] M. Chellali, T. W. Haynes, S. T. Hedetniemi, A. A. McRae, Roman  $\{2\}$ -domination, *Discrete Appl. Math.* 204 (2016) 22–28.
- [16] E. J. Cockayne, P. A. Dreyer Jr., S. M. Hedetniemi, S. T. Hedetniemi, Roman domination in graphs, *Discrete Math.* 278 (1–3) (2004) 11–22.
- [17] E. J. Cockayne, O. Favaron, C. M. Mynhardt, Secure domination, weak Roman domination and forbidden subgraphs, *Bull. Inst. Combin. Appl.* 39 (2003) 87–100.
- [18] E. J. Cockayne, P. J. P. Grobler, W. R. Gründlingh, J. Munganga, J. H. van Vuuren, Protection of a graph, *Util. Math.* 67 (2005) 19–32.
- [19] M. Dettlaff, M. Lemańska, J. A. Rodríguez-Velázquez, Secure Italian domination in graphs., *J. Comb. Optim.* 41 (2021) 56–72.
- [20] G. S. Domke, S. T. Hedetniemi, R. C. Laskar, G. H. Fricke, Relationships between integer and fractional parameters of graphs, in: Y. Alavi, G. Chartrand, O. R. Oellermann, A. J. Schwenk (eds.), *Graph theory, combinatorics, and applications: proceedings of the Sixth Quadrennial International Conference on the Theory and Applications of Graphs*, Western Michigan University, vol. 2, John Wiley & Sons Inc., 1991.
- [21] O. Duginov, Secure total domination in graphs: bounds and complexity, *Discrete Appl. Math.* 222 (2017) 97–108.

- [22] J. F. Fink, M. S. Jacobson,  $n$ -domination in graphs, in: Graph theory with applications to algorithms and computer science, Wiley-Intersci. Publ., Wiley, New York, 1985, pp. 283–300.
- [23] F. Harary, T. W. Haynes, Double domination in graphs, *Ars Combin.* 55 (2000) 201–213.
- [24] T. Haynes, S. Hedetniemi, P. Slater, *Domination in Graphs: Volume 2: Advanced Topics*, Chapman & Hall/CRC Pure and Applied Mathematics, Taylor & Francis, 1998.
- [25] T. W. Haynes, S. T. Hedetniemi, M. A. Henning, *Topics in domination in graphs*, vol. 64 of *Developments in Mathematics*, Springer, Cham, 2020.
- [26] T. W. Haynes, S. T. Hedetniemi, P. J. Slater, *Fundamentals of Domination in Graphs*, Chapman and Hall/CRC Pure and Applied Mathematics Series, Marcel Dekker, Inc. New York, 1998.
- [27] M. A. Henning, A survey of selected recent results on total domination in graphs, *Discrete Math.* 309 (1) (2009) 32–63.
- [28] M. A. Henning, S. T. Hedetniemi, Defending the Roman Empire—a new strategy, *Discrete Math.* 266 (1-3) (2003) 239–251.
- [29] M. A. Henning, A. P. Kazemi,  $k$ -tuple total domination in graphs, *Discrete Appl. Math.* 158 (9) (2010) 1006–1011.
- [30] M. A. Henning, W. F. Klostermeyer, Italian domination in trees, *Discrete Appl. Math.* 217 (2017) 557 – 564.
- [31] M. A. Henning, A. Yeo, *Total Domination in Graphs*, Springer Monographs in Mathematics, Springer New York, 2013.
- [32] X. Hou, Y. Lu, On the  $\{k\}$ -domination number of cartesian products of graphs, *Discrete Math.* 309 (10) (2009) 3413–3419.
- [33] D. J. Klein, J. A. Rodríguez-Velázquez, Protection of lexicographic product graphs, *Discuss. Math. Graph Theory*. In press.  
URL <https://doi.org/10.7151/dmgt.2243>
- [34] W. F. Klostermeyer, G. MacGillivray, Roman, Italian, and 2-domination, *J. Combin. Math. Combin. Comput.* 108 (2019) 125–146.

## *References*

---

- [35] W. F. Klostermeyer, C. M. Mynhardt, Secure domination and secure total domination in graphs, *Discuss. Math. Graph Theory* 28 (2) (2008) 267–284.
- [36] V. R. Kulli, B. Chalugaraju, M. Kumara, Graphs with equal secure total domination and inverse secure total domination numbers, *J. Inf. Optim. Sci.* 39 (2) (2018) 467–473.
- [37] C.-M. Lee, M.-S. Chang, Variations of Y-dominating functions on graphs, *Discrete Math.* 308 (2008) 4185–4204.
- [38] I. Stewart, Defend the Roman Empire!, *Scientific American* 281 (6) (1999) 136–138.
- [39] M. Valveny, H. Pérez-Rosés, J. A. Rodríguez-Velázquez, On the weak Roman domination number of lexicographic product graphs, *Discrete Appl. Math.* 263 (2019) 257–270.
- [40] M. Valveny, J. A. Rodríguez-Velázquez, Protection of graphs with emphasis on Cartesian product graphs, *Filomat* 33 (2019) 319–333.