



9-13-2021

## Improving the Power Outage Resilience of Buildings with Solar PV through the Use of Battery Systems and EV Energy Storage

Huangjie Gong

University of Kentucky, [huangjie.gong@uky.edu](mailto:huangjie.gong@uky.edu)

Dan M. Ionel

University of Kentucky, [dan.ionel@uky.edu](mailto:dan.ionel@uky.edu)

Follow this and additional works at: [https://uknowledge.uky.edu/ece\\_facpub](https://uknowledge.uky.edu/ece_facpub)



Part of the [Power and Energy Commons](#)

[Right click to open a feedback form in a new tab to let us know how this document benefits you.](#)

---

### Repository Citation

Gong, Huangjie and Ionel, Dan M., "Improving the Power Outage Resilience of Buildings with Solar PV through the Use of Battery Systems and EV Energy Storage" (2021). *Electrical and Computer Engineering Faculty Publications*. 49.

[https://uknowledge.uky.edu/ece\\_facpub/49](https://uknowledge.uky.edu/ece_facpub/49)

This Article is brought to you for free and open access by the Electrical and Computer Engineering at UKnowledge. It has been accepted for inclusion in Electrical and Computer Engineering Faculty Publications by an authorized administrator of UKnowledge. For more information, please contact [UKnowledge@lsv.uky.edu](mailto:UKnowledge@lsv.uky.edu).

---

# Improving the Power Outage Resilience of Buildings with Solar PV through the Use of Battery Systems and EV Energy Storage

Digital Object Identifier (DOI)

<https://doi.org/10.3390/en14185749>

## Notes/Citation Information

Published in *Energies*, v. 14, issue 18, 5749.

© 2021 by the authors. Licensee MDPI, Basel, Switzerland.

This article is an open access article distributed under the terms and conditions of the Creative Commons Attribution (CC BY) license (<https://creativecommons.org/licenses/by/4.0/>).

Article

# Improving the Power Outage Resilience of Buildings with Solar PV through the Use of Battery Systems and EV Energy Storage

Huangjie Gong  and Dan M. Ione \* 

SPARK Laboratory, ECE Department, University of Kentucky, Lexington, KY 40506, USA;  
huangjie.gong@uky.edu

\* Correspondence: dan.ionel@ieee.org

**Abstract:** Buildings with solar photovoltaic (PV) generation and a stationary battery energy storage system (BESS) may self-sustain an uninterrupted full-level electricity supply during power outages. The duration of off-grid operation is dependent on the time of the power fault and the capabilities of the home energy management system (HEMS). In this paper, building resilience is quantified by analyzing the self-sustainment duration for all possible power outages throughout an entire year. An evaluation method is proposed and exercised on a reference house in California climate zone 9 for which the detailed electricity usage is simulated using the EnergyPlus software. The influence of factors such as energy use behavioral patterns, energy storage capacity from the BESS, and an electric vehicle (EV) battery on the building resilience is evaluated. Varying combinations of energy storage and controllable loads are studied for optimally improved resilience based on user preferences. It is shown that for the target home and region with a solar PV system of 7.2 kW, a BESS with a capacity of 11 kWh, and an EV with a battery of 80 kWh permanently connected to the home, off-grid self-sustained full operation is guaranteed for at least 72 h.

**Keywords:** distributed energy resource (DER); solar PV system; battery energy storage system (BESS); vehicle-to-home (V2H); electric vehicle (EV); resilience; home energy management (HEM); power outage; blackout



**Citation:** Gong, H.; Ione, D.M. Improving the Power Outage Resilience of Buildings with Solar PV through the Use of Battery Systems and EV Energy Storage. *Energies* **2021**, *14*, 5749. <https://doi.org/10.3390/en14185749>

Academic Editors: Venizelos Efthymiou, Valerio Lo Brano and Christina N. Papadimitriou

Received: 15 June 2021  
Accepted: 6 September 2021  
Published: 13 September 2021

**Publisher's Note:** MDPI stays neutral with regard to jurisdictional claims in published maps and institutional affiliations.



**Copyright:** © 2021 by the authors. Licensee MDPI, Basel, Switzerland. This article is an open access article distributed under the terms and conditions of the Creative Commons Attribution (CC BY) license (<https://creativecommons.org/licenses/by/4.0/>).

## 1. Introduction

In the rapidly evolving electric power system, wherein new renewable and distributed energy resources are being connected and fossil fuel based generators are being retired at a growing rate, it is increasingly important to ensure a continued and reliable supply of electricity. For example, approximately 8000 MW may need to be imported to avoid blackouts in California by filling in gaps caused by renewable energy generation variability and increased power demand. Another major threat to energy supply reliability are large natural disasters, such as, in recent years, wide-spread wild fires [1]. In 2020, there were more than 8 thousand fires in California alone resulting in almost 1.5 million burnt out acres and significant power system damage [2]. In a winter storm in 2021, approximately 2 million homes suffered power outages in Texas which substantially increased electricity demand due to record-breaking low temperatures [3]. Worse still, about 34,000 MW of renewable wind generation capability within Texas was lost during this storm as freezing temperatures forced power plants offline in quick succession [4]. It is very important to ensure power system reliability through whatever means possible under such conditions to protect residents from environmental health risks.

Residences equipped with rooftop solar photovoltaic (PV) panels and battery energy storage systems (BESS) turn into prosumers with generation capability to supply their own on-site demand [5]. The increasing trend of independent PV producers is representative of the possibility of decentralized power generation and distribution [6]. Solar PV panels can achieve the best performance when its material is suitable for the external condition as

measured by matrices including energy payback time (EPBT), energy production factor (EPF) and life cycle conversion efficiency (LCCE) [7]. The thermal and chemical treatment based end-of-life (EOL) method reduces the cost for recycling PV system waste material making PV generation even greener [8]. Solar PV systems may be considered a reliable distributed energy resource (DER) only when it is coordinated with BESS [9]. In-home BESS can store variable renewable generated energy allowing it to be used whenever needed by the user but often have a limited energy capacity due to its hefty initial investment [10]. When advanced thermal management is implemented, BESS can charge and discharge with large power while maintaining operational safety [11].

The growing trend of electric vehicles (EV) provides the potential to boost the energy capacity of residential energy storage systems (ESS) [12]. Hence, research towards the development of smart energy management in residential houses using home ESS and EV battery systems is in progress [13,14]. Residences with EV can help to improve the load factor in communities, reducing costs related to the maintenance of transformers, feeders, etc. [15]. A previous study using data from the national household travel survey (NHTS) found that most cars commute around 20 miles daily, resulting in 90% of SOC remaining on average for EVs when they return home [16].

Recent research shows that EV batteries can operate as a voltage source or offline uninterruptible power supply (UPS) for a home in an outage [17,18]. A well managed energy storage system with BESS and EV support could provide good performance during both transient and steady-state operation, considering the voltage waveform and current harmonics distortion [19]. Different operation modes of EV in smart homes have been proposed and explored, and it was shown that depending on the usage preferences of the user, EV batteries can act as a power source to feed residential appliances during a power outage [17]. When energy not supplied (ENS) or system average interruption duration index (SAIDI) is taken into consideration, the participation of a EV connected to the home improved resilience the most [20].

The vehicle-to-home (V2H) capability of EV realizes the outage management and cost reduction for a smart home [21,22]. EV systems can potentially adopt the same method introduced in [23] allowing the battery system to switch between input PV energy harvesting mode and output V2H mode for emergency situations. V2H functionality also improves power system resilience factors including load restoration, reactive power supply, and peak reduction, etc. [24–28]. Bidirectional wireless power transfer will further facilitate V2H applications by enabling higher power transfer and easing the barrier to entry for the consumer [29].

Depending on the user preferences and applications of the EV, the additional energy storage can expand the residential ESS, but may not be available at the residence when the outage occurs. For example, according to recent reports, the very large 90 kWh battery installed on the most recent EV model of the Ford F-150 truck can be controlled to supply up to 10 days of electricity for a connected home [30]. Other factors including user behavior regarding residential load, the capacity of the residential ESS, renewable energy generation, etc., should all be taken into consideration for systematically quantifying building resilience.

Research gaps remain as the prediction of building resilience duration should consider different time occurrences for power outages. Residences with solar PV generation would be less dependent on electricity from the grid during the daytime and could self-sustain longer if outages occur at times when electricity usage is low. The building resilience for residences with varying electricity usage, PV generation capability, and BESS capacities need to be analyzed in order to provide a reference for all types of house owners. This paper focuses on minute-based simulations of power flow and energy use with building resilience studied by monitoring the energy balance on the demand and supply sides. The quantification of building residence provides utilities with a basis for better planning of rolling blackouts and power restoration, and guide house owners when sizing their localized residential power system.

The major contributions of the paper include:

- Quantification of building resilience considering all possible power outage occurrence times;
- Analysis of building resilience for different factors including user behavior, the impact of renewable energy generation, and the energy capacity of the residential ESS;
- Exploration of the possibility of EV battery incorporation into the residential ESS;
- Evaluation of the impact of EV battery capacity on building resilience.

The typical electricity usage for the reference house is calculated and the main parameters of this model are presented in Section 2. Section 3 focuses on the definition and quantification of the reference house's building resilience. In Section 4, the impact of the varying home load percentages and the sizing of the BESS energy capacity on building resilience is studied. The possibility of incorporating the EV battery into the residential ESS is explored in Sections 5. Finally, Sections 6 and 7 provide concluding remarks and a summary of this study's results.

## 2. Energy Model for the Reference House

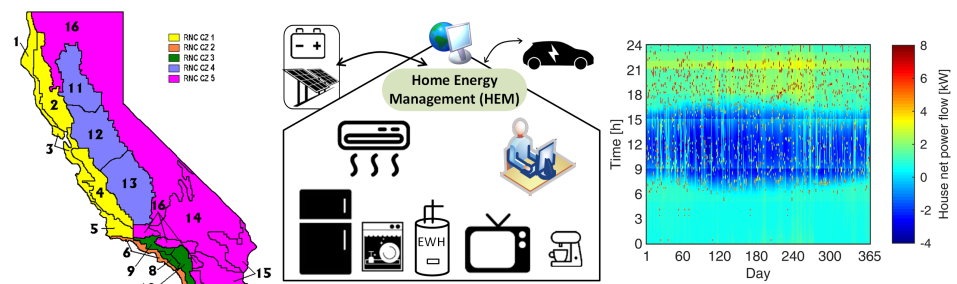
The main parameters for the reference house considered in the study are summarized in Table 1. The use of batteries for power flow and energy studies are based on results from the EnergyPlus software and the INSPIRE+D co-simulation framework [31]. The framework realizes the dynamic communication between the power system simulator and the building model, based on a prototype EnergyPlus model released originally by the Pacific Northwest National Laboratory (PNNL) [32]. The weather data for the studied Burbank area in California climate zone 9 was publicly available on the EnergyPlus website as a typical meteorological year (TMY) [33]. The outputs of the EnergyPlus model include energy usage and generation with a 5-minute resolution and detailed usage for appliances including HVAC, water heater, etc.

**Table 1.** Main specifications for the electricity usage model of the reference house.

Parameters	Value
Conditioned area	223 m <sup>2</sup> (2401 ft <sup>2</sup> )
House type	4-bedroom, 3.5-bathroom
Location	Burbank, CA, Zone 9
PV rating/annual generation	7.2 kW/11,316 kWh
Annual electricity usage w/o EWH	13,628 kWh
Annual electricity usage of EWH	4233 kWh
EWH rated electric power	5 kW
BESS energy capacity/maximum power	11 kWh/5 kW
Initial BESS SOC	100%
Minimum BESS SOC	20%
EV battery energy capacity/maximum power	90 kWh/10 kW
EV battery SOC when EV arrives home	90%
Minimum EV battery SOC	20%

In the schematic representation and graphs from Figure 1, the dark blue area in the middle of the annual electricity usage graph corresponds to power flow from the house to the grid caused by surplus PV generation. Variations in the blue area was caused by the pool pump, which operates during the period 9:00–15:00. The yellow strip at around 21:30 stands for evening demand peaks of power flow into the house.

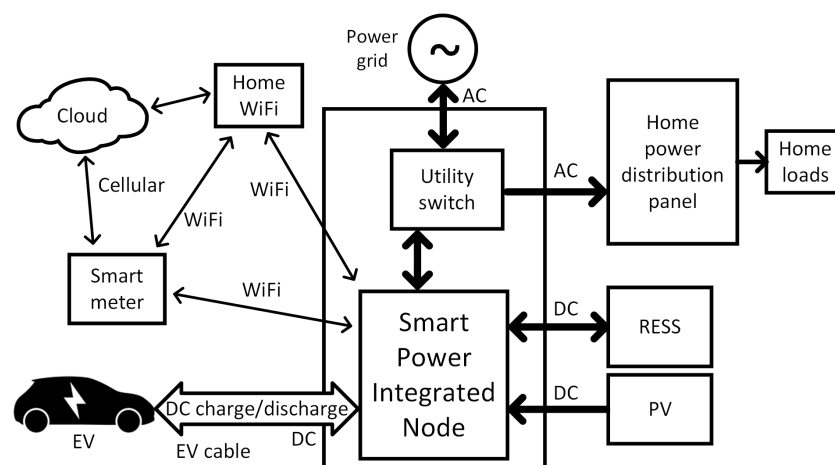
The electric water heater (EWH) was modeled and its typical high and relatively short power draw corresponds to the red dots in Figure 1. The electricity usage and power profile of the EWH are determined by the water draws, quantified according to the California Building Energy Code Compliance for Residence (CBECC-Res) [34]. The rated electric power of EWH is 5 kW, and the calculated annual electricity usage of the EWH is 4233 kWh.



**Figure 1.** Illustrations for the example reference home: location in California zone climate 9 (left); home energy management, PV, battery, EV, and appliances diagram including major energy users HVAC system and EWH (center); and new power flow during a year (right). The negative power flow during daytime is due to surplus solar PV generation. The very high power draw marked with red dots and occurring mostly in the evening and at night is due to the EWH.

The stationary BESS introduced to the home is a Li-ion battery rated as 11 kWh/5 kW in the following studies, and is assumed to have 100% SOC when the power outage occurs. The EV battery is rated as 90 kWh for the reference house. The most recent level 2 charger allows the EV to be charged/discharged at a maximum power of 10 kW with a lower limit of 20% for the EV battery [35]. The EV is scheduled to leave home at 6 a.m. and return at 6 p.m. every day with an SOC of 90%, given the fact that most daily driving mileages are less than 20 [16].

The example topology published in patent [36] includes inverters for connections to EV and other components (Figure 2). Such a multifunctional system can ensure V2H operation, providing support during grid power outages and increased resilience. Residential power system components are represented as nodes or individual elements that interact with a central power management system connected to the cloud for long-distance control and capable of multi-function operation. The central system includes a smart power integrated connected to power grid, BESS, PV cell and EV. Communication can be realized via Ethernet, WiFi, cellular connection, or any available communication protocol. The smart power integrated node (SPIN) provides DC charge and discharge capability to EV via an EV cable in this embodiment. The SPIN may incorporate functionalities such as service setup, display and control, and is capable of receiving transit information from remote server or user interfaces. The operating procedure defined by the user is employed by its many DC/DC, DC/AC switching components.



**Figure 2.** Example of a residential power and energy management system, based on the concept described in a US patent [36]. Such a multifunctional system can ensure V2H operation, providing support during grid power outages and increased resilience.

### 3. Method for Calculating the Self-Sustainment Duration for a Reference House

Power outages or blackouts may occur at any time throughout the entire year, and in such conditions, the house loses electricity supply from the grid. In the following studies, residential loads are supplied by the BESS and PV generation when the blackout occurs, and the resulting performance is analyzed for the following 24 h. The total electricity provided by the BESS after the power outage occurs is defined as:

$$E_{B,t} = \sum_{i=0}^t P_{B,i} \cdot \Delta t, \tag{1}$$

where  $i$  is the simulated time step, with  $i = 0$  indicating the time origin when the power outage occurs; and  $P_{B,i}$ , represents the power of BESS. During a power outage, the BESS supplies the total house demand to provide full building resilience. Therefore,

$$P_{B,i} = P_{H,i}, \tag{2}$$

where  $P_{H,i}$  is the net power flow of the residence. When  $P_{H,i}$  is larger than the maximum power rating of the BESS, the residential load has to be curtailed.

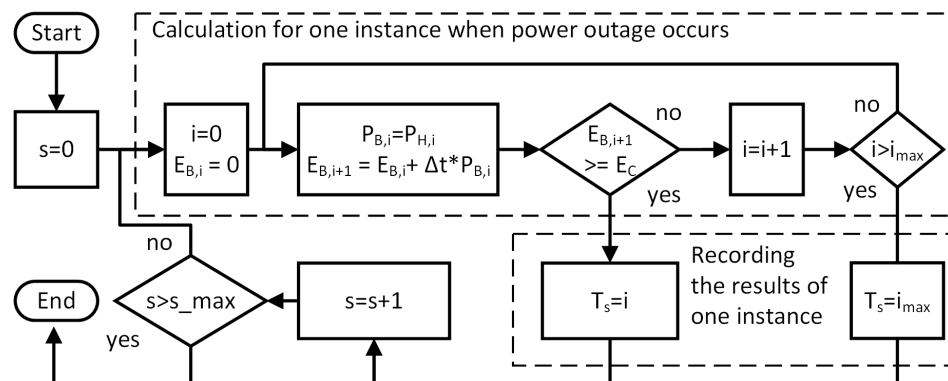
The self-sustainment performance is measured as the duration when the BESS can supply the residential loads. At one instance, e.g., time step  $s$ , when the power outage occurs, the BESS was discharged down to the minimum acceptable SOC. The self-sustainment operation duration  $T_s$  for this instance is defined as:

$$\exists i = T_s : E_{B,i} \leq E_C \wedge E_{B,i+1} \geq E_C, \tag{3}$$

where  $E_C$ , the maximum available energy of the residential ESS:

$$E_C = \eta_B \cdot E_{C,B}, \tag{4}$$

where  $\eta_B$  is 80% in the study, as the maximum SOC for BESS is 100% and minimum is 20%;  $E_{C,B}$ , the rated energy capacity of BESS. When the SOC is 100%, the surplus PV generation is curtailed. After calculating the following 24 h for step  $s$ , the same procedure is applied to step  $s + 1$ , and up to the last time step  $s_{max}$ . Every time step has its own corresponding self-sustainment operation duration  $T_s$ . The procedure for calculating the self-sustainment operation duration is illustrated in Figure 3.



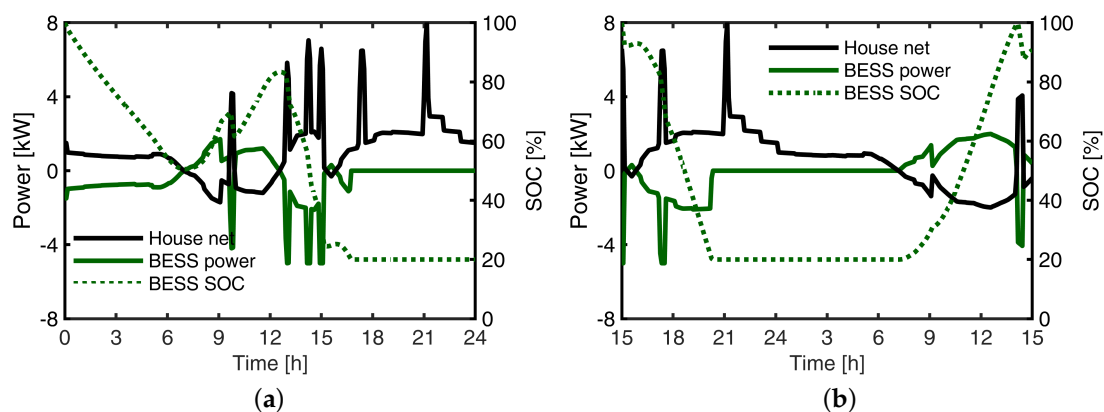
**Figure 3.** NEW FIGURE–Systematic procedure for the evaluation of building resilience. Simulation is performed for each time step, corresponding to instances for which power outage occurs. The self-sustainment duration is calculated for each instance.

The constraints are the maximum BESS power:

$$|P_{B,i}| \leq P_{max}. \tag{5}$$

Residential power must be curtailed if it is too high during a outage. On the other hand, the PV generation input needs to be curtailed if the negative net power flow is too high.

Simulation results in Figure 4 show that the time of the power outage has a great impact on the self-sustainment duration from the reference house. When the power outage occurred at the midnight as shown on the left, the reference house self-sustained approximately 17 h (Figure 4a). The BESS SOC in this case dropped in the early morning, increased in the midday, and decreased in the evening until it was 20%. This happened because the BESS was charged by the surplus PV generation in the midday and discharged to power the loads for the rest of the time. On the same example day, however, when the power outage occurred at 3 pm, the house self-sustained for approximately 5 h, as shown in Figure 4b. The house self-sustained for a significantly shorter amount of time because the BESS was not charged for that day when PV generation faded away in the evening.



**Figure 4.** An example of the daily self-sustain case for the reference house when the power outage occurs at (a) midnight and (b) 3 p.m. The BESS covers the residential load in the morning and was charged by surplus solar PV generation throughout the day. As PV power rapidly declined and no longer met the residential load, the BESS discharged until falling to the minimum SOC of 20%. The reference house tends to self-sustain longer when the power outage occurs in the early morning because the BESS could be charged by PV generation during the daytime hours.

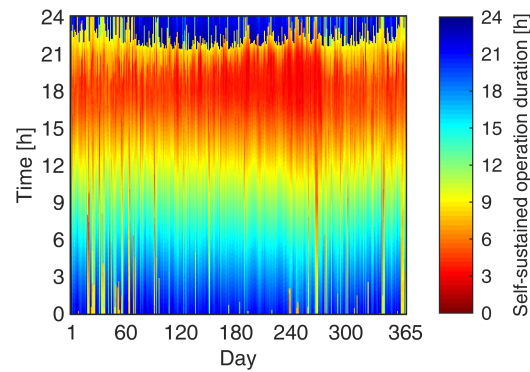
With the simulation time step of 5-min, there are  $12 \times 24 \times 365 = 105,120$  instances throughout the entire year when the power outage could occur. Correspondingly, there are 105,120 calculated self-sustained operation durations which are represented as different colors in Figure 5, with each cell indicating a 5-minute increment. The two instances in Figure 4 result in the colors for the 17 and 5 h for their two cells. Self-sustained operation duration trended towards being longer if the power outage occurred in the early morning because the BESS was charged in the midday by surplus solar PV generation. The self-sustained operation duration around 6 p.m. was short because of both the evening residential load peak and lower solar PV generation.

The simulation results of self-sustained operation duration for the entire year were summarized with an interval of 1-h in Figure 6. If the self-sustained operation duration of the house falls into the interval of  $(t_1, t_1 + 1]$ , it can self-sustain any hours within  $[0, t_1]$ . The cumulative probability curve presented in Figure 7 indicates that after a power outage occurrence, the reference house is almost 100% likely to self-sustain for up to 3 h, and 50% likely to self-sustain up to approximately 10 h. The cumulative curve, which stands for the building resilience, was fitted and represented explicitly with a 4th order polynomial equation, as follows:

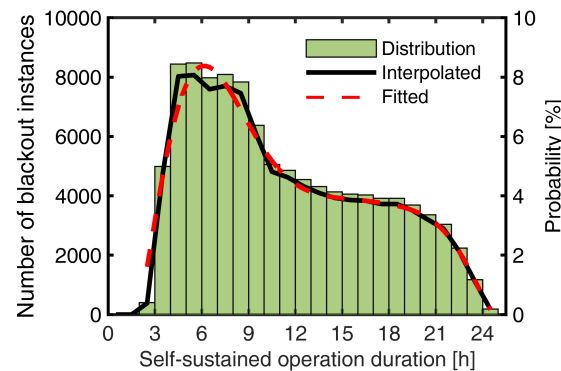
$$f(t) = \begin{cases} 100, & t \in [0, 3) \\ p_1 t^4 + p_2 t^3 + p_3 t^2 + p_4 t + p_5, & t \in [3, 24], \end{cases} \quad (6)$$

where the coefficients for the reference example are  $p = [-0.0017, 0.0934, -1.5743, 3.7379, 99.1833]$ .

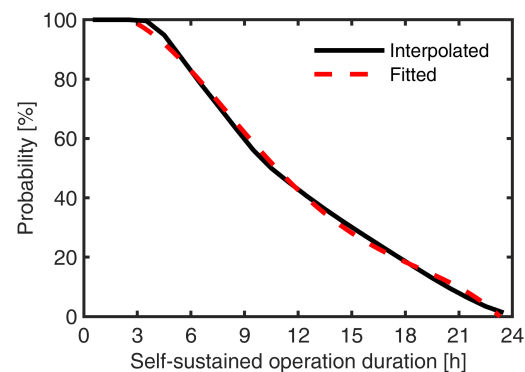




**Figure 5.** Self-sustained operation duration of the reference house for power outages occurring at different times. All 105,120 instances of varying days and times for power outages were calculated throughout the year. The self-sustained operation duration is longer if the power outage occurs in the morning because the BESS could be charged during the day with surplus solar PV generation.



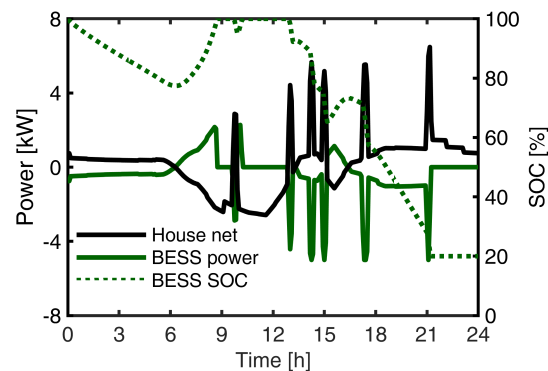
**Figure 6.** The distribution of residence self-sustained operation duration for all 105,120 instances. All instances were binned into duration categories with a time interval of 1-h.



**Figure 7.** The cumulative probability curve for self-sustained operation duration of the reference house. Regardless of when a power outage occurs, the reference house is highly likely to completely self-sustain at 100% load for up to 3 h. If the power outage occurs at any point in time there is a 50% likelihood the residence will self-sustain for up to 10 h.

#### 4. Study for Different Home Load and BESS Energy Capacities

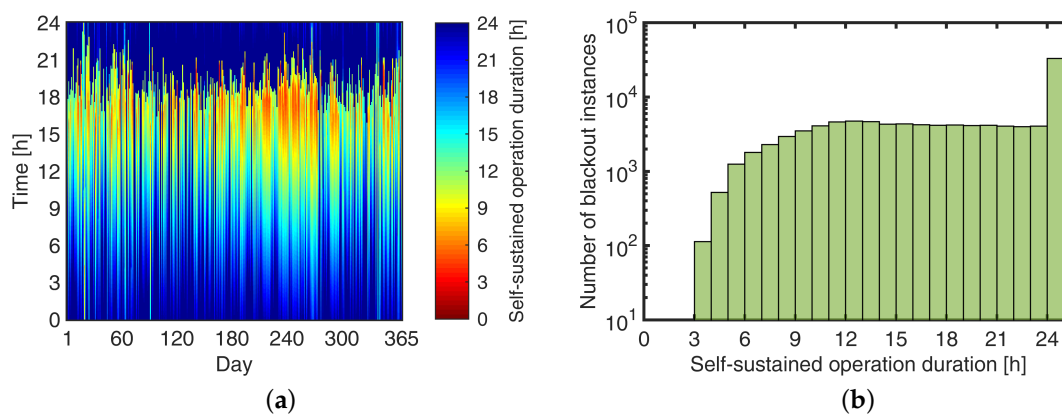
Curtailing the load can reduce the electricity usage and prolong the self-sustained operation in a power outage. The load in Figure 8 was reduced to 50% after the power outage occurred at the midnight. Reducing the load in this scenario enabled the house to self-sustain for approximately 21 h, 4 h more than the reference house at the same instance, as shown in Figure 4a.



**Figure 8.** An example of a self-sustained case with residential load, except for the electric water heater, curtailed to 50% of the reference value. The self-sustainment duration was 21 h, 4 h longer than the reference house because of the lower electricity usage.

Curtailing the residential load increased the self-sustained hours for all 105,120 instances throughout the entire year (Figure 9a). The house load, except for EWH power, was curtailed to 50% while other parameters had the same values from Table 1. The distribution with 1-h interval bins in Figure 9b shows that the probability to self-sustain more than 24 h was increased to approximately 31% when the residential load was curtailed to 50%. Meanwhile, the reference house without load curtailment has a near 0% chance to self-sustain for more than 24 h (Figure 7).

A BESS with larger capacity could store more surplus energy from solar PV generation and sustain the house for a longer time when a power outage occurs. When the house was connected to a BESS with a capacity of 27 kWh, the self-sustained operation duration was prolonged to 22 h, as shown in Figure 10, 5 h more than the reference house case in Figure 4a.

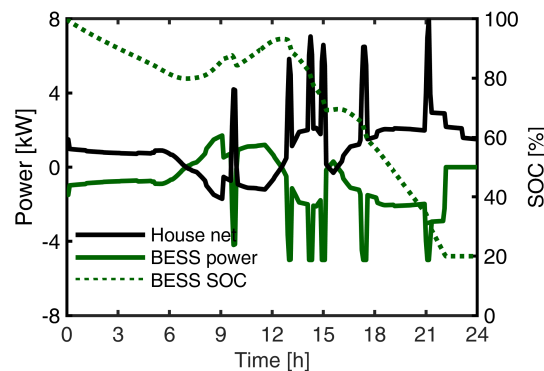


**Figure 9.** Self-sustained operation duration of the house with 50% of the reference residential load presented as a (a) heat map and (b) distribution. The likelihood of the house self-sustaining for more than 24 h is approximately 31%.

Larger BESS capacity increased the self-sustained operation duration for all 105,120 instances throughout the entire year (Figure 11a). When the reference house was equipped with a BESS rated at 27 kWh, it could self-sustain at least 24 h for approximately 72% of all instances (Figure 11b). The self-sustained operation duration was extended in general with larger BESS capacity, as cases with longer time intervals increased compared to the reference house case shown in Figure 6.

The effect of combining partial load and BESS capacity modifications on self-sustained operation duration were studied and for each combination, only the probability of self-sustaining for at least 24 h was recorded. For example, the combination of 50% load percentage and 11 kWh BESS resulted in a 31% likelihood of self-sustaining for at least 24 h, as shown in Figure 9. The simulation results for other combinations were summarized

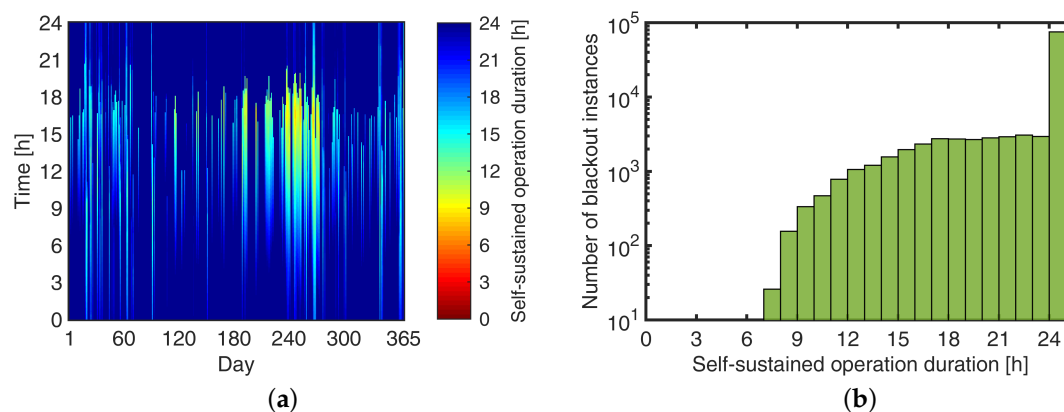
in Figure 12. The load percentages from 50% to 300% covered are representative of the power profiles of residences with different user behaviors and house types. BESS capacities studied were between the range of 10 to 60 kWh. The colors represent the probabilities for residences with combinations of different load percentages and BESS capacities to self-sustain for more than 24 h.



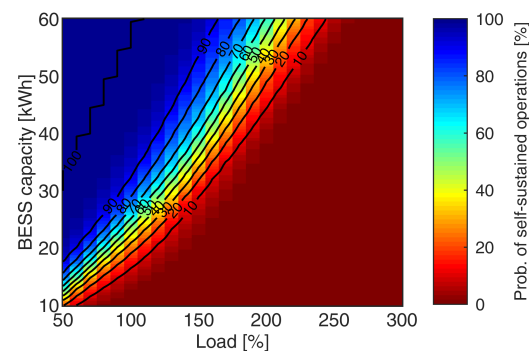
**Figure 10.** An example of self-sustained operation for a house with an increased BESS rating of 27 kWh. In this case, the self-sustained operation of approximately 22 h was 5 h longer than the reference case.

In Figure 12, the horizontal trend indicates the case for different residential loads with a fixed BESS. The case studies for curtailing the reference house from Figure 9 can be referred as the BESS = 11 kWh horizontally. When the residential load of the reference house curtailed from 100% to 50%, the probability to self-sustain more than 24 h was increased from virtually 0% to 31%, as shown in Figure 9. For a BESS capacity larger than 40 kWh, the probability for a house with 100% residential load to self-sustain more than 24 h is almost 95%. With a larger BESS of 60 kWh, the probability for the house to self-sustain at least 24 h is more than 90% even when the load is 150%.

In Figure 12, the vertical trend indicates that for a fixed load percentage, the probability of the residence self-sustaining for more than 24 h increased, in line with the expectations, as the BESS capacity increased. The case study for increasing the BESS capacity to 27 kWh from Figure 11 can be referred to as the Load = 100% case vertically. When the BESS capacity was increased from 11 kWh to 27 kWh, the probability for the house to self-sustain for more than 24 h increases from virtually 0% to 72%. For a house load percentage of less than 250%, increasing the BESS capacity significantly increases the residence self-sustaining duration.



**Figure 11.** Self-sustained operation duration of the house with a BESS rating of 27 kWh is presented as a (a) heatmap, and (b) distribution. The probability that the house can self-sustain for more than 24 h is approximately 72%.



**Figure 12.** Results of a case study examining varying combinations of BESS capacities and home load percentages in self-sustainment duration of 24 h or greater.

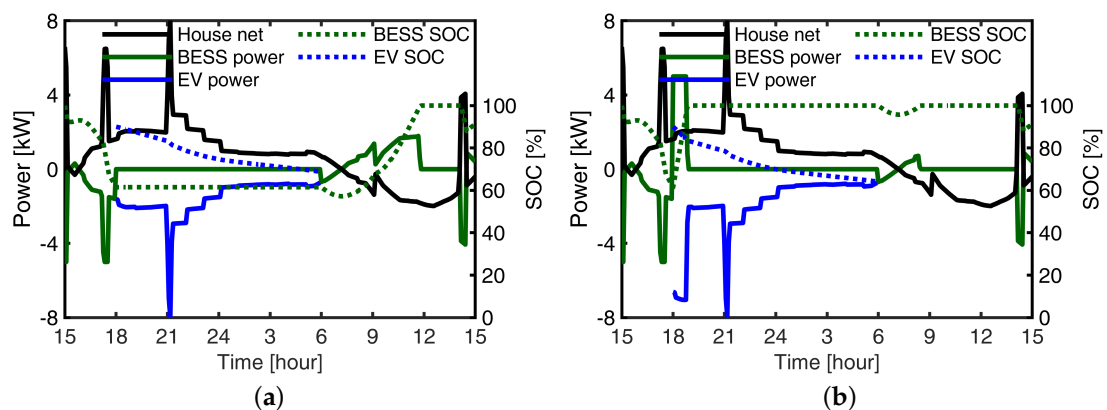
### 5. EV Participation

The reference EV battery considered in the study is rated 90 kWh/10 kW with the returning SOC of 90%, as summarized in Table 1. Within this study, the EV is scheduled to leave and return home at 6 a.m. and 6 p.m., respectively. The EV can interface with the HEMS and supply residential loads when the EV is at home. When supplying power to the home, the total capacity of the residential ESS is expanded and the total energy capacity defined in (3) becomes:

$$E_C = \eta_B \cdot E_{C,B} + \eta_E \cdot E_{C,E} \cdot B_E, \quad (7)$$

where  $\eta_E$  is 80%, the maximum range of the EV battery SOC;  $E_{C,E}$ , the energy capacity of the EV battery;  $B_E$ , Boolean results for 1 represent EV at home, 0 otherwise.

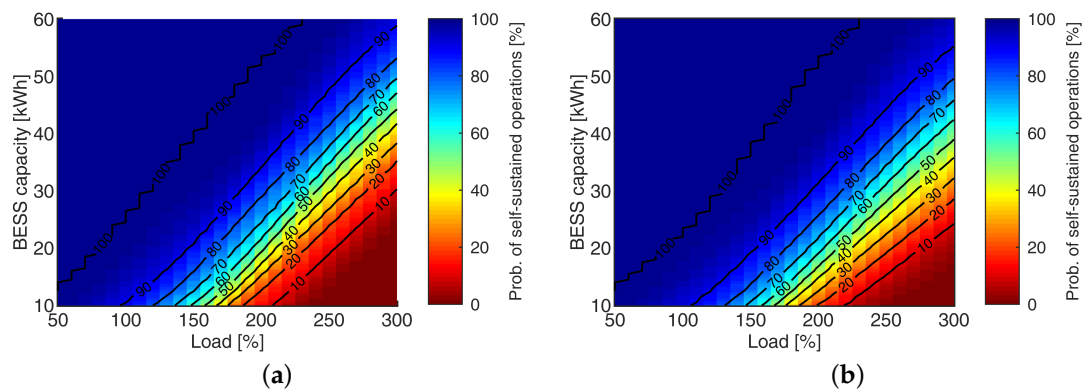
Two types of EV discharging scenarios considering whether or not the BESS was charged by the EV battery were explored in this study. In the first scenario, the EV was discharged to supply the residential load when it arrived home and the BESS stopped discharging, as shown in Figure 13a. As a result, the BESS SOC remained the same until the EV left home at 6 a.m. the next morning. In the second scenario, the EV supplied the residential load and charged the BESS (Figure 13b). In this case, the BESS was left with 100% SOC when EV left home. The residence can self-sustain for more than 24 h under both EV discharging scenarios compared to self-sustaining approximately 5 h in the reference case without EV discharging, as shown in Figure 4b.



**Figure 13.** An example of a self-sustained case for the reference house with EV contributing to (a) supply the residential load only, (b) supply the residential load and charge the BESS. Assuming that the EV arrived home every day at 6 p.m. with a SOC of 90% and left home at 6 a.m. the next day.

Load percentage and BESS capacity effects on self-sustainment were studied and results are shown in Figure 14. For both EV discharging scenarios, the probability to self-sustain more than 24 h was increased to more than 90% for the reference house, which can

be located as (Load = 100%, BESS capacity = 11 kWh) in the heatmap shown in Figure 14. Enabling EV to interface with HEMS increases house resilience significantly compared with the case shown in Figure 12. Furthermore, self-sustainment duration increased when the BESS was able to be charged directly by the EV battery, especially when the load percentage is high. For example, when the BESS capacity is 11 kWh and load percentage is 150%, the results for the two EV discharge scenarios are between [50%, 60%] and [60%, 70%], respectively.

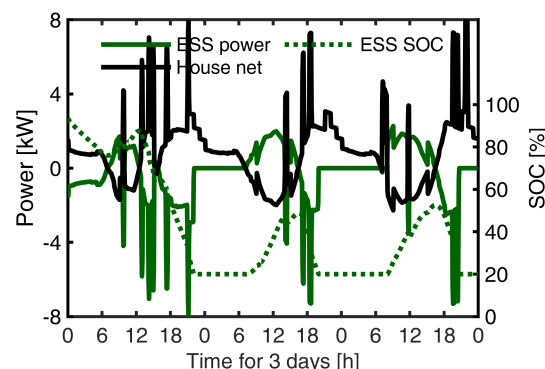


**Figure 14.** Case study for combinations of different load percentage and BESS capacities with an EV participating to (a) supply the residential load only, (b) supply the residential load and charge the BESS.

In some extreme power outages, such as those caused by extended wildfire, the power supply may only be restored after a few days. In such cases, the EV is expected to stay home and its battery can be incorporated to expand the residential ESS capacity, which is defined as:

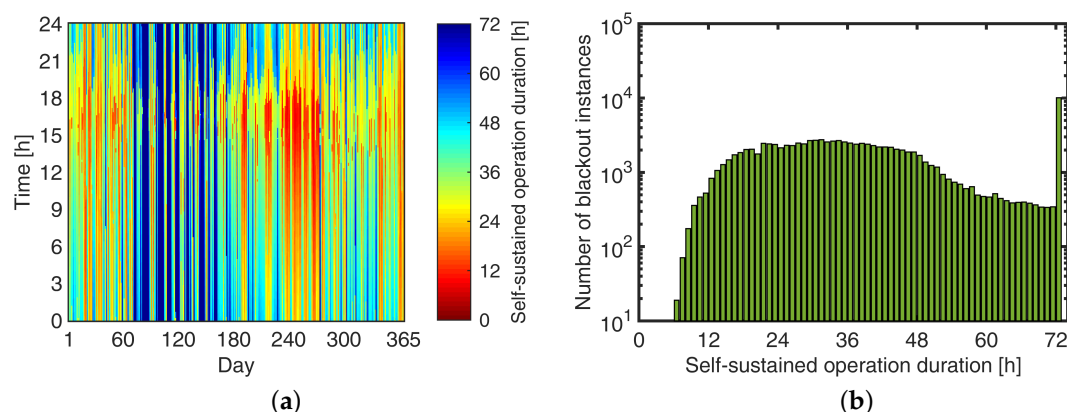
$$E_C = \eta_B E_{C,B} + \eta_E E_{C,E}. \quad (8)$$

The simulation results from Figure 15 show that when the EV battery rated 20 kWh was incorporated in the ESS, self-sustained operation duration was increased to approximately 20 h. Introduction of the EV battery increased the total residential ESS capacity significantly, and since the duration of self-sustainment drastically increased, all instances with an interconnected EV were analyzed for 72 h following an outage.



**Figure 15.** An example self-sustain case for the house with the EV staying at home. Shown is the case with an EV battery rated at 20 kWh. The capacity of the energy storage system (ESS) was expanded dramatically by incorporating the EV battery.

The results for all 105,120 instances are shown in Figure 16. When the EV with a battery of 20 kWh stayed at home, the house could self-sustain longer in general and at least 72 h for approximately 10% of the instances (Figure 16b).

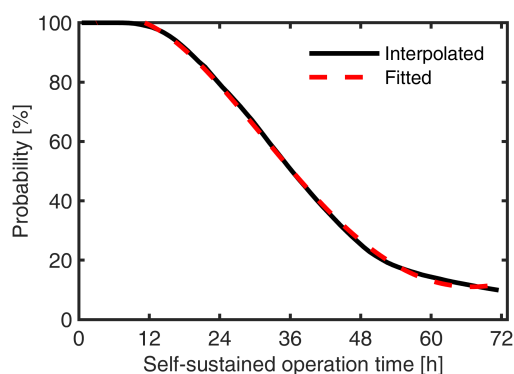


**Figure 16.** The self-sustained operation duration of the house with an EV at home for the duration of 72 h presented as a (a) heatmap, and (b) distribution. The EV battery was rated 20 kWh in this case. The probability that house can self-sustain for at least 72 h is approximately 10%.

With a 20 kWh EV battery staying at home during the outage, threebuilding resilience of the residence improves significantly. The probability of the residence self-sustaining for at least 12 h is almost 100%, as shown in the cumulative probability curve in Figure 17. In this example, the probability that the house could self-sustain at least 24, 48, and 72 h are approximately 80%, 26%, and 10%, respectively. The cumulative distribution of building resilience for varying scenarios was fitted and represented explicitly with a 4th order polynomial equation, as follows:

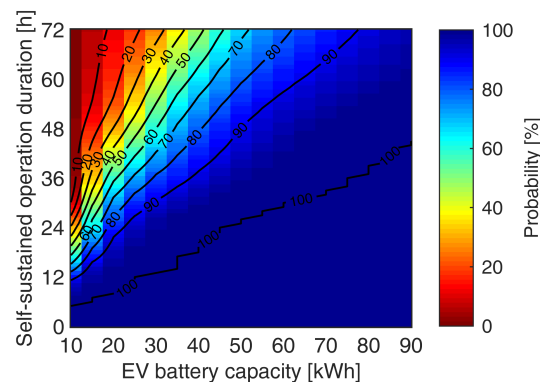
$$f(t) = \begin{cases} 100, & t \in [0, 12) \\ p_1 t^4 + p_2 t^3 + p_3 t^2 + p_4 t + p_5, & t \in [12, 72], \end{cases} \quad (9)$$

where the coefficients are  $p = [-0.0000097, 0.0022765, -0.1557, 1.8578, 95.7078]$ . It is essential to keep the resolution of the first two coefficients 7-decimal to maintain the accuracy.



**Figure 17.** The cumulative distribution for the self-sustained operation duration of the house with an EV at home rated for 20 kWh. threeBuilding resilience was analyzed over a duration of 72 h.

The effect of different EV battery ratings were studied and results are shown in Figure 18. All parameters apart from the EV energy capacity are kept the same as the reference house (Table 1). The probability shown in Figure 17 is represented by the case of fixing the  $x$ -axis at 20 kWh. At this value, the colors show that there exists approximately 80%, 26%, and 10% probability for self-sustainment duration of 24, 48, and 72 h, respectively. EV battery capacities of 30 kWh, 60 kWh, and 90 kWh give the residence a 100% probability to self-sustain approximately 12, 30, and 45 h, respectively. The probabilities for residence with EV battery capacities of 30 kWh, 60 kWh, and 90 kWh to meet a given duration target, e.g., 48 h, are approximately 60%, 92%, and 98%, respectively.



**Figure 18.** Building resilience heatmap for the house with an EV staying at home and providing additional energy storage. The effect of different EV capacities on building resilience was evaluated.

## 6. Discussion

In this paper, the resilience of a building was quantified as the probability to self-sustain for a specified duration of time following a power outage, which can occur at any time throughout an entire year. Factors including the electricity usage of the house, renewable generation, the capacity of the residential energy storage system (ESS), and the availability of a electric vehicle (EV) with its associated battery have been studied. The results show that the reference house considered could self-sustain up to 3 h in almost all instances.

The probabilities for a house to self-sustain for at least 24 h were summarized for combinations of different home loads, which range from 50% to 300%, and BESS capacities, which range from 10 kWh to 60 kWh. For a residence with a fixed BESS capacity, of 40 kWh, the quantified results, which are the probabilities for the house to self-sustain for at least 24 h are 100%, 95%, and 60%, for home load percentages of 50%, 100%, and 150%, respectively. For the example residence with 100% full load, the quantified results, which are the probabilities for the house to self-sustain for at least 24 h are 0%, 25%, and 95%, for BESS capacity of 11 kWh, 20 kWh, and 40 kWh, respectively. The quantified results provides the utility and house owners with the basis for planning rolling blackout, power restoration, and for sizing the residential ESS.

This paper explored the possibility of utilizing an EV during a power outage by incorporating its charged battery into the residential ESS. Considering fixed times for the EV departure from and return to the residence, building resilience increased for all cases even when the EV is away and not available in the daytime. The probability of a reference house with a BESS of 11 kWh, home load percentage of 100%, and a EV battery of 90 kWh to self-sustain for at least 24 h is approximately 90% in such cases. When the house owner opts to keep the EV at home all the time during an extreme power outage, building resilience increased significantly even without load curtailment. The results show that incorporating the EV battery into residential ESS substantially increases self-sustainment duration. With EV battery capacities of 20 kWh, 50 kWh, and 90 kWh, the probability for the house to self-sustain 24 h is, 85%, 100%, and 100%, respectively. With the same capacities, the probability to self-sustain for 48 h is, 30%, 90%, and 98%, respectively.

The effect of different PV ratings was studied with PV rating being changed from 5 kW to 10 kW with increments of 0.1 kW. Results show that, with the ratings considered and all other parameters fixed, this has a negligible impact on building resilience as minor changes in self-sustained duration were noted. This indicates that the capacity of the BESS and that of an additional EV battery system provided have some of the largest impact on improving building resilience.

## 7. Conclusions

A procedure was developed to estimate the building resilience considering the load percentage, capacity of BESS and EV battery. A reference house from California, with an

annual electricity usage of 13,628 kWh and a BESS with capacity of 11 kWh, was used as the baseline for developing the building resilience model. The probability for the reference house to self-sustain for more than 3, 10, and 24 h was found to be 100%, 50% and 0%, respectively. For the reference house, when the BESS capacity was increased, for example, to 40 kWh, the probability for the house to self-sustain for at least 24 h increased to 95%. When the load of the reference house was reduced, for example, to 50%, while other parameters were kept the same, the probability of self-sustaining for 24 h increased to 31%. When an EV with a battery capacity of 90 kWh was incorporated in the home energy management system, the probability for the reference house to self-sustain at least 24 h increased to 90%. If this same EV was parked at home all the time, the probability to self-sustain 24 h was 100%, and the likelihood of self-sustaining for 48 h increased to 98%. When the EV battery capacity was 20 kWh, the results for 24 and 48 h were 85% and 30%, respectively.

**Author Contributions:** Conceptualization, H.G. and D.M.I.; Formal analysis, H.G.; Funding acquisition, D.M.I.; Investigation, H.G.; Methodology, H.G. and D.M.I.; Supervision, D.M.I.; Writing—original draft, H.G.; Writing—review & editing, H.G. and D.M.I. All authors have read and agreed to the published version of the manuscript.

**Funding:** This work was supported in part by the U.S. Department of Energy (DOE) under the program DE-FOA-0001740, project DE-EE0008352, “Solar Power Electronics Modular Integrated Node Platform”, led by Flex Power Control, Inc. Any opinions, findings, and conclusions or recommendations expressed in this material are those of the authors and do not necessarily reflect the views of DOE.

**Institutional Review Board Statement:** Not applicable.

**Informed Consent Statement:** Not applicable.

**Acknowledgments:** This work was supported in part by the DOE program contract DE-EE00008352 and the authors would like to thank the project collaborators and especially Gregory Smith, and May Jang of Flex Power Control, Inc. The suggestions and information provided by Eklas Hossain of Oregon Institute of Technology, Vandana Rallabandi of GE Research, Seun Akeyo of Sargent & Lundy, and Donovin Lewis are gratefully acknowledged.

**Conflicts of Interest:** The authors declare no conflict of interest.

## References

1. Erickson, E.; Slobodin, R.; Poshtan, M.; Taufik, T.; Callenes, J. Using Power Infrastructures for Wildfire Detection in California. In Proceedings of the 2020 IEEE Power & Energy Society Innovative Smart Grid Technologies Conference (ISGT), Washington, DC, USA, 17–20 February 2020; pp. 1–5.
2. California Fire Statistics. Available online: <https://www.fire.ca.gov/stats-events/> (accessed on 9 April 2021).
3. Prohov, J. Millions of Texans without Electricity during Winter Storm, Rotating Power Outages Could Now Last for ‘Hours’. Available online: <https://www.kcentv.com/article/weather/live-updates-winter-storm-north-texas-dallas-fort-worth-february-15-2021/287-6f6cca9f-f093-481e-9d1e-4b3c4c91c64d> (accessed on 9 April 2021).
4. Frozen Wind Turbines Contribute to Rolling Power Blackouts across Texas. Available online: <https://www.cnn.com/2021/02/15/us/power-outages-texas-monday/index.html> (accessed on 9 April 2021).
5. Afzalan, M.; Jazizadeh, F. Quantification of Demand-Supply Balancing Capacity among Prosumers and Consumers: Community Self-Sufficiency Assessment for Energy Trading. *Energies* **2021**, *14*, 4318. [CrossRef]
6. U.S. Energy Information Administration—Electricity. Available online: <https://www.eia.gov/electricity/data/state/> (accessed on 9 April 2021).
7. Rajput, P.; Malvoni, M.; Manoj Kumar, N.; Sastry, O.S.; Jayakumar, A. Operational performance and degradation influenced life cycle environmental–economic metrics of mc-Si, a-Si and HIT photovoltaic arrays in hot semi-arid climates. *Sustainability* **2020**, *12*, 1075. [CrossRef]
8. Gangwar, P.; Kumar, N.M.; Singh, A.K.; Jayakumar, A.; Mathew, M. Solar photovoltaic tree and its end-of-life management using thermal and chemical treatments for material recovery. *Case Stud. Therm. Eng.* **2019**, *14*, 100474. [CrossRef]
9. Chatterji, E.; Bazilian, M.D. Battery Storage for Resilient Homes. *IEEE Access* **2020**, *8*, 184497–184511. [CrossRef]
10. Independent Statistics & Analysis. *Battery Storage in the United States: An Update on Market Trends*; Technical Report; U.S. Department of Energy (DOE): Washington, DC, USA, 2020.



11. Bhattacharjee, A.; Mohanty, R.K.; Ghosh, A. Design of an optimized thermal management system for Li-ion batteries under different discharging conditions. *Energies* **2020**, *13*, 5695. [[CrossRef](#)]
12. California Auto Outlooks. Available online: <https://www.cncda.org/news/> (accessed on 9 April 2021).
13. Gong, H.; Rallabandi, V.; McIntyre, M.L.; Hossain, E.; Ionel, D.M. Peak Reduction and Long Term Load Forecasting for Large Residential Communities including Smart Homes with Energy Storage. *IEEE Access* **2021**, *9*, 19345–19355. [[CrossRef](#)]
14. Hou, X.; Wang, J.; Huang, T.; Wang, T.; Wang, P. Smart home energy management optimization method considering energy storage and electric vehicle. *IEEE Access* **2019**, *7*, 144010–144020. [[CrossRef](#)]
15. Cerna, F.V.; Pourakbari-Kasmaei, M.; Pinheiro, L.S.; Naderi, E.; Lehtonen, M.; Contreras, J. Intelligent Energy Management in a Prosumer Community Considering the Load Factor Enhancement. *Energies* **2021**, *14*, 3624. [[CrossRef](#)]
16. Gong, H.; Ionel, D.M. Optimization of Aggregated EV Power in Residential Communities with Smart Homes. In Proceedings of the 2020 IEEE Transportation Electrification Conference & Expo (ITEC), Chicago, IL, USA, 23–26 June 2020; pp. 779–782.
17. Monteiro, V.; Pinto, J.G.; Afonso, J.L. Operation modes for the electric vehicle in smart grids and smart homes: Present and proposed modes. *IEEE Trans. Veh. Technol.* **2015**, *65*, 1007–1020. [[CrossRef](#)]
18. Shin, H.; Baldick, R. Plug-in electric vehicle to home (V2H) operation under a grid outage. *IEEE Trans. Smart Grid* **2016**, *8*, 2032–2041. [[CrossRef](#)]
19. Monteiro, V.; Sousa, T.J.; Couto, C.; Martins, J.S.; Melendez, A.A.N.; Afonso, J.L. A novel multi-objective off-board EV charging station for smart homes. In Proceedings of the IECON 2018–44th Annual Conference of the IEEE Industrial Electronics Society, Washington, DC, USA, 21–23 October 2018; pp. 1983–1988.
20. Xu, N.Z.; Chan, K.W.; Chung, C.Y.; Niu, M. Enhancing adequacy of isolated systems with electric vehicle-based emergency strategy. *IEEE Trans. Intell. Transp. Syst.* **2019**, *21*, 3469–3475. [[CrossRef](#)]
21. Rastegar, M.; Fotuhi-Firuzabad, M. Outage management in residential demand response programs. *IEEE Trans. Smart Grid* **2014**, *6*, 1453–1462. [[CrossRef](#)]
22. Alahyari, A.; Fotuhi-Firuzabad, M.; Rastegar, M. Incorporating customer reliability cost in PEV charge scheduling schemes considering vehicle-to-home capability. *IEEE Trans. Veh. Technol.* **2014**, *64*, 2783–2791. [[CrossRef](#)]
23. Hsu, Y.C.; Kao, S.C.; Ho, C.Y.; Jhou, P.H.; Lu, M.Z.; Liaw, C.M. On an electric scooter with G2V/V2H/V2G and energy harvesting functions. *IEEE Trans. Power Electron.* **2017**, *33*, 6910–6925. [[CrossRef](#)]
24. Panteli, M.; Pickering, C.; Wilkinson, S.; Dawson, R.; Mancarella, P. Power system resilience to extreme weather: Fragility modeling, probabilistic impact assessment, and adaptation measures. *IEEE Trans. Power Syst.* **2016**, *32*, 3747–3757. [[CrossRef](#)]
25. Watson, E.B.; Etemadi, A.H. Modeling electrical grid resilience under hurricane wind conditions with increased solar and wind power generation. *IEEE Trans. Power Syst.* **2019**, *35*, 929–937. [[CrossRef](#)]
26. Sangswang, A.; Konghirun, M. Optimal Strategies in Home Energy Management System Integrating Solar Power, Energy Storage, and Vehicle-to-Grid for Grid Support and Energy Efficiency. *IEEE Trans. Ind. Appl.* **2020**, *56*, 5716–5728. [[CrossRef](#)]
27. Jamborsalamati, O.; Hossain, M.J.; Taghizadeh, S.; Konstantinou, G.; Manbachi, M.; Dehghanian, P. Enhancing power grid resilience through an IEC61850-based ev-assisted load restoration. *IEEE Trans. Ind. Inform.* **2019**, *16*, 1799–1810. [[CrossRef](#)]
28. Hossain, E.; Roy, S.; Mohammad, N.; Nawar, N.; Dipta, D.R. Metrics and enhancement strategies for grid resilience and reliability during natural disasters. *Appl. Energy* **2021**, *290*, 116709. [[CrossRef](#)]
29. Bertoluzzo, M.; Giacomuzzi, S.; Kumar, A. Design of a Bidirectional Wireless Power Transfer System for Vehicle-to-Home Applications. *Vehicles* **2021**, *3*, 406–425. [[CrossRef](#)]
30. The Electric Ford F-150 Can Power Your Entire House for Three Days on a Single Charge. Available online: <https://www.thedrive.com/tech/40695/the-electric-ford-f-150-can-power-your-entire-house-for-three-days-on-a-single-charge> (accessed on 25 May 2021).
31. Gong, H.; Rallabandi, V.; Ionel, D.M.; Colliver, D.; Duerr, S.; Ababei, C. Dynamic modeling and optimal design for net zero energy houses including hybrid electric and thermal energy storage. *IEEE Trans. Ind. Appl.* **2020**, *56*, 4102–4113. [[CrossRef](#)]
32. Building Energy Codes Program—Residential Prototype Building Models. Available online: [https://www.energycodes.gov/development/residential/iecc\\_models](https://www.energycodes.gov/development/residential/iecc_models) (accessed on 9 April 2021).
33. Burbank-Glendale-Pasadena Bob Hope AP 722880 (TMY3). Available online: [https://energyplus.net/weather-location/north\\_and\\_central\\_america\\_wmo\\_region\\_4/USA/CA/USA\\_CA\\_Burbank-Glendale-Pasadena.Bob.Hope.AP.722880\\_TMY3](https://energyplus.net/weather-location/north_and_central_america_wmo_region_4/USA/CA/USA_CA_Burbank-Glendale-Pasadena.Bob.Hope.AP.722880_TMY3) (accessed on 9 April 2021).
34. CBECC-Res Compliance Software Project. Available online: <http://www.bwilcox.com/BEES/cbecc2019.html> (accessed on 9 April 2021).
35. FlexPower—Discover SPIN. Available online: <http://flxpwr.com/> (accessed on 9 April 2021).
36. Multifunction power management system. Available online: <https://uspto.report/patent/grant/11,011,913> (accessed on 29 June 2021).