

Numerical Analysis of Power System Electromechanical and Electromagnetic Transients based on the Finite Element Technique

I. JURIĆ-GRGIĆ, M. KURTOVIĆ, R. LUCIĆ

University of Split, Faculty of Electrical Engineering,
Mechanical Engineering and Naval Architecture
Croatia

SUMMARY

This paper presents a novel technique for numerical analysis of electromagnetic transients and electromechanical oscillations in a power system. The proposed method is based on the finite element method (FEM). The finite element technique so far used for numerical analysis of continuum field problems here has been adopted to analyse electromagnetic and electromechanical transients in a power system. According to the finite element technique in the field problem, where the region of interest is divided into finite elements, in the proposed method power system is also divided into electric power system (finite) elements. Each finite element (generator, transformer, transmission line, load etc.) is characterized by a system of governing differential equations. Using generalized trapezoidal rule, also known as theta-method for time integration, the system of differential equations of each electric power system (finite) element can be transformed to the system of algebraic equations for every time step. Once when a system of algebraic equations of each electric power system element is obtained, assembly procedure has to be done. The main contribution of the proposed approach is in an assembly procedure. With the proposed approach, in case of any disturbances in power system or in a part of power system, nodal voltage and branch currents will be obtained, as well as all other interesting variables. The proposed method will be tested on the example of the single-phase short circuit in the power system.

KEYWORDS

Electromagnetic transients, Electromechanical oscillations, Power system, Finite Element Technique

ijuricgr@fesb.hr

1. INTRODUCTION

The finite element technique has been widely used in 2D and 3D field problems. To the best of our knowledge, it is not known, that the finite element method is used for electrical network analysis in electrical power system. For power system electromechanical analysis, software package EMTP and Matlab-Simulink are commonly used. On the other hand as the result of our research, the papers [1] and [2] report successful use of the finite element technique for power system analysis. The main contribution of the proposed method over the other known methods is simplification of algorithm by using assembly procedure in a sense of the finite element technique. Each finite element (generator, transformer, transmission line, load etc.) is characterized by a system of governing differential equations. Using generalized trapezoidal rule, also known as theta-method for time integration, the system of differential equations of each electric power system (finite) element can be transformed to the system of algebraic equations for every time step. The entire power system is modeled by assembling the system of algebraic equations of all finite elements. The finite element matrices of electric power system are obtained in natural (a,b,c) coordinates. With such approach the solution of the multimachine problem in a power system is natural and straightforward.

2. SYNCHRONOUS GENERATOR AS FINITE ELEMENT

The three phase synchronous generator with field and damper windings is represented as one finite element with three nodes namely 1,2,3.

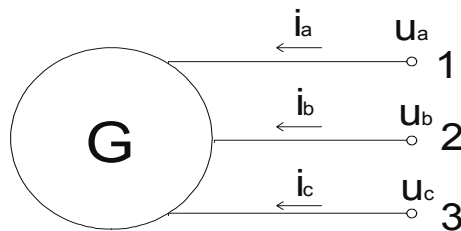

Fig. 1. Synchronous generator finite element

The starting point to obtain the local matrix and vector of synchronous generator finite element is a system of the following equations :

$$\{u\} = [R] \cdot \{i\} + \frac{d}{dt} [\Psi] \quad (1)$$

$$\omega = \frac{d\gamma}{dt} \quad (2)$$

$$T_m \frac{d\omega}{dt} = m_m - m_{el} \quad (3)$$

where are:

$$\{i\}^T = [i_a \ i_b \ i_c \ i_f \ i_D \ i_Q]$$

$[\Psi]$ - (6,6) magnetic flux matrix

ω - electrical angular frequency

t - time

i_f - field coil current

u_f - field coil voltage

$$\{u\}^T = [u_a \ u_b \ u_c \ u_f \ 0 \ 0]$$

$[R]$ - (6,6) resistance matrix

γ - electrical angle of rotor position

i_Q - damper winding current in axes q

i_D - damper winding current in axes d

Time integration of equations (1), (2) and (3) by θ - method, yields equations (4), (5) and (6) :

$$\begin{aligned} \{\Psi\}^+ - \{\Psi\} + [R] \theta \Delta t \{i\}^+ + [R] (1-\theta) \Delta t \{i\} \\ - \theta \Delta t \{u\}^+ - (1-\theta) \Delta t \{u\} = 0 \end{aligned} \quad (4)$$

$$\gamma^+ = \gamma + \omega \Delta t \quad (5)$$

$$\omega^+ = \frac{\theta \Delta t}{T_m} m_m^+ + \frac{(1-\theta) \Delta t}{T_m} m_m - \frac{\theta \Delta t}{T_m} m_{el}^+ - \frac{(1-\theta) \Delta t}{T_m} m_{el} + \omega \quad (6)$$

System of equations (4) need to be rearranged to the system of the algebraic equations which will be suitable for assembling procedure with the rest of the power system :

$$\{i_1^+\} = [E_1] \{u_1^+\} + [E_2] \{u_2^+\} + [D_1] \{u_1\} + [D_2] \{u_2\} + [C_1] \{i_1\} + [C_2] \{i_2\} \quad (7)$$

$$\{i_2^+\} = [E_3] \{u_1^+\} + [E_4] \{u_2^+\} + [D_3] \{u_1\} + [D_4] \{u_2\} + [C_3] \{i_1\} + [C_4] \{i_2\} \quad (8)$$

The finite element local system of the generator is given by the system of algebraic equations (5), (6), (7) and (8). The voltage regulator as an essential part of synchronous generator is modeled by the system of appropriate equations and is shown in [2]. The other power system elements used in this paper such as transmission line, transformer, power system network equivalent and three-phase load are also given in the papers [1] and [2].

3. NUMERICAL EXAMPLE

In order to verify the proposed method, electromagnetic transients and electromechanical behavior of the electric power system, shown in Figure 2, have been analyzed. In the considered power system at the certain moment of time the single-phase short circuit occurs in the middle of double transmission line system. This caused opening of the circuit breakers at the both ends of faulted system of double transmission line system. As the result of mentioned switching operation overvoltages and electromechanical oscillations due to sudden short circuit on the transmission line have been occurred.

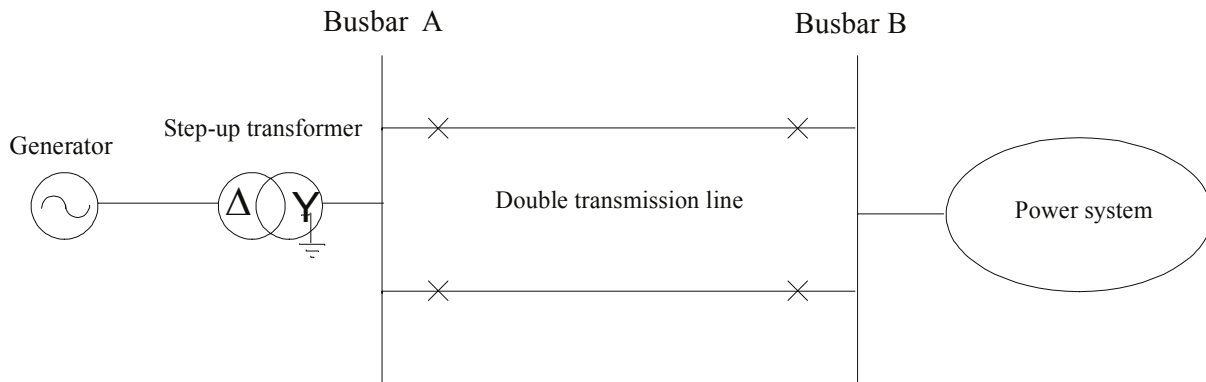

Fig.2. Single-phase scheme of the power system

The generator data are: $S_n = 120$ MVA, $P_n = 108$ MW, $Q_n = 52.3$ Mvar, $U_n = 14.4$ kV, $I_n = 4811$ A, $I_{f0} = 690$ A, $I_{fn} = 1192$ A.

Available parameters of generator are:

- reactance's (pu) $x_d = 1.01$, $x_q = 0.666$, $x_q'' = 0.287$, $x_d' = 0.421$, $x_d'' = 0.268$, $x_\sigma = 0.198$
- armature resistance (pu) $r = 0.00236$
- time constants $T_d' = 3.4$ s, $T_{d0}' = 7.5$ s, $T_d'' = 0.0554$ s, $T_q'' = 0.0876$ s
- mechanical time constant $T_{mG} = 8.63$ s

Step-up transformer data are: $S_n = 120$ MVA, dY5, $U_{n1}/U_{n2} = 10.5/220$ kV, $u_k = 12.06$ %, $P_k = 270$ kW

On the basis of transmission line characteristics, calculated parameters are:

$$[R] = \begin{bmatrix} a & b & c & a_2 & b_2 & c_2 \\ a & 0.18 & 0.09 & 0.09 & 0.09 & 0.09 & 0.09 \\ b & 0.09 & 0.18 & 0.09 & 0.09 & 0.09 & 0.09 \\ c & 0.09 & 0.09 & 0.18 & 0.09 & 0.09 & 0.09 \\ a_2 & 0.09 & 0.09 & 0.09 & 0.18 & 0.09 & 0.09 \\ b_2 & 0.09 & 0.09 & 0.09 & 0.09 & 0.18 & 0.09 \\ c_2 & 0.09 & 0.09 & 0.09 & 0.09 & 0.09 & 0.18 \end{bmatrix} (\Omega/km)$$

$$[L] = \begin{bmatrix} a & b & c & a_2 & b_2 & c_2 \\ a & 2.2 & 0.796 & 0.796 & 0.796 & 0.796 & 0.796 \\ b & 0.796 & 2.2 & 0.796 & 0.796 & 0.796 & 0.796 \\ c & 0.796 & 0.796 & 2.2 & 0.796 & 0.796 & 0.796 \\ a_2 & 0.796 & 0.796 & 0.796 & 2.2 & 0.796 & 0.796 \\ b_2 & 0.796 & 0.796 & 0.796 & 0.796 & 2.2 & 0.796 \\ c_2 & 0.796 & 0.796 & 0.796 & 0.796 & 0.796 & 2.2 \end{bmatrix} (\text{mH}/km)$$

$$[C] = \begin{bmatrix} a & b & c & a_2 & b_2 & c_2 \\ a & 7.76 & -0.76 & -0.76 & -0.76 & -0.76 & -0.76 \\ b & -0.76 & 7.76 & -0.76 & -0.76 & -0.76 & -0.76 \\ c & -0.76 & -0.76 & 7.76 & -0.76 & -0.76 & -0.76 \\ a_2 & -0.76 & -0.76 & -0.76 & 7.76 & -0.76 & -0.76 \\ b_2 & -0.76 & -0.76 & -0.76 & -0.76 & 7.76 & -0.76 \\ c_2 & -0.76 & -0.76 & -0.76 & -0.76 & -0.76 & 7.76 \end{bmatrix} (\text{nF}/km)$$

Transmission line length is 82 km.

Parameters of power system network equivalent are obtained from single and three-phase short circuit current data on the busbar "B":

- rated voltage $U_n = 220 \text{ kV}$
- subtransient three-phase short circuit current $I''_{k3} = 15.15 \text{ kA}$
- subtransient single-phase short circuit current $I''_{k1} = 16.46 \text{ kA}$

In order to model considered power system by the finite element technique, the power system has been divided into the 11 parts (finite elements), shown in the Figure 3. This enables us to define a connection matrix of a power system in a sense of the finite element method.

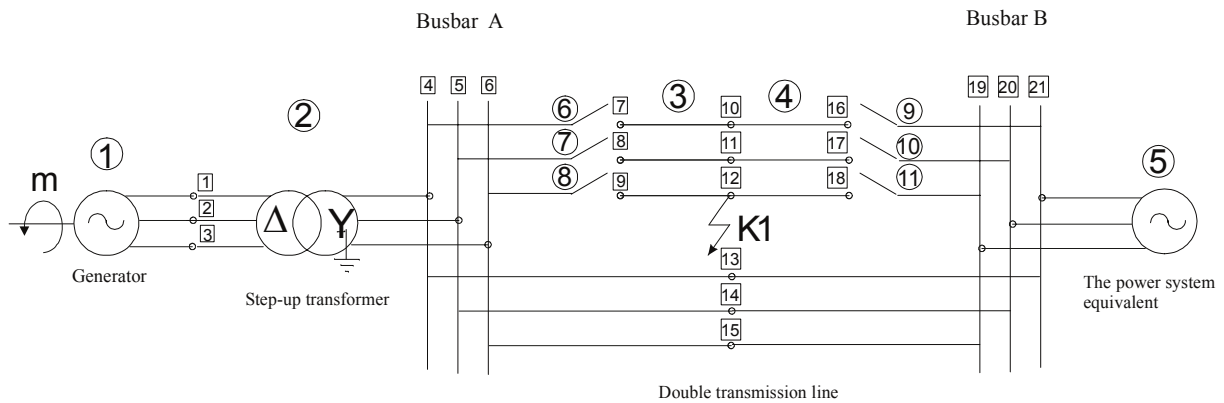

Fig.3. The power system divided to the finite elements

The double transmission line system has been split into two finite elements numbered 3 and 4 with equal lengths of 41 km. The finite elements numbered from 6 to 11 represent single poles of the three phase breakers at the ends of the faulted system of the double transmission line system.

In the beginning of simulation the generator is in nominal operating mode. At the moment $t=0.885 \text{ [s]}$ the single-phase occurs in phase "a" of transmission line. Approximately 100 ms after single-phase short circuit had occurred, the circuit breakers opened at the both ends of the faulted line system.

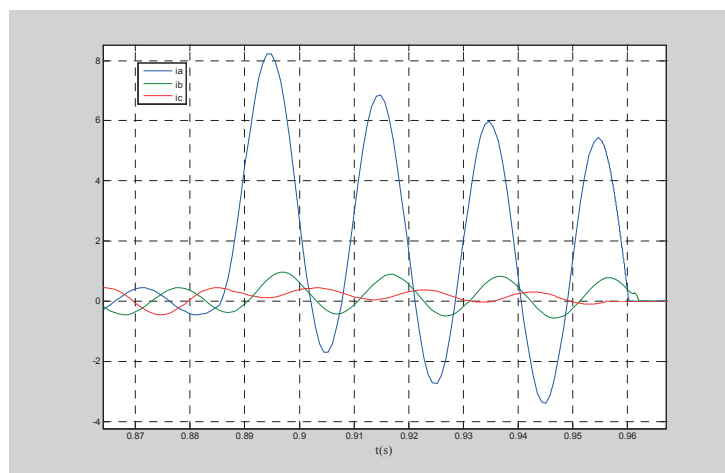

Fig.4. Short circuit currents contributed from busbar "A"

In Figure 4 single-phase short circuit currents of faulted phase “a” and the phases “b” and “c” contributed from busbar “A” are shown. In the Figure 5 overvoltages at the HV-side of the transformer at the busbar “A” after circuit breaker opening are shown.

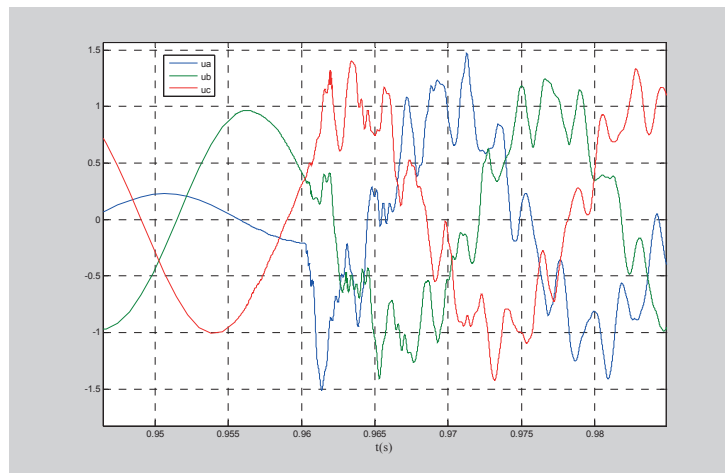

Fig.5. Overvoltages at the HV-side of the transformer at the busbar “A” after circuit breaker opening

According to Figure 5, it can be clearly seen that switching operations at HV-side of the step-up transformer causes approximately 50 % voltage increasing. Due to switching operation, the faulted transmission line of the double transmission line system has been switched off and new steady – state has to be reached. This approach allows us to calculate every interesting variable in all finite elements. For instance, in Figure 6, 7 and 8 electromagnetic moment, field coil current and angular frequency of the generator are shown during entire transient operation.

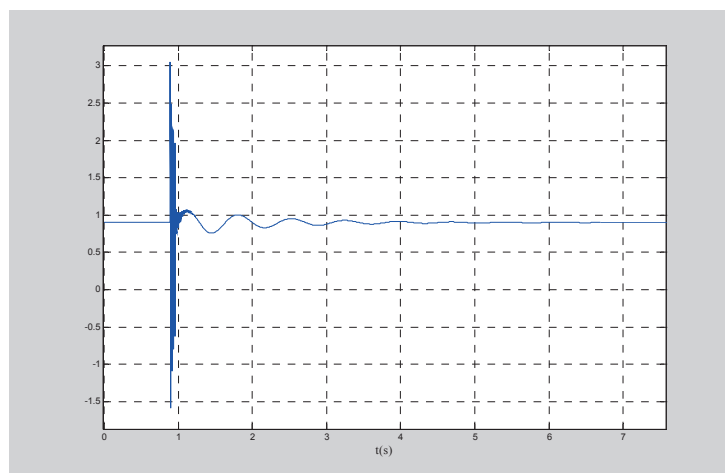

Fig.6. Electromagnetic moment of generator during transient operation

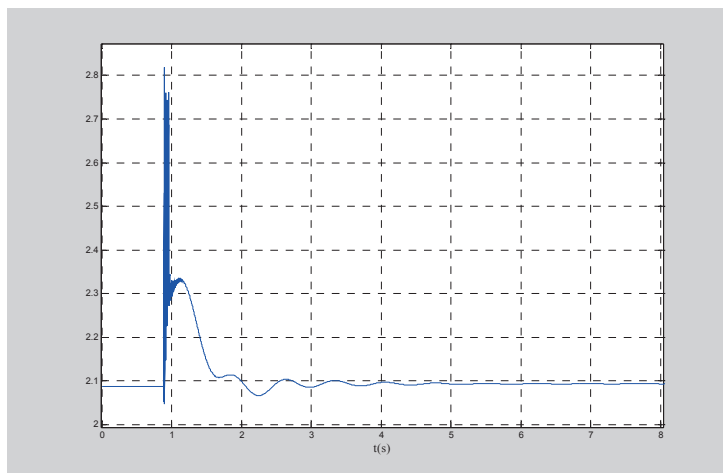

Fig.7. Field coil current of generator during transient operation

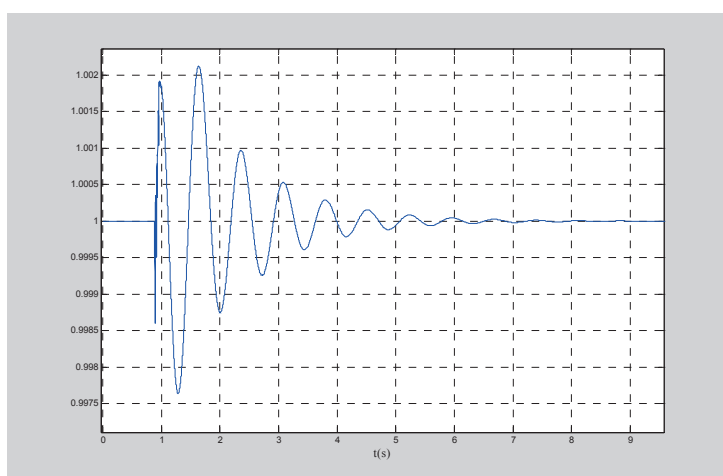

Fig.8. Angular frequency of generator during transient operation

4. CONCLUSION

In this paper the novel method based on the finite element technique has been presented. The proposed method has been successfully applied on short circuit power system analysis. As it has been shown, this approach enables us to calculate currents, voltages as well as other interesting variables in each part of a power system such as generators, transmission lines, transformers etc. Attractive side of this method is a possibility to make a simple algorithm for the multimachine system analysis. The proposed method is competitive, even simpler, than other widely used methods due to elegance of the FEM assembly procedure. As the power system has been built assembling the three phase finite elements, the solution of the multimachine system problem is natural and straightforward.

BIBLIOGRAPHY

- [1] I. Juric-Grgic, R. Lucic, M. Kurtovic "Transients Analysis of Synchronous Generator Using the Finite Element Technique " (Electrical Engineering and Electromagnetics VI, September 2003, pages 137-146)
- [2] I. Juric-Grgic, R. Lucic, M. Kurtovic "Electromagnetic Transients Modeling in Power Systems Using the Finite Element Technique " (Computational Methods and Experimental Measurements XII, 2005, pages 631-639)
- [3] J. Arrillaga, N. Watson "Power Systems electromagnetic transients simulation", The Institution of Electrical Engineers, 2003.
- [4] J. Arrillaga, N. Watson "Computer Modelling of Electrical Power Systems ", 2001.