

Crash simulation and development of automotive bumper impact beam design for weight reduction

Kee Joo Kim⁽¹⁾ and Jun-Hyub Park⁽²⁾

⁽¹⁾Department of Automobile Engineering, Seojeong College University,
1049-56 Whahap-ro, Eunhyeon-Myun, Yangjoo-City, Gyeonggi-do 482-777, KOREA,
e-mail: kjkim@seojeong.ac.kr

⁽²⁾Department of Mechatronics Engineering, Tongmyong University, Busan 608-711, KOREA

SUMMARY

Increasing fuel economy has been a principal issue in the development of new cars. Decrease in weight of vehicle components is one of the important approaches to solving the problem. In order to obtain the goal, researches sought for ways to design lighter and stronger bumper impact beams relinquishing neither impact absorbing capacity of bumpers nor the safety of vehicles. In this paper, a possible weight reduction of impact beam is examined by substituting conventional type of steel with high-strength steel (boron steel having tensile strength 1.5 GPa) with regard to variables such as frontal, offset and corner impact crash capability of a bumper impact beam. In addition, the effects of variation in structural differences in bumper impact beams (open section, closed section, open section with 5 stays) were carefully considered. Arguably, this analysis presents a good guide for an optimum design and development of bumper impact beams.

Key words: automotive body, bumper, open section, closed section, impact beam, weight reduction.

1. INTRODUCTION

Bumpers are automotive parts situated at the front and the rear of a vehicle to ensure the protection of a vehicle body in the case of a low-speed crash. This is enabled via the formability of bumpers and energy absorption during an impact. The bumper primarily consists of an impact beam, bumper stays, impact absorbing materials in the form of structure and a cover. Among these, the majority of energy during an impact is absorbed by the bumper impact beam built in a body side member [1, 2]. The crash capability of the bumper should also meet worldwide regulations regarding the safety of passengers. In order to develop bumpers that might help reduce fuel consumption but still remain safe for passengers, the ways to design lighter, better energy impact absorbing bumpers has

been investigated. To evaluate the structural capability of bumpers, finite element simulation (FE-simulation), whose scope gradually widened, has been adopted for the design [2-5]. There are two methods of weight reduction for the improvement of a vehicle. The first requires the substitution of conventional steel reinforcements with thinner, high-strength steel reinforcements and the second implies the development of substitution materials (Al, Mg, etc.) instead of the steels. However, aluminum alloys or other lighter metal materials have their shortcomings too. High cost, low press formability, adhesion (welding) problems and surface treatment difficulty are some of the disadvantages of using these materials.

In order to apply high-strength steels to vehicle components, high formability of material is required. In the case of high-strength steels, the formability

mostly decreases with the increase of the steel strength. This problem has been solved by hot press forming (or press hardening) process thus ensuring the hardenability increase of boron steel. This process involves rapid cooling after high-temperature forming process for steels containing boron and having bake hardening properties. After the formation process, the shot blasting was performed to remove a thin oxide layer without any particular tempering.

This paper shows the effects of varying the type of material (high-strength steel with tensile strength of $1,500\text{ MPa}$ employed instead of conventional steel) in the design of impact beams, as well as a comparative analysis of frontal, offset and corner impact crash capabilities of such beams with the scope of increasing the possibility of bumper weight reduction. An FE-simulation has been adopted for the analysis.

2. ANALYSIS OF STRUCTURAL PARAMETERS BY FE-SIMULATION

Figure 1 presents an FE-simulation model of a bumper impact beam including load and boundary conditions. To calculate the torsional stiffness in various cases, one side of the impact beam was fixed using rigid body element (RBE) and a unit moment of 100 Nmm was applied to the end of the other side of the beam, as shown in Figure 1.

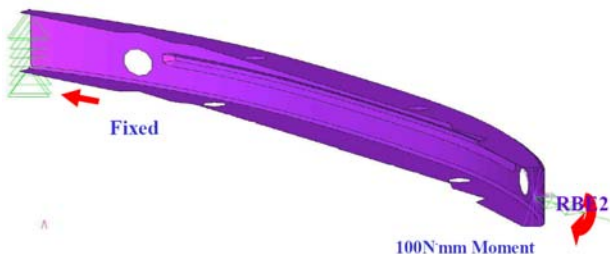

Fig. 1 Model of a bumper impact beam including boundary conditions

The effect of section height (with an initial height of 109 mm), as yet another variable having an effect on the torsional stiffness of bumper impact beam, was analysed. The initial section height of the impact beam was magnified to 165.5 mm (1.5 times), 218 mm (2 times) and 272.5 mm (2.5 times), respectively. In addition, the effect of variation in structural design (the number of stays) on the torsional stiffness of bumper impact beam was analysed. The initial open section design of the impact beam was varied according to the number of stays in the section (from 3 to 7). Moreover, the effect of varying thickness of the beam (from initial thickness of 2.0 mm to 3.5 mm) on the torsional stiffness were investigated as well.

Figure 2 shows the predicted displacement results of the bumper impact beam with a maximum displacement of 1.07 E-01 mm . Lower displacement indicates higher torsional stiffness.

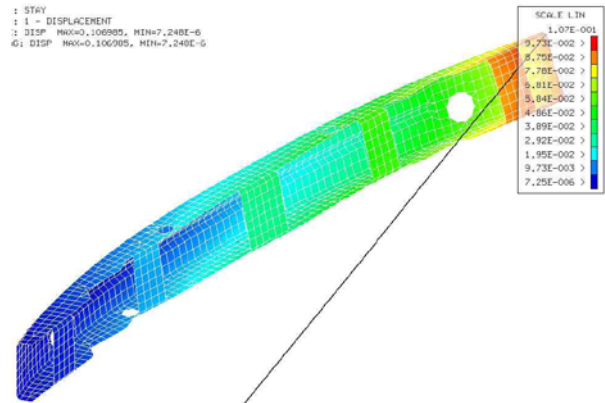

Fig. 2 Predicted displacement of bumper impact beam in case of 5 stays (max.displ.: 1.07 E-01 mm)

Figure 3 shows the results of the effects that structural design differences have on the torsional stiffness. Larger number of stays contributed to the higher torsional stiffness of the impact beam. Additionally, if the back of the impact beam had fully closed section, the torsional stiffness of impact beam was 500 times higher than that of open section [6].

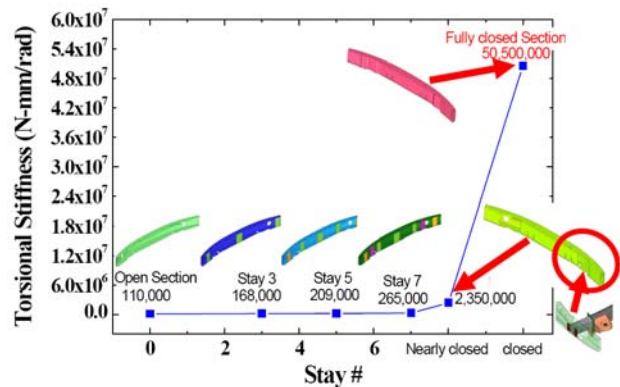

Fig. 3 Effect of the varying number of stays on torsional stiffness

Figure 4 shows the results of simulation taking into account parameters such as section height, thickness and change in design of an impact beam and singling out the most effective method for the increase of torsional stiffness of the beam. Among these parameters, the increase in section height of a beam proved as the most effective parameter. In addition, the design change (adding on the number of stays) proved to be the least effective method in obtaining the desired goal. Finally, the section height should be maximized to effectively increase the torsional stiffness of the bumper impact beam.

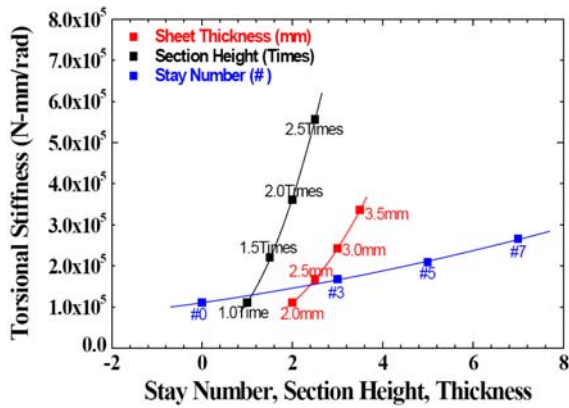

Fig. 4 Effect of section variations on torsional stiffness [6]

3. ANALYSIS OF WEIGHT REDUCTION AND IMPACT CHARACTERISTICS AS A CONSEQUENCE OF MATERIAL CHANGE

A comparative study was conducted on two different types of material for the production of bumper impact beams. The first was SPFC780 (tensile strength of 780 MPa), commercially available material, and the other was boron steel (tensile strength of 1,500 MPa). Table 1 shows the mechanical properties of the two types of steel, while Figure 5 presents experimentally measured tensile curve of boron steel. Weight reduction was tested for cases in which bumper impact beams made of high-strength boron steel varied in design. Several models were tested, from the one having closed section structure to the modified one containing open section without deterioration of impact capability. Figures 6(a), 6(b) and 6(c) show simulation of loading conditions for frontal, offset and corner impacts, respectively. The impact simulation was done by using commercial software LS-DYNA3D.

Table 1. Mechanical properties of beam materials

Materials	Yield strength (MPa)	Tensile strength (MPa)	Elongatin (%)
SPFC780	534.6	816.6	15.4
Boron steel	1,048.1	1467.8	7.9

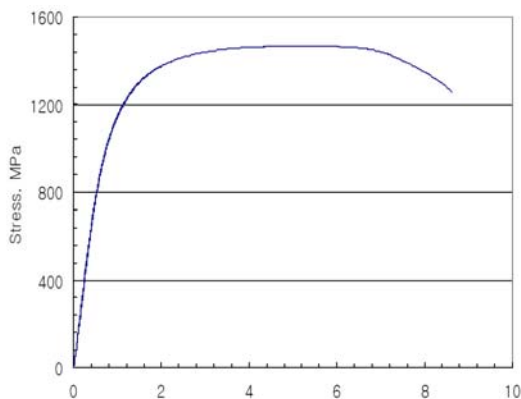

Fig. 5 Experimentally obtained tensile curve for boron steel

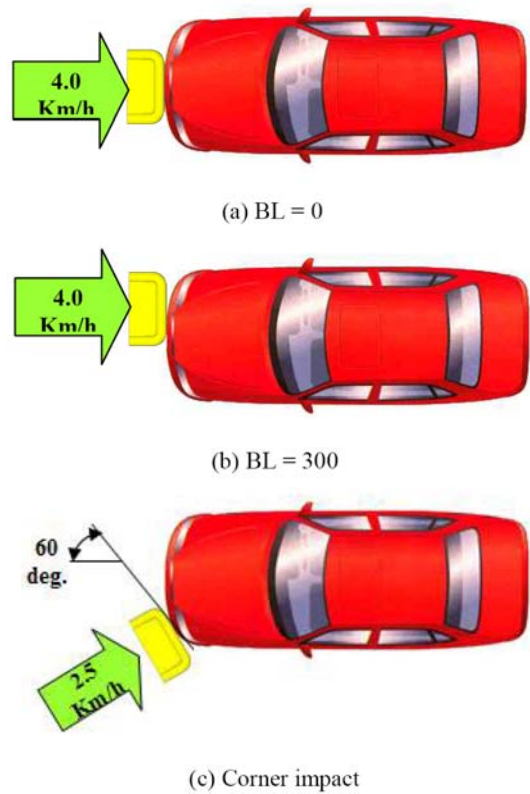

Fig. 6 Impact conditions (speed and loading regions)

Figures 7(a), 7(b) and 7(c) show the FE-models for frontal, offset and corner impact simulations, respectively.

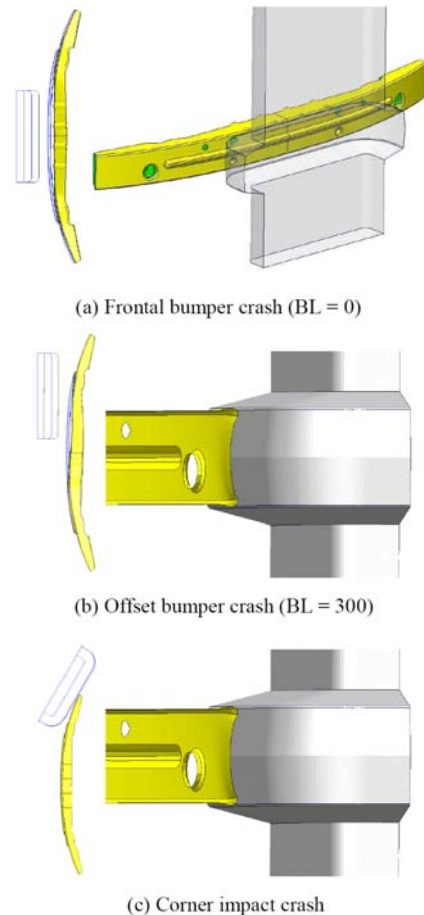

Fig. 7. FE-model for frontal impact simulation

Figure 8 shows the simulation of an impact with an intrusion displacement in the longitudinal direction of a vehicle (X-displacement) versus time after frontal impact simulation for material SPFC780 and in the case of a closed section. In this case, the maximum intrusion displacement was 21.3 mm.

Figure 9(a) shows the simulation of an impact with a resulting intrusion displacement in the longitudinal direction of a vehicle (X-displacement) versus time after frontal impact in the case of boron steel beams with an open section structure. In this case, the maximum intrusion displacement was 24.6 mm. Figure 9(b) shows an intrusion displacement in the longitudinal direction of a vehicle (X-displacement) versus time after an offset impact for beam made of boron steel with an open section structure. In this case, the maximum intrusion displacement was 31.0 mm. Figure 9(c) illustrates an intrusion displacement in the longitudinal direction of a vehicle (X-displacement) versus time after a corner impact for a beam made of boron steel and having an open section structure. In this case, the maximum intrusion displacement was 9.8 mm.

As shown in Figure 9, the intrusion displacement of the boron modified beam was higher than that of the beam made of SPFC780. The improvement of this result was obtained by adding 5 stays in the designed structure of the beam. The improved design structure is shown in Figure 10.

Therefore, Figures 11(a), 11(b) and 11(c) display intrusion displacements in the longitudinal direction of a vehicle (X-displacement) versus time after frontal, offset and corner impact simulations, respectively. The Figure 11 is valid for beams made of boron steel and having open section structures with 5 stays. The maximum intrusion displacements obtained in these simulations were 21.2 mm, 28.6 mm and 9.8 mm, respectively. Compared to the results of the maximum intrusion displacement of SPFC780 impact beam with a closed section, the maximum intrusion displacement of the improved impact beam was reduced by 1% in the case of frontal impact and by 21.6% in the case of a corner impact.

Table 2 shows summarized results of the various conditions discussed above. Accordingly, as shown in Table 2, the weight of the bumper impact beam could be reduced by employing adapted boron steel and in the case in which section structure contains 5 stays, as modelled in Figure 10.

Furthermore, additional changes in the design of bumper structure with respect to distribution and allocation of bumper stays are also possible and worth considering for the future research in finding the optimum structure design; changes are shown in Figure 12.

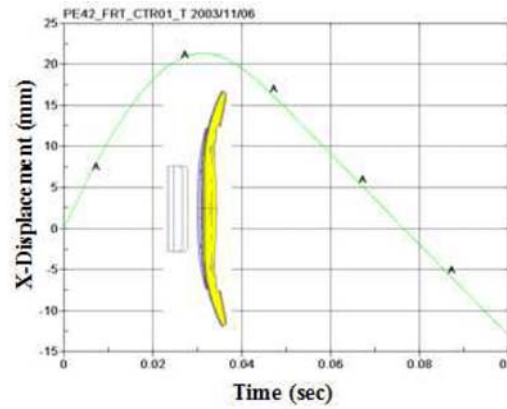
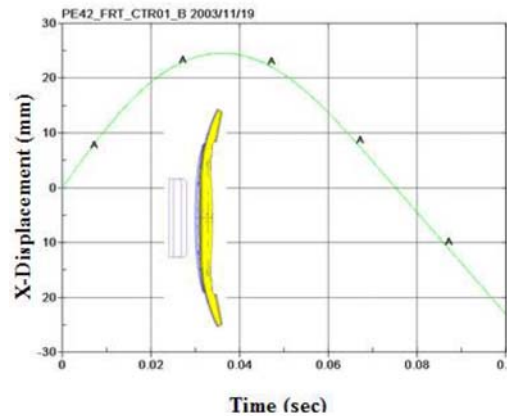
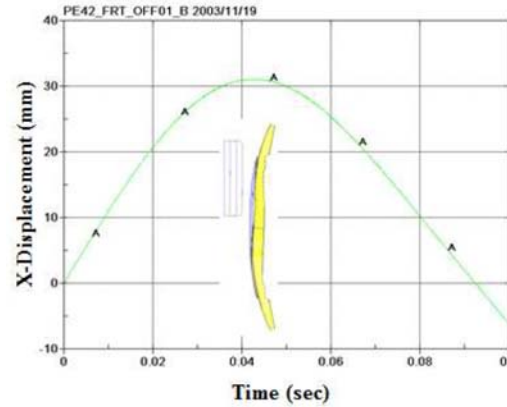

Fig. 8 Impact intrusion displacement of SPFC780 adapted beam (max.displ.: 21.3 mm)



(a) BL=0 (max.displ.: 24.6 mm)



(b) BL=300 (max.displ.: 31.0 mm)

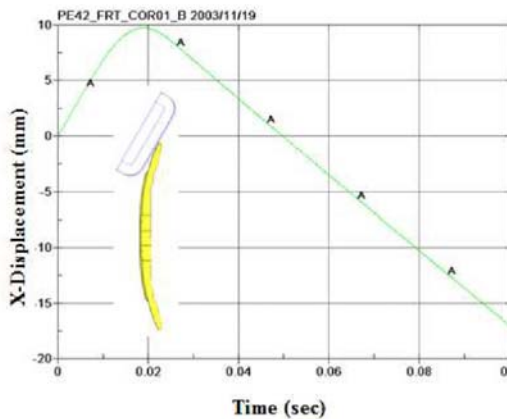

(c) Corner impact (max.displ.: 9.8 mm)

Fig. 9 Impact intrusion displacement of boron steel adapted beam

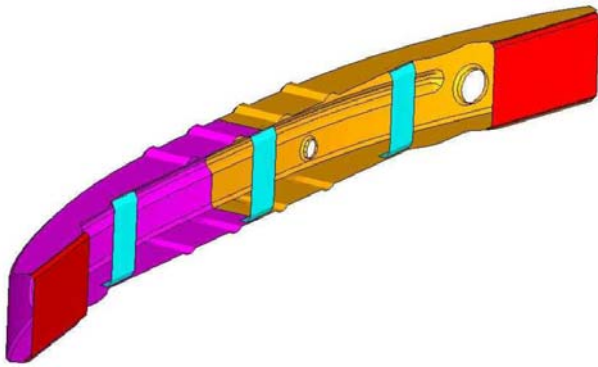
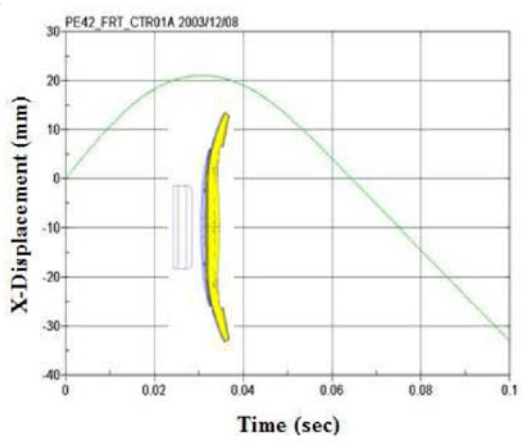
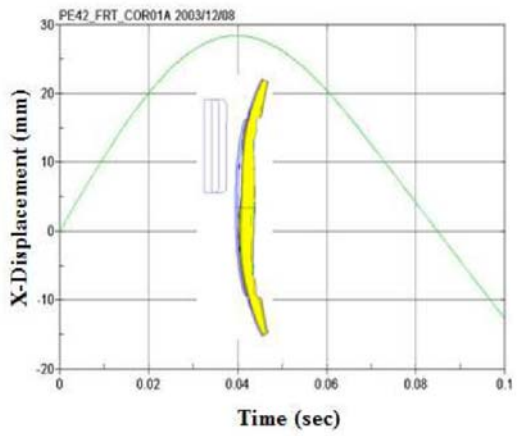

Fig. 10 Modified bumper impact beam including 5 stays



(a) BL=0 (max.displ.: 21.2 mm)



(b) BL=300 (max.displ.: 28.6 mm)

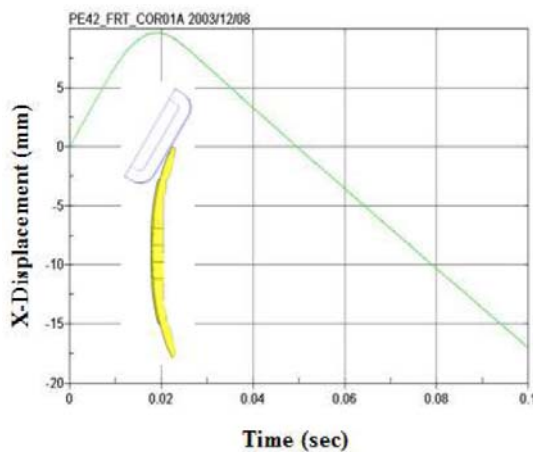

(c) Corner impact (max.displ.: 9.8 mm)

Fig. 11 Impact intrusion displacement of boron steel adapted beam containing 5 stays

Table 2(a) Summary of the results of the analysis and obtained weight values (BL = 0)

Materials (Section)	Maximum intrusion (mm)	Weight (kg)	Time (sec)
SPFC780	21.3 (100%)	6.5 (100%)	0.03
SPFC780	31.0 (146%)	4.3 (66.2%)	0.05
Boron steel	24.6 (115%)	4.3 (66.2%)	0.04
Boron steel (with 5 stays)	21.2 (99%)	4.6 (70.8%)	0.03

Table 2(b) Summary of the results indicating intrusion displacements values (mm)

Materials (Section)	BL = 0	BL = 300	Corner impact
SPFC780	21.3 (100%)	27.9 (100%)	12.5 (100%)
SPFC780	31.0 (146%)	-	-
Boron steel	24.6 (115%)	31.0 (111%)	9.8 (78.4%)
Boron steel (with 5 stays)	21.2 (99%)	28.6 (103%)	9.8 (78.4%)

4. CONCLUSION

The effect of structural variables on crash characteristics was analysed on the basis of the changes and modifications made on both structure and material seeking out the optimal solution for weight reduction. To analyse the possibility of weight reduction by substituting conventional types of steel with high-strength boron steel, the frontal, offset and corner impact crash simulations were performed. The change in design was also taken as one of the parameters in the crash simulations. The results indicate that if 5 stays are added on the impact beam made of boron steel, the maximum displacement of frontal and offset impact intrusion amounts to 21.2 mm and 28.6 mm, respectively; and these are very similar to the initial, reference values for impact beam made of SPFC780. In addition, displacement of corner impact intrusion adding 5 stays for boron steel was 9.8 mm and its bumper crash safety was improved by 21.6% with respect to that of the SPFC780 impact beam.

Finally, the results obtained make this analysis a good reference for the future advancement of bumper impact beams. It can contribute in the development of an optimal design and the reduction of bumper weight.

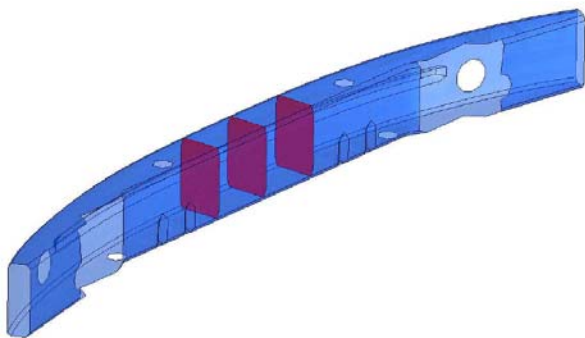

Fig. 12 Example of a structural variation in allocation of stays; a suitable ground for further studies

5. REFERENCES

- [1] S.J. Lee, J.S. Park, D.H. Koo and B.H. Jung, The development of material technology applied to bumper beam, *Transactions of KSAE*, Vol. 10, No. 4, pp. 206-215, 2002. (in Korean)
- [2] J.W. Lee, K.A. Yoon, Y.S. Kang, K.T. Park and G.J. Park, Hood and bumper structure design methodology for pedestrian regulation, *Transactions of KSAE*, Vol. 13, No. 3, pp. 162-170, 2005. (in Korean)
- [3] K.H. Lee and W.S. Joo, Optimum design of an automobile front bumper using orthogonal array, *Transactions of KSAE*, Vol. 10, No. 6, pp. 125-132, 2002. (in Korean)
- [4] J. Suh, J.-H. Lee, H.-S. Kang, K.-T. Park, J.-S. Kim, M.-Y. Lee and B.-H. Jung, Optimal processing and system manufacturing of a laser welded tube for an automobile bumper beam, *Int. J. of Automotive Technology*, Vol. 7, No. 2, pp. 209-216, 2006.
- [5] K.J. Kim, C.W. Sung, Y.N. Baik, Y.H. Lee, D.S. Bae, K.-H. Kim and S.-T. Won, Hydroforming simulation of high-strength steel cross-members in an automotive rear subframe, *Int. J. of Precision Engineering and Manufacturing*, Vol. 9, No. 3, pp. 55-58, 2008.
- [6] K.J. Kim and S.T. Won, Effect of structural variables on automotive body bumper impact beam, *Int. J. of Automotive Technology*, Vol. 9, No. 6, pp. 713-717, 2008.

6. ACKNOWLEDGEMENT

This research was supported by the Korea Science Research Program through the National Research Foundation of Korea funded by the Ministry of Education, Science and Technology (No. KOSEF 2009-0085880).

SIMULACIJA AUTOMOBILSKOG UDARA I PROJEKTIRANJE UDARNE GREDE ODBOJNIKA S CILJEM SMANJENJA TEŽINE GREDE

SAŽETAK

Poticanje energetske učinkovitosti danas predstavlja jedno od ključnih pitanja pri razvoju automobila, a redukcija težine njegovih sastavnih dijelova jedan je od važnijih ciljeva u rješavanju tog problema. Znanstvenici su stoga istraživali optimalna rješenja kojima bi se postiglo da udarna greda odbojnika bude istovremeno snažnija i laganija, a da se pritom njezino svojstvo apsorpcije energije ne smanjuje te posljedično ne umanjuje sigurnost vozila. U ovome istraživanju razmatrana je mogućnost redukcije težine udarnih greda odbojnika variranjem parametara sposobnosti apsorpcije energije pri potpuno frontalnom, djelomično-frontalnom (40% prednjeg dijela automobila) i kutnom udaru automobila u slučaju odabira drugačije vrste materijala, odnosno koristeći čelik izrazito velike čvrstoće (boron čelik vlačne čvrstoće 1.5 GPa) umjesto klasičnog čelika. Nadalje, prednosti s obzirom na vrstu strukture udarne grede odbojnika (otvorenog profila, zatvorenog profila te otvorenog profila s pet pričvršćivača) također su pomno razmotrene. Na koncu, može se tvrditi da ova analiza predstavlja dobar temelj i smjernice pri optimalnom projektiranju udarne grede odbojnika.

Ključne riječi: tijelo automobila, odbojnik, otvoreni profil, zatvoreni profil, udarna greda, reduciranje težine.