

Rapid Assessment of Fragilities for Collections of Buildings and Geostuctures

PROJECT DS-5 FINAL REPORT

Rapid Assessment of Fragilities for Collections of Buildings and Geostuctures

PROJECT DS-5

FINAL REPORT

Project Personnel:

PI: James I. Craig
Co-PIs: J. David Frost
Barry J. Goodno
GRAs: Peeranan Towashiraporn
Gaurav Chawla
Jun-Won Seo
Leonardo Dueñas-Osorio

Georgia Institute of Technology

September, 2007

TABLE OF CONTENTS

ACKNOWLEDGEMENT.....	1
ABSTRACT.....	2
CHAPTER 1 INTRODUCTION.....	4
1.1 Purpose	4
1.2 Research Objectives and Scope	5
1.3 Background.....	8
1.4 Overview.....	9
CHAPTER 2 TRADITIONAL BUILDING FRAGILITY CURVE GENERATION.....	13
2.1 Definition of Fragility	13
2.2 Fragility Curves using Actual Damage Data	14
2.3 Fragility Curves using Engineering Judgment.....	16
2.4 Fragility Curves using Analytical Approaches	18
CHAPTER 3 RESPONSE SURFACE METAMODELS IN FRAGILITY CALCULATION	29
3.1 Definition of Metamodels	29
3.2 The Response Surface Methodology	31
3.2.1 Design of Experiments.....	32
3.2.2 Response Surface Model Fitting.....	35
3.2.3 Statistical Validation of Response Surface	39
3.3 Past Applications	41
3.3.1 Applications in Aerospace System Design.....	41
3.3.2 Applications in Structural Reliability	42
3.4 Approaches for Calculating Building Fragility.....	43
3.5 Implementation of the Approaches: SDOF System.....	51
3.5.1 Description of the Structure.....	51
3.5.2 Selection of Earthquake Ground Motion Records	53
3.5.3 Approach 1.....	56
3.5.3.1 Design of Experiments.....	56
3.5.3.2 Response Surface Model Fitting.....	59
3.5.3.3 Response Simulation	62
3.5.4 Approach 2.....	64
3.5.4.1 Design of Experiments.....	64
3.5.4.2 Response Surface Model Fitting.....	66
3.5.4.3 Response Simulation	67
3.5.5 Approach 3.....	69
3.5.5.4 Design of Experiments.....	69
3.5.5.5 Response Surface Model Fitting.....	71
3.5.5.6 Response Simulation	72
3.5.6 Benchmark Case: Direct Monte Carlo Simulation	73
3.5.7 Effects from the Number of Earthquakes	77
CHAPTER 4 FRAGILITIES OF BUILDING COLLECTIONS USING 2D MODEL	79
4.1 Typical URM Structures in Mid-America	80
4.1.1 Modeling URM Buildings	82
4.1.1.1 2D Versus 3D Analyses.....	83
4.1.1.2 URM Building Components.....	83
4.1.1.3 Component-Level Modeling.....	86
4.1.1.4 DRAIN Model for a URM building	97
4.1.1.5 Building Model with Degraded Material Properties.....	99
4.1.2 Earthquake Inputs	100

4.1.3	Dynamic Analysis of a Composite Spring Model	101
4.1.4	Fragility Assessment of the URM Building.....	105
4.1.4.1	Damage Measure and Limit States	106
4.1.4.2	Uncertainties in Structural Parameters.....	107
4.1.4.3	Uncertainties in Earthquake Loadings.....	107
4.1.4.4	Response Surface Parameters	108
4.1.4.5	Design of Experiments.....	110
4.1.4.6	Response Surface Model Fitting.....	112
4.1.4.7	Statistical Validation of the Response Surface Models	114
4.1.4.8	Response Simulation	116
4.1.4.9	Evaluation of Building Fragilities.....	120
4.2	Rehabilitated URM Structures.....	122
4.2.1	Passive Energy Dissipation Concept	123
4.2.2	Metallic Hysteretic Dampers	124
4.2.2.1	Past Development	125
4.2.2.2	Structural Applications	127
4.2.3	Proposed Rehabilitation Schemes.....	129
4.2.3.1	Type 1 Rehabilitation Scheme.....	130
4.2.3.2	Type 2 Rehabilitation Scheme.....	130
4.2.3.3	Analytical Models.....	132
4.2.3.4	Hysteretic Model of Metallic Dampers	133
4.2.4	Effect of Diaphragm Stiffness	135
4.2.5	Design of the Hysteretic Devices.....	137
4.2.5.1	Design Objectives and Constraints	137
4.2.5.2	Design Variables.....	139
4.2.5.3	Design Optimization	140
4.2.6	Seismic Response of the Rehabilitated Building	145
4.2.7	Fragility Assessment.....	147
4.2.7.1	Response Surface Model Generation.....	148
4.2.7.2	Response Surface Model Validation.....	152
4.2.7.3	Response Simulation and Fragility Curves.....	154
4.2.7.4	Evaluation of Building Fragilities.....	155
4.3	Rapid Fragility Assessment of Building Portfolios Using 2D Models.....	157
4.3.1	Portfolio Fragility Assessment.....	157
4.3.1.1	Conventional Approach	157
4.3.1.2	Proposed Use of the RSM.....	158
4.3.2	Region of Interest.....	159
4.3.3	Building Parameters.....	160
4.3.4	Response Measures and Damage Criteria.....	163
4.3.5	Ground Motion and Intensity Measure	164
4.3.6	Building Model.....	165
4.3.7	Building Designs for Lateral Loads.....	166
4.3.7.1	IBC2000 Design	167
4.3.7.2	SBC1991 Design	169
4.3.7.3	Wind Load Design.....	171
4.3.8	Parameter Screening	172
4.3.9	Response Surface Model Generation.....	176
4.3.10	Hypothesized Building Portfolio	185
CHAPTER 5 FRAGILITIES OF BUILDING COLLECTIONS USING 3D MODELS ...		193
5.1	Fragility Assessment of 5-story LSMF Building Portfolio Using 3D models.....	193
5.2	System Definition	194

5.3	Screening to Identify Optimal Parameters.....	198
5.4	Design of Experiments for RSM's.....	201
5.5	Performance Measures.....	204
5.6	Rapid Seismic Response Assessment.....	206
CHAPTER 6 FRAGILITIES FOR EARTH DAMS.....		209
6.1	Inventory of Earth Dams.....	211
6.2	Numerical Modeling of Dams	216
6.2.1	FLAC Models	217
6.2.2	Model Specification.....	219
6.2.3	FLAC Response Simulation Program.....	221
6.3	Design of Experiments.....	222
6.4	Metamodel Development.....	225
6.5	Integration in Spatial Framework	227
CHAPTER 7 FRAGILITIES FOR LEVEES.....		232
7.1	Methodology.....	232
7.2	Design and Construction of Levees	234
7.3	Hazard Definition	235
7.3.1	Earthquake Hazard.....	235
7.3.2	Flood Hazard	236
7.4	Numerical Modeling of Levees	236
7.4.1	QUAKE/W and SLOPE/W Models.....	236
7.4.2	Model Specification.....	237
7.4.3	Response Simulation Program.....	239
7.4.4	Model Selection	239
7.5	Design of Experiments.....	240
7.6	Metamodels.....	241
7.7	Reliability Based Analysis.....	242
7.8	Integration in Spatial Framework	243
CHAPTER 8 SUMMARY AND CONCLUSIONS.....		246
8.1	Summary.....	246
8.2	Conclusions.....	246
APPENDIX DETAILED PROCEDURE FOR RAPID FRAGILITY ESTIMATION TECHNOLOGY IMPLEMENTATION INTO MAEviz.....		252
REFERENCES.....		257

LIST OF FIGURES

Figure 2.1: Example Fragility Curve of Limit State i	14
Figure 2.2: Latin Hypercube Sampling of Size $n = 5$ for a Normal Probability Distribution [Wyss and Jorgensen, 1998].....	22
Figure 2.3: Methods for Computing Probability Density of Responses	27
Figure 3.1: Steps for Constructing Metamodels [Simpson <i>et.al.</i> , 2001].....	31
Figure 3.2: Graphical Layout of (a) Full Factorial Design, and (b) Central Composite Design, for Three Variables	35
Figure 3.3: Process of Computing Seismic Fragility Using Metamodels	45
Figure 3.4: Graphical Layouts of the Implementation of (a) Approach 1, and (b) Approach 2	48
Figure 3.5: Graphical Layout of a Response Surface Model in Approach 3	49
Figure 3.6: Modified Fragility Computation Process for Approach 3	50
Figure 3.7: SDOF System and Hysteretic Behavior	52
Figure 3.8: Correlation Plot between Maximum Displacements from the SDOF System and Peak Ground Acceleration (PGA) of the Ground Motion Records.....	54
Figure 3.9: Correlation Plot between Maximum Displacements from the SDOF System and Spectral Acceleration (S_a) of the Ground Motion Records.....	55
Figure 3.10: Pareto Plot of Input Variables for the SDOF System	57
Figure 3.11: Response Surface of y as a function of x_1 and x_3	61
Figure 3.12: Prediction Profiler of a Response Surface Model	61
Figure 3.13: Frequency and Cumulative Frequency Plots for Maximum Displacement of a SDOF System	63
Figure 3.14: Normal Probability Distribution Fit of Maximum Displacements due to a Suite of Earthquakes at a Given Level of S_a	65
Figure 3.15: Illustration of Simulation Process in Approach 2.....	68
Figure 3.16: Cumulative Probability Density of Maximum Displacements by Approach 2	68
Figure 3.17: Cumulative Probability Density of Maximum Displacements by Approach 3	73
Figure 3.18: Comparison of Cumulative Probability Density Plots	75
Figure 3.19: Effect of Number of Acceleration Records on Cumulative Distribution of Maximum Displacements	78
Figure 4.1: Typical Low-Rise URM Building in Mid-America	81
Figure 4.2: Detailed Dimensions of the Test Structure.....	82
Figure 4.3: Four Failure Modes of URM In-Plane Walls [Yi, 2004]	85
Figure 4.4: Composite Spring Model of Wall A and Wall B.....	88
Figure 4.5: Rocking Hysteretic Behavior	95
Figure 4.6: Bed-Joint Sliding Hysteretic Behavior.....	95
Figure 4.7: Nonlinear Spring Model Representing a URM Test Structure.....	98
Figure 4.8: Prediction Profiler Plot of the Mean of Maximum Drifts	113
Figure 4.9: Prediction Profiler Plot of the Standard Deviation of Maximum Drifts.....	114
Figure 4.10: Plot of Actual Versus Predicted Maximum Drifts.....	115
Figure 4.11: Cumulative Probability Plot of Maximum Drifts Conditioning to $S_a = 0.9g$	118
Figure 4.12: Fragility Curves of a Typical URM Firehouse in Mid-America	120
Figure 4.13: Acceleration Spectrum corresponding to BSE-1 Hazard Level for a Site in Memphis	121
Figure 4.14: Acceleration Spectrum corresponding to BSE-2 Hazard Level for a Site in Memphis	122
Figure 4.15: Scaled Model of ADAS Element	126
Figure 4.16: Tapered Energy Dissipation Device	127
Figure 4.17: Hysteretic Loops for Tested Tapered Device	127

Figure 4.18: Type 1 Rehabilitation Scheme.....	131
Figure 4.19: Type 2 Rehabilitation Scheme.....	131
Figure 4.20: Simplified Composite Spring Model for the URM Test Structure.....	132
Figure 4.21: Part of the Composite Spring Model with (a) Type 1 Rehabilitation Scheme, and (b) Type 2 Rehabilitation Scheme	133
Figure 4.22: Force-Displacement Relationship with (a) Elastic-Perfectly Plastic Behavior, and (b) Elastic-Linear Strain Hardening Behavior	134
Figure 4.23: Idealized Bilinear Force-Displacement Relationship	135
Figure 4.24: Effects of Diaphragm Shear Stiffness on the Energy Dissipation Ratio Considering a Suite of Ground Motions.....	136
Figure 4.25: Effects of Diaphragm Shear Stiffness on the Diaphragm Maximum Displacement Considering a Suite of Ground Motions.....	137
Figure 4.26: Example Contour Plots of the Energy Ratio and Dynamic Ductility	141
Figure 4.27: Design Curves for the Type 1 PED Device with Ductility Demand Constraint of 10	144
Figure 4.28: Design Curves for the Type 2 PED Device with Ductility Demand Constraint of 10	145
Figure 4.29: Plot of Actual Versus Predicted Maximum Drifts for the Type 1 Rehabilitated Building.....	153
Figure 4.30: Plot of Actual Versus Predicted Maximum Drifts for the Type 2 Rehabilitated Building.....	153
Figure 4.31: Fragility Curves of a Type 1 Rehabilitated URM Firehouse in Mid-America.....	154
Figure 4.32: Fragility Curves of a Type 2 Rehabilitated URM Firehouse in Mid-America.....	155
Figure 4.33: Concept of Average Spectral Acceleration (Sam).....	165
Figure 4.34: General Building Configuration with (a) Plan View showing Moment-Resisting Frames, and (b) Elevation View of a Moment-Resisting Frame.....	166
Figure 4.35: Pareto Plot of Input Parameters.....	175
Figure 4.36: Prediction Profiler Plot.....	176
Figure 4.37: Plot of Response Surfaces with respect to Individual Input Variables.....	179
Figure 4.38: Response Surface Plots for Buildings with Non-Seismic Design	182
Figure 4.39: Response Surface Plots for Buildings with Low-Seismic Design.....	183
Figure 4.40: Response Surface Plots for Buildings with High-Seismic Design	184
Figure 4.41: Fragility Curves for Building AAA.....	188
Figure 4.42: Fragility Curves for Building BBB	189
Figure 4.43: Fragility Curves for Building CCC	189
Figure 4.44: Fragility Curves for Building DDD.....	190
Figure 4.45: Validation of the Fragility Curves by Rapid Assessment Approach.....	191
Figure 5.1: Selection of most probable 5-story LSMF structures.....	195
Figure 5.2: The most probable LSMF structure configurations.....	195
Figure 5.3: Results for 0.1g spectral acceleration.....	200
Figure 5.4: Results for 0.55g spectral acceleration.....	201
Figure 5.5: Results for 1.0g spectral acceleration.....	201
Figure 5.6: Response surface metamodels using polynomial regression function	204
Figure 5.7: Fragility curves for LSMF structures in a hypothetical portfolio.....	207
Figure 6.1: Flowchart of Analysis Methodology	211
Figure 6.2: Spatial Distribution of dams with respect to Seismic Hazard in Mid America region	214
Figure 6.3: FLAC Model Run.....	217
Figure 6.4: Commonly used DOE Techniques	223
Figure 6.5: Estimate of Settlement of the crest of the dam presented in GIS	228
Figure 6.6: Estimate of Settlement to Height ratio presented in GIS.....	229

Figure 6.7: GIS interface for querying and re-running analysis	230
Figure 6.8: New settlements computed and stored in a new column.....	231
Figure 7.1: Methodology for Multi-Hazard Response Simulation	234
Figure 7.2: Levee Design (USACE, 2000)	235
Figure 7.3: QUAKE/W levee model.....	236
Figure 7.4: Modulus degradation and Damping ratio curves (Geo-Slope, 2004a)	238
Figure 7.5: Probability Distribution Functions of RS FoS and LS FoS using MCS.....	243
Figure 7.6: Integration in Spatial Framework.....	244
Figure A.1: The flow chart of defining RSM's function in a program	255
Figure A.2: The flow chart of creating fragility curves in a program.....	256

LIST OF TABLES

Table 3.1: Number of Experimental Samples for Different DOEs.....	35
Table 3.2: Structural Properties and Probabilistic Characteristics.....	53
Table 3.3: Input Variables for Response Surface Metamodels.....	57
Table 3.4: DOE Table for SDOF Systems Subjected to m02_10s Accelerogram.....	59
Table 3.5: DOE Table for SDOF Systems subjected to a Suite of Accelerograms.....	65
Table 3.6: Input Variables for a Response Surface in Approach 3.....	70
Table 3.7: Design of Experiments Table for Approach 3.....	71
Table 3.8: Comparison of Number of Analysis Required by Different Approaches.....	77
Table 4.1: Basic Material Properties for the URM Test Structure.....	81
Table 4.2: Elastic Properties and Strength of Wall Components in Wall A and Wall B.....	94
Table 4.3: Properties of the Out-of-Plane Wall 1 and Wall 2.....	96
Table 4.4: Comparisons between Results from DRAIN-2DX and ABAQUS Models.....	99
Table 4.5: Degraded Masonry Properties.....	100
Table 4.6: Maximum Displacements at Various Locations of the URM Structure under BSE-1 Ground Motions.....	101
Table 4.7: Maximum Displacements at Various Locations of the URM Structure under BSE-2 Ground Motions.....	102
Table 4.8: Structural Performance Levels for URM Structures [FEMA, 2000a].....	103
Table 4.9: Computed Maximum Inter-Story Drifts due to a Suite of Ground Motions.....	104
Table 4.10: Structural Uncertainties for URM Structures.....	107
Table 4.11: Input Variables for a Response Surface Model.....	110
Table 4.12: Design of Experiments Table of Input and Output Variables.....	111
Table 4.13: Conditional Probabilities of Exceedance for the URM Building.....	119
Table 4.14: Memphis Synthetic Ground motions and their Intensity Measures.....	143
Table 4.15: Comparison of the Computed Maximum Inter-Story Drifts for Existing and Type 1 Rehabilitated URM Buildings.....	146
Table 4.16: Comparison of the Computed Maximum Inter-Story Drifts for Existing and Type 2 Rehabilitated URM Buildings.....	147
Table 4.17: Design of Experiments Table for the Type 1 Rehabilitated Building.....	149
Table 4.18: Design of Experiments Table for the Type 2 Rehabilitated Building.....	150
Table 4.19: Computed Measures of Modeling Error.....	153
Table 4.20: Potential Building Parameters for Response Surface Model Generation.....	163
Table 4.21: Structural Performance Levels for Steel Moment Frames [FEMA, 2000a].....	164
Table 4.22: Beam and Column Sections for a Building Designed with IBC2000.....	169
Table 4.23: Beam and Column Sections for a Building Designed with SBC1991.....	171
Table 4.24: Beam and Column Sections for a Building Designed to the Non-Seismic Code Level	172
Table 4.25: Design of Experiments Table based on the 2-Level Fractional Factorial Design for 11 Input Variables.....	175
Table 4.26: Screened Input Parameters for Response Surface Models.....	177
Table 4.27: Input Parameters for Response Surface Models including the Seismic Design Level Parameter.....	180
Table 4.28: Characteristics of Buildings from the Hypothesized Portfolio.....	186
Table 5.1: Number and position of respondents who completed the survey.....	194
Table 5.2: Number of people selecting different configurations of LSMF structure.....	195
Table 5.3: Potential parameters of 5-story LSMF structures.....	196
Table 5.4: 5-story LSMF structure designs (Ec. : 2.75m).....	197

Table 5.5: Design matrix and response data from nonlinear time-history simulation	198
Table 5.6: Screened input parameters for RSM.....	202
Table 5.7: Design matrix and response data for RSM	203
Table 5.8: Characteristics of eight LSMF structures in a hypothetical portfolio; the presence of * in a field indicates that it is defined as a random parameter.....	206
Table 6.1: Spatial Distribution of Dams in Mid America Region	215
Table 6.2: Soil Parameters for FLAC Numerical Modeling.....	220
Table 6.3: Three metamodel factors for Design of Experiments	223
Table 6.4: Design of Experiments Table	224
Table 7.1: Set of Soil Parameters.....	238
Table 7.2: Three Levels for the Seven Factor DOE.....	241

ACKNOWLEDGEMENT

This research was supported by the Mid-America Earthquake Center under National Science Foundation Grant EEC-9701785.

ABSTRACT

This report describes the results of research to develop a way to rapidly assess the fragility of structures and geostuctures over a specified region. Structural performance under future earthquakes cannot be predicted with certainty. This is primarily due to the fact that an earthquake is a random phenomenon in nature, but another source of uncertainty comes from the structures themselves. For an individual structure or geostucture, the uncertainty arises largely from material properties and construction methods, but for a collection of structures whose individual characteristics are not known, additional uncertainty arises from macro-level parameters such as structural type, base planform, orientation, as well as vertical and planform irregularities, and the applicable design codes. Since detailed analysis of each structure or geostucture in the collection is impractical, this report addresses the problem by developing a methodology based on the use of computationally efficient metamodels to represent the overall structural behavior of the collection. In particular, response surface metamodels are developed using a Design of Experiments approach to select the most influential parameters. Monte Carlo simulation is carried out using probability distributions for the parameters that are characteristic of the target collection of structures or geostuctures, and the fragility of the collection is estimated from the computed responses.

The report presents the development of the basic methodology and then follows with a discussion of several applications that are relevant to structures in Mid America. These include a single building (an unreinforced masonry firehouse typical of an essential facility) as a reference case, and the effect of seismic rehabilitation on the computed fragility is also investigated. The method is next applied to a class of lowrise steel moment frame structures using a 2D structural model only, and the fragilities of a collection of such structures is estimated. This is followed by an extension involving the use of 3D structural models for a class of lowrise L-shaped steel

PROJECT DS-5 FINAL REPORT

moment frame structures. Finally, the methodology is applied to two important classes of geostructures that are common to Mid America: (1) earthen and rockfill dams, and (2) levees.

The report also discusses how the proposed methodology might be incorporated into advanced GIS-based risk assessment and management software systems for practical applications.

CHAPTER 1 INTRODUCTION

1.1 Purpose

In general, the response of a structure (*e.g.*, a building structure, a geostructure, *etc.*) is influenced by (a) the loads acting on the structure, (b) the geometry of the structure, and (c) the strength of materials used in its construction. Deterministic responses are calculated from the designed or expected values of loading and structural parameters. However, sources of uncertainty exist in all aspects mentioned above, and actual values may deviate from their mean values. For structural responses due to seismic events, it is well known that the most uncertain aspect is the loading itself [Galambos *et.al.*, 1982]. Characteristics of future earthquakes cannot be predicted with certainty. Moreover, structural geometry can differ from initial design due to construction practice which can vary from one structure to another, and more importantly, is very difficult to quantify. Properties of the construction materials also possess uncertainties due to manufacturing processes or inherent unpredictability within the materials themselves. Another source of uncertainty, and probably the most overlooked, comes from modeling error or prediction accuracy of the structural models. Computational models cannot precisely replicate physical structures in real situations. However, this type of uncertainty is epistemic and can be reduced with better knowledge of real structures, more refined analysis models, and calibration based on experimental studies.

Deterministic seismic response analysis only provides values of structural response from specific seismic events and may be misleading in some cases. On the other hand, probabilistic seismic response computation takes into account uncertainties arising from both seismic loading and structural aspects.

Structural seismic fragility is a common measure of damage likelihood due to random ground motions. Fragility relationships are usually expressed in terms of a damage probability

matrix [ATC, 1985] or in terms of fragility curves. Seismic fragility, by definition, is the probability of damage exceeding a certain limit state condition at a given seismic intensity level. Probabilistic descriptions of response or damage are required for computing exceedance probabilities. When analytical solutions for the probabilities are not readily available, conventional methods use the Monte Carlo technique to estimate the probability distribution of outcomes. The basic Monte Carlo technique is conceptually straightforward, as it generates artificial random samples from the distribution of inputs and for a given set of inputs computes the output. However, the Monte Carlo technique usually requires a relatively large number of such computations in order to obtain a sufficiently reliable estimate of the output probability distribution. When the structural model involves detailed computation of response time-histories, it quickly becomes impractical to carry out the required thousands of structural analyses to formulate the probabilistic characteristics of the seismic responses.

This report proposes an efficient means for predicting structural seismic responses in a simplified manner. It significantly reduces the computational cost required in the Monte Carlo simulation, and this allows the incorporation of uncertainty in more inputs to the structural model, including in particular, uncertainty in both micro- as well as the macro-parameters of the structures.

1.2 Research Objectives and Scope

The primary goal of this report is to present a new approach utilizing metamodels to calculate seismic fragility. The metamodels associate a dependent variable or output with the independent input parameters in a function-like manner. The approach incorporates uncertainties in seismic loadings as well as structural parameters. The particular metamodel used in this work is a multivariate polynomial function, also known as a response surface function, and it is employed in a process for prediction of selected seismic responses and damage. Conventional

PROJECT DS-5 FINAL REPORT

Monte Carlo simulation is carried out using the response surface models to obtain damage probability distributions, and consequently, fragility of buildings and geostructures.

Computational costs required in a Monte Carlo simulation are significantly reduced since the simulation is performed on a polynomial response surface function, rather than on a highly complex structural dynamic model. The incorporation of a metamodel allows the Monte Carlo simulation to be expanded to include a broader range of uncertainties in the inputs, and more specifically it allows inclusion of both micro-parameters (*i.e.*, material strength, material stiffness, damping, *etc.*) as well as macro-parameters such as overall dimensions, base shapes, cross-section shapes, building story heights, *etc.* As a result, it is possible to apply the methodology to the estimation of fragilities for a collection of structures based on the assumed distributions of the micro- and macro-parameters as well as on the hazard itself.

The proposed approach is implemented for five different cases: (1) fragility calculations for a specific structure, (2) preliminary rapid fragility assessment of building portfolios using 2D structural models, (3) rapid fragility assessment of building portfolios using 3D structural models, (4) through seismic response of earth and rockfill dams, and (5) through the seismic response of levees.

In the first case, a single unreinforced masonry building typical of firehouse construction in Mid-America is considered. Uncertainties that exist in material properties are included in the model. Uncertainties from seismic loadings are captured by applying ground motions with a wide variety of hazard characteristics to the building. An ideal solution is to use a sufficiently large set of records of actual earthquakes. However, in Mid-America, historical records of major seismic activities are scarce. As a result, Wen and Wu [2001] developed a suite of synthetic ground motions appropriate for three cities in Mid-America. Rix [2003] refined the methodology and used detailed local soil data to develop another set of synthetic ground motions. However, since the work presented in this report spans the development of these sets of ground motions, the

PROJECT DS-5 FINAL REPORT

Wen and Wu suite is used for some of the cases while the Rix suite is employed for other cases (as will be noted later).

In the first case, the methodology is applied to estimating the fragility of a single structure, and for this case, the range of macro-parameters considered is very limited. Also, even though response due to an earthquake is dependent on the direction of ground motion input, only a two-dimensional weak axis response of the building is considered in this report. The use of metamodels in computing seismic fragilities is presented for both an existing and a rehabilitated firehouse. Performance of different rehabilitation schemes is evaluated through the resulting fragility curves.

In the second case, the benefits from using metamodels to perform rapid fragility assessments of a building portfolio become more appealing. Conventional loss estimation packages use generic fragility curves typical of different building classifications to quantify probable damage. However, buildings in the same classification may have widely different fragility relations due to variability in 2D macro-parameters such as the vertical geometry or other building aspects. This could lead to an inaccurate estimation of building portfolio losses. The methodology proposed in this report provides an efficient means for rapidly deriving fragility relations specific to a given portfolio. This aspect is of interest to governmental agencies or building owners who are responsible in planning for proper mitigation measures for their building portfolios.

In the third case, the rapid assessment methodology is extended to incorporate 3D models for structural response of buildings in order to more accurately represent the behavior of buildings with irregular planform geometries. In particular, as an representative example of irregular buildings, a collection of five-story L-shaped moment-resisting frame structures with variable first story height and structural eccentricity are studied. The process is used to estimate building

portfolio losses for L-shaped buildings and the results are consistent with the 2D methodology developed in the second case.

In the fourth case, this study focuses on development of a methodology with which the seismic response of a large number of dams can be efficiently computed and viewed in a spatial framework. Clearly, this task cannot be accomplished if each dam were to be analyzed for different earthquake scenarios, different material properties and different retained water levels. Instead, a metamodel-based approach was adopted to efficiently simulate the seismic response of all the dams in the region of interest.

Lastly, this study focuses on development of a metamodel-based approach to compute the multi-hazard response of a levee system. As in the previous cases, the methodology relies on a Design of Experiments approach, wherein only a few representative levee models are systematically selected. These few levee models are then analyzed and the results are used for damage prediction of all possible levee and hazard conditions using multivariate polynomial regression equations.

1.3 Background

Approximation methods are an efficient tool for carrying out engineering analyses of complex models leading to fewer calculations while retaining accuracy of results. Despite the steady growth of computing power and speed, the complexity of these analyses often keeps pace with developing computing technologies. For such engineering problems, approximation methods offer a viable alternative to more intensive and time consuming engineering analyses. The most popular technique for creating structural metamodels at present is the response surface approach which typically employs second-order polynomial models based on least squares regression techniques. The origin of the response surface metamodel (RSM) can be traced back to the work of researchers in the early 1930's when RSM's were developed to determine the

optimal conditions in chemical processes. Since then, RSM's have been successfully applied in many different fields of study such as chemical, industrial, manufacturing, aerospace engineering design and structural reliability. A contemporary description of the methodology is provided in [Myers and Montgomery, 2002]. The first applications of RSM's in structural engineering were to structural reliability problems [Faravelli 1989]. Recently, RSM's developed for structural reliability problems have been compared with the kriging method as an alternative approximation method to RSM's, and results of the two approaches are compared in [Irfan 2005].

As another application of response surface metamodels in structural fields, response surface metamodels were used for rapid seismic loss estimation of a population of steel moment frame structures in civil engineering [Towashiraporn, 2004]. This work is the doctoral thesis of one of the co-authors of the present report (and much of the work is incorporated in this report). Seismic fragility analysis of RC structures have been carried out using RSMs in conjunction with First Order Reliability Method (FORM) analysis, with the constructed empirical limit-state function as input [Franchin *et.al.* 2003]. The fragility curves derived for a population of low-rise infilled RC structures of inadequate seismic design have been developed using a methodology in connection with RSMs for the derivation of fragility curves using analytical damage statistics [Rossetto and Elanshai 2004].

1.4 Overview

This report summarizes research carried out over a period of several years under project DS-5 funded by the Mid America Earthquake Center. The project objective was to develop a methodology for rapid assessment of structural fragilities over a region, and the focus was on three broad categories of structures typically found in the Mid-America region: buildings, earthen dams, and levees. The research was carried out in two coordinated tasks, one directed at buildings and the other at geostructures, and both tasks shared the development of a common

RSM methodology. As a result, this report is organized into two major sections, one dealing with the development of the RSM methodology and its application to buildings and the other dealing with geostuctures. The following is an overview of the general contents of the chapters.

CHAPTER 2: Traditional Fragility Curve Generation. The second chapter introduces the concept of fragility curves for displaying the likelihood of building or geostructure damage due to random seismic events. This chapter also explains conventional ways of generating fragility curves, including fragility curves developed using expert opinion, empirical fragility curves, and analytical fragility curves. Examples from past developments are given in detail in this chapter. Focus is placed on the analytical development of fragility curves, which will be used as part of the proposed methodology presented in this thesis.

CHAPTER 3: Response Surface Metamodels in Fragility Calculation. Chapter 3 begins with introduction to the concept of a metamodel, its definition, and history. Examples of different metamodels are mentioned. The Response Surface Methodology (RSM) [Myers and Montgomery, 2002] is one of the most widely-used approaches, and well-proven metamodels have been developed for many engineering applications [Simpson *et.al.*, 2001]. Metamodels based on response surfaces statistically approximate desired responses in the form of polynomial functions of random predictor variables. The Design of Experiments (DOE) technique provides the locations of these data points [Montgomery, 1997]. History and past applications of RSM are also presented in this chapter. RSM has been implemented in the preliminary design process for aircraft in the field of aerospace engineering systems design. Response surfaces relate aircraft performance measures to their configuration parameters. Appropriate design configurations can then be obtained from optimization analysis of the response surfaces. Another application of RSM is in the area of structural reliability, which is more closely related to civil engineering problems. Response surfaces are commonly used to approximate limit state functions which cannot always be explicitly represented in closed-form solutions.

CHAPTER 4: Fragilities of Building Collections Using 2D Models. This chapter presents a proof-of-concept application in a fragility investigation of an essential facility, in this case a typical firehouse, in Mid-America. A 2-story URM model building ([Yi *et.al.*, 2002] and [Yi, 2004]) was chosen as representative of firehouses in the region. The RSM approach developed in Chapter 3 is then applied using a 2D structural model to estimate the fragility for such firehouses. After investigating fragilities of a collection of URM firehouse structures, rehabilitation plans for reducing the vulnerability of URM firehouses using passive metallic damping devices are described. Finally, the RSM approach is extended to estimating the fragility of a collection of lowrise steel moment frame buildings using 2D structural models to represent the performance. The extension of the methodology as part of a portfolio loss assessment is also discussed.

CHAPTER 5: Fragilities for Building Collections Using 3D Models. This chapter extends the development in chapter 4 that is based on 2D structural models to 3D models. More specifically, fragilities for the specific class of 3D L-shaped steel moment resisting frame (LSMF) are developed using the proposed RSM methodology. Statistically significant predictors for rapid seismic fragility assessment are identified by using Design of Experiments (DOE) and statistical tools. The resulting metamodels are used to estimate fragilities for LSMF structures in a regional portfolio of buildings.

CHAPTER 6: Fragilities for Earth Dams. Chapter 6 extends the basic RSM approach and presents a comprehensive methodology for regional seismic response simulation of earth dams in an earthquake vulnerable region. The methodology also allows the effect of inherent uncertainties in factors such as dam construction and seismic hazard on the seismic response of the dam to be incorporated.

CHAPTER 7: Fragilities for Levees. This chapter presents a methodology for a combined flood and earthquake response simulation of levees. The methodology also incorporates the

PROJECT DS-5 FINAL REPORT

effect of inherent uncertainties in factors such as levee construction and design as well as flood and earthquake hazard on the response of the levee.

CHAPTER 8: Summary and Conclusions. This chapter summarizes the two major tasks (seismic fragility estimation for buildings and geostructures in a region) that comprise the DS-5 project and discusses their potential impacts. Recommendations for future research are also discussed in this chapter.

CHAPTER 2

TRADITIONAL BUILDING FRAGILITY CURVE GENERATION

Conventional building response analyses use deterministic approaches in which loadings and structural characteristics are based on the best estimates or expected values from field data and experimental results. However, seismic loadings are clearly nondeterministic. Moreover, resistance of building structures also exhibits stochastic characteristics arising from uncertainties in construction processes, physical properties and modeling abstraction. As a result, a purely deterministic description of structural responses to earthquakes can be misleading in some cases. Probabilistic seismic response analysis takes into account uncertainties in both seismic loading and structural characteristics. Building seismic fragility is commonly used in this matter as a measure of potential damage in a building.

2.1 Definition of Fragility

Building seismic fragility describes the likelihood of damage due to random ground motions. The seismic fragility of a structure is mathematically defined as the probability of failure of the structure conditional on specific ground motion intensity. Let I_j be a specific value of the hazard intensity at the j^{th} level. Let D be the load effect due to this random event on the global response of the structure. Let C_i be the random structural capacity to withstand this load effect corresponding to the i^{th} limit state. Accordingly, the building seismic fragility is calculated as:

$$PF_{ij} = \text{Pr ob} \left[D \geq C_i \mid I_j \right] \quad (2.1)$$

where PF_{ij} denotes the probability of failure with respect to the i^{th} limit state at the j^{th} hazard intensity level. The fragility curve for a limit state i can be constructed by evaluating PF_{ij} at

different levels of hazard intensity (j). Graphical representation of an example fragility curve for limit state i is shown in Figure 2.1

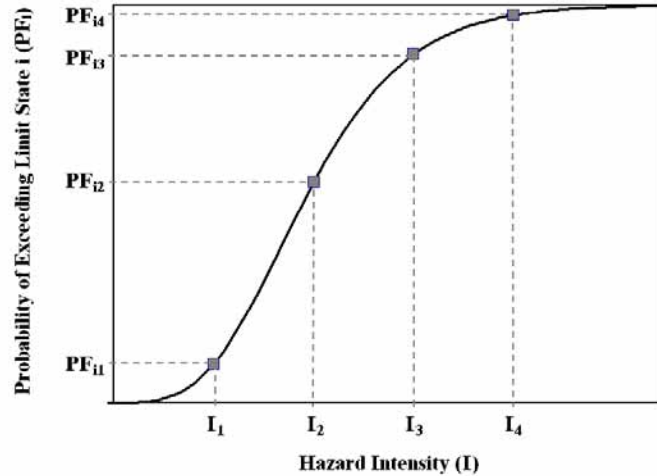

Figure 2.1: Example Fragility Curve for Limit State i

Generally, fragility curves can be generated using (1) actual earthquake damage data, (2) engineering judgment, and (3) analytical methods. These approaches will be summarized in the following sections.

2.2 Fragility Curves using Actual Damage Data

This approach is based primarily on actual damage data obtained from field investigations after an earthquake or from experiments to generate fragility curves. This kind of fragility curve is essentially close to exact results because it is derived directly from real structures and real earthquakes. However, the quality is still limited by the limited numbers of sampled structures that can be examined.

This type of fragility curve is useful in characterizing the seismic performance of a collection of similar structures in an earthquake-prone area. Earthquake intensity data at each structure site and corresponding damage to the structure are collected following an earthquake. The raw data is then statistically processed to generate fragility curves. This process usually

requires a large amount of data in order for reliable estimates of fragility. This empirical fragility curves are often used to calibrate the fragility curves developed analytically. Past development of empirical fragility curves are listed as follows.

Yamazaki *et.al.* [1999] constructed a series of fragility curves for expressway bridges in Japan based on actual damage data from the 1995 Hyogoken-Nanbu (Kobe) earthquake. Damage data from 216 expressway bridges throughout Japan were collected after an earthquake. Five damage ranks from collapse to no damage were assigned to all bridges. Earthquake intensities values, which are peak ground acceleration (PGA) values, at some bridge locations were measured by the accelerometers during the earthquake. Earthquake intensities at other non-instrumented bridges were estimated based on available records. Based on these damage-intensity data, fragility curves for the expressway bridges were constructed assuming a lognormal distribution for the cumulative probability of damage. Results from this study were used in planning for appropriate traffic control immediately after earthquakes.

A similar approach was proposed by Shinozuka *et.al.* [2000b] for developing empirical fragility curves for the Hanshin Expressway Public Corporation's (HEPC's) bridge columns in Japan. Records of the damage resulting from the 1995 Kobe earthquake were used as a basis for generating fragility curves. The states of damage and PGA values from a sample of 770 singly supported reinforced concrete columns were considered. It was also assumed that the fragility curves could be represented by a two-parameter lognormal distribution. Contrary to the work done by Yamazaki et al [1999], which used the method of least squares, the maximum likelihood method was employed to estimate the lognormal distribution parameters.

O'Rourke and So [1999, 2000] presented a method for developing empirical fragility curves for on-grade steel liquid storage tanks. The fragility curves are based on the seismic damage records of over 400 tanks in 9 earthquake events. One of the 5 damage states and corresponding peak ground acceleration (PGA) were given to each tank. The seismic fragility

relations were built using logistic regression analysis. The fragility relations developed in this study were then compared with the corresponding relations available in HAZUS and ATC studies. It was found that actual tanks performed better than that calculated in the existing approaches.

From a comprehensive database of bridge damage for the Northridge and Loma Prieta earthquakes, Basöz and Kiremidjian [1999] generated fragility curves to quantify bridge seismic fragilities. The bridge damage descriptions were obtained from bridge damage reports compiled by the California Department of Transportation (CalTrans). A four-level damage measure (minor, moderate, major, and collapse) was used to describe bridge damage. Earthquake intensity levels at the bridge sites were either recorded by USGS or simulated through a scenario event. Similar to the O'Rourke and So [1999, 2000] approach, a logistic regression analysis was utilized to describe a relationship between the conditional probability and the earthquake intensity, which was taken as the PGA in this study.

Fragility curves derived from actual damage data provides valuable perception of potential impact from future earthquakes. However, damage data obtained from the field needs to constitute a statistically large sample size. Scarcity of data may lead to unreliable prediction of seismic fragilities.

2.3 Fragility Curves using Engineering Judgment

When the required actual earthquake damage and building inventory data are not available, one can develop such data from the experience and judgment of earthquake engineering experts. These data are then processed statistically for earthquake damage estimates of the region. One of the best-known methodologies for generating fragility curves based on engineering judgment is from ATC-13 [ATC, 1985]. This project summarized damage probability matrices (DPM) for families of structures with similar structural types. Damage probability matrices describe the discrete probabilities of damage in different damage states at various levels of

PROJECT DS-5 FINAL REPORT

ground shaking. It is comparable and can easily be converted to fragility curves. Using ATC-13, the structures in California were classified into 78 classes based on size, structural system, and type. Modified Mercalli Intensity (MMI) was selected as an earthquake intensity level in this study. The three-round questionnaire process was carried out involving 71 senior-level specialists in earthquake engineering to obtain damage information for each structure. Damage was expressed in terms of damage factors. The damage data obtained from the questionnaires were tested using Beta, Normal, and Lognormal probability distribution functions. It was found from the results that the Beta distribution fitted the data uniformly and better than the other distributions. The Beta distribution was then used to describe probabilistic damage and to create damage probability matrices (DPM) for all 78 classes of structures. A damage probability matrix is equivalent to the fragility curve in the sense that both represent a probability of exceeding a specific damage state conditioning on a ground motion intensity level, which is MMI in this study.

Several improvements to the ATC-13 approach have been made by Anagnos *et.al.* [1995]. Two major changes related to a new building classification and fragility formulations for those classes based on the damage probability matrices in ATC-13. ATC-13 categorized building structures into 40 different classes. Anagnos *et.al.* [1995] reduced the number of building classes to 17, considering only framing types and structural materials used. Fragility curves, which could be transformed from ATC-13 damage probability matrices, were then created for each building class. Analogous to ATC-13, the damage factor was used to describe the damage states in this study. For each building class and MMI level, integrations were performed on the Beta probability distributions from ATC-13 to calculate probabilities of exceeding a particular damage state or fragilities. Repetition of the process over different MMI levels yielded a set of fragility data points. Lognormal curves were assumed and fitted through the resulting points using least-square error techniques. Comparison of these curves suggested a possible consolidation of building classes when the curves are sufficiently close.

2.4 Fragility Curves using Analytical Approaches

An analytical approach for generating fragility curves is implemented when the actual earthquake damage data are limited and cannot provide sufficient statistical information.

Analytical fragility curves are developed from seismic response analysis of structures. This methodology is often applicable in regions with infrequent seismic activities, such as in central and eastern United States. An analytical approach is the basis for developing fragility curves in this study as its applications are focused in the Mid-America region. In general, analytical fragility curves can be constructed following these procedures.

- The first step is to identify an appropriate seismic intensity parameter. Seismic hazard intensity is commonly measured by the peak values from the ground motion time history, including peak ground acceleration (PGA), peak ground velocity (PGV), or peak ground displacement (PGD). The use of spectral values as a seismic intensity measure is also common in fragility calculations. Spectral acceleration (S_a) and spectral displacement (S_d) are the two measures regularly used for fragility curves. There are advantages and disadvantages of using the two types of intensity measures. The use of peak values is simple since they can readily be obtained from the records. However, peak ground motion parameters may provide poor correlation with structural responses. On the other hand, spectral parameter is a direct measure of the demand of the excitation on structural responses. The drawback of the use of spectral values is that it is structure-dependent.
- Uncertainties from the earthquakes are implicitly incorporated in the analysis by the use of an ensemble of ground acceleration records with a wide variety of seismic hazards. Both actual and synthesized records can be used in this matter. Ground motion records in an ensemble are scaled such that they have the same level of seismic intensity.
- Uncertainties that are inherited in a structural aspect must be considered. The source of this aleatory uncertainty comes from randomness in construction material properties.

PROJECT DS-5 FINAL REPORT

Probabilistic density functions of each random parameter can be obtained from existing experimental results or field surveys.

- A response measure that best describes damage from seismic loadings is selected. Damage limit states corresponding to the selected damage measure must also be identified. Parameters such as base shear, maximum roof displacement, peak inter-story drift, damage indices, ductility ratio, and energy dissipation capacity can be used to identify the damage states depending on the types of structure being investigated.
- Appropriate computational structural models are established for determining seismic responses. Structural uncertainties (*i.e.*, material properties) must be included in these models as well.
- A statistical approach is employed to formulate a large number of seismic response analyses on the models with stochastic properties subjected to an ensemble of ground motions scaled to a specific intensity level.
- Damage probabilities are calculated from the computed seismic responses. These probability values are conditioned on a specific intensity level. Repetition of the process over all intensity levels results in a series of probabilities of exceeding limit states at various intensity levels or fragility curves.

The most direct means of statistical analysis to obtain probabilistic description of response is through Monte Carlo simulation [Kleijnen, 1974]. The basic (*i.e.*, naive) Monte Carlo technique is a brute-force simulation technique which randomly generates values for uncertain input variables to simulate scenarios of a problem. These values are taken from within a fixed range and selected to fit a probability distribution (*e.g.*, uniform distribution, normal distribution, lognormal distribution, *etc.*). In basic Monte Carlo simulation, the random selection process is repeated many times to create multiple scenarios. In the basic or naïve approach the

PROJECT DS-5 FINAL REPORT

samples are selected randomly, but the number of simulations can be reduced if more efficient sampling of the input distributions is employed. Each time a value is randomly selected, it forms one possible scenario and the outcome to the problem is then evaluated. Together, these scenarios give a range or probability distribution of possible outcomes. In the case of seismic response analysis, structural uncertainty parameters (*e.g.*, material, structural and geometric properties) and seismic inputs are randomly selected, based on their probability distributions, to form many structure-earthquake combinations. Seismic analysis performed on each combination yields a seismic response of interest (*e.g.*, peak drift, damage indices, *etc.*) When the selection process is repeatedly carried out for hundreds or thousands of times, probabilistic descriptions of seismic response can be formulated. Probabilities of response exceeding certain values can be obtained.

Mosalam *et.al.* [1997] made use of the Monte Carlo simulation technique on the seismic fragility analysis of the unreinforced masonry infilled frames. Five random parameters from the pushover curve were assumed to follow lognormal distribution. A total of 600 synthetic ground motions were considered in this study. For each earthquake record, 200 building samples were generated from the Monte Carlo simulation. Seismic analyses were performed on those building samples to calculate inter-story drift responses. The probabilities of exceeding specific inter-story drift limit states were computed based on the results of 200 runs. The process recurred for all ground acceleration records yielding 600 probability values for each limit state. The fragility curves were plotted by fitting these exceedance probability data points to appropriate regression models.

The advantage of the Monte Carlo technique is that it calculates probabilities from the outcomes of the simulated scenarios regardless of a specific probability distribution of the outcomes. However, it requires a relatively large number of simulations in order to obtain a sufficiently reliable estimate for probability of damage. Mann *et.al.* [1974] suggested that the number of simulations might need to be of the order of 10,000 to 20,000 for approximately 95%

confidence limit, depending on the function being evaluated. It will be computationally impractical, if not impossible, to simulate thousands or even hundreds of nonlinear time-history analyses.

Sampling techniques have been proposed, as an alternative to Monte Carlo simulation, in selecting random input variables. The Latin Hypercube sampling technique [McKay *et.al.*, 1979] is a one of a number of efficient sampling techniques which ensures that the entire range of input variables is sampled. For small samples, the method provides unbiased point estimates (*e.g.* mean values or probabilities of exceeding certain values) with relatively small sampling error in comparison to many other Monte Carlo methods. Latin hypercube sampling selects n different values from each input variables in the following manner. The probability distribution of each input variable is divided into n intervals of equal probability (shown in Figure 2.2). The n values obtained for each input variable are combined in a random manner with the values of other variables to form n random combinations of input variables. Evaluation of output or response from each combination of variables yields n values of response. The n responses are fitted to the appropriate probability density function. The probability of exceeding certain values of response can then be calculated based on the fitted distribution.

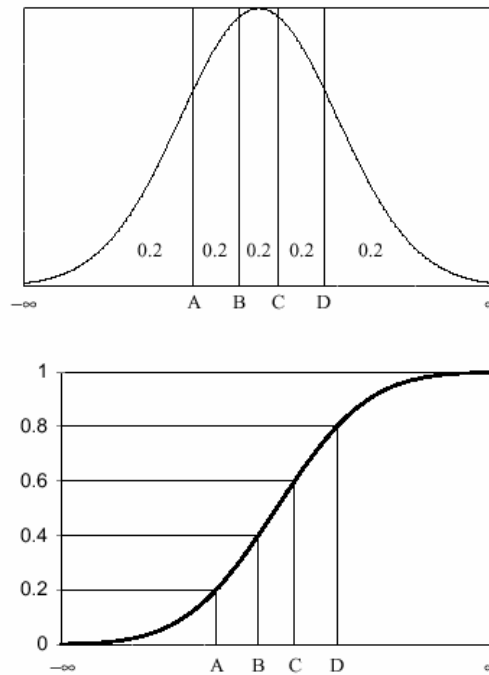

Figure 2.2: Latin Hypercube Sampling of Size $n = 5$ for a Normal Probability Distribution [Wyss and Jorgensen, 1998]

A number of researchers have suggested several analytical approaches using the Latin Hypercube technique for assessing fragilities of the structures as shown in the subsequent paragraphs.

Hwang and Huo [1994a, 1994b] proposed an analytical method for establishing fragility curves and a damage probability matrix of a five-story reinforced concrete frame building. Synthetic ground motions were generated from probability-based scenario earthquakes. Peak ground acceleration (PGA) ranging from 0.05g to 0.5g was used as a ground shaking parameter. For each PGA level, fifty earthquake acceleration time histories were generated. Five damage states of the building, which varied from nonstructural damage to collapse, were categorized using the building damage index. Structural uncertainties taken into account in this study were the viscous damping ratio, strength, and elastic modulus of construction materials. For each random structural parameter, 50 samples were randomly generated within two standard deviations

PROJECT DS-5 FINAL REPORT

around the means. These samples were then combined using the Latin Hypercube sampling technique to assemble 50 structural models. These structural models obtained from the sampling process were then paired with 50 samples of ground acceleration records to create 50 samples of earthquake-site-structure systems in each PGA level. A nonlinear time-history analysis was carried out on each sample to determine the building damage index. At the end, 50 values of damage index were obtained in each PGA level. A probability distribution of the building damage index was assumed to follow a lognormal probability function. Regression analysis was performed to determine the lognormal distribution parameters. Conditioning on this particular PGA level, the probability of damage or the fragility was then calculated for each damage state. This process was repeated over other PGA levels to complete the fragility curves.

Analogous methodology with minor difference in details (*e.g.*, structural types, damage states, *etc.*) has been presented by several researchers. Seya *et.al.* [1993] applied this methodology in a probabilistic seismic analysis of a five-story steel frame building. Uncertainties in structural and seismic parameters were taken into account. In this study, the damage state was defined in terms of the system ductility ratio obtained from a nonlinear time-history analysis. Peak ground acceleration (PGA) is used as an earthquake intensity measure. For a given PGA level, a lognormal probability distribution function was fitted to the computed response data. Probabilities of damage could be calculated from these fitted lognormal relations. The fragility curves were then constructed by evaluating the probability of damage at different levels of PGA. Song and Ellingwood [1999] investigated the role of inherent uncertainty on the seismic reliability of special moment steel frames with welded connections. Simple damage states based on overall or interstory drifts were implemented. Four parameters from the hysteresis model of degraded connection behavior were treated as structural uncertainties. Factorial analysis was performed to study the effect and significance of each parameter. It was concluded that only two parameters had a statistically significant effect on the response. Additional structural parameters

included the material properties and the damping ratio. An ensemble of 9 simulated ground accelerations was considered an equally likely representation of ground motion at the site. The Latin Hypercube sampling was chosen to represent combinations of structural and seismic uncertainties in calculating the dynamic response. The responses were rank-ordered and plotted on lognormal probability report for each spectral acceleration level. The lognormal distribution parameters were determined from regression analysis and the maximum likelihood estimates (MLE). The seismic fragilities were then calculated from these probability functions.

Dumova-Jovanoska [2000] proposed the use of Modified Mercalli Intensity (MMI) scale as an earthquake intensity indicator in the development of fragility curves and damage probability matrices for reinforced concrete structures in Macedonia. A normal probability distribution was assumed for the damage measures and the validity of the fitted values was checked by the Chi-square test. Since the MMI could be regarded as a discrete intensity level, the fragility curves were depicted as a piece-wise combination of lines connecting between two MMI levels.

Hwang *et.al.* [2000] further simplified the statistical process by forgoing a process of calculating exceeding probability for each PGA level. Instead, an overall relationship between the damage measures and ground-shaking parameters (PGA or Sa) was set up through a regression analysis. Using the Latin Hypercube technique, 100 unscaled earthquake samples and 10 structure samples were combined and a total of 100 earthquake-structure samples were established. Dynamic analyses of these sample resulted in 100 pairs of PGA (or Sa) and damage measures and the functional relationship is established through a regression analysis. Both demand and capacity of the structure is assumed to follow a lognormal probability density function. Probabilities of demand exceeding capacity or fragility can be calculated as a function of seismic intensity.

More recently, similar approach was proposed by Cornell *et.al.* [2002]. It was assumed in this study that structural uncertainties remained deterministic following the notion that

uncertainties in the loadings were much more pronounced in the case of earthquakes. A single structure was subjected to a collection of unscaled ground motions. A relationship between the median of the drift demands (responses) and corresponding spectral accelerations (seismic intensity) of the earthquakes were approximated by a power function. Parameters of this power function were estimated from a regression analysis of nonlinear dynamic results. Dispersions of the drift demands given S_a were measured assuming a lognormal distribution of the drift demands. As a result, the fragilities or the probability of exceeding certain values of drift demands given S_a were easily obtained based on the lognormality assumption.

It can be observed that there is dissimilarity among the past research in the selection of the probability density functions for fitting the sampled seismic responses. The probability distributions considered by the researchers include the lognormal distribution (by Hwang and Huo [1994a, 1994b], Seya *et.al.* [1993], Shinozuka *et.al.* [2000a, 2000b], Song and Ellingwood [1999], and Cornell *et.al.* [2002]), the normal distribution (by Dumova-Jovanoska [2000]), and the Extreme Type I distribution (by Jaw and Hwang [1988]). Questions arise on the issue of which type of distributions provides the best estimates and whether the best estimate is a close representation of the real probabilistic description of the response. Unlike the past research, this report presents an alternative means for deriving the exceedance probabilities of the seismic response from a straightforward Monte Carlo simulation in which an assumption for a specific density function is not necessary.

In summary, for analytical fragility curves, there are two ways of computing probabilities of damage. The most direct and accurate means uses Monte Carlo technique to simulate a large number of random samples and calculate probability essentially by counting the actual outcomes. This is a brute-force method that provides accurate values of probability of damage, but it is very computational expensive. Another means uses a sampling technique such as a Latin Hypercube to simplify the random simulation process. It significantly reduces the number of samples to a

PROJECT DS-5 FINAL REPORT

manageable level and approximates the probability values by curve-fitting a small number of responses to an assumed probability distribution. However, probabilities of exceeding a certain limit state are based on limited data and may not represent the actual outcomes. Graphical representations of the two processes (Figure 2.3) are equivalent to that used by Fox [1994] to describe the methods in probabilistic design system. According to Figure 2.3, method (a) applies a more accurate Monte Carlo to an accurate but complex representation of seismic response analysis. Method (b) applies an inaccurate Latin Hypercube sampling technique to an accurate seismic analysis model.

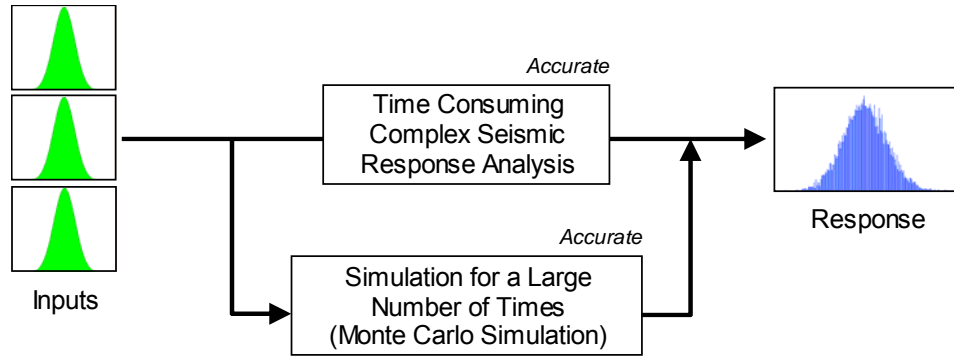

(a)

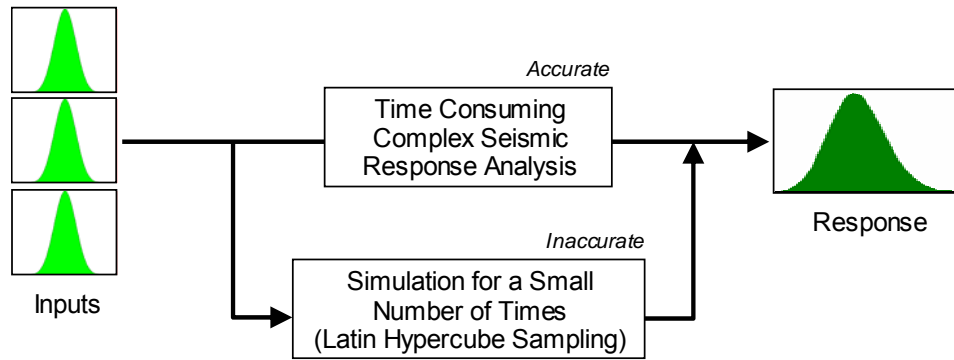

(b)

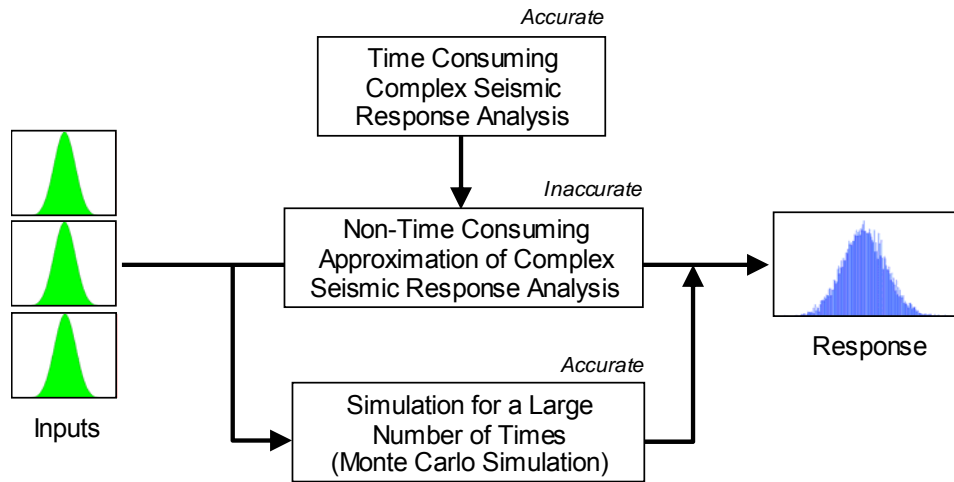

(c)

Figure 2.3: Methods for Computing Probability Density of Responses

PROJECT DS-5 FINAL REPORT

This report explores an alternative means of simplifying the fragility calculation process. The existing method uses a sampling technique to simplify the process of simulating complex seismic analyses and, hence, approximates the probabilistic characteristics of the seismic responses by fitting limited data to a particular probability distribution. On the other hand, this report proposes an effective means to approximate the seismic response analysis using metamodels (Figure 2.3c). Since the models become more computational tractable, the direct Monte Carlo simulation can be applied to the approximated model (metamodel) and the probability of exceeding certain levels can be calculated independent of any specific density function. Detailed development of the metamodels and approaches for computing building seismic fragilities are presented in Chapters 3 - 5. The application to geotechnical structures is described in Chapter 6 (earth dams) and Chapter 7 (levees).

CHAPTER 3

RESPONSE SURFACE METAMODELS IN FRAGILITY CALCULATION

The previous chapter presented the conventional means of generating analytical fragility curves. Sampling techniques were used for developing a brute-force simulation of complex seismic response analyses (Figure 2.3b). A problem arises when the probability distribution derived by fitting a small number of data points may not be representative of the actual population of the responses. Instead of trying to approximate the density function of the responses, this report proposes an approach for approximating building and geostucture seismic responses in a closed-form functional fashion (Figure 2.3c). The probability distribution of the response can then be analytically derived from the functional relationship of the input and output variables. In general, such a derivation for complex structural or geostructural systems is generally difficult especially when the functional relationships are nonlinear. As an alternative, a Monte Carlo simulation can be naively performed on an approximated model with relatively little computational cost needed to obtain the probability distribution of the response. The use of a metamodel (or model of a model) technique in conjunction with Monte Carlo technique for approximating seismic fragilities is presented in detail in this chapter.

3.1 Definition of Metamodels

In most cases, the exact relationship between a response and a set of input variables that influence the response is implicit and the response has to be computed by running a “black box” complex computer code. In many circumstances, however, the computational expense of running computer analysis codes may become prohibitive when the models are complex and when a large number of models is involved.

A metamodel is a statistical approximation of the complex and implicit phenomena. Response is estimated in a closed-form function of input variables which is computationally simpler to evaluate. If the true but unknown relationship between response (y) and a vector of input variables (ξ) in nature is represented as

$$y = f(\xi) \quad (3.1)$$

Then a metamodel $g(\xi)$ is sought to approximate the true relationship $f(\xi)$. The relationship between y and ξ becomes

$$y = g(\xi) + \varepsilon \quad (3.2)$$

where ε represents a total error term. This error term is the sum of a lack-of-fit or bias error (ε bias) resulting from approximation of $f(\xi)$ with $g(\xi)$ or an approximation of the reality and a random error (ε random) due solely to experimental and observational error (*i.e.*, repeating experiments at a specific set of ξ produces different values of y). The error term is assumed to be a zero-mean random variable. However, the random error term (ε random) does not exist in the case of computer analysis where repeated analytical evaluations of ξ always yield the same value of y . Expectation of the response function is in the form

$$E[y] = g(\xi) \quad (3.3)$$

which can be derived by running computer analysis codes at predefined levels of ξ (*i.e.*, experimental designs), observing responses, and fitting data to an appropriate model.

Construction of metamodels generally involves 3 main steps: (1) choosing an experimental design for selecting a set of ξ for observing or running analysis for y , (2) choosing a functional form of $g(\xi)$ for metamodel representation, and (3) fitting the model to the observed data. Several options in each step result in various approximation techniques that can be used as metamodels, as shown in Figure 3.1. Typical metamodels include polynomial regression models

of complex analyses based on experimental designs (*e.g.*, the response surface methodology), artificial neural networks, kriging, Gaussian metamodels, and inductive learning metamodels.

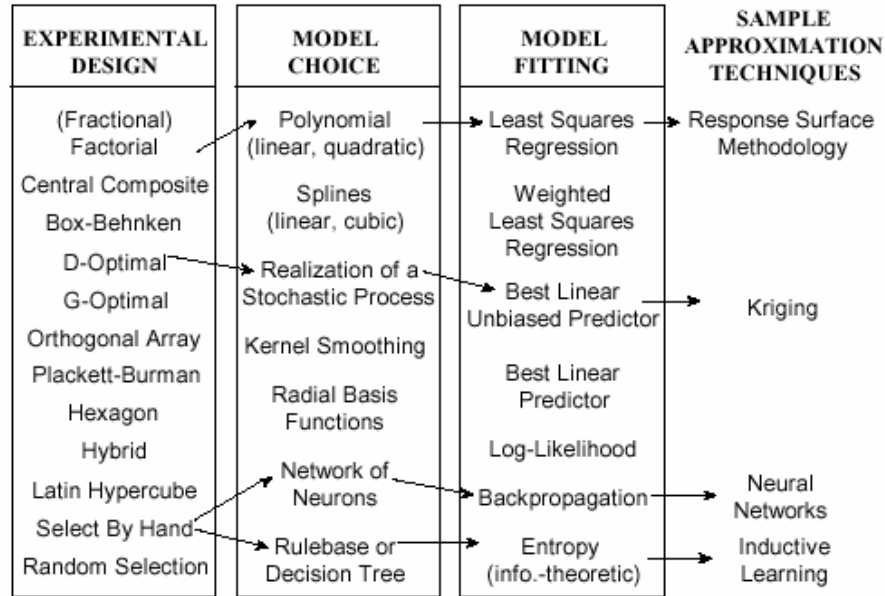

Figure 3.1: Steps for Constructing Metamodels [Simpson *et al.*, 2001]

3.2 The Response Surface Methodology

One of the most widely-used metamodels is the Response Surface Methodology (RSM). The origin of the RSM can be traced back to the works done by several researchers in the early 1930's or even earlier. However, it was not until Box and Wilson [1951] formally developed the methodology to determine the optimal condition in the chemical investigations. Since then, the RSM has been successfully applied in many different fields of study such as chemical engineering, industrial engineering, manufacturing, aerospace engineering, structural reliability, and computer simulation.

Response Surface Methodology refers not simply to the use of a response surface as a multivariate function but also to the process for determining the polynomial coefficients

themselves [Myers and Montgomery, 2002]. A response surface equation is simply a polynomial regression to a data set. The process is straightforward if a sufficiently large data set is available, that is, if the number of members in the data set is at least as large as the number of coefficients in the polynomial. On the other hand, if the data set must be determined and if the process is time-consuming and computationally expensive, then the overall usefulness of the method will depend on the use of an efficient method for selecting the fewest possible members. Design of Experiments (DOE) techniques provide the needed basis for this critical step in the methodology [Montgomery, 1997].

3.2.1 Design of Experiments

Following the general 3 steps of constructing metamodels (Figure 3.1), the first step is to generate an appropriate experimental design. The experimental design systematically defines an efficient set experimental sampling points at which the responses must be computed or observed. There are many types of experimental design that can be used for this purpose [Montgomery, 1997], but the most common ones are a Full Factorial design (FFD) and a Central Composite design (CCD).

The DOE takes levels of input variables to systematically formulate different combinations at which the outputs are observed or computed. In the DOE domain, it is more convenient to use the “coded” or “standardized” input variables (x_i) instead of their actual values (ξ_i). For example, let's assume that the actual input variables ξ_i has a region of interest defined by the lower and upper bounds $\xi_{i,low}$ and $\xi_{i,high}$, respectively. The coded variable x_i can be calculated as

$$x_i = \frac{\xi_i - \frac{\xi_{i,high} + \xi_{i,low}}{2}}{\frac{\xi_{i,high} - \xi_{i,low}}{2}} \quad (3.4)$$

This coded variable x_i has a value of -1 for the lower level, a value of 0 for the mid-level, and a value of +1 for the high level. In some cases, the experimental design may include variable

levels that locate outside the original range. It results in coded values below -1 or above +1. An example of this type of experimental design is the CCD, which will be explained in the subsequent paragraphs.

Choosing meaningful ranges for the input variables must be done with great care. On the one hand, the ranges should be large enough to include all possible parameter spaces. On the other hand, the ranges cannot be so large that they reduce the prospect of a good regression fit of the response surfaces to the actual response.

The simplest experimental design for collecting observations is the Full Factorial Design (FFD) or the 3^k Factorial Design. In this arrangement, each input variable is assumed to take on 3 different values, which when equally spaced, produces the coded values -1, 0, and +1. It is required, in the FFD, that the responses are observed at all possible combinations of the levels of k input variables which have three levels each. The total number of variable level combinations (design points) becomes $N = 3^k$ points which can be impractically large, especially when a large number of input variables are under study or when the experiments are costly.

An unmanageable number of experiments required in the FFD leads to an introduction of the designs that require fewer design points, while maintaining acceptable accuracy in the prediction. Perhaps the most popular class of designs used in a second-degree model is the Central Composite Design (CCD). This consists of:

1. A complete 2^k factorial design, where the variable levels are coded to the usual -1 and +1 values. This is called the factorial portion or “cube” points of the design.
2. Two axial points on the axis of each design variable at a distance of α from the design center. This portion is called the axial portion or “star” points of the design.
3. n_0 center points ($n_0 \geq 1$).

PROJECT DS-5 FINAL REPORT

Selection of the location of the axial or star points prompts further discussion since it affects the rotatability property of the CCD. Rotatability in the designs ensures that the variance of the estimated response is constant at a fixed distance from the center point. The CCD is considered rotatable if

$$\alpha = (2^k)^{1/4} \quad (3.5)$$

It is obvious that α is always greater than unity, which makes the star points located outside the original range. As a result, each input variable has to be evaluated at 5 levels ($-\alpha$, -1 , 0 , $+1$, and $+\alpha$). This may not be practical in some instances where it is physically difficult or impossible to extend the experiment beyond the region defined by the upper and lower limits of each input variable. In addition, this research seeks an efficient method with less computational effort as possible. The rotatability requirement can be dropped in such cases and the distance α is set at 1. Results from such a design prove that the response surface model provides good prediction even without the rotatability property.

The replications of the center points provide a means for estimating pure experimental error. However, this type of error does not exist in the computer analysis. Hence, only one replicate of the center point is required. As a result, the total number of distinct design points is $N = 2^k + 2k + 1$. Comparison in the number of experiments required by the FFD and the CCD is shown in Table 3.1. Graphical layouts of the FFD and the CCD (with $\alpha = 1.0$) considering 3 input parameters are displayed in Figure 3.2.

Table 3.1: Number of Experimental Samples for Different DOEs

DOE	Equation	3 Variables	5 Variables	7 Variables
Full Factorial Design	3^k	27	243	2187
Central Composite Design	$2^k + 2k + 1$	15	43	143

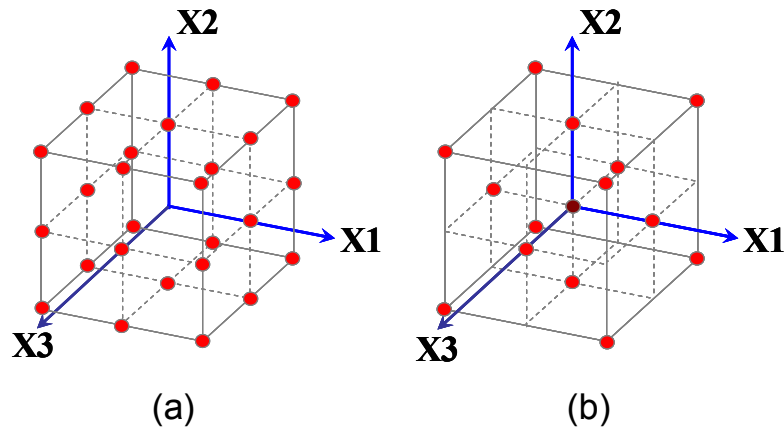

Figure 3.2: Graphical Layout of (a) Full Factorial Design, and (b) Central Composite Design, for Three Variables

There are other experimental designs that can be used for response surface application such as the Box-Behnken design, the Space Filling design, Taguchi’s orthogonal arrays [Simpson *et.al.*, 2001], *etc.* However, they are not as widely used as the FFD and the CCD.

3.2.2 Response Surface Model Fitting

After performing a set of experiments or computer runs to obtain outputs according to the experimental designs, the next step is to take the vectors of inputs (x) and corresponding outputs (y) for fitting an appropriate model.

The most widely used response surface function is a mathematical polynomial function. Typical response surface models limits the order of the polynomials to one or two since low-

degree models contain fewer terms than higher-degree models and thus require fewer experiments to be performed. In the case of seismic analysis, the responses usually exhibit highly nonlinear (or even discontinuous) behaviors, and as a result an immediate question arises as to whether any low-degree polynomial is appropriate for a response surface. Since the application of the response surfaces will be to estimate responses for a number of input variables with wide ranges in a Monte Carlo simulation and then to use these to estimate exceedance probabilities, it is felt that the lack of local irregularity inherent in a low order polynomial will not be a limitation. However, it is very important that the selected samples used to construct the response surface represent the most important trends in the structural response over the range of inputs considered. A second-order polynomial is used as a response surface model in this study. The response function considering second-order polynomial model is as follows:

$$y = \beta_0 + \sum_{i=1}^k \beta_i x_i + \sum_{i=1}^k \beta_{ii} x_i^2 + \sum_{i=1}^{k-1} \sum_{j>i}^k \beta_{ij} x_i x_j + \varepsilon \quad (3.6)$$

where

- Y = Response or dependent variable
- x_i, x_j = The coded input or independent variables
- $\beta_0, \beta_i, \beta_{ii}, \beta_{ij}$ = Unknown coefficients to be estimated
- E = Bias or lack of fit error term
- K = Number of input variables

Even though the response surface function in (3.6) contains higher-order terms, it is still considered as a linear regression model. Alternatively, the model can be written in the form of general linear model as follows:

$$y = \beta_0 + \sum_{i=1}^{p-1} \beta_i z_i + \varepsilon \quad (3.7)$$

where p is the number of parameters to be estimated. A vector of dummy first-order variables z replaces the original input variable x that contain quadratic terms. For example, a response function with 2 input variables (x_1 and x_2) which has the quadratic form of

$$y = \beta_0 + \beta_1 x_1 + \beta_2 x_2 + \beta_{11} x_1^2 + \beta_{22} x_2^2 + \beta_{12} x_1 x_2 + \varepsilon \quad (3.8)$$

can be converted into a general linear regression model as

$$y = \beta_0 + \beta_1 z_1 + \beta_2 z_2 + \beta_3 z_3 + \beta_4 z_4 + \beta_5 z_5 + \varepsilon \quad (3.9)$$

It can be seen that the dummy variables $z_1, z_2, z_3, z_4,$ and z_5 are equivalent to the original variables $x_1, x_2, x_1^2, x_2^2,$ and $x_1 x_2,$ respectively. The regression model becomes linear both in terms of parameters and independent variables.

A general matrix form of the linear model can be written as

$$\mathbf{Y} = \mathbf{Z}\boldsymbol{\beta} + \boldsymbol{\varepsilon} \quad (3.10)$$

where

$$\mathbf{Y} = \begin{bmatrix} y_1 \\ y_2 \\ \vdots \\ y_N \end{bmatrix}_{N \times 1} \text{ is a vector of actual responses,}$$

$$\mathbf{Z} = \begin{bmatrix} 1 & z_{11} & z_{12} & \cdots & z_{1,p-1} \\ 1 & z_{21} & z_{22} & \cdots & z_{2,p-1} \\ \vdots & \vdots & \vdots & \cdots & \vdots \\ 1 & z_{N1} & z_{N1} & \cdots & z_{N,p-1} \end{bmatrix}_{N \times p} \text{ is a matrix of constant,}$$

$$\boldsymbol{\beta} = \begin{bmatrix} \beta_0 \\ \beta_1 \\ \vdots \\ \beta_{p-1} \end{bmatrix}_{p \times 1} \text{ is a vector of unknown parameters, and}$$

$$\boldsymbol{\varepsilon} = \begin{bmatrix} \varepsilon_1 \\ \varepsilon_2 \\ \vdots \\ \varepsilon_N \end{bmatrix}_{N \times 1} \text{ is a vector of error terms with expectation } E[\boldsymbol{\varepsilon}] = 0.$$

Consequently, a random vector \mathbf{Y} has expectation of

$$E[\mathbf{Y}] = \mathbf{Z}\boldsymbol{\beta} \quad (3.11)$$

The parameters of the polynomials are usually determined by a least squares regression analysis by fitting to existing experimental data points. The method of least squares selects the values $(b_0, b_1, \dots, b_{p-1})$ for unknown parameters $(\beta_0, \beta_1, \dots, \beta_{p-1})$ such that they minimize the sum of squares of the differences between the actual output (y) and the approximated or fitted outputs (\hat{y}). Mathematically, the least squares method minimizes

$$S(\mathbf{b}) = \sum_{u=1}^N (y_u - \hat{y}_u(\mathbf{b}))^2 \quad (3.12)$$

where S is defined as the sum of squares function, N is the number of experimental points ($N > p$), and \mathbf{b} is a vector of least squares estimates of parameters $\boldsymbol{\beta}$.

The estimates of the polynomial parameters can be obtained by solving the following matrix equation

$$\mathbf{b} = (\mathbf{Z}'\mathbf{Z})^{-1}(\mathbf{Z}'\mathbf{Y}) \quad (3.13)$$

in which its derivation can be found in Chapter 3 of Box and Draper [1986]. The fitted response surface function becomes

$$\hat{y} = b_0 + \sum_{i=1}^k b_i x_i + \sum_{i=1}^k b_{ii} x_i^2 + \sum_{i=1}^{k-1} \sum_{j>i}^k b_{ij} x_i x_j \quad (3.14)$$

The use response surface methodology in connection with Monte Carlo simulation simplifies the process of generating fragility curves. Since the simulations are not performed on

complex structural analyses, but rather on a polynomial equation, a lot of computational time can be saved. The probability of damage conditional on seismic intensity can be calculated from the simulation results and fragility curves can be constructed.

3.2.3 Statistical Validation of Response Surface

Least-square regression analysis gives the parameter estimates for the response surface function. The next step is to evaluate an adequacy of fit of the model. There are a number of statistical measures that can be used to verify linear regression models. However, statistical testing is inappropriate in the cases where outputs are computed by deterministic computer runs and random error (ϵ_{random}) does not exist [Welch *et.al.* 1990, Simpson *et.al.* 2001]. The simplest measure for verifying model adequacy in deterministic computer experiments is the coefficient of determination (R^2).

$$R^2 = \frac{SSR}{SST} \quad (3.15)$$

where

$$SSR = \mathbf{b}'\mathbf{X}'\mathbf{Y} - \frac{(\mathbf{1}'\mathbf{Y})^2}{N} \quad \text{is the Error Sum of Squares,}$$

$$SST = \mathbf{Y}'\mathbf{Y} - \frac{(\mathbf{1}'\mathbf{Y})^2}{N} \quad \text{is the Total Sum of Squares, and}$$

$\mathbf{1}'$ is a 1 x N vector of ones.

The value of R^2 characterizes the fraction of total variation of the data points that is explained by the fitted model. It has a value between 0 and 1 (with 1 being a perfect fit).

However, the R^2 can be misleading in some cases since it always increases as more input

variables are added. An adjusted- R^2 (R_A^2), which takes into account the number of parameters

in the model, is introduced for evaluating the goodness-of-fit of the model. It can be computed as follow.

$$R_A^2 = 1 - (1 - R^2) \cdot \left(\frac{N-1}{N-p} \right) \quad (3.16)$$

A value of R_A^2 close to unity indicates a good fit of the response surface model to the experimental data points. Papila and Haftka [2000] suggested the value of R^2 (or R_A^2) of at least 0.9 to ensure adequate approximation of the model.

Even though the R_A^2 value explains how well the model fits to the experimental points, the value does not, however, reflect the prediction potential of the model to other points not used to generate model. In order to verify the overall accuracy of the response surface models, statistical tests at additional random data points in the design space must be performed. Those tests include the Average Absolute Error (%AvgErr), the Maximum Absolute Error (%MaxErr), and the Root Mean Square Error (%RMSE) [Venter *et.al.*, 1997]. These measures are defined as follow.

$$\%AvgErr = 100 \cdot \frac{\frac{1}{N} \cdot \sum_{i=1}^N |y_i - \hat{y}_i|}{\frac{1}{N} \cdot \sum_{i=1}^N y_i} \quad (3.17)$$

$$\%MaxErr = \max_i \left[100 \cdot \frac{|y_i - \hat{y}_i|}{\frac{1}{N} \cdot \sum_{j=1}^N y_j} \right] \quad (3.18)$$

$$\%RMSE = 100 \cdot \frac{\sqrt{\frac{1}{N} \cdot PRESS}}{\frac{1}{N} \cdot \sum_{i=1}^N y_i} \quad (3.19)$$

where

$$\text{PRESS} = \sum_{i=1}^N (y_i - \hat{y}_i)^2$$

Finally, in addition to the use of these measures, visual assessment of the residual and the correlation plots may be helpful in determining model accuracy.

3.3 Past Applications

While the application of a response surface methodology to determine fragility curves is novel, it is not uncommon in other applications. Response surface metamodel applications have been extensively employed over the past decade in the area of aerospace system design and structural reliability.

3.3.1 Applications in Aerospace System Design

The pioneering uses of the response surface were to approximate higher fidelity analyses at an early point in the design of an aerospace system when there is not enough detail to support such analyses. The goal of the preliminary design of aerospace systems is to determine a set of design parameters that optimizes the performance of a system. The optimization process usually involves iterative analyses of complex structural systems that quickly becomes computationally prohibitive. A response surface concept is utilized in this context to approximate complex system analyses and convey what a particular design will deliver.

Engelund *et.al.* [1993] conducted an investigation to determine a set of optimal aerodynamic configuration design parameters for a space transportation system. The design of such a vehicle is a complex process even at the conceptual level. The response surface methodology was used to optimize a set of configuration parameters in order to achieve minimum vehicle dry weight, while maintaining other constraints. Mavris and Bandte [1995] and Mavris *et.al.* [1996] carried out an economic uncertainty assessment of a High Speed Civil Transport

(HSCT) using a combined response surface methodology and Monte Carlo simulation approach. Response surface for the average yield per Revenue Passenger Mile is constructed as a function of seven input variables. An uncertainty assessment using the Monte Carlo simulation is performed on the response surface model. DeLaurentis *et.al.* [1996] incorporated a response surface equation in place of a complex aerodynamic analysis in a preliminary aircraft design in order to more efficiently search the design space for optimum aircraft configurations.

3.3.2 Applications in Structural Reliability

A general structural reliability problem considers a probability of failure of a structural system. Failure occurs when a limit state function reaches a certain predefined values. However, the limit state functions generally cannot be explicitly represented by closed form solutions. Response surface methodology has been used in this field for approximating these implicit limit state functions. Examples of application are shown as follow.

Bucher and Bourgund [1990] were among the first researchers to introduce an application of the response surface methodology in the field of structural reliability. The method is used to approximate limit state conditions of a nonlinear single-degree-of-freedom oscillator and a frame structure. Good quality of the response surface prediction was observed. Rajashekhar and Ellingwood [1993] then evaluated an existing response surface approach in structural reliability analysis and proposed a way for selecting experimental points at the distribution extremes instead of the entire range of the distributions. Numerical examples were given to confirm an efficiency of the approach. Rajashekhar *et.al.* [1996] compared the reliabilities, for various limit states, of reinforced concrete slabs by response surface approach with reliabilities obtained using traditional approaches. Yao and Wen [1996] extended the study into a time-variant problem. The research described a reliability calculation of structures under earthquake loads. A response surface methodology is utilized in approximating the maximum system response and providing an

explicit limit state function. A method for measuring the accuracy of the response surface approximation was also presented.

Response surface methodology was found to provide good approximation of the complex analysis code both in the case of aerospace system design and structural reliability calculation. These successful applications have led to an idea that the method could be useful in other fields where complex and implicit analysis code can be replaced by a simple response surface function. Seismic fragility analysis of buildings typically requires repetitive runs of dynamic analysis code in order to obtain reliable damage statistics and it easily becomes computationally prohibitive. This research implements the response surface concept for predicting building damage (responses) due to earthquake loadings. The approaches are described as follows.

3.4 Approaches for Calculating Building Fragility

Building seismic fragility describes the likelihood of damage to a building due to various levels of earthquakes. It takes into account randomness in earthquake loadings and uncertainties in the structural characteristics (*e.g.*, strength, modulus, geometric configuration) for deriving probabilistic descriptions of the damage. Seismic fragility assessment requires repeated damage simulations of a building with random properties subjected to random earthquake inputs. Each realization of seismic damage is carried out either through a time-history or a pushover analysis. It usually becomes impractical because of the large number of time-consuming analyses needed to obtain reliable statistics of the outcomes. A response surface metamodel is sought to approximate an implicit building seismic damage computation using an explicit polynomial function. Monte Carlo simulation is then performed over the simpler metamodel instead of the complex dynamic analyses. The process for calculating seismic fragility based on the use of response surface metamodels is described in the subsequent paragraphs.

PROJECT DS-5 FINAL REPORT

Figure 3.3 depicts a general process for generating fragility curves utilizing response surface metamodel concept. The first step is to define the input and output (or response) variables for the response surface. An appropriate building response or damage measure, such as a peak inter-story drift, is defined as an output variable. Random building parameters characterizing response calculation are used as input variables, and the applicable range of each input variable is defined. When a large number of input variables (generally more than 5) are identified, a screening process is generally used to determine the subset of variables that have the largest influence on the output (response). A DOE technique is utilized for selecting an efficient set of input variable combinations (experimental sampling). Finally, a seismic intensity measure is defined, and the ground motion records in an ensemble are scaled such that they have the same level of intensity.

Next, detailed computational analysis is performed on a building model constructed to represent one combination of input variables defined by the DOE step. Each of the scaled acceleration records is used as loading input for this analysis, and the chosen seismic response (*e.g.*, interstory drift, peak drift, peak acceleration, *etc*) is extracted from each analysis run. The process is repeated for each combination of input variables defined in the DOE step. Least-square regression analysis is then performed over the sampled input data points and corresponding outputs to form a polynomial response surface function. This response surface model is computationally inexpensive. Monte Carlo techniques with a large number of simulations can be carried out using probability density functions to describe the input variables. Consequently, the probability of the chosen response exceeding certain damage limit states can be extracted from the simulation outcomes. This probability value is conditioned on a specific earthquake intensity level and represents one point in a fragility curve. Repetition of the process over different levels of earthquake intensity provides exceedance probability values at other intensity levels, and the fragility curves can be constructed.

The main advantage of the response surface metamodel is that while it provides an admittedly simple functional relation between the most significant input variables and the output (response), the model is computationally very efficient.

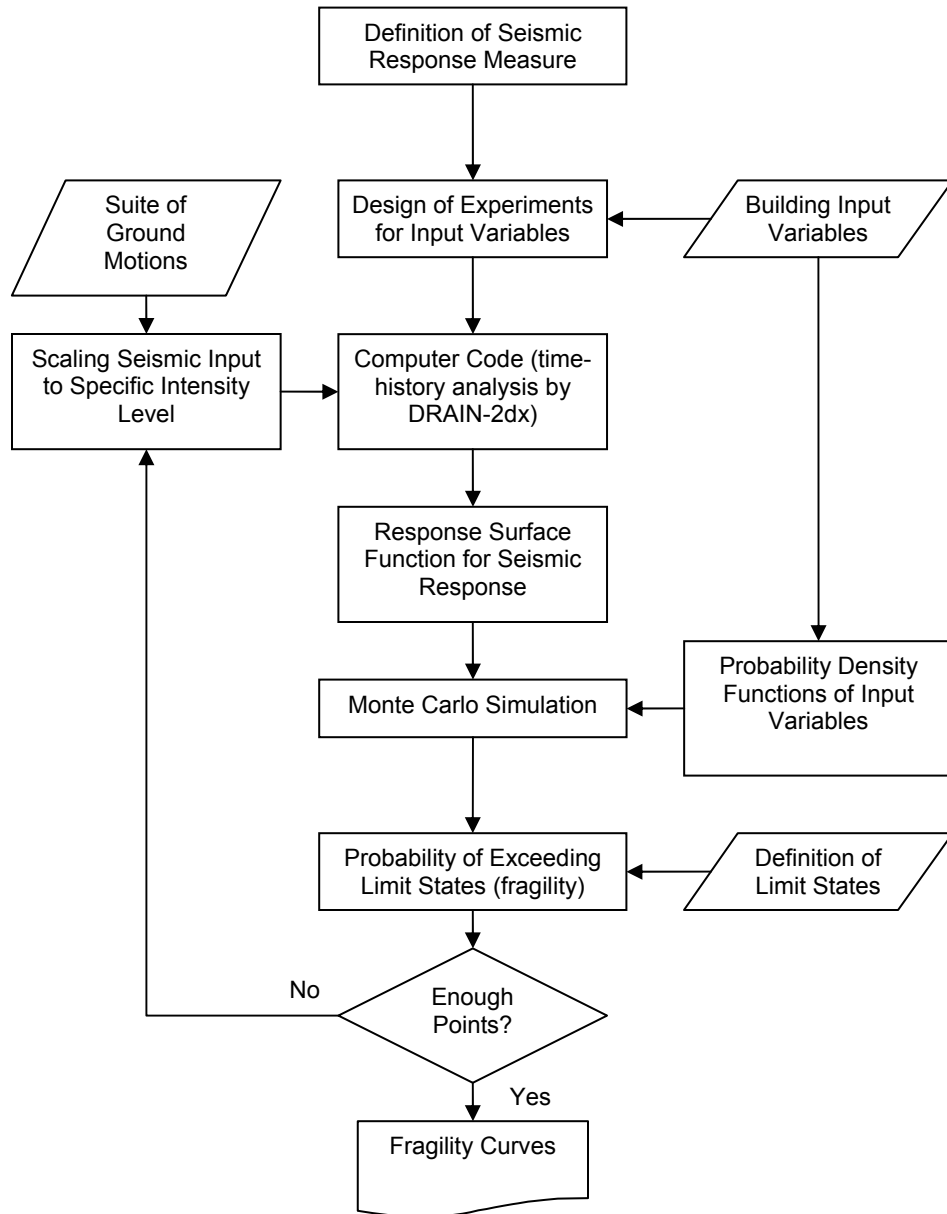

Figure 3.3: Process of Computing Seismic Fragility Using Metamodels.

PROJECT DS-5 FINAL REPORT

This study proposes 3 approaches for computing building seismic fragilities. Approach 1 and Approach 2 follow the general process shown in Figure 3.3. The main difference between the two approaches is on the way seismic uncertainties are treated. Approach 1 simply generates a response surface for each ground motion in a suite and they are randomly selected in the simulation process. On the other hand, Approach 2 makes use of the dual response surface concept [Lin and Tu, 1995] by generating response surfaces of the mean and standard deviation of building responses due to a suite of ground motions. Approach 3 further simplifies the process by adding a predictor variable describing the intensity of the earthquakes in the response surface metamodel. Details of the three approaches are given in the following paragraphs.

Approach 1 is the least efficient use of response surface in fragility computation. However, it follows closely the conventional notion in selection of earthquake loadings at random. The process starts by a general process of defining a suite of ground motions and its intensity measure. Each ground motion in the pool is then scaled to a specific level of intensity. In this approach, response surface models are generated for predicting building seismic response due to each individual ground motion in the suite as shown below.

$$\hat{y}_i = g_i(\mathbf{x}), i = 1..n,$$

where n is the number of ground motions. As a result, the number of response surface models is same as number of ground motions in the suite.

Monte Carlo technique is then applied not only for sampling to the probability density functions of the input parameters, but also in the random selection of response surface metamodels to use. Response surface metamodels are chosen with equal probability based on an assumption that each earthquake is equally likely to occur. The process of random selection of the response surface functions implicitly takes into account randomness in earthquake inputs. Damage probabilities or fragilities can be extracted from a large number of trials.

Approach 2 is proposed to overcome an unwieldy process of generating response surface models for individual earthquakes in Approach 1. Approach 2 takes a concept of dual response surface [Lin and Tu, 1995] and implements in the fragility computation. In this approach, seismic responses due to all ground motions in the suite are computed at each experimental design point. These seismic responses are assumed to follow a specific probability distribution for each design point. Mean and standard deviation values of the response distribution are calculated. Dual response surface models for the mean and standard deviation of the building responses are generated, as shown in (3.20) and (3.21), respectively.

$$\hat{y}_{\mu} = g(\mathbf{x}) \quad (3.20)$$

$$\hat{y}_{\sigma} = h(\mathbf{x}) \quad (3.21)$$

The overall response surface model for predicting seismic demand becomes

$$\hat{y} = \hat{y}_{\mu} + Z(\mathbf{x}) \quad (3.22)$$

where $Z(\mathbf{x})$ represents a random departure from the predicted mean response due to randomness in earthquakes. This random term is assumed to have a Normal distribution with zero mean and the standard deviation of \hat{y}_{σ} . Theoretically, samples from Normal distributions can fall in the negative range of the response, which is not meaningful in the case of seismic demands.

However, the probability of this event was found to be very small and had little impact on the response statistics computed from (3.20) and (3.21). The normality assumption is validated in the subsequent sections.

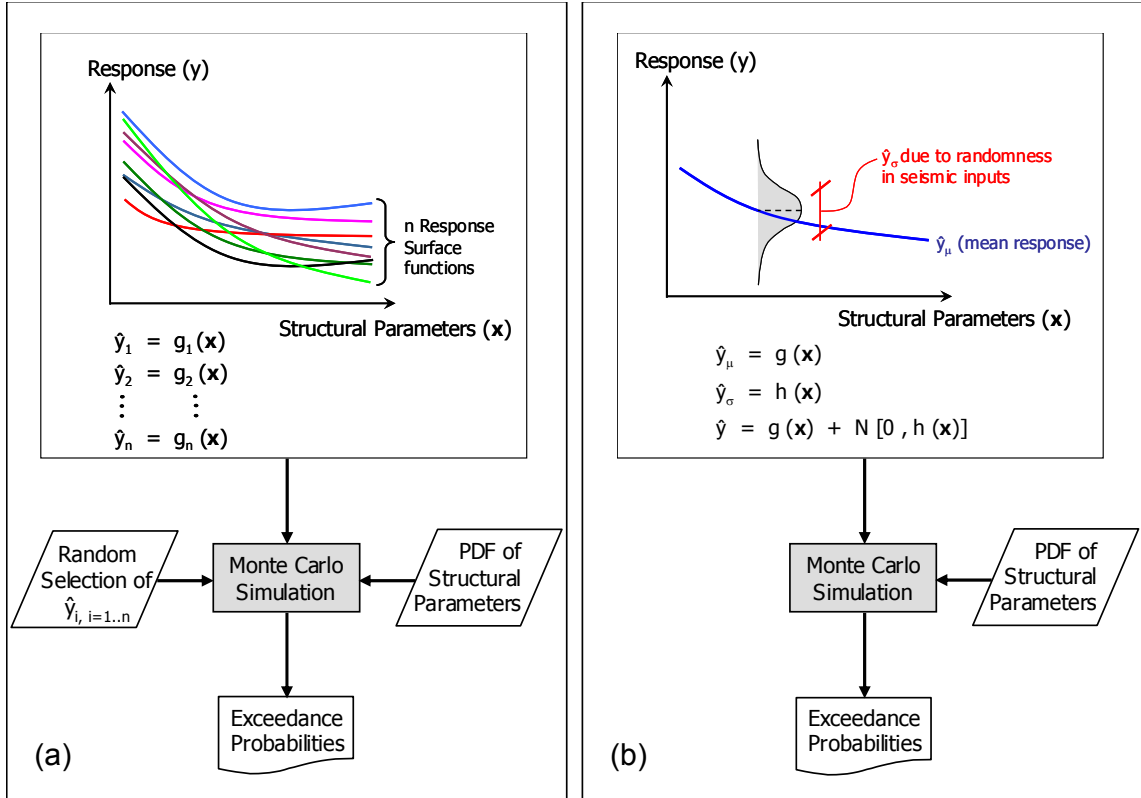

Figure 3.4: Graphical Layouts of the Implementation of (a) Approach 1, and (b) Approach 2

Graphical layouts of Approach 1 and Approach 2 are shown in Figure 3.4. For simple representation, each response surface model is shown as a 2-dimensional plot of the response (y) in a vertical axis and a vector of structural parameters (\mathbf{x}) in a consolidated horizontal axis. The two approaches differ in the process of building the metamodels, yet the use of the models are generally the same except that Approach 1 requires a random selection of the response surface models.

The downside of the proposed process (Figure 3.3) is the fact that the response surface is conditioned on a specific level of earthquake intensity. Hence, the entire process of generating the response surface models has to be repeated for different levels of earthquake intensity. Approach 3 is proposed as a modification of Approach 2 to overcome this weak point. In this approach, an earthquake intensity parameter (s) is included in the response surface model in

addition to the structural uncertainty parameters (\mathbf{x}). Figure 3.5 shows a schematic view of a response surface model in Approach 3. The seismic intensity parameter (s) is displayed as an added dimension to the plots between the response (y) and a vector of input parameters (\mathbf{x}). Similar concept to Approach 2 with the dual response surfaces of the mean (3.23) and standard deviation (3.24) of responses is implemented in Approach 3.

$$\hat{y}_{\mu} = g(\mathbf{x}, s) \quad (3.23)$$

$$\hat{y}_{\sigma} = h(\mathbf{x}, s) \quad (3.24)$$

Hence, the overall response surface model can be shown as

$$\hat{y} = g(\mathbf{x}, s) + N[0, h(\mathbf{x}, s)] \quad (3.25)$$

where $g(\mathbf{x}, s)$ and $h(\mathbf{x}, s)$ are the response surface metamodells for predicting the mean and standard deviation of the building responses due to a suite of ground motions, respectively.

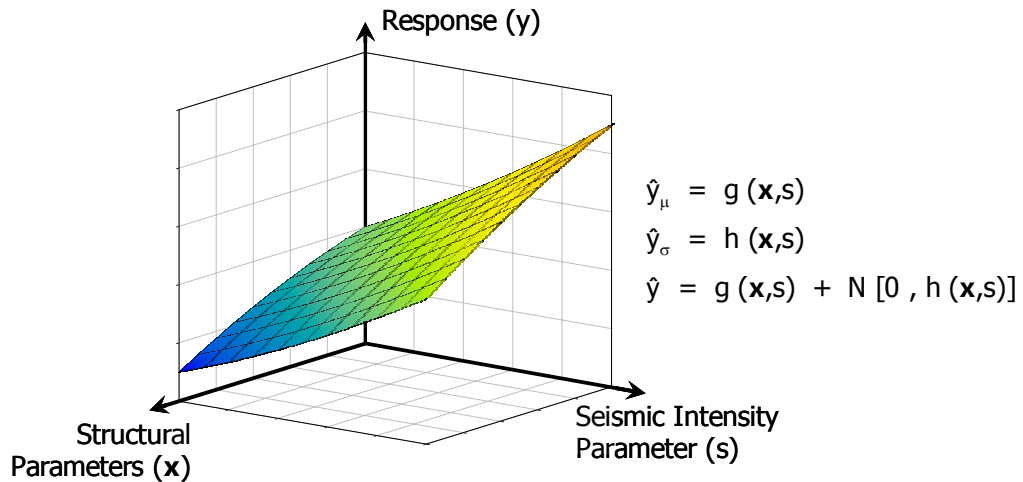

Figure 3.5: Graphical Layout of a Response Surface Model in Approach 3

The response surface developed in Approach 3 is not specific to a certain level of earthquake intensity. The computation of the response depends not only on the structural properties, but also on the level of seismic intensity. The required computational cost may

increase in the initial metamodel building process due to the added parameter. However, the overall process is much more efficient since the needs for repetitive generation of response surface models are eliminated. Metamodels for different levels of seismic intensity can be obtained directly by evaluating the response surface at specific values of intensity measures.

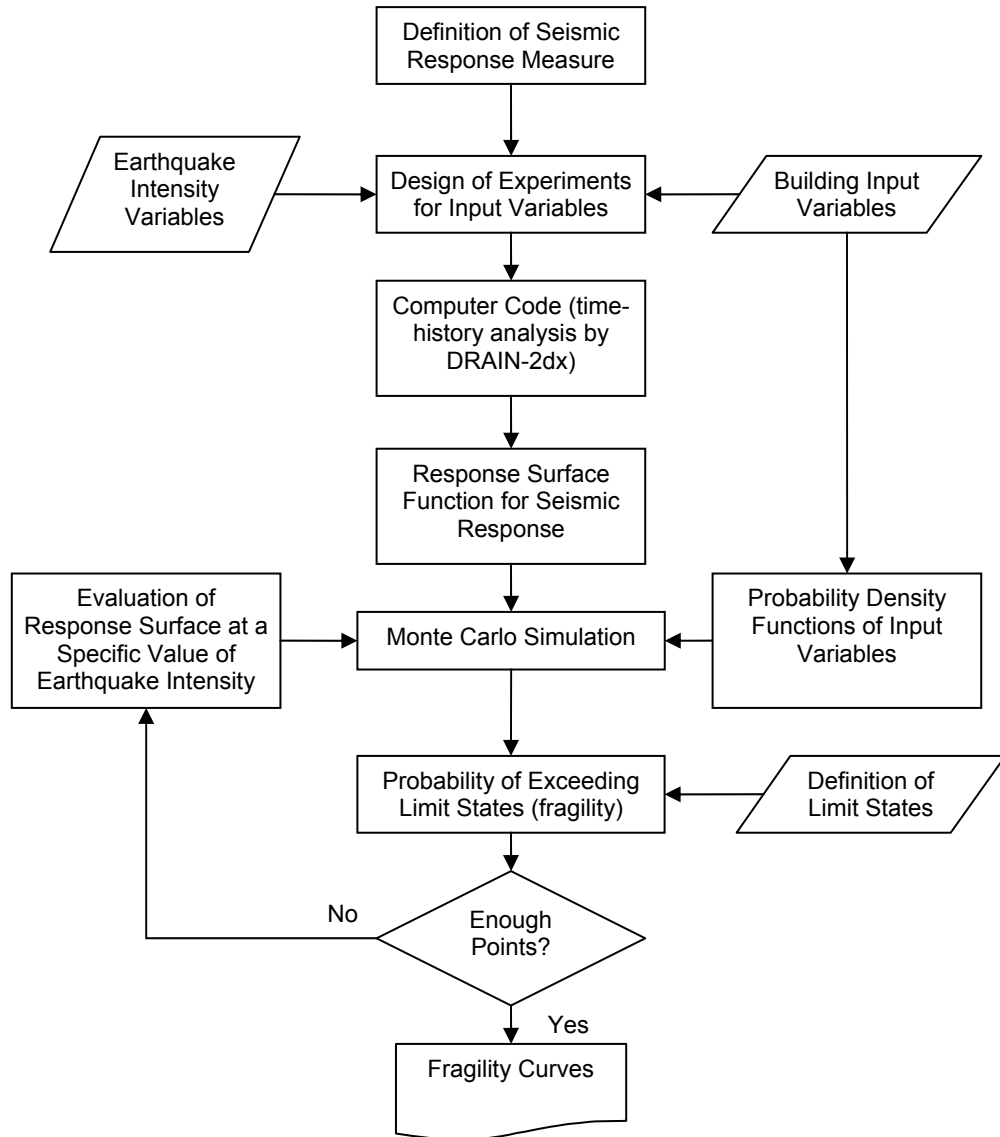

Figure 3.6: Modified Fragility Computation Process for Approach 3

The general process of constructing fragility curves is modified for Approach 3, as shown in Figure 3.6. Processes for building a response surface begin in a similar fashion as previous approaches, except that a Design of Experiments table is constructed based on both structural uncertainty parameters and seismic intensity parameter. One can view a seismic intensity parameter as a control variable and structural parameters as random variables in a response surface function. A control variable is fixed at a certain level of earthquake intensity while the random variables are varied according to their probability distribution in a Monte Carlo simulation. Damage probabilities obtained from the simulation are, in turn, conditioned on that particular level of intensity. In order to draw a fragility curve, the process is repeated at a simulation level by adjusting the control variable or seismic intensity parameter to other intensity values. It becomes computationally much cheaper than repetitively building many response surfaces as in Approach 1 and Approach 2.

Implementations of Approach 1, 2, and 3 for computing probabilistic descriptions of seismic response of a simple system are described in the next section.

3.5 Implementation of the Approaches: SDOF System

For the purposes of demonstrating and comparing the three proposed approaches, a simple structure is chosen as an example. Derivations of probabilistic response of a linear-elastic single-degree-of-freedom (SDOF) system are presented in detail. Even though the structure in this case is so simple that the benefit of using the metamodels will not be fully realized, its simplicity makes it possible for the validation of the approach to be done through conventional methods which for this case are no longer so time-consuming.

3.5.1 Description of the Structure

A rather simple structural model that can be used in a seismic response analyses is the nonlinear spring-mass SDOF system. The system is composed of a spring with an elastic

stiffness (k) and yield force or strength (F_y) connecting a lumped mass (m) to the ground as shown in Figure 3.7. Damping characteristic of the system is represented by a Rayleigh-type damping, which is proportional to mass and stiffness of a structure. For a SDOF system, a damping ratio can be computed as

$$\zeta = \frac{a_0}{2} \cdot \frac{1}{\omega_n} + \frac{a_1}{2} \cdot \omega_n \quad (3.26)$$

where $\omega_n = \sqrt{\frac{k}{m}}$ is the natural circular frequency of vibration of the SDOF system, and a_0 and a_1 are the mass and stiffness proportional damping coefficients, respectively.

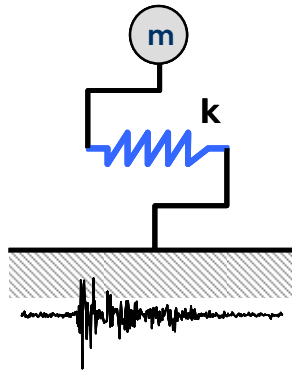

Figure 3.7: SDOF System and Hysteretic Behavior

A time-history dynamic analysis was carried out in this study in order to determine the structural responses. Time-dependent acceleration inputs were applied at the base of the structure, and the structural responses were obtained at each time step by numerical integration.

Maximum displacement of the SDOF system was chosen as a response measure for damage assessment. Fragility analysis requires that the computed responses are described probabilistically. This can be accomplished by simulating cases with random structural properties and earthquake inputs. Randomness in structural characteristics is described by the

probability density function of each parameter. These random parameters were, in turn, used as input variables of the response surface model. In this study, the random parameters include mass, stiffness, damping, and strength of the SDOF system. However, since the damping ratio is dependent on mass and stiffness of the system (3.26), it is not used in the response surface models. Table 3.2 summarizes the input variables and their assumed probabilistic density characteristics. Combinations of these structural properties represent SDOF structures with fundamental periods ranging from 1.2 to 3.1 seconds. A baseline structure was constructed using mean values of the structural properties. It has the mass of 8 kip-sec²/in and the elastic stiffness of 80 kips/in resulting in a fundamental period of 2 seconds and a damping ratio of 0.03.

Table 3.2: Structural Properties and Probabilistic Characteristics

Random Parameters	Distribution	Min	Mean	Max
Mass, m (kip-sec ² /in)	Uniform	4	8	12
Strength, F_y (kips)	Uniform	400	500	600
Stiffness, k (kip/in)	Uniform	50	80	110

3.5.2 Selection of Earthquake Ground Motion Records

Uncertainty in seismic inputs is taken into account by the use of a suite of earthquake records. Ground motions in a suite should be obtained from historical seismic events in a region of interest. However, in the region with fewer seismic activities (*e.g.*, Mid-America region), recorded events may be too scarce that available data are statistically insufficient. In this case, earthquake accelerograms must be analytically synthesized considering local seismic source and soil properties of the region. A large number of simulations must be carried out to obtain sufficiently large samples. Ground motion records in the suite consequently possess randomness in epicentral distance, focal depth, magnitude, attenuation, and slip distribution. Wen and Wu [2001] developed a set of synthetic ground motion records for 3 Mid-America cities: Carbondale,

PROJECT DS-5 FINAL REPORT

IL, Memphis, TN, and St. Louis, MO). Two groups of 10 acceleration records were generated for each city, with equal probabilities of occurrence in each group. In the end, there are a total of 60 synthesized acceleration records, and they were used collectively in this research. Each record is systematically named based on its location and probability of occurrence. For example, the record “m02_10s” is the 6th record generated for Memphis with 10% probability of occurrence. Examples of the time-history plots for these synthetic ground motions can be found in Wen and Wu [2001].

Typical earthquake intensity measures include the peak ground acceleration (PGA) and the spectral acceleration at a fundamental period of the structure (S_a). Selection of an appropriate intensity measure is based primarily on its correlation with the damage potential or, in this case, peak displacement. Correlation plots between peak displacement from the SDOF system and both intensity measures are shown in Figure 3.8 and Figure 3.9. It is apparent from these plots that spectral acceleration or S_a provides much higher correlation with structural response than that of the peak ground acceleration. As a result, S_a is chosen as a seismic intensity measure in this study.

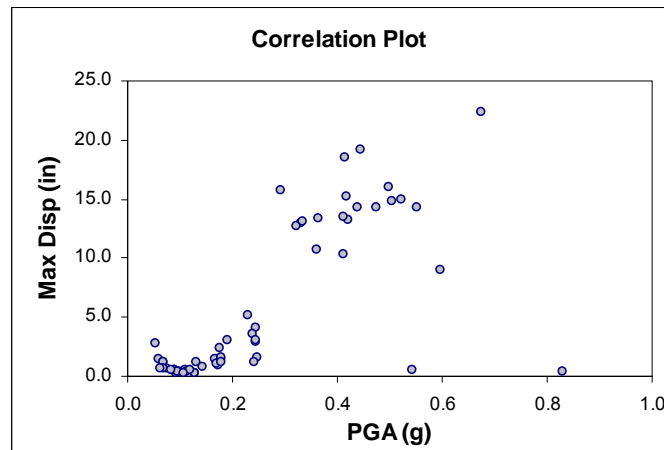

Figure 3.8: Correlation Plot between Maximum Displacements from the SDOF System and Peak Ground Acceleration (PGA) of the Ground Motion Records

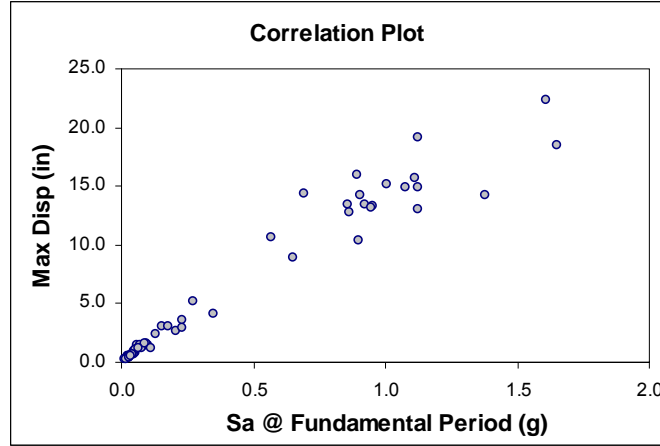

Figure 3.9: Correlation Plot between Maximum Displacements from the SDOF System and Spectral Acceleration (S_a) of the Ground Motion Records

The ground motion records in a suite were scaled such that they have the same level of earthquake intensity, that is, a spectral acceleration (S_a) at a fundamental period of the baseline structure (2 seconds). For example, the i^{th} earthquake record with a spectral acceleration of $S_{a,i}$ was scaled such that its spectral acceleration becomes $S_{a,\text{target}}$. The scale factor for the i^{th} record is

$$F_i = \frac{S_{a,\text{target}}}{S_{a,i}} \quad (3.27)$$

The scaling of the ground motion records ensures that the damage probabilities calculated based on a suite of ground motions is conditioned on a specific seismic intensity level.

Based on the definition of a response or damage measure and an earthquake intensity measure, the fragility of this SDOF system for a given hazard level (0.4g) can be expressed following (2.1) as

$$PF_i = \text{Pr ob}[\text{Max.Displ.} \geq d_i \mid S_a = 0.4\text{g}]$$

where PF_i is a fragility of performance or damage level i and d_i is a performance or damage threshold described in term of a maximum displacement.

Subsequent sections present detailed implementation of the 3 approaches in deriving probability distributions of the maximum displacement of a SDOF system.

3.5.3 Approach 1

Approach 1 generates response surface metamodels for approximating maximum displacement of the SDOF system under a specific earthquake motion. The number of response surface models is the same as the number of earthquake records in a suite.

3.5.3.1 Design of Experiments

Input variables for a response surface model generation are initially those that define randomness in structural properties (Table 3.2). The variable or design space is formed by defining an operating range of each input variable in a way that the range covers most of the area under the probability density of the structural parameter. For this particular example, since each random parameter is uniformly distributed over a finite region, the design space is defined according to each parameter's probability distribution. Selection of the location of the center point for each variable space is less relevant in the case of seismic response analysis since much higher variability exists in earthquake than that in structural properties. Mean values of the structural parameters are used as center points. Finally, each parameter is normalized using (3.4) to have its range between -1 and +1. These normalized variables are used for formulating a Design of Experiments (DOE) cases. Table 3.3 shows the input variables for response surface model, both in the actual and normalized forms.

Table 3.3: Input Variables for Response Surface Metamodels

Random Structural Parameters	Input Variables	Lower Bound	Center Point	Upper Bound
Mass, m	ξ_1	4	8	12
	x_1	-1	0	+1
Strength, F_y	ξ_2	400	500	600
	x_2	-1	0	+1
Stiffness, k	ξ_3	50	80	110
	x_3	-1	0	+1

In order to make the response surface metamodel more efficient, the initial set of input parameters must be screened such that only the most influential input variables are used to construct the model. Even though the screening process is not overly essential in this particular example, as the initial set of inputs contains only 3 variables, it is still an important part of the response surface methodology and should not be overlooked. Such a screening process will be more crucial in the case when the number of input variables becomes unmanageable (5 or higher).

The contributions of each input variable to the response computation can be shown graphically by a Pareto plot [Montgomery, 1997]. Figure 3.10 shows such a plot for the 3 input variables in this example. The horizontal bars represent degrees of significance from the input variables. It is obvious from this figure that x_2 is the least influential parameter and can be screened out without making significant effect to the response prediction.

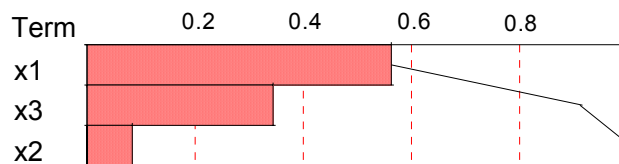

Figure 3.10: Pareto Plot of Input Variables for the SDOF System

PROJECT DS-5 FINAL REPORT

Past research identified the full factorial design (FFD) and the central composite design (CCD) as appropriate DOE for the response surface metamodel generation. Initial study has shown that both of the designs produce comparable results. However, the number of cases (or nonlinear time-history analyses) required to complete the FFD is significantly higher than the CCD. As a result, this research only considers the use of the CCD for a response surface formulation due to its efficiency.

An example of a DOE table for structural responses due to a specific scaled ground motion input (m02_10s scaled to $0.4g S_a$) is displayed in Table 3.4. The value of a maximum displacement listed for each case of DOE is obtained from the nonlinear time-history analysis of a SDOF system. There are a total of 9 different SDOF systems to be analyzed following the CCD for 2 input variables (x_1 and x_3). Each SDOF system has structural properties according to the corresponding DOE case and is subjected to single ground acceleration record. Using DOE case 9 as an example, the SDOF system in this case is composed of a spring with a stiffness of 110 kips/in and a lumped mass of 12 kip-sec²/in. A scaled ground acceleration record is applied to this system and the displacement at the mass level is computed at every time step. The maximum displacement (5.68 in) is extracted and recorded in the DOE table (Table 3.4) as a response quantity of this DOE case.

Table 3.4: DOE Table for SDOF Systems Subjected to m02_10s Accelerogram

Case	x_1	x_3	Actual Max Displacement (y), in.	Predicted Max Displacement (\hat{y}), in.
1	-1	-1	4.38	5.10
2	-1	0	3.25	2.22
3	-1	+1	2.22	2.53
4	0	-1	11.00	10.04
5	0	0	4.60	5.71
6	0	+1	4.74	4.59
7	+1	-1	13.60	13.84
8	+1	0	8.16	8.08
9	+1	+1	5.68	5.52

3.5.3.2 Response Surface Model Fitting

In approach 1, a response surface model predicts maximum displacement in a SDOF system due to a particular earthquake given levels of input variables (mass, damping coefficients, and stiffness). A second-degree polynomial function is chosen for a response surface model in this study. A typical response surface function for 3 input variables is in the form of

$$\hat{y} = b_0 + b_1x_1 + b_3x_3 + b_{11}x_1^2 + b_{31}x_3x_1 + b_{33}x_3^2$$

where \hat{y} is the predicted maximum drift and x_1 , x_2 , and x_4 are the input variables representing randomness in structural properties as shown in Table 3.3. Coefficients of a polynomial function are determined by the least-square regression analysis of the inputs (x 's) and responses (y) listed in the DOE table. The matrix of all coefficients (\mathbf{b}) can be obtained following (3.13) as

$$\mathbf{b} = \begin{bmatrix} b_0 \\ b_1 \\ b_3 \\ b_{11} \\ b_{31} \\ b_{33} \end{bmatrix} = \begin{bmatrix} 5.713 \\ 2.932 \\ -2.723 \\ -0.565 \\ -1.440 \\ 1.600 \end{bmatrix}$$

and the fitted response surface function can be rewritten as follows:

$$\hat{y} = 5.713 + 2.932x_1 - 2.723x_3 - 0.565x_1^2 - 1.44x_3x_1 + 1.6x_3^2 \quad (3.28)$$

It was found in this study that, unlike the early study of the response surface models [Bucher and Bourgund, 1990] which the cross terms were neglected, the cross term in this model is significant to the computation of the response and must be included for accuracy of the approximation. A comparison between the actual maximum drifts computed by the dynamic analyses (actual responses) and the maximum drifts predicted by the response surface model (predicted responses) is also shown in Table 3.4 for each case of the Design of Experiments. It is obvious from this table that the response surface is able to predict the maximum displacement due to an earthquake (m02_10s) reasonably well at the design points.

The coefficient of determination (R^2) and an adjusted- R^2 (R_A^2) for this model are 0.965 and 0.907, respectively. The high values of R^2 and R_A^2 obtained from this model indicates high association between the computed and the approximated maximum displacements at the design points.

The response surface is shown in Figure 3.11. For the purpose of illustration, the response (y) or maximum displacement is plotted against the two input parameters (x_1 and x_3) over their ranges. The two-dimensional illustrations of this response surface function can also be shown in Figure 3.12. In this plot, the response (y) is plotted against each of the input variables

PROJECT DS-5 FINAL REPORT

(x 's) while other input variables are held constant. The plot shows how the response computation changes with the input variables over its range.

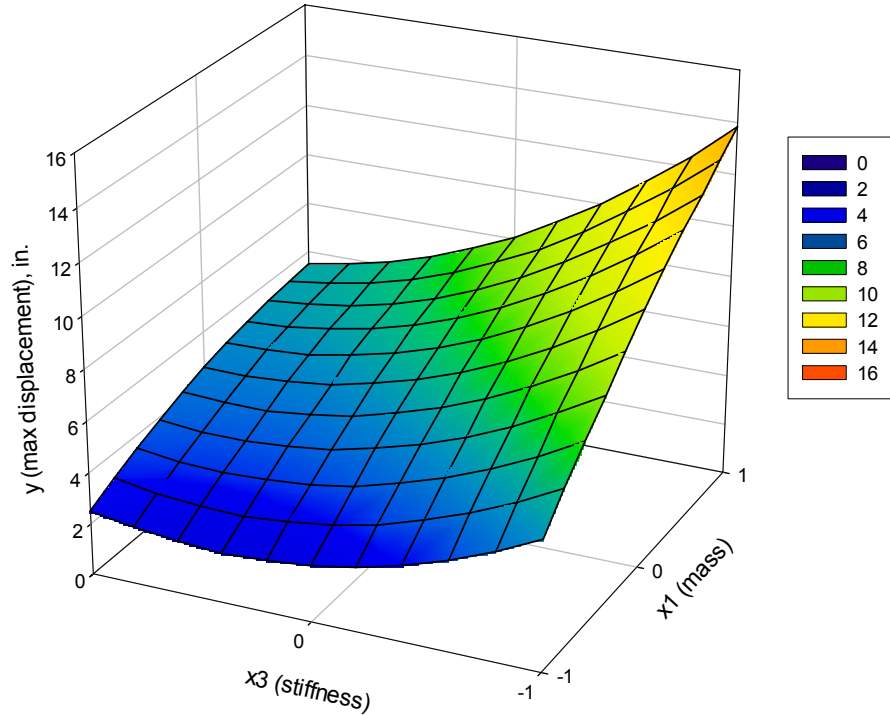

Figure 3.11: Response Surface of y as a function of x_1 and x_3

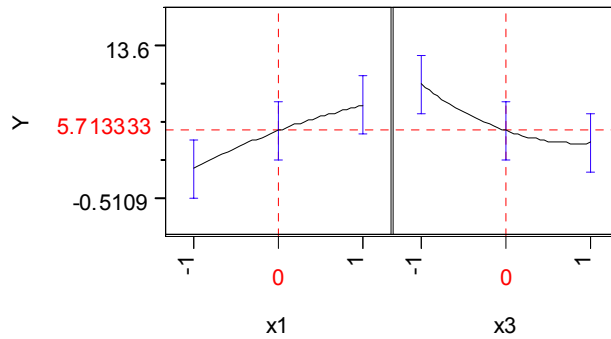

Figure 3.12: Prediction Profiler of a Response Surface Model

The response surface shown previously is contingent on a particular ground motion (m02_10s). The process of generating response surface models must be repeated for all other

ground acceleration records, which have the same intensity level, in the suite. This results in 60 different response surface functions (\hat{y}_1 to \hat{y}_{60}) for all of the 60 earthquake records in the suite.

The main purpose of this section is only to demonstrate the process of using the response surface metamodels in damage probability calculation. Model checking and validation are not performed for this example. Chapters 4, 5, 6 and 7 of the report, which implement the approaches to real structures, provide model validation in great detail.

3.5.3.3 Response Simulation

A response surface metamodel using Approach 1 approximates the maximum displacements of a SDOF system due to a given ground acceleration record from a set of known structural properties. However, the earthquake loading cannot be predicted with certainty. As a result, structural response or maximum displacement cannot be calculated with exactness without taking uncertainties in seismic loading into account. These uncertainties are taken care of by a random selection of a response surface model from a pool of all earthquake-specific models (\hat{y}_1 to \hat{y}_{60}). Random samplings are performed over a large number (10,000) of trials resulting in 10,000 values of maximum displacement. Frequency and cumulative frequency plots of the maximum displacement are shown in Figure 3.13.

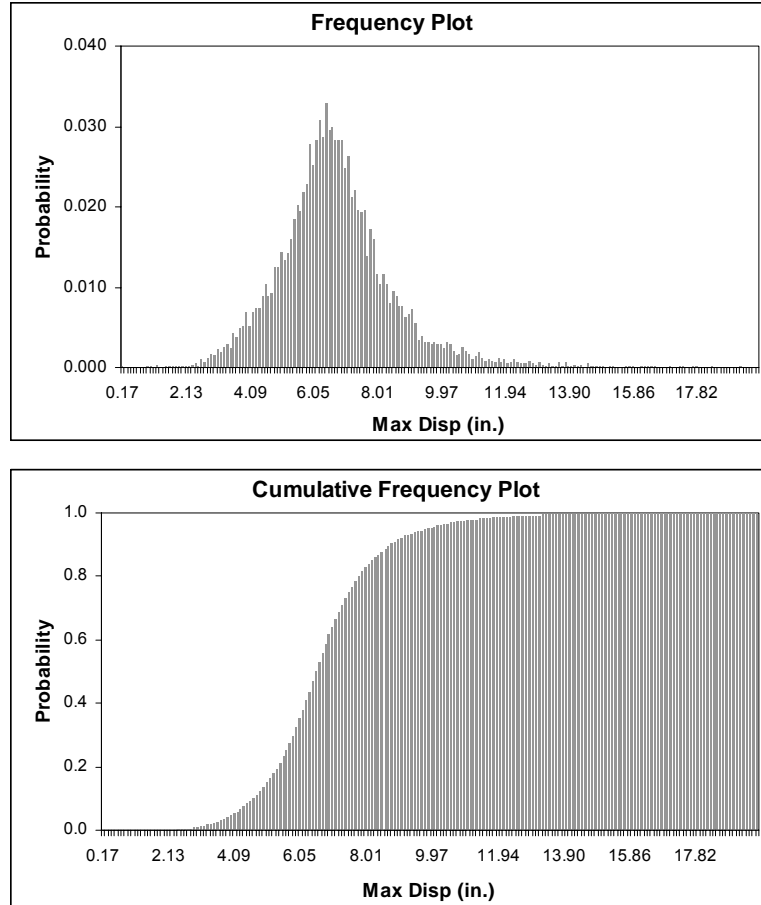

Figure 3.13: Frequency and Cumulative Frequency Plots for Maximum Displacement of a SDOF System

The probability of exceeding limit states for this particular level of seismic intensity ($S_a = 0.4g$) or fragility can be calculated by the ratio between the number of times the computed maximum displacements exceed the limit state thresholds and the total number of simulation trials (10,000 trials). For example, assuming that a damage threshold is defined by a maximum displacement of 8 in., the fragility of this SDOF system for a hazard level of $0.4g S_a$ is computed by

$$PF = \frac{1}{10,000} \cdot \sum_{i=1}^{10,000} I(D_i \geq 8 \text{ in.}) = \frac{1724}{10000} = 0.1724$$

I is an indicator function giving a value of 1 if the condition ($D_i \geq 8$ in.) is met, and 0 otherwise. D_i is the maximum displacement value computed by the response surface function of input variables from the i^{th} simulation.

3.5.4 Approach 2

Approach 2 overcomes an inefficient process of generating response surface models for individual ground motion records in Approach 1. Instead, the response surface models in this approach independently predict the mean and standard deviation of the maximum displacements due to all acceleration records in a suite. The overall metamodel includes a term representing an expected response and a term taking into account a record-to-record dispersion, and consequently incorporates uncertainties in seismic loadings.

3.5.4.1 Design of Experiments

Similar to Approach 1, the input variables for the response surface model in Approach 2 are those structural properties (Table 3.3) that are most influential to the response computation (*i.e.*, x_1 and x_3). However, the output variables in this approach are the mean and the standard deviation of the maximum displacements calculated from 60 ground motions.

A combination of parameter levels in each DOE case symbolizes a SDOF system with a specific set of structural properties. In approach 2, each SDOF structure (or DOE case) is subjected to all 60 ground motions in the suite. The maximum displacement due to each ground acceleration input is recorded. It is assumed that the seismic responses given a specific S_a are normally distributed. This assumption is validated by fitting a set of maximum displacements computed from a suite of records to a Normal distribution [Ang and Tang, 1975]. Figure 3.14 shows that the normality assumption is valid for the set of maximum displacements. The mean value and standard deviation obtained from the fitted distribution are used as the output variables for the response surface models (y_μ and y_σ , respectively). Computation of mean and standard

deviation of the responses is repeated for all other DOE cases and the DOE table is formed, as shown in Table 3.5 **Error! Reference source not found.**

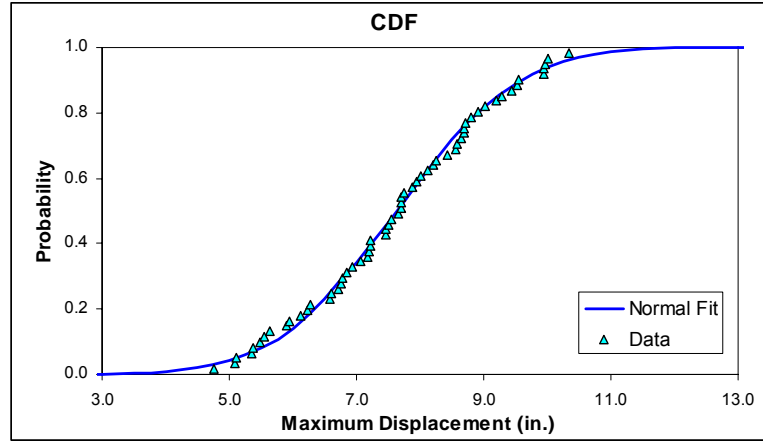

Figure 3.14: Normal Probability Distribution Fit of Maximum Displacements due to a Suite of Earthquakes at a Given Level of S_a

Table 3.5: DOE Table for SDOF Systems subjected to a Suite of Accelerograms

Case	x_1	x_3	y_1 (in.)	y_2 (in.)	...	y_{60} (in.)	Mean (y_μ)	Std Dev (y_σ)
1	-1	-1	4.34	2.39	...	7.53	6.28	3.04
2	-1	0	4.92	2.32	...	3.70	4.39	2.72
3	-1	+1	4.11	2.81	...	4.79	3.56	2.17
4	0	-1	5.29	9.42	...	6.31	6.05	2.02
5	0	0	6.35	4.62	...	6.00	4.42	2.15
6	0	+1	3.34	2.73	...	5.35	4.01	1.64
7	+1	-1	7.24	5.39	...	8.34	6.01	2.01
8	+1	0	5.44	8.34	...	6.02	4.33	1.88
9	+1	+1	5.22	6.01	...	5.96	4.82	0.96

3.5.4.2 Response Surface Model Fitting

Response surface polynomial functions of the mean and standard deviation of the maximum displacements for a given level of S_a ($S_a = 0.4g$) are generated in the same fashion as in Approach 1. Again, the model for 4 input variables can be expressed in the form of

$$\hat{y} = b_0 + b_1x_1 + b_3x_3 + b_{11}x_1^2 + b_{31}x_3x_1 + b_{33}x_3^2$$

The polynomial coefficients are estimated using (3.13) where the matrix \mathbf{Z} is similar to that presented in Approach 1. The dual responses y_μ and y_σ , in a matrix form, can be written as

$$\mathbf{Y}_\mu = \begin{bmatrix} 6.28 \\ 4.39 \\ 3.56 \\ \vdots \\ 4.82 \end{bmatrix} \begin{matrix} \text{Case 1} \\ \text{Case 2} \\ \text{Case 3} \\ \vdots \\ \text{Case 9} \end{matrix}$$

and

$$\mathbf{Y}_\sigma = \begin{bmatrix} 3.04 \\ 2.72 \\ 2.17 \\ \vdots \\ 0.96 \end{bmatrix} \begin{matrix} \text{Case 1} \\ \text{Case 2} \\ \text{Case 3} \\ \vdots \\ \text{Case 9} \end{matrix}$$

respectively.

Least-square regression analyses of the matrix of generalized input variables (\mathbf{Z}) against both matrices for the output variables (\mathbf{Y}_μ and \mathbf{Y}_σ) result in response surface polynomial functions for \hat{y}_μ and \hat{y}_σ as follows:

$$\hat{y}_\mu = 4.332 + 0.155x_1 - 0.992x_3 + 0.072x_1^2 - 0.383x_3x_1 + 0.742x_3^2 \quad (3.29)$$

and

$$\hat{y}_\sigma = 2.121 - 0.513x_1 - 0.383x_3 + 0.193x_1^2 - 0.045x_3x_1 - 0.277x_3^2 \quad (3.30)$$

The model for the mean response has R^2 and R_A^2 of 0.984 and 0.958, while the model for the standard deviation has R^2 and R_A^2 of 0.951 and 0.868, respectively. Both models exhibit high correlation between the actual maximum displacements and those that are approximated by the metamodels.

3.5.4.3 Response Simulation

In Approach 2, separate response surface models for the mean and standard deviation of maximum displacements of the SDOF system due to all 60 ground motions were generated. The overall metamodel is composed of the two response surface models, \hat{y}_μ and \hat{y}_σ . Following the normality assumption, the metamodel can be mathematically expressed as

$$\hat{y} = \hat{y}_\mu + N[0, \hat{y}_\sigma] \quad (3.31)$$

In this model, the first term predicts an expected or a mean value of the maximum displacements due to a suite of ground motions, while the second term represents the earthquake-to-earthquake dispersion in response computation and consequently incorporates randomness in earthquake excitations. In order to simulate the probability density of the maximum displacements, distributions of the input variables are defined (Table 3.2). The basic Monte Carlo sampling technique selects values of input variable corresponding to their probability distributions. A combination of the input variables in each simulation step reflects a SDOF system with properties corresponding to the selected input values. The maximum displacement is approximated by evaluating both response surface models (\hat{y}_μ and \hat{y}_σ) and combining them according to (3.31). A schematic view of the each simulation step is shown in Figure 3.15. The response surface is shown here, for simplicity, as a 2-dimensional plot between y and x_3 . As an example, let a be a value that is randomly selected from the uniform distribution of x_3 . The

responses \hat{y}_μ and \hat{y}_σ are evaluated for $x_3 = a$ and the maximum displacement for this simulation step can be computed as

$$\hat{y}(x_3 = a) = \hat{y}_\mu(x_3 = a) + N[0, \hat{y}_\sigma(x_3 = a)]$$

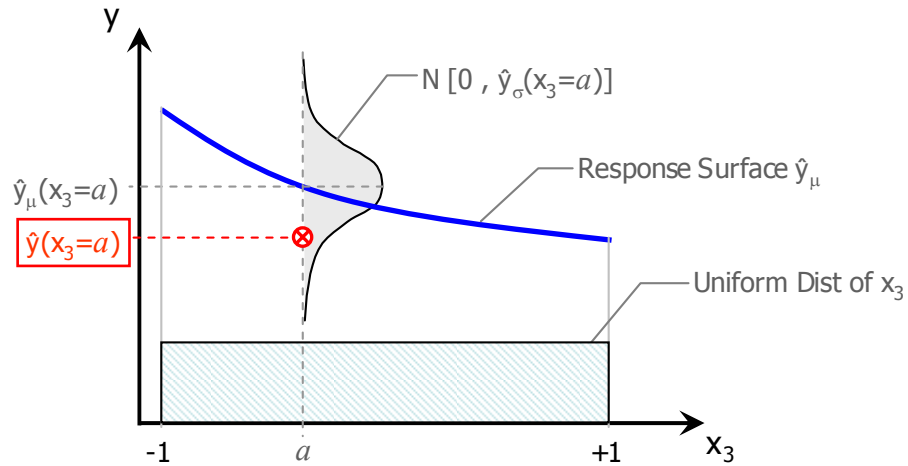

Figure 3.15: Illustration of Simulation Process in Approach 2

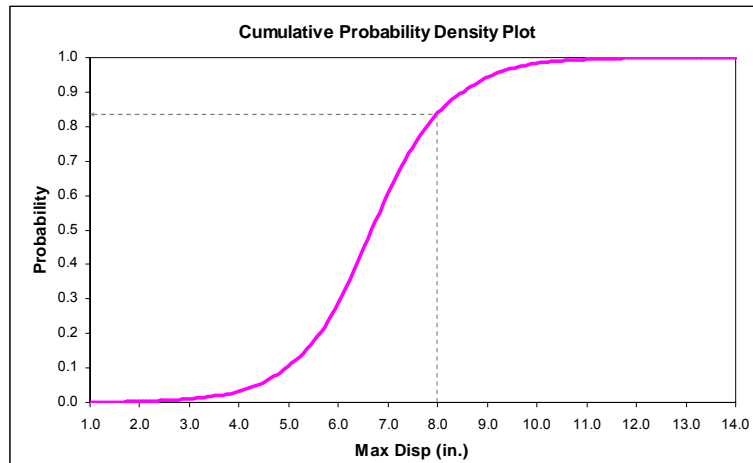

Figure 3.16: Cumulative Probability Density of Maximum Displacements by Approach 2

In this example, repeated random combinations were performed 10,000 times to produce response statistics of the maximum displacement (\hat{y}). A cumulative frequency (or cumulative

density) plot is shown in Figure 3.16. Damage probability for an 8-inch displacement threshold conditioned on the spectral acceleration value of 0.4g is calculated to be 0.1706.

3.5.5 Approach 3

A major drawback in Approach 1 and Approach 2 is that the response surface models are generated for specific levels of earthquake intensity. A need for repetitive analyses with increasing S_a levels for a complete fragility curve requires extensive computational cost. Approach 3 is proposed to forego this process by including the seismic intensity parameter as one of the predictors in the response surface models. The metamodel in this case can be used for computing damage probabilities at any levels of S_a within the predefined range.

3.5.5.1 Design of Experiments

In Approach 3, the input variables in the response surface model are composed of 2 components, random variables and a control variable. Random variables are those that define uncertainties in structural properties including mass (x_1) and stiffness (x_3) of the SDOF system. On the other hand, the control variable is deterministic with its fixed values characterizing different response prediction models. The control variable in this case is the spectral acceleration (S_a) that defines earthquake intensity level (referred to as x_{EQ}). Evaluation of response surface at different values of S_a yield models for predicting maximum displacement due to specific levels of S_a .

For constructing a response surface model, the control variable is treated in a similar way as other random variables. The lower bound, center point, and upper bound of the control variable S_a must be defined. In this example, the values of 0.1g and 0.7g characterize the boundary of variable range for S_a while the value of 0.4g defines the center point (Table 3.6). Three batches of 60 scaled ground motions are generated. The first batch contains accelerograms

PROJECT DS-5 FINAL REPORT

with spectral acceleration values scaled to 0.1g representing a lower bound case. The second and third batches are scaled to the center point and upper bound, correspondingly.

A Central Composite Design (CCD) is utilized to formulate 15 combinations of 3 input variables as shown in Table 3.7. The variables x_1 , x_2 , and x_4 describe structural properties for a SDOF system, while x_{EQ} indicates the level of S_a and, in turn, the batch of acceleration records to use for the analysis. For example, in case 1, the SDOF system has a mass of 4 kip-sec²/in and a spring stiffness of 50 kip/in. This particular system is subjected to a suite of ground motions that are scaled to have a spectral acceleration of 0.1g (or the first batch). A maximum displacement resulting from nonlinear time-history analysis is recorded for each ground motion. A normality assumption is again made for the distribution of the maximum displacements. The mean and the standard deviation values for this particular case are extracted from the fitted distribution.

Table 3.6: Input Variables for a Response Surface in Approach 3

Random Structural Parameters	Input Variables	Lower Bounds	Center Points	Upper Bounds	Units
Mass, m	ξ_1	4	8	12	kip-sec ² /in
	x_1	-1	0	+1	-
Stiffness, k	ξ_3	50	80	110	kip/inch
	x_3	-1	0	+1	-
Spectral Acceleration, S_a	ξ_{EQ}	0.1	0.4	0.7	g
	x_{EQ}	-1	0	+1	-

Table 3.7: Design of Experiments Table for Approach 3

Case	x_1	x_3	x_{EQ}	y_1 (in.)	y_2 (in.)	...	y_{60} (in.)	Mean (y_μ)	Std Dev (y_σ)
1	-1	-1	-1	2.25	2.80	...	1.79	2.07	0.76
2	-1	-1	+1	14.70	17.89	...	11.78	12.73	4.32
3	-1	0	0	6.57	4.57	...	6.19	5.56	2.17
4	-1	+1	-1	1.06	0.90	...	0.96	1.31	0.61
5	-1	+1	+1	8.79	6.08	...	7.54	10.22	3.76
⋮	⋮	⋮	⋮	⋮	⋮	⋮	⋮	⋮	⋮
14	+1	+1	-1	1.38	1.67	...	1.28	1.46	0.11
15	+1	+1	+1	9.65	11.83	...	8.97	10.26	1.05

3.5.5.2 Response Surface Model Fitting

Similar to the previous approaches, the mean and standard deviation of the maximum displacements are approximated by second-degree polynomial functions. Five input variables are used in the models to describe the response computation. The coefficients of the polynomial are derived using (3.13) and the response surface models for the mean (\hat{y}_μ) and standard deviation (\hat{y}_σ) of the response can be expressed as follows:

$$\begin{aligned} \hat{y}_\mu = & 6.68 + 0.513x_1 - 0.901x_3 + 4.871x_{EQ} - 0.426x_1^2 + \\ & 0.43x_3x_1 + 0.473x_3^2 + 0.324x_{EQ}x_1 - 0.75x_{EQ}x_3 - 0.163x_{EQ}^2 \end{aligned} \quad (3.32)$$

and

$$\begin{aligned} \hat{y}_\sigma = & 1.622 - 0.038x_1 - 0.713x_3 + 1.314x_{EQ} + 0.441x_1^2 - \\ & 0.442x_3x_1 + 0.913x_3^2 - 0.058x_{EQ}x_1 - 0.563x_{EQ}x_3 - 0.438x_{EQ}^2 \end{aligned} \quad (3.33)$$

3.5.5.3 Response Simulation

Response surface models constructed in Approach 3 are unconditional of specific levels of earthquake intensity. Evaluation of the polynomial functions for different values of the control variable x_{EQ} (normalized form of S_a) produces models for response prediction at specific intensity levels. Monte Carlo simulation is then carried out over the metamodels of random variables for response statistics derivation.

Damage probability conditioning to a particular S_a value of $0.4g$ is computed here for consistent comparison with results from Approach 1 and Approach 2. A normalized form of S_a that is employed in the response surface models can be calculated according to (3.4) as follows:

$$x_{EQ} = \frac{0.4g - \frac{0.7g + 0.1g}{2}}{\frac{0.7g - 0.1g}{2}} = 0$$

Consequently, the response surface models of a mean and standard deviation of maximum displacements for a spectral acceleration of $0.4g$ are obtained by substituting $x_{EQ} = 0$ in (3.32) and (3.33) and, hence, they become

$$\hat{y}_{\mu|S_a=0.4g} = 6.68 + 0.513x_1 - 0.901x_3 - 0.426x_1^2 + 0.43x_3x_1 + 0.473x_3^2 \quad (3.34)$$

and

$$\hat{y}_{\sigma|S_a=0.4g} = 1.622 - 0.038x_1 - 0.713x_3 + 0.441x_1^2 - 0.442x_3x_1 + 0.913x_3^2 \quad (3.35)$$

The overall metamodel takes the form of (3.31) in which a normality assumption on the distribution of maximum displacement is exercised. Simulation is performed by randomly selecting values for input variables under their probability density assumptions and calculating responses from the models. Ten thousand simulated cases result in a cumulative frequency or probability density plot, as shown in Figure 3.17. Assuming that the damage threshold of the

maximum displacement is 8 inches, damage probability of this SDOF system, subjected to earthquake intensity of 0.4g, is 0.1823.

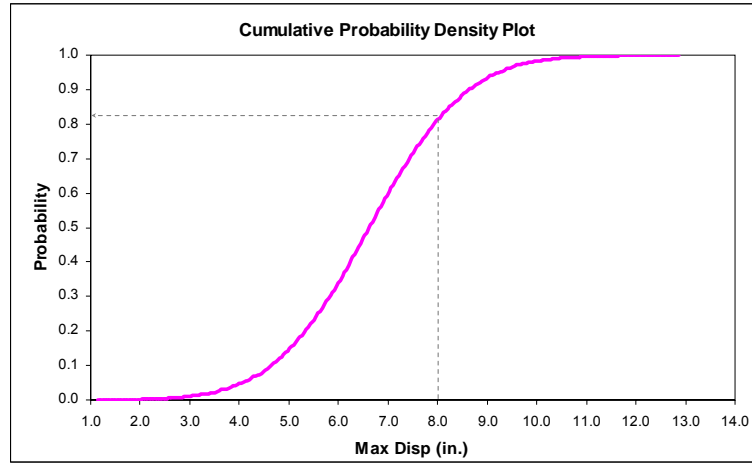

Figure 3.17: Cumulative Probability Density of Maximum Displacements by Approach 3

3.5.6 Benchmark Case: Direct Monte Carlo Simulation

The three proposed approaches perform Monte Carlo simulation through an approximated metamodel to generate statistics of the seismic response. Cumulative density plots of the maximum displacement produced by the 3 approaches are found to be very similar (Figure 3.18a). Further comparison with conventional methods must also be performed to ensure reliability of the proposed approaches.

In order to verify the use of the metamodels in fragility analysis, a benchmark case using direct Monte Carlo simulation (MCS) is developed. The term “direct” refers to the process of carrying out a Monte Carlo simulation directly on a structural analysis model rather than a simplified metamodel. The structural property parameters that are selected corresponding to their probabilistic descriptions are combined at random to generate a large number of SDOF systems (10,000 systems in this example). Based on an assumption that earthquakes in a suite are equally likely to occur, ground motion records are randomly selected (with replacement) to pair with the 10,000 SDOF systems. Nonlinear dynamic analysis is performed on each earthquake-structure

PROJECT DS-5 FINAL REPORT

combination and the maximum displacement is extracted. A cumulative frequency plot is constructed from 10,000 values of maximum displacement from the dynamic analyses.

It is assumed again that the damage threshold of the maximum displacement is 8 inches; the damage probability of this SDOF system, subjected to earthquake intensity of 0.4g, is 0.1603.

Cumulative probability distribution of the maximum displacement from the benchmark case is compared with those obtained from Approach 1, Approach 2, and Approach 3 (Figure 3.18b, Figure 3.18c, and Figure 3.18d, respectively). It was found that each of the proposed approaches is able to produce results similar to those from the benchmark case. This demonstrates that the use of response surface metamodels can be adequate for the fragility analysis of a structure. It should also be noted that even for a very simple SDOF system, Monte Carlo simulation on the dynamic analyses of the structures is still computational expensive. The task of response simulation would be impossible to accomplish for much more complex structural systems.

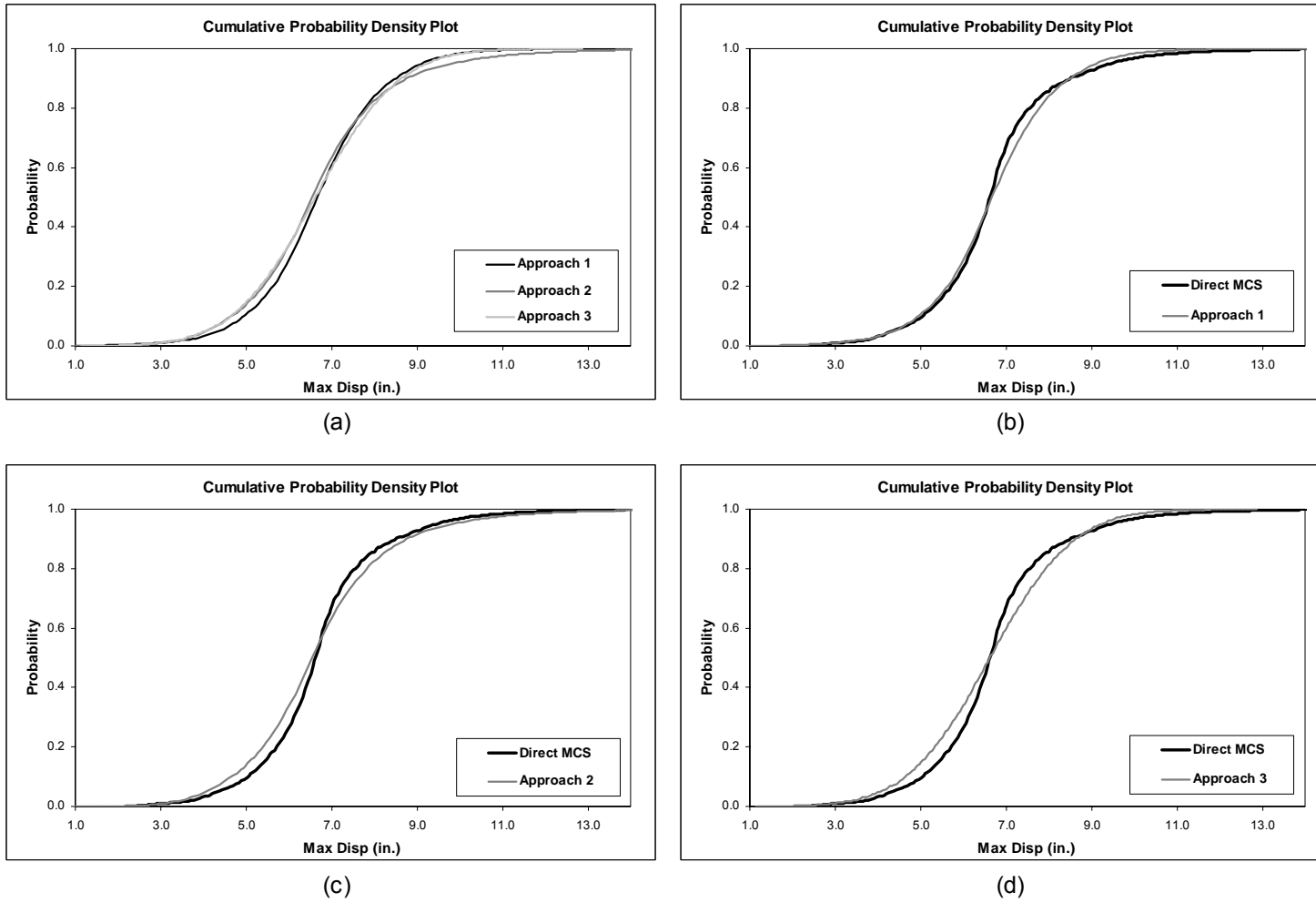

75

Figure 3.18: Comparison of Cumulative Probability Density Plots: (a) Between the 3 Approaches, (b) Approach 1 vs Direct MCS, (c) Approach 2 vs Direct MCS, and (d) Approach 3 vs Direct MCS

PROJECT DS-5 FINAL REPORT

The added value of using metamodels is due to their efficiency. Significant reduction in computational efforts is achieved from using the proposed approaches. Table 3.8 presents a comparison on the number of dynamic analysis cases required by different approaches. A comparison is first made on the number of cases for calculating damage probabilities at a given intensity level. In the proposed approaches, central composite design generates 9 and 15 structural combinations for the 2 and 3 input variables, respectively. Sixty ground acceleration records are used to represent an uncertainty from seismic loadings. Dynamic analyses of structural combinations with all ground acceleration records construct metamodels which are used in the response simulation. Second, in order to complete a fragility curve, damage probabilities at other intensity levels are also needed. Further comparison on the total number of dynamic analysis for repetitive process over different levels of intensity is made. For this comparison, it is assumed that 10 intensity levels are desired for a fragility curve derivation. The total number of analysis cases is obtained by a multiplication of 10 to the number of cases required at each given intensity level. However, Approach 3 does not require any further analysis case since the metamodel in this approach is not specific to a particular intensity level and the damage probabilities can be computed by evaluating the existing metamodels at different values of intensity measure. It is apparent that while the proposed approaches using response surface metamodels produce outcomes similar to a conventional method, they are computationally much more efficient.

Table 3.8: Comparison of Number of Analysis Required by Different Approaches

Approaches	Number of Dynamic Analysis Required	
	For Damage Probability at a Specific	For Fragility Curve Generation
Direct MCS	10,000	100,000 [‡]
Approach 1	$9^* \times 60^\dagger = 540$	5,400 [‡]
Approach 2	$9^* \times 60^\dagger = 540$	5,400 [‡]
Approach 3	$15^* \times 60^\dagger = 900$	900

* Number of cases from the Central Composite Design

† 60 ground acceleration records in a suite

‡ 10 levels of earthquake intensity used for generating fragility curves

3.5.7 Effects from the Number of Earthquakes

At this point in the development, a suite of 60 accelerograms has been utilized for capturing uncertainty arising from earthquake loadings to the structures. It has been suggested, however, that fewer numbers of records might be used [Song and Ellingwood, 1999], [Shinozuka *et.al.* 2000a, 2000b]. A study was next performed to assess the effect of the number of accelerogram used in a fragility analysis. In particular, only one-third of the original suite (20 accelerograms) is used in the process of establishing metamodels and the results are observed. Figure 3.19 shows a comparison of the cumulative probability distribution plots of the maximum displacements obtained from the process that utilize 60 and 20 ground acceleration records. It can be seen from these plots that the reduction in the number of records to 20 does not present a significant discrepancy from the original case that uses 60 records. By using a smaller number of ground motions, the number of dynamic analysis required for completing a fragility curve can be reduced to one-third of the original values shown in Table 3.8. Based on this finding, a suite of 20 accelerograms will be used as a basis for generating metamodels in subsequent chapters.

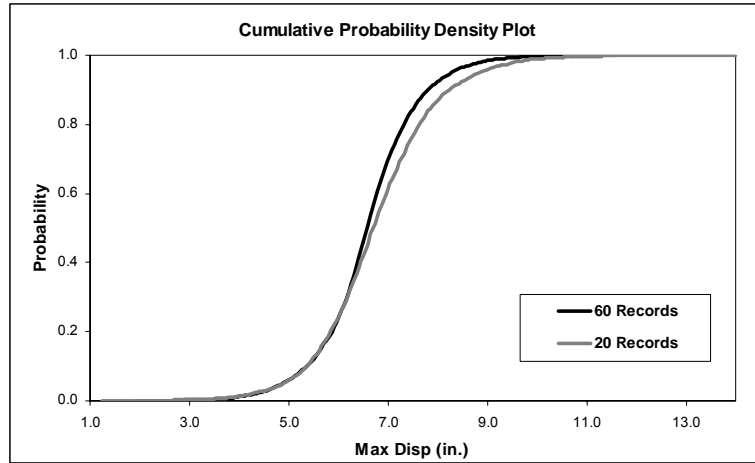

Figure 3.19: Effect of Number of Acceleration Records on Cumulative Distribution of Maximum Displacements

The method of using response surface metamodells in fragility calculation has been shown to be efficient in a simple test case. Implementations of this approach in real structures are carried out and described in the subsequent chapters.

CHAPTER 4

FRAGILITIES OF BUILDING COLLECTIONS USING 2D MODEL

The use of response surface metamodels for computing seismic fragilities was shown in the previous chapter to be accurate and efficient for a simple SDOF test case. Focus is now shifted to an implementation of the approaches for assessing the seismic fragilities of more realistic structures using 2D structural models for the seismic analysis. Three applications are considered: (1) fragility of a two-story unreinforced masonry (URM) building typical of firehouse (*i.e.*, an essential facility) construction, (2) the rehabilitated URM building upgraded using passive damping devices, and (3) three-story moment resisting frame buildings typical of construction in Mid-America.

The majority of earthquake engineering research focuses on problems arising in areas of the world with high seismic activity, and much less attention is directed at hazard mitigation in areas where the recurrence interval for large earthquakes is much longer but the inventory of at-risk structures may be far greater. The low-probability high-consequence problem exists in many regions of the U.S., where the infrequency of damaging earthquakes has been wrongly interpreted as low risk. The New Madrid seismic zone (NMSZ) is regarded as the most hazardous seismic zone in the central United States (referred to as Mid-America in this study). The series of earthquake events during 1811 and 1812 in New Madrid, Missouri are considered among the largest earthquakes to have occurred in the contiguous United States. However, due to the infrequent nature of major earthquakes in this region, most existing buildings in the region were designed only for gravity and wind loads. The consequences of earthquakes, especially major events that would affect a large part of Mid-America, have been largely neglected.

4.1 Typical URM Structures in Mid-America

Typical URM essential facilities in Mid-America are relatively small and low-rise (one or two-story in height). The building is composed of 2 main components: the URM bearing walls and the floor and roof diaphragms. The walls are generally stiff and constructed with many openings for windows and doors. Walls with openings are referred to as perforated walls. The diaphragms are usually constructed of timber and, as a result, are much more flexible than the walls.

A benchmark building is selected as a representation of existing URM low-rise buildings in Mid-America. The building was designed and constructed for an experimental research (Yi *et.al.* [2002] and Yi [2004]) conducted at Georgia Tech to determine the lateral load resistance of a URM building (Figure 4.1). The full-scale 2-story test building was designed to represent a typical construction of an existing URM firehouse in Mid-America. Four unreinforced masonry walls, referred to as wall A, wall B, wall 1, and wall 2, define the test structure. The detailed dimensions of each wall and a plan view are shown in Figure 4.2. The building is 24 feet by 24 feet in plan and has story heights of 12 feet and 10 feet for the first and second stories, respectively. Wall A and, on the opposite side, wall B are of the same configuration. Wall 1 only has a door on the first floor and two window openings on the second floor. On the other hand, wall 2 has a large door opening in the bottom floor designed to represent a fire apparatus entrance.

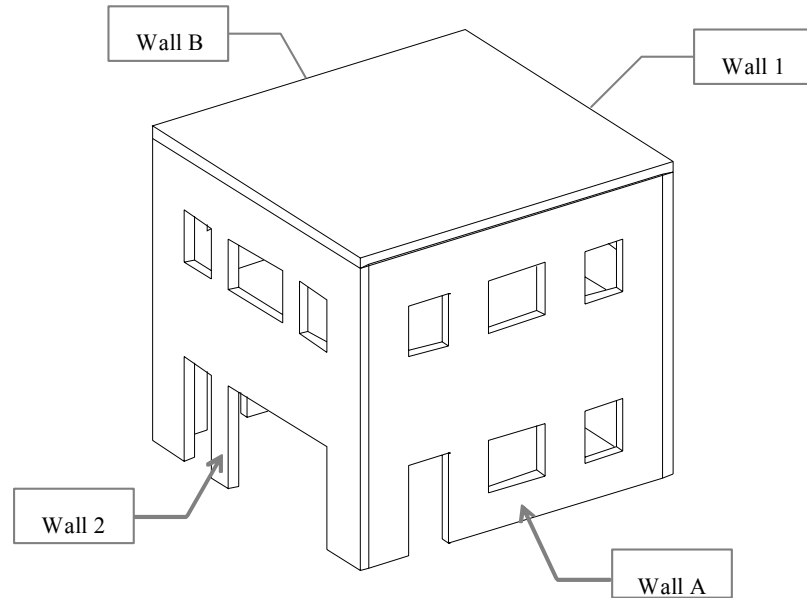

Figure 4.1: Typical Low-Rise URM Building in Mid-America

Material properties are obtained from the experimental studies (Yi *et.al.* [2002] and Yi [2004]). In this experiment, masonry prism specimens and 4-brick specimens are constructed for material tests. Basic properties are listed in Figure 4.2.

Table 4.1: Basic Material Properties for the URM Test Structure

Properties	Mean Values
Masonry Density (lb/in ³)	0.06944
Masonry Compressive Strength (psi)	1458
Masonry Elastic Modulus (ksi)	600
Masonry Bed-Joint Shear Strength	60

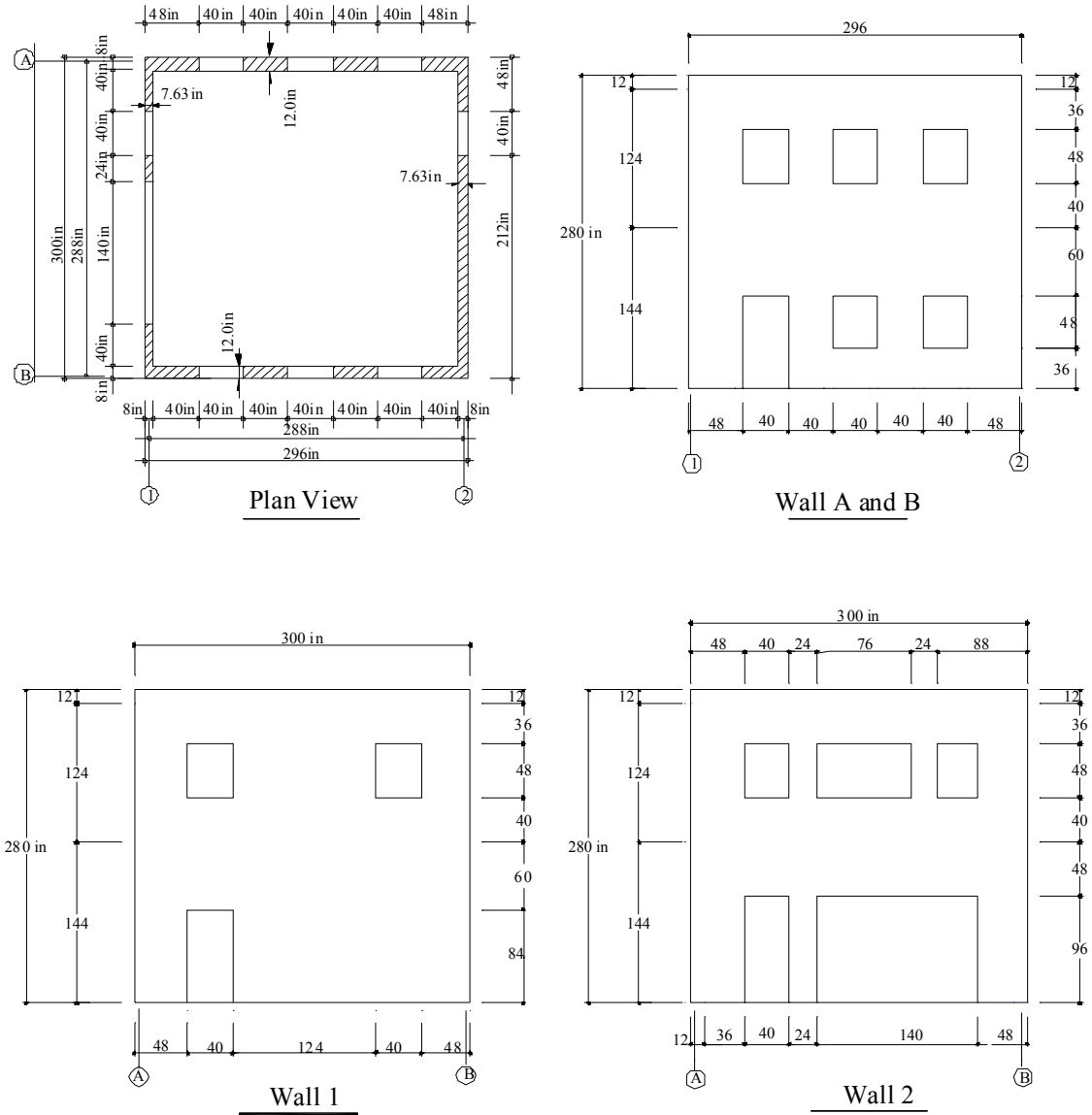

Figure 4.2: Detailed Dimensions of the Test Structure

4.1.1 Modeling URM Buildings

Unreinforced masonry is a non-homogeneous material made up of 2 components: the masonry bricks and the mortar. URM properties are dependent upon the properties of its constituents. Structural behavior of the URM can be very complex even under static loadings. The most refined approach for analyzing a URM wall is the so-called brick-by-brick approach

which models individual masonry brick as a solid element connecting to each other by the interface elements representing the mortar. However, for the purpose of seismic fragility analysis of the URM building, repeated dynamic analyses are required and this approach can quickly become impractical. As a result, a more tractable structural model is needed in this study.

4.1.1.1 2D Versus 3D Analyses

Under earthquake excitation, the particular direction of seismic loading cannot be anticipated. It is unlikely that the actual earthquake loading will be in a direction aligned to the building axes. In addition, many real buildings have irregular layouts that can result in a structure that behaves in complex three-dimensional ways under seismic loadings. Therefore, three-dimensional analysis should produce a more accurate description of the behavior of the structure, and this might include torsional responses due to asymmetry of the rigidity and mass distributions of each component with respect to the loading direction. However, in the interest of achieving a simpler model for dynamic analysis, the models developed in this first application are based on two-dimensional behavior only. The 2D model presented in this study is simple enough for repetitive dynamic analyses, yet is able to capture most of the important nonlinear behaviors of the wall components and the diaphragms. Chapter 5 extends the methodology to 3D structural models.

4.1.1.2 URM Building Components

The two-dimensional analysis model for a URM building computes building response due to an earthquake input in a single horizontal direction. Building components are defined as being either in-plane or out-of-plane, depending on their orientation relative to the loading direction.

URM In-Plane Walls

Building walls that are oriented parallel to the loading direction are referred to as in-plane walls. URM walls usually develop high initial elastic stiffness in the in-plane direction resulting in a high elastic stiffness and low elastic structural period of URM buildings. The overall nonlinear behaviors of the in-plane perforated walls are dominated by behaviors of different components and their arrangement in the wall. A perforated wall can be subdivided into wall components between openings (see Figure 4.4). Each individual component (referred to as a wall pier) behaves in a similar fashion as a solid URM wall. There are four kinds of in-plane failure mode for the monolithic URM walls when subjected to lateral loadings. The type of failure mode is dependent primarily on the masonry strength, aspect ratio of the wall component, and the vertical compressive stress on the wall. The four types of in-plane failure mode can be summarized as follows [FEMA, 1997].

(a) *Rocking failure* (Figure 4.3a): As horizontal load or displacement demand increases, bed-joint cracks in tension, and shear is carried by the friction of compressed masonry at the toe. The final failure occurs the wall overturns about its toe.

(b) *Bed-joint sliding* (Figure 4.3b): Due to the formation of horizontal tensile cracks in the bed-joints, subjected to reversed seismic action, potential sliding planes can form along the cracked bed-joints. This failure mode is possible for low levels of vertical load and/or low friction coefficients.

(c) *Diagonal tension cracking* (Figure 4.3c): Peak resistance is governed by the formation and development of inclined diagonal cracks, which may follow the path of bed and head joints in a stair-step pattern or may go through the bricks in a straight diagonal path, depending on the relative strength of mortar joints, brick-mortar interface, and bricks.

(d) *Toe crushing* (Figure 4.3d): When the strength, as limited by toe compression stress, is less than the strength determined by rocking, the wall undergoes a sudden failure due to the crushing of the toe.

Strengths of the URM wall corresponding to each failure mode are derived in FEMA [2000a] and will be discussed later in this chapter.

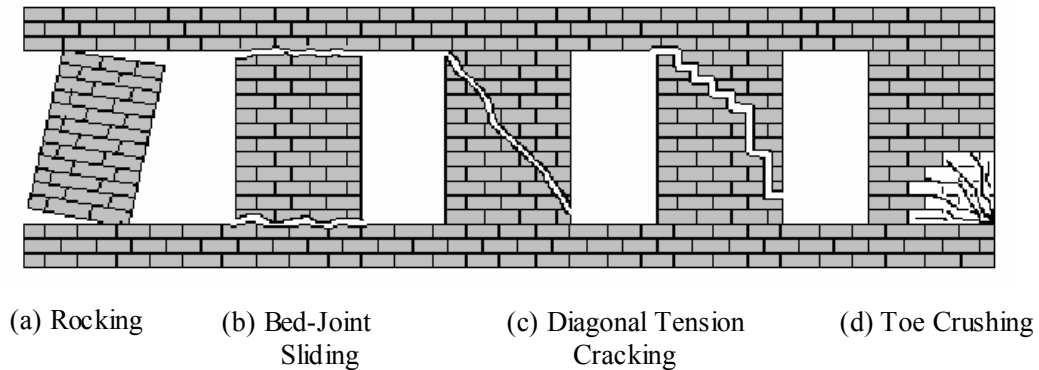

Figure 4.3: Four Failure Modes of URM In-Plane Walls [Yi, 2004]

URM Out-of-Plane Walls

Contrary to the in-plane wall, the out-of-plane wall is the building wall that is perpendicular to the direction of the earthquake inputs. Its lateral stiffness is significantly lower than that of the in-plane wall. Out-of-plane failures are generally quite brittle unless significant compressive loads are present. Failure or even collapse of the out-of-plane walls under earthquakes is imminent if the connections between the out-of-plane walls and the diaphragms and/or the in-plane walls are not well constructed.

Floor and Roof Diaphragms

The floors and roof diaphragms of a URM building in the region are typically constructed of timber joists and sheathings. The use of timber as a construction material makes the diaphragms much more flexible than the supporting masonry walls. Timber diaphragms have large deformation capacity and high strength relative to its mass [Yi, 2004]. Failure of the

diaphragm itself usually has not been a major concern under earthquake loadings. However, the connection between the diaphragms and the supporting walls are sometimes the weak points. Improper design and construction of diaphragm connection can even trigger failures in other components such as out-of-plane walls. Even though it has been realized that the connections are an important issue in the URM buildings, the precise manner of this connection is often quite difficult to assess and to model. For the interest of a simpler dynamic model for the URM building, the connections between the diaphragms and the masonry walls are assumed rigid in this research.

4.1.1.3 Component-Level Modeling

As mentioned in previous section, this research only focuses on two-dimensional responses of the URM test structure. Earthquake loadings should be applied to the building in the direction that the three-dimensional effects are prevented. Figure 4.2 shows that the configurations of wall 1 and wall 2, which are parallel to each other, are significantly different. This indicates a major difference in terms of the lateral stiffness between the two walls. As a result, torsional effects will be developed if the seismic load is applied in the in-plane direction to wall 1 and wall 2. On the other hand, wall A and, on the opposite side, wall B are constructed with identical configuration. Lateral load applied in the in-plane direction of wall A and B is less likely to cause major torsional deformation in the URM test structure. Based on these observations, earthquake inputs are restricted only in the direction parallel to wall A and wall B in this study. With this loading direction, wall A and wall B consequently become in-plane walls, while wall 1 and wall 2 are out-of-plane walls.

In-Plane Wall Modeling

While solid URM walls exhibit a very stiff linear elastic behavior for in-plane loading, the walls will ultimately fail through a fracture process that can involve diagonal cracking or bed joint fracture and sliding. Perforated walls can exhibit much more complex behavior that is

associated with localized failures in the masonry piers, lintels and spandrels. For these cases, the behavior can range from essentially ductile behavior developed through pier rocking to highly nonlinear hysteretic behavior developed through, for example, bed joint sliding.

In order to more realistically model the nonlinear in-plane wall behavior, especially for perforated walls with different kinds of openings, a simple composite nonlinear spring model was developed [Craig *et.al.*, 2002] and [Park *et.al.*, 2002]. The basic approach to develop a composite spring model for the in-plane behavior of a URM wall is to first subdivide the wall into distinct areas or segments. These segments are defined as rectangular regions that can be represented using simple flexural and shear deformation models and for which a single failure mode can be specified. Each of these segments is then represented by a single elasto-plastic hysteretic spring whose elastic properties can be determined from the deformation model and whose strength and hysteretic properties can be determined from the assumed failure mode. The geometric dimensions and end conditions are used to determine the elastic properties of a segment while the failure mode is determined from empirical data [FEMA, 2000a]. Figure 4.4 shows an example perforated URM wall on the left side and the schematic view of the corresponding composite spring model on the right. In this model, each segment of the URM wall is represented by a nonlinear spring, and the springs are assembled in series and parallel arrangements to match the segment topology for the wall itself. In this figure, springs number 1 and number 8 are not representative of any wall component, but rather capture the story bending effects. The elastic properties of these two springs are defined as a function of the overall interstory wall aspect ratio and are calibrated from the finite element analysis results (Craig *et.al.* [2002] and Park *et.al.* [2002]).

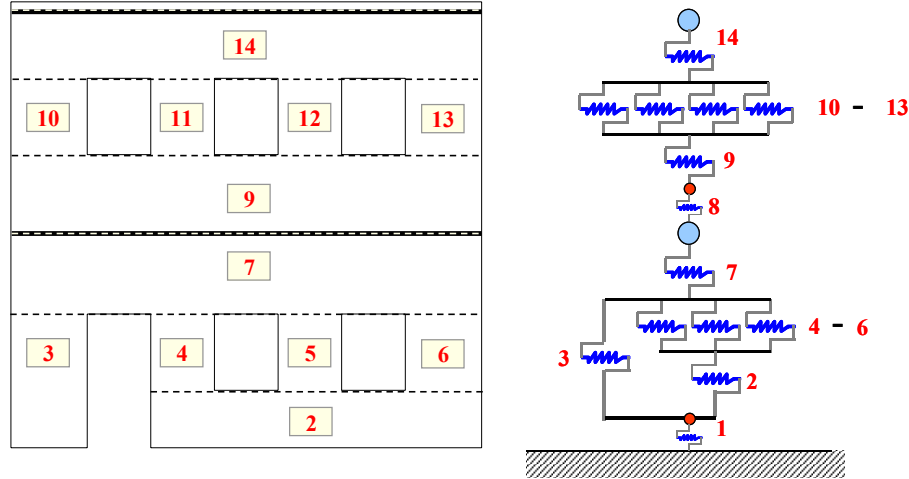

Figure 4.4: Composite Spring Model of Wall A and Wall B

In this composite spring model, each component or segment is treated individually as a solid masonry shear wall. The in-plane force-deflection behavior of unreinforced masonry shear walls is linearly elastic before net flexural tension stresses at the wall heel exceed tensile strengths, or diagonal tension or bed-joint sliding shear stresses exceed shear strengths. FEMA-356 [FEMA, 2000a] provides a formula for the calculation of the linear elastic stiffness of an URM shear wall as follows.

$$k = \frac{1}{\frac{h_{\text{eff}}^3}{3E_m I_E} + \frac{h_{\text{eff}}}{A_v G_m}} \quad (4.1)$$

for a cantilever (fixed-free) shear wall, and

$$k = \frac{1}{\frac{h_{\text{eff}}^3}{12E_m I_E} + \frac{h_{\text{eff}}}{A_v G_m}} \quad (4.2)$$

for a fixed-fixed shear wall, where

$$h_{\text{eff}} = \text{Wall height}$$

PROJECT DS-5 FINAL REPORT

A_v = Shear area

I_g = Moment of inertia for the gross section

E_m = Masonry elastic modulus

G_m = Masonry shear modulus

These formulas are based on the classical theory of bending and shear. They are derived for different boundary conditions of the masonry shear walls. However, the masonry piers in a perforated wall are typically connected to other wall components below and above them. It is, in turn, hard to characterize the actual boundary conditions for the masonry piers as they cannot be regarded as fixed-fixed. One approach to account for boundary conditions that are less stiff than the assumed ideal fixed condition is to instead assume a finite rotational restraint at each end. Another approach is to simply increase the pier height while maintaining the ideal fixed end conditions.

For this study, the pier height is altered to account for the less than ideal end fixity. In other words, the pier height is increased by a factor, r , to create a new “effective height” [Craig *et.al.*, 2002 and Park *et.al.*, 2002]. Since this increased pier height is not real, but is used simply to compute a more accurate stiffness, it is referred to as an “effective height.” Furthermore, since the end conditions may not be symmetric, the effective heights are computed separately for the upper and the lower half of the piers and added together. The r factors are determined from simple design formulas that are in turn based on correlations with detailed plane stress finite element models of the piers with a wide range of different end conditions. At the end, the initial elastic stiffness of each masonry pier is calculated using (4.2) with h_{eff} being the effective or the factored height.

PROJECT DS-5 FINAL REPORT

The strength of the wall is different for each failure mode and must be determined separately. FEMA [2000a] provides design formulas for the strength of each failure mode of a solid wall under an in-plane force applied along its top. These empirical formulas reflect the geometry of each segment, material strengths, and the vertical compressive loads. FEMA [2000a] also notes that unreinforced masonry walls and piers should be considered as deformation-controlled components if their expected lateral strength, limited by bed-joint sliding, shear stress, or rocking, is less than the lower bound lateral strength limited by diagonal tension or toe compressive stress. Otherwise, these components should be considered as force-controlled components.

The strengths of the masonry solid walls are calculated following FEMA [2000a]. Material properties used in these formulations are based on the mean values of the test data. Strengths for the four failure modes can be calculated as follows:

(a) *Rocking failure*: The expected lateral strength of existing URM walls governed by rocking failure is

$$V_r = 0.9 \cdot \alpha \cdot P_E \cdot \left(\frac{L}{h_{\text{eff}}} \right) \quad (4.3)$$

where

α = Factor = 0.5 for fixed-free cantilever wall, or = 1.0 for fixed-fixed wall

P_E = Expected axial compressive force due to gravity loads
= $1.1 \cdot (Q_D + Q_L + Q_S)$

Q_D = Dead load

Q_L = Effective live load

PROJECT DS-5 FINAL REPORT

Q_s = Effective snow load

L = Length of wall

h_{eff} = Height of resultant of lateral force

(b) *Bed-joint sliding failure*: When bed-joint sliding governs the wall failure, the expected strength of the wall is

$$V_{bjs} = v_{me} A_n = \frac{0.75 A_n \left(0.75 v_{te} + \frac{P_{CE}}{A_n} \right)}{1.5} \quad (4.4)$$

where

v_{me} = Expected bed-joint sliding shear strength, psi

A_n = Area of net mortared/grouted section, in²

v_{te} = Average bed-joint shear strength, psi

P_{CE} = Expected vertical axial compressive force (= P_E)

The 0.75 factor on the v_{te} term may be waived for single wythe masonry, or if the collar joint is known to be absent or in very poor condition. Values for the mortar shear strength, v_{te} , in (4.4) should not exceed 100 psi.

(c) *Diagonal tension cracking failure*: the strength of a solid wall governed by diagonal shear cracking is

$$V_{dt} = f'_{dt} \cdot A_n \cdot \left(\frac{L}{h_{eff}} \right) \cdot \sqrt{1 + \frac{f_a}{f'_{dt}}} \quad (4.5)$$

where

PROJECT DS-5 FINAL REPORT

f'_{dt} = Lower bound of masonry diagonal tension strength

(may be substituted by the bed-joint shear strength, v_{me}), psi

f_a = Upper bound of vertical axial compressive stress $\left(= \frac{P_E}{A_n} \right)$, psi

This equation is only applicable for the range of L/h_{eff} between 0.67 and 1.00. As mentioned earlier, diagonal tension cracking can be divided into two different kinds, depending on the relative strength of mortar joints, brick-mortar interface, and bricks: (1) cracking that follows the path of bed- and head-joints or a stair-step pattern, and (2) cracking that goes through the bricks. Equation (4.5) above is only applicable to case (2). It would be rational to apply (4.5) for case (1), because the lateral movement of the wall can only be resisted by the friction of the bed-joints.

(d) *Toe crushing failure*: The strength of a wall governed by toe crushing is

$$V_{tc} = \alpha \cdot P_L \cdot \left(\frac{L}{h_{eff}} \right) \cdot \left(1 - \frac{f_a}{0.7f'_m} \right) \quad (4.6)$$

where

P_L = Lower bound of vertical compressive force

$$= 0.9 \cdot Q_D$$

f'_m = Lower bound of masonry compressive strength, psi

For this case, the lower bound masonry compressive strength, f'_m should be taken as the expected strength, f_{me} divided by 1.6.

The strengths of each segment in an in-plane wall are computed using the above equations. The governing failure mode of each segment is determined by the lowest strength of

the four failure modes. Table 4.2 shows properties of each segment in a composite spring model for wall A (and wall B) and their governing behavior calculating from FEMA guidelines. The elastic stiffness presented in this table has been adjusted for a less-than-ideal fixity by the “effective height” method.

Based on this composite spring approach, the overall elastic stiffness of wall A and wall B is found to be 1533 kips/in. For a validation of the model, the elastic stiffness of the walls that is computed by a plane-stress analysis in Yi [2004] is used as a benchmark. The benchmark stiffnesses for wall A and wall B are varied between 1100 and 1515 kips/in, depending on the location of the applied forces. It is apparent that the stiffness based on a composite spring model is only slightly higher than that from a detailed finite element analysis. This confirms the validity of the composite spring model in approximating the elastic properties of a perforated wall.

Under strong earthquake loadings, URM in-plane wall (and its components) generally deforms into an inelastic range. Hysteretic properties associated to each failure mode must be defined for the nonlinear spring elements. A number of past experimental research characterized nonlinear behaviors of different failure modes. However, since all component-level behaviors in wall A and wall B are either rocking or bed-joint sliding (Table 4.2), only the hysteretic properties of the two failure mode are used in this report. Details of hysteretic behaviors of the diagonal tension cracking and toe crushing failure modes can be found elsewhere [Magenes and Calvi, 1997] and [FEMA, 1998].

Table 4.2: Elastic Properties and Strength of Wall Components in Wall A and Wall B

Segment	Governing	Elastic	Strength
2	Sliding	16678.38	108.72
3	Rocking	1688.14	7.08
4	Rocking	880.73	8.60
5	Rocking	966.34	8.60
6	Rocking	1133.95	12.38
7	Sliding	13612.09	148.98
9	Sliding	21447.34	121.05
10	Rocking	1138.3	4.23
11	Rocking	970.11	2.94
12	Rocking	970.11	2.94
13	Rocking	1138.3	4.23
14	Sliding	17352.35	113.81

* Elastic stiffness is calculated using the “effective height” approach

Rocking failure: In the case of a rocking response, very large displacements can theoretically be obtained without significant loss in strength. A typical flexural response is depicted in Figure 4.5a, where a nonlinear but nearly elastic behavior with very minimal hysteretic energy dissipation is shown. A simple elasto-plastic model with a completely elastic behavior is used in the spring model in the case that rocking failure governs (Figure 4.5b).

Bed-joint sliding failure: When sliding on horizontal bed-joints occurs, a very stable mechanism is involved, since high displacements are possible without a loss of integrity of the wall. Damage is concentrated in a bed-joint, and as long as a vertical load is present, high energy dissipation is possible due to solid friction generated by a relative movement between sliding brick units. The hysteretic shape the bed-joint sliding behavior was developed from a cyclic loading test of a URM wall under constant vertical pressure [Abrams, 1992], shown in Figure 4.6a. This hysteretic behavior can be idealized with an elasto-plastic model with inelastic unloading, as shown in Figure 4.6b.

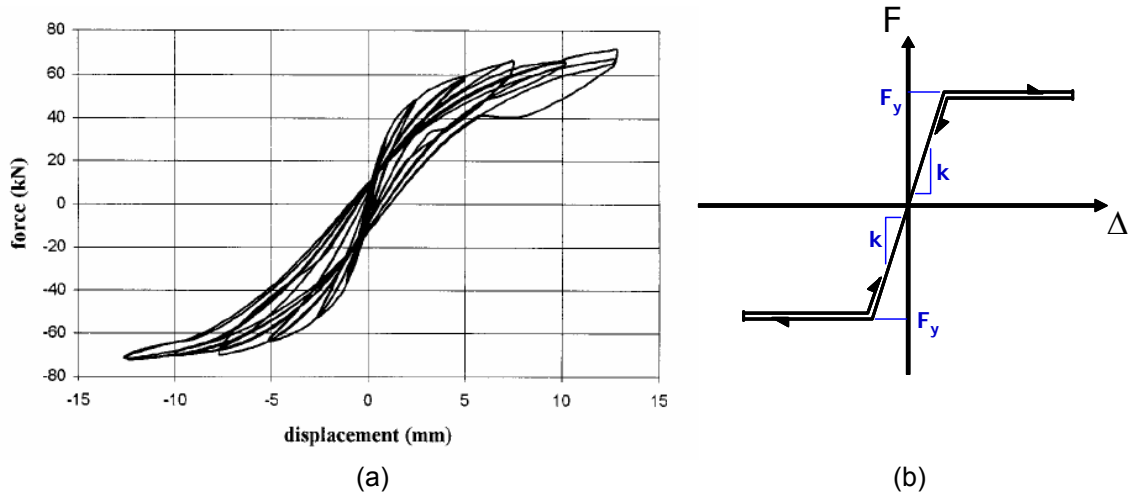

Figure 4.5: Rocking Hysteretic Behavior, (a) Experimental Results [Magenes and Calvi, 1997], and (b) Idealized model

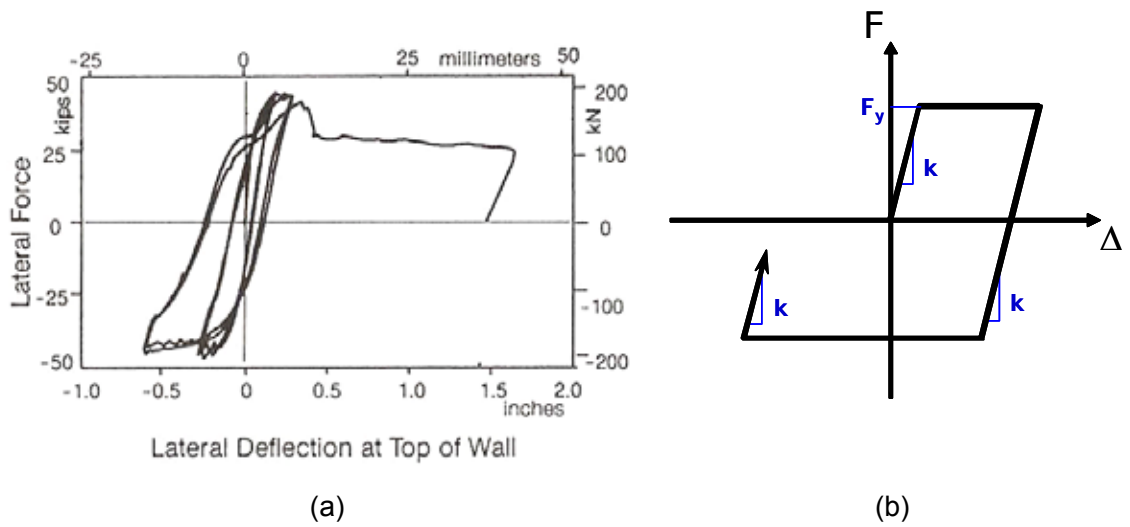

Figure 4.6: Bed-Joint Sliding Hysteretic Behavior, (a) Experimental Results [Abrams, 1992], and (b) Idealized model

Another important component of the dynamic analysis is the mass property of the URM walls. The mass of the in-plane wall is computed from the wall's self weight and, for this composite spring model, is lumped at the floor and the roof levels. Masses for wall A and wall B at floor and roof levels are computed to be $0.11 \text{ k-sec}^2/\text{in}$ and $0.04 \text{ k-sec}^2/\text{in}$, respectively.

Out-of-Plane Wall Modeling

In reality, URM walls that are subjected to the out-of-plane loadings are susceptible to damage because of their relatively low out-of-plane stiffness and, more importantly, brittle failure mechanism. URM out-of plane walls are most likely the dominant cause of structural failure under earthquakes. In order to prevent the premature failure of a building, it is assumed in this research that a strengthening measure has been applied to the out-of-plane walls to ensure integrity of the walls. This also makes the URM wall out-of-plane behavior much simpler to model as it can be assumed linear elastic.

In the simplified model, only a single linear-elastic spring is used to represent an out-of-plane stiffness between floor levels. The values for the out-of-plane stiffness of wall 1 and wall 2 are obtained from the finite element model [Yi, 2004] and are presented in Table 4.3. As expected, it should be noted that these stiffnesses are much lower than the in-plane wall stiffness and therefore contribute relatively little to the 2D response of the structure. The mass properties of wall 1 and wall 2 are calculated in a similar way as that of the in-plane walls. The mass values at each floor level are also shown in Table 4.3.

Table 4.3: Properties of the Out-of-Plane Wall 1 and Wall 2

Properties	Wall 1		Wall 2	
	1 st Floor	2 nd Floor	1 st Floor	2 nd Floor
Out-of-Plane Stiffness	104.4	160.9	66.4	160.9
Mass (k-sec ² /in)	0.125	0.041	0.091	0.037

Flexible Diaphragm Modeling

In 2-dimensional URM building models, floor bending is not considered, and as a result, the floors are usually considered as diaphragms with extensional and shear stiffnesses. Floors made from tongue-and-groove or plywood decking over wooden joists are quite common in old

URM construction in the region although newer construction may involve poured concrete on light steel decking. In either case, and especially for the wooden floors, the shear stiffness is much less than the extensional stiffness and usually is the defining characteristic of the floor. Laboratory tests of typical and modified wooden flooring systems [Peralta *et.al.*, 2000] confirm this behavior and provide representative stiffnesses. It should also be noted that these stiffnesses are nonlinear and are often accurately characterized by a bilinear stiffness with hysteretic behavior.

Floor and roof diaphragms for the test structure are of identical construction. Their shear and extensional stiffnesses from the experiments are found to be 4 kips/in and 870 kips/in, respectively. Mass of each diaphragm is lumped at its center and is found to be 0.06 k-sec²/in, based on experimental study [Yi, 2004]

4.1.1.4 DRAIN Model for a URM building

DRAIN-2DX [Prakash *et.al.*, 1993] was selected in this study for modeling the behavior of the URM test structure. While DRAIN-2DX does not have a straightforward means to model URM structures, it does include a versatile, zero-length spring element with a variety of possible nonlinear behaviors. As described in the previous sections, this simple nonlinear spring element can be used to develop basic nonlinear models for simple URM structures with flexible floor diaphragms. Each component in the model is constructed using the DRAIN-2DX TYPE 04 zero-length nonlinear spring element. A simple 2D model can be constructed by orienting the 2D axis system in a horizontal plane. The complete URM test structure is modeled by assembling the composite nonlinear springs for each wall with the lumped wall masses, as illustrated in Figure 4.7. For illustration purpose, the in-plane walls are represented in Figure 4.7 by a single spring in each floor. However, the actual model incorporates the nonlinear behaviors of in-plane walls at a component-level as displayed in Figure 4.4.

Parallel research [Kim and White, 2001] has also developed a 3-dimensional nonlinear modeling tool for URM structures with flexible floor diaphragms that is based around ABAQUS. Much like the above DRAIN-2DX approach, the nonlinear URM wall behavior is modeled using simple nonlinear springs. However, the floor diaphragm is modeled with a special ABAQUS User Element developed specifically for this purpose. As a result, the ABAQUS model is capable of handling more realistic 3-dimensional models but at the expense of using a considerably more complex analysis tool. This ABAQUS model is used as a validation tool for a much simpler DRAIN-2DX composite spring model used in this study.

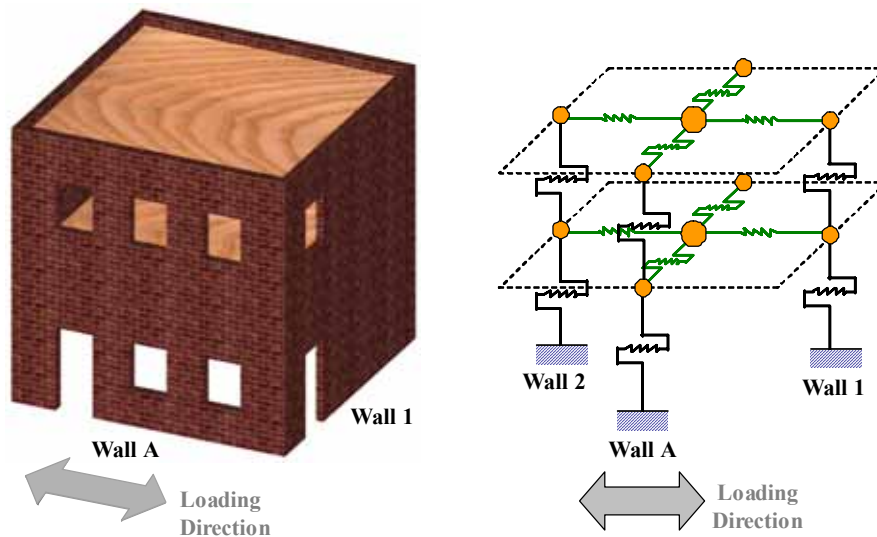

Figure 4.7: Nonlinear Spring Model Representing a URM Test Structure

Validation of the simplified DRAIN-2DX model is carried out by comparing its dynamic characteristics and responses to those computed from the finite element model [Kim and White, 2001]. It is found that the simplified model is able to capture most of the nonlinear behaviors in the walls and diaphragms and produces similar results to the more complex finite element model when the behavior is largely 2-dimensional (*i.e.*, no torsional response). Comparisons in the

building's fundamental period and maximum displacement at various locations due to a certain artificial ground motions are displayed in Table 4.4.

Table 4.4: Comparisons between Results from DRAIN-2DX and ABAQUS Models

	DRAIN-2DX Model	ABAQUS Model
Fundamental Period (sec)	0.304	0.304
Max Disp. @ Top of Wall A	0.0290	0.0263
Max Disp @ Top of Wall 1 (in.)	0.4528	0.4505
Max Disp. @ Center of Roof	0.4073	0.3930

Good agreement in the dynamic responses between the DRAIN-2DX composite spring model and the ABAQUS model provides confidence in utilizing the composite spring model in this research. It is believed that the much simpler spring model is sufficient for seismic performance assessment, and more importantly in the fragility analysis that requires a large number of analyses, of the URM structure in this study.

4.1.1.5 Building Model with Degraded Material Properties

The majority of the URM firehouses in Mid-America were constructed prior to 1970 [French and Olshansky, 2000]. Strength and structural integrity of these buildings may experience some sorts of degradation over such a long period of time. In addition, construction materials (*i.e.*, brick and mortar) that are older than 50 years did not provide as high a strength as similar materials today. In order to truly represent existing firehouses in the region, these factors must be taken into account in the structural models.

One way is to use lower values for the strength parameters of masonry to reflect the poor masonry condition. FEMA [2000a] suggests the values for compressive strength, elastic modulus, and shear strength of masonry with poor condition and they are listed in Table 4.5. These so-called degraded material properties replace those values obtained from the experimental study

and are used to construct the composite spring model in this research. Consequently, the stiffness and strength properties of each wall are modified to reflect these degraded material properties.

Table 4.5: Degraded Masonry Properties

Properties	Values
Masonry Compressive Strength (psi)	300
Masonry Elastic Modulus (ksi)	165
Masonry Bed-Joint Shear Strength	13

4.1.2 Earthquake Inputs

The focus of this study is to assess performance of typical firehouse in Mid-America under earthquakes. The test structure presented in the previous sections is a representation of typical URM firehouse constructions in this region. In order to be relevant, the earthquake loadings that are applied to the test structure must resemble seismic characteristics in the same region. An ideal approach is to use ground motions recorded from historical earthquake events. However, due to the fact that the last major earthquake in this region was almost 200 years ago, the available recorded information for strong ground motions is scarce.

Wen and Wu [2001] developed a suite of synthetic ground motions for 3 cities in Mid-America. These cities include Carbondale, IL, Memphis, TN, and St. Louis, MO. Earthquakes were generated based on two hazard levels: 10% and 2% probabilities of exceeding in 50 years. Earthquake events were simulated with their epicenters uniformly distributed around the New Madrid Seismic Zone (NMSZ). The body wave magnitudes of these simulated earthquakes range between 5 and 8. Local site effects and soil amplification at the location of each city were also taken into account in the simulation process. At the end, a suite of 20 ground acceleration records were generated for each city location (10 records for 10% probability level and 10 records for 2% probability level).

In this study, focus has been placed on the area around Memphis and Shelby County. As a result, using the synthesized ground motions for Memphis is most appropriate. Both probability levels are applied in this research with the 10% exceeding probability events signifying the BSE-1 (Basic Safety Earthquake-1 defined by FEMA [2000a]) and the 2% events indicating the BSE-2. Time-history and elastic acceleration spectrum plots for each synthesized record can be found in Wen and Wu [2001].

4.1.3 Dynamic Analysis of a Composite Spring Model

Performance of the URM firehouse under the earthquakes are assessed by numerical simulation of dynamic responses using DRAIN-2DX. The synthetic ground accelerations are applied to the composite spring model and the building displacement responses are computed. Table 4.6 and Table 4.7 summarize the maximum displacements computed during the period of ground excitations. The maximum displacements displayed in these tables are computed at various locations in the building, that is Δ_{IPW} represents the maximum displacement at the top of the in-plane wall (wall A), Δ_{OPW} corresponds to the out-of-plane wall (wall 1), and Δ_{DIA} is computed at the center of the roof diaphragm.

Table 4.6: Maximum Displacements at Various Locations of the URM Structure under BSE-1 Ground Motions

Ground	Δ_{IPW}	Δ_{OPW}	Δ_{DIA}
m10_01s	0.014	0.288	0.288
m10_02s	0.018	0.348	0.348
m10_03s	0.018	0.235	0.235
m10_04s	0.018	0.325	0.325
m10_05s	0.025	0.350	0.350
m10_06s	0.016	0.321	0.321
m10_07s	0.019	0.459	0.459
m10_08s	0.027	0.378	0.378

PROJECT DS-5 FINAL REPORT

m10_09s	0.022	0.461	0.461
m10_10s	0.014	0.285	0.285

Table 4.7: Maximum Displacements at Various Locations of the URM Structure under BSE-2 Ground Motions

Ground	Δ_{IPW}	Δ_{OPW}	Δ_{DIA}
m02_01s	0.501	2.122	2.124
m02_02s	0.129	1.775	1.776
m02_03s	0.354	1.770	1.771
m02_04s	0.304	2.324	2.325
m02_05s	0.454	1.776	1.777
m02_06s	0.217	2.218	2.219
m02_07s	0.182	1.713	1.714
m02_08s	0.237	2.032	2.033
m02_09s	0.358	2.096	2.097
m02_10s	0.327	2.367	2.369

Table 4.6 and Table 4.7 show that the maximum displacements due to earthquake loadings are much higher in the out-of-plane wall and the diaphragm than they are in the in-plane wall. This finding confirms that the out-of-plane walls are usually the most vulnerable component in the URM buildings. Past research on the nonlinear behaviors of the URM out-of-plane walls [Simsir *et.al.*, 2002, and Goodno *et.al.*, 2003] also showed very low out-of-plane strengths. Had the out-of-plane walls not been strengthened, they would likely be the first point of failure due to their large lateral deformations.

The issue of the behavior of the out-of-plane walls is beyond the scope of this study. Instead, it is assumed that proper mitigation has been implemented for the out-of-plane walls such that the out-of-plane walls remain elastic. The focus is thus mainly on the nonlinear behavior and

failures in the in-plane walls. Future research should include a more detailed nonlinear behavior of the out-of-plane action in the analytical models.

The use of the building maximum displacements provides an insight on how the building performs under earthquake loadings and it may relate well to building damage. However, rather than using the maximum displacements, FEMA-356 [FEMA, 2000a] suggests the use of maximum inter-story drift as a performance measure in the URM buildings. The inter-story drift is computed as the relative lateral displacement between floors expressed as a percent of the story height at that floor. Building performance or damage levels are specified as a function of the maximum inter-story drift the building sustains during an earthquake. In the case of a URM building, three performance levels are defined. They include, Collapse Prevention (CP), Life Safety (LS), and Immediate Occupancy (IO) performance levels. Descriptions and the maximum drift limit for each building performance level are displayed in Table 4.8.

Table 4.8: Structural Performance Levels for URM Structures [FEMA, 2000a]

	Structural Performance Levels		
	Collapse Prevention S-5	Life Safety S-3	Immediate Occupancy S-1
Damage Levels	Severe	Moderate	Light
Overall Damage Descriptions	Extensive cracking. Face course and veneer may peel off. Noticeable in-plane and out-of-plane offsets.	Extensive cracking. Noticeable in-plane offsets of masonry and minor out-of-plane offsets	Minor cracking of veneers. Minor spalling in veneers at a few corner openings. No observable out-of-plane offsets.
Drift	1.0%	0.6%	0.3%

In order to assess the performance of the URM firehouse in the research, the maximum inter-story drifts are calculated from the time-history analyses of the composite spring model subjected to the suite of artificial ground motions. Both BSE-1 (10% exceedance probability) and BSE-2 (2% exceedance probability) earthquakes are applied to the structure. Table 4.9 presents

PROJECT DS-5 FINAL REPORT

the values of the maximum inter-story drift for both earthquake levels. The results obtained from the BSE-1 case are displayed on the left-hand side of the table, while those from the BSE-2 case are on the right. It is found that the building performs reasonably well under the BSE-1 earthquakes as its maximum drifts always satisfy FEMA’s Immediate Occupancy (IO) criterion. On the other hand, when subjected to the stronger BSE-2 motions, the building undergo large drifts that it exceed the Collapse Prevention (CP) limit most of the time.

Table 4.9: Computed Maximum Inter-Story Drifts due to a Suite of Ground Motions

Ground	Max	Ground	Max
M10_01s	0.167	m02_01s	1.250
M10_02s	0.209	m02_02s	0.973
M10_03s	0.136	m02_03s	0.975
M10_04s	0.178	m02_04s	1.390
M10_05s	0.201	m02_05s	1.003
M10_06s	0.181	m02_06s	1.187
M10_07s	0.275	m02_07s	1.020
m10_08s	0.224	m02_08s	1.192
m10_09s	0.269	m02_09s	1.256
m10_10s	0.157	m02_10s	1.342
Mean	0.200	Mean	1.159
COV	0.23	COV	0.13

FEMA [2000a] defines a building performance objective that is mainly used for a rehabilitation purpose; however, the same objective can be used to assess seismic performance of existing building as well. The Basic Safety Objective (BSO) is the objective that ensures acceptable risk on a traditional life safety criterion. In order to achieve the BSO, the building must exceed the Life Safety (LS) building performance level under the BSE-1 earthquake hazard level and, at the same time, it must also exceed the Collapse Prevention (CP) building performance level under the BSE-2 hazard level.

However, in the case for an essential facility, a more stringent performance objective must be utilized. FEMA [1997] suggests an Enhanced Safety Objective for essential facilities that are critical for post-earthquake disaster response and recovery. In order to achieve this enhanced objective, the building must satisfy the Immediate Occupancy (IO) performance level under BSE-1 and the Life Safety (LS) level under BSE-2. It must be noted that this objective does not ensure that no interruptions will occur in the building function. Some cleaning or minor repair may be required in order to restore the building's original services, but it is intended that such repair can be quickly accomplished.

The maximum drift values from Table 4.9 indicate that the URM firehouse under this study does not comply with the Enhanced Safety Objective. A seismic rehabilitation is thus required in order to improve the building performances under future earthquakes. For this purpose, the use of metallic passive damping devices for seismic rehabilitation will be examined in Section 4.2 below.

A more important point from Table 4.9 is that the computed maximum drifts vary quite significantly even for the same level of earthquakes. The primary cause of the fluctuation in the building responses is due to an inherent randomness in the seismic ground motions. Deterministic assessment of a building due to certain earthquakes may not provide an accurate insight for planning proper mitigation measures. Fragility assessment takes into account the uncertain parameters in determining the damage likelihood to the buildings. The following section presents a fragility analysis of the URM firehouse developed using the metamodel approaches developed in Chapter 3.

4.1.4 Fragility Assessment of the URM Building

Significant variation in building responses exists when the URM building is subjected to various ground motions. This is due to the inherent random characteristics of the earthquake events. In addition, the construction materials also exhibit uncertain properties so that using their

mean values alone in the response computation may be misleading. As a result, an assessment that takes into account these uncertainties should be implemented. This is particularly useful for the decision-makers to be able to assess the likelihood of seismic damage and plan for proper actions. Fragility curves are a common tool in this regard as they describe the probabilities of damage to a building due to different levels of earthquake intensity.

In this chapter, the seismic responses and, consequently, damage are estimated through an explicit response surface metamodel. Uncertainties that exist in the problem are taken into account by simulating a large number of possibilities and calculating probabilities that damage may take place. The process for generating fragility curves for this URM building follows what has been developed in Chapter 3 for a SDOF system.

4.1.4.1 Damage Measure and Limit States

The first step in the process (Figure 3.3 and Figure 3.6) is to define a response measure that is suitable for quantification of seismic damage. A number of researchers have proposed the damage measures for buildings subjected to earthquake loadings. Some utilized a displacement-based measure such as a maximum roof drift ratio to quantify damage [Rodriguez and Aristizabal, 1999]. Some used energy-based criteria that relate the amount of hysteretic energy to the levels of damage [Wong and Wang, 2001]. Some researchers combined the two parts and derived unique measures [Park and Ang, 1985, and Rodriguez and Aristizabal, 1999]. However, there has been little consistency on the most appropriate measure to quantify the seismic damage. In light of these available damage measures, FEMA [2000a] proposed the use of the maximum drifts to assess building performance and levels of damage to structural components. In the case for unreinforced masonry walls, certain values of drift are defined for three performance or damage levels, as shown in Table 4.8. This simpler damage measure is used for assessing damage potential in the URM firehouse under investigation.

4.1.4.2 Uncertainties in Structural Parameters

Past investigations [Abrams and Shinozuka, 1997; Schueremans and Gemert, 1999]; and JCSS, 2001] suggest a number of the URM material properties that exhibit uncertain properties. In this study, it is assumed that masonry density, elastic modulus, compressive strength, bed-joint shear strength, tensile strength and damping ratio are major sources of structural uncertainty for the URM structures. Statistical descriptions of the structural parameters are presented in Table 4.10. The mean values of the random parameters are obtained from experimental studies [Yi, 2004; and FEMA, 2000a]; while the parameters' probability distributions and their dispersion measures were collected from several previous investigations [Abrams and Shinozuka, 1997; Schueremans and Gemert, 1999; and JCSS, 2001].

Table 4.10: Structural Uncertainties for URM Structures

Random Parameters	Distribution	Mean	COV
Masonry Density (lb/in ³)	Lognormal	0.06944	0.05
Masonry Elastic Modulus (ksi)	Uniform	165.0	0.20
Masonry Compressive Strength	Lognormal	300.0	0.25
Masonry Tensile Strength (psi)	Lognormal	10.0	0.44
Masonry Bed-Joint Shear	Lognormal	13.0	0.20
Damping (%)	Uniform	5.0	0.10

4.1.4.3 Uncertainties in Earthquake Loadings

This chapter continues to use a set of artificial ground motions generated for Memphis, TN [Wen and Wu, 2001] for fragility analysis. The earthquakes in this suite were generated with variability in magnitudes and hypocentral distances from Memphis. Local site effects and soil amplification were also taken into consideration. Twenty synthetic ground acceleration records for Memphis are selected, as it is found in the preliminary study on the SDOF system that using a suite of 20 ground motions provides comparable results to a much larger suite.

A measure of earthquake intensity must also be identified. Initial investigation of the SDOF system (Chapter 3) shows that the use of spectral ordinate of the earthquakes provides better correlation to the displacement-based damage measure. In particular, the spectral acceleration value at the fundamental period of the building is considered as an earthquake intensity measure. Since fragility describes the damage probability conditional on a specific level of earthquake intensity, all ground acceleration records in the suite are scaled, according to (3.27), such that all have the same spectral acceleration values.

4.1.4.4 Response Surface Parameters

The main purpose of a fragility is to describe the probabilistic response or damage of a structure with uncertain properties subjected to random excitations. A response surface model is defined in a way that it relates the damage measure to a set of random variables consisting of structural and seismic uncertainty parameters. The development in Chapter 3 proposed 3 approaches for constructing fragility curves. For this particular example, Approach 3 (see Chapter 3 for details), which incorporates the seismic parameter in the metamodel, is implemented because it provides the least computational expense (Table 3.9) while maintaining prediction accuracy. In this case the output parameters for the response surface are the mean values (y_{μ}) and the standard deviation (y_{σ}) of the maximum drifts (in percents) in the URM building computed from a suite of ground motions. The input parameters for the response surface are the material properties (random variables) and the seismic intensity measure (control variable).

The random input variables for constructing the response surface must be those structural uncertainty parameters (Table 4.10) that possess significant contributions to the computation of the response. The preliminary step is to perform a screening test for this set of input variables. It is found that the masonry tensile strength is largely unimportant and can be omitted from the response surface model derivation. The remaining random parameters include the masonry density, the masonry compressive strength, the elastic modulus, the bed-joint shear strength, and

the damping ratio. However, the elastic modulus and the compressive strength are perfectly dependent to each other (*i.e.*, knowing one parameter means knowing the other) which violate the rule that states that the input variables for the response surface must be independent [Khuri and Cornell, 1987]. As a result, only the elastic modulus is used as one of the input variables for the response surface metamodel. Finally, this set of 4 random variables (density, elastic modulus, bed-joint shear strength, and damping) is joined by a control variable describing the level of earthquake intensity. Parameter space or ranges of input variables are specified for generating a response surface. Each input variable range is set such that it covers most (if not all) of the area under the probability density of the input. In the case when the input variables are described by the uniform distribution (*i.e.*, masonry elastic modulus and damping ratio), their ranges are identical to the distribution limits. For cases other than the uniform distribution (*i.e.*, lognormally distributed masonry density and bed-joint shear strength), the input parameters' lower and upper bounds for the response surface are set at -3σ and $+3\sigma$ from the means, respectively.

Table 4.11 summarizes the response surface input variables and their ranges. It can be seen that each input variable is normalized (3.4) such that its values lie between -1 and +1. The spectral acceleration level is assumed to vary between 0.1g to 1.9g. Three levels of the spectral acceleration are used for generating the response surface model. These levels correspond to three batches of scaled ground motions; that is batch 1, 2, and 3 contain the Memphis ground acceleration records that are scaled to $0.1g S_a$, $1.0g S_a$, and $1.9g S_a$, respectively.

Table 4.11: Input Variables for a Response Surface Model

Random Structural Parameters	Input Variables	Lower Bounds	Center Points	Upper Bounds	Units
Masonry Density	ξ_1	0.0592	0.06944	0.07986	lb/in ³
	x_1	-1	0	+1	-
Masonry Elastic Modulus	\square_{\square}	108.0	165.0	222.0	ksi
	x_2	-1	0	+1	-
Masonry Bed-Joint Shear Strength	\square_{\square}	5.2	13.0	20.8	psi
	x_3	-1	0	+1	-
Damping	\square_{\square}	4.0	5.0	6.0	%
	x_4	-1	0	+1	-
Spectral Acceleration (S_a)	\square_{\square}	0.1	1.0	1.9	g
	x_5	-1	0	+1	-

4.1.4.5 Design of Experiments

JMP [1995] is a versatile statistical software package that is employed extensively in this research. It can be used in an initial step of formulating the DOE tables, fitting the response surface models, and finally performing statistical diagnosis on the derived models. In this part, JMP is used to form a DOE table based on the CCD. For this particular case of 5 input variables, 43 combinations of input variables are employed. Table 4.12 shows a Design of Experiments (DOE) table utilizing a scheme with reduced number of runs on the CCD. Each case or combination is composed of values -1, 0, or +1 of the input variables signifying the lower bounds, center, and upper bounds values, respectively.

Table 4.12: Design of Experiments Table of Input and Output Variables

Case	x_1	x_2	x_3	x_4	x_5	Mean (y_μ)	Std Dev (y_σ)
1	-1	-1	-1	-1	-1	0.064	0.011
2	-1	-1	-1	-1	1	1.201	0.229
3	-1	-1	-1	1	-1	0.056	0.010
4	-1	-1	-1	1	1	1.058	0.204
5	-1	-1	1	-1	-1	0.064	0.011
6	-1	-1	1	-1	1	1.205	0.231
7	-1	-1	1	1	-1	0.056	0.010
8	-1	-1	1	1	1	1.060	0.204
9	-1	0	0	0	0	0.458	0.075
10	-1	1	-1	-1	-1	0.042	0.010
11	-1	1	-1	-1	1	0.772	0.179
12	-1	1	-1	1	-1	0.036	0.009
13	-1	1	-1	1	1	0.690	0.162
⋮	⋮	⋮	⋮	⋮	⋮	⋮	⋮
40	1	1	1	-1	-1	0.051	0.006
41	1	1	1	-1	1	1.015	0.109
42	1	1	1	1	-1	0.047	0.005
43	1	1	1	1	1	0.850	0.102

The input parameters x_1 through x_4 describe the random material properties for constructing the composite spring models. The input parameter x_5 indicates the level of earthquake intensity a particular building is subjected to, which corresponds to the 3 batches of scaled earthquakes. In the end, there are 860 structure-earthquake combinations resulting from 43 unique building models with each subjected to 20 ground motions. Nonlinear time-history analysis is performed on each of the structure-earthquake combination and the maximum inter-story drift is extracted. The mean values and standard deviation of maximum drifts are computed

with the normality assumption at each DOE case and recorded in the DOE table, as shown in Table 4.12.

4.1.4.6 Response Surface Model Fitting

The response surface models approximate the mean and standard deviation of maximum drifts by means of simple polynomial functions. A second-degree polynomial function is deemed appropriate in this study since the building responses are computed with nonlinear behaviors. A typical second-degree response surface function for 5 input variables is in the form of

$$\begin{aligned} \hat{y} = & b_0 + b_1x_1 + b_2x_2 + b_3x_3 + b_4x_4 + b_5x_5 + b_{11}x_1^2 + b_{21}x_2x_1 + b_{22}x_2^2 + \\ & b_{31}x_3x_1 + b_{32}x_3x_2 + b_{33}x_3^2 + b_{41}x_4x_1 + b_{42}x_4x_2 + b_{43}x_4x_3 + b_{44}x_4^2 + \\ & b_{51}x_5x_1 + b_{52}x_5x_2 + b_{53}x_5x_3 + b_{54}x_5x_4 + b_{55}x_5^2 \end{aligned} \quad (4.7)$$

Least-square regression analyses between the input variables (x_1 to x_5) and the output variables (y_μ and y_σ) result in a matrix of the polynomial coefficient estimates (\mathbf{b}). In particular, the coefficients of the polynomial are derived by (3.13) and the response surface models for the mean (\hat{y}_μ) and standard deviation (\hat{y}_σ) of the maximum drifts are expressed as follows:

$$\begin{aligned} \hat{y}_\mu = & 0.55 + 0.06x_1 - 0.103x_2 + 0.001x_3 - 0.034x_4 + 0.495x_5 - \\ & 0.023x_1^2 + 0.001x_2x_1 - 0.004x_2^2 - 0.007x_3x_1 + 0.003x_3x_2 + \\ & 0.008x_3^2 - 0.004x_4x_1 + 0.008x_4x_2 - 0.001x_4x_3 + 0.011x_4^2 + \\ & 0.053x_5x_1 - 0.094x_5x_2 + 0.001x_5x_3 - 0.03x_5x_4 + 0.008x_5^2 \end{aligned} \quad (4.8)$$

and

$$\hat{y}_\sigma = 0.055 + 0.02x_1 - 0.0491x_2 - 0.002x_3 - 0.006x_4 + 0.102x_5 +$$

PROJECT DS-5 FINAL REPORT

$$0.039x_1^2 - 0.037x_2x_1 + 0.066x_2^2 - 0.004x_3x_1 + 0.001x_3x_2 - \quad (4.9)$$

$$0.012x_3^2 - 0.002x_4x_1 + 0.004x_4x_2 + 0.033x_4x_3 - 0.014x_4^2 +$$

$$0.018x_5x_1 - 0.045x_5x_2 - 0.003x_5x_3 - 0.007x_5x_4 - 0.012x_5^2$$

Special two-dimensional or so-called prediction profiler plots [JMP, 1995] are shown in Figure 4.8 and Figure 4.9, for the mean and standard deviation of the maximum drifts, respectively. In the prediction profiler plot, the response is plotted against each of the input variables, while other input variables are fixed at their center point values. The purpose of this plot is to observe the trend of the response due to an effect from a single input variable.

It is apparent from Figure 4.8 that the earthquake intensity level (x_5) has much more influence than the URM material properties on the calculation of the maximum inter-story drift of the URM building. Figure 4.9 also reveals that variability in the maximum drifts from a suite of earthquakes is more pronounced as the earthquake intensity increases.

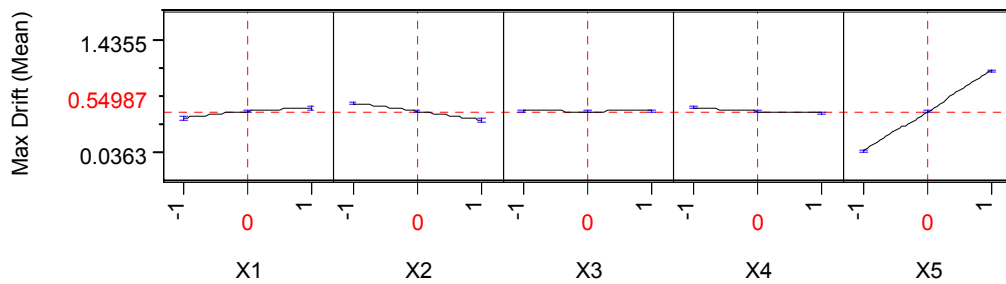

Figure 4.8: Prediction Profiler Plot of the Mean of Maximum Drifts

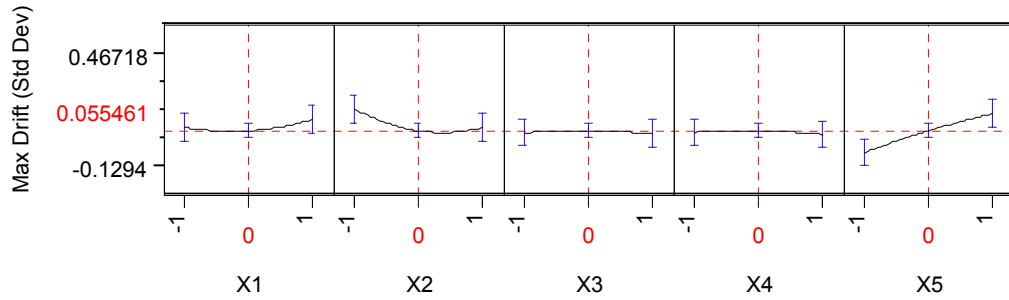

Figure 4.9: Prediction Profiler Plot of the Standard Deviation of Maximum Drifts

4.1.4.7 Statistical Validation of the Response Surface Models

The simplest step to check the response surface models is through the R^2 and R_A^2 values computed from (3.15) and (3.16), respectively. The model for the mean response has R^2 and R_A^2 of 0.9999 and 0.9996, while the model for the standard deviation has R^2 and R_A^2 of 0.9743 and 0.8885, respectively. Both models exhibit high correlation between the actual responses and those that are approximated by the metamodels. However, these overly optimistic indications may be the result of the number of experiments compared to the numbers of degree of freedom in the model. The next step to verify the overall prediction accuracy of the response surface models require a model testing at additional and random combinations of the inputs. [Venter *et.al.*, 1997] suggested the use of the Average Absolute Error (%AvgErr), the Maximum Absolute Error (%MaxErr), and the Root Mean Square Error (%RMSE) for testing response surface model accuracy. For the purpose of these statistical tests, 100 additional combinations of input variables are generated at random. Actual (y_i) and predicted (\hat{y}_i) maximum inter-story drifts are calculated for each combination and those statistical measures are computed as follows:

$$\%AvgErr = 100 \cdot \frac{\frac{1}{N} \cdot \sum_{i=1}^N |y_i - \hat{y}_i|}{\frac{1}{N} \cdot \sum_{i=1}^N y_i} = 2.96\%$$

$$\%MaxErr = \max_i \left[100 \cdot \frac{|y_i - \hat{y}_i|}{\frac{1}{N} \cdot \sum_{j=1}^N y_j} \right] = 8.73\%$$

$$\%RMSE = 100 \cdot \frac{\sqrt{\frac{1}{N} \cdot \sum_{i=1}^N (y_i - \hat{y}_i)^2}}{\frac{1}{N} \cdot \sum_{i=1}^N y_i} = 3.58\%$$

The above measures quantify the error, in percentage, that the predicted maximum drifts from the response surface model depart from the actual values. It can be seen that the level of error in the model is extremely low indicating the prediction accuracy of the response surface model.

Figure 4.10 displays a plot of actual drifts from the time-history analyses versus the drifts predicted by the response surface models. The diagonal line represents a perfect fit between the actual and the predicted values. It is apparent from the figure that the majority of the points lie within a close proximity of this line. This plot confirms that the response surface metamodel provide good approximation to the much more complex nonlinear dynamic analysis.

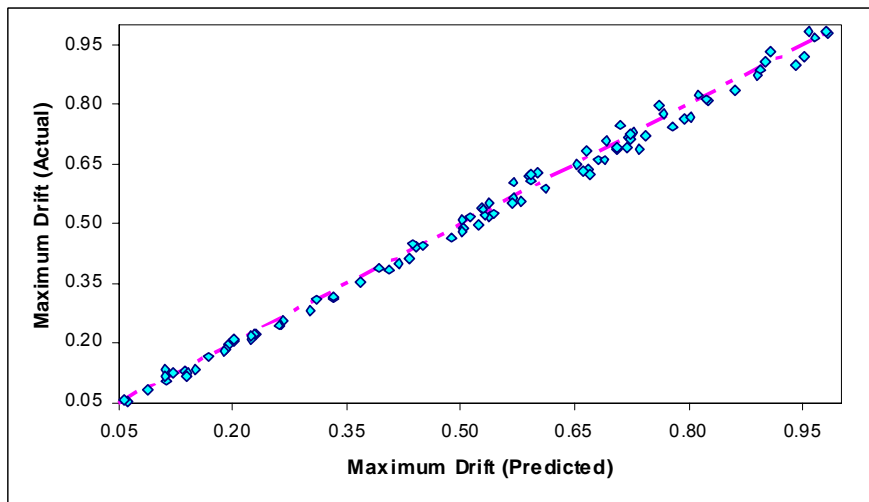

Figure 4.10: Plot of Actual Versus Predicted Maximum Drifts

4.1.4.8 Response Simulation

The response surface model generated by Approach 3 predicts the maximum drifts in the URM building subjected to earthquake with various intensities. In order to compute the building fragilities, the response surface must be evaluated at specific intensity levels, creating metamodels that are conditioned on specific levels of earthquake intensity. The overall response surface in this case is evaluated at every 0.1g increment of the spectral acceleration (from 0.1g to 1.9g). The process creates 19 distinct polynomial models for predicting maximum drifts conditioned on specific intensity levels. For example, in the case of $S_a = 0.9g$, the value for the input parameter x_5 is derived from the normalization of the parameter according to (3.4) as follow.

$$x_5 = \frac{0.9g - \frac{1.9g + 0.1g}{2}}{\frac{1.9g - 0.1g}{2}} = -0.11 \quad (4.10)$$

Consequently, the response surface models of a mean and standard deviation of maximum drifts for a spectral acceleration of 0.9g are obtained by substituting $x_5 = -0.11$ in (4.8) and (4.9) and, hence, they become

$$\begin{aligned} \hat{y}_{\mu|S_a=0.9g} &= 0.495 + 0.054x_1 - 0.093x_2 + 0.001x_3 - 0.031x_4 - \\ &0.023x_1^2 + 0.001x_2x_1 - 0.004x_2^2 - 0.007x_3x_1 + 0.003x_3x_2 + \\ &0.008x_3^2 - 0.004x_4x_1 + 0.008x_4x_2 - 0.001x_4x_3 + 0.011x_4^2 \end{aligned} \quad (4.11)$$

and

$$\begin{aligned} \hat{y}_{\sigma|S_a=0.9g} &= 0.044 + 0.018x_1 - 0.044x_2 - 0.002x_3 - 0.005x_4 + \\ &0.039x_1^2 - 0.037x_2x_1 + 0.066x_2^2 - 0.004x_3x_1 + 0.001x_3x_2 - \\ &0.012x_3^2 - 0.002x_4x_1 + 0.004x_4x_2 + 0.033x_4x_3 - 0.014x_4^2 \end{aligned} \quad (4.12)$$

The overall metamodel takes the following form

$$\hat{y}_{S_a=0.9g} = \hat{y}_{\mu|S_a=0.9g} + N\left[0, \hat{y}_{\sigma|S_a=0.9g}\right] \quad (4.13)$$

in which a normality assumption (see Chapter 3 for validation) on the distribution of maximum drifts is applied. Monte Carlo simulation is performed on (4.13) by repeatedly selecting random values for input variables based on their assumed probability densities (Table 4.10) and calculating responses using the metamodels.

Further validation of the outcomes from simulating the response surface metamodels is performed. A conventional approach that utilizes the Latin Hypercube Sampling (LHS) technique is used as a benchmark. The LHS divides the probability densities of the structural uncertainty parameters into 20 segments of equal probability. A random pairing process of structural parameters and earthquakes generates 20 structure-earthquake systems for dynamic analyses. Twenty discrete values of maximum drifts obtained from the dynamic analyses are rank-ordered and their cumulative probability values are computed according to Ang and Tang [1975]. Figure 4.11 compares these discrete probability values with the continuous cumulative density plot derived from the simulation of the response surface models. The figure shows consistent outcomes from both approaches.

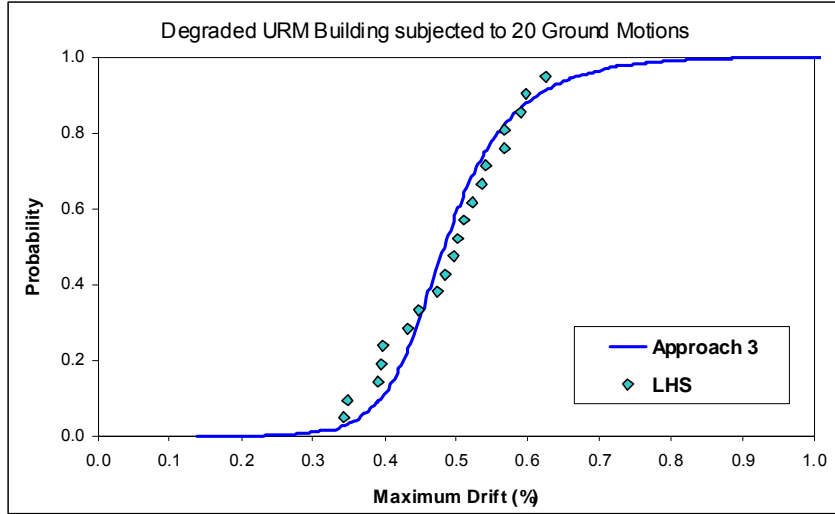

Figure 4.11: Cumulative Probability Plot of Maximum Drifts Conditioning to $S_a = 0.9g$

The probabilities that the computed maximum drifts exceed the predefined limit states (Table 4.8) are computed from ten-thousand outcomes of the simulated response surface model as follows:

$$PE_{IO|S_a=0.9g} = \frac{1}{10,000} \cdot \sum_{i=1}^{10,000} I(\text{Drift}_i \geq 0.3\%) = \frac{9911}{10000} = 0.9911$$

$$PE_{LS|S_a=0.9g} = \frac{1}{10,000} \cdot \sum_{i=1}^{10,000} I(\text{Drift}_i \geq 0.6\%) = \frac{1216}{10000} = 0.1216$$

$$PE_{CP|S_a=0.9g} = \frac{1}{10,000} \cdot \sum_{i=1}^{10,000} I(\text{Drift}_i \geq 1.0\%) = \frac{5}{10000} = 0.0005$$

where $PE_{IO|S_a=0.9g}$, $PE_{LS|S_a=0.9g}$, and $PE_{CP|S_a=0.9g}$ are, respectively, the probabilities of exceeding the IO, LS, and CP limit states conditioning on the intensity level of $0.4g S_a$. $I(\cdot)$ is an indicator function giving a value of 1 if the condition is met, and 0 otherwise. Repetition of the process for all earthquake intensity levels (0.1g to 1.9g) gives a damage probability matrix, as shown in Table 4.13.

PROJECT DS-5 FINAL REPORT

Table 4.13: Conditional Probabilities of Exceedance for the URM Building

S _a (g)	Probability of Exceedance		
	IO	LS	CP
0.1	0.0002	0.0000	0.0000
0.2	0.0001	0.0000	0.0000
0.3	0.0019	0.0000	0.0000
0.4	0.0312	0.0000	0.0000
0.5	0.2517	0.0006	0.0000
0.6	0.7456	0.0019	0.0000
0.7	0.9318	0.0115	0.0000
0.8	0.9764	0.0469	0.0001
0.9	0.9911	0.1216	0.0005
1.0	0.9951	0.2634	0.0016
1.1	0.9979	0.4603	0.0075
1.2	0.9987	0.6581	0.0179
1.3	0.9986	0.7955	0.0439
1.4	0.9995	0.8947	0.0829
1.5	0.9996	0.9429	0.1414
1.6	1.0000	0.9693	0.2260
1.7	0.9999	0.9831	0.3248
1.8	0.9999	0.9908	0.4250
1.9	0.9998	0.9954	0.5544

Plotting these probability values against the corresponding intensity level produces fragility curves for this URM building (Figure 4.12). Each curve is specific to a limit state or performance level. These curves depict the likelihood of damage corresponding to specific damage states with increasing levels of earthquake intensity.

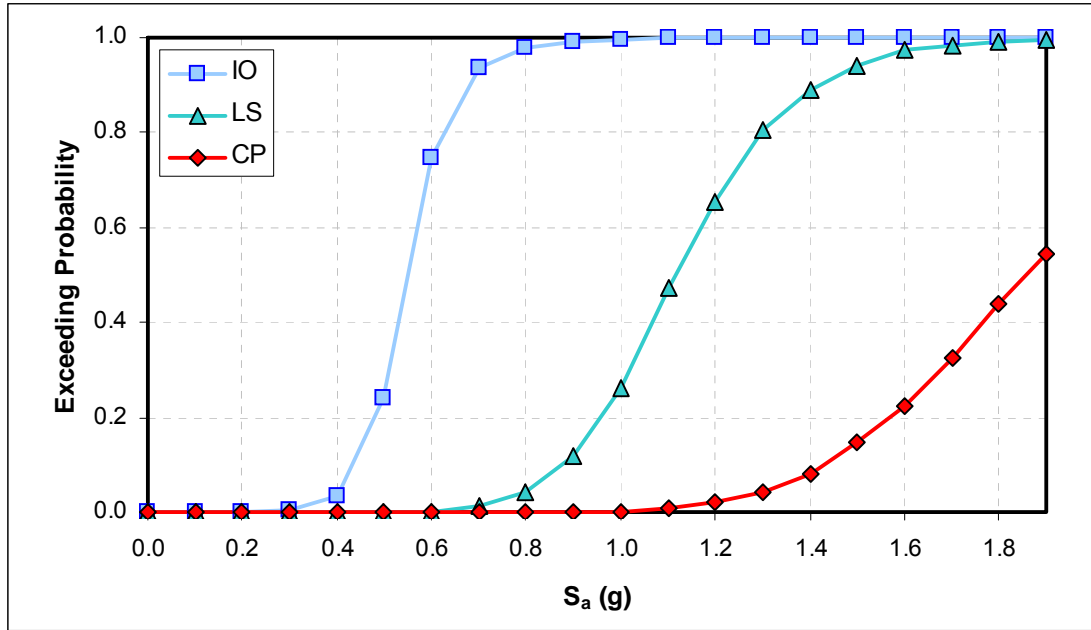

Figure 4.12: Fragility Curves of a Typical URM Firehouse in Mid-America

It is found, however, that these curves are generally different from those obtained from HAZUS [NIBS, 1999], especially for the higher damage levels (*i.e.* LS and CP). HAZUS fragility curves are generated based on subjective assessment of the states of damage and are not expected to provide reliable results for a particular building. The approach in this research is viewed as advancement from HAZUS methodology in computing fragilities and could potentially be implemented in more advanced loss estimation packages in the future.

4.1.4.9 Evaluation of Building Fragilities

In order to evaluate the fragilities of the URM building under investigation, the seismic hazard information at the site of the building is required. In this study, the URM building is assumed to be located in Memphis, TN (35.172 Latitude and -90.016 Longitude). U.S. Geological Survey (USGS) provides the spectral acceleration values at short and long structural periods at locations throughout the United States. The values at the assumed location of the URM building are extracted from the 2002 USGS hazard maps. FEMA [2000a] guidelines are

PROJECT DS-5 FINAL REPORT

used to construct acceleration spectra for both BSE-1 (10% in 50 years) and BSE-2 (2% in 50 years) as shown, respectively, in Figure 4.13 and Figure 4.14.

Expected values for the spectral acceleration corresponding to the building fundamental period can be obtained directly from these spectra. For this URM firehouse, with a fundamental period of approximately 0.5 second, the corresponding spectral acceleration values from the spectral plots are approximately 0.4g and 1.2g for the BSE-1 and the BSE-2 hazard levels, respectively.

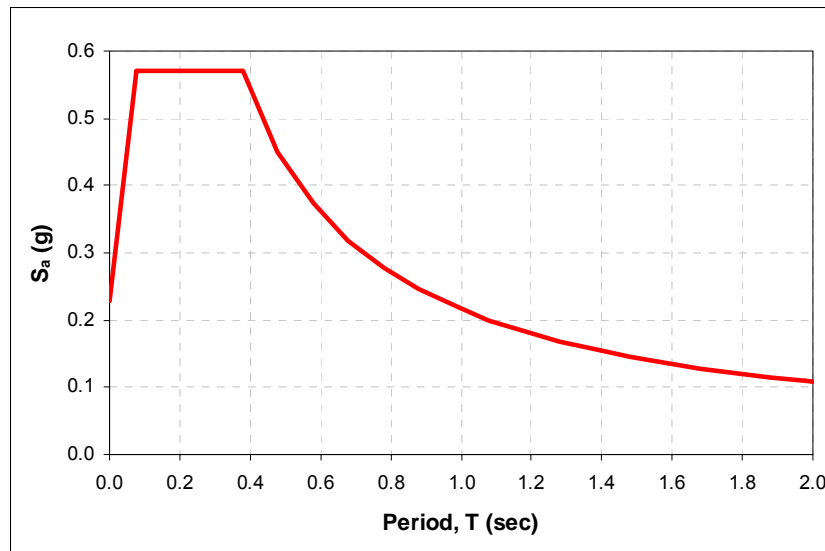

Figure 4.13: Acceleration Spectrum corresponding to BSE-1 Hazard Level for a Site in Memphis, TN [FEMA, 2000a]

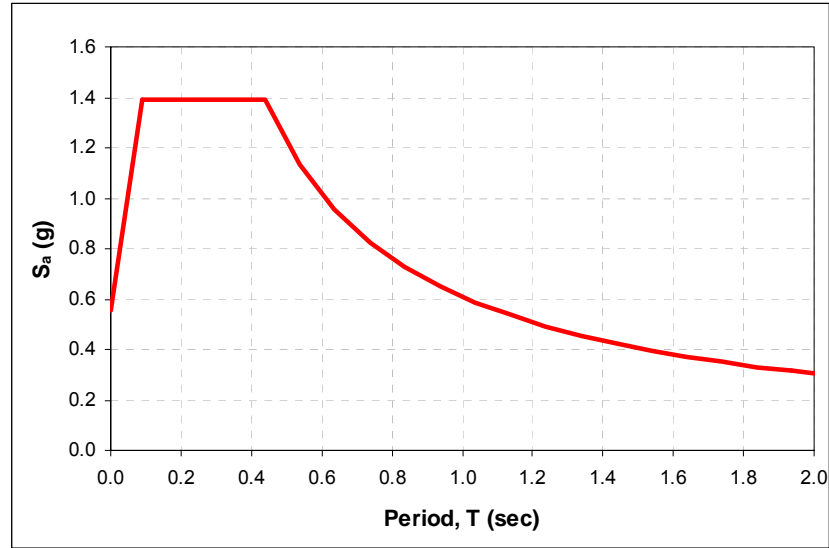

Figure 4.14: Acceleration Spectrum corresponding to BSE-2 Hazard Level for a Site in Memphis, TN [FEMA, 2000a]

As mentioned previously, the Enhanced Safety Objective [FEMA, 1997] requires that the essential facilities satisfy the Immediate Occupancy (IO) performance level under BSE-1 and the Life Safety (LS) level under BSE-2. Based on the spectral acceleration values for the BSE-1 and the BSE-2 hazard levels specific to the site, it is found from the fragility curves (Figure 4.12) that there is approximately 3% chance that the building damage exceeds the IO performance level given that the BSE-1 event were to occur. However, there is 66% chance that this URM building is damaged beyond the LS limit under the BSE-2 earthquake.

An appropriate rehabilitation option may be implemented to reduce the damage probabilities to a more desirable level. Chapter 4.2 presents the rehabilitation proposal for this URM firehouse using the metallic dampers. Deterministic and probabilistic assessments are performed.

4.2 Rehabilitated URM Structures

In Section 4.1, seismic assessment of an unreinforced masonry building typical of firehouse construction in Mid-America led to a conclusion that the building is dangerously

susceptible to future earthquakes and may not satisfy the performance criterion defined by FEMA [1997]. As a result, an appropriate rehabilitation should be employed in order to upgrade the building to the desired levels of performance. In this section, innovative rehabilitation schemes using a simple metallic damping device are proposed. Seismic fragility of the rehabilitated URM building is assessed using the response surface approach. The resulting fragility curves display significant reduction to damage potential over that of the baseline URM building.

4.2.1 Passive Energy Dissipation Concept

It is usually not practical to design building structures to withstand a maximum credible earthquake while maintaining purely elastic structural response. Conventional seismic design is based, instead, on the concept of ductility in which structural members are allowed to undergo large inelastic deformation in order to dissipate seismic input energy while maintaining basic structural integrity. However, this large and repetitive inelastic deformation can result in serious damage in the structural members. Such problems can be avoided if the structure is pre-designed such that the inelastic deformation is largely concentrated in the areas where structural integrity would not be affected. This design philosophy focuses on preventing structural collapse, but the inter-story drifts required to achieve significant energy dissipation are often large and result in severe damage to nonstructural components. Substantial damage in both structural and nonstructural components could affect the overall functionalities of the structures. This is particularly important for essential facilities, which must be designed to maintain operational capabilities during and after an earthquake.

Supplemental energy dissipation systems are one way of addressing these problems in seismic rehabilitation applications. The basic role of the energy dissipation devices is to absorb a significant portion of the seismic energy imparted to the building from an earthquake, thus reducing energy dissipation demand in the primary structural elements. As a result, damage in the main structural elements is minimal. A direct benefit from incorporating the energy

dissipation devices appears in the reduction in the dynamic responses of the buildings. The energy dissipation systems that are widely used as the structural protective systems can be divided into 3 groups. They include (1) seismic isolation systems, (2) passive energy dissipation systems, and (3) active and semi-active control systems [Soong and Dargush, 1997]. While all these protective systems can be effectively used for seismic rehabilitation applications, the focus of this research is on an implementation of a specific type of a passive energy dissipation device.

For roughly 25 years, it has been recognized by both researchers and practitioners that incorporation of passive energy dissipation (PED) devices into buildings would improve their dynamic responses (*i.e.*, reduce displacements, accelerations, *etc.*) Different types of passive energy dissipation devices have been used in seismic protection application for buildings. Metallic energy dissipation devices are based on the plastic deformation of metallic materials, such as mild steel. Friction dampers dissipate energy through the friction that develops between two solid bodies sliding relative to each other. Viscoelastic dampers use highly dissipative polymeric materials, which dissipate energy when subjected to shear deformations. Other forms of passive energy dissipation devices include viscous fluid dampers, tuned mass dampers, tuned liquid dampers, and metal extrusion.

4.2.2 Metallic Hysteretic Dampers

As noted previously, the earthquake hazard in Mid-America, particularly in the NMSZ, is characterized by seismic events with very large magnitudes but relatively long recurrence intervals. As a result, much higher levels of reliability and higher resistance to aging must be assured for any technology used to reduce this hazard.

Passive energy dissipation systems using metallic hysteretic dampers are attractive for seismic protection systems under these conditions because they offer good long-term reliability, modest cost and relatively simple design. As a result, this research focuses only on the metallic energy dissipation devices as an innovative way of rehabilitating URM buildings in this region.

In recent years, extensive efforts have been carried out on the application of metallic hysteretic dampers for rehabilitation and retrofit purposes. A large number of PED devices using metallic hysteresis have been successfully installed in structures in high seismic regions throughout the world. Development of the metallic hysteretic energy dissipation systems will be described in the following sections.

4.2.2.1 Past Development

The idea of utilizing metallic hysteretic dampers to dissipate portion of the input energy in the structures began in early 1970s. Kelly, Skinner, and Heine [1972], and Skinner, Kelly, and Heine [1973, 1975] reported on the conceptual and experimental development of three special mechanical devices to be incorporated into a structure specifically to passively absorb energy generated by an earthquake. These devices included the rolling-bending of thin U-shaped strips, torsional energy absorbers, and flexural energy absorbers.

The U-shaped steel strips interact between adjacent surfaces whose relative movement is directed parallel to each other. The plastic deformation occurs when the strip changes from straight to curved. Different specimens were tested under controlled cyclic displacements. The peak load, dissipated energy and the total number of cycles to failure depended upon the thickness, radius and width of the device. The torsional bar utilizes a combination of torsion and bending, and therefore can be designed for use between surfaces moving away from each other in foundations or shear wall systems. The flexural device utilizes bending of short rectangular beams, and can be designed for use in a number of different situations.

A concept of triangular plate damper was originally developed in New Zealand by Tyler [1978]. This device, which consists of some identical triangular structural steel plates positioned in parallel, is typically installed within a frame bay between chevron braces and the overlying beam. The base of each triangular plate is welded into a rigid base plate to approximate a fixed

end condition. As a result of this configuration, the damper primarily resists horizontal forces, associated with an interstory drift, via uniform flexural deformation of the individual plate.

Following the triangular plate energy dissipators, Scholl [1988] reported on the development of a tapered steel X-plate (so-called added damping and stiffness element or ADAS) and its applications as an energy dissipation device. ADAS elements (Figure 4.15) consist of multiple X-shaped mild steel plates connected in parallel to each other. Whittaker *et.al.* [1991] investigated the use of ADAS elements in the retrofit of moment resisting frames. They showed that these energy dissipation devices could successfully reduce the dynamic response of a moment resisting frame, and they proposed to extend their use to other types of structural systems.

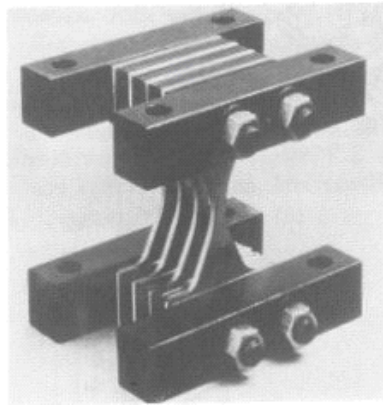

Figure 4.15: Scaled Model of ADAS Element [Perry *et.al.*, 1993]

At Georgia Tech, Pinelli [1992] and Pinelli *et.al.* [1993] analytically and experimentally investigated the use of tapered energy dissipation device as cladding connections in buildings. The particular device they proposed consists of a section of a square tube, cut away as shown in Figure 4.16 to create two tapered beams for which the plastification will occur over the greater portion of materials and ensure that the tapered beams will deform with double curvature.

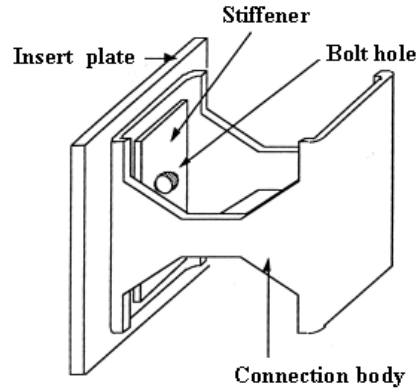

Figure 4.16: Tapered Energy Dissipation Device [Pinelli *et.al.*, 1993]

The test results showed that these tapered devices provided large and stable hysteretic loops without stiffness degradation and strength deterioration (Figure 4.17). The plastic deformations were distributed uniformly throughout the tapered beams maximizing the amount of energy dissipated. The device also sustained a large number of cyclic load reversals (as high as 37 cycles) before failure presenting a good fatigue behavior of the tapered device.

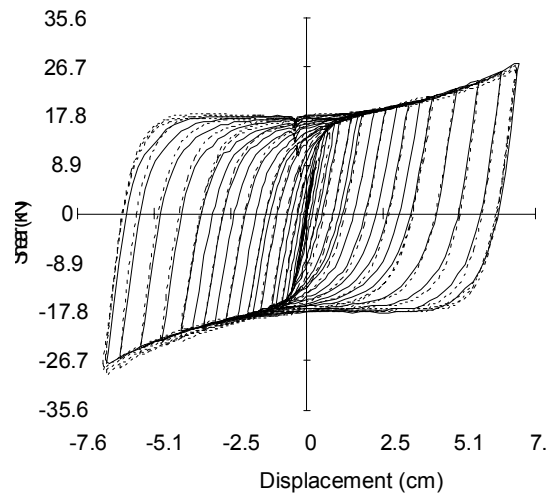

Figure 4.17: Hysteretic Loops for Tested Tapered Device [Pinelli *et.al.*, 1993]

4.2.2.2 Structural Applications

Having gained confidence from promising experimental results with the metallic damper, researchers and practitioners turned their interests to its applications. This part of the report

summarizes the applications of the metallic damping devices in case-study structures. Martinez-Romero [1993] reported on the implementations of the metallic damping devices in 3 buildings in Mexico City including the Izazaga building, the Cardiology Hospital buildings, and the Reforma buildings. The 3 buildings experienced structural damage from the 1985 Mexico earthquake to various degrees. The buildings were retrofitted with the application of the ADAS systems. Computer simulations of the retrofitted buildings showed that the buildings would perform well under future major earthquakes.

Perry *et.al.* [1993] summarized the seismic upgrade of the Wells Fargo Bank building in San Francisco. The building is a two-story non-ductile concrete frame structure. The building experienced structural and nonstructural damage from the 1989 Loma Prieta earthquake. The retrofit plan was to add some steel chevron-braced frames connected to the existing concrete frames by the ADAS devices. A series of X-shaped mild steel plates was used for this system. The use of the ADAS devices in this building was the first structural application of these devices in the United States. The nonlinear time-history analyses confirmed that the maximum displacement of the retrofitted building was within the acceptable limits under severe earthquakes.

Goodno *et.al.* [1998] investigated the application of cladding connectors using tapered energy dissipation devices developed by Pinelli [1993]. A 20-story steel frame building located in Oakland was selected to carry out computational analyses and check the performance of the tapered connectors. DRAIN-2DX, which can perform nonlinear time-history dynamic analysis, was used. Over a thousand of tapered energy dissipative cladding connectors were added to the building model. The simulations indicated a reduction in top floor displacement of up to 40 percent when the tapered connectors were included. Further investigation included a redesign process that concentrated on the reduction in seismic demand of the primary structures while maintaining the same level of baseline building response. It was concluded that by installing the

tapered cladding connectors in a new design, the primary structural member sizes could be reduced by up to 17 percent in weight compared to the baseline building.

4.2.3 Proposed Rehabilitation Schemes

Normally, passive energy dissipation systems are not considered for unreinforced masonry applications because it is difficult to realize sufficient deformation in these relatively stiff structures to activate typical devices. However, the vast majority of URM essential facilities in the NMSZ are one or two story structures with wooden floor and roof diaphragms. For such buildings, the flexibility of the floor diaphragm and its interaction with the walls in a building with fairly regular floor plan may provide sufficient deformation to activate inelastic deformation, and hence develop energy dissipation, in appropriately configured passive devices.

The hysteretic damper considered in this research is a tapered ductile metal flexural device similar to the ADAS device [Perry *et.al.*, 1993] presented. Such devices, even those fabricated from mild steel, are capable of developing large and stable hysteresis loops under cyclic loads and are capable of providing good and predictable energy dissipation.

Initial analysis of the 2-story URM model with square floor plan shows that the relative displacement between the center of the floor diaphragm and the top of the in-plane wall is in the order of 6 times greater than that between the diaphragm center and the out-of-plane wall. This suggests the possible use of PED devices, perhaps in connection with floor stiffening, to reduce this flexibility and therefore stabilize the out-of-plane walls. On this basis, the devices considered in this study are activated using the flexibility in the floor diaphragm. One configuration makes use of relative displacement between flexible floor diaphragms and the in-plane walls. Another potential configuration is to utilize the relative displacement between the center of the flexible diaphragm and the ground or the floor below. These implementations are called Type 1 and Type 2 rehabilitation schemes, respectively.

4.2.3.1 Type 1 Rehabilitation Scheme

The concept behind the Type 1 rehabilitation scheme is to utilize the differential displacement between the flexible floor (or roof) diaphragm and the much stiffer in-plane walls to activate the hysteretic devices. The actual application could be in a number of different forms involving either distributed deformation or transfer (via braces or link beams) to a localized device. An implementation of the devices using a link beam and localized PED device is shown in Figure 4.18. In this figure, wall 2 of the URM building is removed from the view in order to better see the implementation of the PED devices. It is assumed that the device will respond only to seismic input in a direction perpendicular to the link beam. A relatively stiff link beam is used to connect between the two in-plane walls (wall A and wall B). The PED device is then attached between the middle of the link beam and center of the diaphragm. Provided that the lateral stiffness (and possibly the torsional stiffness for eccentric connections) of the link beam is relatively high, the displacement at the middle of the link beam is comparable to that of the in-plane walls. The PED device then sustains relative displacement between center of the diaphragm and the in-plane walls, and energy dissipation is developed when the device deforms inelastically.

4.2.3.2 Type 2 Rehabilitation Scheme

Because of the flexibility of the diaphragm, high differential displacement between the center of the diaphragm and the ground is also expected. The Type 2 scheme makes use of this differential movement directly to trigger inelastic deformation and, consequently, energy dissipation in a PED device connected between the floor diaphragm and the ground. The second floor implementation may be less effective, but definitely is possible. In order to capture this differential displacement, a simple chevron-brace frame is used to support the PED device relative to the floor diaphragm. A very stiff chevron-brace system is desirable in such a scheme, and it seems reasonable to think that such a design could be incorporated in a rehabilitation

project. Figure 4.19 illustrates the application of a Type 2 rehabilitation scheme in unreinforced masonry building. Wall A and wall 2 are omitted from the URM building in the figure for better view of the PED devices. In this illustration it is assumed that the device will respond to seismic input in the direction of the chevron-brace plane.

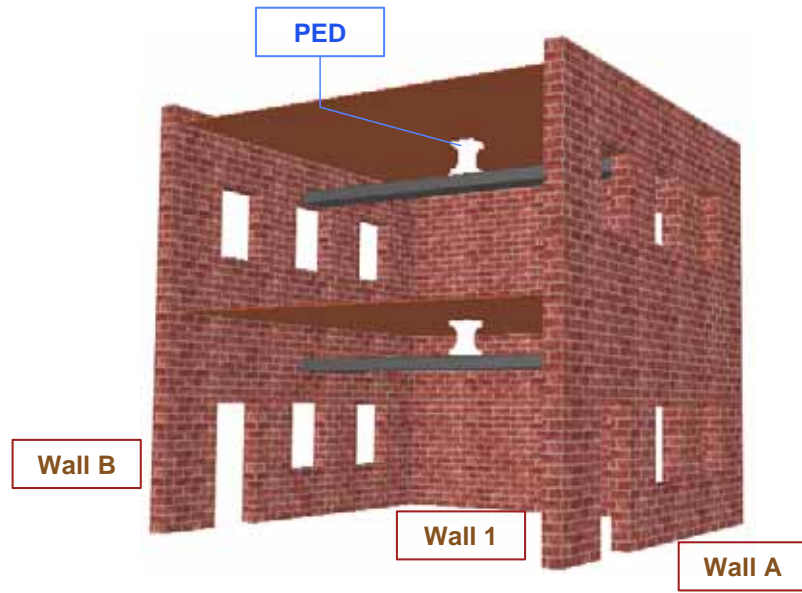

Figure 4.18: Type 1 Rehabilitation Scheme

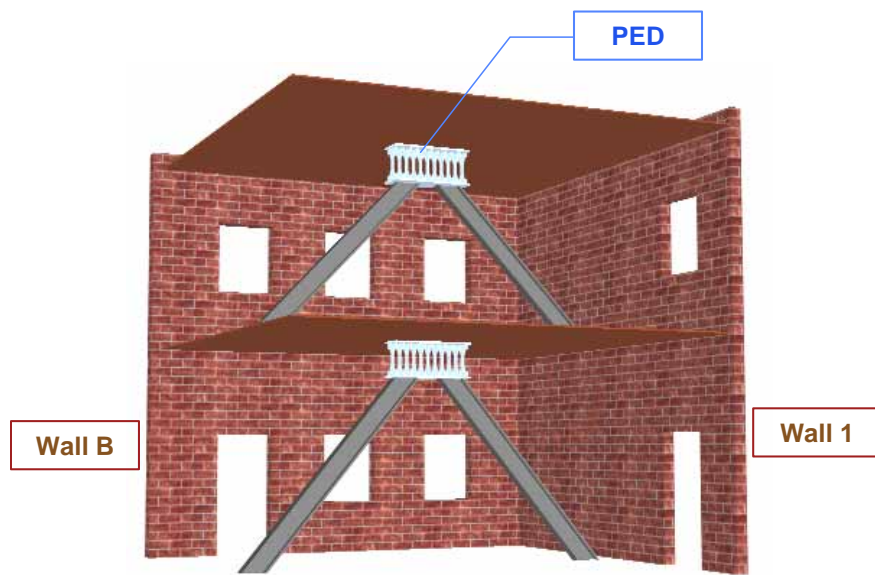

Figure 4.19: Type 2 Rehabilitation Scheme

4.2.3.3 Analytical Models

Chapter 4.1 of this report has presented the use of DRAIN-2DX spring elements to construct models of the URM building with nonlinear behaviors. The model is constructed using the DRAIN TYPE 04 zero-length nonlinear spring. Figure 4.20 shows a schematic of this simple spring model in which the zero-length springs and nodes are separated in order to show the model topology. Wall A and, on the opposite side, wall B represent the in-plane walls, while wall 1 and wall 2 represent the out-of-plane walls. The masses of the in-plane walls, out-of-plane walls, and diaphragms are lumped at the floor level, as shown in Figure 4.20.

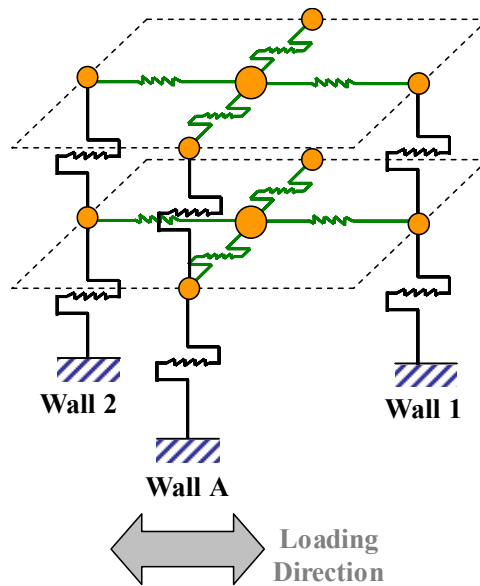

Figure 4.20: Simplified Composite Spring Model for the URM Test Structure

The basic well-designed hysteretic metallic PED device can be represented by a nonlinear spring element. As a result, it is a relatively simple matter to introduce the PED device into the building model simply by adding another TYPE 04 spring in the appropriate place(s). For a Type 1 PED device design, this spring is introduced between the in-plane wall and diaphragm masses as shown in Figure 4.21a. For the Type 2 PED device design, the spring is introduced between the diaphragm mass and the ground as shown in Figure 4.21b. For clarification purpose, only the first story parts of the model are shown in these figures. In addition, since there is no explicit

interaction between the out-of-plane walls and the PED devices, the representation of the out-of-plane walls is also omitted from the figures. The two in-plane walls are connected to each other through the springs representing the shear stiffness of the diaphragm (DIA_S).

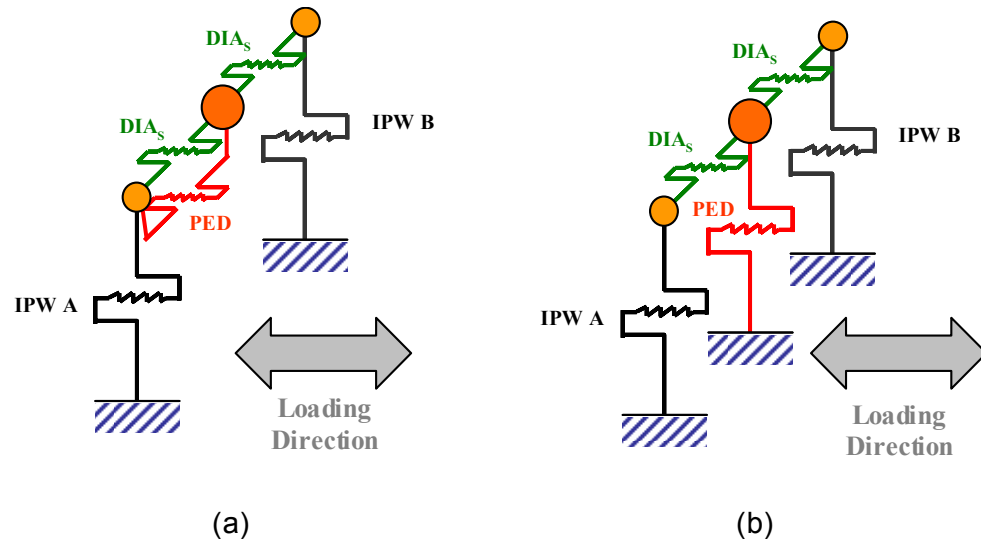

Figure 4.21: Part of the Composite Spring Model with (a) Type 1 Rehabilitation Scheme, and (b) Type 2 Rehabilitation Scheme

The stiffness of the link beam used with the Type 1 design or the stiffness of the brace used to support the Type 2 design will clearly reduce the available differential displacement across the PED device and therefore reduce its potential performance capability. However, this less-than-ideal behavior is not taken into consideration in the current study.

4.2.3.4 Hysteretic Model of Metallic Dampers

As previously mentioned, the energy dissipation mechanism in the metallic dampers results from their inelastic deformations. Numerous mathematical models have been proposed to simplify the force-displacement relationship of the metallic substances. Two of the simplest and most well-known models are the elastic-perfectly plastic model (Figure 4.22a) and the elastic-linear strain hardening model (Figure 4.22b). These models present reasonably good comparisons with the experimental results for well-designed PED devices.

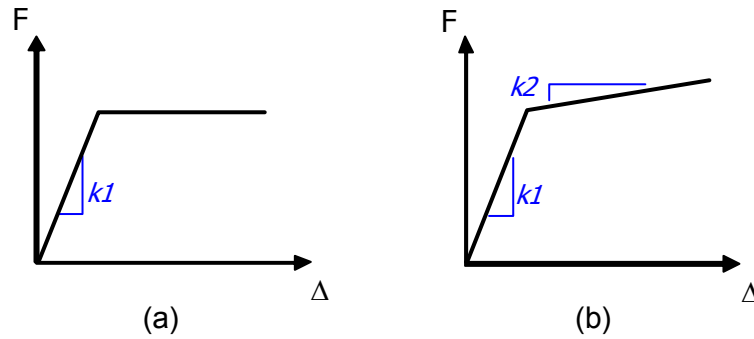

Figure 4.22: Force-Displacement Relationship with (a) Elastic-Perfectly Plastic Behavior, and (b) Elastic-Linear Strain Hardening Behavior

Furthermore, in order to develop the hysteretic model for the metallic dampers, material behavior under load reversals must be considered. The unloading branch of the force-displacement curve is assumed parallel to the initial loading path until it reaches another yield point in the reversed direction. The loading-unloading process will be repeated as the external cyclic loading continues.

An experimental result by Pinelli *et.al.* [1993] (Figure 4.17) displays the hysteretic loops of the metallic tapered devices. An occurrence of the strain hardening behavior is obvious in the post yield region. As a result, this hysteretic behavior is best modeled by the elastic-linear strain hardening model. Figure 4.23 illustrates a typical metallic damper hysteretic model in this research. This kind of behavior is easily modeled using the DRAIN-2DX TYPE 04 nonlinear zero-length spring element.

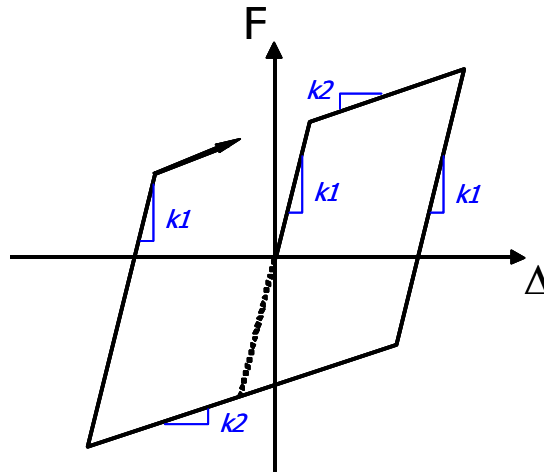

Figure 4.23: Idealized Bilinear Force-Displacement Relationship

4.2.4 Effect of Diaphragm Stiffness

As mentioned previously, the flexibility of the floor diaphragms is a key issue in the utilization of a passive rehabilitation system. Further investigations on the effects of diaphragm stiffness are performed. The ratio of the energy dissipated in the PED device to the total input seismic energy (labeled as the “energy ratio”) is computed as the shear stiffness of the floor diaphragm is varied. Figure 4.24 shows the relationship between the energy ratio and the shear stiffness of the floor diaphragm normalized to the stiffness of the in-plane wall. The vertical lines (error bars) capture a variation due to different ground motion inputs. This figure shows a rapid decrease in the energy dissipation ratio as the diaphragm shear stiffness gets higher. The curve confirms our early assumption that the energy dissipation capability of the PED devices will be more promising when the floor diaphragm is more flexible.

Generally, the maximum displacements (or drifts) are of interest in the case of unreinforced masonry structures. Figure 4.25 demonstrates how the diaphragm shear stiffness affects the maximum displacement at the diaphragm center under a suite of ground motions. Both displacements from the existing and rehabilitated structures are plotted against the diaphragm shear stiffness ratio. The maximum displacement from the existing structure is shown

with a darker line, while that of a rehabilitated one is shown with a lighter line. The maximum displacements for both cases are almost identical when the stiffness ratio is relatively high (the diaphragm shear stiffness is around 20% or more of in-plane wall elastic stiffness). This means the passive control system is not effective. On the other hand, the maximum diaphragm displacement for the rehabilitated structure is much lower than that of the existing building when the diaphragm stiffness is significantly less than the in-plane wall elastic stiffness. This indicates a greater response reduction can be achieved in the rehabilitated structure, in addition to more energy dissipation, when the diaphragm is more flexible. For the URM building in this research, the diaphragm shear stiffness is approximately 1% of the elastic stiffness of the in-plane wall confirming great benefits from implementing the PED device.

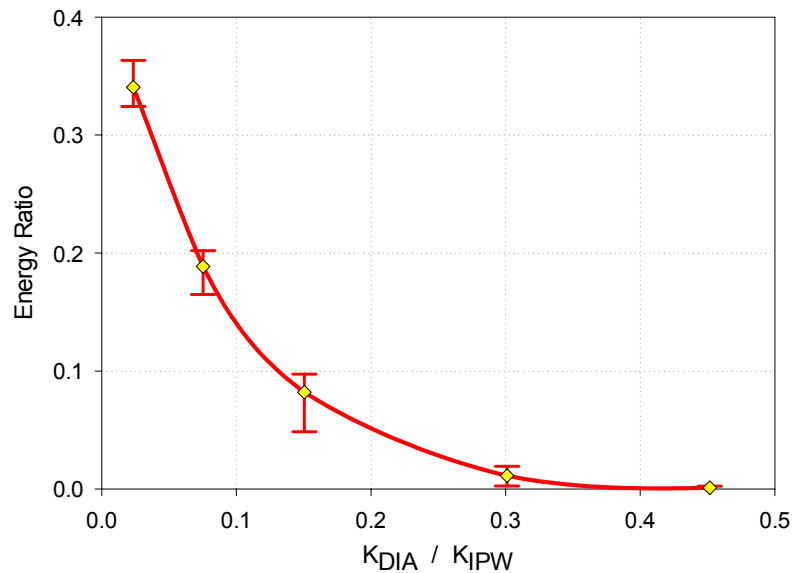

Figure 4.24: Effects of Diaphragm Shear Stiffness on the Energy Dissipation Ratio Considering a Suite of Ground Motions

Stiffening of the diaphragms is one of the typical ways for diaphragm rehabilitation. Results from a relevant research on diaphragm rehabilitation shows that typical stiffening methods would not increase the stiffness of the diaphragm beyond a few percents of the in-plane

wall stiffness. This indicates that the application of a passive energy dissipation system in conjunction with diaphragm stiffening technique is also plausible.

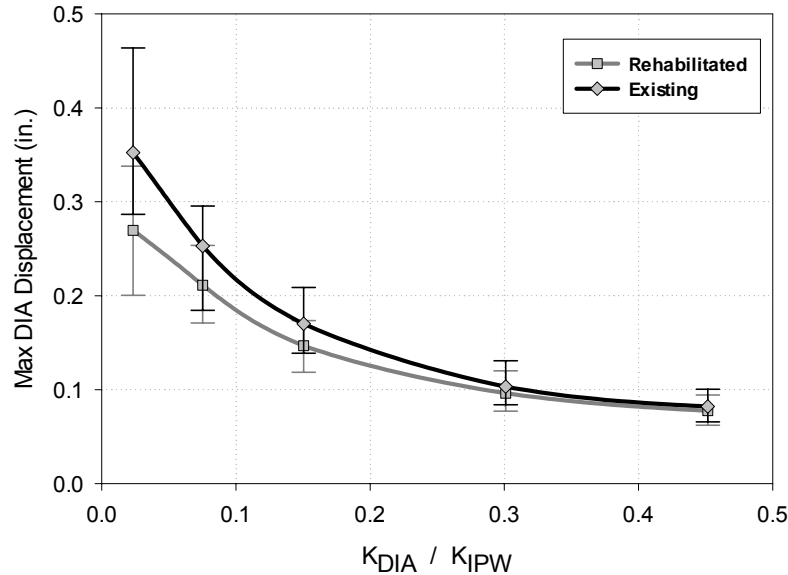

Figure 4.25: Effects of Diaphragm Shear Stiffness on the Diaphragm Maximum Displacement Considering a Suite of Ground Motions

4.2.5 Design of the Hysteretic Devices

The approach for designing the hysteretic dampers in this research follows the works done by Pinelli *et.al.* [1993], Goodno *et.al.* [1998], and Craig *et.al.* [2002]. The PED device itself is designed using an energy-based formulation. In this approach, the system is designed such that it maximizes the amount of the energy dissipation in the devices and, hence, minimizes the demand in the primary structural elements.

4.2.5.1 Design Objectives and Constraints

For a structure to resist an earthquake excitation in an economical and feasible way, part of the energy must be dissipated through viscous or hysteretic damping. However, hysteretic damping is often associated with yielding and damage to the structural members, formation of plastic hinges, and possibly collapse of the structure. Alternatively, many of the so-called energy

dissipators developed in recent years aim at concentrating the dissipation, either viscous or hysteretic, away from the structural members, in a few pre-engineered elements. This is exactly the idea behind the tapered PED device.

In order to identify the best possible design for a PED device, the following criterion is adopted [Pinelli *et.al.*, 1996]:

The best design will be the one that provides the highest ratio E_C/E_i ,

where E_C is the total hysteretic energy dissipated in all the devices, and E_i is the relative energy input to the structure at the end of the motion. The term E_C/E_i is referred to as an “energy ratio” or a “dissipating energy ratio” in this research.

The design process can easily be cast into the form of a simple nonlinear optimization process with the energy ratio as the objective function and appropriate constraints added for the maximum force in the PED device, stiffness and dynamic ductility, for example:

1. The ductility demand on any of the PED devices should not exceed an allowable value defined for each particular energy dissipator (*e.g.*, based on laboratory tests);
2. PED device physical geometry and fabrication constraints (these are not explicitly considered in the present study).

The E_C/E_i criterion takes the fullest advantage of the energy dissipation property of the PED devices. Pinelli *et.al.* [1996] showed that satisfaction of this design criterion would ensure that little hysteretic energy was dissipated in the structural members, and that the overall seismic response of the building was reduced.

A critical issue in the design of the PED device is the definition of ductility. The traditional definition of ductility, as the ratio of maximum displacement to yield displacement, provides only limited information to designers in the case of systems subjected to random vibrations with varying amplitudes. It overlooks important parameters like the number of cyclic

reversals and the energy dissipated by the system. Here, a more comprehensive definition of ductility due to McCabe and Hall [1989] has been adopted.

McCabe and Hall [1989] assumed that the damage suffered by an elasto-plastic structural steel system during an earthquake is similar to a low cycle fatigue phenomenon. Based on their work, it is possible to predict an equivalent monotonic ductility, μ_p , for a system subjected to an arbitrary cyclic loading. This equivalent monotonic plastic ductility, or ductility demand, is the maximum plastic ductility that the system should exhibit in a monotonic loading test in order to dissipate the same amount of energy as that obtained during the cyclic loading. The equivalent monotonic plastic ductility demand on the system can be evaluated in terms of energy, and load reversals, as:

$$\mu_p = \frac{H_t}{f_y u_y (2N_f)^{0.4}} \quad (4.14)$$

where H_t is the total hysteretic energy dissipated in the system during N_f load reversals; and f_y and u_y are the yield load and yield displacement of the system.

4.2.5.2 Design Variables

The design criterion as stated above is, in fact, a classical constrained optimization problem. The objective function to be optimized (or maximized in this case) is the energy ratio E_c/E_i . The design variables for the present optimization process are direct properties of the PED device, and they include, (a) the elastic stiffness, and (b) the yield capacity of the metallic devices. The use of only 2 design variables makes it somewhat easier to graphically describe the design space since a simple Cartesian 3-dimensional surface or a 2-dimensional contour plot can be used to describe the objective function, and the constraints can be readily superposed. It should be noted that for more complicated cases involving more design variables, a numerical optimization procedure could also be employed to compute the design parameters directly. However, in most

cases little or no information about the design space itself is revealed. For the present study, a grid of values of the objective (energy ratio) and constraint (dynamic ductility demand) functions are computed and plotted as superposed contour plots.

Based on the energy ratio criterion, the damage in the main structural components, if at all occurs, is minimal. Instead, damages will be concentrated in the pre-designed hysteretic devices where most of the hysteretic energy takes place. In terms of performances, rehabilitated URM buildings are expected to experience less response (*i.e.*, displacement, acceleration) due to an earthquake. The following sections describe the design process and outcomes for both Type 1 and Type 2 rehabilitation schemes in details.

4.2.5.3 Design Optimization

The design process can be formulated as a straightforward numerical optimization process in which an objective function (E_c/E_i) as computed using DRAIN-2DX must be maximized with respect to PED device design variables, elastic stiffness (k) and yield force (f_y), and with constraints on the maximum allowable dynamic ductility. A number of powerful, versatile, and widely available numerical methods could be used but are not in this study. Rather, a purely graphical process is manually implemented in which the objective function is numerically evaluated for a tabular array of different design variables (PED device elastic stiffness and yield force) spanning the design space under investigation. In addition, the resulting dynamic ductility demand for each case is also computed and recorded. The result of these calculations is a grid of values of the objective function and constraint values (dynamic ductility demand) that could be plotted as superposed 2-dimensional contour plots.

Type 1 Rehabilitation Scheme

A number of test cases are investigated using the Type 1 PED device model subjected to a reference suite of ground accelerations. In the case of an essential facility, it is more appropriate that the protective system is designed based on the maximum credible earthquakes

PROJECT DS-5 FINAL REPORT

(BSE-2 level earthquakes based on FEMA [2000a]). A suite of the Memphis synthetic ground motions [Wen and Wu, 2001] with 2% probability of exceedance in 50 years is considered in the design of the PED devices. A contour plot for determining an optimal design of the PED devices is generated specific to each ground motions in the suite.

The yield force and elastic stiffness of the PED devices are varied from 1 to 15 kips and from 10 to 120 kips/in, respectively, resulting in a total of 345 analysis cases. DRAIN-2DX computes the objective energy ratio and the constraint dynamic ductility for each analysis case. An example of the resulting contour plot from a particular earthquake is shown in Figure 4.26. Contour lines of the energy ratios and dynamic ductility demand are superimposed over the design space. The contour lines for the energy ratio are shown as solid gray lines while the contour lines for the plastic ductility demand are shown as solid black lines.

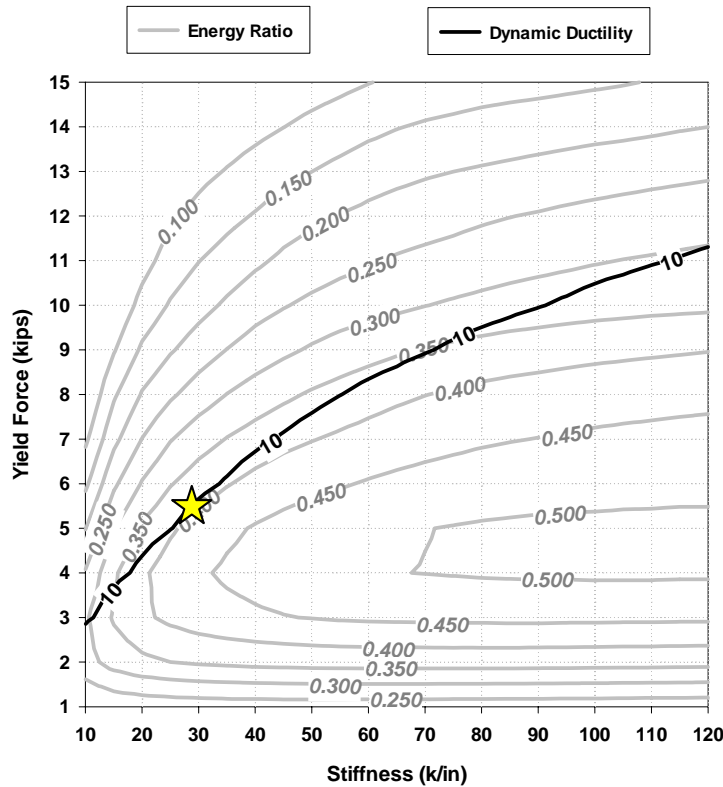

Figure 4.26: Example Contour Plots of the Energy Ratio and Dynamic Ductility

When the dynamic ductility is considered as a constraint in order to represent the finite deformation capacity of the devices (before fracture), the optimal solutions can be limited by the superposed dashed curves. Based on a laboratory test of tapered flexure PED devices [Pinelli *et.al.* 1996] similar to the ones considered in this research, it is reasonable to allow dynamic ductility demands of no greater than about 10. Using this constraint value, the optimal design can be found along the ductility constraint line where the highest energy ratio presents. A star in Figure 4.26 shows the optimal design point of the PED devices for this particular ground motion. The objective contours indicate that by adding the PED devices with their properties corresponding to the optimal values into the existing structure, approximately 40% of the input seismic energy can be dissipated.

For better visualization of the optimal design of the PED devices, the 2-dimensional contour plot is converted to a design curve. This design curve is constructed by reading the values for the energy ratio and the elastic stiffness along the constraint curve at each increasing discrete levels of the yield force. Next, a plot of the energy ratio versus the corresponding elastic stiffness can be drawn for increasing levels of the yield force. The optimal design is defined at the peak of the curve where the energy ratio reaches its maximum. An example of the design curve can be seen from Figure 4.27.

Another important point is that the optimal solution of the PED device design is dependent of the earthquake ground motion used in the analysis. A straightforward solution is to design the PED devices corresponding to all of the earthquakes in a suite and evaluate the building performances when subjected to all other earthquakes. The final design is selected from the design that provides the best overall building performances. However, this is a very time-consuming process, and it may also be possible that no single design provides the “best” performance when earthquakes with various characteristics are considered. This research takes a simpler step by pre-selecting a few earthquakes from the suite that are believed to cause the most

PROJECT DS-5 FINAL REPORT

damage to the structure and using them as a basis in the design. The earthquakes are selected based on various intensity measures that have been found to correlate well with structural damage [Kramer, 1996]. These intensity parameters include the peak ground acceleration (PGA), the effective duration of (T), the ratio between the peak velocity and the peak acceleration (V/A), and the spectral acceleration at the fundamental period of the structure (S_a). Table 4.14 lists the Memphis synthetic earthquakes with their intensity parameters with the maximum values in each category underlined. From this table, it appears that 3 ground motions (m02_05s, m02_08s, and m02_10s) may be appropriate as design earthquakes.

The design curves for these 3 particular earthquakes are constructed and are displayed in Figure 4.27. The optimal solution of the design is obtained from the peak of each curve. For conservatism, the lowest curve is used for selecting the optimal design. In this case the optimal design is found to be 6 kips and 19 kips/inch for the yield force and elastic stiffness of the PED devices, respectively.

Table 4.14: Memphis Synthetic Ground motions and their Intensity Measures

Earthquakes	PGA (in/s ²)	V/A (sec)	Duration (sec)	S_a @ 0.52 sec (g)
m02_01s	430	0.1352	30.67	3.04
m02_02s	326	0.1327	21.46	2.41
m02_03s	353	0.1381	20.24	1.95
m02_04s	317	0.1347	55.32	2.76
m02_05s	<u>466</u>	0.1400	<u>57.82</u>	2.52
m02_06s	408	0.1539	43.51	2.77
m02_07s	358	0.1429	23.01	2.29
m02_08s	286	<u>0.2255</u>	18.04	2.71
m02_09s	328	0.1286	22.18	2.18
m02_10s	405	0.1364	19.68	<u>3.74</u>

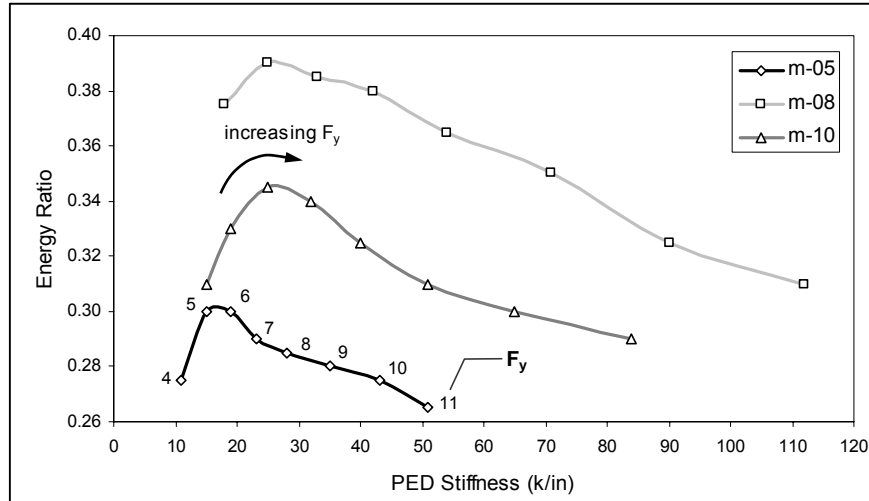

Figure 4.27: Design Curves for the Type 1 PED Device with Ductility Demand Constraint of 10

Type 2 Rehabilitation Scheme

A design process for the Type 2 scheme is similar to that of the Type 1 scheme. A grid of energy ratio and dynamic ductility demand values computed from over 300 cases is used to construct the superimposed contour plots. Similar to the Type 1 scheme, the ductility constraint of 10 is implemented for the Type 2 scheme as well. The resulting design curves for the Type 2 scheme are presented in Figure 4.28.

The optimal design for the PED devices with Type 2 configuration is found to be 13 kips and 86 kips/inch for the yield force and elastic stiffness of the PED devices, respectively.

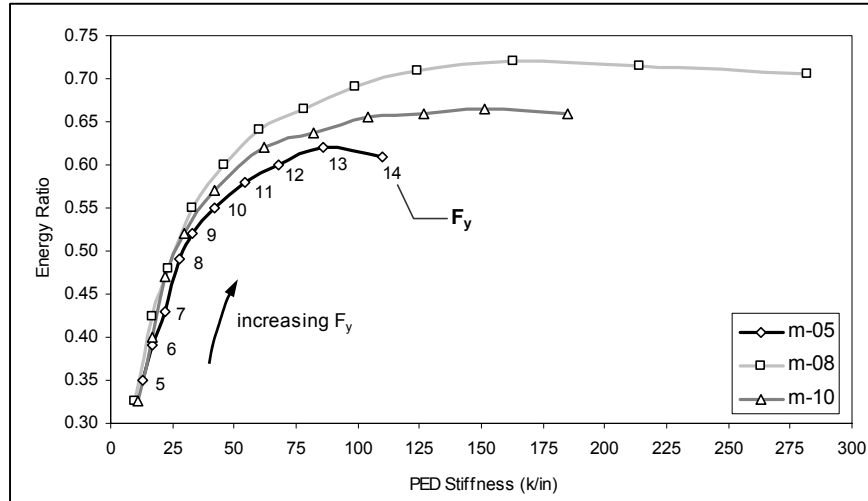

Figure 4.28: Design Curves for the Type 2 PED Device with Ductility Demand Constraint of 10

4.2.6 Seismic Response of the Rehabilitated Building

The energy-based design criterion ensures that a large portion of the seismic input energy is absorbed by the supplemental energy dissipation devices and, hence, reducing energy dissipation demand and possible damage in the main structural components. In addition, an increase in supplemental damping and stiffness from the added devices may also help in improving building seismic responses (*i.e.*, displacements or accelerations). Evaluation of the rehabilitated URM building subjected to potential earthquakes is presented in this section.

As presented in Section 4.1, the maximum inter-story drift is used for quantifying levels of damage according to FEMA [2000a]. Maximum drifts from the URM building that incorporates the optimal PED device designs are computed for every Memphis artificial ground motions and are listed in Table 4.15 and Table 4.16 for the Type 1 and Type 2 rehabilitation schemes, respectively.

A comparison between the maximum drifts obtained from the existing building and the building rehabilitated with the PED devices reveals that the addition of the PED devices not only reduces the energy dissipation demands in the primary structures, it also has an effect on reducing the drift responses in the URM building under investigation.

PROJECT DS-5 FINAL REPORT

The case with Type 2 rehabilitation scheme shows better performance than that of Type 1 scheme. The building’s maximum drift demands, in most of the time, conform to the enhanced objective for essential facilities. On the other hand, the Type 1 scheme, even though achieving a major improvement, still fails to fulfill the Life Safety requirement under strong earthquakes (BSE-2 with 2% probability of exceedance in 50 years). Fluctuation in the computed building drifts is considerably high as due primarily on the random characteristics of the earthquakes. Fragility assessment of these Type 1 and Type 2 rehabilitated buildings takes into account the uncertainties in both earthquakes and structure and, consequently, provides the likelihood of damage as will be shown in subsequent sections.

Table 4.15: Comparison of the Computed Maximum Inter-Story Drifts for Existing and Type 1 Rehabilitated URM Buildings

Ground Motions	Maximum Drift (%)		Percent Reduction	Ground Motions	Maximum Drift (%)		Percent Reduction
	Rehabilitated	Existing			Rehabilitated	Existing	
m10_01s	0.142	0.167	14.7	m02_01s	0.840	1.250	32.8
m10_02s	0.167	0.209	20.0	m02_02s	0.709	0.973	27.1
m10_03s	0.100	0.136	26.3	m02_03s	0.815	0.975	16.3
m10_04s	0.165	0.178	7.5	m02_04s	0.945	1.390	32.0
m10_05s	0.193	0.201	4.2	m02_05s	0.737	1.003	26.5
m10_06s	0.140	0.181	22.8	m02_06s	0.944	1.187	20.5
m10_07s	0.152	0.275	44.5	m02_07s	0.652	1.020	36.1
m10_08s	0.191	0.224	14.7	m02_08s	0.747	1.192	37.3
m10_09s	0.246	0.269	8.5	m02_09s	0.876	1.256	30.3
m10_10s	0.108	0.157	31.2	m02_10s	0.921	1.342	31.4
Mean	0.160	0.200	19.5	Mean	0.819	1.159	29.0
COV	0.27	0.23	0.63	COV	0.13	0.13	0.23

PROJECT DS-5 FINAL REPORT

Table 4.16: Comparison of the Computed Maximum Inter-Story Drifts for Existing and Type 2 Rehabilitated URM Buildings

Ground Motions	Maximum Drift (%)		Percent Reduction	Ground Motions	Maximum Drift (%)		Percent Reduction
	Rehabilitated	Existing			Rehabilitated	Existing	
m10_01s	0.112	0.167	32.9	m02_01s	0.508	1.250	59.3
m10_02s	0.094	0.209	55.1	m02_02s	0.424	0.973	56.4
m10_03s	0.096	0.136	29.6	m02_03s	0.447	0.975	54.2
m10_04s	0.105	0.178	41.4	m02_04s	0.466	1.390	66.5
m10_05s	0.098	0.201	51.2	m02_05s	0.451	1.003	55.1
m10_06s	0.090	0.181	50.0	m02_06s	0.610	1.187	48.6
m10_07s	0.119	0.275	56.7	m02_07s	0.431	1.020	57.8
m10_08s	0.148	0.224	33.8	m02_08s	0.462	1.192	61.2
m10_09s	0.079	0.269	70.8	m02_09s	0.466	1.256	62.9
m10_10s	0.070	0.157	55.0	m02_10s	0.512	1.342	61.9
Mean	0.101	0.200	47.7	Mean	0.478	1.159	58.4
COV	0.22	0.23	0.27	COV	0.12	0.13	0.10

4.2.7 Fragility Assessment

As randomness is inherent in the problem, a deterministic assessment of building’s seismic performances may not be sufficient. As a result, probabilistic description of the URM buildings with hysteretic damping devices would be more appropriate. The proposed approach of using the response surface metamodels is again implemented for fragility computation. Fragility curves can be used as an indicator for assessing an improvement on the damage likelihood in the URM firehouse when the metallic PED devices are implemented.

The structural uncertainties follow those defined previously for the existing building in Section 4.1 (Table 4.11). They include the masonry density, elastic modulus, shear strength, and the building’s damping ratio. It is assumed that the PED system is well constructed that the level of uncertainty in its properties is statistically insignificant compared to those of the earthquakes

and the URM material properties. As a result, the properties of the PED device are assumed to remain deterministic in this research. In terms of seismic uncertainty, it is taken into consideration by utilizing a suite of artificial earthquakes. The ground motions generated specifically for Memphis, TN are used in the same way as in Section 4.1 for the existing URM building.

4.2.7.1 Response Surface Model Generation

The maximum inter-story drift that the building experiences over the duration of an earthquake defines the level of damage. Response surface models are sought to relate this damage measure to those structural uncertainty parameters as well as the earthquake intensity parameter. It was obvious that Approach 3 (see details in Chapter 3) provides comparable outcomes while only requiring a fraction of the computational expenses compared to the other 2 approaches. In Approach 3, the response surfaces for the mean (y_{μ}) and the standard deviation (y_{σ}) of the maximum drifts due to a suite of earthquakes are constructed. The input variables for the response surface polynomial and their ranges are described in Table 4.12. Note that in this chapter, the range of the spectral acceleration (S_a) is expanded (0.1g to 2.9g) in order to accommodate the potentially shift-to-the-right fragility curves. All other parameters (structural uncertainties) remain the same as those for the existing building.

The special scheme of the Central Composite Design (CCD) is then used to assemble combinations of input variables. Nonlinear time-history analyses are performed on the rehabilitated buildings (both with Type 1 and Type 2 schemes) for each combination to complete the DOE table (Table 4.17 and Table 4.18 for Type 1 and Type 2 Rehabilitation schemes, respectively).

PROJECT DS-5 FINAL REPORT

Table 4.17: Design of Experiments Table for the Type 1 Rehabilitated Building

Case	x_1	x_2	x_3	x_4	x_5	Mean (y_μ)	Std Dev (y_σ)
1	-1	-1	-1	-1	-1	0.045	0.011
2	-1	-1	-1	1	1	1.026	0.212
3	-1	-1	1	-1	1	1.130	0.264
4	-1	-1	1	1	-1	0.041	0.010
5	-1	0	0	0	0	0.461	0.096
6	-1	1	-1	-1	1	0.808	0.201
7	-1	1	-1	1	-1	0.028	0.007
8	-1	1	1	-1	-1	0.032	0.008
9	-1	1	1	1	1	0.775	0.202
10	0	-1	0	0	0	0.609	0.109
11	0	0	-1	0	0	0.535	0.112
12	0	0	0	-1	0	0.554	0.116
13	0	0	0	0	-1	0.039	0.010
14	0	0	0	0	0	0.536	0.113
15	0	0	0	0	1	1.039	0.233
16	0	0	0	1	0	0.519	0.110
17	0	0	1	0	0	0.536	0.112
18	0	1	0	0	0	0.460	0.095
19	1	-1	-1	-1	1	1.425	0.430
20	1	-1	-1	1	-1	0.053	0.007
21	1	-1	1	-1	-1	0.059	0.009
22	1	-1	1	1	1	1.368	0.385
23	1	0	0	0	0	0.579	0.111
24	1	1	-1	-1	-1	0.040	0.010
25	1	1	-1	1	1	1.007	0.225
26	1	1	1	-1	1	1.086	0.239
27	1	1	1	1	-1	0.036	0.009

PROJECT DS-5 FINAL REPORT

Table 4.18: Design of Experiments Table for the Type 2 Rehabilitated Building

Case	x_1	x_2	x_3	x_4	x_5	Mean (y_μ)	Std Dev (y_σ)
1	-1	-1	-1	-1	-1	0.024	0.007
2	-1	-1	-1	1	1	0.616	0.176
3	-1	-1	1	-1	1	0.662	0.216
4	-1	-1	1	1	-1	0.022	0.006
5	-1	0	0	0	0	0.236	0.054
6	-1	1	-1	-1	1	0.456	0.128
7	-1	1	-1	1	-1	0.016	0.005
8	-1	1	1	-1	-1	0.018	0.006
9	-1	1	1	1	1	0.445	0.130
10	0	-1	0	0	0	0.333	0.083
11	0	0	-1	0	0	0.277	0.064
12	0	0	0	-1	0	0.280	0.064
13	0	0	0	0	-1	0.024	0.007
14	0	0	0	0	0	0.275	0.063
15	0	0	0	0	1	0.629	0.180
16	0	0	0	1	0	0.272	0.061
17	0	0	1	0	0	0.275	0.063
18	0	1	0	0	0	0.252	0.056
19	1	-1	-1	-1	1	0.832	0.214
20	1	-1	-1	1	-1	0.032	0.010
21	1	-1	1	-1	-1	0.035	0.011
22	1	-1	1	1	1	0.801	0.203
23	1	0	0	0	0	0.317	0.078
24	1	1	-1	-1	-1	0.025	0.007
25	1	1	-1	1	1	0.645	0.186
26	1	1	1	-1	1	0.677	0.206
27	1	1	1	1	-1	0.023	0.006

PROJECT DS-5 FINAL REPORT

The response surface models are represented by simple polynomial functions. A least-square regression technique is used to derive the polynomial coefficients. The response surface models for the mean (\hat{y}_μ) and standard deviation (\hat{y}_σ) of the maximum drifts in the URM building rehabilitated with the Type 1 scheme are expressed as follows:

$$\begin{aligned} \hat{y}_\mu = & 0.528 + 0.073x_1 - 0.082x_2 + 0.005x_3 - 0.018x_4 + 0.516x_5 - \\ & 0.007x_1^2 - 0.009x_2x_1 + 0.008x_2^2 - 0.003x_3x_1 + 0.001x_3x_2 + \\ & 0.009x_3^2 - 0.001x_4x_1 + 0.003x_4x_2 + 0.007x_4x_3 + 0.01x_4^2 + \\ & 0.069x_5x_1 - 0.076x_5x_2 + 0.006x_5x_3 - 0.016x_5x_4 + 0.012x_5^2 \end{aligned} \quad (4.15)$$

and

$$\begin{aligned} \hat{y}_\sigma = & 0.104 + 0.023x_1 - 0.025x_2 + 0.001x_3 - 0.007x_4 + 0.128x_5 + \\ & 0.001x_1^2 - 0.017x_2x_1 - 0.002x_2^2 - 0.005x_3x_1 + 0.001x_3x_2 + \\ & 0.009x_3^2 - 0.001x_4x_1 + 0.005x_4x_2 + 0.018x_4x_3 + 0.009x_4^2 + \\ & 0.025x_5x_1 - 0.026x_5x_2 + 0.001x_5x_3 - 0.007x_5x_4 + 0.018x_5^2 \end{aligned} \quad (4.16)$$

Similarly, the least-square regression analysis derives the response surface polynomial functions for the Type 2 rehabilitation scheme based on Table 4.18. The models are presented as follows:

$$\begin{aligned} \hat{y}_\mu = & 0.278 + 0.05x_1 - 0.044x_2 + 0.002x_3 - 0.008x_4 + 0.308x_5 - \\ & 0.002x_1^2 + 0.004x_2x_1 + 0.014x_2^2 - 0.002x_3x_1 + 0.001x_3x_2 - \\ & 0.002x_3^2 + 0.001x_4x_1 + 0.002x_4x_2 - 0.005x_4x_3 - 0.002x_4^2 + \end{aligned} \quad (4.17)$$

$$0.046x_5x_1 - 0.041x_5x_2 + 0.002x_5x_3 - 0.007x_5x_4 + 0.048x_5^2$$

and

$$\begin{aligned} \hat{y}_\sigma = & 0.065 + 0.011x_1 - 0.011x_2 + 0.003x_3 - 0.004x_4 + 0.087x_5 + \\ & 0.001x_1^2 + 0.006x_2x_1 + 0.004x_2^2 - 0.002x_3x_1 - 0.001x_3x_2 - \\ & 0.002x_3^2 + 0.001x_4x_1 + 0.002x_4x_2 - 0.007x_4x_3 - 0.002x_4^2 + \\ & 0.009x_5x_1 - 0.009x_5x_2 + 0.003x_5x_3 - 0.004x_5x_4 + 0.028x_5^2 \end{aligned} \quad (4.18)$$

4.2.7.2 Response Surface Model Validation

In order to examine the prediction accuracy of the response surface models, 100 additional random combinations of the input variables are generated. The maximum drifts are computed by DRAIN-2DX nonlinear dynamic analysis (y_i) and the response surface model (\hat{y}_i) for each combination of inputs. A graphical comparison is obtained by plotting the actual values (DRAIN-2DX) against the predicted values (response surface) as shown in Figure 4.29 and Figure 4.30. It is apparent from those comparisons that the response surface models are able to predict the maximum drifts well. Furthermore, Venter *et.al.* [1997] suggested the use of 3 quantitative measures to test the models. These measures quantify the level of error (in percentage) that the predicted responses depart from the actual ones. The expressions for the 3 measures can be found in (3.17), (3.18), and (3.19). Table 4.19 summarizes these statistical measures for both Type 1 and Type 2 rehabilitated buildings. The percentages of error in all measures are small, indicating high prediction accuracy of the response surface metamodels.

PROJECT DS-5 FINAL REPORT

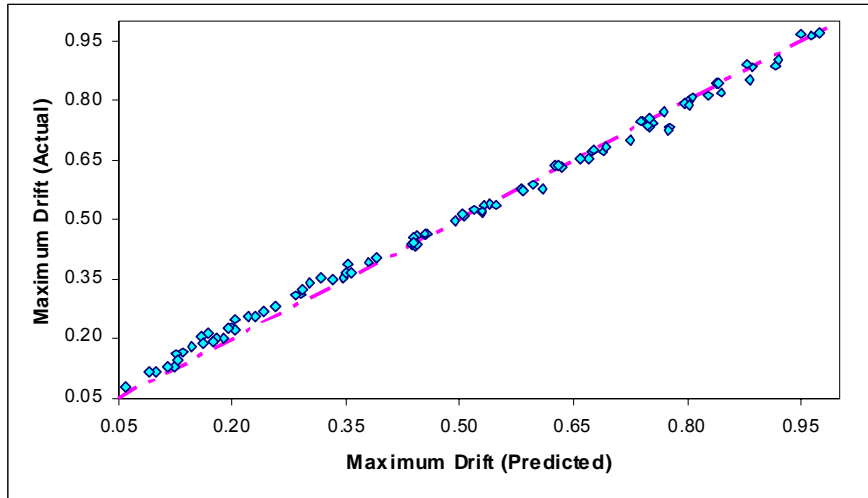

Figure 4.29: Plot of Actual Versus Predicted Maximum Drifts for the Type 1 Rehabilitated Building

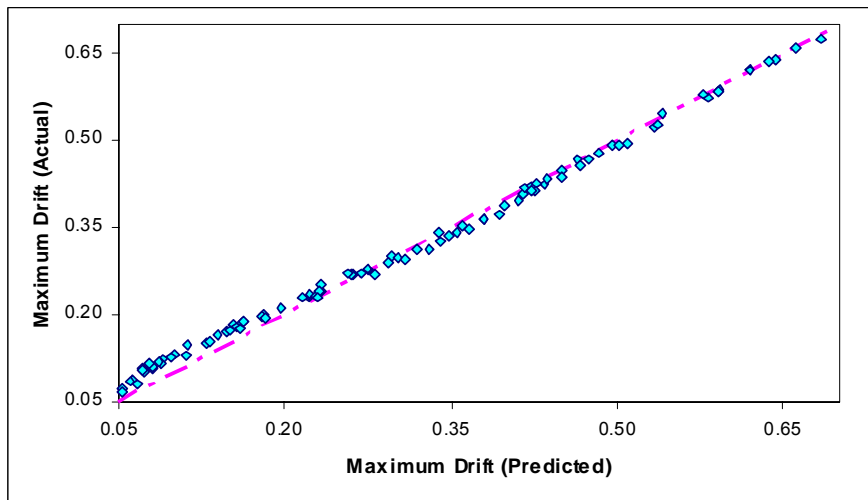

Figure 4.30: Plot of Actual Versus Predicted Maximum Drifts for the Type 2 Rehabilitated Building

Table 4.19: Computed Measures of Modeling Error

Measures	Type 1	Type 2
%AvgErr	3.2	4.5
%MaxErr	9.3	12.8
%RMSE	4.0	5.6

4.2.7.3 Response Simulation and Fragility Curves

The response surface models are evaluated at discrete levels of S_a from 0.1g to 2.9g. This process essentially produces new response surface models specific to certain values of S_a . The response surface models for the mean and the standard deviation of the maximum drifts are combined with an assumption that the drifts due to various ground motions are normally distributed. Monte Carlo simulation is performed at a specific level of earthquake intensity S_a and the fragilities or the conditional probabilities of damage are extracted. The plot of the damage probability values against the corresponding spectral acceleration values yields fragility curves for the rehabilitated URM buildings. Note that the detailed description of the process is given in Chapter 4.

The fragility curves for the IO, LS, and CP performance levels for the buildings with Type 1 and Type 2 rehabilitation schemes are presented in Figure 4.31 and Figure 4.32, respectively.

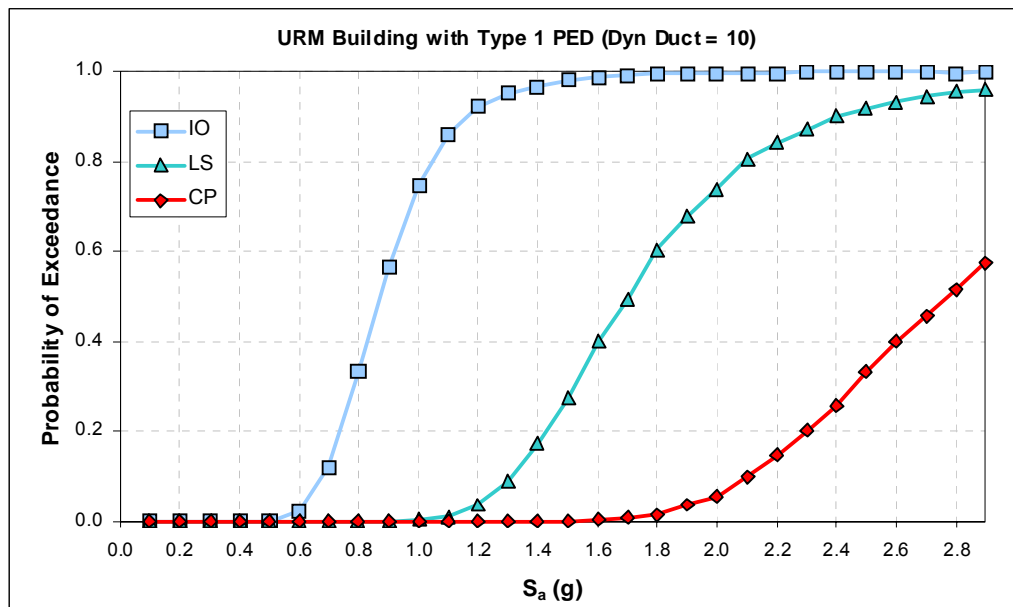

Figure 4.31: Fragility Curves of a Type 1 Rehabilitated URM Firehouse in Mid-America

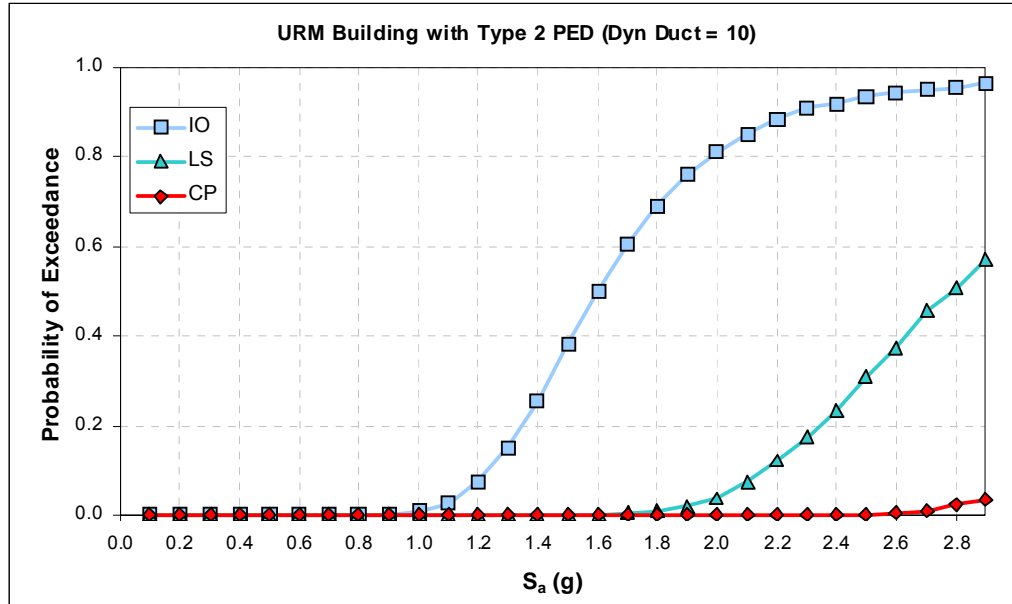

Figure 4.32: Fragility Curves of a Type 2 Rehabilitated URM Firehouse in Mid-America

4.2.7.4 Evaluation of Building Fragilities

For the URM building located in Memphis, TN (35.172 Latitude and -90.016 Longitude), the expected spectral acceleration values for the BSE-1 and BSE-2 earthquakes can be read from the USGS site-specific acceleration spectra (Figure 4.13 and Figure 4.14). In the case of the URM building with the Type 1 rehabilitation scheme, the fundamental period of the building is approximately at 0.4 second. As a result, the expected S_a values for the BSE-1 and BSE-2 earthquake events are 0.55g and 1.4g, respectively. FEMA [1997] stated that the building must conform to the Immediate Occupancy (IO) performance level under the BSE-1 events and, at the same time, to the Life Safety (LS) performance level under the BSE-2 earthquakes. In this regard, the fragility curves for the URM building with Type 1 rehabilitation scheme (Figure 4.31) are examined. It was found that there is virtually no chance that the building will be damaged beyond the IO level under the BSE-1 earthquakes. However, there exists 17% chance that the building drift will go in excess to the LS limit if the BSE-2 earthquakes were to happen. Even though the Type 1 scheme does not guarantee buildings' operability under stronger earthquakes,

it still provides a significant improvement in building performance over that of the existing building in Memphis.

For the Type 2 rehabilitation scheme, the building has a fundamental period of 0.27 second resulting in the spectral acceleration of 0.57g and 1.4g for BSE-1 and BSE-2 earthquakes, respectively. The fragility curves for the Type 2 scheme (Figure 4.32) reveal that it is statistically likely that the rehabilitated URM building will perform well and achieve the enhanced safety objective under future earthquakes.

In conclusion, it is found in this research that the use of the metallic tapered energy dissipation devices, which was once thought inappropriate, can be a viable option for seismically upgrading URM low-rise buildings. The devices not only lessen the seismic energy dissipation demand in the structures, but they are also effective in reducing the seismic response such as story drifts in the buildings.

However, there are several practicality issues that should be stated. Significant improvement in building seismic performance in this research may be due largely to the assumptions of an ideal condition such as the perfect connectivity of the PED device to the URM wall and diaphragm components or the infinitely rigid link beams and the chevron-braces, which may be impossible or impractical in real-building implementations. In addition, caution must be placed in an actual attachment of PED devices to the timber diaphragms. Significant amount of lateral force is required in order to achieve sufficient deformation in the metallic device. This force will be transferred to the timber diaphragm and could cause a localized damage to timber at the attached points. Nonetheless, these practicality issues are not the main focus of this feasibility-type investigation. Further analytical and experimental studies are required in the future for such connection details to ensure most benefit from the implementation of PED devices.

4.3 Rapid Fragility Assessment of Building Portfolios Using 2D Models

The use of a response surface methodology (RSM) in conjunction with a simple Monte Carlo simulation has been shown to be effective and quite accurate in estimating the seismic fragilities for a representative unreinforced masonry (URM) building. The current section takes a step further in utilizing the proposed approach. The main idea is to explicitly include broader macro-level building parameters that describe different building physical characteristics in a response surface metamodel. The methodology is viewed as a step towards developing an efficient tool for a rapid fragility assessment of a particular building portfolio. Fragility estimation of buildings in a hypothetical portfolio is presented as an example in this chapter.

4.3.1 Portfolio Fragility Assessment

Seismic fragility describes a likelihood of damage to building(s) due to future earthquakes. Fragility relations specific to a building or a building portfolio is an important component in the loss estimation process. It is usually of interest to governmental agencies or building owners who are responsible for developing effective mitigation measures for their building portfolios. The fragility must be consistently derived because inaccurate fragility computation could lead to erratic portfolio loss estimation.

4.3.1.1 Conventional Approach

Conventional loss assessment packages [NIBS, 1999] make use of the fragility curves that are generated for a representative building (hereafter called a generic fragility curve) in a loss estimation computation for a population of building with similar classification in a region (*i.e.*, low-rise URM buildings in Mid-America). It is not intended that these generic fragility curves be used for evaluating individual buildings in a community, but rather, they are more appropriate for assessing fragility and losses at a regional level.

Even though the perspective of using generic curves is widely acceptable among many practitioners, it is doubtful that different buildings would share the same fragility relation even if they are considered in the same classification. The building configurations and many other non-physics parameters (*e.g.*, age, maintenance, *etc.*) also play an important role in the dynamic responses of the buildings. The conventional approach tends to ignore this fact and assumes that the buildings with similar construction type would produce the same level of damage under an earthquake regardless of their geometries. This could lead to an inaccurate estimation of building portfolio losses. As a result, building-specific fragility relations that take into account building physical characteristics are needed for better estimation of the loss. While building-specific fragility curves can be determined from brute-force simulations based on complex structural analyses on each building, for portfolio assessment, it becomes impractical to produce a large number of seismic response analyses. Instead, some sort of rapid assessment may be more appropriate at the portfolio level.

4.3.1.2 Proposed Use of the RSM

This research extends the use of the response surface metamodel to include broader macro-level building parameters for estimating the damage levels. The approach in this section takes into account not only uncertainties in material properties but it also considers variability in building geometry as well as the age of the buildings. By this way, the structural variability in a region is explicitly incorporated in the development of the damage estimation model for a certain building type.

A benefit of using the closed-form response surface model to approximate the degree of damage is realized when a fragility or loss assessment of a particular building or building portfolio is of interest. The use of the readily developed generic fragility curves does not provide accurate results to specific buildings [NIBS, 1999] and, on the other end, a detailed building-by-building fragility analysis may be prohibitively expensive. The response surface model, when

incorporating the geometric parameters, can be utilized for a rapid fragility assessment of specific building or building portfolio in a specific region. The response surface in this case can be regarded as a damage prediction model for a certain type of building construction in a particular region. The level of damage to a specific building can be quickly estimated based on the building geometry (and possibly other) parameters. Randomness that exists in the material properties and seismic inputs are also included in simulating the probabilistic distribution of damage and, hence, deriving fragility curves specific to a given building portfolio.

A detailed example application of the proposed approach for computing portfolio-specific fragilities is presented in this section. The approach presents a good compromise between the use of the rather inaccurate generic curves and the time-consuming building-by-building assessment.

4.3.2 Region of Interest

The first step is to define the region of interest. As mentioned previously, the New Madrid Seismic Zone (NMSZ) is regarded as one of the most hazardous seismic region in the US. However, due to the infrequent nature of earthquake events in the region, most building owners believe that a stringent seismic design is not an economical solution for their buildings. The city of Memphis, as one of the major cities close to the NMSZ, could be susceptible to consequence following an earthquake event if a suitable mitigation is not in place. Fragility analysis of a building portfolio in Memphis can provide an insight into the level of damage that might be expected if an earthquake were to happen in the region.

It is assumed in this study that a suitable database or building inventory is available to describe the portfolio of interest. For example, research at the Mid America Earthquake Center [French, 2003] has yielded a building inventory database of over 280,000 buildings in Memphis. Results from this study are essential in defining the parameters and their applicable ranges for use in the response surface models. At this point, however, the database is still under development

and does not include all the needed information. As a result, appropriate assumptions must be made in the development to bridge these gaps.

4.3.3 Building Parameters

In reality, a building portfolio will typically consist of building constructions that belong to several classifications and the buildings from different classifications will likely respond differently to earthquakes. As a result, a separate response surface model is needed for each building class for its damage prediction. In this study, however, only a single structural class will be treated, and this is the class of low-rise steel moment resisting frame construction (S1-L according to HAZUS building classification). In other words, the methodology will be developed and applied to one class of buildings in the portfolio. This simplified problem is viewed as a first step with a purpose of showing an applicability of the method, and an approach for incorporating multiple classes of structures will be outlined.

The benefit of using a metamodel is the ability to rapidly predict the response and damage to any particular building given its geometric characteristics, but such characteristics must be defined. Building parameters that should be included in the model are the ones that affect the response computation. In addition, the parameters must be largely independent of each other. The initial step in the input parameter selection process is to identify all possible building parameters and then some parameters with little effect will be eliminated in the screening process.

In an ideal setting, an efficiently designed sample of buildings of a particular structural class would be selected from the building stock in the target region. A detailed structural model would then be constructed for each building and subjected to a suite of earthquakes in order to assess the performance. These analyses would then provide the basis for the screening process and subsequently for the construction of the response surface metamodels. Such an approach is not possible in most cases (including the present) because available regional inventories of the building stock do not typically include more than very general structural classifications, and much

of this is provided by cursory visual inspection or other indirect means. Moreover, detailed structural plans needed to construct a structural model are almost certainly not available. As a result, other means must be used to develop suitable structural model samples for construction of the metamodels. The approach taken in the present work is to simply design a representative building structure for each sample of building parameters and then to carry out the structural analysis on these models rather than on models derived from actual structures in the region. Details of this procedure are provided in subsequent sections.

While the direction of an earthquake and the 3-dimensional building characteristics can cause significant impact to the building responses, the scope of the work in this chapter is limited to the 2-dimensional aspects of the building. This makes the problem more tractable and appropriate for a proof-of-concept type of investigation.

In order to further limit the extent of the problem to a manageable level, the initial study assumes that the S1-L buildings in the region are regularly constructed without structural discontinuity (*e.g.*, missing columns or beams, *etc.*). Furthermore, assumptions on the variation of the building overall dimensions have to be made because the detailed building inventory data for the region is lacking at the time of this research. The buildings in the region are assumed to have their overall length (along the direction of the applied earthquakes) varying between 96 ft and 144 ft and the overall height ranging from 29 ft to 39 ft. In this first study, a general bay and story arrangement is assumed invariable. It is defined following the 3-story-4-bay steel moment frame building model from the SAC project [FEMA, 2000b]. The variability in the building overall length and overall height is taken into account by adjusting the width of each bay and the story heights. This may not be sensible for the normal design practice in which the bay width does not vary by much and the length of a building is increased by adding new bays. However, following a design practice is not as important an issue in this research as showing the

applicability of the approach. It is believed that it would be more appropriate for future research to address this issue.

In addition to the configuration parameters, the mass (reflecting dead and live loads in a building) at each story is also incorporated as the input variables. Material property parameters, even though are expected to have much less significance in the response computation, represent uncertainty in the model and must still be incorporated for probabilistic assessment of damage. Table 4.20 presents all possible input parameters for the response surface generation. These parameters can be divided into 2 groups: geometric variability parameters that are used to characterize individual buildings, so-called macro-level parameters (ξ_1 to ξ_6) and random parameters for material properties, so-called micro-level parameters (ξ_7 to ξ_{11}).

Information on the regional variability (*i.e.*, bounds of each parameter) can be obtained from an actual field survey or building inventory data. However, resources are not available to develop the necessary survey of the structural characteristics in the target region and, as noted previously, the available inventory data is not complete. As a result, in this study, variability of building characteristics must be assumed. Table 4.20 shows the assumed lower and upper bounds of the input parameters for the specified region. Bounds are given to each parameter to define range of parameters applicable to a specific building class in the Memphis area.

Table 4.20: Potential Building Parameters for Response Surface Model Generation

	Building Parameters	Lower Bounds	Center Points	Upper Bounds
ξ_1	Bottom Floor Height (ft)	11.2	14.0	16.8
ξ_2	Typical Floor Height (ft)	9.0	10.0	11.0
ξ_3	Bay Width (ft)	24.0	30.0	36.0
ξ_4	2nd Floor Mass (kips-sec ² /ft)	26.21	32.76	39.32
ξ_5	3rd Floor Mass (kips-sec ² /ft)	26.21	32.76	39.32
ξ_6	Roof Mass (kips-sec ² /ft)	28.36	35.45	42.54
ξ_7	Column Yield Strength (ksi)	44.0	55.0	66.0
ξ_8	Beam Yield Strength (ksi)	44.0	55.0	66.0
ξ_9	Column Young's Modulus (ksi)	27550	29000	30450
ξ_{10}	Beam Young's Modulus (ksi)	27550	29000	30450
ξ_{11}	Damping Ratio	2%	3%	4%

4.3.4 Response Measures and Damage Criteria

Quantification of damage from a seismic event to a building is based primarily on overall response of the buildings. Maximum inter-story drift is one of the simplest parameters and has been known to provide a good correlation to connection damage in steel frame structures [Kircher, 2003]. FEMA-356 [FEMA, 2000a] also suggests the use of maximum inter-story drift as a performance measure in the steel moment frame buildings. The inter-story drift is computed by dividing the relative lateral displacement between floors with the corresponding height between the two floors. The peak value at any location in a frame and at any time instance is termed peak or maximum inter-story drift. Similar to the case of the URM structures, three building performance levels are defined. They include Collapse Prevention (CP), Life Safety (LS), and Immediate Occupancy (IO) performance levels. Descriptions and the maximum drift limit for each building performance level are displayed in Table 4.21.

Table 4.21: Structural Performance Levels for Steel Moment Frames [FEMA, 2000a]

	Structural Performance Levels		
	Collapse Prevention S-5	Life Safety S-3	Immediate Occupancy S-1
Damage Levels	Severe	Moderate	Light
Overall Damage Descriptions	Extensive distortion of beams and column panels. Many fractures at moment connections, but shear connections remain intact.	Hinges form. Local buckling of some beam elements. Severe joint distortion; isolated moment connection fractures, but shear connections remain intact.	Minor local yielding at a few places. No fractures. Minor buckling or observable permanent distortion of members.
Drift	5%	2.5%	0.7%

4.3.5 Ground Motion and Intensity Measure

A suite of the synthesized accelerograms for Memphis, TN [Wen and Wu, 2001] is used again in this chapter. The earthquakes in the suite are generated with randomness in the characteristics of source, site, and magnitude of the earthquake as well as the local soil conditions. As a result, the use of an ensemble of earthquakes indirectly incorporates seismic uncertainty in the fragility assessment.

A simple parameter that characterizes earthquake intensity must be defined. It was shown in Chapter 3 that the use of the spectral acceleration as an earthquake intensity measure is more appropriate than the use of the peak accelerations. The spectral acceleration at the fundamental period of the building has been used extensively in the previous chapters. However, in this chapter, the damage prediction response surface model also takes into consideration the variability in building geometrical parameters. As a result, the building configuration and, consequently, the building's fundamental period can be varied over the parameter space. The use of the spectral acceleration at a specific period as the intensity measure becomes inappropriate in this case.

Dimova and Elenas [2002] suggested the use of an average spectral acceleration (S_{am}) as a measure of seismic intensity in the case that involves the fragility analysis of several buildings with different periods. It is an average value of S_a between the minimum (T_i) and the maximum periods (T_j) of those buildings. The concept of the average spectral acceleration is presented graphically in Figure 4.33. The study by Dimova and Elenas [2002] also suggested high correlation between this intensity measure and structural damage.

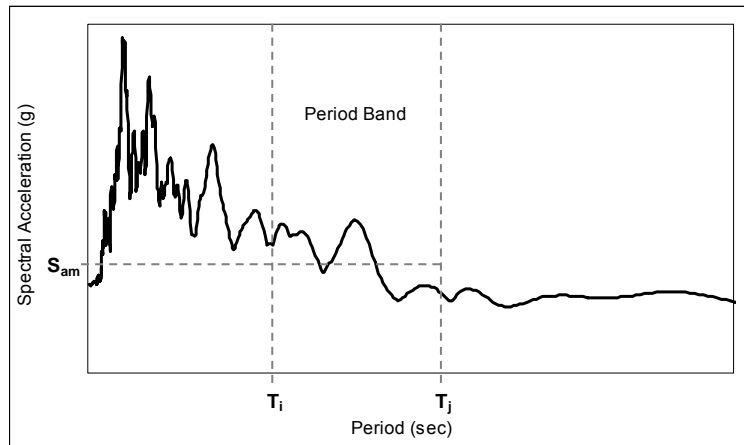

Figure 4.33: Concept of Average Spectral Acceleration (S_{am})

In this investigation, the earthquakes in the suite are scaled such that they have the same value of S_{am} . The same scaling scheme (3.27) as in the case of S_a can be utilized.

4.3.6 Building Model

The low-rise moment-resisting steel frame (S1-L) in Memphis is assumed to have a general configuration similar to the model building from the SAC report [FEMA, 2000b]. The building is 3-story in height with 4 bays in the east-west direction and 6 bays in the north-south direction (Figure 4.34a). All bays are assumed to be of equal width. Discontinuity in structural elements (*i.e.*, beams and columns) is not presented in this building. The seismic response analysis in this study is limited only to the 2-dimensional aspects and, as a result, the earthquake is assumed to arrive at the structure only in the east-west direction. Figure 4.34a also shows the

position of moment-resisting frames in the plan view (shown as bold lines). Figure 4.34b shows an elevation view of the moment resisting frame that is used in the response analysis. In this study, the dynamic analysis is performed on the 2-dimensional moment-resisting frame model generated by DRAIN-2DX. Element type 2 (beam-column element) is used to assemble the frame models. Plasticity in any element that may occur is concentrated at the end of each element. A simple bilinear force-displacement relationship with an inelastic unloading branch is assumed for the element's hysteretic property. The gravity loads used in the design of the building as well as in the calculation of masses follow FEMA [2000b] and are listed in the following section. The masses are lumped at the frame nodes. Connections between the beams and the columns, however, are assumed to be rigid. The columns in the moment-resisting frame bend about their strong axes and the column based are considered fixed. The P- Δ effects are ignored in this study.

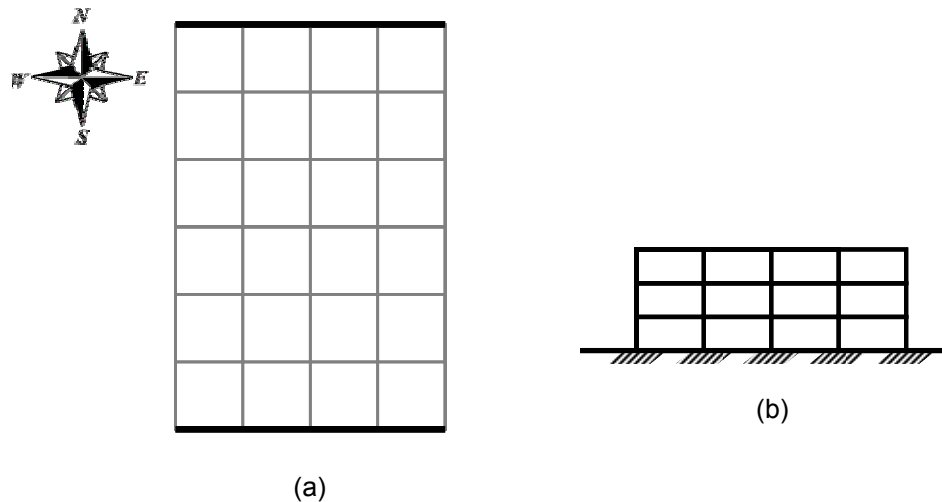

Figure 4.34: General Building Configuration with (a) Plan View showing Moment-Resisting Frames, and (b) Elevation View of a Moment-Resisting Frame

4.3.7 Building Designs for Lateral Loads

Buildings in a region, even though they are in the same class, are designed differently. Some are designed without a consideration of seismic effects. On the other hand, some are designed to the most stringent level. The seismic design provision to which a particular building

conforms also plays a very important role on how the building would respond to an earthquake. However, it is hard to derive a consistent criterion for characterizing the building design provision for each building. For simplicity, it is assumed that the construction year of the buildings reflect the seismic design provision that the buildings conform to. It is further assumed that all the low-rise steel moment-resisting frame buildings (S1-L) in Memphis can be categorized into three different design provisions as follows:

1. The 2000 International Building Code (IBC2000) represents the most stringent design (so-called high seismic design) and is applicable to the buildings constructed after the year 2001.
2. The 1991 Standard Building Code (SBC1991) represents the less stringent design (so-called a low seismic design) in the region and is applicable to the buildings constructed between 1992 and 2001.
3. Lastly, the non-seismic design follows the design provision for wind loads and is applicable to the buildings in the region that are constructed prior to 1992.

A brief summary of design criteria and results for each design level is presented as follow.

4.3.7.1 IBC2000 Design

IBC2000 code [ICC, 2000] represents the most stringent seismic design provision that is assumed to be applicable for the recently constructed buildings in the region. For such a low-rise and regularly constructed frame, the equivalent lateral force procedure is used for the purpose of designing the moment-resisting frame. The following design criteria are adopted for the design of a steel moment frame building in Memphis.

- A572 steel for both columns and beams
- Nominal steel yield strength of 50 ksi

PROJECT DS-5 FINAL REPORT

- Steel Young's modulus of 29,000 ksi
- Site class D for Memphis [Williams *et.al.*, 2003]
- Spectral acceleration for short period (S_S) of 1.12 second
- Spectral acceleration for a 1-second period (S_1) of 0.33 second
- Seismic use group I
- Seismic occupancy importance factor (I_E) of 1.0
- Response modification coefficient (R) of 4.0 (for ordinary steel moment frames)
- Floor dead load of 96 psf [FEMA, 2000b]
- Roof dead load of 83 psf [FEMA, 2000b]
- Reduced floor and roof live load of 20 psf

In this equivalent lateral force procedure, the seismic base shear is calculated as a fraction of the total weight of the building in accordance to the following equation.

$$V = C_s W \quad (4.19)$$

The multiplier C_s or the seismic response coefficient is determined from the building characteristics, the site-specific design spectral responses, the building classification and its occupancy. The total base shear is then vertically distributed as nodal forces acting on the moment-resisting frames at each floor level. The amount of force acting on each floor is determined primarily by the floor weight and its height from the ground.

IBC2000 also indicates that the building must be designed to resist the following load combinations when earthquake actions are considered. Note that wind load is not taken into consideration since earthquake effects are expected to govern in the design.

(1) D

- (2) $D + L$
- (3) $D + L + L_r$
- (4) $D + 0.7E + L + L_r$
- (5) $0.6D + 0.7E$

where D , L and L_r are the dead loads, the floor live loads and the roof live loads, respectively. E is the combined effect of horizontal and vertical earthquake induced forces.

GTSTRUDL [1999] is used in selecting the structural members for the building that is design based on the Allowable Stress Design (ASD). The member selection criteria are specified such that the beams are of the same section in each floor and, at the same time, the columns are of the same section for all interior columns (and same for the exterior columns). Table 4.22 shows an example of the beam and column sections in a particular building design (the building with mean geometries).

Table 4.22: Beam and Column Sections for a Building Designed with IBC2000

Floor	Columns		Beams
	Exterior	Interior	
1/2	W14x211	W14x283	W24x104
2/3	W14x211	W14x283	W27x146
3/Roof	W14x211	W14x283	W24x131

4.3.7.2 SBC1991 Design

Most of the designs of the low-rise building in Memphis and its vicinity had not considered the effect from an earthquake until the early 90s. The 1991 Standard Building Code [SBCCI, 1991] has pioneered the seismic design procedure in this region. In this study, it is used

PROJECT DS-5 FINAL REPORT

as a basis for the less stringent design (compare to the more recent IBC2000) that is applicable for the buildings constructed on or after the early 90s but before the IBC2000 is adopted.

Similar to the general concept in IBC2000, the equivalent lateral load procedure is implemented. The total shear at the base of a building that is resulted from seismic forces is determined as a fraction of the weight of the building. The formulation in (4.19) also applies in this case; however, the derivation of the factor C_s is quite different. The following design data are used for designing a building in Memphis.

- Peak velocity-related acceleration coefficient (A_v) of 0.2
- Peak acceleration coefficient (A_a) of 0.2
- Seismic hazard exposure group I
- Seismic performance category C
- Soil profile type S_4 (site coefficient, $S = 2.0$)
- Response modification factor (R) of 4.5 (for ordinary steel moment frames)

The distribution of the lateral loads is similar to that defined in IBC2000. They are determined based on the weight and elevation of the floor. The gravity loads follow the information provided in FEMA [2000b]. Load combinations that are defined in SBC1991 are slightly different from those of IBC2000. They are presented as follows:

- (1) Dead + Floor Live + Roof Live
- (2) Dead + Floor Live + Seismic
- (3) $(1.1 + 0.5A_v)$ Dead + Floor Live + Seismic
- (4) $(0.9 - 0.5A_v)$ Dead + Seismic

It is also assumed for this design that the A572 steel with nominal strength of 50 ksi and Young’s modulus of 29,000 ksi is used for both beams and columns. Similar criteria for selecting beam and column sections are implemented in the GTSTRUDL design procedure and the resulting selection of steel sections of a particular building (the building with mean geometries) is shown in Table 4.23.

Table 4.23: Beam and Column Sections for a Building Designed with SBC1991

Floor	Columns		Beams
	Exterior	Interior	
1/2	W14x159	W14x193	W18x97
2/3	W14x159	W14x193	W24x104
3/Roof	W14x159	W14x193	W18x86

4.3.7.3 Wind Load Design

For older buildings or those buildings in the region that are constructed prior to the point when the seismic provision is adopted, it is assumed that they are designed to withstand the effects from the gravity and wind loads only. For this matter, the recommendation for the wind load design from the 1969 edition of the Southern Standard Building Code [SBCC, 1969] is adopted in designing the steel moment frame buildings that are associated to the non-seismic design level.

The minimum design wind pressure for an inland location (more than 125 miles from the coast) varies with the height of the building. For the height zone that is less than 30 feet from the ground level, the wind pressure is 10 psf. For the height zone between 31 feet and 50 feet, the design wind pressure becomes 20 psf. The wind pressure in each height zone is assumed to be uniformly distributed over the building side. Nodal forces are computed for each floor of the moment-resisting frames based on the tributary area. GTSTRUDL is again used in selecting the

appropriate steel sections. In this case, which represents older constructions in the region, A36 steel is assumed for the beams while A572 steel is used for the columns. Table 4.24 shows an example of beam and column sections in a particular design (the building with mean geometries).

Table 4.24: Beam and Column Sections for a Building Designed to the Non-Seismic Code Level

Floor	Columns		Beams
	Exterior	Interior	
1/2	W12x40	W12x53	W14x68
2/3	W12x40	W12x53	W14x68
3/Roof	W12x40	W12x53	W14x61

4.3.8 Parameter Screening

One disadvantage of the response surface model is the limitation on the number of independent input variables. In general, for standard Design of Experiment (DOE) designs, less than 8 input parameters are allowed for a response surface metamodel. The structural parameters to be included in the metamodels should be those that have greatest impact on the output or response calculation (maximum inter-story drift), but the selection is not always obvious for complex problems. As a result, a screening process is employed to identify the contribution of each parameter to the response of the system. One of the simplest methods is to systematically make reasonable increments in each input variable and compute the response for each case. A rank-ordered output yields what is often called a Pareto optimal solution [Montgomery, 1997].

As mentioned previously, 11 input parameters (Figure 4.33) are preliminarily chosen to capture basic structural characteristics that could affect peak inter-story drift calculations. A Design of Experiment (DOE) technique is used to generate an 11-dimensional experimental space composing of different levels of each input parameter. For the purpose of screening test, a 2-level fractional factorial design [JMP, 1995] is employed in this study. Two-level design only uses

minima and maxima of input variables to form design (or experimental) space. Sixteen experimental cases based on fractional factorial design [JMP, 1995] for the 11 input parameters are shown in Table 4.25. The values of -1 and +1 denote minima and maxima of input variables, respectively. Sixteen detailed structural analysis models are generated corresponding to the combination of input parameter levels in the DOE table. For example, case #1 is constructed by using minimum values for bottom floor height (x_1), typical floor height (x_2), bay width (x_3), 2nd floor mass, (x_4) roof mass (x_6), column yield strength (x_7) and modulus (x_9) and using maximum values for 3rd floor mass (x_5), damping ratio (x_{11}), beam yield strength (x_8) and modulus (x_{10}). The output variables (y) are those maximum inter-story drift values (in percents) obtained from the nonlinear time-history analyses, which are performed over each building model.

A first order regression model (4.19) is generated for identifying an influence each input parameter has to the output calculation.

$$y = \beta_0 + \beta_1 x_1 + \beta_2 x_2 + \cdots + \beta_{11} x_{11} \quad (4.20)$$

where

y = output variable or maximum inter-story drift (%)

x_i 's = input parameters

β_i 's = coefficient estimates

The scaled estimates are those coefficient estimates multiplied by the standard deviation of the input parameter such that the estimates can be reasonably compared with each other. The Pareto plot is a plot showing composition of an absolute value of each scaled estimate normalized to the sum. Parameter with highest scaled estimate represents the most influential parameter as minor change in the value of input produces major influence in the output calculation given that all other input parameters remain constant.

PROJECT DS-5 FINAL REPORT

Figure 4.35 shows a plot of the scaled estimates for each input parameters (so-called Pareto plot). The solid curve in the figure indicates the cumulative contribution to the overall response while the individual contribution or scaled estimate is indicated by the horizontal bar.

Another way to obtain a qualitative impression of the significance of each input variable is through the prediction profiler plots (Figure 4.36). The prediction profiler plot is a plot between the output variable (y) and each of the input variables (x 's) while other inputs are held at their center point or mean values. The influence of each input variable can be inferred from the steepness of the line as a steeper line over the variable range means that the input variable is more influential to the output calculation than the others. It is obvious from

Figure 4.35 that the first 5 parameters (x_3 , x_7 , x_{11} , x_9 , and x_{11}) contribute to almost 80% of the overall response. Thus, these 5 parameters can be used as the input variables in the response surface while fixing the remaining parameters to their best estimated values and still be assured of reasonable data fit.

PROJECT DS-5 FINAL REPORT

Table 4.25: Design of Experiments Table based on the 2-Level Fractional Factorial Design for 11 Input Variables

Case	x ₁	x ₂	x ₃	x ₄	x ₅	x ₆	x ₇	x ₈	x ₉	x ₁₀	x ₁₁	y (%)
1	-1	-1	-1	-1	+1	-1	-1	+1	-1	+1	+1	2.46
2	-1	-1	-1	+1	-1	+1	+1	-1	+1	-1	-1	2.61
3	-1	-1	+1	-1	-1	+1	+1	-1	-1	+1	+1	2.18
4	-1	-1	+1	+1	+1	-1	-1	+1	+1	-1	-1	2.20
5	-1	+1	-1	-1	-1	+1	-1	+1	+1	-1	+1	2.16
6	-1	+1	-1	+1	+1	-1	+1	-1	-1	+1	-1	2.64
7	-1	+1	+1	-1	+1	-1	+1	-1	+1	-1	+1	2.15
8	-1	+1	+1	+1	-1	+1	-1	+1	-1	+1	-1	2.20
9	+1	-1	-1	-1	-1	-1	+1	+1	+1	+1	-1	2.29
10	+1	-1	-1	+1	+1	+1	-1	-1	-1	-1	+1	2.27
11	+1	-1	+1	-1	+1	+1	-1	-1	+1	+1	-1	2.01
12	+1	-1	+1	+1	-1	-1	+1	+1	-1	-1	+1	2.22
13	+1	+1	-1	-1	+1	+1	+1	+1	-1	-1	-1	2.59
14	+1	+1	-1	+1	-1	-1	-1	-1	+1	+1	+1	2.10
15	+1	+1	+1	-1	-1	-1	-1	-1	-1	-1	-1	2.01
16	+1	+1	+1	+1	+1	+1	+1	+1	+1	+1	+1	2.03

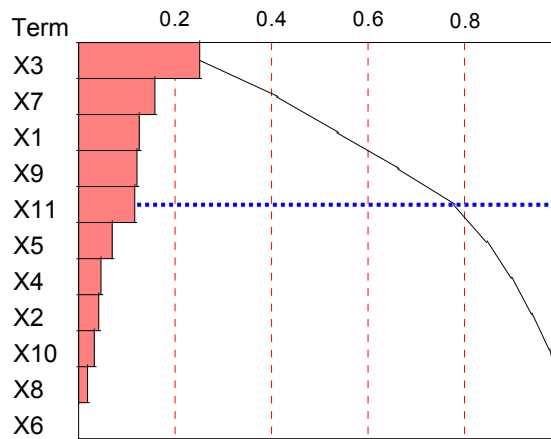

Figure 4.35: Pareto Plot of Input Parameters

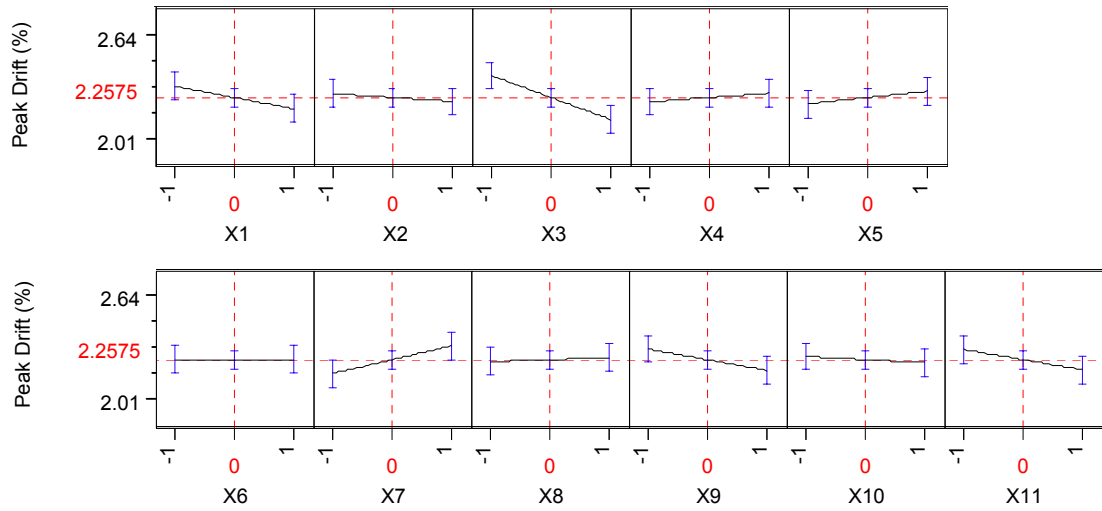

Figure 4.36: Prediction Profiler Plot

4.3.9 Response Surface Model Generation

An initial goal of this study is to develop the damage prediction response surface model specific for each design level (*i.e.*, high-, low-, and non-seismic designs). The 5 most influential structural parameters, including the bottom floor height (ξ_1), the bay width (ξ_3), the column yield strength (ξ_7), the column Young's modulus (ξ_9), and the damping ratio (ξ_{11}) are used in combination with the earthquake intensity parameter (ξ_{EQ}) to formulate the response surface models according to the proposed Approach 3 in this study (see chapter 3 for details). The parameters' lower bounds, center point, and upper bound values along with their normalized values are displayed in Table 4.26. Note that the 3 levels of the average spectral acceleration dictate the way the earthquake records are scaled. For example, in the case where $\xi_{EQ} = 0$, each of the earthquakes that is used for the response computation is scaled such that the S_{am} of 1.0g is achieved. A similar concept applies to the case of $\xi_{EQ} = -1$ and $\xi_{EQ} = +1$.

The Design of Experiments technique (*i.e.*, a reduced Central Composite Design in particular) is utilized to formulate combinations of input variables for response computation. In this case that the building geometries are also varied in the DOE table, the buildings must be

redesigned according to its geometric parameters defined for each combination. In the initial study, each combination of building parameters is designed to the 3 design levels. Maximum inter-story drifts are computed from the nonlinear dynamic analyses and recorded in the DOE table for each design level. Finally, 3 sets of matrices of input variables and the corresponding computed responses are formulated.

Table 4.26: Screened Input Parameters for Response Surface Models

Input Parameters	Input Variables	Lower Bounds	Center Points	Upper Bounds	Units
Bottom Floor Height	ξ_1	11.2	14.0	16.8	ft
	x_1	-1	0	+1	-
Bay Width	ξ_3	24.0	30.0	36.0	ft
	x_3	-1	0	+1	-
Column Yield Strength	ξ_7	44.0	55.0	66.0	ksi
	x_7	-1	0	+1	-
Column Young's Modulus	ξ_9	27550.0	29000.0	30450.0	ksi
	x_9	-1	0	+1	-
Damping	ξ_{11}	2.0	3.0	4.0	%
	x_{11}	-1	0	+1	-
Average Spectral Acceleration (S_{am})	ξ_{EQ}	0.1	1.0	1.9	g
	x_{EQ}	-1	0	+1	-

The least-square regression technique is used in deriving the coefficient estimates of the response surface functions. The response surface or the maximum drift prediction models is generated for each seismic design level (*i.e.*, non-, low-, and high-seismic designs). They can be shown symbolically as follows:

$$\hat{y}_{non} = \hat{y}_{\mu|non} + N[0, \hat{y}_{\sigma|non}] \quad (4.21)$$

$$\hat{y}_{low} = \hat{y}_{\mu|low} + N[0, \hat{y}_{\sigma|low}] \quad (4.22)$$

$$\hat{y}_{\text{high}} = \hat{y}_{\mu|\text{high}} + N[0, \hat{y}_{\sigma|\text{high}}] \quad (4.23)$$

The response functions for the mean drift are plotted against each of the building parameters in Figure 4.37. The two extreme cases for the design levels, non-seismic and high-seismic, are plotted together for comparison. It is as expected that the maximum drifts predicted from the non-seismic design case are significantly higher. Note that the level of seismic intensity is fixed at its central value of 1.0g in these plots.

It is found that the process may not be completely efficient since the damage prediction model is dependent of the seismic design levels. Further investigation is made in order to incorporate the design levels into the response surface model and, as a consequence, merges the 3 models into a single response prediction model. In this regard, the design parameters can be thought of as an indicator or a categorical variable that determines whether the building design is non-seismic, low-seismic, or high-seismic. For the response surface models, the normalized variable (x_{DES}) has its values discretely described by -1 , 0 , and $+1$. The value -1 represents the case of the non-seismic design, while the value 0 and $+1$ stand for the low- and high-seismic designs, respectively. It is obvious from Figure 4.37 that the difference in the response due to distinct design levels is far greater than the variation of the responses within the same design level. This interprets as the level of the seismic design has much more influence on the computation of the maximum drifts than any other building parameters. As a result, in order to limit the number of input parameters to six, the damping ratio (that is the least influential parameter) is eliminated from a set of input variables and it is replaced by the design level parameters (ξ_{DES}) as can be seen in Table 4.27 for the new set of the response surface input variables.

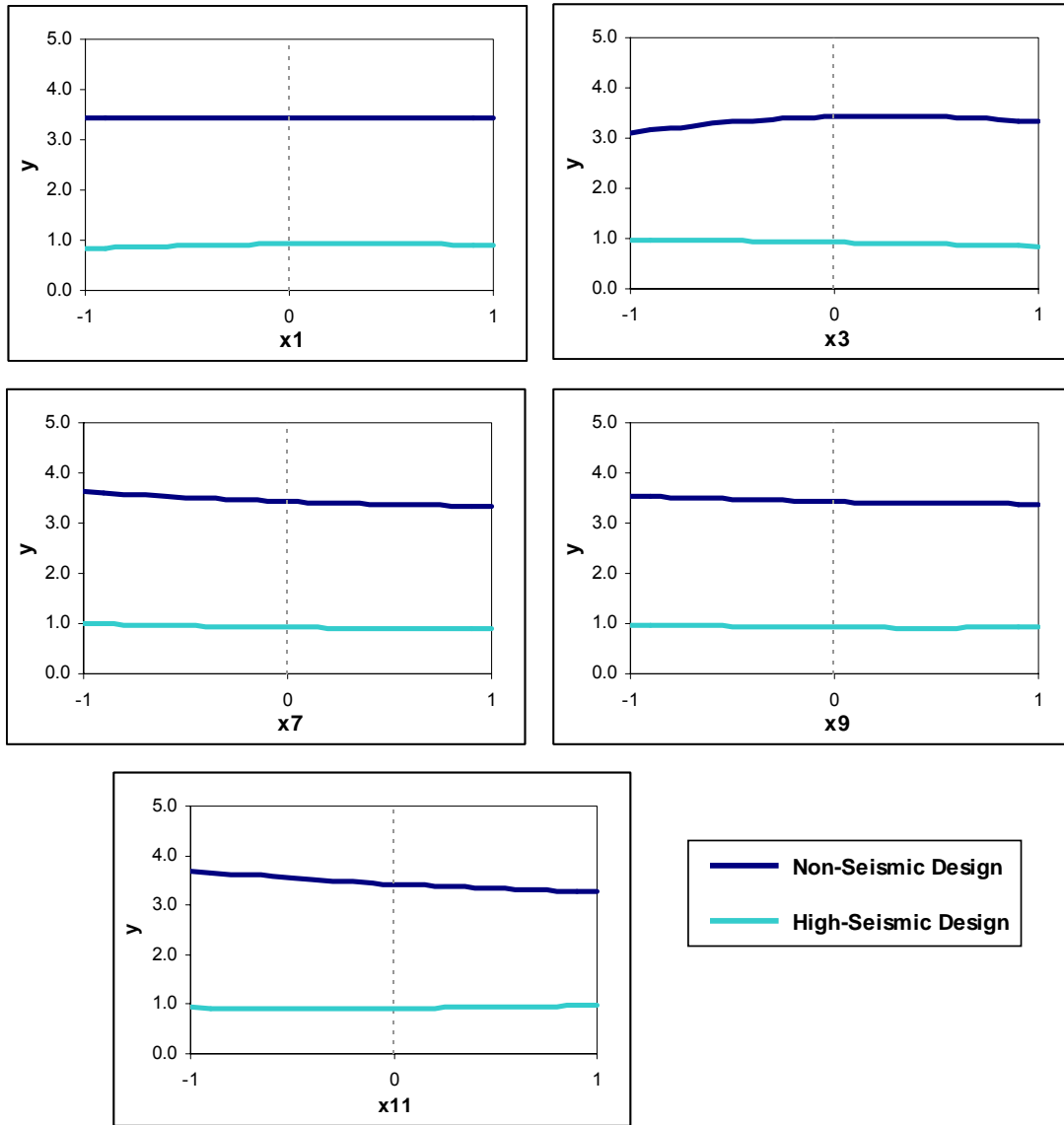

Figure 4.37: Plot of Response Surfaces with respect to Individual Input Variables

Table 4.27: Input Parameters for Response Surface Models including the Seismic Design Level Parameter

Input Parameters	Input Variables	Lower Bounds	Center Points	Upper Bounds	Units
Bottom Floor Height	ξ_1	11.2	14.0	16.8	ft
	x_1	-1	0	+1	-
Bay Width	ξ_3	24.0	30.0	36.0	ft
	x_3	-1	0	+1	-
Column Yield Strength	ξ_7	44.0	55.0	66.0	ksi
	x_7	-1	0	+1	-
Column Young's Modulus	ξ_9	27550.0	29000.0	30450.0	ksi
	x_9	-1	0	+1	-
Design Level	ξ_{DES}	Non-	Low-	High-	-
	x_{DES}	-1	0	+1	-
Average Spectral Acceleration (S_{am})	ξ_{EQ}	0.1	1.0	1.9	g
	x_{EQ}	-1	0	+1	-

The DOE table is again constructed for this new set of input parameters. Forty five combinations of input variables are defined following the reduced Central Composite Design [JMP, 1995]. It is worth showing an example of how the response computation is achieved in each of the DOE case. A specific case contains the following combination of the input variables: $x_1 = -1$, $x_3 = -1$, $x_7 = -1$, $x_9 = +1$, $x_{DES} = +1$, and $x_{EQ} = +1$. This set of variable is interpreted as a building with a bottom floor height of 11.2 feet, a bay width of 24 feet, a column yield strength of 44 ksi, and a column Young's modulus of 27550 ksi. All other building parameters that are deemed less influential are fixed at their center point or mean values. This particular building is then designed to resist the lateral loads based on the high-seismic level or the IBC2000. A suite of earthquakes that each has been scaled to have an average spectral acceleration (S_{am}) of 1.9g is applied to the building and the maximum inter-story drifts are extracted from the nonlinear dynamic analysis of the building subjected to each earthquake. Finally, the mean and the

PROJECT DS-5 FINAL REPORT

standard deviation of the maximum drifts are computed and recorded in the DOE table.

Repetition of the procedure, using the same idea, for other 44 input variable combinations results in the matrices of input and output variables.

The resulting response surface polynomial models are derived based on the least-square criterion and are shown below.

$$\begin{aligned}
 \hat{y}_{\mu} = & 1.118 - 1.278x_{DES} + 0.003x_3 - 0.100x_7 - 0.026x_9 - 0.083x_1 + \\
 & 2.206x_{EQ} + 1.085x_{DES}^2 - 0.051x_3x_{DES} + 0.014x_3^2 + 0.015x_7x_{DES} + \\
 & 0.005x_7x_3 + 0.007x_7^2 + 0.004x_9x_{DES} + 0.023x_9x_3 - 0.003x_9x_7 - \\
 & 0.002x_9^2 + 0.064x_1x_{DES} + 0.022x_1x_3 + 0.051x_1x_7 + 0.001x_1x_9 - \\
 & 0.006x_1^2 - 1.186x_{EQ}x_{DES} + 0.003x_{EQ}x_3 - 0.103x_{EQ}x_7 - 0.019x_{EQ}x_9 - \\
 & 0.121x_{EQ}x_1 + 0.229x_{EQ}^2
 \end{aligned} \tag{4.24}$$

and

$$\begin{aligned}
 \hat{y}_{\sigma} = & 0.512 - 0.466x_{DES} + 0.041x_3 - 0.052x_7 + 0.005x_9 - 0.099x_1 + \\
 & 1.003x_{EQ} + 0.415x_{DES}^2 - 0.05x_3x_{DES} + 0.168x_3^2 + 0.083x_7x_{DES} + \\
 & 0.009x_7x_3 - 0.011x_7^2 - 0.017x_9x_{DES} + 0.026x_9x_3 + 0.017x_9x_7 + \\
 & 0.015x_9^2 + 0.036x_1x_{DES} + 0.023x_1x_3 + 0.019x_1x_7 - 0.001x_1x_9 + \\
 & 0.042x_1^2 - 0.456x_{EQ}x_{DES} + 0.042x_{EQ}x_3 - 0.052x_{EQ}x_7 + 0.008x_{EQ}x_9 - \\
 & 0.118x_{EQ}x_1 - 0.037x_{EQ}^2
 \end{aligned} \tag{4.25}$$

PROJECT DS-5 FINAL REPORT

The response prediction model for a building designed to a particular design level is derived by evaluating the above functions at $x_{DES} = -1, 0,$ and $+1$.

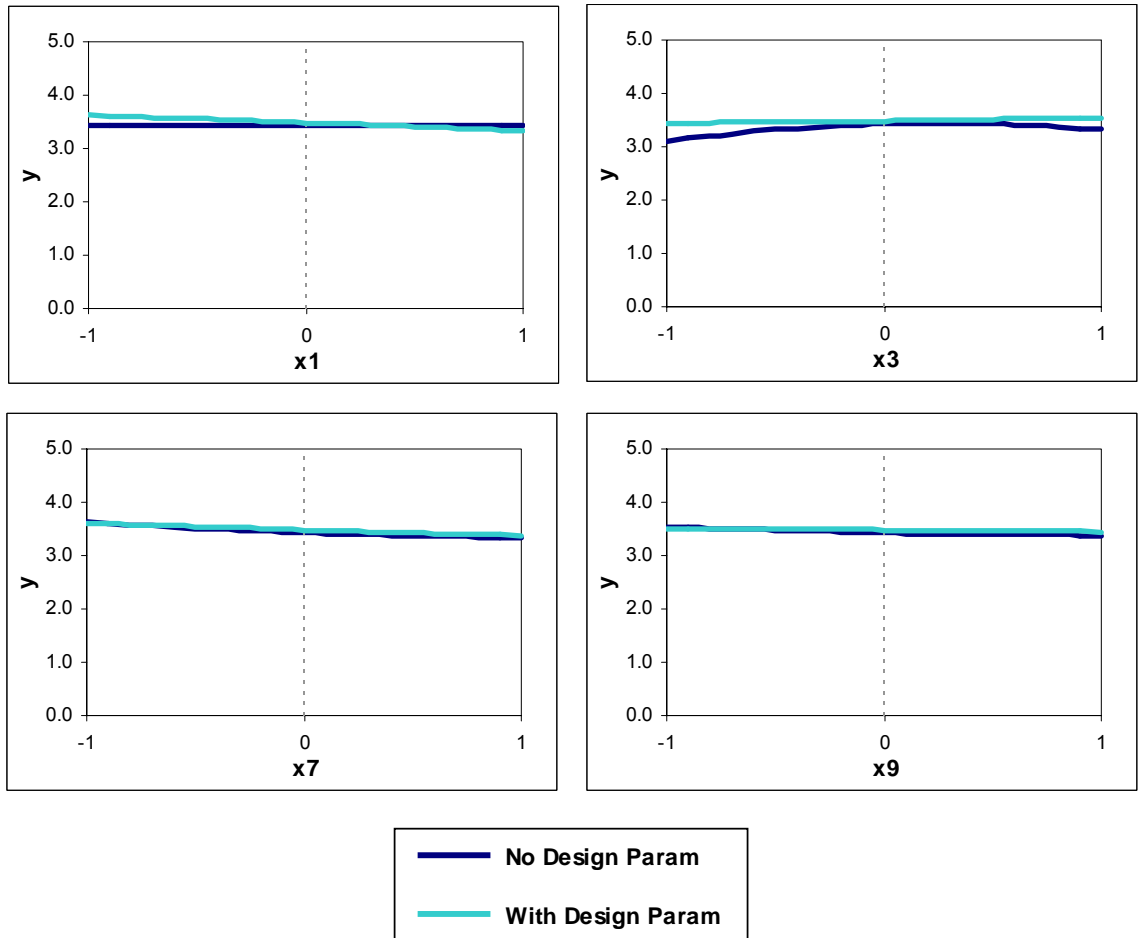

Figure 4.38: Response Surface Plots for Buildings with Non-Seismic Design

PROJECT DS-5 FINAL REPORT

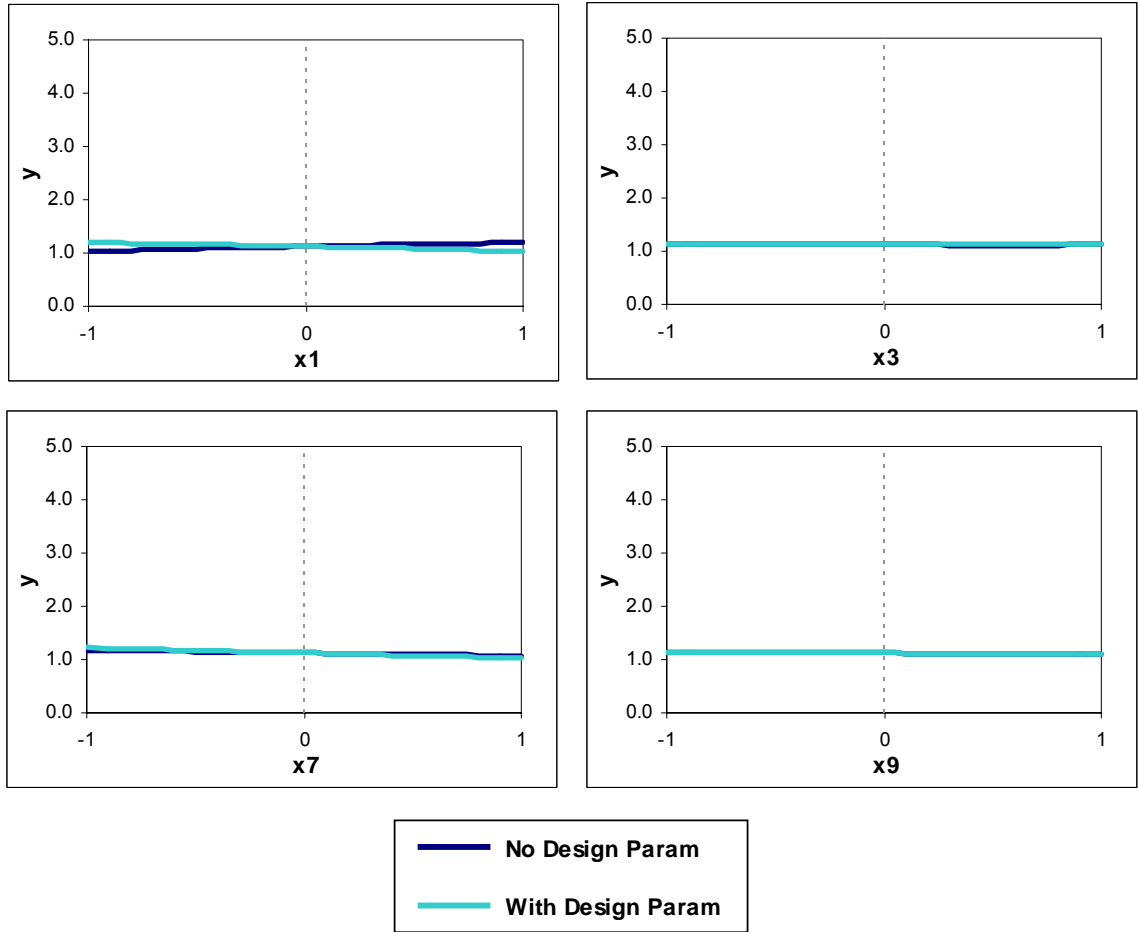

Figure 4.39: Response Surface Plots for Buildings with Low-Seismic Design

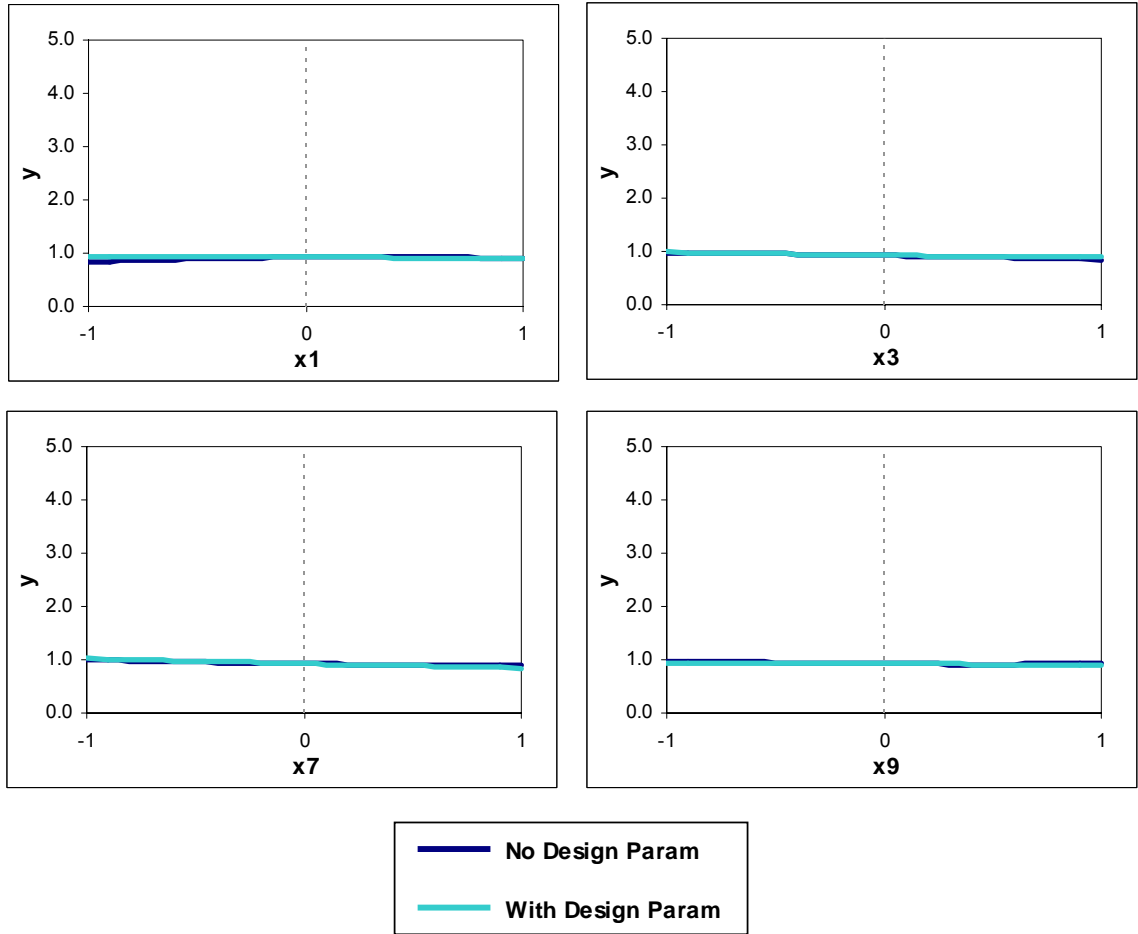

Figure 4.40: Response Surface Plots for Buildings with High-Seismic Design

The response surfaces for the mean value of the maximum drifts are plotted against each of the building parameters. For a comparison purpose, the polynomial function in (4.24) is evaluated at $x_{EQ} = 0$ (representing the case with $S_{am} = 1.0g$) and $x_{DES} = -1, 0,$ and $+1$ (for non-, low-, and high-seismic designs), essentially creating 3 response functions. Their plots are compared with those generated from the response surface specific to each code level (*i.e.*, $\hat{y}_{\mu|non}$, $\hat{y}_{\mu|low}$, and $\hat{y}_{\mu|high}$) in Figure 4.38, Figure 4.39, and Figure 4.40, respectively. It can be seen from these plots that the current approach that incorporates the design level parameter directly as the response surface input variable yields comparable outcomes, but is greatly more efficient.

Diagnosis of the response surface models using the %AvgErr (3.17), %MaxErr (3.18), and %RMSE (3.19) may not be appropriate in this case. These tests require that a relatively large number of additional input variable combinations are used as a basis in performing the tests. However, for this case, the input variables include those geometric parameters as well as the design level parameters and, as a result, modifying those parameters involves in redesigning the new buildings. It would not be economical to design other 100 or more buildings for this purpose. As a consequence, only the R_A^2 value is used to validate the models at this model-level. The validation of the resulting fragility curve as an outcome of the models is performed in the subsequent section.

The R_A^2 of the response surface models for the mean and standard deviation of the maximum drifts are calculated to be 0.978 and 0.943, respectively. These high values of R_A^2 indicate a strong association between the actual and the predicted responses.

The response surface model presented in (4.24) is essentially a damage prediction model. It can be used in a rapid deterministic assessment of an individual building. The level of the maximum inter-story drift can be predicted given the building properties, the design level, and the intensity of an earthquake. However, the benefit of the proposed approach is more prominent as a tool in a portfolio loss estimation process.

4.3.10 Hypothesized Building Portfolio

In order to present the use of the response surface models as a tool in the seismic loss estimation of a building portfolio, a group of four buildings is hypothetically selected. This assumed portfolio is composed solely of low-rise steel moment-resisting frame buildings and they are all located in Memphis, TN. All buildings are different in basic properties and geometric configuration as well as the year that the buildings were constructed. Note that this less-than-realistic portfolio is used for the purpose of showing an application of the response surface

models and is not intended to represent any real buildings. Description of the buildings in this portfolio is displayed in Table 4.28.

Table 4.28: Characteristics of Buildings from the Hypothesized Portfolio

Building Name	Class	Year Built	Number of Story	Typical Floor Height (ft)	Bottom Floor Height (ft)	Bay Width (ft)	Steel Yield Strength (ksi)	Steel Young's Modulus (ksi)
AAA	S1-L	1974	3	9.0	11.2	24.0	50	28000
BBB	S1-L	1993	3	10.0	14.0	30.0	55	29000
CCC	S1-L	2002	3	10.0	14.0	30.0	60	29000
DDD	S1-L	1972	3	11.0	16.8	36.0	48	28000

The response surface functions obtained from the previous steps is appropriate for predicting maximum drifts for an aggregation of low-rise steel moment frame buildings. Modification is needed in order to convert to a response surface applicable to a specific building. Control variables are the variables that dictate how a metamodel for one building differs from the others. In this study, the control variables include the bottom floor height (x_1), the bay width (x_3), and the design level (x_{DES}). Building-specific response prediction model is derived by substituting values of the control variables specific for that building in the response surface of an aggregation (4.24 and 4.25).

As an example, the derivation of the damage prediction model for building AAA is shown. Building AAA was constructed in 1974 and, based on the design level criterion in 4.3.7, was designed according to the non-seismic design level. The value for x_{DES} of -1 is applicable for building AAA. The actual values for the bottom floor height and the bay width of building AAA are converted to the normalized values according to (3.4) as follows:

$$x_1 = \frac{11.2\text{ft} - \frac{16.8\text{ft} + 11.2\text{ft}}{2}}{\frac{16.8\text{ft} - 11.2\text{ft}}{2}} = -1$$

$$x_3 = \frac{24\text{ft} - \frac{36\text{ft} + 24\text{ft}}{2}}{\frac{36\text{ft} - 24\text{ft}}{2}} = -1$$

By substituting the specific values of the control variables into the response surface functions (4.24 and 4.25), these response surfaces then become response or damage prediction functions for Building AAA.

$$(\hat{y}_\mu)_{AAA} = 3.607 - 0.171x_7 - 0.052x_9 + 3.510x_{EQ} - 0.003x_7x_9 - \quad (4.26)$$

$$0.103x_7x_{EQ} - 0.019x_9x_{EQ} + 0.007x_7^2 - 0.002x_9^2 + 0.229x_{EQ}^2$$

$$(\hat{y}_\sigma)_{AAA} = 1.67 - 0.163x_7 - 0.003x_9 + 1.534x_{EQ} + 0.017x_7x_9 - \quad (4.27)$$

$$0.052x_7x_{EQ} + 0.008x_9x_{EQ} - 0.011x_7^2 + 0.015x_9^2 - 0.037x_{EQ}^2$$

and finally, the overall response surface model becomes

$$(\hat{y})_{AAA} = (\hat{y}_\mu)_{AAA} + N[0, (\hat{y}_\sigma)_{AAA}] \quad (4.28)$$

The micro-level material property parameters remain in the response functions and are treated as random variables for simulating probabilistic responses. Probability density functions of the random variables are introduced into the model. Lognormal and uniform probability distributions are assumed for the column yield strength and Young's modulus, respectively [Song and Ellingwood, 1999]. The mean values for the yield strength and the modulus can be obtained directly from the design documents of the building (also shown in Table 4.28). The Coefficient

of Variation (COV), which is a measure of dispersion, is assumed to be 0.12 and 0.06 for the yield strength and the modulus, respectively.

Monte Carlo simulations are then carried out on the functions of random variables for increasing values of earthquake intensity (x_{EQ}). Probability of response exceeding certain limit states (Table 4.21) can be computed from a suitably large number of outputs obtained from the simulation at each intensity level. This, in the same fashion as in 4.7.8, yields plots of fragility curves for building AAA as shown in Figure 4.41.

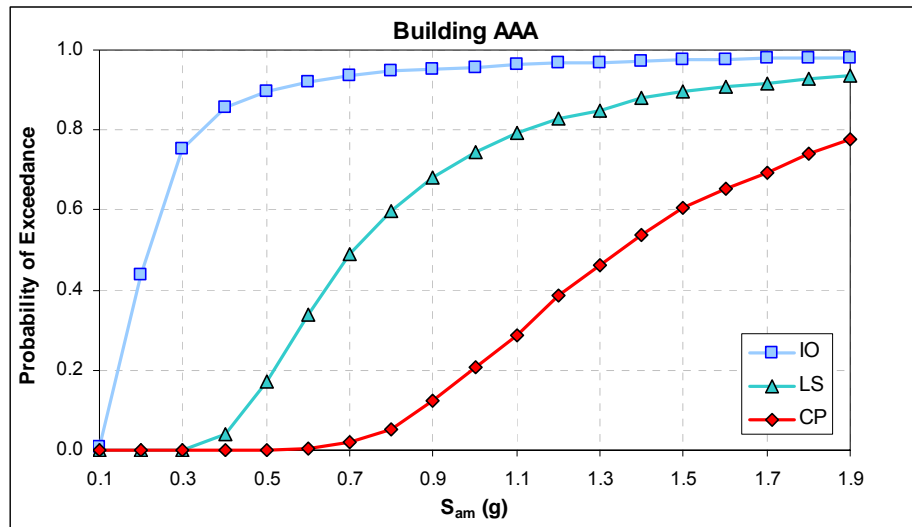

Figure 4.41: Fragility Curves for Building AAA

Fragility curves that are specific to the other 3 buildings in the hypothetical portfolio are derived in a similar fashion as that is for building AAA. They are depicted in Figure 4.42 to Figure 4.44.

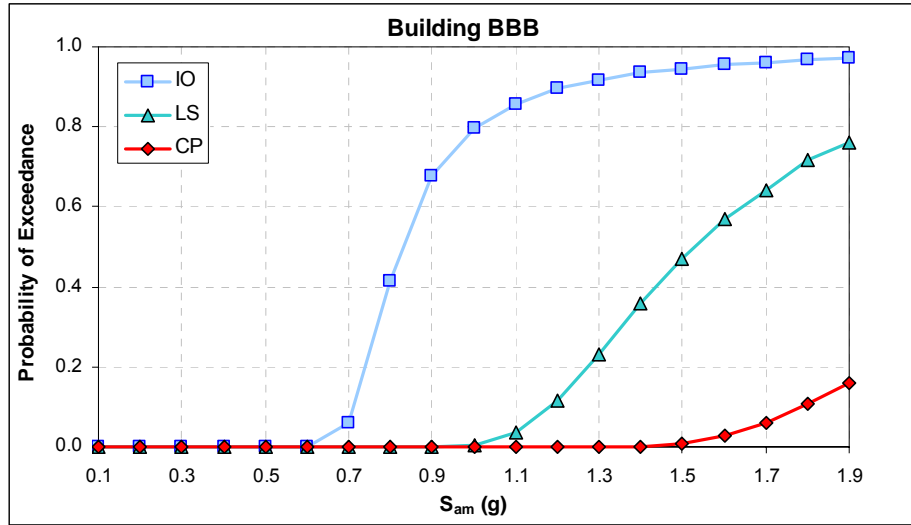

Figure 4.42: Fragility Curves for Building BBB

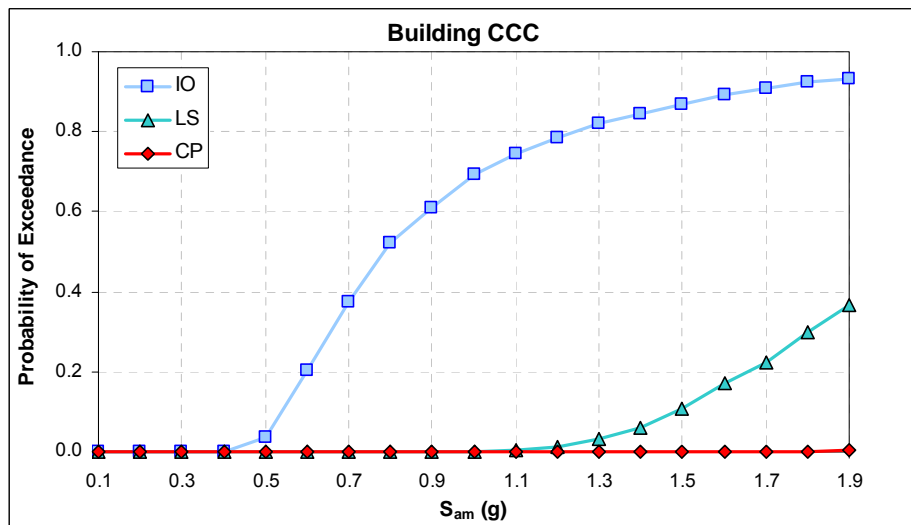

Figure 4.43: Fragility Curves for Building CCC

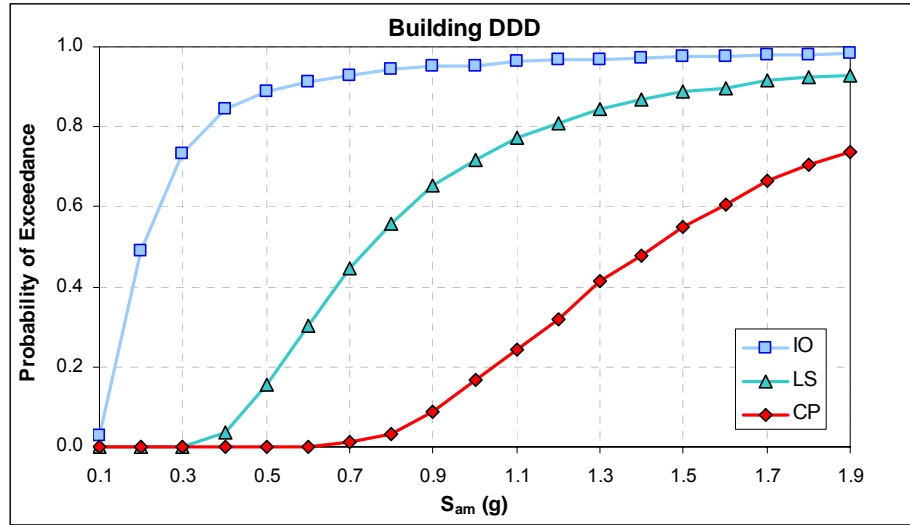

Figure 4.44: Fragility Curves for Building DDD

It is obvious that, even though all 4 buildings are in the same classification, they exhibit different seismic fragility relations. The use of generic fragility curves for all buildings in the same class may lead to an erroneous estimate of potential seismic loss to the portfolio. It can be concluded further that the geometric configurations of the building have little influence on the building fragilities as the curves for building AAA (Figure 4.41) are just slightly different from those of building DDD (Figure 4.44). This can partly be due to the fact that the responses are only limited to the 2-dimensional aspect. An ongoing study is investigating buildings with 3-dimensional responses and its preliminary results are showing that the parameters characterizing the plan-form configurations are much more influential than those in this study. It must also be noted that the spatial correlation of the damage may exist as the buildings in close proximity are more likely to have similar level of damage than the ones that are far apart. However, this correlation is assumed to be absent in this study.

In order to validate this rapid approach of deriving the building-specific fragility curves, a detailed building-by-building analysis is performed for building AAA. The process is much like that presented in Sections 4.1 and 4.2 where only the parameters that define the material properties are

used in the response surface model. The resulting fragility curves are plotted as dashed lines along with those solid lines from the rapid assessment in Figure 4.45. The figure confirms an accuracy of the rapid fragility assessment using the response surface metamodels.

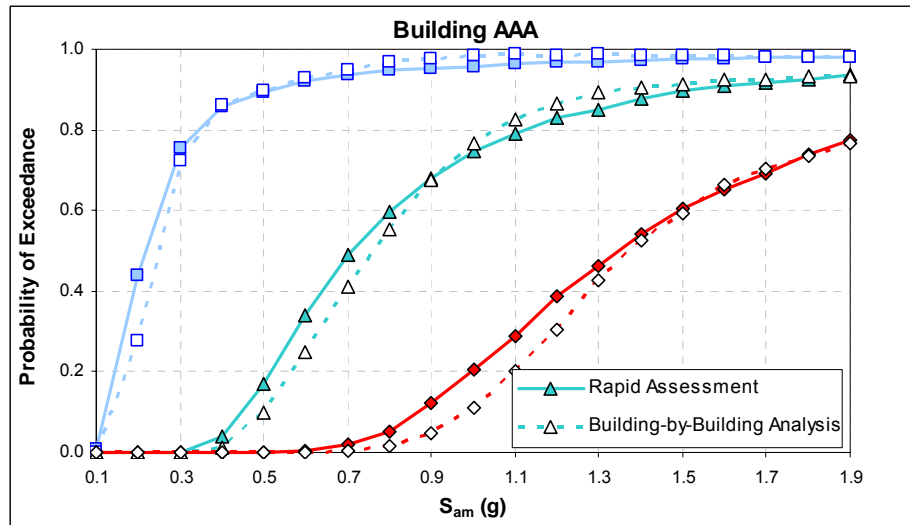

Figure 4.45: Validation of the Fragility Curves by Rapid Assessment Approach

The ability to quickly estimate a fragility relation for an individual building in a target portfolio is a step toward more accurate seismic loss estimation. Nevertheless, the hypothetical building portfolio presented in this study is composed of only a single building structural classification. This may be unrealistic because an actual portfolio of interest will likely contain buildings of several structural classifications. Ultimately, regionally derived metamodels for every major building classification must be formulated based on the building inventory data. A similar process to that used in this study for the S1-L classification can be utilized to generate metamodels for all other building classes.

The greatest benefits from using metamodels are their computational efficiency and versatility. Considerable computational cost may be necessary in the process of actually generating the global metamodels, but utilizing them in the loss estimation process requires relatively little computational effort, even for Monte Carlo simulation. After metamodels

PROJECT DS-5 FINAL REPORT

applicable for building inventory in a geographical region are developed, they can be implemented for any portfolio of interest located within the same region.

In summary, this chapter presents a means for a rapid fragility computation. Response surface metamodels are applied in the prediction of seismic response for an aggregation of buildings. Results from the simulations can provide the seismic fragility of an individual building in a portfolio. However, the results from this report must be considered hypothetical at this point, but the method is shown to be effective and can be directly applied to some of the available data sets.

CHAPTER 5 FRAGILITIES OF BUILDING COLLECTIONS USING 3D MODELS

The use of response surface metamodels for computing seismic fragilities has been shown to be accurate and efficient for the building collections using 2D models. Focus is now shifted to an implementation of the approaches for 3D structures taking into account torsional effects and different seismic loading directions in this chapter. More specifically, the fragility of the class of 5-story L-shaped steel moment frame (LSMF) structures typical of office construction in Mid-America will be treated.

5.1 Fragility Assessment of 5-story LSMF Building Portfolio Using 3D models

Previous chapters have considered the problem of rapid fragility estimation of collections of buildings and have focused on using two-dimensional representations of the building structures. However, three-dimensional analyses should be used in a rapid assessment to adequately represent the behavior of both the regular and the irregular structures in Mid-America. For structures with planform irregularities, the main predictors for assessment of their seismic response must first be defined. A specific class of structures, 5 story L-shaped steel moment frame structures, is treated. Variables included in the investigation include both micro-parameters (*i.e.*, material properties) and macro-parameters (*i.e.*, eccentricity, building design code level, and earthquake loading direction). The statistically significant predictors for rapid response assessment are identified by using the same Design of Experiments (DOE) approach described in Chapter 3. These parameters are then used to develop response surface metamodels to describe the structural response to an earthquake. Appropriate fragility curves for the LSMF structures are then constructed using the metamodels and Monte Carlo simulation. Finally, the methodology is applied to estimate the fragility for a portfolio of buildings that includes LSMF structures. As for the two dimensional case, the limit state condition for defining the fragility is considered to be the peak inter-story drift.

5.2 System Definition

The lack of detailed inventory data for 5-story LSMF structures, and more specifically the structural plans for buildings in the inventory, in a target region requires additional steps to define suitable models on which to base the development of RSM's. The target region is broadly defined to be Mid-America, and in order to obtain the most probable 5-story LSMF structure configurations in this region, a survey of structural and architectural experts was carried out. General information on the survey participants is listed in Table 5.1. Nine out of twelve experts contacted at a recent U.S. national meeting (ASCE/SEI Structures Congress, 2005) responded to a short questionnaire. These experts included practicing structural engineers with on average 30 years of building design experience. The survey also included several architectural and structural engineering professors with on average 20 years of research experience in their related fields.

Table 5.1: Number and Position of Respondents Who Completed the Survey

Respondents	Number
Structural Engineers	6
Architectural Professors	1
Structural Engineering Professors	2

For the survey, a suite of realistic code-compliant structural configurations were synthesized as shown in Figure 5.1(b). These configurations were identified using NEHRP guidelines [FEMA, 1986] which state that when a_2/a or b_2/b , see Figure 2(a), are larger than 0.15 to 0.20, the structure should be classified as irregular. The reference building is based on the 4 by 6 bay configurations used in the SAC Steel Program as described in Appendix B of FEMA-351 [FEMA, 2000]. The respondents were first asked to select the planforms that they felt were most prevalent in buildings designed based on pre-seismic codes. They were then asked to select the planforms that they felt would be most common for designs carried out using seismic codes (no specific code references were made). Table 5.2 shows the number of people selecting different LSMF structures based upon pre-seismic code design (identified as Old) and the number of

PROJECT DS-5 FINAL REPORT

people selecting planforms based on seismic code design (identified as New). The number of responses is tabulated in the third column labeled as Sum. From the results of this survey the most likely LSMF structural configurations identified by the respondents are shown in Figure 5.2.

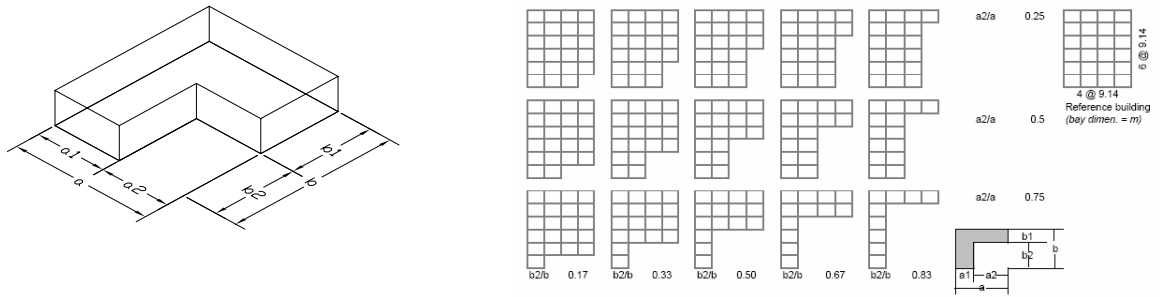

$a2/a > 0.15-0.20$ and $b2/b > 0.15-0.20$

(a) Geometry irregularities

(b) L-shape plan

Figure 5.1: Selection of Most Probable 5-Story LSMF Structures

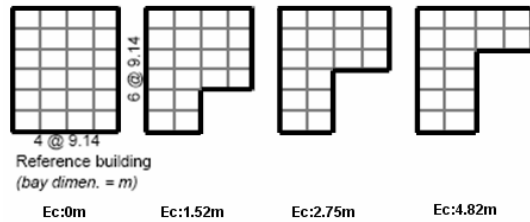

Figure 5.2: The Most Probable LSMF Structure Configurations

Table 5.2: Number of People Selecting Different Configurations of LSMF Structures

a2/a	Old	New	Sum	Old	New	Sum	Old	New	Sum	Old	New	Sum	Old	New	Sum
	b2/b														
	0.17			0.33			0.5			0.67			0.83		
0.25	2	1	3	0	0	0	0	0	0	1	0	1	0	0	0
0.5	0	2	2	5	4	9	5	7	12	6	3	9	0	0	0
0.75	0	2	2	0	0	0	0	1	1	1	0	1	2	0	2

The potential input parameters considered for this study include earthquake loading direction, building design code, structural eccentricity (identified as Ec.), bottom floor height, steel yield strength, damping coefficient, and steel Young’s modulus. Table 5.3 summarizes these potential input parameters for RSM development. As mentioned earlier these parameters can be divided into 2 groups: geometric/structural parameters, also called macro-level parameters

(X1, X4, X5 and X6), and parameters for material properties, also called micro-level parameters (X2, X3 and X7). The LSMF parameter values used here, include the reference building (*i.e.*, $E_c = 0$ m) and the most probable L-shaped building (*i.e.*, $E_c = 4.82$ m), as obtained from the survey results shown in Figure 5.2. It should also be noted that the number of stories is not included because preliminary studies suggested that it is not a significant factor for structures under 5 stories and because of the added complexity of the required structural models.

Table 5.3: Potential Input Parameters for 5-story LSMF Structures

Parameters	Values		
	-1	0	1
X1 Earthquake Direction (Deg)	0	67.5	135
X2 Steel Yield Strength (MPa)	250	375	500
X3 Damping Coefficient (%)	2	4	6
X4 Bottom Floor Height (m)	3.96	4.95	5.94
X5 Building Design Code	Wind	Low Seismic	High Seismic
X6 Eccentricity (m)	0	2.75	4.82
X7 Steel Young's Modulus (GPa)	190	200	210

The building design code levels are classified in order of severity of requirements as wind design, low seismic design, and high seismic design. The wind design is based on the 1969 Southern Standard Building Code [SSBC 1969] following the design provision for wind loads and is assumed to be applicable to any 5-story LSMF structures constructed prior to 1988 in the region. Low seismic design represents the less stringent seismic design in the region and is applicable to 5-story LSMF structures constructed between around 1988 and 2001. This design is in accordance with the 1988 American Society of Civil Engineering Standard [ASCE, 1988]. High seismic design represents the most stringent design standards and is applicable to 5-story LSMF structures designed and constructed after the year 2001. This design is in accordance with 2000 International Building Code [IBC, 2000] based upon the Load and Resistance Factor Design (LRFD).

PROJECT DS-5 FINAL REPORT

In order to carry out the screening process and subsequently to create the response surface metamodel, it is necessary to have a suitable 3D structural model that is capable of computing limit state structural response for selected earthquake inputs. Without access to structural plans for representative buildings in the target region, it is necessary to actually design the sample building as specified by the given micro- and macro-parameters. GTSTRUDL [GTSTRUDL, 1999] is used to carry out the design using the allowable stress design (ASD) method to meet the SSBC and ASCE design requirements. The same approach is used for the IBC design using the LRFD method. The member selection criteria are specified such that the beams are of the same section in each floor and, at the same time, the columns are of the same section for all exterior columns (E. columns) and interior columns (I. columns). Table 5.4 shows a representative example of beam and column sections in a particular building design (the 5-story LSMF structure with eccentricity (Ec.) 2.75m and mean values for the other geometry).

Table 5.4: 5-story LSMF structure designs (Ec. : 2.75m)

(a) Beam and column sections for the building designed with SSBC 1969

Story	Moment Resisting Frames		
	E. Columns	I. Columns	Girders
1	W14X111	W14X111	W24X76
2	W14X111	W14X111	W24X76
3	W14X95	W14X95	W24X76
4	W14X95	W14X95	W24X76
5	W14X68	W14X68	W24X68

(b) Beam and column sections for the building designed with ASCE 1988

Story	Moment Resisting Frames		
	E. Columns	I. Columns	Girders
1	W14X132	W14X132	W24X94
2	W14X132	W14X132	W24X94
3	W14X109	W14X109	W24X94
4	W14X109	W14X109	W24X94
5	W14X68	W14X68	W24X84

(c) Beam and column sections for the building designed with IBC 2000

Story	Moment Resisting Frames		
	E. Columns	I. Columns	Girders

1	W14X159	W14X159	W24X104
2	W14X159	W14X159	W24X104
3	W14X120	W14X120	W24X104
4	W14X120	W14X120	W24X104
5	W14X68	W14X68	W24X103

5.3 Screening to Identify Optimal Parameters

A Design of Experiments technique is used to generate a seven dimensional experimental space composed of different levels of each input parameter. For the purpose of a screening test, a Fractional Factorial design [JMP, 2005] was employed in this study. A two-level design only uses minima and maxima of the input variables to form the design space. The 16 experimental cases with 7 input parameters and their corresponding upper and lower level values are shown in the left half of Table 5.5. The values of -1 and +1 denote the minima and maxima of the input variables, respectively, as defined in Table 5.3. For instance, the first case is constructed by using maximum values for building design code (X5), steel Young’s modulus (X7) and by using minimum values for earthquake loading direction (X1), steel yield strength (X2), damping coefficient (X3), bottom floor height (X4), eccentricity (X6).

Table 5.5: Design matrix and response data from nonlinear time-history simulation

Run	Pattern Parameters							Peak inter-story drift ratio (%) Spectral acceleration (S _a)		
	X1	X2	X3	X4	X5	X6	X7	0.1g	0.55g	1.0g
1	-1	-1	-1	-1	1	-1	1	0.34	0.79	2.19
2	-1	-1	-1	1	-1	1	-1	0.27	2.07	2.91
3	-1	-1	1	-1	-1	1	-1	0.29	1.74	4.83
4	-1	-1	1	1	1	-1	1	0.24	0.93	3.02
5	-1	1	-1	-1	1	1	-1	0.36	1.81	4.37
6	-1	1	-1	1	-1	-1	1	0.25	2.17	3.73
7	-1	1	1	-1	-1	-1	1	0.28	1.13	3.35
8	-1	1	1	1	1	1	-1	0.25	2.26	3.81
9	1	-1	-1	-1	-1	-1	-1	0.23	0.90	2.91
10	1	-1	-1	1	1	1	1	0.19	1.05	2.56
11	1	-1	1	-1	1	1	1	0.22	0.86	2.53
12	1	-1	1	1	-1	-1	-1	0.17	0.97	2.29
13	1	1	-1	-1	-1	1	1	0.21	1.88	3.31
14	1	1	-1	1	1	-1	-1	0.19	0.94	2.58
15	1	1	1	-1	1	-1	-1	0.20	0.60	1.55
16	1	1	1	1	-1	1	1	0.18	1.63	2.82

PROJECT DS-5 FINAL REPORT

The limit state structural response is computed for each of the experimental cases using the Zeus-NL software for the inelastic analysis of structures [Zeus, 2005]. In particular, Zeus-NL is used to find peak inter-story drifts for each of the different experimental cases under three different synthetic ground motions for three different spectral accelerations at the fundamental period of the structure. The right half of Table 5.5 displays the results for the sixteen models (combinations) subjected to 0.1g, 0.55g and 1.0g spectral accelerations using the most recently available uniform hazard synthetic ground motion records [Rix *et al*, 2004].

The most influential parameters were determined by least-squares regression [JMP, 2005] based on the results of the sixteen combinations. The scaled estimates are the coefficient estimates divided by the standard deviation of the input parameter so that the estimates can be reasonably compared with each other. The Pareto plot is a composition of an absolute value of each scaled estimate normalized to the sum. The parameter with highest scaled estimate represents the most influential parameter and corresponds to the case where a minor change in the value of the input parameter produces a major influence on the output calculation given that all other input parameters remain constant.

As shown in Figures 5.3-5.5 (a), the R^2 values are computed to be 0.95, 0.92 and 0.67. In general, a higher R^2 value indicates a better fit of the regression model so that the models with 0.1g and 0.55g spectral accelerations applied to them were better correlated between actual and predicted values than the models when subjected to 1.0g spectral acceleration inputs. However, almost all of the results are within the dotted red lines which correspond to how well the model is being predicted. Thus it appears that the screening test would probably capture the variability quite well.

In particular, part (b) of Figures 5.3-5.5 show the plots of the scaled estimates for each of the input parameters in what is called a Pareto plot. The solid curve in the figures indicates the

PROJECT DS-5 FINAL REPORT

cumulative contribution to the overall response while the individual contribution, or scaled estimate, is indicated by the horizontal bar. It is obvious from Figure 5.3 (b) for 0.1g spectral acceleration input that the first two parameters (X1 and X4) contribute almost 75% of the overall response. It is also seen from Figure 5.4 (b) for 0.55g spectral acceleration input that the first three parameters(X6, X1 and X5) influence almost 70% of the overall response. Similarly, the first 3 parameters (X1, X6 and X5) in the case of 1.0g spectral acceleration input contribute to almost 70% of the overall response as seen in Figure 5.5.

When 0.1g spectral acceleration records are applied to the sixteen models, the significant variables are different from the results when 0.55g and 1.0g inputs are applied to the same combinations. The LSMF structures designed to the wind code considered only wind load in their design but performed well under the low seismic loads characterized by the 0.1g spectral acceleration records. However, when 0.55g and 1.0g spectral acceleration records are applied to the sixteen representations, the building design code is now observed to be a significant parameter. Based upon these screening results, X1, X4, X5 and X6 are chosen as the Pareto-optimal parameters for determining the seismic response of three-dimensional LSMF structures subjected to ground motions with three different spectral accelerations. Thus, these four parameters are used as the input variables for the computing a response surface covering most of the feasible space.

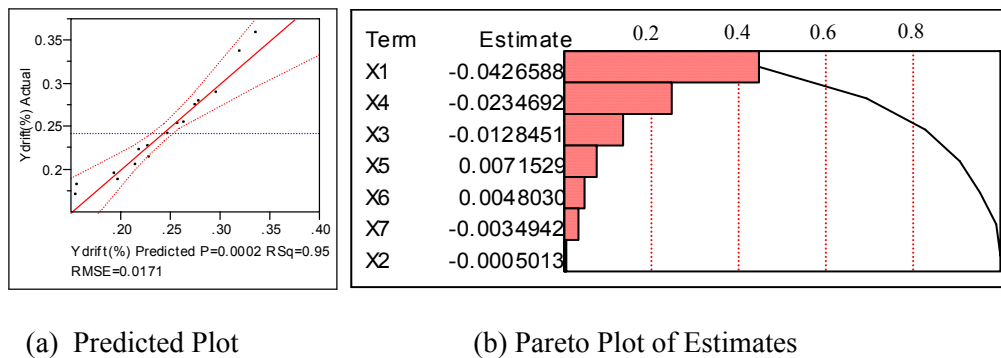
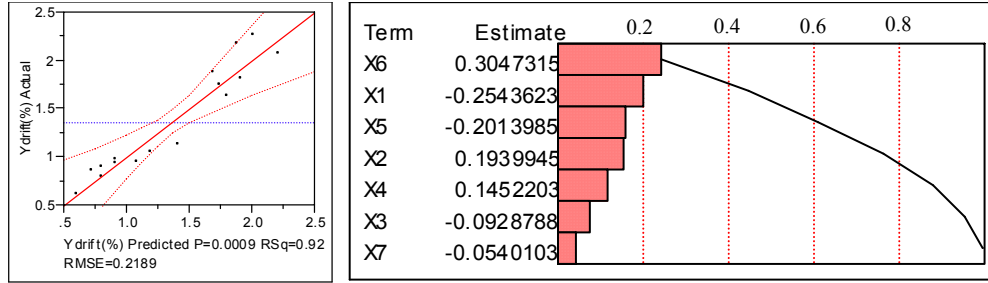

Figure 5.3: Results for 0.1g spectral acceleration



(a) Predicted Plot

(b) Pareto Plot of Estimates

Figure 5.4: Results for 0.55g spectral acceleration

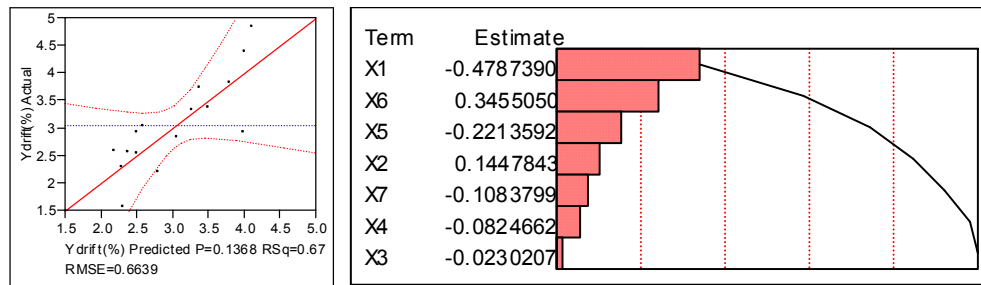

(a) Predicted Plot

(b) Pareto Plot of Estimates

Figure 5.5: Results for 1.0g spectral acceleration

5.4 Design of Experiments for RSM's

The next step is to develop a response surface metamodel based on the screened parameters that is capable of estimating the limit state response of the buildings. The input parameters for the response surface model are composed of 2 components: the four Pareto-optimal parameters and a control parameter. The four parameters are X1(earthquake direction), X4 (bottom floor height), X5 (building design code) and X6 (structural eccentricity). The control parameter is the spectral acceleration that defines the earthquake intensity level. The model output is the peak inter-story drift (%). The selected input parameters and their lower,

Table 5.6: Screened input parameters for RSM

Parameters		Values		
		-1	0	1
X1	Earthquake Direction (Deg)	0	67.5	135
X4	Bottom Floor Height (m)	3.96	4.95	5.94
X5	Building Deign Code	Wind	Low Seismic	High Seismic
X6	Eccentricity (m)	0	2.75	4.82
Xs	Spectral Acceleration (g)	0.1	0.55	1

It has been suggested [Cornell, 1996] that the variability in the response due to ground motion can be at least roughly estimated using only 4 to 5 recorded earthquake accelerograms. In this study, ten synthetic ground motion [Rix et al, 2004] are randomly selected according to the three required levels of the spectral acceleration at the fundamental period of the structure to form a block of inputs. Also then an appropriate design should be selected on the basis that the resulting function provides good fit to the data points and, at the same time, requires a minimal number of observations.

The initial study by Towashiraporn [2004] described in Chapters 3 and 4 investigated the use of a Full Factorial Design (FFD), a Central Composite Design (CCD), and a Box-Behnken Design (BBD) for generating response surfaces. It was found that the CCD showed the best compromise between accuracy and computational effort required. A CCD with four input parameter and control parameters (selected as the average spectral acceleration) contains 43 sample points. As a result, nonlinear structural models for a total of 43 LSMF structures models defined by the CCD are constructed. In order to consider torsional and earthquake loading direction effects in this study, fully 3D LSMF structural models are employed. Nonlinear time-history analysis is performed using Zeus-NL software on each LSMF structure following the same methods as used in the screening process. Three blocks of ten synthetic ground motions with different spectral accelerations are applied to each treatment and so the total number of simulations is 430 as seen in Table 5.7. The peak inter-story drift is extracted as the output.

Forty three sets of output and the corresponding treatments of inputs are used to fit the RSM model using a least-square regression analysis. The response surface obtained from this regression analysis thus approximates the peak inter-story drift for different LSMF structures for increasing values of ground motion intensity. The output (peak inter-story drift) is formed from the mean value from the RSM plus one standard deviation to account for uncertainty in the model. The use of average spectral acceleration (S_{a_m}) as a measure of seismic intensity is suggested for cases that involve the fragility analysis of several buildings with different periods [Towashiraporn, 2004].

Table 5.7: Design Matrix and Response Data for RSM

Run	Pattern					Peak inter-story drift ratio (%)	
	Parameters					Spectral acceleration (S_a)	
	X1	X4	X5	X6	Xs	Mean	Std
1	1	1	-1	-1	-1	0.31	0.06
2	-1	1	1	-1	-1	0.32	0.05
3	-1	1	1	1	1	3.69	1.60
4	1	1	1	-1	-1	0.23	0.04
5	-1	-1	1	-1	-1	0.13	0.04
6	1	1	-1	-1	1	3.78	1.15
7	-1	1	-1	-1	1	5.39	1.87
8	-1	1	1	1	-1	0.50	0.10
9	1	-1	1	1	1	1.21	0.38
10	-1	-1	-1	-1	-1	0.18	0.03
⋮	⋮	⋮	⋮	⋮	⋮	⋮	⋮
⋮	⋮	⋮	⋮	⋮	⋮	⋮	⋮
40	1	-1	1	1	-1	0.18	0.04
41	0	0	-1	0	0	1.88	0.56
42	0	-1	0	0	0	1.11	0.14
43	0	0	1	0	0	1.33	0.20

Three-dimensional prediction plots in terms of mean and one standard of the maximum drifts are shown in Figure 5.6. In the prediction plots, the seismic response is plotted against each of the input parameters, while other input variables are fixed at their center point values. The purpose of this plot is to observe the trend of the response due to effects from changed input

parameters and fixed control parameter. It obviously appears that X4 more considerably affected the seismic responses than X1, X5 and X6 as seen in Figure 5.6.

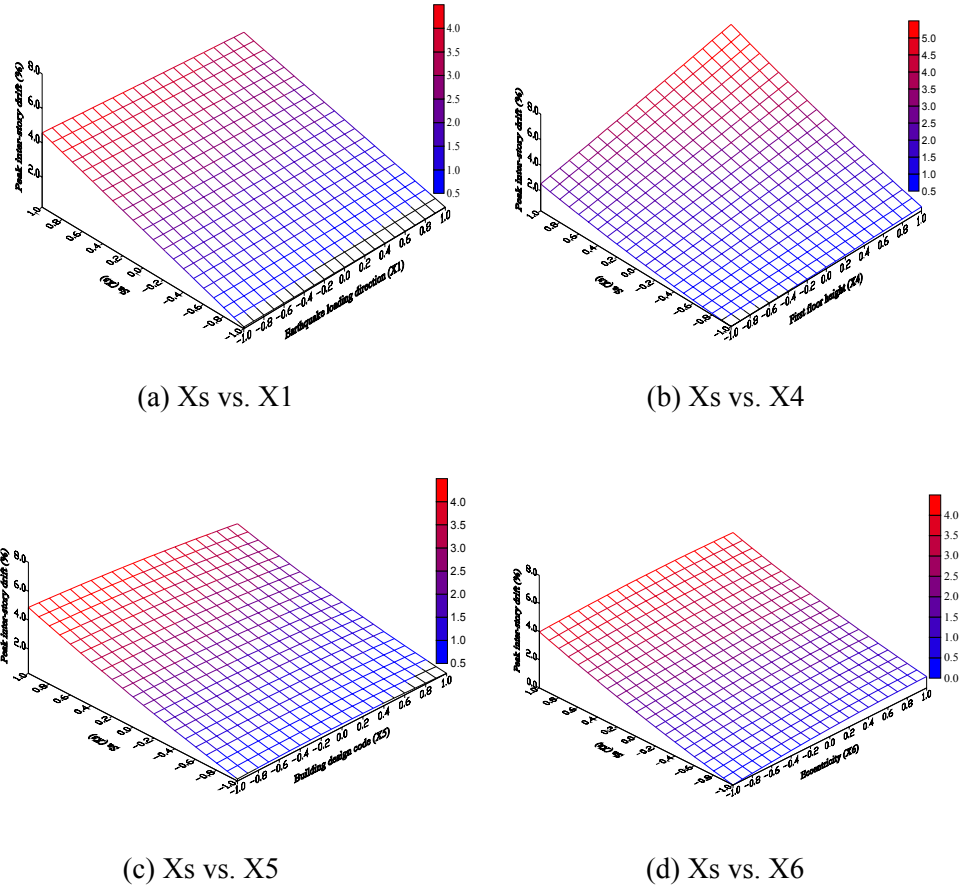

Figure 5.6: Response surface metamodels using polynomial regression function

5.5 Performance Measures

The performance measures relate to the ability of the RSM's to reproduce the behavior of LSMF structures over a range of values of the considered parameters. These are necessary to verify the overall accuracy of the RSM's. The statistical tests at additional random data points in the design space must be performed.

So as to calculate the metamodel performance measures, the original 3D LSMF structural model is compared with the continuous response surface function developed in this study. Three measures of metamodel performance are considered: (1) mean absolute error (MAE), (2)

maximum absolute error (MAX) and (3) root mean square error (RMSE) [Venter et al, 1997]. For the purpose of these statistical tests, 43 combinations of input parameters are generated at random. Peak inter-story drifts computed from the original 3D simulation and the continuous response surface function are calculated for each combination and the statistical measures are computed as follows:

$$MAE(\%) = \frac{\frac{1}{N} \cdot \sum_{i=1}^N |y_i - \hat{y}_i|}{\frac{1}{N} \cdot \sum_{i=1}^N y_i} = 13.4\% \quad (5.1)$$

$$MAX(\%) = MAX_i \left[\frac{|y_i - \hat{y}_i|}{\frac{1}{N} \cdot \sum_{i=1}^N y_i} \right] = 55.2\% \quad (5.2)$$

$$RMSE(\%) = \frac{\sqrt{\frac{1}{N} \cdot \sum_{i=1}^N (y_i - \hat{y}_i)^2}}{\frac{1}{N} \cdot \sum_{i=1}^N y_i} = 17.2\% \quad (5.3)$$

where \hat{y}_i is predicted peak inter-story drifts obtained from the response surface function for the five-story LSMF structures and y_i are actual peak inter-story drifts gained from the original 3D simulation.

The above measures quantify the error, in percentage, that the predicted peak drifts between the response surface metamodel and the actual values computed using the original 3D simulation. It can be seen that the levels of MAE and RMSE in the model are reasonably low and are an indication of good agreement. The MAX value is a much higher and reflects less accuracy for the response surface in predicting the extreme levels of response. Since this is more sensitive to single events, it is not expected to have a major effect on the estimation of fragilities which describe a cumulative damage probability.

5.6 Rapid Seismic Response Assessment

As an example application of the response surface approach presented above, a vulnerability assessment is performed for a hypothetical LSMF structure portfolio consisting of eight 5 story LSMF structures (“cases”) located in Memphis, TN. Assumed characteristics of each structure are shown in Table 5.8. For some cases specific values of the control variables are known and are listed in the table. When specific values for control variables are not available, they are replaced using values estimated from the statistics of the target population. In this example the earthquake direction and bottom floor height are assumed to follow a uniform distribution while the eccentricity is assumed to follow a skewed normal distribution (in accordance with eccentricity calculation for the L-shaped planforms previously considered). The building design code is treated as a discrete distribution and each discrete distribution probability is computed based on the inventory data for year built in the Memphis area.

Table 5.8: Characteristics of Eight LSMF Structures in a Hypothetical Portfolio (the presence of * in a field indicates that it is defined as a random parameter).

Structure	Class	Number of Stories	Earthquake Direction (Deg)	Bottom Floor Height (m)	Year Built	Eccentricity (m)
CASE 1	LSMF	5	*	*	1965	*
CASE 2	LSMF	5	*	*	2001	*
CASE 3	LSMF	5	*	*	*	0
CASE 4	LSMF	5	*	*	*	4.82
CASE 5	LSMF	5	90	*	*	*
CASE 6	LSMF	5	0	*	*	*
CASE 7	LSMF	5	*	3.96	*	*
CASE 8	LSMF	5	*	5.94	*	*

Monte Carlo simulations (10,000 trials) are carried out on the response surfaces using the assumed probability density functions. The probability of the response exceeding a certain limit state can be computed from a suitably large number of outputs obtained from the simulation. This yields a value of fragility for a specific level of spectral acceleration. The process is repeated for other sets of synthetic ground acceleration records. Vulnerability for various

earthquake intensity levels can be plotted in the form of a fragility curve. Figure 5.8 shows fragility curves constructed from the simulated probabilities (indicated by the points) for different limit states (inter-story drift) corresponding to Immediate Occupancy (IO), Life Safety (LS) and Collapse Prevention (CP).

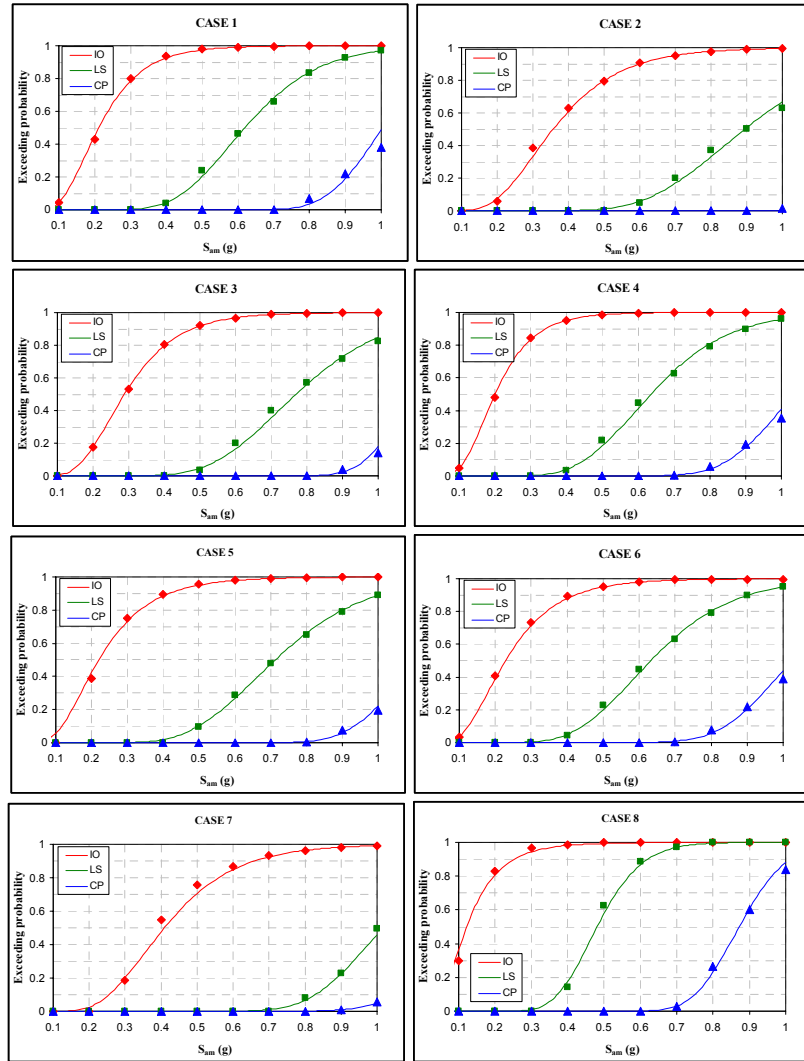

Figure 5.7: Fragility curves for LSMF structures in a hypothetical portfolio

Figure 5.7 also shows lognormal functions (solid curves) that are fitted to the simulation data, and the results show a high level of goodness of fit to the Monte Carlo results. It is apparent that, even though all eight LSMF structures are in the same classification, they exhibit notably

PROJECT DS-5 FINAL REPORT

different seismic vulnerability functions. As a result, the use of generic fragility curves for all LSMF structures in the same class may produce an erroneous assessment of the potential seismic loss. It can be seen that structural parameters related to geometric configuration such as eccentricity and bottom floor height have more influence on fragilities for LSMF structure than earthquake loading direction as shown in Figure 5.7. The building design code used also has a significant effect on the seismic fragility curve. For example, CASE 2 built in 2001 does not have a failure probability for the case of CP (see Figure 5.7).

CHAPTER 6

FRAGILITIES FOR EARTH DAMS

Earth and rockfill dams, if breached during or as a result of an earthquake, can produce serious consequences ranging from direct loss of life to indirect economic losses for a region. Hence, the ability to conduct a detailed investigation of the seismic response of all dams in a region that can potentially be impacted by an earthquake is desirable. An inherent challenge in conducting such a regional assessment results from the number of dams and the lack of complete and consistent engineering information regarding the structural and material properties of the dams, as well as the usual uncertainty associated with the occurrence and magnitude of seismic events. As part of this project to explore using metamodels to capture uncertainties in computing the seismic response of structures and geostructures across a region, this portion of the study presents an integrated, scalable framework for computation and presentation of the seismic response of earth and rockfill dams present in an earthquake vulnerable region.

The focus in this portion of the study is on the development of a regional based methodology with which the seismic response of a large number of dams can be efficiently computed and viewed in a spatial framework. Clearly, this task cannot be accomplished if each dam has to be analyzed for different earthquake scenarios, different material properties and different retained water levels. Instead, a metamodel-based methodology following the basic developments presented in Chapter 3 is adopted to efficiently simulate the seismic response of all of the dams in the region of interest.

Fig. 6.1 shows a flowchart which outlines the step-by-step procedure adopted for response simulation of all of the dams in the geographic region of interest. The framework involves a series of steps in which the entire dam population and the seismic hazard they may experience is first analyzed. For example, the initial step in the process requires an iterative process wherein the dams contained in the inventory are grouped using a range of factors such as

type of dam (*e.g.* zoned-filled or monolithic), height, upstream/downstream slope characteristics, and foundation conditions amongst others. Based on this, the characteristics of a small number of carefully selected dams from the inventory that are representative of all those contained in the database are identified. These few representative dam models are the ones that are subsequently analyzed in detail and whose responses are used as the basis for damage prediction of all dams in the inventory. In parallel with identification of the “representative dams” from the inventory, seismic hazard analyses are conducted for selected dam types to allow for identification of dams that are likely to be more or less vulnerable to seismic activity in the selected region. Through this process, which relies on preliminary analysis results, the characteristics of a set of dams that are expected to represent both the dam type and seismic response are identified.

Once these representative dams are identified, then the properties of the models for detailed seismic hazard and dynamic response are established. In simple terms, this is the screening process where specific physical attributes of the representative dams (*e.g.*, height, upstream/downstream slopes, crest width, free-board) are identified and the material properties (*e.g.*, soil density, hydraulic conductivity, shear strength, compressibility) are selected based on site specific as well as established correlations for geo-material properties. Using these representative dams, the formulation of the metamodel is established and the seismic response prediction of all dams in the region of interest is predicated using the resulting response surface. Parameter uncertainty is analyzed using Monte Carlo simulation on the resulting predicted dam response and the results can be integrated in the spatial analysis framework.

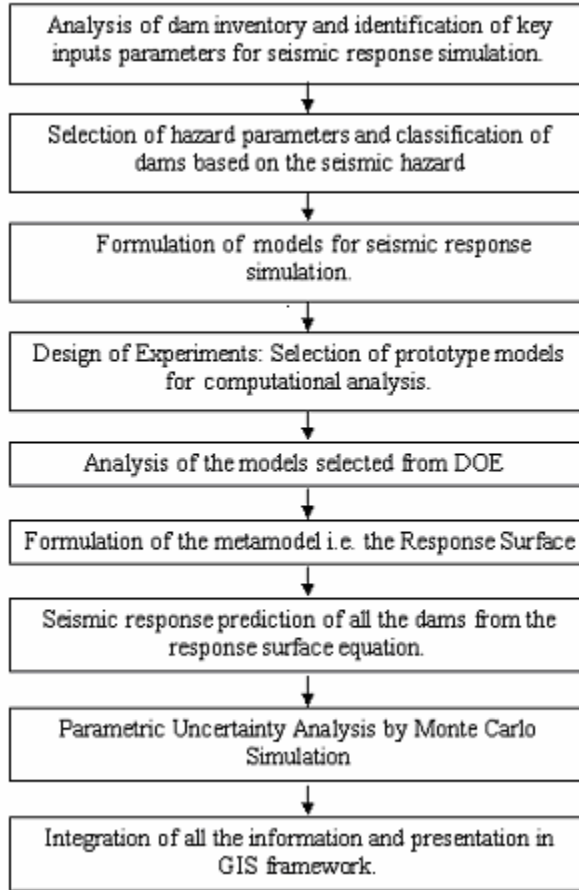

Figure 6.1: Flowchart of Analysis Methodology

6.1 Inventory of Earth Dams

A base requirement for the proposed seismic response simulation is the availability of an inventory of earth and rockfill dams in a consolidated electronic format. The inventory data required for computational analysis using the commercial finite difference code developed for analyzing geostructures called FLAC (Fast Lagrangian Analysis of Continua) can be classified in the following categories:

- Embankment dam and foundation geometric characteristics (dam height, storage capacity, upstream slope, downstream slope, upstream blanket, depth of bedrock below base of

PROJECT DS-5 FINAL REPORT

dam, depth of different soil strata below dam, geometry of internal zones in zone-filled earth dam,

- Embankment dam material parameters (strength, compressibility and hydraulic conductivity of the various soils types represented in the embankment),
- Foundation material parameters (strength, compressibility and hydraulic conductivity of the various soils types represented in the foundation soils), and
- Seismic parameters (expected ground acceleration, earthquake magnitude, epicentral distance).

The above information represents the range of information required for robust dynamic analysis of embankment dams using advanced numerical techniques. Unfortunately, in many cases, particularly when dealing with older dams, not all information may be available in archived records, if indeed it was ever determined at the time the structure was built. Accordingly, geotechnical engineers routinely utilize indirect methods ranging from regional geological interpretations from sources such as aerial photography and other macro-scale studies to estimate subsurface material properties. In addition, established correlations between limited index properties such as moisture contents and grain size distributions are utilized to provide estimates of engineering properties such as strength, compressibility and hydraulic conductivity. While the researchers in this study do not recommend this approach for detailed analysis of specific dams, they are considered acceptable when other data sources are not available for regional studies such as the one described herein.

The inventory of earth and rockfill dams available from the National Inventory of Dams (NID) website [<http://crunch.tec.army.mil/nid/webpages/nid.cfm>] was used as the basis for the study reported herein. The legal and technical aspects of dam inventory data collection are described in the literature [USACE, 2001]. The dam inventory for the entire United States was initially obtained from the NID website for this study. The inventory is in .dbf format and can be

PROJECT DS-5 FINAL REPORT

viewed using any commercially available GIS program. The database includes more than 65,000 dams a subset of which was selected based on location information provided in the database. Only earth, rockfill and hybrid earth-rockfill dams as listed in the database were considered in this study. If essential data required for response simulation and data presentation was not reported (dam type, latitude, longitude, dam height or storage capacity), then this record was excluded from subsequent analysis. Fortunately, these incomplete data sets accounted for less than 1% of the total inventory being used in this investigation.

It was also noted that other information such as dam age, design characteristics, and foundation type was not reported for many dams (dam design and foundation data is not reported for 95% of the dams in the database – particularly small and medium height dams) thus the dams were analyzed for a range of assumed material properties.

The dams present in the Mid America region will not experience the same shaking levels in the event of a seismic event in the Mid-America region thus seismic hazard information must be determined for use in seismic response computations for dams of interest. Presently, hazard information for different dam locations is not available in the NID database.

For the present study, the seismic hazard of the dams must be defined for the following reasons:

- to select the relevant dams to be analyzed based on the severity of hazard expected to be experienced by the dam;
- to define the model parameters for the FLAC numerical simulation models;
- to define the predictor variables for statistical analysis, *i.e.* to define metamodels.

The seismic hazard itself can be defined using a deterministic seismic hazard analysis (DSHA) or a probabilistic seismic hazard analysis (PSHA). The former methodology uses deterministic scenario earthquakes while the latter incorporates uncertainty in source, path and

site [Kramer, 1996]. For this study, the seismic hazard was defined using USGS maps, which were developed using PSHA [Mueller et al, 1996].

USGS based seismic hazard definition yields some distinct advantages. First, the USGS method utilizes the PSHA approach and incorporates all possible seismic zones, thereby eliminating the need for defining different earthquakes for each deterministic hazard scenario. The USGS method also uses several weighted attenuation relationships to define the expected hazard at different locations for different boundary conditions. The hazard is computed in terms of Spectral Acceleration values for periods of 0.0, 0.2, 0.3 and 1.0 seconds and for 2%, 5% and 10% probability of exceedance levels and is presented in the form of Spectral Acceleration contours as shown in Figure. 6.2.

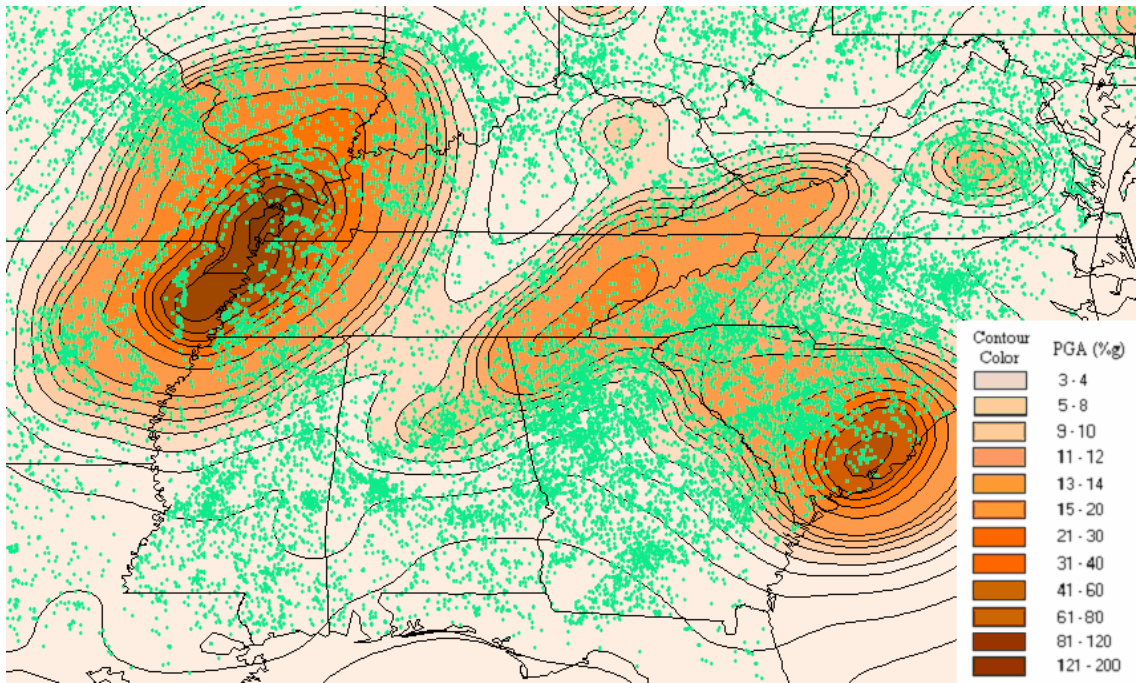

Figure 6.2: Spatial Distribution of dams with respect to Seismic Hazard in Mid America region

As a result of their location, the dams will experience different levels of seismic hazard. To account for this in the simulation, the spatial variation in ground acceleration was coupled with the dam location. Since dam locations are reported in the NID database in latitude-longitude

PROJECT DS-5 FINAL REPORT

format, a database integration with the USGS seismic hazard maps was carried out using GIS tools. A series of maps were developed to give insight into the spatial distribution of dams with respect to seismic hazard. Fig 6.2 shows one such map with the NID dams overlaid on the 2% probability of exceedence USGS hazard maps.

Using the GIS tools, a spatial analysis was performed wherein the NID dams database was integrated with the USGS spectral acceleration values. After the integration, the seismic values were appended to the information extracted from the existing NID database. This resulted in an enhanced dam database, which also contains the seismic hazard defined in terms of spectral acceleration values for the three probability of exceedence levels.

Table 6.1 summarizes the spatial distribution of dams present in the Mid America region. The PGA from USGS maps (2% P.E. in 50 years) was used as an initial indicator of seismic hazard in the table. Clearly there are a large number of dams in the low hazard range and a relatively small number of dams in the high hazard range. Dams which are likely to experience a PGA of less than 0.1g with 2% P.E. were not included in the analysis. Nevertheless, the large number of dams remaining justifies the proposed metamodeling approach.

Table 6.1: Spatial Distribution of Dams in Mid America Region

PGA Range(g)	Average PGA(g)	Number of Dams	Max Height (m.)	Max Storage (m ³)
0.1 – 0.2	0.15	7606	100.9	4636943100
0.2 - 0.3	0.25	2869	109.7	3718728000
0.3 – 0.4	0.35	884	47.2	1706225400
0.4 – 0.5	0.45	436	30.5	20784681
0.5 – 0.6	0.55	198	29.3	188649000
0.6 – 0.8	0.70	158	22.6	102267486
0.8 – 1.2	1.00	195	15.5	1368630000
1.2 – 1.6	1.40	73	14.6	36373500

Knowing the spectral acceleration values at the dam location, the earthquake ground motions that can be experienced at that location can be computed. Although other spectral acceleration values were available, only PGA values were used for defining seismic hazard for

the subsequent analysis. This was because any attempt to define seismic hazard by more than one parameter would require more numerical model runs. This would in turn require a different design of experiments setup for the correlated spectral acceleration values. Most importantly, the response surface regression equation would require the removal of one of the highly correlated parameters used to define the hazard. Hence, the seismic hazard was defined using only the PGA value.

The time histories for various PGA values were generated using the SMSIM program [Boore *et al*, 2000]. This program uses stochastic methods and random vibration theory to generate synthetic ground motions. The program requires magnitude and distance as input and computes peak values (PGD, PGV, PGA) and a desired number of time histories. Time histories were generated by selection of a feasible combination of magnitude and distance, which resulted in the desired level of PGA. These time histories were used in the FLAC software for dynamic analysis of earth dams.

It is emphasized that these time histories represented a particular level of hazard in the form of PGA. Since the entire response spectrum is not utilized in the generation of time histories, this hazard definition has an epistemic component of uncertainty which can be removed by better hazard definition (*i.e.* definition of hazard by using the entire response spectrum). This however was not done in the present study because of the reasons discussed above. Even if the entire response spectrum is defined, the time histories cannot be uniquely defined. This leads to an aleatory uncertainty component in the seismic response. This aleatory uncertainty cannot be removed.

6.2 Numerical Modeling of Dams

The dynamic response of dams can be predicted using numerical models and the FLAC software (see Fig. 6.3 below). Several studies have used different computational packages for this

purpose ([Elgamal et al, 2002] and [Gazetas, 1987]). Any numerical model needs a minimum set of input parameters for complete definition of the prototype dam and for calculation of its dynamic response as noted earlier.

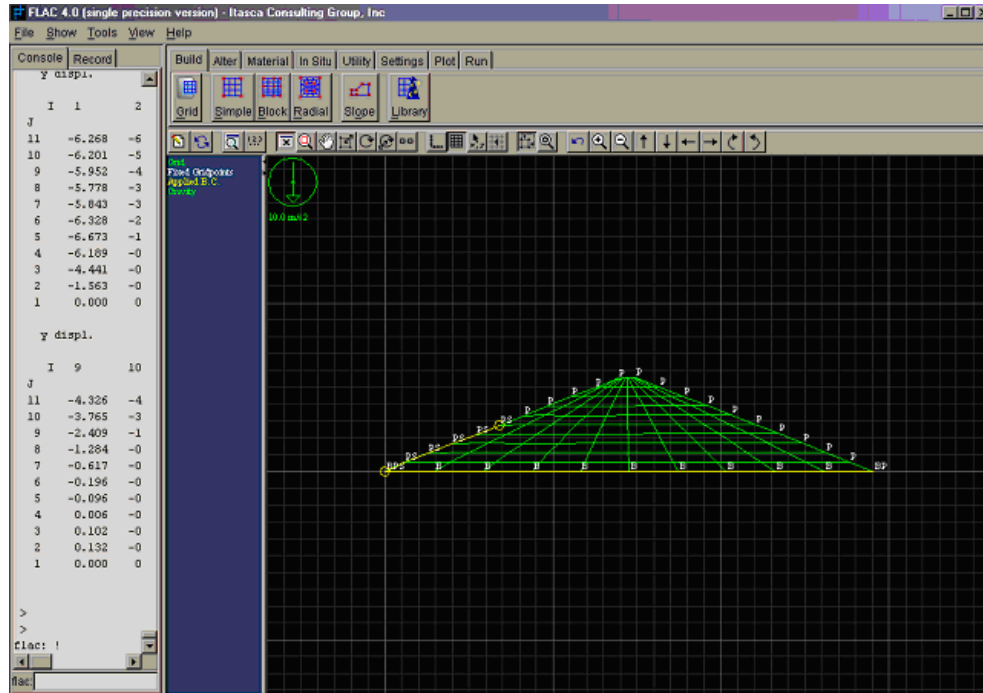

Figure 6.3: FLAC Model

As previously noted, this study utilized the commercial software FLAC to conduct the response simulation of dams [Itasca, 2000]. FLAC is an explicit finite difference program developed for geomechanics computations and the dynamic option available in FLAC offers a nonlinear and effective stress based approach for seismic response simulation that enables both the seismic induced pore pressure and the non-linear stress strain response of soil to be correctly modeled in the analysis.

6.2.1 FLAC Models

It is important to recognize that the FLAC software discussed throughout this section of the report is essential to the implementation of the response surface methodology. In particular,

the numerical analyses conducted using the software allow for advanced simulation of individual dams under selected boundary conditions

The approach used in this study was to develop and analyze several FLAC models of varying complexity for subsequent use in assembling the dam metamodel. Each FLAC model had a coherent set of dam properties, material parameters and assumptions and no specific model could be classified as the correct model. The best FLAC prototype was selected based on the following guidelines:

- The FLAC prototype should attempt to model the actual physical characteristics of the dam as closely as possible; minor design details could be omitted.
- The FLAC model assumptions should be compatible with other assumptions (*e.g.* hazard definition).
- The FLAC model parameters should be readily quantifiable and should also be used as metamodel parameters in the Design of Experiments process.
- The FLAC model should not be defined by a large number of variables because this would result in the need for an unnecessarily large number of factors for the Design of Experiments (DOE) process and consequently, would rapidly necessitate a significant number of additional FLAC numerical runs. Furthermore, it is anticipated that some of the variables would likely be proven to be less significant in the screening process to be developed .
- Given that certain key geo-material properties are based on correlations and other interpretative methods, the degree of complexity captured in the FLAC models should be consistent with this limitation. In other words, increasing the complexity and sophistication of the FLAC model will not lead to enhanced predictions if certain key material properties are based on indirect determinations.

- The FLAC model should simulate the dynamic response of the various soils in the dam and the foundation as closely as possible.

6.2.2 Model Specification

The FLAC model format is developed using the above criteria and incorporates a series of key model elements based on generally accepted protocols and structure responses confirmed by parametric analyses performed as part of this study.

The height of the dam (H_d) and the height of retained water (H_w) are identified as important model variables. The height of the dam is obtained from the NID database. The height of retained water are represented by a ratio of height of water to height of dam ($0 < H_w/H_d < 1$). The effect of height of retained water is studied by taking a range of different values for this ratio. An H_w/H_d value in the range of 0.9 to 0.95 would be indicative of the retained water behind the dam at “full stage”. Similarly, an H_w/H_d value of 0.5 or less would likely represent conditions following a period of sustained “below normal” precipitation. Based on parametric analyses, other design parameters are found to be less important and are either defined as a constant or as a multiple of height. For example, embankment slopes are taken to be 2.5H/1V, internal core slopes as 1H/1V and dam crest width as 10% of height of the dam. These defined values are representative of common practice.

As previously noted, material parameters were unavailable in the NID database for many cases thus it was decided to perform the dam analyses using material parameters values broadly based on accepted correlations. Three sets of soil parameters were selected for analysis purposes. These parameter sets were considered to be representative of poor (unengineered), fair (partially engineered) and good (well-engineered) soil types. The parameter values were selected to be internally consistent with selected parameter values being derived from $(N_1)_{60}$ (blow count) a established correlations. Table 6.2 lists the various soil parameters for each soil type incorporated

in the FLAC analyses in this study. These soil parameters are assigned to the embankment material. These values conform to [ASCE, 1999] and [USACE, 1994].

Table 6.2: Soil Parameters for FLAC Numerical Modeling

Soil Quality	SAND			CLAY		
	Poor	Fair	Good	Poor	Fair	Good
Soil Index	-1	0	1	-1	0	1
Blow count (N ₁) ₆₀	5	20	35	5	20	35
Unit Weight (kg/m ³)	1950	2050	2130	1500	1700	1900
Friction Angle (deg)	28	37	42	15	20	25
Cohesion (kPa)	0	0	0	10	55	100
Permeability (m/sec)	10 ⁻³	10 ⁻⁴	10 ⁻⁵	10 ⁻⁶	10 ⁻⁷	10 ⁻⁸
Bulk Modulus (MPa)	10	55	100	10	55	100
Shear Modulus (MPa)	6	25	33	2	11	21

For the initial series of analyses, the earth embankment was assumed to be constructed on rock. This simplified the analysis, required fewer FLAC runs and was compatible with the seismic hazard definition. However, such a simplifying assumption doesn't allow for simulation of phenomena such as foundation soil liquefaction. Subsequent models sand and/or clay layers within the dam foundations were developed.

Ideally, a comprehensive model for soil should account for all the physical effects that occur during static and dynamic loading, such as volume changes, energy dissipation and modulus degradation. In this study, the Mohr Coulomb model was used to model clay and sand failure (see Table 5.2 for appropriate $c - \phi$ values). Additionally, the Byrne model was used to simulate liquefaction in sands. The constitutive model for cyclic stress-strain behavior for sands as suggested by Byrne [2001] is

$$(\Delta\varepsilon_{vol}/\gamma) = C_1 \exp(-C_2 (\varepsilon_{vol}/\gamma)) \tag{6.1}$$

where ε_{vol} and γ are the volumetric strain and shear strain, respectively and C_1 and C_2 are interrelated constants that are related to other soil parameters as

$$C_1 C_2 = 0.4, C_1 = 7600 D_r^{-2.5} \text{ where } D_r \text{ is the relative density and } C_1 = 8.7 (N_1)_{60}^{-1.25} \tag{6.2}$$

The correlation of the dynamic soil parameters with other simple soil parameters like $(N_1)_{60}$ makes the task of definition of type of soil relatively unambiguous. Clay is modeled as a linear elastic model (see Table 5.2) with 5% material damping.

Dynamic excitation is applied to the dam in the form of acceleration time histories. The time histories represent the expected PGA at the site. The acceleration histories are applied in the horizontal direction to the base of the dam foundation, thereby representing horizontally polarized and vertically propagating shear waves.

The settlement of the crest of the dam is selected as the damage index in the present study. The damage index is used to quantify the extent of damage to a dam from seismic activity. Experience from past earthquakes has demonstrated that in many cases, crest settlement is a reasonable parameter to capture various dam and foundation response mechanisms including lateral spreading, soil settlement and slope movements. The quantification of damage using other indices is also possible but is beyond the scope of the present study.

6.2.3 FLAC Response Simulation Program

The FLAC response simulation program simulates the construction of an embankment dam in a step-by-step manner. This approach enables the actual construction and reservoir filling processes to be reasonably modeled and the associated construction induced improvement in material properties to be simulated in a straightforward manner. The simulation steps are:

- Placement of the foundation material.
- Construction of the embankment in a single stage.
- Stabilization of the system by low strain model cycling.
- Application of retained water level and development of phreatic surface by low strain model cycling.

- Definition and application of acceleration time histories.
- Dynamic analysis of the dam.

As previously noted, the FLAC program is an efficient tool for computation of the seismic response of a dam. However, this finite difference program is computationally expensive and thus can be time consuming if large numbers of model are to sequentially analyzed. There are thousands of dams present in the inventory database within the region of interest in the present study and for a traditional analysis methodology, each of these dams should be individually analyzed. Given that any given dam also needs to be analyzed for parametric uncertainty, the resulting number of computer model runs could quickly exceed several million and render the approach unfeasible. This impractical approach is avoided in the present study by employing the basic metamodel technique outlined in Chapter 3 which begins with a Design of Experiments (DOE) procedure.

6.3 Design of Experiments

The design of experiments procedure is aimed at selection of the most influential combination of FLAC prototype variables that should be included in a model and used as input for FLAC program runs that will define the response surface metamodels. In implementing DOE, the entire population of dams is first analyzed and their physical and material parameters are treated as variables. The variables used are selected because they have an important effect on the seismic response of the dam. Only the key variables are considered and other less important variables were taken as constant parameters or functions of the key variables.

The five variables selected for development of dam models, and thereby included in development of the metamodel, are: height of the dam (H_d), ratio of retained water to height of dam (H_w/H_d), the sand quality index (S), the clay quality index (C) and the seismic hazard (PGA). As previously described, these variables are selected based on a series of parametric or

screening analyses and included the dam geometric properties that most significantly influenced the model response while simultaneously allowed for the range of soil types and thus material parameters in both foundation soils and earth dams to be appropriately captured in the response surface methodology.

A three level design that can be used to predict the second order (quadratic) effects is selected for the DOE. The minimum, average and the maximum values of the five model variables are summarized in Table 6.3.

Table 6.3: Five Metamodel Factors for Design of Experiments

Factor	Minimum (-1)	Average (0)	Maximum (+1)
H_d (meters)	4	56	108
H_w/H_d	0.1	0.5	0.9
S	-1	0	+1
C	-1	0	+1
PGA (g)	0.15	0.775	1.4

A five-factor design is selected for implementation of the five parameters that define the model. There are several options for use of a basic three-level five-factor design [Khuri, 1987]. Figure 6.4 shows some of the commonly used three level three factor designs. The red points correspond to the input data sets used for performing the experiment and later creating the metamodel regression equation. Each design has its own assumptions, advantages and disadvantages. As for the building metamodel development, a Central Composite Design is used for designing the five factor three level FLAC numerical experiments.

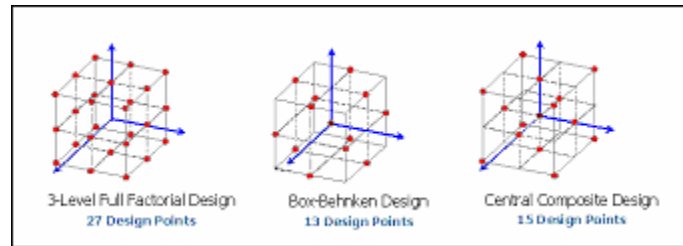

Figure 6.4: Commonly used DOE Techniques

PROJECT DS-5 FINAL REPORT

A five factor Central Composite Design requires 27 experimental runs. These runs are sufficient to explore the effect of each factor on the damage index. Since the time histories are not unique for each PGA level, two different time histories from the software SMSIM are used for each model and the average damage index is calculated from them. This results in 54 FLAC simulations from which the response surface equation can be developed. Table 6.4 summarizes the DOE table of the 27 experimental runs (FLAC models) developed using the SAS JMP program [SAS Institute, 2002]. The table also lists the average crest settlement (ΔH) that the models predicted on the basis of FLAC software simulation.

Table 6.4: Design of Experiments Table

Factor Pattern	H _d (m)	H _w /H _d	S	C	PGA (g)	ΔH (m)	Log (ΔH)	$\Delta H/H_d$ (%)
++---	108	0.9	-1	-1	0.150	8.0000	0.90	7.4
+--+	108	0.1	-1	1	0.150	5.5000	0.74	5.1
---++	4	0.1	-1	1	1.400	0.0700	-1.15	1.8
--++-	4	0.1	1	1	0.150	0.0005	-3.30	0.0
----	4	0.1	-1	-1	0.150	0.0020	-2.70	0.1
++-++	108	0.9	-1	1	1.400	14.5000	1.16	13.4
0A000	56	0.9	0	0	0.775	1.3500	0.13	2.4
--+-+	4	0.1	1	-1	1.400	0.0500	-1.30	1.3
A0000	108	0.5	0	0	0.775	10.0000	1.00	9.3
0a000	56	0.1	0	0	0.775	0.7000	-0.15	1.3
0000A	56	0.5	0	0	1.400	1.8000	0.26	3.2
+--+	108	0.1	1	-1	0.150	5.0000	0.70	4.6
+++--	108	0.9	1	-1	1.400	13.5000	1.13	12.5
+---+	108	0.1	-1	-1	1.400	12.0000	1.08	11.1
-+--+	4	0.9	-1	1	0.150	0.0040	-2.40	0.1
000a0	56	0.5	0	-1	0.775	1.2000	0.08	2.1
a0000	4	0.5	0	0	0.775	0.0300	-1.52	0.8
00a00	56	0.5	-1	0	0.775	1.3000	0.11	2.3
-++--	4	0.9	1	-1	0.150	0.0030	-2.52	0.1
000A0	56	0.5	0	1	0.775	0.9500	-0.02	1.7
++++-	108	0.9	1	1	0.150	7.0000	0.85	6.5
-+--+	4	0.9	-1	-1	1.400	0.2000	-0.70	5.0
+----	108	0.1	1	1	1.400	11.0000	1.04	10.2
00000	56	0.5	0	0	0.775	1.0000	0.00	1.8
0000a	56	0.5	0	0	0.150	0.5000	-0.30	0.9
00A00	56	0.5	1	0	0.775	0.7000	-0.15	1.3
-++++	4	0.9	1	1	1.400	0.0500	-1.30	1.3

6.4 Metamodel Development

Implementation of a metamodel is undertaken to avoid the large number of computational runs which would otherwise be required to predict the response of a large number of dams. It also adds scalability to the analysis methodology [Neter et al, 1996]. There are different metamodeling techniques such as Response Surface Methodology (RSM), and Artificial Neural Networks [Friedman, 1995].

Following the same general reasoning outlined in Chapter 3, this study employs RSM as the metamodeling technique for the seismic response analysis of dams. The resulting response surface regression equation approximates the damage index as polynomial functions of model variables. The coefficients of the equation are calculated by a least square regression on the data obtained from the designed numerical model experiments. The equation is then used to approximate the damage indices of other combinations of model variables. [Khuri *et al*, 1987; Kleijnen et al, 2000].

The quality of a response surface depends on the degree of the approximating polynomial which is usually chosen to be 1 or 2 since low-degree models contain fewer terms than higher-degree models and thus require that fewer experiments be performed. The lower order terms and interaction effects are more important than higher order terms. The predicted response function based on a second-degree polynomial model is:

$$Y = \beta_0 + \beta_1 X_1 + \beta_2 X_2 + \beta_{11} X_1^2 + \beta_{22} X_2^2 + \beta_{12} X_1 X_2 + \dots \quad (6.3)$$

Since geometric properties as well as material and seismic parameters inherently include uncertainty, variability in these inputs can translate into variability in the computed damage index. A Monte Carlo Simulation (MCS) can be used to estimate the probabilistic response of the damage index. The Monte Carlo technique is a brute-force simulation technique, which randomly generates values for uncertain input variables to simulate scenarios of a problem [Kleijnen, 1974].

PROJECT DS-5 FINAL REPORT

Probability distributions (*e.g.* uniform, normal, lognormal)) of each predictor variables are first computed or assumed. Then, during MCS, the random selection of predictors is repeated many times to create multiple scenarios. Each time a value is randomly selected from the probability distribution an outcome is computed using the response surface regression equation. Together, these scenarios give a probability distribution of the damage index. Thus, equation (6.1) can be used for translating the probability distribution of geometric and material parameters to the probability distribution of the damage index by MCS.

The response surface equation is developed for the logarithm of the settlement rather than the settlement value itself. This is because the regression for log of settlement gives a higher linear regression correlation coefficient value of 0.997 and did not predict negative settlement values when compared to the regression on the settlement values. It also gives a constant variance, which is observed in the residuals versus fitted values plot thereby reinforcing the validity of the linear regression model. The settlement values are computed later by raising the predicted log settlement value to power of 10.

The resulting response surface equation as computed using SAS JMP program is as follows:

$$\begin{aligned} \text{Log}(\Delta H) = & -3.37 + 0.0494H_d + 1.02(H_w/H_d) - 0.195S - 0.118C \\ & + 1.67\text{PGA} - 0.00317 H_d*(H_w/H_d) + 0.001570H_d*S + 0.00177(H_w/H_d)*S \\ & + 0.00109H_d*C - 0.00808(H_w/H_d)*C - 0.0303S*C - 0.01007H_d*\text{PGA} \\ & - 0.190(H_w/H_d)*\text{PGA} + 0.000937S*\text{PGA} + 0.00310C*\text{PGA} - 0.000114H_d^2 \\ & - 0.375(H_w/H_d)^2 - 0.0683S^2 - 0.0194C^2 - 0.181\text{PGA}^2 \end{aligned} \tag{6.4}$$

This response surface is then used to predict the settlement for all dams in study region being considered in this Mid America study . The five input factors of the metamodel are used as input. Height is obtained from the NID database and PGA from the enhanced database obtained

from integration of the NID database with the USGS seismic hazard maps. The ratio of height of water to dam is a variable, and while varied throughout the course of the analyses performed in this study, it was set to an average value of 0.5 (half full) for presentation purposes. Since quality of construction is not known, an average value of the sand/clay quality index ($=0$) was also used for methodology presentation purposes.

A parametric analysis was also conducted by performing a Monte Carlo Simulation on the response surface equation for the William Shaddan Dam for which $H = 12.9\text{m}$, $\text{PGA}=1.4\text{g}$. Using uncertain values for $H_w/H_d \sim N(0.5, 0.12)$, $S \sim N(0, 0.22)$ and $C \sim N(0, 0.22)$, the uncertain settlement values as predicted by Monte Carlo simulations are:

- Average of settlement = 0.2 m
- Standard deviation of settlement = 0.025 m
- Coefficient of variation = 12.5 %

The response surface equation serves a distinct advantage here. The Monte Carlo simulation is performed on the response surface equation; the random numbers generated for H_w/H_d , S and C during the Monte Carlo simulation compute the corresponding damage index from the response surface equation rather than requiring a FLAC model run for the random inputs.

6.5 Integration in Spatial Framework

After the response surface regression equation is formulated for the damage index, the entire analysis can be integrated in a spatial framework. Equation (6.3) is simply a polynomial equation of a number of key variables, X_i , each one of which should be present in the inventory database. GIS programs such as ArcGIS can then be used to compute and visualize the damage index for a selection of dams in the region of interest. Also, an interactive user interface can be created so that the user can enter in different values of dam variables (predictors) and then

compute different damage indices. This can be used for analysis of different scenarios and possible retrofitting strategies.

All of the original NID data, USGS data, predictor variables and response variables are integrated in one single database, which is used for final GIS presentation. Figure 6.5 shows the predicted settlement values (ΔH) for the dams present in Mid America. Similarly, the relative settlement values ($\Delta H/H_d$) can also be viewed as shown in Figure 6.6. The user can also view the settlement of a single dam by identifying and clicking on it or by querying it by location (*e.g.* proximity to a city) or by attribute (*e.g.* name or owner). The William Shaddan Dam located near the NMSZ is selected as an example for such a spatial query. The integrated database shows all of the relevant values including the settlement of the dam (0.2 m for a height of 43 ft = 12.9 m) for the average soil index conditions of $S = 0$, $C = 0$ and $H_w/H_d = 0.5$.

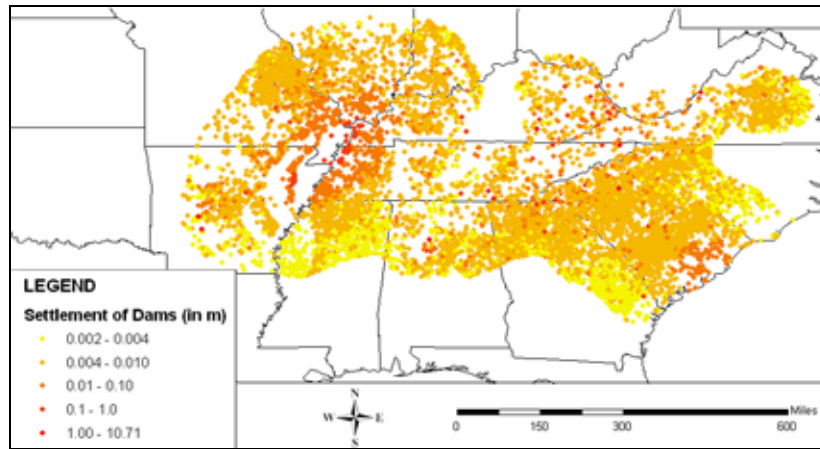

Figure 6.5: Display of Estimated Settlement of the Crest of the Dam

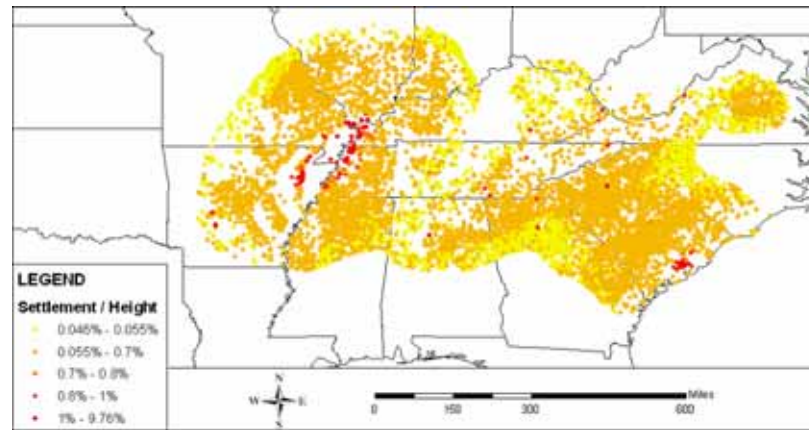

Figure 6.6: Display of Estimated Settlement-to-Height ratio

The results from seismic analysis of dams can be visualized using GIS software as shown in Figure 6.5 and Figure 6.6 above. However, it is difficult for the user to query and choose the region of interest and to re-run the analysis for different scenarios without an understanding of SQL query, regression equations and database tables. An extension to GIS software was developed to circumvent these problems. This extension is essentially a VBA form and is accessed through a User Interface button. Clicking the button results in the form being displayed as shown in Figure 6.7. The user can then query the dam database by a region of interest, owner type or dam attributes. In addition, the user can also choose new factors for the metamodel regression equation. For example if the user chooses default properties, then the default settlement will be recomputed. When the user clicks the ‘Calculate Settlements’ button, the database is queried as per user conditions and new settlements values are computed in a new column. The new layer is then automatically added as shown in Figure. 6.8. A new column USER_SETT containing new settlement values is added to the table, which has only the queried records. These new settlement values can then be used as an attribute to display the layer. The user can either save the new layer or discard it. The user can then re-run the analysis any number of times. Each time, the user is free to select different regions of interest and different values of predictor variables to analyze various scenarios of interest.

PROJECT DS-5 FINAL REPORT

The screenshot shows a software window titled "Dam Query" with a close button in the top right corner. The window is divided into several sections:

- Dam Query**: This section contains input fields for geographic coordinates and administrative boundaries:
 - Latitude** (Decimal deg): South (31.69722) and North (40.0016)
 - Longitude** (Decimal deg): West (-93.58694) and East (-77.03333)
 - State**: A dropdown menu set to "Any State"
 - County**: A dropdown menu set to "Any County"
 - Owner Type**: A dropdown menu set to "Any Owner"
 - Dam Height** (ft): Minimum (1.2192) and Maximum (109.7)
 - Dam Storage** (acre-ft): Minimum (0.33) and Maximum (3760700)
- Factors for Settlement of Dam Computation**: This section contains parameters for settlement analysis:
 - Height of the Dam (in meters)**: A text box containing "from database"
 - Water Retention Level (between 0 and 1)** (Default value = 0.5): A text box containing "0.5"
 - Sand Quality Index** (Default value = 0) (between -1 (unengineered) and +1 (engineered)): A text box containing "0"
 - Clay Quality Index** (Default value = 0) (between -1 (unengineered) and +1 (engineered)): A text box containing "0"
 - Peak Ground Acceleration** (as a fraction of 'g'):
 - Radio button selected: USGS 2% probability of exceedence in 50 years
 - Radio button unselected: A text box containing "0.5"
- Buttons**: At the bottom, there are two buttons: "Calculate Settlements" and "Close".

Figure 6.7: GIS interface for querying and re-running analysis

PROJECT DS-5 FINAL REPORT

Attributes of Sample XY Event layer										
PGA_Level	HT_METERS	WATER_LEV	SAND_QUAL	CLAY_QUAL	LOG_OF_SET	SETT	STRAIN	USER SETT	Shape*	
0.11	3.9624	0.5	0	0	-2.801	0.002906	0.000632	0.009030	Point	
0.11	3.6576	0.5	0	0	-2.615	0.002427	0.000663	0.008768	Point	
0.15	3.048	0.5	0	0	-2.583	0.002612	0.000857	0.008265	Point	
0.15	7.62	0.5	0	0	-2.377	0.004198	0.000557	0.012808	Point	
0.15	11.58	0.5	0	0	-2.202	0.006281	0.000542	0.018553	Point	
0.11	7.62	0.5	0	0	-2.435	0.003673	0.000402	0.012808	Point	
0.13	8.5344	0.5	0	0	-2.365	0.004315	0.000406	0.013962	Point	
0.13	10.67	0.5	0	0	-2.27	0.005370	0.000403	0.017051	Point	
0.11	7.62	0.5	0	0	-2.435	0.003673	0.000482	0.012808	Point	
0.13	7.62	0.5	0	0	-2.406	0.003926	0.000415	0.012808	Point	
0.13	15.85	0.5	0	0	-2.045	0.009016	0.000369	0.027411	Point	
0.13	5.7912	0.5	0	0	-2.488	0.003251	0.000361	0.010764	Point	
0.13	9.144	0.5	0	0	-2.338	0.004592	0.000302	0.014786	Point	
0.11	11.58	0.5	0	0	-2.298	0.005521	0.000277	0.018553	Point	
0.11	4.572	0.5	0	0	-2.573	0.002673	0.000465	0.009576	Point	
0.11	8.2296	0.5	0	0	-2.408	0.003908	0.000445	0.013567	Point	
0.13	7.62	0.5	0	0	-2.406	0.003926	0.000446	0.012808	Point	
0.11	7.0104	0.5	0	0	-2.462	0.003451	0.000443	0.012809	Point	
0.11	7.62	0.5	0	0	-2.435	0.003673	0.000482	0.012808	Point	
0.11	8.5344	0.5	0	0	-2.394	0.004036	0.000473	0.013962	Point	

Figure 6.8: New settlements computed and stored in a new column

CHAPTER 7 FRAGILITIES FOR LEVEES

Levees are a “specialized” type of embankment dam typically built alongside the banks of a river to serve as a barrier or elevation separator between floodwater and adjacent industrial and other activities. Unlike earth dams, levees are typically subjected to high-retained water levels for only short periods of time. The design of levees is primarily governed by flood protection criteria. Levees can also be present in a seismically active region, which makes them vulnerable to damage due to earthquakes, especially during flood stage. A multi-hazard analysis of such structures is warranted because of the disastrous consequences resulting from their failure. As an extension of the original scope of the project, the authors elected to demonstrate how the Response Surface methodology could be adopted and used to provide an integrated, scalable framework for computation and presentation of the seismic response of levees present in a flood and earthquake vulnerable region. It is noted from the outset that the focus on this portion of the study was limited to demonstrating the general flexibility of the approach to this problem and not the direct application to a Mid-America locale since no levee – riverfront retaining structure inventory was collected and or available as part of this project. In addition, in conducting the levee analysis portion of the study, the authors elected to utilize two different computational tools (QUAKE/W and SLOPE/W) to perform the dynamic analysis of the prototype levees. This was done to demonstrate the relative flexibility of the approach to using other computational tools as appropriate and/or desired.

7.1 Methodology

This phase of the study focused on examining how the geostructure methodology described in the previous section of this report could be utilized to compute the multi-hazard response of a levee system. As with the regional dam response studies, the task of conducting regional levee response studies can not be adequately accomplished if numerical models

PROJECT DS-5 FINAL REPORT

corresponding to different physical cross-section and material parameters are randomly chosen and analyzed. Such an unsystematic approach would require thousands of computational runs using models of different levee systems. Since the levees can experience various possible hazards, the task of modeling all possible conditions of different levees together with all possible conditions of hazards becomes an untractable task also.

The metamodeling based methodology as presented herein makes the regional analysis of a system of levees possible. As previously described in the previous section of this report, the methodology relies on a Design of Experiments approach, wherein only a few representative levee models are systematically selected and analyzed and the results are used for damage prediction of all possible levee and hazard conditions using regression equations. Figure 7.1 shows a similar flowchart as presented earlier that outlines the step-by-step procedure adopted for computation of the response simulation for levees. The principal difference in this flowchart is the replacement of FLAC as the computational tool with the QUAKE/W and SLOPE/W tools. Additional details of these computational packages are summarized later in this section of the report. As before, the metamodel regression equation is also used for Monte Carlo Simulation, the results of which can be later utilized to view the probabilistic response in a GIS framework.

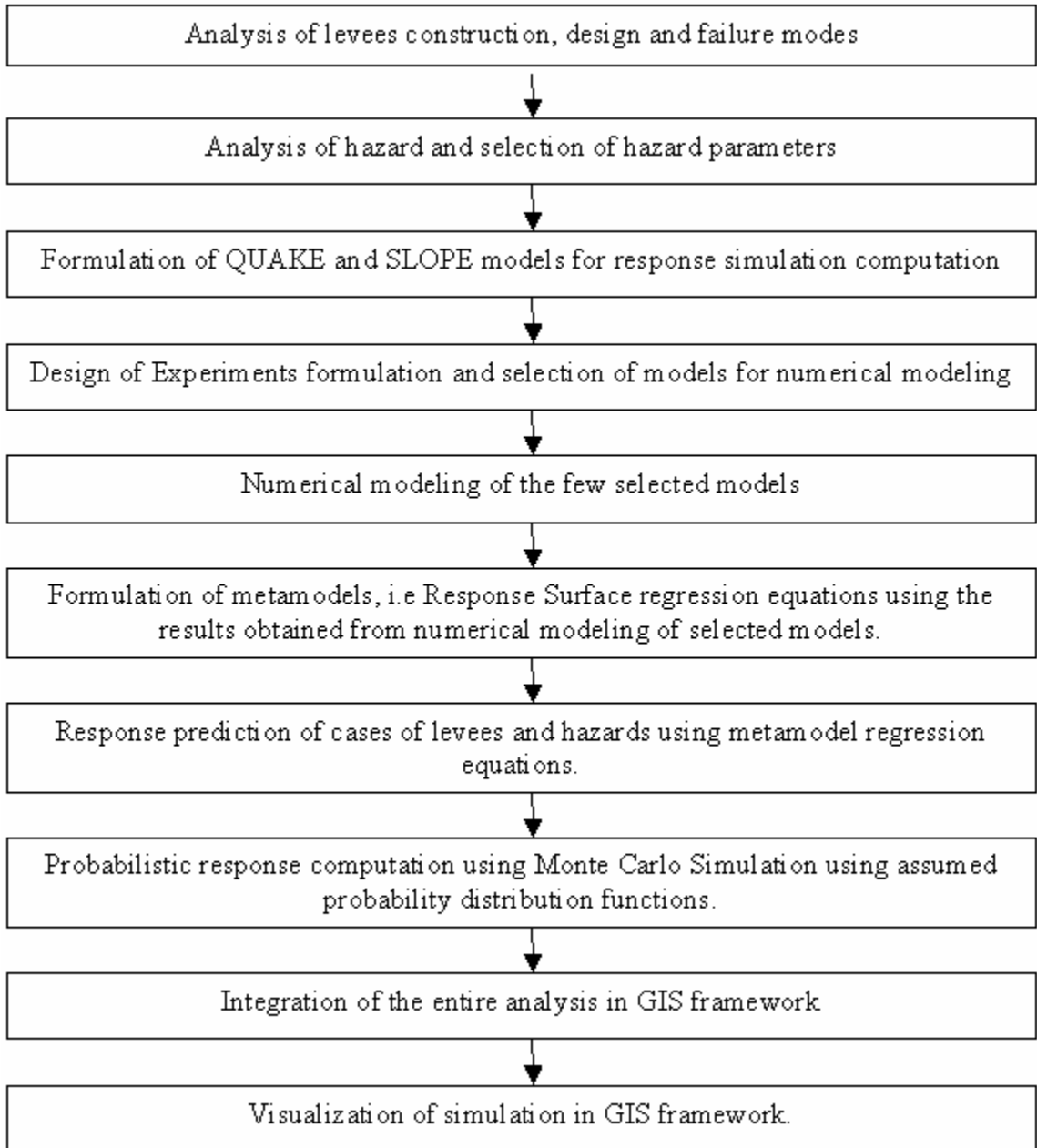

Figure 7.1: Methodology for Multi-Hazard Response Simulation for Levees

7.2 Design and Construction of Levees

The U.S. Army Corps of Engineers is responsible for design and construction of most of the levees in the United States. USACE (2000) describes the general guidelines for design and construction of levees. A typical levee design process involves field investigations, laboratory

testing, design of levee slopes and design of a seepage control system. A typical levee design is shown in Figure 7.2. IN the absence of specific inventory information for levees in the Mid-America region, this study used the cross-section illustrated in Figure 7.2 as a representative design for levees. USACE (2000) does not provide the exact material specifications but some approximate values are provided.

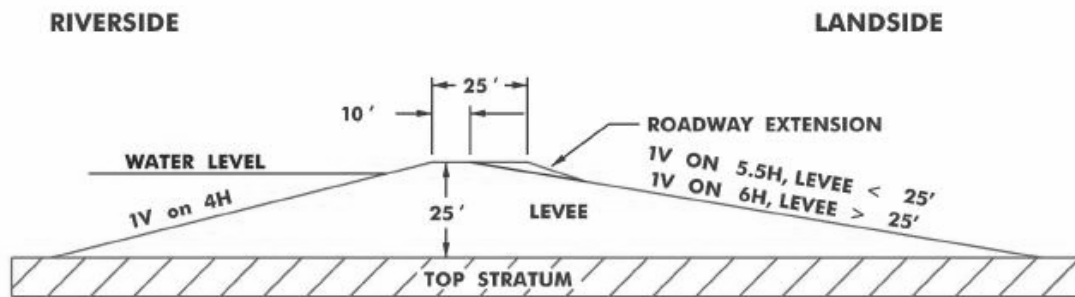

Figure 7.2: Levee Design (USACE, 2000)

7.3 Hazard Definition

7.3.1 Earthquake Hazard

This phase of the study utilized the scenario earthquake ground motions developed by Rix and Leon (2004). The ground motions were simulated for the city of Memphis, TN, for several source models, earthquake magnitudes and hypocentral distances. The simulations were actually based on the stochastic ground motion model implemented by Boore (2003) in a program called SMSIM. The influence of the deep soil column of the Upper Mississippi Embayment was also considered through site amplification factors developed by Drosos (2003). This implementation of nonlinear site response specifically for the city of Memphis is a key difference with respect to previous studies such as Wen and Wu (2001).

7.3.2 Flood Hazard

The basic function of levees is flood protection and the reliability based design of levees requires the computation of flood hazard [USACE, 1996]. For example, in the 1993 Mississippi river flood, the water level was higher than the flood level for 144 days between April 1 and September 30. In this study, the flood hazard was represented in a more simple manner by varying the elevation of the water with respect to the levee. The height of water was a measure of flood/drought level. Different water levels were used to understand the effect of flood.

7.4 Numerical Modeling of Levees

7.4.1 QUAKE/W and SLOPE/W Models

This phase of the study utilized Geo-Slope's QUAKE/W and SLOPE/W software for flood and seismic response simulation of levees. The levee geometric model is assembled in QUAKE/W and SLOPE/W as shown in Figure 7.3. QUAKE/W is a geotechnical finite element software product for the dynamic analysis of earth structures subjected to earthquake shaking [Geo-Slope, 2004a]. QUAKE/W can be used to compute stresses and excess pore-water pressures due to earthquake loading. The stresses computed by QUAKE/W can then be imported into SLOPE/W and the factor of safety of the slopes can be computed [Geo-Slope, 2004b].

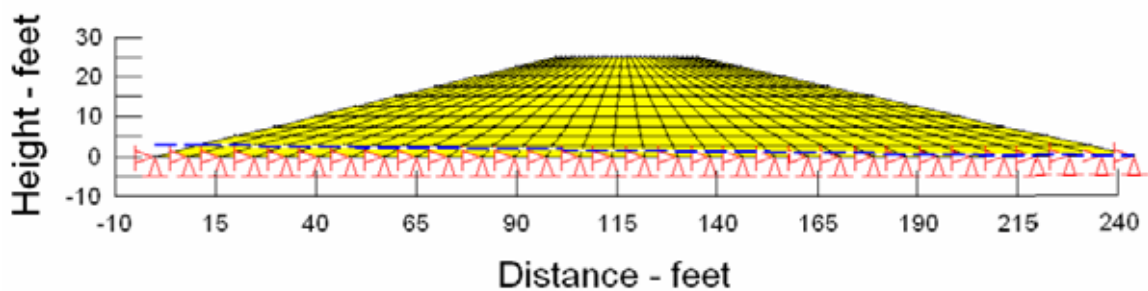

Figure 7.3: QUAKE/W levee model

As with the program FLAC described in the previous section, a QUAKE/W - SLOPE/W model run requires a minimum set of input parameters for complete definition of the levee model and for calculation of its response. These input parameters include:

- Physical design parameters (*e.g.* levee height, slopes)
- Levee material parameters (*e.g.* elastic moduli, soil strength, hydraulic conductivity)
- Material constitutive behavior (stress-strain behavior, modulus degradation of soil)
- Seismic hazard (acceleration time histories of expected ground motions)
- Flood hazard (water level on the riverside slope)

7.4.2 Model Specification

The following parameters were used for the levee models developed for analysis with the QUAKE/W and SLOPE/W software:

- **Physical design parameters:** The height of the levee (H) and the height of retained water (h) were identified as important physical variables and were used directly as key model variables. Crest width was taken as a constant (35 ft.) for all models and was based on common construction practice. The riverside slope (RS) and landside slope (LS) of the levee were also variables used in defining a levee model.
- **Levee material parameters:** As shown in Table 7.1, the QUAKE/W and SLOPE/W model computer analyses require a range of soil parameters. These soil parameters, such as unit weight, elastic moduli, and cohesion, are not completely independent of each other. Also, each additional predictor variable results in several model runs. Hence, the levee models were analyzed for a consistent set of material parameters. Three sets of soil parameters were selected for these analyses. These parameters represent poor (-1), average (0) and good (+1) types of soil and are intended to also be reflective of the degree to which the structures were poorly or well engineered. Table 7.1 lists the various soil parameters for each type of soil. These values are within the range prescribed by USACE [2000] and Coad [2004].

Table 7.1: Material Parameters for Computational Analysis

Parameter	Soil Type		
	-1	0	1
Damping Ratio %	0.04	0.04	0.04
Poisson Ratio	0.4	0.4	0.4
G Modulus (psf)	50	275	500
Soil Plasticity Index	10	30	50
Unit Weight (pcf)	100	115	130
Cohesion (psf)	50	275	500
Friction Angle (degree)	10	20	30

- Material constitutive behavior:** The equivalent linear model was used to model the soil behavior. The modulus degradation and damping ratio curves used to model soil are shown in Figure 7.4. The curves correspond to the modulus degradation and damping ratio functions presented by Ishibashi and Zhang (1993). These functions are dependent on soil plasticity index, which is provided in Table 7.1.

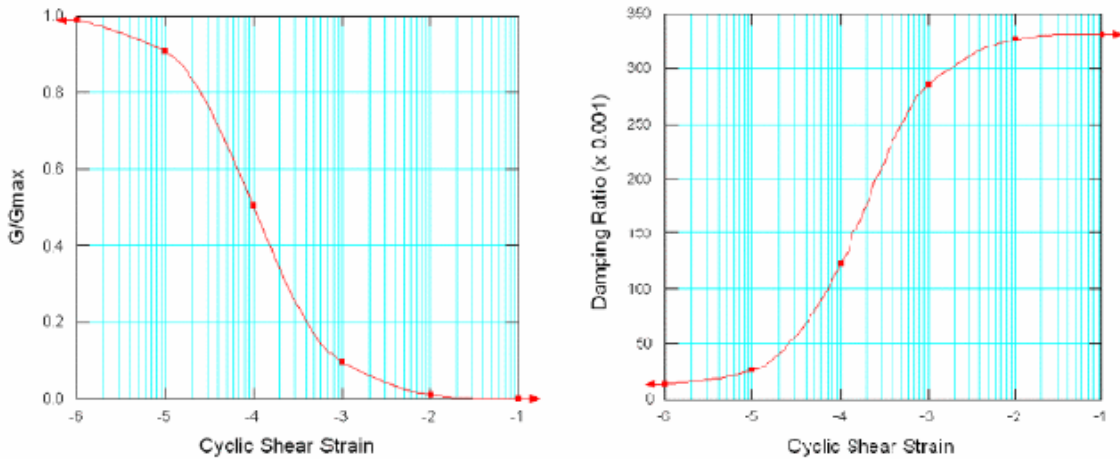

Figure 7.4: Modulus degradation and damping ratio curves (Geo-Slope, 2004a)

- Seismic hazard:** The dynamic excitation is applied to the levee in the form of acceleration time histories from Rix and Leon [2004]. The acceleration histories are applied in the horizontal direction to the base of the levee foundation, thereby representing horizontally polarized and vertically propagating shear waves.

- **Flood hazard:** The height of retained water is representative of flood hazard. The hazard was characterized by the ratio of height of water to height of levee ($0 < h/H < 1$). The effect of height of retained water was studied by taking different values for this ratio.

This study utilized both factor of safety of the landside (LS FoS) and the factor of safety of the riverside slope (RS FoS) as the damage indices. Note that in the previous section on regional dam response analysis, settlement of crest height was utilized. The QUAKE/W and SLOPE/W software cannot model failure modes such as overtopping or piping but levee slope failure, the predominant observed mode of failure, can be readily modeled and evaluated. Other levee details like toe drains, relief wells, *etc.*, were not modeled in the present study in the interest of simplicity however there is no limitation on doing so with the various computational programs.

7.4.3 Response Simulation Program

The final response simulation was obtained using a combination of QUAKE/W and SLOPE/W models. The following process is simulated in a step-by-step manner:

- Development of initial in-situ model of levee in QUAKE/W.
- Application of earthquake time histories in QUAKE/W model.
- Computation of landside and riverside slope factor of safety in separate SLOPE/W files which uses the stresses and porewater pressures generated by QUAKE/W. Note that QUAKE/W and SLOPE/W are developed by the same company and thus exchange of data between the two software packages is readily accomplished.

7.4.4 Model Selection

As with the FLAC program discussed in the previous section, the QUAKE/W and SLOPE/W programs are efficient tools for computation of levee response. However, these programs are computationally time consuming. This can again be avoided by adopting the metamodeling technique, which is achieved through a Design of Experiments (DOE) procedure

as previously described. The DOE is aimed at selection of a small number of combinations of predictor variables that should be analyzed and used as input for QUAKE/W and SLOPE/W models.

7.5 Design of Experiments

This study utilized Design of Experiments to create response surface metamodels of the QUAKE/W and SLOPE/W models. In implementing DOE, the levee properties were first analyzed and their physical and material parameters were treated as random variables. Seven variables were chosen (and are listed below and in Table 7.2) which may affect the factor of safety of the levee slopes are treated as predictor variables. The seven selected variables for the modeling and metamodeling were height of the levee (H), the soil quality index (S), landside slope (LS), riverside slope (RS), ratio of retained water to height of levee (h/H), magnitude (M) and distance (R) of the earthquake. The seismic and flood hazard variables determined from seismic hazard analysis and simplified flood hazard representation are also treated as predictor variables.

These seven key factors define both a computational model run as well as a metamodel experiment. A three level design that can also predict the second order (quadratic) effects was selected for DOE. The minimum, average and the maximum values of the seven factors are summarized in Table 7.2.

Table 7.2: Three Level Design for Seven Factor DOE

Factor	Minimum	Average	Maximum
H (ft)	23	25	27
S	-1	0	+1
LS	1V: 4H	1V: 6H	1V: 12H
RS	1V: 3H	1V: 4H	1V: 8H
h/H	0.1	0.5	0.9
M	-1	0	+1
R (km)	20	60	100

A seven-factor design was selected for the seven parameters that define the model.

Several options for a three-level seven-factor design exist, for example Central Composite Design, Box-Behnken, Full Factorial Design, *etc.* [Neter et. al., 1996]. Each design has its own assumptions, merits and demerits. A seven-factor Box-Behnken was selected for designing the experiments. This DOE resulted in 62 model runs. Once the DOE table is obtained using the JMP program (SAS Institute, 2002), the QUAKE/W and SLOPE/W model runs were performed corresponding to the each set of input variables. The resultant landside and riverside factor of safety were computed and used to develop response surface regression equations.

7.6 Metamodels

The response surface regression equation can be used to approximate the factor of safety as polynomial functions of the predictor variables. The coefficients of the equation are computed by a least squares regression on the data obtained from the designed QUAKE/W and SLOPE/W experiments. The response surface equation was developed for landside (LS Fos) and riverside slope (RS Fos) factor of safety. The JMP program [SAS Institute, 2002] computed the following response surface regression equations (7.1) and (7.2) which can be used directly to compute the factor of safety of any model.

$$\text{Log RS FoS} = 5.14 - 0.156 H - 0.03 (h/H) - 0.77 RS + 0.33 LS - 0.045 S - 0.632 M - 0.0038 R + 0.00347 H^2 + 0.063 (h/H)^2 - 2.99 RS^2 - 3.01 LS^2 - 0.0893 S^2 + 0.0498 M^2 + 0.000002$$

PROJECT DS-5 FINAL REPORT

$$\begin{aligned}
 &R^2 - 0.0042 H*(h/H) - 0.006 H*RS - 0.000 H*LS + 0.0080 H*S - 0.0051 H*M + 0.000035 H*R + \\
 &0.31 (h/H)*RS + 0.004 (h/H)*LS + 0.0231 (h/H)*S - 0.0003 (h/H)*M - 0.00005 (h/H)*R + 2.76 \\
 &RS*LS + 0.660 RS*S + 0.041 RS*M + 0.0084 RS*R - 0.019 LS*S + 0.084 LS*M + 0.00178 \\
 &LS*R - 0.0078 S*M + 0.000242 S*R + 0.000207 M*R \tag{7.1}
 \end{aligned}$$

$$\begin{aligned}
 &\text{Log LS FoS} = 19.8 - 1.40 H + 0.02 (h/H) - 7.47 RS - 2.40 LS - 0.301 S - 0.092 M - \\
 &0.0086 R + 0.0283 H^2 - 0.091 (h/H)^2 + 12.3 RS^2 + 5.88 LS^2 + 0.0711 S^2 + 0.0030 M^2 + 0.000026 \\
 &R^2 + 0.0081 H*(h/H) + 0.004 H*RS - 0.057 H*LS + 0.0123 H*S - 0.0041 H*M + 0.000030 H*R \\
 &+ 1.67 (h/H)*RS - 2.58 (h/H)*LS - 0.0524 (h/H)*S + 0.0126 (h/H)*M - 0.00014 (h/H)*R + 6.56 \\
 &RS*LS + 0.595 RS*S + 0.133 RS*M + 0.0055 RS*R - 0.046 LS*S + 0.029 LS*M + 0.0107 \\
 &LS*R + 0.0220 S*M + 0.000048 S*R + 0.000322 M*R \tag{7.2}
 \end{aligned}$$

7.7 Reliability Based Analysis

“For geotechnical and structural analysis, the principle source of uncertainty is the structural performance of an existing levee. Uncertainty in structural performance occurs due to a levee’s physical characteristics and construction quality” [USACE, 1996]. Wen et. al. [2003] discussed the role of epistemic and aleatory uncertainty in earthquake engineering. The parameter uncertainty can be quantified by performing a Monte Carlo Simulation (MCS) on equations (7.1) and (7.2). For example, consider a levee with the following parameters and probability distribution functions:

$$H \sim U(24\text{ft}, 26\text{ft}),$$

$$S \sim U(-0.8, -0.4),$$

$$LS \sim U(1:8, 1:5),$$

$$RS \sim U(1:9, 1:6),$$

$$h/H \sim U(0.6, 0.9),$$

$$M \sim U(7.3, 7.5),$$

$$R \sim U(25 \text{ km}, 35 \text{ km}),$$

where $X \sim U(a, b)$ means that random variable X has a probability distribution function with lower and upper bounds of ‘a’ and ‘b’. In this case, the average (expected) value and standard deviation of landside and riverside factors of safety can be computed from a MCS on equations (7.1) and (7.2). Figure 7.5 shows the probability distribution of RS FoS and LS FoS computed using the Crystal Ball software [Crystal Ball, 2006] (an Excel add-in program).

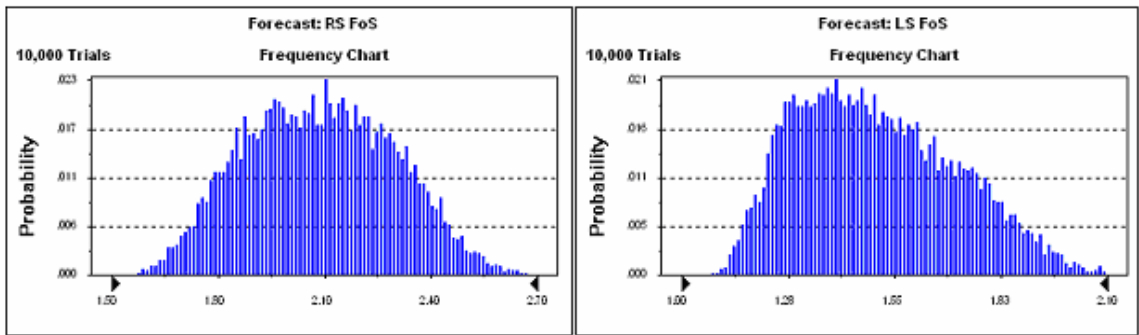

Figure 7.5: Probability Distribution Functions of RS FoS and LS FoS using MCS

From the MCS, RS FoS Average = 2.08, RS FoS Standard Deviation = 0.21, LS FoS Average = 1.48, LS FoS Standard Deviation = 0.21.

7.8 Integration in Spatial Framework

The spatial location of levees in the Mid America region was obtained from Coad (2004). Exact attribute data for levees is not collected and managed by agency and was unavailable. Hence, the typical levee section shown in Section 7.2 represented all of the levees, *i.e.* the attribute component of the levees database is initialized with the “average” data shown in Table 7.2. The user interface can be used to enter and modify the predictor variables. The damage

indices (LS FoS and RS FoS) can be computed from the user interface itself. These values can be stored in the database and levees can be analyzed for different hazard scenarios. Figure 7.6 illustrates the interface for computation of damage indices for levees near Memphis, TN.

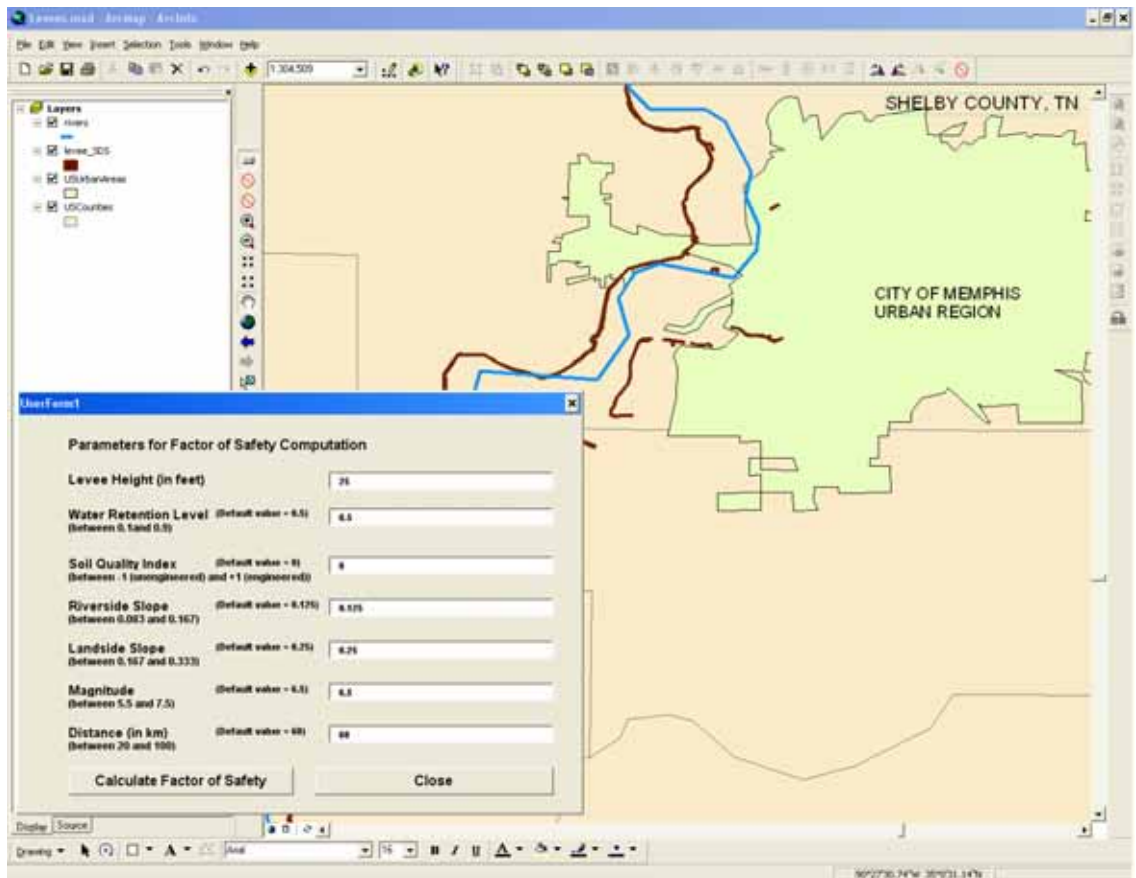

Figure 7.6: Integration in Spatial Framework

The preceding discussion and analyses have demonstrated the flexibility of the Response Surface methodology for conducting regional assessment of seismic hazard of levees and have outlined how the methodology initially developed for embankment dams can be easily extended to levees and also to multi-hazard analyses such as combined earthquake – flood scenarios of these structures. The lack of a specific database of levee and riverfront structures for areas within the Mid-America region resulted in the direct assessment of the methodology not being possible.

PROJECT DS-5 FINAL REPORT

Equally well, the combined examples contained in this report demonstrate the modularity of the method and the ability to integrate additional computational models and tools with ease.

CHAPTER 8

SUMMARY AND CONCLUSIONS

8.1 Summary

Structure performance under future earthquakes is largely unknown and cannot be predicted with certainty. This is primarily due to the fact that an earthquake is a random phenomenon in nature such that no two earthquakes are alike. Another source of uncertainty comes from the structure itself, as the construction material properties can exhibit deviation from their designed or expected values. Performance assessment based only on deterministic response analyses may be misleading and probabilistic assessment is often more appropriate. Structure seismic fragility is utilized as a probabilistic measure of the damage likelihood in a building subjected to future seismic events with specified intensity.

The conventional approaches develop structure fragilities through simulation of seismic responses. However, simulation normally requires a large number of samples in order to obtain consistent outcomes. Thousands or ten of thousands of samples may be needed in this regard. It quickly becomes impractical when each sample in the simulation is a nonlinear dynamic analysis of a complex structural model. This report proposes an alternative approach for deriving a simulation-based fragility by using a statistical technique called a response surface metamodel.

8.2 Conclusions

This report presents the use of the response surface metamodel in conjunction with Monte Carlo simulation techniques as a tool to derive structure seismic fragility. A response surface function is sought to approximate an implicit structure seismic response computation using an explicit polynomial function. The response surface methodology applies Design of Experiments (DOE) techniques to identify an efficient set of computer analyses and then use

regression analysis to create a polynomial approximation of the analysis results over a specified design space.

Three proposed approaches using response surface metamodels for calculating structure fragilities are presented in this research. Approach 1, which is least effective, generates metamodels for buildings subjected to each individual ground motion record in a suite of earthquakes. Seismic uncertainty is included when the earthquake-specific metamodels are randomly selected in the simulation process. Approach 2 adopts the dual response surface concept to generate separate metamodels for the mean and standard deviation of the responses calculated from a suite of ground motions. The final response surface is composed of mean and standard deviation parts and, hence, incorporates seismic uncertainty in the model itself. Approach 3 avoids the shortcoming of having to repeat the process for different earthquake intensity levels by including a parameter defining intensity level in the response surface models. All three approaches yield comparable probability distributions of the response in the case of a simple single-degree-of-freedom system and their outcomes are essentially as good as those obtained from conventional use of Monte Carlo simulation on the complex model.

Five applications of the proposed approaches are presented. The first application is to compute seismic fragilities of a specific building that represents a typical unreinforced masonry firehouse in Mid-America. A firehouse was chosen because they are considered to be essential facilities that must be operational during and after an earthquake for emergency response purposes. Fragility assessment of the firehouse utilizes Approach 3. Simulations of the response surface models with random material properties as well as seismic uncertainties result in the probabilistic description of the responses. This probabilistic response agrees well with the results from a conventional use of the Latin Hypercube Sampling technique ensuring the validity of the proposed approach. The fragility curves of the particular building are obtained from the values of conditional exceedance probabilities for various seismic intensity levels. It is found that there is a

high chance that the particular study building, if assumed to be located in Memphis, would satisfy the performance objectives for moderate level earthquakes, but the chance of not fulfilling the objectives increases significantly when strong earthquakes are considered.

In order to investigate the use of these methods for computing fragilities for modified buildings, rehabilitation schemes are proposed for this firehouse in order to improve its performance under earthquakes. Metallic energy dissipation devices are incorporated in the building in order to consume a portion of the input energy from earthquakes and hence reduce the energy dissipation demand in the main structural elements. Two designs of the devices are considered and both of them utilize the flexibility of the floor and roof diaphragms to maximize the energy dissipation in the devices. The response surface approach is applied in calculating fragilities of the rehabilitated buildings and the resulting fragility curves reveal that the rehabilitated buildings are much more likely than the original building to meet the more stringent “immediate occupancy” performance objectives defined for essential facilities.

The second application of the response surface approach is to rapidly approximate fragilities for a target building portfolio. Seismic loss estimation for a portfolio of buildings generally requires fragility relations for individual buildings in the portfolio in order to assess probable damage due to seismic hazards. While building-specific fragility curves can be determined from brute-force simulations based on complex structural analyses for each building, for portfolio assessment it becomes impractical to produce the needed large number of seismic response analyses. Instead, a response surface metamodel is used to predict the seismic structural response of a specific building characterized by carefully selected macro-level building parameters (*e.g.*, variability in building geometry, age, etc) and micro-level parameters (*e.g.*, material properties) in a simple functional form. The probability densities of the response and the fragility curves specific to a particular building are then generated through Monte Carlo simulation.

PROJECT DS-5 FINAL REPORT

A hypothetical portfolio of four buildings is selected as an example. Each of the buildings in the portfolio is unique in terms of its geometric configuration and age. Response prediction models are generated specific to individual buildings. Simulations using random material properties and earthquakes yield a set of fragility curves for each building in the portfolio. The resulting fragility curves are similar to but yet distinctly different from the single generic curve for buildings of similar type. This concept of building-specific fragilities is believed to lead to a more accurate estimate of losses in comparison to the conventional use of generic curves for all buildings of the same classification.

The third application described in Chapter 5 has presented a response surface metamodel methodology for rapid development of seismic vulnerability functions for populations of LSMF structures across a vulnerable region using 3D models. The metamodel estimates a single limit state (peak interstory drift) and are based on 5 pareto-optimal parameters. The sample structures consisted of eight hypothetical LSMF structures defined on the basis of an expert opinion survey and designed to the appropriate code specifications. The metamodel is then used with Monte Carlo simulation to construct vulnerability functions for a target class of buildings and for specific individual buildings. From the vulnerability functions for LSMF structures, it is found that structural parameters related to geometric configuration such as eccentricity and bottom floor height have more influence on fragilities for LSMF structure than earthquake loading direction. The building design code used also has a significant effect on the seismic fragility curve.

This fourth application described in Chapter 6 has presented an integrated scalable method for seismic response simulation of earth and rockfill dams. The methodology is also applied for response prediction of earth dams in Mid America for a 2% P.E. in 50 years earthquake. Dam inventory is obtained from the National Inventory of Dams, which is then analyzed for frequent typologies. The hazard for the dams is defined using USGS probabilistic hazard maps.

PROJECT DS-5 FINAL REPORT

The seismic response of dams is simulated using FLAC. A Design of Experiments based technique is adopted to reduce the number of simulation runs required to model all the dams. Various model parameters that influence the seismic response of the dam are used as model and metamodel parameters. The Response Surface Methodology is used for metamodeling the models wherein the damage indices are approximated as a function of the model parameters. Uncertainty in seismic response due to parameter uncertainty is evaluated by performing a Monte Carlo Simulation on the response surface equation. The entire analysis is integrated in a spatial framework where the probabilistic response of all dams in the region was observed. Here, the user can select the hazard level and the inventory of interest and can perform a damage simulation.

The last application has presented the methodology for multi-hazard response simulation of levees present in a flood and earthquake vulnerable region as described in Chapter 7. The design and construction guidelines by USACE are first studied to understand the design considerations. The response of levees was simulated using QUAKE/W and SLOPE/W. A Design of Experiments based technique is adopted to reduce the number of simulation runs required to model the levee for various cases. Seven key model parameters that influence the response of the levee are used as predictor variables for the metamodel. The Response Surface Methodology is used for metamodeling the models wherein the landside and riverside Factor of Safety are approximated as polynomial functions (equations (7.2) and (7.3)) of the model parameters. The uncertainty in seismic response due to parameter uncertainty is understood by performing a Monte Carlo Simulation on the response surface equation. The entire analysis was integrated in a spatial framework where the response of the levees can be viewed from a friendly interface.

In summary, the research presents an effective use of the response surface metamodels in prediction of the response and, consequently, the damage due to earthquakes. The closed-form nature of these metamodels makes it practical to employ Monte Carlo methods to carry out

PROJECT DS-5 FINAL REPORT

probabilistic response computations. Values of the seismic fragility are then obtained directly from the simulation outcomes.

APPENDIX

DETAILED PROCEDURE FOR RAPID FRAGILITY ESTIMATION TECHNOLOGY IMPLEMENTATION INTO MAEviz

In order to help MAEviz implementation, two detailed algorithms of the proposed methodology for rapid fragility estimation are shown in Figures A.1 and A.2, respectively. Specifically, Figure A.1 displays the algorithm to develop response surface metamodels (RSM's) for a specific structure, while Figure A.2 shows the algorithm describing how to generate fragility curves from an existing metamodel description.

Metamodel Generation

Metamodels must be developed for each structural class that is to be included in the fragility assessment for a collection of structures. This report describes the development of metamodels for several specific classes of structures, but other classes must be developed for full implementation of the fragility assessment process for a collection. The first step shown in Figure A.1 is intended to determine what a type of target structure is used in the determination of the RSM. Closely associated with this step is the question of whether it will be possible to base the RSM on a sample of existing structural designs or whether it will be necessary to actually design structures to meet the required sampling conditions. Both approaches are illustrated in this report.

The next step is to define the input and output parameters for the target structure. The input parameters for a target structural or geosstructural class are identified based on experience and engineering judgment and may consist of macro-(*e.g.* geometric and structural) and micro-(*e.g.* material) parameters. The range of each input parameter applicable to the collection (region) of interest should be defined based on available inventory data. The outputs are based on defined damage states but can also be based on damage indices or peak structural or geosstructural responses.

The next step starts with a screening of the considered parameters in order to identify those few parameters with the most effect on the output. This identifies which of the selected predictor parameters are statistically significant in affecting the response of a specific structure and insures that the response surface function will be efficient. This identification process is carried out by using simple statistical analysis, typically a 2-level multifactor experiment that yields a matrix of cases (defined by input and output variables) to evaluate. The matrix form is determined based on design of experiments (*e.g.*, Plackett Burman designs, *etc.*). Nonlinear time-history analyses using a tool such as ZEUS-NL [Elnashai 2005] with an ensemble of ground motions are then performed to find the output for each of the cases of the selected input parameters. The significant parameters are determined by following a screening process (*i.e.*, a Pareto optimization).

The next step involved another design of experiments to define the cases (samples) used to generate the response surface itself. Thus far only 2nd order multivariate polynomials have been used, and in this procedure, the Central Composite Design method is used because it is straightforward and provides a competent set of input parameter combinations (also known as experimental sampling). An ensemble of representative ground motion records is randomly selected for applying to each combination for which the nonlinear time history response is computed following the same approach used in the screening process. Peak structural or geosstructural responses obtained from the nonlinear time history analysis are used as the output variables for each set of input parameter combinations. Finally, the polynomial response surface function(s) are computed from the selected samples using least-squares regression.

Fragility Estimation from Metamodel

Fragility estimations are developed by a straightforward Monte Carlo simulation using the RSM's developed previously to represent the structural behavior of the classes of structures represented in the collection. This is shown in Figure A.2 which describes the process used to

estimate the fragility of a single class of structures within a collection. It is first necessary to choose the appropriate metamodel (RSM) for the particular class of structures or geostructures to be considered. For instance, the response surface function for L-shaped steel moment frame buildings is developed in Chapter 5 and models for dams and levees are developed in Chapters 6 and 7. The metamodel will then allow rapid estimation of the appropriate limit state variable (*e.g.*, inter-story drift for buildings, top displacement for levees). Once the RSM function for a specific structure is determined, it is also necessary to identify the structural performance levels consisting of predefined limit states. For buildings these limit states are immediately occupancy, life safety and collapse prevention.

The next step involves determination of the probability distributions that characterize the uncertainty in the significant input parameters. These distributions are determined based on inventory data or engineering judgment and may be specific to the particular collection under consideration. In the next step, a Monte Carlo simulation is carried out using samples for each of the significant parameters based on the corresponding probability distributions. The output (limit state variable) is then computed using the computationally efficient response surface for the particular structural class. The calculated response is used to determine whether it exceeds the specific structural performance limit state or not. Typically, as part of the Monte Carlo simulation, an indicator function (ID) that takes the value of 1 if the response goes beyond limit states and otherwise is 0, is defined. This procedure is repeated many times for all available ground motions expected at the site, and it is repeated for structures resulting from new realizations of the input variables. This process is run for several thousand times (*e.g.*, $n=10,000$) in order to find reliable damage probabilities. Finally, the fragility curve for a specific structure type is generated using simulated points found by following the proposed algorithm. Optionally, a lognormal distribution can be fitted through the computed points.

PROJECT DS-5 FINAL REPORT

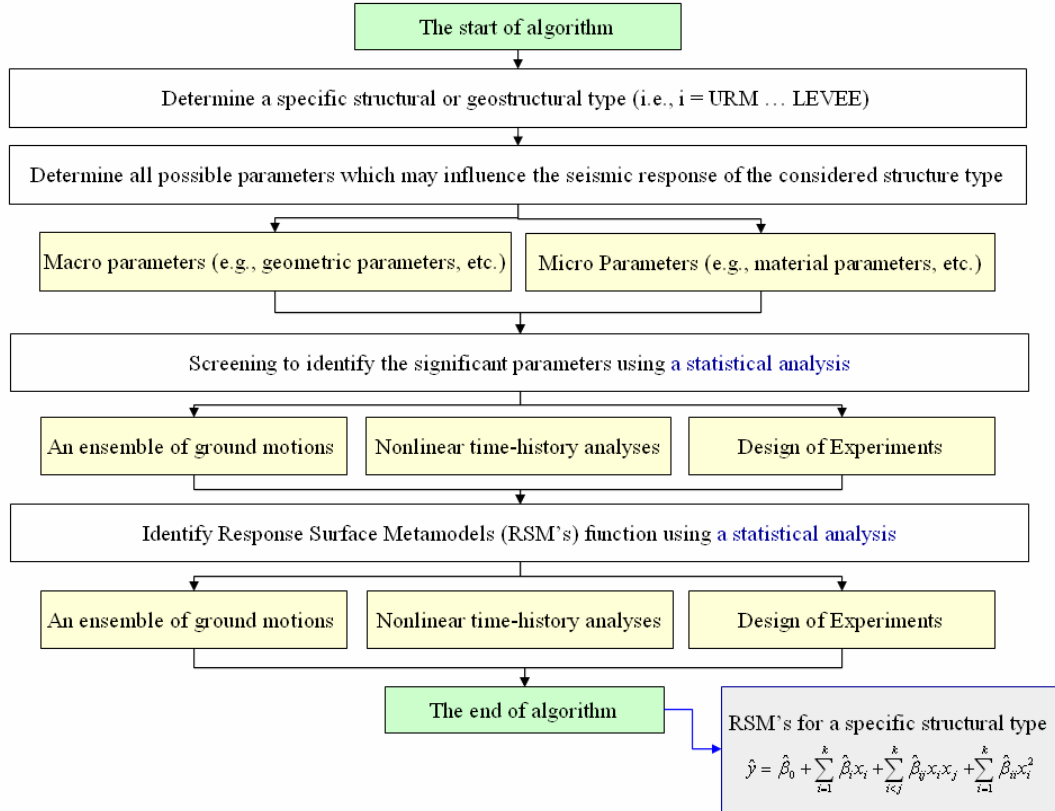

Figure A.1: The flow chart of defining RSM's function in a program

PROJECT DS-5 FINAL REPORT

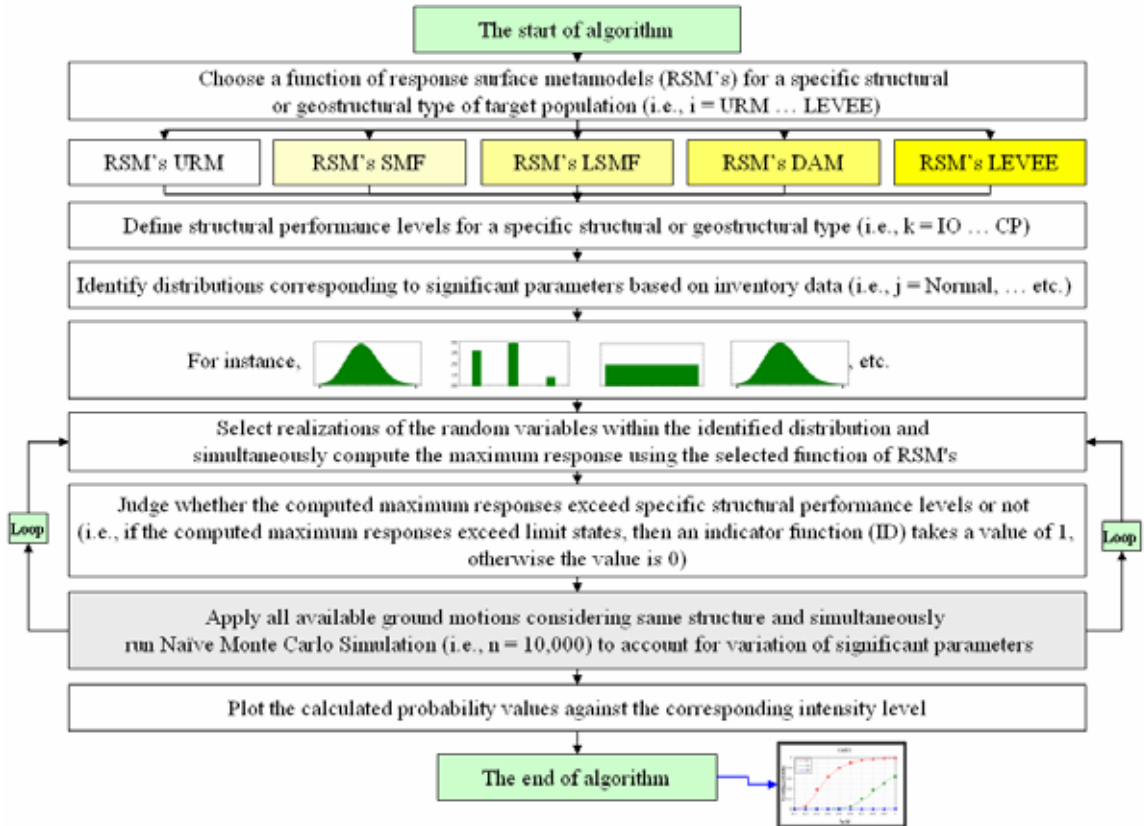

Figure A.2: The flow chart of creating fragility curves in a program

REFERENCES

- A.D., Mueller C.S., Barnhard T., Perkins D.M., Leyendecker E.V., Dickman N., Hanson S. and Hopper M., National Seismic Hazard Maps: Documentation - Open-File Report 96-532, U.S. Geological Survey, 1996
- Abrams, D. P., “Strength and Behavior of Unreinforced Masonry Elements,” Proceedings of the Tenth World Conference on Earthquake Engineering, Madrid, Spain, 1992, pp. 3475-3480
- Abrams, D. P., and Shinozuka, M., “Loss Assessment of Memphis Buildings,” Technical Report NCEER-97-0018, National Center for Earthquake Engineering Research, University at Buffalo, State University of New York, Buffalo, NY, 1997
- American Society of Civil Engineers Standard, New York: ASCE, 1988
- Anagnos, T., Rojahn, C., and Kiremidjian, A. S., “NCEER-ATC Joint Study on Fragility of Buildings,” Technical Report NCEER-95-0003, National Center for Earthquake Engineering Research, University at Buffalo, State University of New York, Buffalo, NY, 1995
- Ang, A. H. S., and Tang, W. H., “Probability Concepts in Engineering Planning and Design”, Volume 1 – Basic Principles, John Wiley & Sons, Inc., New York, 1975
- Ang, A. H. and Tang, W.H., “Probability Concepts in Engineering Planning and Design”, Vol. 2, Decision, Risk, and Reliability, Wiley, NY, 1984
- ASCE, “Construction Control for Earth and Rockfill Dams”, Technical Engineering and Design Guides as adapted from the US Army Corps of Engineers, No.27, American Society of Civil Engineers Press, VA, 1999
- ASCE/SEI Structure congress, New York, NY, 2005
- ATC – Applied Technology Council, “Earthquake Damage Evaluation Data for California,” Report ATC-13, Applied Technology Council, Redwood City, CA, 1985
- Basöz, N., and Kiremidjian, A. S., “Development of Empirical Fragility Curves for Bridges,” Proceedings of the 5th U.S. Conference on Lifeline Earthquake Engineering, Seattle, WA, 1999, pp. 693-702.

PROJECT DS-5 FINAL REPORT

- Boore D.M., SMSIM - Fortran programs for simulating ground motions from earthquakes: version 2.0, A revision of OFR 96-80-A. Open-File Report 00-509. US Geological Survey, CA, 2000
- Box, G. E. P., and Draper, N. R., "Empirical Model-Building and Response Surfaces", John Wiley & Sons, Inc., New York, NY, 1986
- Box, G. E. P., and Draper, N. R., "Robust Designs", *Biometrika*, Vol. 62, No. 2, pp. 347-352, 1975
- Box, G. E. P., and Wilson, K. B., "On the Experimental Attainment of Optimum Conditions", *Journal of the Royal Statistical Society, Series B*, Vol. 13, Issue 1, pp. 1-45, 1951
- Box, G.E.P. and Draper, N.R., "Empirical Model-Building and Response Surfaces", John Wiley & Sons, NY, 1987
- Bucher, C. G., and Bourgund, U., "A Fast and Efficient Response Surface Approach for Structural Reliability Problems", *Structural Safety*, Vol. 7, No. 1, pp. 57-66, 1990
- Byrne, P. M., "A cyclic shear-volume coupling and pore pressure model for sand" Proceedings, 2nd international conference on Recent Advances in Geotechnical Earthquake and Soil Dynamics, St. Louis, Missouri, March 2001, Vol.1, pp. 47-56
- Chawla G. and Frost J. D. "A spatial probabilistic framework for regional seismic simulation of earth and rockfill dams" Proceedings, 11th International Conf. on Soil Dynamics and Earthquake Engineering/3rd International Conf. in Earthquake Geotechnical Engineering, January 2004, Vol. 2, pp. 372-379
- Christopher, A, Robert, R. Building Configuration and Seismic Design; John Wiley & Sons, Inc: New York, 1982
- Coad D. W., Personal E-mail Communication, US Army Corps of Engineers, 2004
- Constantinou, M. C., and Sigaher, A. N., "Energy Dissipation system Configurations for Improved Performance", Proceedings of the 2000 Structures Congress & Exposition, Philadelphia, PA, 2000

PROJECT DS-5 FINAL REPORT

- Cornell, C. A., Jalayer, F., Hamburger, R. O., and Foutch, D. A., “Probabilistic Basis for 2000 SAC Federal Emergency Management Agency Steel Moment Frame Guidelines,” *Journal of Structural Engineering*, Vol. 128, No. 4, pp. 526-533, 2002
- Cornell, CA. “Calculating building seismic performance reliability: a basis for multi-level design norms” In: Proc of the 11th WCEE, Acapulco, Mexico, STS 13, 1996
- Craig, J. I., Goodno, B. J., Towashiraporn, P., and Park, J., “Response Modification Applications for Essential Facilities,” Final Report for Project ST-4, Mid-America Earthquake Center, School of Civil and Environmental Engineering, Georgia Institute of Technology, Atlanta, GA, 2002
- DeLaurentis, D., Mavris, D. N., and Schrage, D. P., “System Synthesis in Preliminary Aircraft Design using Statistical Methods,” Proceedings of the 20th Congress of the International Council of the Aeronautical Sciences, Sorrento, Italy, 1996
- Dimova, S. L., and Elenas, A., “Seismic Intensity Parameters for Fragility Analysis of Structures with Energy Dissipating Devices,” *Structural Safety*, Vol. 24, No. 1, pp. 1-28, 2002
- Drosos, V., “Synthesis of earthquake ground motions for the New Madrid seismic zone”, Master Thesis, Georgia Institute of Technology, Atlanta, GA, 2003
- Dueñas-Osorio, L., Craig, J. I., and Goodno, B. J. “Rapid regional response simulation of 3-D prototype structures for fragility characterization” Proceedings, 13th World Conference on Earthquake Engineering, August 1-6; Paper No 1499, 2004
- Dumova-Jovanoska, E., “Fragility Curves for Reinforced Concrete Structures in Skopje (Macedonia) Region,” *Soil Dynamics and Earthquake Engineering*, Vol. 19, No. 6, pp. 455-466, 2000
- Earthquake Engineering, August 1-6; Paper No 1006, 2004
- Elgamal A., Parra E., Yang Z. and Adalier K., “Numerical Analysis of Embankment Foundation Liquefaction Countermeasures”, *Journal of Earthquake Engineering*, Vol. 6, No. 4, 447–471, 2002
- Elnashai, A. S., Papanikolaou, V. and Lee, D. H. ZEUS Non-linear: A system for inelastic analysis of structures, User Manual, version 1.6.3. UIUC, Urbana-Champaign, IL, 2005

PROJECT DS-5 FINAL REPORT

Engelund, W. C., Stanley, D. O., Lepsch, R. A., McMillan, M. M., and Unal, R., "Aerodynamic Configuration Design using Response Surface Methodology Analysis," Proceedings of the AIAA Aircraft Design, Systems, and Operations Meeting, Monterey, CA, 1993

Faravelli, L. "Response surface approach for reliability analysis", Journal of Engineering Mechanics, ASCE, 115:1763-1781, 1989

FEMA – Federal Emergency Management Agency, "NEHRP Commentary on the Guidelines for the Seismic Rehabilitation of Buildings," Report No. FEMA-274, Washington, DC, 1997

FEMA – Federal Emergency Management Agency, "Evaluation of Earthquake Damaged Concrete and Masonry Wall Buildings," Report No. FEMA-307, Washington, DC, 1998

FEMA – Federal Emergency Management Agency, "Prestandard and Commentary for the Seismic Rehabilitation of Buildings," Report No. FEMA-356, Washington, DC, 2000a

FEMA – Federal Emergency Management Agency, "State of the Art Report on Systems Performance of Steel Moment Frames Subject to Earthquake Ground Shaking," Report No. FEMA-355C, Washington, DC, 2000b

FEMA-Federal Emergency Management Agency, NEHRP recommended provisions for the development of seismic regulations for new buildings. Report FEMA 96, Federal Emergency Management Agency, Washington, DC, 66-79, 1986

Fox, E. P., "The Pratt & Whitney Probabilistic Design System," Proceedings of the 35th AIAA/ASME/ ASCE/ AHS/ASC Structures, Structural Dynamics, and Materials Conference, Hilton Head, SC, 1994

Franchin, P., Lupoi, A., Pinto, P.E., and Schotanus, M.IJ. "Response surface for seismic fragility analysis of RC structures", 9th International conference of Applications of Statistics and Probability in Civil Engineering, 2003

French, S., "DS-2 Advanced Inventory Technologies,"
<http://mae.ce.uiuc.edu/Research/Coreslides/ds-2.ppt>, 2003

French, S., and Olshansky, R., "Inventory of Essential Facilities in Mid-America," Project SE-1 Final Report, Mid America Earthquake Center, The University of Illinois, Champaign, IL, 2000

PROJECT DS-5 FINAL REPORT

- Friedman L. W., "The Simulation Metamodel", Kluwer Academic Publishers, 1995
- Galambos, T. V., Ellingwood, B., MacGregor, J. G., and Cornell, C. A., "Probability Based Load Criteria: Assessment of Current Design Practice", ASCE Journal of Structural Division, Vol. 108, No. ST5, pp. 959-977, 1982
- Gazetas G., "Seismic response of earth dams: some recent developments", J. Soil. Dyn. and Earthquake Engineering, 6(1), 1-47, 1987
- Geo-Slope International Ltd, "QUAKE/W 5 User's Guide", Geo-Slope International Ltd, Calgary, Canada, 2004a
- Geo-Slope International Ltd, "SLOPE/W 5 User's Guide", Geo-Slope International Ltd, Calgary, Canada, 2004b
- Goodno, B. J., Craig, J. I., and Losiriluk, T., "Performance Objectives for Essential Facilities," Final Report for Project ST-9, Mid-America Earthquake Center, School of Civil and Environmental Engineering, Georgia Institute of Technology, Atlanta, GA, 2003
- Goodno, B. J., Craig, J. I., Dogan, T., and Towashiraporn, P., "Ductile Cladding Connection Systems for Seismic Design," Building and Fire Research Laboratory, NIST, Report GCR 98-758, 1998
- GTSTRUDL User Guide: Design – Revision 2, Computer Aided Structural Engineering Center, School of Civil and Environmental Engineering, Georgia Institute of Technology, Atlanta, GA, 1999
- Hwang, H. H. M., and Huo, J.-R., "Generation of Hazard-Consistent Fragility Curves", Soil Dynamics and Earthquake Engineering, Vol. 13, No. 5, pp. 345-354, 1994a
- Hwang, H. H. M., and Huo, J.-R., "Generation of Hazard-Consistent Fragility Curves for Seismic Loss Estimation Studies", Technical Report NCEER-94-0015, National Center for Earthquake Engineering Research, University at Buffalo, State University of New York, Buffalo, NY, 1994b
- Hwang, H., Liu, J. B., and Chiu, Y.-H., "Seismic Fragility Analysis of Highway Bridges", Center of Earthquake Research and Information, The University of Memphis, Memphis, TN, 2000
- ICC – International Code Council, 2000 International Building Code, Falls Church, VA, 2000

PROJECT DS-5 FINAL REPORT

- Irfan, K., “Application of kriging method to structural reliability problems”, *Structural Safety*, 27: 133-151, 2005
- Ishibashi, I. and X. Zhang, “Unified dynamic shear moduli and damping ratios of sand and clay”, *Soils and Foundations*, 33, 1, 182-191, 1993
- Itasca, *FLAC - Fast Lagrangian Analysis of Continua: Optional Features: Dynamic Option*, Version 4.0, Itasca Consulting Group, MN, 2000
- Jaw, J.-W., and Hwang, H. H. M., “Seismic Fragility Analysis of Shear Wall Structures,” Technical Report NCEER-88-0009, National Center for Earthquake Engineering Research, University at Buffalo, State University of New York, Buffalo, NY, 1988
- JCSS – Joint Committee on Structural Safety, “JCSS Probabilistic Model Code,” Internet Publication, <http://www.jcss.ethz.ch/JCSSPublications/PMC/PMC.html>, 2001
- JMP Statistics and Graphics Guide – Version 5.1.2, SAS Institute Inc., Cary, NC, 2005
- Kelly, J. M., Skinner, R. I., and Heine, A. J., “Mechanisms of Energy Absorption in Special Devices for Use in Earthquake Resistant Structures”, *Bulletin of New Zealand Society for Earthquake Engineering*, Vol.5, No 3, 1972
- Khuri, A. I., and Cornell, J. A., “Response Surfaces Designs and Analyses”, Marcel Dekker, Inc., New York, NY, 1987
- Kim, S.-C., and White, D. W., “MDOF Response of Low Rise Buildings” Draft Report for Project ST-5, Mid-America Earthquake Center, School of Civil and Environmental Engineering, Georgia Institute of Technology, Atlanta, GA, 2001
- Kircher, A. C., “Earthquake Loss Estimation Methods for Welded Steel Moment-Frame Buildings,” *Earthquake Spectra*, Vol. 19, No. 2, pp. 365-384, 2003
- Kleijnen, J. P. C., *Statistical Techniques in Simulation: Part 1*, Marcel Dekker, Inc., New York, NY, 1974
- Kramer, S. L., *Geotechnical Earthquake Engineering*, Prentice Hall, Upper Saddle River, NJ, 1996

PROJECT DS-5 FINAL REPORT

Lin, D. K. J., and Tu, W., "Dual Response Surface Optimization", *Journal of Quality Technology*, Vol. 21, No. 1, pp. 34-39, 1995

Magenes, G. and Calvi, G. M., "In-Plane Seismic Response of Brick Masonry Walls", *Earthquake Engineering and Structural Dynamics*, Vol. 26, pp. 1091-1112, 1997

Mann, N. R., Schafer, R. E., and Singpurwalla, N. D., "Methods for Statistical Analysis of Reliability and Life Data", John Wiley & Sons, Inc., New York, NY, 1974

Martinez-Romero, E., "Experiences on the Use of Supplementary Energy Dissipators on Building Structures", *Earthquake Spectra*, Vol. 9, No. 3, pp. 581-625, 1993

Mavris, D. N., and Bandte, O., "A Probabilistic Approach to Multivariate Constrained Robust Design Simulation", *Proceedings of 1997 World Aviation Conference*, Anaheim, CA, 1997

Mavris, D. N., Bandte, O., and Schrage, D. P., "Effect of Mission Requirements on the Economic Robustness of an HSCT Concept", *Proceedings of the 18th Annual Conference of the International Society of Parametric Analysts*, Cannes, France, 1996

McCabe, S. L., and Hall, W. J., "Assessment of Seismic Structural Damage," *Journal of Structural Engineering*, Vol. 115, No. 9, pp. 2166-2183, 1989

McKay, M. D., Beckman, R. J., and Conover, W. J., "A Comparison of Three Methods for Selecting Vales of Input Variables in the Analysis of Output From a Computer Code," *Technometrics*, Vol. 21, No. 2, pp. 239-245.(Latin-Hypercube), 1979

McNamara, R. J., Huang, C. D., and Wan, V., "Viscous-Damper with Motion Amplification Device for High Rise Building Applications", *Proceedings of the 2000 Structures Congress & Exposition*, Philadelphia, PA, 2000

Montgomery, D. C., *Design and Analysis of Experiments*, John Wiley & Sons, Inc., 1997

Mosalam, K. M., White, R. N., and Gergely, P., "Computational Strategies for Frames with Infill Walls: Discrete and Smeared Crack Analyses and Seismic Fragility," *Technical Report NCEER-97-0021*, National Center for Earthquake Engineering Research, University at Buffalo, State University of New York, Buffalo, NY, 1997

PROJECT DS-5 FINAL REPORT

Myers, R. H. and Montgomery, D. C., *Response Surface Methodology*, 2nd Edition, John Wiley & Sons, Inc., 2002.

Neter J., Kutner M. H., Nachtschiem C. J., Wasserman W., “*Applied Linear Statistical Models*”, McGraw-Hill/Irwin; 4th edition 1996, pp. 1045-1310

NIBS – National Institute of Building Sciences, “*HAZUS 99 Earthquake Loss Estimation Methodology*”, Technical Manual, Washington, DC, 1999

O’Rourke, M. J., and So, P., “*Seismic Behavior of On-Grade Steel Tanks; Fragility Curves*”, Proceedings of the 5th U.S. Conference on Lifeline Earthquake Engineering, Seattle, WA, pp. 849-858, 1999

O’Rourke, M. J., and So, P., “*Seismic Fragility Curves for On-Grade Steel Tanks*,” *Earthquake Spectra*, Vol. 16, No. 4, pp. 801-815, 2000

Papila, M., and Haftka, R. T., “*Response Surface Approximations: Noise, Error Repair, and Modeling Errors*,” *AIAA Journal*, Vol. 38, No. 12, pp. 2336-2343, 2000

Park, J., Craig, J. I., and Goodno, B. J., “*Simple Nonlinear In-Plane Response Models for Assessing Fragility of URM Walls*,” Proceedings of the 7th U.S. National Conference on Earthquake Engineering, Boston, MA, 2002

Park, Y.-J., and Ang, A. H.-S., “*Mechanistic Seismic Damage Model for Reinforced Concrete*,” *Journal of Structural Engineering*, Vol. 111, No. 4, pp. 722-739, 1985

Park, Y.-J., and Ang, A. H.-S., “*Mechanistic Seismic Damage Model for Reinforced Concrete*,” *Journal of Structural Engineering*; 111: No. 4, 722-739, 1985

Peralta, D. F., Bracci, J. M., and Hueste, M. B. D., “*Seismic Performance of Rehabilitated Floor and Roof Diaphragms*,” Final Report for Project ST-8, Mid-America Earthquake Center, Texas A&M University, College Station, TX, 2000

Perry, C. L., Fierro, E. A., Sedarat, H., and Scholl, R. E., “*Seismic Upgrade in San Francisco Using Energy Dissipation Devices*,” *Earthquake Spectra*, Vol. 9, No. 3, pp. 559-579, 1993

Pinelli, J. P., Moor, C., Craig, J. I., and Goodno, B. J., “*Testing of Energy Dissipating Cladding Connections*,” *Earthquake Engineering and Structural Dynamics*, Vol. 25, pp. 129-147, 1996

PROJECT DS-5 FINAL REPORT

Pinelli, J.-P., "Development of Energy Dissipating Cladding Connections for Passive Control of Building Seismic Response," Ph.D. Thesis, School of Civil and Environmental Engineering, Georgia Institute of Technology, Atlanta, GA, 1992

Pinelli, J.-P., Craig, J. I., Goodno, B. J., and Hsu, C. C., "Passive Control of Building Response Using Energy Dissipating Cladding Connections," *Earthquake Spectra*, Vol. 9, No. 3, pp. 529-546, 1993

Prakash, V., Powell, G. H., and Campbell, S., "DRAIN-2dx Base Program Description and User Guide," Version 1.10, Dept. of Civil Engineering, University of California, Berkeley, CA, 1993

Rajashekhar, M. R., Adidam, S. S. R., and Ellingwood, B. R., "Structural Reliability Analysis Through Response Surfaces," *Journal of Structural Engineering*, Structural Engineering Research Centre, Madras, India, Vol. 22, No. 4, pp. 179-192, 1996

Rajashekhar, M. R., and Ellingwood, B. R., "A New Look at the Response Surface Approach for Reliability Analysis," *Structural Safety*, Vol. 12, No. 3, pp. 205-220, 1993

Rix, G. J. and Fernandez-Leon, J. A., "Synthetic ground motions for Memphis", TN, Mid-America Earthquake Center, 2004 <http://www.ce.gatech.edu/research/mae_ground_motion>

Rodriguez, M. E. and Aristizabal, J. C., "Evaluation of a Seismic Damage Parameter", *Earthquake Engineering and Structural Dynamics*, 28: 463-477, 1999

Rossetto, T., and Elnashai, A. S. A new analytical procedure for the derivation of displacement-based vulnerability curves for populations of RC structures. 13th World Conference on Earthquake Engineering, August 1-6, Paper No 1006, 2004

SAC joint venture. State of the art report on systems performance of steel moment frames subjected to earthquake ground shaking. Report FEMA 355. Federal Emergency Management Agency, Washington, DC, 2000.

SAS Institute, "JMP – Design of Experiments Guide, Version 5", SAS Institute Inc., Cary, NC, 2002.

SBCC – Southern Building Code Congress, Southern Standard Building Code, Edition, Birmingham, AL, 1969

PROJECT DS-5 FINAL REPORT

SBCCI – Southern Building Code Congress International, 1991 Standard Building Code, Birmingham, AL, 1991

Scholl, R. E., “Added Damping and Stiffness Elements for Earthquake Damage and Loss Control,” Proceedings of Conference XLI: A Review of Earthquake Research Applications in the National Earthquake Hazards Reduction Program: 1877-1987, USGS Open File, Report No. 88-13-A, San Diego, CA, 1988

Schueremans, L., and Gemert, D. V., “Evaluating the Reliability of Structural Masonry Elements Using the Response Surface Technique,” Proceeding of the 8th International Conference on Durability of Building Materials and Components, Vancouver, Canada, 1999

Seya, H., Talbott, M. E., and Hwang, H. H. M., “Probabilistic Seismic Analysis of a Steel Frame Structure,” Engineering Mechanics, Vol. 8, No. 2, pp. 127-136, 1993

Shinozuka, M., Feng, M. Q., Kim, H.-K., Kim, S.-H., “Nonlinear Static Procedure for Fragility Curve Development”, Journal of Engineering Mechanics, Vol. 126, No. 12, pp. 1287-1295, 2000a

Shinozuka, M., Feng, M. Q., Lee, J., and Naganuma, T., “Statistical Analysis of Fragility Curves”, Journal of Engineering Mechanics, Vol. 126, No. 12, pp. 1224-1231, 2000b

Simpson, T. W., Peplinski, J. D., Koch, P. N., and Allen, J. K., “Metamodels for Computer-Based Engineering Design: Survey and Recommendations”, Engineering with Computers, Vol. 17, No. 2, pp.129-150, 2001

Simsir, C. C., Aschheim, M. A., and Abrams, D. P., “Response of Unreinforced Masonry Bearing Walls Situated Normal to the Direction of Seismic Input Motions”, Proceedings of the 7th U.S. National Conference on Earthquake Engineering, Boston, MA, 2002

Skinner, R. I., Kelly, J. M., and Heine, A. J., “Energy Absorption Devices for Earthquake Resistant Structures”, Proceeding of the 5th World Conference on Earthquake Engineering, Rome, Italy, pp. 2924-2933, 1973

Skinner, R. I., Kelly, J. M., and Heine, A. J., “Hysteretic Dampers for Earthquake-Resistant Structures,” Earthquake Engineering and Structural Dynamics, Vol.3, pp. 287-296, 1975

Song, J., and Ellingwood, B. R., “Seismic Reliability of Special Moment Steel Frames with Welded Connections: II”, Journal of Structural Engineering, Vol. 125, No. 4, pp. 372-384, 1999

PROJECT DS-5 FINAL REPORT

- Soong, T. T., and Dargush, G. F., “Passive Energy Dissipation Systems in Structural Engineering”, John Wiley & Sons Ltd., West Sussex, England, 1997
- Southern Standard Building Code, Southern Building Code Congress, Birmingham, AL, 1969
- Towashiraporn P., “Building Seismic Fragilities using Response Surface Metamodels”, PhD Thesis, Georgia Institute of Technology, Atlanta, GA, 2004
- Towashiraporn, P., Craig, J. I., and Goodno, B. J., “Probabilistic response simulation and regional vulnerability determination using response surface metamodels”, 13th World Conference on Earthquake Engineering, August 1-6, 2004; Paper No 1410.
- Tyler, R.G., “Tapered Steel Energy Dissipators for Earthquake Resistant Structures”, Bulletin of the New Zealand Society for Earthquake Engineering, Vol.11, No. 4, pp 282-294, 1978
- USACE, U. S. Army Corps of Engineers, National Inventory of Dams, Methodology, State and Federal Agencies Manual, Version 2.0, US Army Corps of Engineers, Washington, DC, 2001
- USACE, U.S. Army Corps of Engineers, “Earth and Rock-Fill Dams- General Design and Construction Consideration, Report No. 1110-2-2300”, US Army Corps of Engineers, Washington, DC., 1994
- USACE, U.S. Army Corps of Engineers, Engineering and Design - Introduction to Probability and Reliability Methods for Use in Geotechnical Engineering, ETL 1110-2-547, US Army Corps of Engineers, Washington, DC, 1995
- USACE, U.S. Army Corps of Engineers, Risk Based Analysis for Evaluation of Hydrology/Hydraulics, Geotechnical Stability, and Economics in Flood Damage Reduction Studies , ETL 1105-2-101, US Army Corps of Engineers, Washington, DC, 1996
- USACE, U.S. Army Corps of Engineers, Risk analysis in geotechnical engineering for support of planning studies, ETL 1110-2-556, US Army Corps of Engineers, Washington, DC, 1999
- USACE, U.S. Army Corps of Engineers, Design and Construction of Levees, ETL 1110-2-1913, US Army Corps of Engineers, Washington, DC, 2000
- Venter, G., Haftka, R. T., and Chirehdast, M., “Response Surface Approximations for Fatigue Life Prediction,” Proceedings of the 38th AIAA/ASME/ASCE/AHS/ASC Structures, Structural

PROJECT DS-5 FINAL REPORT

- Dynamics, and Material Conference and AIAA/ASM/AHS Adaptive Structures Forum, Kissimmee, FL, 1997
- Venter, G., Haftka, R. T., and Chirehdast, M. "Response surface approximations for fatigue life prediction", Proceedings of the 38th AIAA/ASME/ASCE/AHS/ASC Structures, Structural Dynamics, and Material Conference and AIAA/ASM/AHS Adaptive Structures Forum, Kissimmee, FL, 1997
- Welch, W. J., Yu, T.-K., Kang, S. M., and Sacks, J., "Computer Experiments for Quality Control by Parameter Design," Journal of Quality Technology, Vol. 22, No. 1, pp. 15-22, 1990
- Wen Y.K., Ellingwood B.R., Veneziano D. and Bracci J., Uncertainty Modeling in Earthquake Engineering , MAE Center Project FD-2 Report. <http://mae.ce.uiuc.edu>, 2003
- Wen, Y. K., and Wu, C. L., "Uniform Hazard Ground Motions for Mid-America Cities", Earthquake Spectra, Vol. 17, No. 2, pp. 359-384, 2001
- Whittaker, A. S., Bertero, V. V., Thompson, C. L., and Alonso, L. J., "Seismic Testing of Steel Plate Energy Dissipation Devices", Earthquake Spectra, Vol. 7, No. 4, pp. 563-604, 1991
- Williams, R. A., Stephenson, W. J., Odum, J. K., and Worley, D. M., "Seismic Velocities from High-Resolution Surface-Seismic Imaging at Six ANSS Sites Near Memphis, Tennessee," Open-File Report 03-218, U.S. Department of the Interior, U.S. Geological Survey, Golden, CO, 2003
- Wong, K. K. F. and Wang, Y., "Energy-Based Damage Assessment on Structures during Earthquakes", The Structural Design of Tall Buildings, 10: 135-154, 2001
- Wu, C. F. J. and Hamada, M. Experiments-Planning, Analysis and Parameter Design Optimization, John Wiley & Sons, Inc., 2000
- Wyss, G. D., and Jorgensen, K. H., "A User's Guide to LHS: Sandia's Latin Hypercube Sampling Software," Technical Report SAND98-0210, Sandia National Laboratories, Albuquerque, NM, 1998
- Yamazaki, F., Hamada, T., Motoyama, H., and Yamauchi, H., "Earthquake Damage Assessment of Expressway Bridges in Japan," Proceedings of the 5th U.S. Conference on Lifeline Earthquake Engineering, Seattle, WA, pp. 361-370, 1999

PROJECT DS-5 FINAL REPORT

Yao, T. H.-J., and Wen Y.-K., "Response Surface Method for Time-Variant Reliability Analysis," *Journal of Structural Engineering*, Vol. 122, No. 2, pp. 193-201, 1996

Yi, T., "Experimental Investigation and Numerical Simulation of an Unreinforced Masonry Structure with Flexible Diaphragms," Ph.D. Thesis, School of Civil and Environmental Engineering, Georgia Institute of Technology, Atlanta, GA, 2004

Yi, T., Moon, F., Leon, R., and Kahn, L., "Performance Characteristics of Unreinforced Masonry Low-Rise Structure Before and After Rehabilitation," *Proceedings of the 7th U.S. National Conference on Earthquake Engineering*, Boston, MA, 2002