

## **The large scale observing system component of ADRICOSM: the satellite system**

Roberto SCIARRA, Emanuele BÖHM, Emma D'ACUNZO  
and Rosalia SANTOLERI

*Istituto di Scienze dell'Atmosfera e del Clima – C.N.R.,  
Via del Fosso del Cavaliere 100, Rome, Italy*

---

*In the framework of the ADRICOSM project, the Satellite Oceanography Group (GOS) of Rome developed a Fast Delivery System (FDS) for providing the partner modeling centres with remotely-sensed ocean colour and sea surface temperature (SST) data. Data are processed, mapped and binned on the Adriatic Sea area in order to be assimilated into both ecosystem models and circulation models for ocean forecasting. Further technological improvements permitted the building and optimization of a system suitable for meeting the increasing demand for near-real-time ocean colour and SST products for applications in operational oceanography. Real-Time Images of SeaWiFS chlorophyll concentration, clouds/case I/case II water flags and true colour images are obtained by processing the satellite passes using climatological ancillary data. These images are provided daily through an ad hoc automatic system that processes the raw satellite data and makes it available on the web within an hour of satellite overpass acquisition. All of the images are stored in a gallery web archive organized in a calendar chart. Accurate chlorophyll maps for assimilation are produced in near real time (typically after 4 days) as soon as daily meteorological ancillary data are made available on the NASA website. Each chlorophyll map is flagged for clouds or other contamination factors using the corresponding 24 quality flag maps. This implies that case-2 waters and spurious atmospheric effects have been removed from the pigment data set. This final product is binned on the Adriatic model grid and made available for the ADRICOSM project on the GOS web site. NOAA/AVHRR data are also acquired by the GOS ground station in Rome and managed by the FDS from their reception up to their distribution. Daily SST maps of the Adriatic Sea binned over the AREG model grid at 1/16° resolution are distributed weekly in Near-Real-Time along with the daily SST maps of the eastern Mediterranean Sea delivered at 1/8° resolution to the MFSTEP project. Real-Time SST maps of the Adriatic Sea at 1km resolution are posted daily in GIF format on the GOS website.*

---

**Key words:** ADRICOSM project, SeaWiFS, SST, AVHRR, Adriatic Sea

---

## INTRODUCTION

The importance of satellite oceanography in operational applications is based on the capability of satellite-based sensors to collect oceanographic data from large areas in a very short time (i.e. producing synoptic observations). Therefore they make possible the ubiquitous characterization of the conditions and evolution of large marine areas at different scales of motion unobtainable with *in situ* measurements.

However, the real strength of satellite measurements arises when they are combined with the very detailed measurements that can only be made by sampling the marine environment directly.

The Adriatic Sea is 800 km long and on average 150 km wide. It's about 132 000 km<sup>2</sup> in area. It's a semi-enclosed basin with a complex hydrodynamic environment characterized by a cyclonic coastal current system flowing around major gyres. Instabilities occur between coastal and offshore waters. Satellite observations are particularly suitable for quantitatively describing the latter features and their environmental implications.

One of the major aims of the ADRICOSM project is to demonstrate the feasibility of Near Real Time (NRT) coastal current forecasts in order to implement an integrated coastal zone management system in the Adriatic Sea. The Satellite Oceanography Group (GOS) of the Rome section of the Institute of Atmospheric Sciences and Climate (ISAC) of the National Council of Research of Italy (CNR) contributes by supplying the project team with *ad hoc* satellite derived products for the Adriatic Sea acquired by the sensors mounted on NOAA16/17 and Orbview-2 satellites. Data from the Advanced Very High Resolution Radiometer (AVHRR, mounted on NOAA16 and 17) are converted into Sea Surface Temperature maps and given in NRT to the modeling centres where they are assimilated into numerical models for coastal current forecasting. In the same way, data from the Sea-viewing Wide Field-of-view Sensor (SeaWiFS, in orbit on Orbview-2) are converted into water quality parameters for assimilation into ecological models (DEMIROV

*et al.*, 2003; GREZIO & PINARDI, 2006; ODDO *et al.*, 2006; ZAVATARELLI & PINARDI, 2003).

The timely processing of the satellite products is made possible by GOS operating its own High Resolution Picture Transmission (HRPT) receiving station located in Rome (41.84°N, 12.65°E) since 1998. Data from NOAA satellites are public domain, with uncoded broadcasts. The reception of the raw telemetry stream occurs 5 to 6 times per day per satellite over the Mediterranean Sea.

The SeaWiFS mission (<http://seawifs.gsfc.nasa.gov>) is a public-private partnership between NASA and Orbital Sciences Corporation. For this reason, access to the data during the mission is restricted to Authorized Users who will use the data for scientific purposes. Through an agreement with NASA and Orbimage (<http://www.orbimage.com>), GOS is operating the only SeaWiFS real-time direct readout station (HROM) with complete coverage of the Mediterranean Sea with 2-3 passes per day (SeaWiFS operates only during daytime).

The combined SeaWiFS and AVHRR raw data volume acquired daily by the HROM ground station is about half a Gigabyte. Processing the data to higher levels products causes a threefold increase of the data volume.

In order to fulfil the project requirement of NRT data dissemination, the semi-manual GOS information system was automated, thus reducing the human effort to a monitoring activity. This goal was achieved by first analyzing and identifying the main functionalities of the previously existing system. The collected information permitted the summarizing of all activities into three main functions. These are described in the second paragraph. Thereupon follows the identification and description of the objects involved in the actions performed by each function and the description of the activities (sections three and four). Section five describes the structure and behavior of the FDS in terms of hardware and software components and in terms of information interchange between them.

## THE FAST DELIVERY SYSTEM

AVHRR and SeaWiFS data processing develops by two parallel paths.

### Main functions of the FDS

The FD System performs the following three main functions: data acquisition, data processing and data distribution.

The acquisition function: Data from AVHRR and SeaWiFS are broadcast continuously and can be recorded by any High Resolution Picture Transmission (HRPT) ground station within range. In general, HRPT data is lost unless it is received by a ground station or saved on the onboard tape recorder. The HROM direct read-out ground station is equipped with a Data Capture Facility (DCF). The DCF has its core in the Quorum HRPT Data Capture Engine, supplied by Quorum Communications Inc. (<http://www.qcom.com>), which is the system dedicated to the acquisition. It consists of a 1.2 m parabolic antenna equipped with a Tracking Antenna Controller, a GPS receiver, a MetCom Digital Signal Processing receiver and a set of electronics that interact with the QtrackNTDB program, software operating under Windows 2000 which has controlling and data capture functions including SeaWiFS data decryption (AVHRR data are uncoded). It also operates the system calibration and alignment.

Each HRPT pass is kept as one image. Depending on satellite elevation HRPT scenes can range from very short (if the satellite is at the horizon of the station) to very long (more than 10 minutes). Data from NOAA/AVHRR and Orbview-2/SeaWiFS images are acquired and processed daily. During the day, priority is given to SeaWiFS in case of simultaneous

NOAA+Orbview passes. The antenna operates above 5 degrees elevation in order to avoid electromagnetic clutter present in the Rome area. The resulting reduction in geographic coverage has no impact for the Adriatic Sea satellite observation.

The processing function basically consists of a sequence of activities operating a change of state of their inputs. Each activity is referred to here as a processor unit. Processors are simply related by sequential input-outputs: the output of a processor is the input of the following one (waterfall method). However this basic architecture is modified by the requirements of the projects and services in which GOS is involved. SeaWiFS data pass through three main processors: Level 0 to 1 processor, a Level 1 to 2 processor and a Level 2 to End-Products processor. On the other side AVHRR data are involved in the activities of five processors: ingestion, navigation, SST computation, mapping and declouding. Further details are given in the following sections.

The distribution function includes all the activities related to the collection and organization of the higher level products and their distribution and dissemination to the scientific community.

GOS contributes to the ADRICOSM project by distributing the requested data products listed below on the ADRICOSM section of the GOS web-site (<http://gos.ifa.rm.cnr.it>):

- Adriatic Sea Real-Time satellite-derived SST, Chlorophyll *a* concentration, case I and case II waters along with cloud mask in GIF format at 1 km resolution (Figs. 1a, 1b, 1c).

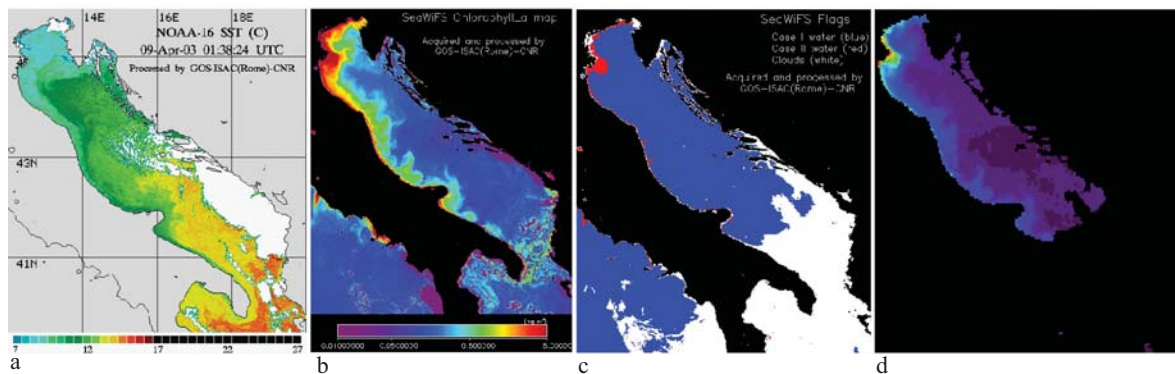

Fig. 1: a) Example of SST .GIF image for the Adriatic Sea; b) RT chlorophyll map processed with climatological data support; c) RT map of flags: case II water (red), case I water (blue), clouds (white); d) visualization of the declouded chlorophyll data binned on the AREG model grid derived from the NRT ancillary data (a different palette is applied compared to b)

- Adriatic Sea Near-Real-Time SST (daily) binned data over the AREG model grid at 5 km resolution.

- Adriatic Sea Near-Real-Time Chlorophyll *a* (as soon as ancillary data are available from NASA) binned data over the AREG model grid at 5 km resolution (Fig. 1d).

In addition to ADRICOSM-related activity the FDS makes other products available to the scientific community such as the Mediterranean Sea Real-Time satellite-derived Quasi True Colour images and Chlorophyll concentration maps in GIF format, both at 4 km resolution, posted on the GOS website.

Nineteen data products (9 of which are related to water parameters while the other 10 concern atmospheric parameters) are produced, organized and stored in the GOS archive for research use as a standard activity.

Level 1a SeaWiFS files (see following section) are posted into the NASA GODDARD DAAC archive centre and images of chlorophyll concentration mapped to requested area limits can be sent to research vessels involved in oceanographic cruises.

### THE DATA

AVHRR and SeaWiFS data pass through different formats when processed from raw data to higher products data. Although some processing

steps are common to both sensors it is not possible to make a completely parallel description of both data format evolutions. SeaWiFS processing levels are quite detailed and need further descriptions (SeaWiFS Data Set ReadMe document, web reference) while AVHRR data can be easily described together with the processing activity.

### SeaWiFS DATA DESCRIPTION

SeaWiFS data processed at different levels have different attributes (Table 1). The flow chart of Fig. 2 shows how the different formats are related to the processing activities.

LAC (Local Area Coverage) data is actually Recorded HRPT data. LAC is output up to three times per day according to the Orbview-2 direct broadcast schedule, and it is decrypted by the Data Capture Facility prior to being frame formatted. The thus reconstructed file is called the Level 0 file (L0).

Level 0 is the starting input which is converted into the Level-1A data.

The Level-1A product contains all of the Level-0 data (raw radiance counts from all bands as well as spacecraft and instrument telemetry), appended calibration and geo-referencing data, and instrument and selected spacecraft telemetry that are reformatted and also appended. Each Level-1A product is stored as one physical HDF file.

Table 1. Brief description of the main data types involved in the SeaWiFS processing

Data Type	Description
HRPT	High Resolution Picture Transmission. Data broadcast continuously by the satellite for reception by the HRPT stations
LAC	Local Area Coverage. Recorded HRPT data at 1 km resolution received by a ground station
Level-0 (L0)	Initial data from the SeaWiFS sensor. Reconstructed, unprocessed instrument/payload data at full resolution (raw radiance counts from all bands as well as spacecraft and instrument telemetry)
Level-1A (L1):	Reconstructed, unprocessed instrument data at full resolution, including radiometric and geometric calibration coefficients and geo-referencing parameters (i.e., platform ephemeris) computed and appended, but not applied to the L0 data
Level-2 (L2)	Derived environmental variables at the same resolution and location as the L1 data
QTC	Quasi True Color. 256 color image generated by combining the three SeaWiFS bands that most closely represent red, green and blue (RGB) in the visible spectrum



Level 2 (L2) data consist of derived geophysical parameters produced using the Level 1A radiances as input data. Therefore each Level-2 is generated from a corresponding Level-1A. The main data contents of the product are the geophysical values for each pixel derived from the Level-1A raw radiance counts by applying the sensor calibration, atmospheric corrections and bio-optical algorithms. Each Level-2 product corresponds exactly in geographical coverage (scan-line and pixel extent) to that of its parent Level-1A product and is stored in one physical Hierarchical Data Format (HDF) file. While it is possible to derive 211 geophysical values for each pixel, those most relevant to ADRICOSM are: water-leaving radiances, chlorophyll *a* concentration, the diffuse attenuation coefficient, the epsilon value for the aerosol correction, the angstrom coefficient and the aerosol optical thickness. In addition, 32 flags are associated with each pixel indicating if any algorithm failures or warning conditions occurred for that pixel. The 211 output products include 8 bands across 21 radiance categories (for a total of 168 possible products), plus 43 additional miscellaneous products. GOS has selected for processing only some of these according to projects requirements and GOS' own research use. The main product is chlorophyll *a* concentration.

## THE PROCESSING

Although the acquisition function is common both for SeaWiFS and AVHRR data, the processing function differs for the two sensors. It develops following two parallel processing lines, ending in a common distribution function.

The FD System operates in two phases: Real Time (RT) and Near Real Time (NRT). The Real Time phase includes the entire acquisition function both for SeaWiFS and AVHRR. SeaWiFS processing and distribution occurs both in RT and in NRT, while AVHRR data, after acquisition, are all processed and distributed in NRT.

The descriptions of the activities performed by the processors are explained separately for SeaWiFS (Fig.2) and AVHRR (Fig. 3).

### SeaWiFS processing

With reference to Fig. 2 the processing steps may be explained. The L0 to L1 conversion is conducted in the SeaDAS (SeaWiFS Data Analysis System, BAITH *et al.*, 2001, see section 5) environment. The program reads in SeaWiFS Level 0, 10-bit Data Capture Facility (DCF) frame-formatter files and creates a Level-1A file in Hierarchical Data Format (HDF) for each scene. Level 1A image data are raw, and all spacecraft and instrument telemetry are retained in raw form as in the Level 0 data. In addition, geo-location data, instrument telemetry and selected spacecraft telemetry are converted and appended. The program needs a file called *elements.dat* to calculate the navigation information that is included in the L1A output. The data in the file are orbit position and velocity elements produced by the program using onboard GPS data and a high order orbit propagation model. They are accurate and are used to meet 1 pixel navigation accuracy. To obtain the best navigation, the most recent version of *elements.dat* from the SeaWiFS Project (from a NASA ftp site) is downloaded every day automatically. The downloaded file is derived using a larger number of GPS data and may incorporate occasional navigation corrections. The L1 file produced is temporarily stored on disk (a month) for further processing. An e-mail to the SeaWiFS project at GODDARD DAAC NASA is sent within 20 minutes of acquisition in order to advise ftp data readiness. As the L1 file is produced it is immediately involved in two processors: L1 to L2 and L1 to QTC.

#### L1 to QTC (RT)

This processor has been developed in order to supply a visual online archive of SeaWiFS Quasi True Color images. The QTC is generated by combining the three SeaWiFS bands that most closely represent red, green and blue (RGB) in the visible spectrum. Compositing the

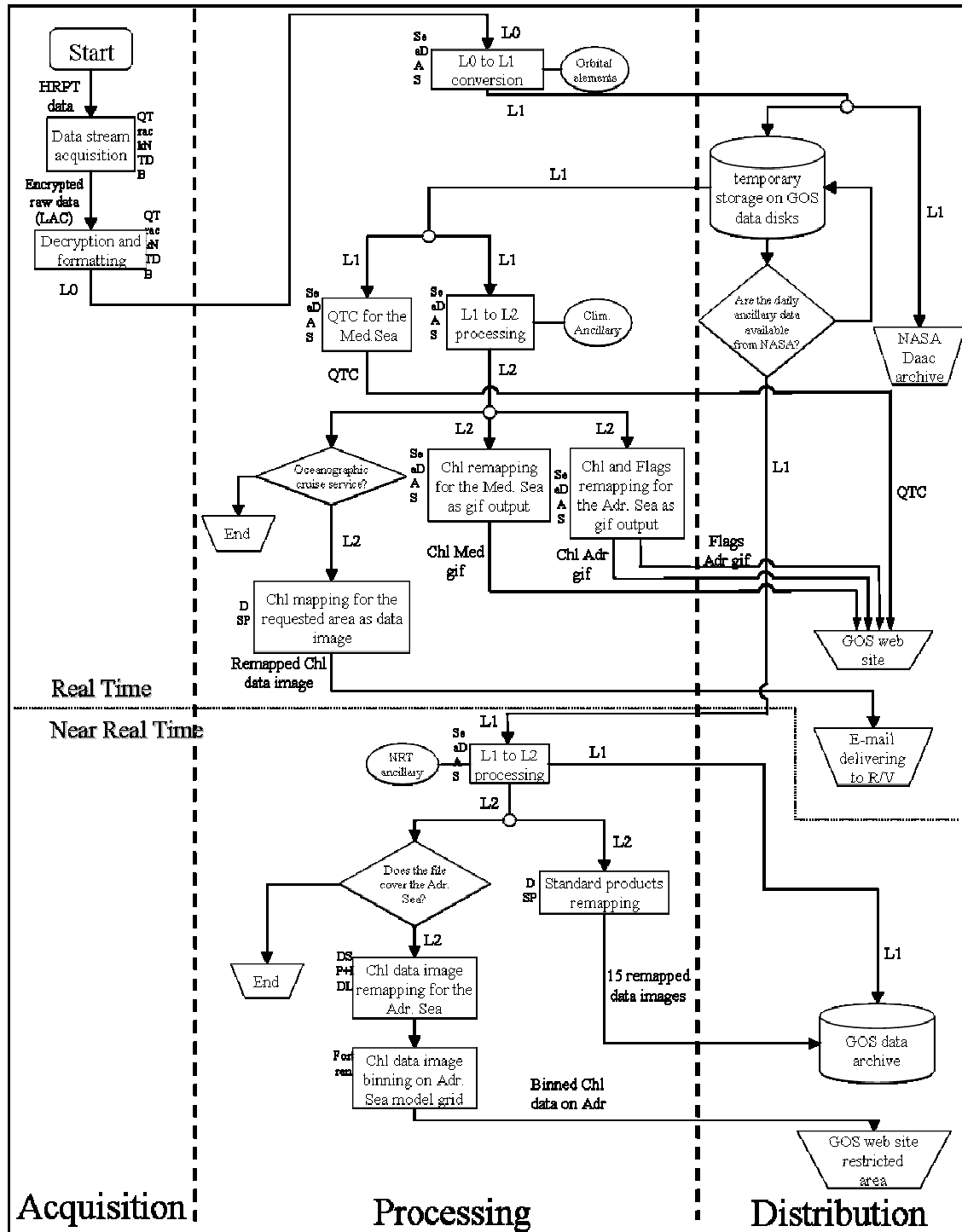

Fig. 2. The FD System performed the following three functions: acquisition, processing and distribution (see text). The input and output for these functions are shown in the flow chart. The Real Time and Near Real Time sections are also indicated

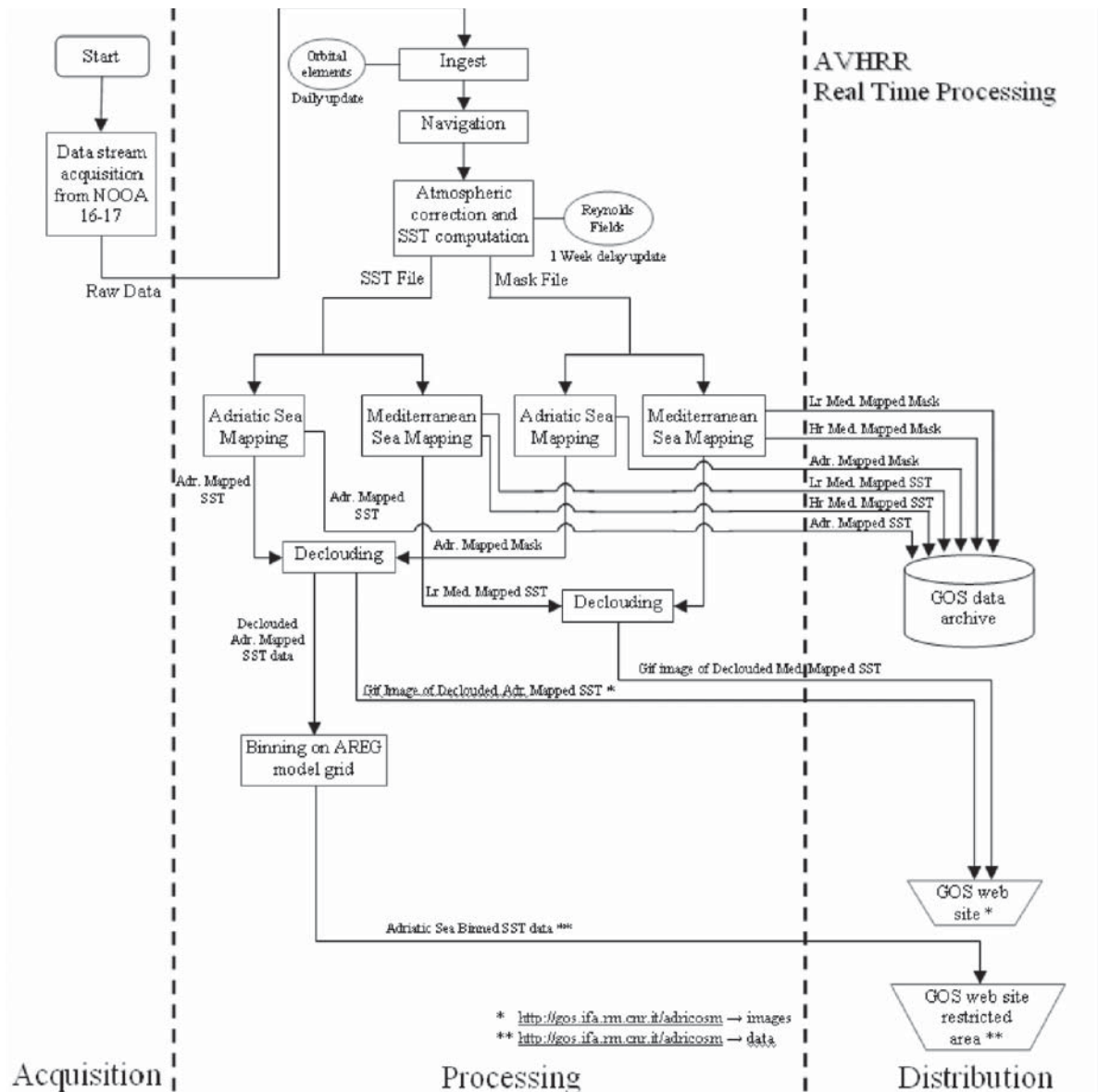

Fig. 3. SST data processing flowchart. The processors involved in the ADRICOSM project production are outlined in red

Rayleigh-corrected radiances at 412 nm, 555 nm and 670 nm (SeaWiFS bands 1, 5 and 6, respectively) produces the range of 256 visible colors, creating an image that is fairly close to what the human eye and brain would perceive as if the observer were viewing the Mediterranean basin region from space. Each pixel represents an area of approximately 1 square kilometer. The output is a gif image of the satellite pass map projected over the Mediterranean basin. The image is

immediately posted on the GOS web site (<http://gos.ifa.rm.cnr.it>).

### L1 to L2 processing with climatological ancillary data (RT)

It is well recognized that more than 90% of the signal measured by an ocean color satellite sensor is due to the confounding influence of the atmosphere. The atmospheric and ocean surface effects must be removed before ocean radiance

signals may be analyzed for the purposes of understanding the ocean biosphere. This step in the processing of satellite ocean color imagery is referred to as the atmospheric correction procedure (SIEGEL *et al.*, 2000). The partition of the atmospheric and ocean contributions to the top of atmosphere radiances sensed by the satellite is the major step of the data processing. One of the problems with this fundamental step is the necessity to have atmospheric ancillary data (ozone profiles, water vapour, etc.) that are not available in Real Time. As a consequence, we decided to have a preliminary RT product using climatological ancillary data (long term monthly means), while definitive products are obtained from daily NRT ancillary data with a few days delay (typically 4 days).

This SeaDAS software performs Level-2 processing on SeaWiFS data and generates Level-2 geophysical products by applying atmospheric corrections and bio-optical algorithms. At this step of the processing chain, there are 211 Level-2 products available for output. Any combination of these 211 products may be selected and written to up to 4 different output files. GOS has defined its output products by choosing the chlorophyll *a* concentration, retrieved with the Ocean Color 4-band algorithm version 4 (OC4v4, O'REILLY *et al.*, 2000), and the l2 flags for indicating if any algorithm failures or warning conditions occurred. The flags product gives information about the presence of turbid water and clouds (Fig. 1c). The processor has a single L2 file as output in which data of the selected product are stored.

#### **L2 to GIF (RT)**

The L2 files from the previous processor becomes the input for a new processor whose aim is to produce a gif file of chlorophyll concentration mapped on the Mediterranean basin, a gif file of the chlorophyll concentration mapped on the Adriatic Sea and the corresponding gif file showing clouds, turbid water (case II water) and case I water. For the chlorophyll (Chl) of the Mediterranean Sea the program operates in three steps. First, the Chl product is extracted from

the L2 file, is then projected on a Mercator map of the Mediterranean basin and, eventually, is posted as a gif file on the GOS web site.

The Adriatic Sea needs more attention in processing. In fact there's a need for detecting which of the two or three passes of the day best covers the Adriatic Sea region. The gif file related to the first pass of the day is always written on the GOS web site. The gif file related to the second pass substitutes the previous one only if its size in K bytes exceeds the size of the previous file. These gif files posted on the web are only used qualitatively.

#### **Processing for imagery delivery service to research vessels (RT)**

Oceanographic cruise campaigns in the Mediterranean Sea often require having on board chlorophyll map images with a daily frequency in order to make decisions about the operational activities. Since the Real Time constraint is an important factor for delivering maps to the ship a switch in the processor which deals with the first L2 round processing has been included for activation in case of GOS support for oceanographic cruises. When it is ON, the L2 output becomes the input for a DSP processor which operates an extraction of the chlorophyll product and then a high resolution mapping on the requested area. The output is a data image file which is automatically sent by e-mail to the research vessel server. In this step DSP is necessary because of Unix workstations onboard the R/V with DSP installed on them.

#### **L1 to L2 processing with near real-time ancillary data products (NRT)**

The L1A file still remains archived in the temporary GOS disk after the Real Time processing while waiting for its NRT ancillary data to become ready for ftp from the GODDARD DAAC (Distributed Active Archive Center, <http://daac.gsfc.nasa.gov>). The NRT ancillary data are meteorological data (meridional wind, zonal wind, pressure, and relative humidity) and total ozone used during the Level-2 processing.



They are usually available from NASA after 4 days. The current source for Met (Meteorological) data is NCEP (National Centers for Environmental Prediction) while that for ozone data is EP TOMS (Earth Probe Total Ozone Mapping Spectrometer). TOVS (TIROS Operational Vertical Sounder) is used as a backup source for ozone data.

While the satellite overpass time fluctuates a little, NRT ancillary data represent global "snapshots" at 1° spatial resolution sampled four times per day for NCEP meteorological data (midnight, 6 a.m., noon, 6 p.m.) and one time per day for EP TOMS ozone data (at noon). Ancillary data are therefore linearly interpolated at the SeaWiFS overpass time. An *ad hoc* procedure has been put in place in order to daily check the availability of the data by retaining memory of the L1 files that still need second L2 round processing. In this NRT L2 processing a larger number of products is selected for retrieval. Nineteen products are divided into two output L2 files: an atmospheric file containing ten products related to the atmosphere (i.e. optical thickness, aerosol index) and an oceanic file containing 9 products related to water parameters (i.e. water leaving radiances for different bands, chlorophyll *a* concentration). Using NRT ancillary data for L2 processing gives more accurate data values than using the climatological data, especially on days in which the meteorological values differ from the long-term monthly means.

### EXTRACTION, MAPPING AND BINNING (NRT)

The NRT L2 output is a file of large dimensions. In the present work it can reach a size of 120 MByte or more, depending on the number of scan lines of the passage and on the number of products processed. In order to have a mapped data image file for each product, a DSP procedure has been developed for performing the product extraction from the L2 file and its mapping on equirectangular projection. Chlorophyll is mapped both in high resolution (1 km<sup>2</sup> per pixel) and in low resolution (4 km<sup>2</sup> per pixel) and flagged for clouds or other con-

tamination factors using the corresponding 24 quality flag maps (McCLAIN *et al.*, 1995). The twenty product files are then archived both on disk and on DAT magnetic tapes. These products are classified as standard because of the normal use which GOS makes of them.

ADRICOSM project requirements foresee the supply by GOS of binned chlorophyll data images on particular model grids for assimilation in numerical ecosystem models for coastal current forecasting. In this step, only the best pass of the day covering the Adriatic Sea needs processing. The information about the best of the two/three passes of the day for the Adriatic Sea is acquired during the RT processing and is passed as a file to the program that manages the DSP processing. Once the file has been extracted and mapped, it is formatted for processing by a Fortran procedure that bins the data onto the model grid (Fig. 1d) The binned data is successively posted on the GOS web site in a password protected area dedicated to ADRICOSM partners.

### AVHRR PROCESSING

With reference to Fig. 1 the following processing steps are used. The processing of AVHRR data begins with the reception of the raw telemetry stream by GOS HRPT station 5 to 6 times per day per satellite over the Mediterranean Sea. The data are processed using the Display Software Package (DSP) developed at Miami University (see section 5).

Ingestion consists of the conversion of the satellite HRPT raw data format (pixel interleaved) to a standard, more processing friendly, DSP image format (band interleaved). Geo-referencing is automatically done on the basis of the orbital elements and onboard clock. Both orbital elements and onboard clock are however inaccurate, unlike the SeaWiFS counterpart which is based on onboard GPS adjustment.

Navigation is the determination and adjustment of the mapping from line/pixel space to latitude/longitude space in order to correct mapping errors due to spacecraft clock and attitude parameters drifts. During visual analysis by a

trained analyst, the required time and roll corrections are applied by adjusting the coastal outline to the actual coastline visible in the imagery (Fig. 4 a, b).

Geophysical conversion is the transformation from sensor counts to single channel radiance and multi-channel derived SST. The Pathfinder algorithm (WALTON *et al.*, 1998; KILPATRICK *et al.*, 2001) has been identified as that providing the most accurate SST's based upon comparison with independent observations (within 0.2 °C) and has been tested on an independent set (from the one used to develop the Pathfinder algorithm) of observations in the Mediterranean Sea (D'ORTENZIO & MARULLO, 2000) with results equivalent to those of the global data set.

Remapping is the specification and application of a particular projection in which to map the image. The specified mathematical transform is applied to a navigated image consisting of scaled geophysical data. Remapped data is specified only by the projection, the latitude/longitude center of the image, and the output pixel size. The projection applied to the images is equirectangular (same projection as for SeaWiFS for allowing the superimposing of different products). The dimensions of Eastern Mediterranean remapped images are 1024 x 800 pixels, ranging from lat. 30.0 N, lon. 10.4 E to lat. 46.0 N, lon. 36.4 E, while for the Adriatic Sea the remapped images are 512 x 600, ranging from lat. 39.0 N, lon. 12.0 E to lat. 46.0 N, lon. 20.0 E (Fig. 1a). Remapped Adriatic SST.gif images are produced at this step.

Declouding is the identification of cloud contaminated pixels in SST imagery (Fig. 4 a, b). Pathfinder SST procedures construct quality control fields based on spatial uniformity tests and difference from Optimally Interpolated REYNOLDS fields (1° resolution weekly averaged global SST) published weekly by NOAA. Low quality pixels are defined as cloud contaminated. However this automated declouding procedure can erroneously identify clouds in areas of strong oceanic cloud fronts due to the coarse resolution of the REYNOLDS fields. An improvement of the declouding procedure is needed in the Adriatic Sea where coastal fronts are strong. A new procedure that takes into account the time evolution of the SST field has been integrated in the processing procedure with the following major steps:

1. generation of a time series of images, of which the last is the image L to be declouded,
2. creation of a reference image R (obtained by retaining the warmest pixels found over the week preceding image L) that is free of clouds in the pixels for which image L is not certainly cloud-free (i.e. all the pixels that are not certainly clouds SST > 5 °C),
3. computation of the difference image L-R (computed on a pixel by pixel basis),
4. use of the histogram of L-R to define an SST (negative) difference threshold below which the image L is cloudy,
5. application of the threshold and the output is the declouded image L<sub>d</sub>.

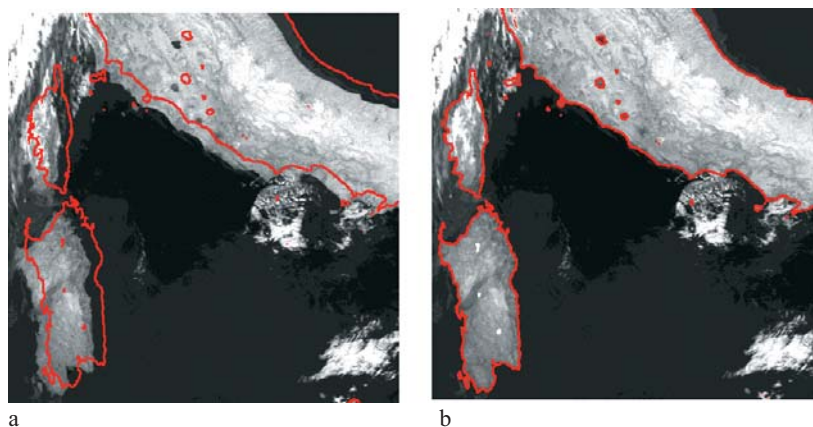

Fig. 4. Navigation example: a) before navigation; b) after navigation

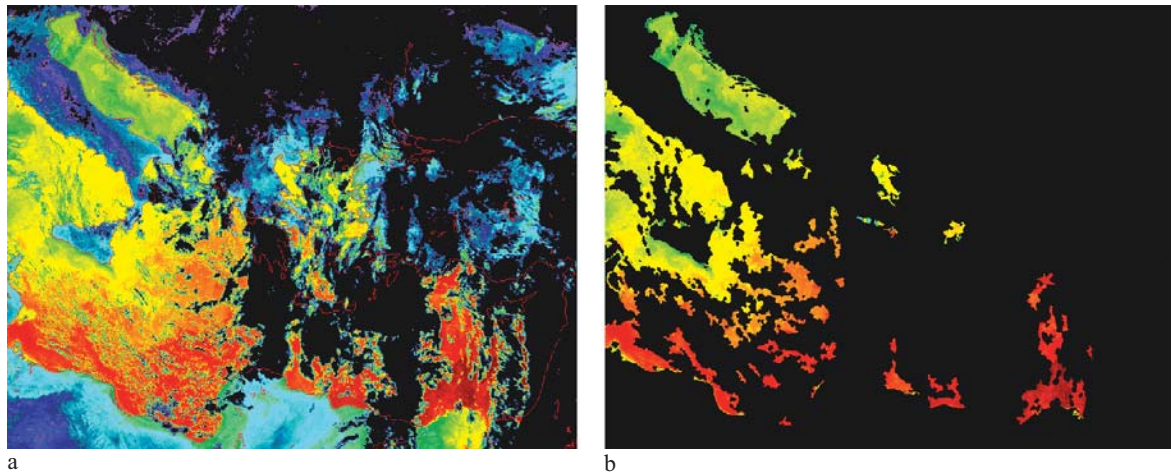

Fig. 5: a) Example of SST image for the Eastern Mediterranean Sea as derived by the AVHRR, and b) the same image after application of the cloud detection algorithm. Clouds and land are in black

Once the declouded images are obtained (Fig. 4b) daily maps are created comprising of single pass images. In order to avoid the diurnal cycle and the skin heating effects, only night passes have been used. After composing the images, daily maps are binned at  $1/8^\circ$  on the MFSTEP model grid and at  $1/16^\circ$  on the AREG grid.

After the processing is completed, the Adriatic data are archived and can be accessed via the GOS web page.

### THE FD SYSTEM ARCHITECTURE

The FDS originates from a previous satellite data processing system that was already operating at GOS. In the latter system the processing steps were similar to those described in the previous sections but they were performed separately and without a specific schedule. The processors were not linked to one another and therefore human activity was essential for managing the data flow. The drawback of the latter configuration was the longer processing time depending on the other commitments of people involved.

The architecture of the FDS is built around the three main functions described in the previous sections and it's based on a job scheduling that minimizes inactivity. The detailed description of the Data Capture Facility, which man-

ages the acquisition function, is discussed in the previous sections.

The activities of each processor unit involved in the processing function are performed by routines developed using three different software packages: IDL, SeaDAS and DSP.

The Interactive Data Language (IDL) by Research System Inc. is software for data analysis, visualization and cross-platform application development. It is used for manipulating the final product according to the user format requirements. IDL routines are used by SeaDAS (SeaWiFS Data Analysis System), which is a comprehensive image analysis package for processing, displaying and analyzing all SeaWiFS data products and ancillary data. The NASA ocean biochemistry program supports SeaDAS. It runs under Linux, Solaris and SGI operating systems.

DSP (Display Software Package) has been developed by the remote sensing group of the University of Miami/RSMAS designed to support oceanographic satellite-derived image processing. It runs under Unix and Linux operating systems. DSP routines perform the mapping of SeaWiFS L2 data and all of the AVHRR processing steps.

SeaDAS and DSP are installed separately on two different workstations, which constitute the hardware core of the FDS processing function. IDL is installed on both the machines that work in parallel. In fact, raw data output from



the DCF is served to the appropriate machine depending on the satellite. The FDS information exchange between the processors behaves like a cell (Fig. 6).

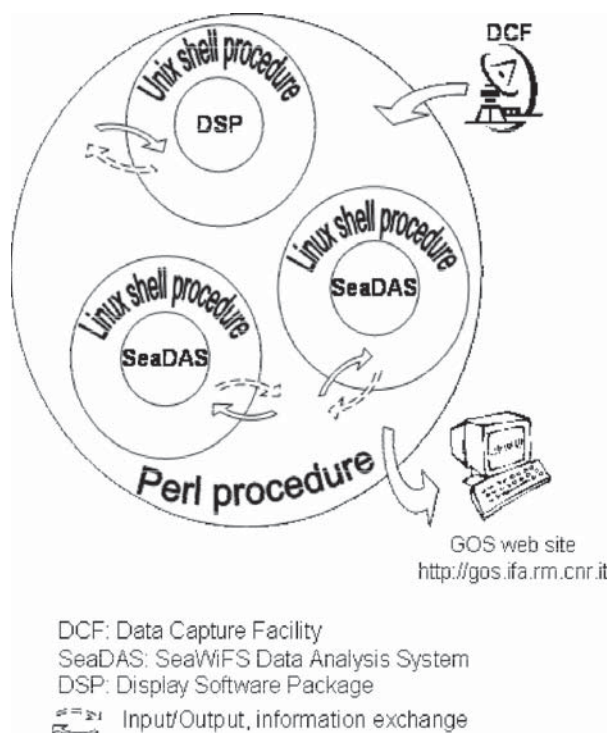

Fig. 6. The FD System architecture

The outermost wrapping consists of a procedure written in Practical Extraction and Report Language (PERL) that manages system tasks. It ideally contains all the processors that, as many nuclei, are composed of an external shell and a core. In each processor unit core there is a SeaDAS or DSP routine performing the conversion of the input file to the output file. The external shell consists of an Unix or Linux shell procedure, which writes all of the parameters files that need to be passed as arguments to the core routine. The master PERL procedure built for the FDS channels the inputs to the individual processors from the DCF raw data to the higher level products posted to the GOS website at each step of the processing. The detailed structure of the PERL procedure is articulated in the 4 steps and illustrated in Fig. 7 below:

1. Processor activity is triggered via e-mail that signals data availability. This occurs in two separate instances: the first when acquired data are ready for processing and the second when final products are ready to be posted on the web. E-mail subject and body contain relevant information for data file processing.

2. Meteorological ancillary data availability is regularly checked by ftp connection with

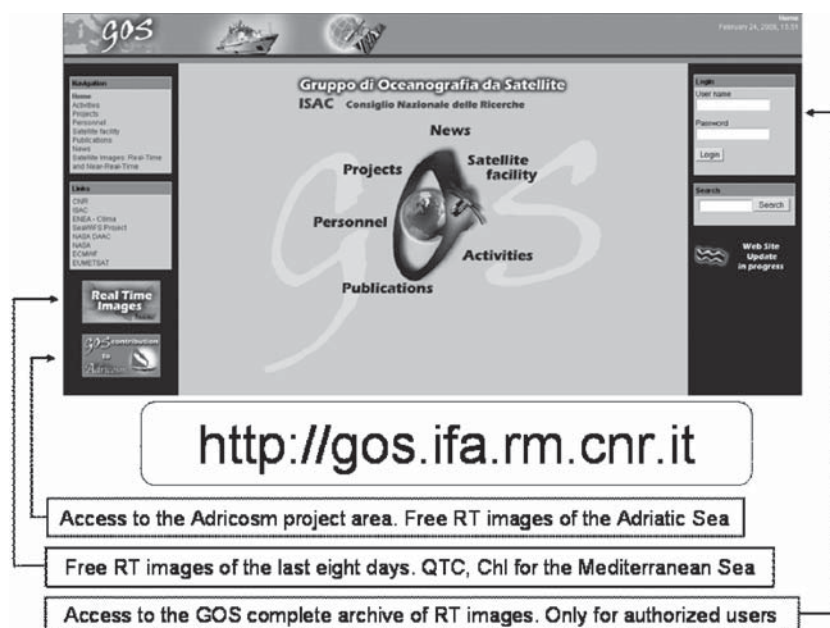

Fig. 7. Home page of the web site of the satellite oceanography group

the NASA archives. When ancillary data are found they are downloaded and used to generate NRT SeaWiFS products.

3. Reporting to log files accomplishes two purposes: the first is to supply the human operator with relevant information (e.g. log e-mails are sent to the people assigned to monitoring the processing), the second is to allow the automated processing to gather useful information (e.g. the information about which pass has the best coverage of the Adriatic Sea).

4. Gif images are placed in galleries interactively linked to a calendar chart web page. Adriatic Sea binned data are posted to an area of the GOS web site restricted to ADRICOSM users (Fig. 7).

## SUMMARY AND CONCLUSIONS

The satellite component of the ADRICOSM large scale observing system acquires, processes and distributes data from SeaWiFS and AVHRR satellite-based sensors. The products derived from this observation are chlorophyll concentration and sea surface temperature. The former gives an indication of the biological activity and the latter of the water mass distribution. These

synoptic high resolution observations of the Adriatic Sea are assimilated with *in situ* data into circulation and ecosystem models. In addition, satellite imagery is directly used to set local observations in the basin scale framework.

Top of the atmosphere radiances are corrected for the atmosphere contribution to retrieve water leaving radiances. These are in turn converted into geophysical products (chlorophyll and SST) by specific algorithms. The FDS performs all of the required processing operations in Real-Time or in Near-Real-Time in an automated fashion providing the final products to the project partners via web. The FDS represents a prototype system for providing value added satellite data to users in a timely fashion. Future improvements will include subsetting capability and live access server functionalities.

## ACKNOWLEDGMENTS

The authors would like to thank the SeaWiFS Project (Code 970.2) and the Distributed Active Archive Center (Code 902) at the GODDARD Space Flight Center, Greenbelt, MD 20771, for the production and distribution of these data, respectively. NASA's Mission to Planet Earth Program sponsors these activities.

## REFERENCES

- BAITH, K., R. LINDSAY, G. FU & C. R. McCLAIN. May 1, 2001. SeaDAS: Data analysis system developed for ocean color satellite sensors. *Eos. Trans. Am. Geophys. Union.*, 82 (18): p 202.
- DEMIROV, E., N. PINARDI, C. FRATIANNI, M. TONANI, L. GIACOMELLI & P. DEMEY. 2003. Assimilation scheme of the Mediterranean Forecasting System: operational implementation. *Ann. Geophys.*, 21: 189-204.
- D'ORTENZIO, F., S. MARULLO & R. SANTOLERI. 2000. Validation of AVHRR Pathfinder SST's over the Mediterranean Sea. *Geophys. Res. Lett.*, 2: 241-244.
- GREZIO, A. & N. PINARDI. 2006. Data assimilation of temperature and salinity profiles in the Adriatic regional model. *Acta Adriat.*, 47 (Suppl.): 149-168.
- KILPATRICK, K. A., G. P. PODESTÀ & R. EVANS. 2001. Overview of the NOAA/NASA advanced very high resolution radiometer Pathfinder algorithm for sea surface temperature and associated match up database, *J. Geophys. Res.*, 106: 9179-9197.
- McCLAIN, C. R., K. ARRIGO, W. E. ESAIAS, M. DARZI, F. S. PATT, R. H. EVANS, J. W. BROWN, C. W. BROWN, R. A. BARNES, & L. KUMAR. 1995. SeaWiFS Algorithms, Part 1, NASA Tech. Memo. 104566, Vol. 28, Hooker, S.B., Firestone E.R. & Acker, J.G. (Editors). NASA Goddard Space Flight Center, Greenbelt, Maryland, 45 pp.
- ODDO, P., N. PINARDI, M. ZAVATARELLI & A. COLUCCELLI. 2006. The Adriatic basin forecasting system. *Acta Adriat.*, 47 (Suppl.): 169-184.



- O'REILLY, J. E., S. MARITORENA, D. SIEGEL, M. C. O'BRIEN, D. TOOLE, B. G. MITCHELL, M. KAHRU, F. P. CHAVEZ, P. STRUTTON, G. COTA, S. B. HOOKER, C. R. MCCLAIN, K. L. CARDER, F. MULLER-KARGER, L. HARDING, A. MAGNUSON, D. PHINNEY, G. F. MOORE, J. AIKEN, K. R. ARRIGO, R. LETELIER & M. CULVER. 2000. Ocean color chlorophyll *a* algorithms for SeaWiFS, OC2, and OC4: Version 4. SeaWiFS Postlaunch Technical Report Series, Hooker, S. B & Firestone, E. R. (Editors). Vol. 11, SeaWiFS Postlaunch Calibration and Validation Analyses, Part 3. NASA, Goddard Space Flight Center, Greenbelt, Maryland, pp. 9-23.
- SIEGEL, D. A., M. WANG, S. MARITORENA & W. ROBINSON. 2000. Atmospheric correction of satellite ocean color imagery: the black pixel assumption. *Appl. Opt.*, 39: 3582-3591.
- WALTON, C. C., W. G. PICHEL, J. F. SAPPER & D. A. MAY. 1998. The development and operational application of non-linear algorithms for the measurements of sea surface temperature with the NOAA polar-orbiting environmental satellites, *J. Geophys. Res.*, 103 (12): 27, 999 - 28, 012.
- ZAVATARELLI, M. & N. PINARDI. 2003. The Adriatic Sea modeling system: A nested approach. *Ann. Geophys.*, 21: 345-364.

## **Komponenta projekta ADRICOSM – sustav promatranja na velikoj skali – satelitski sustav**

Roberto SCIARRA, Emanuele BÖHM, Emma D'ACUNZO i Rosalia SANTOLERI

*Institut znanosti o atmosferi i klimi – C.N.R.  
Via del Fosso del Cavaliere 100, Rim, Italija*

### **SAŽETAK**

U okviru projekta ADRICOSM, GOS (Grupa za satelitsku oceanografiju) iz Rima razvila je Sustav za brzu isporuku FDS, snabdijevanje partnerskih centara za modeliranje satelitskim snimcima boje mora i temperaturnim podacima površine mora (SST). Podaci za Jadran su obrađeni, pretvoreni u grafičke produkte i digitalizirani kako bi se mogli asimilirati u model strujanja i model ekosistema, te koristiti oceanografskoj prognozi. Daljnja tehnološka poboljšanja su omogućila izgradnju i optimalizaciju sustava, zbog rastućih potreba za produktima boje mora i površinske temperature za različite primjene u operativnoj oceanografiji. Slike koncentracije klorofila od senzora SeaWiFS, slike oblaka te Case1 i Case2 oznake, kao i slike prave boje dobivaju se procesiranjem satelitskih scena uz popratne klimatološke podatke. Slike se procesiraju dnevno kroz *ad-hoc* automatski sustav koji obrađuje sirove satelitske podatke i omogućuje njihovu isporuku na mrežu, sat vremena nakon prikupljanja satelitskih podataka tj. nakon prolaska satelita. Sve se slike spremaju u arihvu na mreži koja je organizirana prema datumima. Korigirane slike koncentracije klorofila za asimilaciju u model proizvode se u skoro realnom vremenu (tipično 4 dana kasnije) čim se dobiju popratni meteorološki podaci s mreže NASA-e. Na svakoj slici klorofila su označeni oblaci ili drugi kontaminirajući faktori, prema 24 kategorije kvalitete slika. To znači da su Case 2 slučajevi piksela uklonjeni iz snimaka kao i atmosferske smetnje. Konačni produkt se usklađuje s koordinatnom mrežom Jadrana i stavlja na raspolaganje na stranicama ADRICOSM-a preko GOS-ove Internet stranice. GOS zemaljska stanica u Rimu prikuplja i podatke NOAA/AVHRR koji se procesiraju kroz FDS sustav, od prijema do konačne distribucije podataka. Dnevne se slike površinske temperature mora (SST), usklađene preko koordinatne mreže AREG-a pri prostornom razlučivanju od 1/16 stupnja, distribuiraju tjedno u skoro realnom vremenu, zajedno sa slikama istočnog Sredozemlja koje imaju razlučivanje od 1/8 stupnja prema MFSTEP projektu. Dnevno, u skoro realnom vremenu, isporučuju se slike SST za Jadran uz prostorno razlučivanje od 1 km u GIF formatu na Internet stranici GOS-a.

**Ključne riječi:** projekt ADRICOSM, SeaWiFS, SST, AVHRR, Jadransko more