

# Entropy formulas for systems with singular sets

David Boaventura Mesquita

Tese de Doutoramento apresentada à  
Faculdade de Ciências da Universidade do Porto.  
Matemática

2019

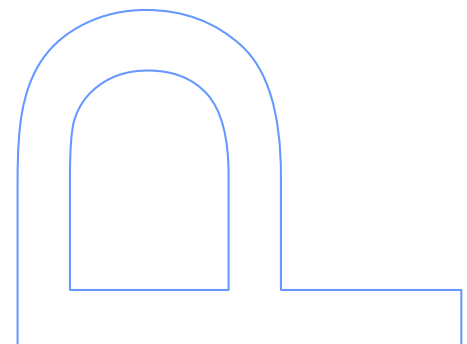
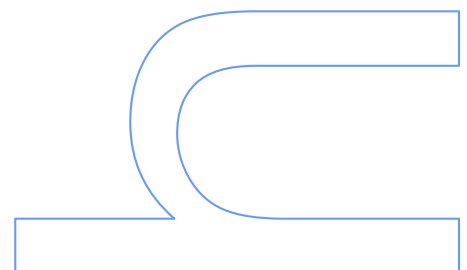
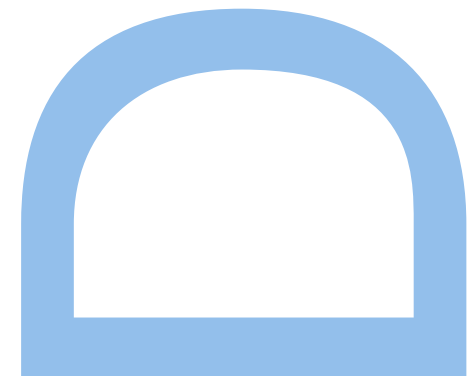
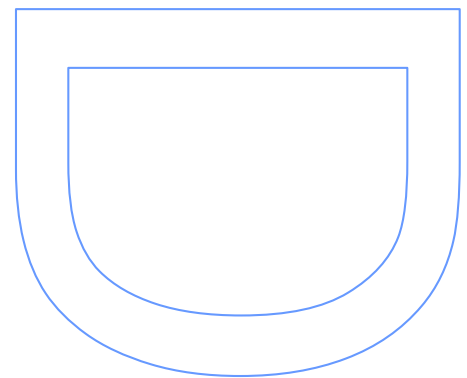
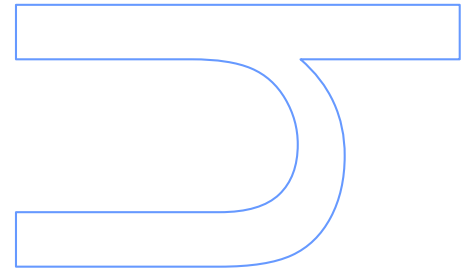
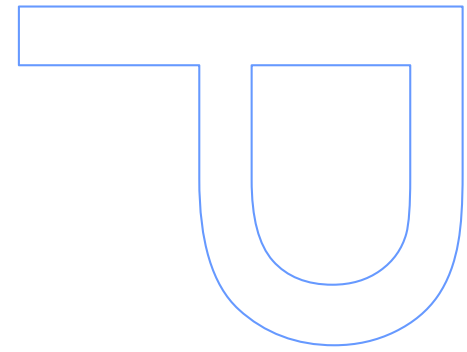



# Entropy formulas for systems with singular sets

**David Boaventura Mesquita**



UP|UC Joint PhD Program in Mathematics

Programa Inter-Universitário de Doutoramento em Matemática

PhD Thesis | Tese de Doutoramento

December 2019



*To my family.*



## Acknowledgements

First and foremost, I would like to express my sincere gratitude to Prof. José Alves for having accepted me as a PhD student, after having already supervised me in the masters. The vast knowledge he shared with me during these years of advanced study, coupled with his friendly guidance and continuous encouragement, contributed decisively to bring this strenuous task to completion and having myself reaching the summit of university education. In this regard, I would like to also acknowledge Prof. Jérôme Buzzi and Prof. Maria Carvalho for the very helpful feedback concerning an hardship related to this work.

My gratitude extends to all the friends, professors, colleagues, university staff and other people that I have come to meet in Porto and other places since the time of my bachelors. They undoubtedly made my journey more meaningful and my learning no less rich.

Last, but not least, I would like to express special thanks to my parents and sister, who provided a platform of patient support over the years of my PhD studies and life in general.

**Financial support:** This work, developed in the Departamento de Matemática da Faculdade de Ciências da Universidade do Porto (DM-FCUP) and Centro de Matemática da Universidade do Porto (CMUP), was financially supported by the project PTDC/MAT/CAL/3884/2014 and the doctoral scholarship PD/BD/128062/2016, funded by Fundação para a Ciência e a Tecnologia (FCT) with national (MCTES) and European structural funds (FSE) through the program POCH. My dearest thanks to all the institutions for the opportunity to pursue a PhD.







## Abstract

In this thesis, we obtain some entropy formulas for the *physical* or *Sinai-Ruelle-Bowen (SRB) measures* of two classes of systems with singular sets first introduced in [5] that, to the best of our knowledge, are not yet clearly covered in previous literature. The first class consists of general endomorphisms displaying *nonuniform expansion* and *slow recurrence* to a *nondegenerate* singular set. The second, inspired on Poincaré return maps of the Lorenz flow, comprises *partially hyperbolic diffeomorphisms with singularities* which are *nonuniformly expanding along the centre-unstable direction* and also exhibit *slow recurrence* to a *nondegenerate* singular set.

Our fundamental approach is heavily dependent upon the existence of a certain type of combinatorial and geometrical structures, introduced in [76]. The full construction of *Young structures*, as these are nowadays commonly called, is thoroughly performed for the first time to the second class of partially hyperbolic maps with singularities, in a way that can be applied to yield the existence of the technically simpler *Gibbs-Markov structures* in the case of endomorphisms, a well-established fact in previous works but recovered here under a new general framework. An entropy formula is then derived for the second class taking into account a classical *compression technique along the stable direction*, that allows a reduction of a Young structure to a Gibbs-Markov, and the inducing scheme based techniques used to derive an entropy formula for the first class.

These abstract results find interesting applications in parametrized families of one- and two-dimensional dynamics encompassing *Lorenz*, *Rovella* and *Luzzatto-Viana* maps. In conjunction with previous works on *statistical stability*, our results pave the way to deepen the study on the problem of the variation of the physical or SRB entropy seen as a function of the maps in these families.

**Keywords:** entropy, partial hyperbolicity, physical/SRB measures, nonuniform expansion, slow recurrence, systems with singularities.



## Resumo

Neste trabalho, o estudo foca-se na obtenção de fórmulas para a entropia das medidas *físicas* ou de *Sinai-Ruelle-Bowen (SRB)* de duas classes de sistemas com conjuntos singulares introduzidas em [5] as quais, tanto quanto nos é possível saber, não se encontram ainda cobertas na literatura disponível. A primeira classe consiste de endomorfismos exibindo *expansão não-uniforme* e *recorrência lenta* a um conjunto singular *não-degenerado*. A segunda, inspirada nas aplicações de primeiro retorno de Poincaré associadas ao fluxo de Lorenz, engloba *difeomorfismos parcialmente hiperbólicos com singularidades* apresentando *expansão não-uniforme ao longo da direção centro-instável* e exibindo de igual forma *recorrência lenta* a um conjunto singular *não-degenerado*.

A nossa estratégia fundamental depende fortemente da existência de um certo tipo de estruturas combinatórias e geométricas introduzidas em [76]. A construção completa de *estruturas de Young*, como são hoje vulgarmente conhecidas, é feita detalhadamente pela primeira vez para a segunda classe de difeomorfismos parcialmente hiperbólicos com singularidades, de uma forma que pode igualmente ser adaptada no caso do endomorfismo para a construção de *estruturas Gibbs-Markov* tecnicamente mais simples, um facto que já se encontra bem estabelecido na literatura mas é aqui recuperado sob uma nova luz. A fórmula da entropia para esta segunda classe é então obtida tendo em conta uma *técnica de compressão ao longo das folhas estáveis*, a qual permite reduzir uma estrutura de Young a uma Gibbs-Markov, e as técnicas de indução usadas para obter a fórmula da entropia para a primeira classe.

Estes resultados abstratos encontram aplicações interessantes em famílias parametrizadas de sistemas uni- e bidimensionais englobando mapas de *Lorenz*, *Rovella* e *Luzzatto-Viana*. Em conjugação com trabalhos prévios sobre *estabilidade estatística*, os nossos resultados abrem caminho para um estudo mais aprofundado sobre o problema da variação da entropia da medida física ou SRB nestas famílias.

**Palavras-chave:** entropia, expansão não-uniforme, hiperbolicidade parcial, medidas físicas/SRB, recorrência lenta, sistemas com singularidades.



# Table of contents

|          |  |           |
|----------|--|-----------|
| <b>1</b> | <b>Introduction</b>  | <b>1</b>  |
| <b>2</b> | <b>Definitions and statements</b>  | <b>7</b>  |
| 2.1      | Expanding endomorphisms with singular sets . . . . .                               | 7         |
| 2.2      | Partially hyperbolic diffeomorphisms with singular sets . . . . .                  | 11        |
| <b>3</b> | <b>Entropy formula for expanding endomorphisms with singular sets</b>              | <b>17</b> |
| 3.1      | Gibbs-Markov structures . . . . .  | 17        |
| 3.2      | Tower extension . . . . .  | 19        |
| 3.3      | Overview of the strategy . . . . .   | 22        |
| 3.4      | Entropy formula for the tower map . . . . .  | 26        |
| 3.5      | Original vs Tower map entropies . . . . .  | 30        |
| <b>4</b> | <b>Entropy formula for partially hyperbolic diffeomorphisms with singular sets</b> | <b>35</b> |
| 4.1      | Young structures . . . . .   | 36        |
| 4.2      | Extensions and quotient dynamics . . . . .   | 39        |
| 4.3      | Theoretical framework . . . . .  | 41        |
| 4.4      | Hyperbolic disks and times . . . . .   | 44        |
| 4.5      | Construction of a reference leaf . . . . .   | 54        |
| 4.6      | Entropy formula . . . . .  | 57        |
| <b>5</b> | <b>Applications</b>  | <b>61</b> |
| 5.1      | Lorenz maps . . . . .  | 61        |
| 5.2      | Rovella maps . . . . .   | 66        |
| 5.3      | Luzzatto-Viana maps . . . . .  | 68        |
|          | <b>Appendix A Background from ergodic theory</b>                                   | <b>71</b> |
| A.1      | Entropy . . . . .  | 71        |
|          | <b>Appendix B Constructing Young structures</b>                                    | <b>75</b> |
| B.1      | Partition on the reference leaf . . . . .  | 75        |

|                   |  |           |
|-------------------|--|-----------|
| B.2               | The Young structure . . . . .                  | 82        |
| B.3               | Integrability of the recurrence time . . . . . | 83        |
| <b>References</b> |  | <b>87</b> |

# Chapter 1

## Introduction

The *modern theory of dynamical systems*, having its roots in the works of Poincaré on celestial mechanics at the end of the 19<sup>th</sup> century, can be broadly described as the study of the long-term behavior of processes evolving in time. Roughly speaking, two main ingredients compound what we call a dynamical system: first, a *phase space*, consisting of the several configurations the system can assume; second, an *evolution law*, i.e., a dynamical rule determining how a certain configuration is obtained from another in the course of time. The mathematical description of these processes can be done in either continuous or discrete terms, most commonly when they appear as flows associated to the solutions of differential equations (continuous time) or simply as iterations of maps (discrete time), respectively. We concern ourselves only with *discrete dynamics*, more precisely smooth maps  $f : M \rightarrow M$  defined on some compact Riemannian manifold  $M$ .

It soon became apparent that even very simple evolution laws may give rise to highly complex dynamical phenomena. Quite often, systems display the so-called *sensitivity to initial conditions* or *chaotic behavior*, roughly meaning that two initial configurations which are arbitrarily close to one another may diverge largely as the time passes by - in other words, the behavior of individual trajectories becomes *unpredictable*. It thus became one of the major goals of this theory to investigate the typical behavior of *most* orbits in some suitable sense, whenever that possibility was available. A successful approach in this regard is provided by *ergodic theory*, a further evolution of the dynamical systems' branch aiming at understanding systems from a probabilistic point of view. Here, the phase space is a probability space  $M$  endowed with an invariant measure  $\mu$  for the dynamics  $f : M \rightarrow M$ . A nontrivial property on its own, indeed, the existence of invariant measures founds one of its *raison d'être* in *Birkhoff's Ergodic Theorem*, a foundational result which describes from a statistical viewpoint the orbits of most points with respect to  $\mu$ .

For several purposes, the Lebesgue or volume measure still plays a prominent role and becomes a natural reference measure. Nevertheless, it turns out that the Lebesgue measure is not necessarily invariant, thus not fitting automatically into the ergodic theory natural setting. This simple observation triggered the question of determining the invariant measures (not necessarily ergodic) that bear some physical significance, that is, in a sense, the ones most compatible with volume when volume is not

preserved. In this context, the notion of *physical measure* emerged, a type of invariant measure that still describes the statistics of orbits with respect to initial conditions in a large (positive Lebesgue measure) set of the phase space. There are examples of systems without physical measures (e.g. the identity map) as well as examples with an infinite number of physical measures (e.g. Dirac measures supported on attracting periodic orbits), but these are somewhat pathological examples. The research program delineated in the *Palis conjecture* [60] aims at showing that typical dynamical systems admit at least one and at most a finite number of physical measures. Despite some and slow progress along the lines of the Palis conjecture, up to the present date, it is still a challenging and fundamentally open problem to determine which dynamical systems admit or not physical measures, let alone prove it.

A class of systems for which the Palis conjecture has already been proved is the class of *uniformly hyperbolic systems*. These are characterized by the existence of an invariant splitting of the tangent bundle for which the derivative contracts or expands uniformly on each of the invariant directions of that splitting. Actually, in between the end of the 1960's and the beginning of 1970's, Sinai, Ruelle and Bowen introduced and constructed a particular type of physical measures in the setting of uniformly hyperbolic attractors, encompassing Anosov diffeomorphisms, Axiom A diffeomorphisms and flows, that are nowadays called *Sinai-Ruelle-Bowen, or SRB, measures* in their honor; see [30, 31, 70, 73, 74]. To this end, an earlier approach fruitfully generalized some decades afterward was based on the introduction of rich geometric and combinatorial structures, called *Markov partitions*, which allowed to bring the techniques of symbolic dynamics into the theory of smooth uniformly hyperbolic dynamical systems; cf. [28]. Despite bearing the same significance as physical measures quite often in the literature, an interchange backed by the fact that the two notions actually coincide in the uniformly hyperbolic world, the distinguishing feature of SRB measures is the property of having non-zero Lyapunov exponents almost everywhere and absolutely continuous conditional measures on unstable manifolds. For the purposes of this thesis, to be detailed in the sequel, it is worth mentioning that, in this setting, SRB measures coincide with the ones satisfying an entropy formula, as pointed in the detailed exposition [78]. In the particular case of uniformly expanding systems, proving the existence of SRB measures can be reduced, by Birkhoff's Ergodic Theorem, to the problem of finding ergodic, absolutely continuous invariant measures - we refer the reader to [46], where the authors proved the existence of such measures for uniformly expanding maps.

Beyond the uniformly hyperbolic world, the dynamical picture is necessarily more complex, involving increasingly sophisticated new arguments and techniques. Some success has been obtained in the settings of *nonuniformly hyperbolic* and *partially hyperbolic* dynamics, often a combination of both. The necessity of combining these two beforehand distinct settings is in part grounded on the pioneering work of Pesin and Sinai [63], where so-called *Gibbs measures* were constructed for partially hyperbolic systems. While Gibbs measures provide a platform to investigate the existence of SRB measures, they may nevertheless fail to be physical because of the possible lack of absolute continuity or even existence of a foliation tangent to the central subbundle. The existence of SRB measures for a considerably large set of one-dimensional quadratic maps exhibiting non-uniformly expanding behavior has been established in the pioneer work of Jakobson [42]. Subsequently, in the



1980's and 1990's, M. Benedicks and L. Carleson, in the celebrated paper [22], studied using hard analysis (*a tour de force*) the dynamics near the well known Hénon attractors; afterward SRB measures for these attractors were constructed by M. Benedicks and L.S. Young in [23]. On the other hand, SRB measures corresponding to nonhyperbolic attractors of derived from Anosov diffeomorphisms were constructed by M. Carvalho in [33]. Later, M. Viana introduced in [75] an open class of chaotic maps in higher dimensions with non-uniformly expanding behavior, and J. F. Alves, making use of the original notion of *hyperbolic times*, proved in [2] the existence of SRB measures for these maps. Motivated by these results, Alves, Bonatti and Viana obtained general conclusions on the existence of SRB measures for partially hyperbolic systems with *mostly expanding central direction* [5] and *mostly contracting central direction* [27], conditions which couple nonuniform and partially hyperbolic behaviors as referred to in the beginning of the paragraph.

An important breakthrough along this research line of systems with some sort of hyperbolicity occurred about two decades ago in L. S. Young papers [76, 77]. There, she introduced a type of Markov partitions that generalized, and were much less rigid than, the classical Markov partitions used by Sinai, Ruelle and Bowen, in basically three main aspects: they are characterized by some (not the whole) region of the phase space partitioned into an at most countable (not necessarily finite) number of subsets with associated (variable, not fixed, depending on the partition element) return times. This abstract setting is, up to this date, one of the most powerful frameworks to study nonuniformly hyperbolic dynamical systems, yielding not only the existence of SRB measures as well as several of their statistical properties like the Decay of Correlations, Large Deviations and probabilistic Limit Theorems. As a matter of fact, in the original paper [76], the existence of these structures was shown for some classical dynamics previously mentioned, including Axiom A attractors, billiards with convex scatterers, logistic maps, intermittent maps, piecewise hyperbolic maps and Hénon-like attractors; for the latter, see also [24]. This approach was successfully carried out afterward by Alves, Luzzatto and Pinheiro in the context of partially hyperbolic systems and general systems with critical or singular sets [8, 9, 13, 64]; the existence of SRB measures was already known via the classical *geometric-pushforward* approach, where they are realized as limit points of Birkhoff's averages of the Lebesgue measure restricted to some suitable region of  $M$ , typically where we can guarantee some expansion. In the recent survey [34], Climenhaga, Luzzatto and Pesin provide an excellent exposition on the several methods to construct SRB measures ranging from the more classical works mentioned above to a new general framework based on the notion of *effective hyperbolicity*.

The concept of dynamical *entropy* was successfully introduced by Kolmogorov and Sinai [45] around 1958, based on the analogous notion proposed by C. Shannon in Information Theory. In broad terms, this quantity measures the rate of increase in dynamical complexity as the system is iterated in time and thus relates to the unpredictability of the system. A first, very natural question arising from the actual definition was the computation of this number for concrete systems, - a question treated by Kolmogorov and Sinai themselves in their celebrated theorem concerning *generating partitions* - finding one of its first answers in the *Rokhlin formula*, which expresses the entropy in terms of the integral of the Jacobian for general invariant measures, and in related subsequent works [1, 26, 49]).

For the setting of smooth diffeomorphisms of a Riemannian manifold, Ruelle established in [71] that the entropy of any invariant probability measure is always bounded by the integral of the sum of the positive Lyapunov exponents (counted with multiplicity) with respect to that measure. The reverse inequality has been obtained in [62] by Pesin for the case when the invariant probability measure is absolutely continuous with respect to the Lebesgue measure and also in a simpler, ingenious way by R. Mañé in [56]. There is currently a vast literature addressing Pesin's entropy formula. For instance, extensions of the results of Ruelle and Pesin for the class of maps with infinite derivative inspired on billiards and introduced in [43] were obtained in [48], and a characterization of the validity of the entropy formula in terms of the so-called SRB property is given in [50]; cf. also [79]. Natural versions for non-invertible smooth maps (endomorphisms) have been drawn in [51, 53, 65]. Albeit, to the best of our knowledge, besides the recent work [14], not much is known on the existence of entropy formulas that can be applied directly to smooth maps with singular sets in general, specially in dimensions greater than one (for one-dimensional dynamical systems, see e.g. [25], [44] or [47], and, in higher dimensions, see e.g. [36]). In this regard, let us refer that, in the Markov case of piecewise expanding maps with full branches, a direct approach as in [10] can be implemented to obtain an entropy formula and it will be further explored in this work.

Regarding the integral term in Pesin entropy formula, we are naturally lead to consider the case where all Lyapunov exponents are positive and the sum of Lyapunov exponents coincides with the *Jacobian* of the map or, more generally, the sum of Lyapunov exponents coincides with the *unstable Jacobian*, i.e., along the unstable direction, in case of systems displaying contracting behavior along some directions. The main contribution of this work is thus to extend the classes of systems with singularities, fitting the previous two scenarios, for which it holds an entropy formula resembling that appearing in the classical literature. More precisely, the classes we address here were introduced in the seminal work [5]: the first consisting of general endomorphisms of a compact Riemannian manifold, and the second of partially hyperbolic diffeomorphisms - both having a singular set satisfying some nondegeneracy conditions. The original construction of SRB measures for these classes - essentially pointed out and not carried thoroughly until the end for the latter - followed the so-called *geometric-pushforward approach* aforementioned. Notwithstanding, it turns out that such SRB measures can also be lifted to Markov structures, a nontrivial fact essentially well known from the works [9, 64] for the endomorphism case but not for the partially hyperbolic systems with singularities inspired on the Lorenz attractor that constitute one of the *leitmotifs* of this thesis. Owing to their symbolic nature, the existence of these structures is actually the fundamental tool to overcome the presence of singularities and deduce an entropy formula in this context as indeed we do, so that the approach to be used here may in principle be carried out whenever this condition (or any other equivalent to this one) is ensured.

Before ending this introduction, we would like to allude to the problem of the variation of the *entropy of the physical or SRB measures* - henceforth referred to simply as *physical or SRB entropy* -, in parametrized families of systems admitting them, i.e., how that quantity changes as a function of the parameter (system) in the family. Despite being beyond the scope of the present work, we remark that the *validity of the entropy formula* similar to the ones we obtain here together with the

---

*statistical stability* of the systems has been a mainstream ingredient to deduce results concerning the *continuity of the physical or SRB entropy* in several relevant parametrized families, including, for instance, the Benedicks-Carleson quadratic maps, Hénon-maps, Tent and Viana maps (see e.g. [6, 7, 10, 14, 15, 21, 39]), which often use in a significant way the boundedness of the derivative. Therefore, we hope the results in this paper may at least open the door to deepen the study on the problem of the entropy variation for systems with singularities, in particular for the families of endomorphisms with singularities we consider in the applications.

After the present introduction which is the content of Chapter 1, this work is organized as follows:

In Chapter 2, we present the main results of this thesis and the necessary definitions to do it. In Section 2.1, we start with a general class of not necessarily invertible systems with singularities coming from [5] and stating an entropy formula for them, and then, in Section 2.2, introduce a class of partially hyperbolic diffeomorphisms with singularities (also coming from [5]) drawing its main inspiration from the model of two-dimensional Poincaré return maps of Lorenz flows. In the latter, we state not only an entropy formula as well as the existence of Young structures which sustain the SRB measures and provide the suitable background for the calculation of their entropy.

In Chapter 3, we prove the entropy formula for the first class of systems with singularities. We give an overview of the strategy in Section 3.3, strongly dependent upon the classical Gibbs-Markov structures we introduce in Section 3.1. The existence of these structures for the maps we consider in this chapter, stated in Theorem 3.3.1, is well known from the works [9, 64], but we recover this result here under a general framework to be used in the next chapter for the partially hyperbolic case. The entropy formula is then stated under general conditions (mainly, the existence of Markov structures) in Proposition 3.3.5. Our approach consists in using a tower extension of the Gibbs-Markov inducing scheme, as in Section 3.2, deriving an entropy formula for the tower, which we do in Section 3.4, and finally relate back the entropies of these two semi-conjugated systems in Section 3.5.

In Chapter 4, the spirit is the same as that of the previous chapter, but with increased complexity. In addition to the work done in the previous chapter, where the existence of inducing schemes for a class of systems with singularities was essentially contained in previous literature, here the main focus is on the construction of *Young structures* that we review in Section 4.1, playing the same role for these systems as the Gibbs-Markov structures do for the previous. A main difference between them is the presence of contracting directions so that the return of the partition elements only needs to stretch all the way over along the unstable direction, i.e., it does not need to be a *full return* in the previous sense. The general framework for the construction of Young structures is then provided in Section 4.3. Accordingly, the relevant work consists of the construction of so-called hyperbolic disks and times for these maps as well as that of a reference leaf serving as the basis of the Young structure, which is done in Sections 4.4 and 4.5, respectively. We postpone to Appendix B the partitioning algorithm of the reference leaf and other more or less standard check-ups, as these do not contain any particular novelty or require substantial adaptations in this setting; however, the construction in [8, Section 5] from where it is drawn is improved here, in the sense that clearer satellite estimates are provided and it serves as well for the purpose of the construction of Gibbs-Markov structures for endomorphisms.

In order to derive an entropy formula, we essentially make use of the results and line of attack of the previous chapter, but with more sophisticated tools. We introduce the *quotient dynamics*, obtained, roughly speaking, by collapsing stable leaves, and associated tower extension in Section 4.2. More importantly, in Section 4.2, we present the notion of *natural extension*, which is, in other words, the formal way to express or deduce the heuristic and a priori expected idea that such collapsing procedure - which neglects only the stable direction where no new dynamical information is produced - preserves the entropy. We conclude the reasoning in Section 4.6.

In Chapter 5, we present three families of systems with singularities that enable an illustration of our main theorems, namely: Lorenz maps, both one-dimensional and two-dimensional (Section 5.1), Rovella maps (Section 5.2) and Luzzatto-Viana maps (Section 5.3). To the best of our knowledge, entropy formulas for the maps in these families are not yet clearly established in previous literature and pave the way to approach the problem of the variation of the SRB entropy.

In Appendix A, we briefly review some elementary concepts of ergodic theory, in particular, the notion of *metric* or *measure-theoretic* or *Kolmogorov-Sinai entropy* [45] of a measure-preserving dynamical system and some useful related results for the purposes of this thesis. The core of Appendix B was already exposed.

## Chapter 2

# Definitions and statements

In this chapter, we present the main results of this thesis and the necessary definitions to do it. We start with a general class of endomorphisms with singularities and then introduce a class of partially hyperbolic diffeomorphisms with singularities, drawing its main inspiration from the model of two-dimensional Poincaré return maps of Lorenz flows, both outlined in [5]. In the latter, we state not only an entropy formula as well as the existence of Young structures which sustain the SRB measures and provide the suitable background for the calculation of their entropies.

### 2.1 Expanding endomorphisms with singular sets

Let  $M$  be a compact Riemannian manifold of dimension  $d \in \mathbb{N}$  and  $\text{Leb}$  denote the reference normalized Riemannian or Lebesgue measure defined on the Borel  $\sigma$ -algebra of  $M$ . Let  $f : M \rightarrow M$  be an endomorphism which is  $C^{1+}$  local diffeomorphism (meaning that  $f$  is a  $C^1$  with Hölder continuous derivative) out of a (nonempty) compact submanifold  $\mathcal{S}$  of  $M$  with  $\dim(\mathcal{S}) < \dim(M)$  that we shall refer to as the *singular set* of  $f$ . As the name suggests, this set consists of *singular points* or *singularities*, i.e., points  $x_0 \in M$  at which  $Df(x_0)$  is not defined. For instance, singularities appear if  $\|Df\|$  is unbounded near  $x_0$  or else  $f$  fails to be continuous at  $x_0$ . Given  $x \in M \setminus \mathcal{S}$ , we define the *minimum norm* as

$$m(Df(x)) := \inf_{\|v\|=1} \|Df(x) \cdot v\|,$$

a number easily seen to be equal to  $\|Df(x)^{-1}\|^{-1}$  in the present setting, since  $Df(x)$  is invertible. In this work, we require that  $\mathcal{S}$  satisfies the non-degeneracy conditions indicated in the next definition.

#### Nondegeneracy of a set

We say that a subset  $\mathcal{S}$  of  $M$  is *nondegenerate* (with respect to  $f$ ) if both  $\mathcal{S}$  and  $f(\mathcal{S})$  have zero Lebesgue measure and there are constants  $\alpha, \beta, B > 0$  such that:

1. for every  $x \in M \setminus \mathcal{S}$ , we have

$$B^{-1} \text{dist}(x, \mathcal{S})^\alpha \leq m(Df(x)) \leq \|Df(x)\| \leq B \text{dist}(x, \mathcal{S})^{-\alpha}.$$

2. for any  $x, y \in M \setminus \mathcal{S}$  with  $\text{dist}(x, y) < \text{dist}(x, \mathcal{S})/2$  we have,

$$\begin{aligned} \text{(a)} \quad & |\log \|Df(y)^{-1}\| - \log \|Df(x)^{-1}\| \leq \frac{B}{\text{dist}(x, \mathcal{S})^\alpha} \text{dist}(x, y)^\beta, \\ \text{(b)} \quad & |\log |\det Df(y)| - \log |\det Df(x)| \leq \frac{B}{\text{dist}(x, \mathcal{S})^\alpha} \text{dist}(x, y)^\beta. \end{aligned}$$

*Remark 2.1.1.* Observe that the first condition is only significant when the norm of the derivative of  $f$  is unbounded (below or above) near  $\mathcal{S}$ , providing in that case analytic information about the *order* of the (singular) set. The last two conditions say that the functions  $\log |\det Df|$  and  $\log \|Df^{-1}\|$  are locally Hölder at points  $x \in M \setminus \mathcal{S}$ , with the Hölder constant possibly getting worse as  $x$  approaches  $\mathcal{S}$ . Notice that if  $\dim(M) = 1$ , conditions 2.(a) and 2.(b) express the same property.

*Remark 2.1.2.* The original definition of nondegenerate set was meant to allow the possibility of including *critical points* in  $\mathcal{S}$ , i.e., points at which  $Df$  is defined but not invertible. Our results remain valid in that case since all that matters in this regard is that the nondegeneracy conditions hold true for the critical points as well. Despite the fact that some of our applications exhibit critical points, the focus of this work and its main novelty lies on the singular ones. Indeed, in the absence of singularities, i.e., when differentiability is not an issue, the classical research literature on entropy covers the situation completely [51, 65, 66].

### Nonuniform expansion and slow recurrence

In the definitions that follow, we will be implicitly assuming that the forward orbits of points in some set  $H$  do not hit the singular set  $\mathcal{S}$ . In general, if a set  $H$  does not satisfy this property, we can always consider a subset  $H^+$  of  $H$  with the same Lebesgue measure satisfying it, namely,  $H^+ := \bigcap_{n=0}^{\infty} f^{-n}(H \setminus \mathcal{S})$ . For this reason, we may assume without loss of generality that  $H$  is itself forward invariant. Such assumption is reinforced by the fact that the properties expressed in the definitions below are morally invariant under forward and backward iteration, i.e., modulo some technical assumptions like the precedent one to ensure that certain quantities appearing in these definitions are well-defined in the presence of a singular set.

We say that  $f$  is *nonuniformly expanding (NUE)* on a subset  $H$  of  $M$  if there is  $\lambda > 0$  such that for all  $x \in H$ ,

$$\liminf_{n \rightarrow \infty} \frac{1}{n} \sum_{j=0}^{n-1} \log \|Df(f^j(x))^{-1}\| < -\lambda. \quad (2.1)$$

Alternatively, we may express the condition (2.1) as follows:

$$\limsup_{n \rightarrow \infty} \frac{1}{n} \sum_{j=0}^{n-1} \log \|Df(f^j(x))^{-1}\|^{-1} > \lambda. \quad (2.2)$$

*Remark 2.1.3.* In dimension one, (2.2) is equivalent to the existence of a positive Lyapunov exponent at  $x$ . In higher dimensions, all one can say is that nonuniform expansion at a point  $x \in M$  implies the existence of  $\dim(M)$  positive Lyapunov exponents at  $x \in M$ :

$$\limsup_{n \rightarrow \infty} \frac{1}{n} \log \|Df^n(x) \cdot v\| > \lambda > 0, \text{ for all } v \in T_x M, \quad (2.3)$$

a strictly weaker property than nonuniform expansion, in general.

*Remark 2.1.4.* In the original paper [5], the authors considered a stronger notion of nonuniform expansion by replacing the limsup with the liminf in the definition above: more precisely, we say that  $f$  is **strongly nonuniformly expanding** on a subset  $H$  of  $M$  if there is  $\lambda > 0$  such that for all  $x \in H$ ,

$$\limsup_{n \rightarrow \infty} \frac{1}{n} \sum_{j=0}^{n-1} \log \|Df(f^j(x))^{-1}\| < -\lambda. \quad (2.4)$$

Our techniques rely on the existence of inducing schemes for such maps, a property that can be guaranteed under the weaker form of nonuniform expansion in (2.1); cf. [64].

Given  $r > 0$  and  $x \in M \setminus \mathcal{S}$ , we define the  $r$ -truncated distance from  $x$  to  $\mathcal{S}$  as

$$\text{dist}_r(x, \mathcal{S}) = \begin{cases} 1, & \text{if } \text{dist}(x, \mathcal{S}) \geq r. \\ \text{dist}(x, \mathcal{S}), & \text{otherwise.} \end{cases} \quad (2.5)$$

The careful reader might note that this is not a distance in the usual sense, but only a useful quantity derived from it. We say that  $f$  has *slow recurrence to the singular set*  $\mathcal{S}$  on a subset  $H$  of  $M$ , if for every  $\varepsilon > 0$  there exists  $r > 0$  such that for every  $x \in H$  we have

$$\limsup_{n \rightarrow \infty} \frac{1}{n} \sum_{j=0}^{n-1} -\log \text{dist}_r(f^j(x), \mathcal{S}) < \varepsilon. \quad (2.6)$$

*Remark 2.1.5.* As observed in several previous works involving the slow recurrence, we do not need to impose this condition in all its strength, i.e., for all  $\varepsilon > 0$ : it suffices that (2.6) holds for some  $\varepsilon^* > 0$  sufficiently small.

## Main results

Given a Borel probability measure  $\mu$  on  $M$  we define the *basin of*  $\mu$  as the set

$$\mathcal{B}_\mu := \{x \in M : \lim_{n \rightarrow \infty} \frac{1}{n} \sum_{j=0}^{n-1} \phi(f^j(x)) = \int \phi d\mu \text{ for all continuous } \phi : M \rightarrow \mathbb{R}\}. \quad (2.7)$$

Roughly speaking, the basin of a measure  $\mu$  is the set of points in the phase space whose orbits under  $f$  are asymptotically uniformly distributed with respect to  $\mu$  and are thus well-understood in statistical terms. A priori, there is no reason for the basin to be a nonempty set. Under certain conditions, this

is indeed the case and it is actually a large set with respect to the volume or Lebesgue measure. For instance, the classical Ergodic Theorem of Birkhoff, together with the fact that  $C^0(M)$  has a countable dense set, implies that if  $\mu$  is an ergodic invariant probability measure, then  $\mu$ -almost every point belongs in the basin of  $\mu$ . Besides, if  $\mu$  is absolutely continuous with respect to the Lebesgue measure, then we immediately conclude that the basin of  $\mu$  has positive Lebesgue measure. On the other hand, if  $\mu$  is singular with respect to Lebesgue measure, which happens frequently, this does not guarantee beforehand that the basin has positive Lebesgue measure. These contrasting scenarios motivate the following definition: a measure  $\mu$  is called *physical* if

$$\text{Leb}(\mathcal{B}_\mu) > 0. \quad (2.8)$$

The existence of a finite collection of ergodic absolutely continuous invariant (hence physical) probability measures

$$\mathcal{F}_f := \{\mu_1, \dots, \mu_l\} \quad (2.9)$$

for each map  $f$  in the first class of systems with critical/singular sets that we consider in this section is well known in the literature since [5]. In addition, a striking and non-trivial feature of these measures is that they can be associated with a particular type of geometrical and combinatorial structures, which we call *Gibbs-Markov* [8, 9, 64]. The precise definition of these structures is actually not needed for the formulation of the main result and, in order to keep this presentation as simple as possible, it will be postponed to Chapter 3, where related comments on their existence for this class of systems can be found. The reason why we highlight this fact in the presentation relates to the goal of providing the reader with the underlying idea of the heart of our strategy: first, we derive an entropy formula for the Markov structures of these measures and then pass the information down to original system. We will illustrate Theorem A below with some concrete applications in Chapter 5.

**Theorem A.** *Let  $f : M \rightarrow M$  be a  $C^{1+}$  local diffeomorphism out of a nondegenerate set  $\mathcal{S} \subset M$ . Assume that there exists a positive Lebesgue measure set  $H \subset M$  on which  $f$  is non-uniformly expanding and has slow recurrence to  $\mathcal{S}$ . Then, for any measure  $\mu \in \mathcal{F}_f$ , we have*

$$h_\mu(f) = \int \log |\det Df| d\mu. \quad (2.10)$$

*Remark 2.1.6.* Observe that the integrand term in (2.10) is measurable and well defined outside  $\mathcal{S}$ , a zero Lebesgue (and thus  $\mu$ ) measure set. A natural question that may be prompted is whether or not the integral in (2.10) is finite. In [51, Remark 1.2], it is proved that the *integrability condition*

$$\log |\det Df| \in L^1(\mu) \quad (2.11)$$

is automatically verified whenever  $f$  is a  $C^2$  smooth map of a  $C^\infty$  compact Riemannian manifold and  $\mu$  is an  $f$ -invariant probability measure absolutely continuous with respect to the Lebesgue measure. In our setting, it is a rather straightforward consequence of the definition of nondegenerate set that (2.11)



holds for any  $\mu \in \mathcal{F}_f$ . Indeed, from the condition (1), it follows that for every  $x \in M \setminus \mathcal{S}$  we have

$$B^{-d} \operatorname{dist}(x, \mathcal{S})^{\alpha d} \leq m(Df(x))^d \leq |\det Df(x)| \leq \|Df(x)\|^d \leq B^d \operatorname{dist}(x, \mathcal{S})^{-\alpha d}. \quad (2.12)$$

Taking logarithms,

$$0 \leq |\log |\det Df(x)|| \leq d |\log B| + \alpha d |\log \operatorname{dist}(x, \mathcal{S})|. \quad (2.13)$$

By the fact that  $d\mu/d\operatorname{Leb} \in L^\infty(\operatorname{Leb})$  and invoking, for instance, [4, Proposition 4.1, Corollary 4.2], we conclude that the function  $\log \operatorname{dist}(\cdot, \mathcal{S})$  is  $\mu$ -integrable and therefore (2.11) follows from (2.13). It should not be neglected that the same argument yields the integrability of the derivatives:

$$\log \|Df^{\pm 1}\| \in L^1(\mu), \quad (2.14)$$

a useful condition to guarantee the existence (and finiteness) of Lyapunov exponents in the light of Oseledets Theorem.

## 2.2 Partially hyperbolic diffeomorphisms with singular sets

Now, we consider a second class of systems with singularities inspired on Poincaré return maps of Lorenz flows. Let  $M$  be a compact Riemannian manifold, possibly with boundary, of dimension  $d \in \mathbb{N}$ , and  $\operatorname{Leb}$  denote the normalized Riemannian or Lebesgue measure defined on the Borel  $\sigma$ -algebra of  $M$ . Let  $f: M \rightarrow M$  be a  $C^{1+}$  diffeomorphism (meaning that  $f$  is  $C^1$  with Hölder continuous derivative) out of a compact submanifold  $\mathcal{S}$  of  $M$  with  $\dim(\mathcal{S}) < \dim(M)$  that we shall refer to as the *singular set of  $f$* . As in the previous chapter, this set may consist of points  $x_0 \in M$  at which  $Df(x_0)$  is not defined, so-called *singular points*, either because  $\|Df\|$  is unbounded near  $x_0$  or  $f$  is not continuous at  $x_0$ . Before we present the nondegeneracy conditions of  $\mathcal{S}$  adapted to this situation, we need to introduce the notion of *partial hyperbolicity* upon which they depend.

### Partial hyperbolicity

We say that a compact subset  $K \subseteq M$  with  $\operatorname{Leb}(K) > 0$  is a *partially hyperbolic set* for  $f$  if it is forward invariant, in the sense that  $f(K \setminus \mathcal{S}) \subset K$ , and there is a continuous splitting of the tangent bundle  $T_{K \setminus \mathcal{S}} M = E^{cu} \oplus E^{ss}$  such that

$$Df(E_x^*) \subseteq E_{f(x)}^* \text{ for } x \in K \setminus \mathcal{S} \cap f^{-1}(K \setminus \mathcal{S}) \text{ and } * \in \{cu, ss\} \quad (2.15)$$

and, for some choice of a Riemannian metric  $\|\cdot\|$  on  $M$ , there is a constant  $0 < \lambda < 1$  such that:

1.  $E^{ss}$  is strongly (uniformly) contracting:  $\|Df|_{E_x^{ss}}\| \leq \lambda < 1$  for all  $x \in K \setminus \mathcal{S}$ ;
2.  $E^{cu} \oplus E^{ss}$  is dominated:  $\|Df|_{E_x^{ss}}\| \cdot \|Df^{-1}|_{E_{f(x)}^{cu}}\| \leq \lambda < 1$  for all  $x \in K \setminus \mathcal{S} \cap f^{-1}(K \setminus \mathcal{S})$ .

We stress that in spite of the fact that the above conditions are naturally dependent upon the choice of Riemannian metric, it is enough that they are verified for some such choice. With regards to nomenclature,  $E^{cu}$  is called the *centre-unstable bundle* and  $E^{ss}$  is called the *strong-stable bundle*. Owing to the presence of a singular set, in addition to the usual conditions described above, we require two additional properties that are standard for partially hyperbolic systems (without singularities) but we are not sure about to what extent they hold true in more general situations as in the present one:

(E<sub>1</sub>) *Transversality of the dynamical bundles*: the angle between the bundles  $E^{cu}$  and  $E^{ss}$ , set to

$$\angle(E^{cu}, E^{ss}) := \min_{x \in K \setminus \mathcal{S}} \min_{v_u \in E_x^{cu}, v_s \in E_x^{ss}} \angle(v_u, v_s),$$

is strictly positive.

(E<sub>2</sub>) *Existence of long stable manifolds*: There is  $\delta_s > 0$  such that the local stable manifolds  $W_\delta^s(x)$  are defined for all points  $x \in K \setminus \mathcal{S}$  and  $0 \leq \delta \leq \delta_s$ .

*Remark 2.2.1.* Despite that being the case in the two-dimensional Poincaré return maps of Lorenz flow that we consider in Chapter 5, in general,  $K \setminus \mathcal{S}$  is not assumed to contain any open sets. Since our techniques require that we work with open regions  $\Sigma$  of the ambient space where these bundles are defined, we therefore assume the existence of continuous extensions of the bundles, still denoted  $E^{cu}$  and  $E^{ss}$ , to some compact neighbourhood  $\mathcal{V}$  of  $K \setminus \mathcal{S}$ , containing a  $\delta_1$ -neighbourhood of  $K \setminus \mathcal{S}$  for some  $\delta_1 > 0$  to be specified later. It should be noted that we are assuming the possibility to extend the bundles to  $\mathcal{S}$ , but, for self-evident reasons, we are not requiring that  $Df$  can be extended in a similar fashion. Actually, this is immaterial since even in case our *working regions*  $\Sigma$  or their iterates intersect the singular set, we will just consider sub-regions where that does not happen and so be able to take the derivative  $Df$ . For simplicity, we assume that  $\mathcal{V}$  is forward invariant: for instance, it may be thought as a *trapping region* for an attractor.

### Cone fields

The extensions  $E^{cu}$  and  $E^{ss}$  are not a priori assumed to be invariant outside  $K \setminus \mathcal{S}$  as in (2.15), but we can still derive some sort of invariance if we allow more freedom in the dynamic directions. Given  $0 < a < 1$ , we define the *centre-unstable cone field*  $C_a^{cu} = (C_a^{cu}(x))_{x \in \mathcal{V}}$  of width  $a$  by

$$C_a^{cu}(x) := \{v_u + v_s \in E_x^{cu} \oplus E_x^{ss} : \|v_s\| \leq a \|v_u\|\} \subset T_x M. \quad (2.16)$$

Analogously, we define the *strong-stable cone field*  $C_a^{ss} = (C_a^{ss}(x))_{x \in \mathcal{V}}$  of width  $a$  in a similar way, just reversing the roles of the sub-bundles in (2.16). We fix  $a > 0$  and  $\mathcal{V}$  small enough so that, up to slightly increasing  $\lambda$ , the domination condition (2) remains valid in the two cone fields:

$$\|Df(x) \cdot v^{ss}\| \cdot \|Df^{-1}(f(x)) \cdot v^{cu}\| \leq \lambda < 1 \quad (2.17)$$

for every point  $x \in \mathcal{V}$  and  $v^{ss} \in C_a^{ss}(x)$ ,  $v^{cu} \in C_a^{cu}(f(x))$ . Under the above conditions, the centre-unstable cone field is forward invariant:

$$Df(x) \cdot C_a^{cu}(x) \subseteq C_a^{cu}(f(x)), \text{ for all } x \in \mathcal{V} \setminus \mathcal{S}. \quad (2.18)$$

Let  $\Sigma$  be a submanifold of  $M$ , possibly with boundary. We denote by  $\text{dist}_\Sigma$  and  $\text{Leb}_\Sigma$ , respectively, the distance and Lebesgue measure on the Borel sets of the submanifold  $\Sigma$ , both induced by the Riemannian metric on  $M$ . The boundary of  $\Sigma$  is denoted by  $\partial\Sigma$  and the distance from a point  $x \in \Sigma$  to its boundary is set to  $\text{dist}_\Sigma(x, \partial\Sigma) := \inf_{y \in \partial\Sigma} \text{dist}_\Sigma(x, y)$ . We say that an embedded  $C^1$  manifold  $\Sigma \subset \mathcal{V}$  is a *centre-unstable disk*, abbreviated to *cu-disk*, if  $T_x\Sigma$ , the tangent space to  $\Sigma$  at a point  $x \in \Sigma$ , is contained in the corresponding cone  $C_a^{cu}(x)$ . Observe that the property (2.18) implies that given any subdisk  $\Delta_0$  of a *cu-disk*  $\Sigma$ , we have that  $f(\Delta_0)$  is a *cu-subdisk* of  $f(\Sigma) \subset \mathcal{V}$ . Given  $x \in K \setminus \mathcal{S}$ , we define the usual sup- and inf- norms of  $Df|E_x^{cu}$  as

$$\|Df|E_x^{cu}\| = \sup_{\|v\|=1} \|Df|E_x^{cu}(v)\| \text{ and } m(Df|E_x^{cu}) := \inf_{\|v\|=1} \|Df|E_x^{cu}(v)\|. \quad (2.19)$$

Again, we have  $m(Df|E_x^{cu}) = \|(Df|E_x^{cu})^{-1}\|^{-1}$  in the present setting owing to the fact that  $Df|E_x^{cu}$  is invertible.

*Remark 2.2.2.* We opt for the notation  $(Df|E_x^{cu})^{-1}$  to denote the inverse map of  $Df|E_x^{cu} : E_x^{cu} \rightarrow E_{f(x)}^{cu}$ . Notice that it may happen that  $f(x)$  belongs in the singular set  $\mathcal{S}$  and therefore  $Df^{-1}|E_{f(x)}^{cu}$  is not necessarily defined. Of course, when  $f(x) \notin \mathcal{S}$ , we naturally have  $(Df|E_x^{cu})^{-1} = Df^{-1}|E_{f(x)}^{cu}$  and consequently  $m(Df|E_x^{cu}) = \|Df^{-1}|E_{f(x)}^{cu}\|^{-1}$ . Alternatively, when  $x \notin f(\mathcal{S})$ , the singular set of  $f^{-1}$ , we have  $Df^{-1}|E_x^{cu} = (Df|E_{f^{-1}(x)}^{cu})^{-1}$ .

### Nondegeneracy of a set

In the partially hyperbolic setting, we say that a set  $\mathcal{S}$  as above is *non-degenerate* (with respect to  $f$ ) if both  $\mathcal{S}$  and  $f(\mathcal{S})$  have zero Lebesgue measure and there are constants  $\alpha, \beta, B > 0$  such that:

1. for every  $x \in K \setminus \mathcal{S}$ , we have

$$B^{-1} \text{dist}(x, \mathcal{S})^\alpha \leq m(Df|E_x^{cu}) \leq \|Df|E_x^{cu}\| \leq B \text{dist}(x, \mathcal{S})^{-\alpha};$$

2. for any centre-unstable disk  $\Sigma \subset \mathcal{V}$  and  $x, y \in \Sigma$  with  $\text{dist}_\Sigma(x, y) < \text{dist}(x, \mathcal{S})/2$ , we have

- (a)  $|\log \|(Df|T_y\Sigma)^{-1}\| - \log \|(Df|E_x^{cu})^{-1}\| \leq \frac{B}{\text{dist}(x, \mathcal{S})^\alpha} \text{dist}_\Sigma(x, y)^\beta$ , and
- (b)  $|\log |\det Df|T_y\Sigma| - \log |\det Df|T_x\Sigma| \leq \frac{B}{\text{dist}(x, \mathcal{S})^\alpha} \text{dist}_\Sigma(x, y)^\beta$ .

These conditions are entirely analogous to those in Section 2.1, but here we account only for the behavior of  $f$  along the centre-unstable direction.

### Nonuniform expansion and slow recurrence

In the definitions below, we will need to consider points  $x \in K$  for which the entire forward orbit  $\{f^n(x)\}_{n \geq 0}$  is well defined, meaning that  $f^n(x) \notin \mathcal{S}$  for all  $n \geq 0$ . Strictly speaking, such points belong to a smaller subset of  $K$ , namely,

$$K^+ := \bigcap_{n=0}^{\infty} f^{-n}(K \setminus \mathcal{S}),$$

which could happen to be too small in the sense of having zero Lebesgue measure. Since we are assuming that  $\text{Leb}(\mathcal{S}) = 0$  we still have  $\text{Leb}(K^+) = \text{Leb}(K) > 0$ . For this reason and in order to avoid unnecessary notational complexity, we will keep writing  $K$  instead of  $K^+$ . We say that  $f$  is *nonuniformly expanding (NUE) along the centre-unstable direction on a set  $H \subseteq K$*  if there is  $\lambda > 0$  such that for all  $x \in H$ ,

$$\liminf_{n \rightarrow \infty} \frac{1}{n} \sum_{j=1}^n \log \|Df^{-1}|E_{f^j(x)}^{cu}\| < -\lambda. \quad (2.20)$$

or equivalently,

$$\limsup_{n \rightarrow \infty} \frac{1}{n} \sum_{j=1}^n \log \|Df^{-1}|E_{f^j(x)}^{cu}\|^{-1} > \lambda.$$

*Remark 2.2.3.* As before, the notion of NUE admits a stronger version, simply replacing the  $\liminf$  by the  $\limsup$  in the definition: more precisely, we say that  $f$  is *strongly non-uniformly expanding along the centre-unstable direction on a set  $H \subseteq K$*  if there is  $\lambda > 0$  such that for all  $x \in H$ ,

$$\limsup_{n \rightarrow \infty} \frac{1}{n} \sum_{j=1}^n \log \|Df^{-1}|E_{f^j(x)}^{cu}\| < -\lambda.$$

Owing to this reason, a map  $f$  satisfying (2.20) may be called *weakly nonuniformly expanding* (see e.g. [8]).

Exactly in the same way, we say that  $f$  has *slow recurrence to  $\mathcal{S}$*  on a set  $H \subseteq M$ , if for every  $\varepsilon > 0$  there exists  $r > 0$  such that for every  $x \in H$  we have

$$\limsup_{n \rightarrow \infty} \frac{1}{n} \sum_{j=0}^{n-1} -\log \text{dist}_r(f^j(x), \mathcal{S}) < \varepsilon, \quad (2.21)$$

with the truncated distance  $\text{dist}_r$  as in (2.5). Again, we don't need the slow recurrence condition in all its strength, i.e., for all  $\varepsilon > 0$ : it will be enough that (2.21) holds for some  $\varepsilon^* > 0$  sufficiently small.

### Main results

We now present the main results concerning this type of maps, having their seminal form proposed in [5, final comments in Section 5]. A particular type of physical measures are the so-called *Sinai-Ruelle-Bowen, or SRB, measures*, which have the property of having a positive Lyapunov exponent almost everywhere and admitting a Rokhlin decomposition of conditional measures on Pesin's unstable

manifolds that are absolutely continuous with respect to the Lebesgue measures on these manifolds. The first part of our main results in this section (Theorem B) concerns the existence and finiteness of ergodic physical SRB measures and may be regarded as the natural counterpart of [8, Theorem A] for the class of partially hyperbolic systems *with singularities* just introduced. The proof requires nontrivial technical adaptations in the corresponding arguments for the partially hyperbolic case owed to the presence of a singular set, properly addressed in Chapter 4, thus granting Theorem B some novelty despite the two statement's similarity.

The main ingredient is the construction of a finite collection of nontrivial combinatorial and geometric structures which we call *Gibbs-Markov-Young, or just Young, structures* for  $f$  [76]. We postpone the quite involved description of such mathematical objects to Chapter 4 but, for the purposes of the formulation of the statement, we just mention that such structures consist of an *induced map*  $F = f^R : \Lambda \rightarrow \Lambda$ , defined on some set  $\Lambda \subset M$  by a, generally unbounded, *recurrence time function*  $R : \Lambda \rightarrow \mathbb{N}$  yet satisfying a control condition that we call *the integrability of the return times*. Classical results then imply the existence of the aforementioned SRB measures for the original system associated with Young structures with integrable return times, a process to be described more thoroughly in Chapter 4. The global picture is given below.

**Theorem B.** *Let  $f : M \rightarrow M$  be a  $C^{1+}$  diffeomorphism outside a non-degenerate singular set  $\mathcal{S}$  and  $K \subseteq M$  a partially hyperbolic set for  $f$ . Suppose moreover that there exists a positive Lebesgue measure set  $H \subseteq K$  on which  $f$  is nonuniformly expanding along the centre-unstable direction and has slow recurrence to the singular set  $\mathcal{S}$ . Then*

1. *there exist closed invariant transitive sets  $\Omega_1, \dots, \Omega_l \subseteq K$  such that for every  $x \in H$  we have  $\omega(x) = \Omega_j$  for some  $1 \leq j \leq l$ ;*
2. *each  $\Omega_j$  contains a subset  $\Lambda_j$  which is the domain of a Young structure (for  $f$ ) with integrable return times;*
3. *there exists a finite collection  $\mathcal{F}_f := \{\mu_1, \dots, \mu_l\}$  of ergodic physical SRB measures supported on the sets  $\Omega_1, \dots, \Omega_l$ , whose basins have nonempty interior and cover a full Lebesgue measure subset of  $H$ .*

Another compelling advantage of an inducing scheme-based approach, beyond its standard usefulness to study statistical properties of the liftable measures, is that it allows us to derive a natural entropy formula for them. In this regard, we call

$$J_f^u(x) := |\det Df|_{E_x^{cu}}$$

the *Jacobian (w.r.t. Lebesgue) along the centre-unstable direction*, a quantity naturally defined  $\mu$ -almost everywhere for every ergodic SRB measure  $\mu \in \mathcal{F}_f$ . Observe that the integrability condition

$$\log |\det Df|_{E_x^{cu}} \in L^1(\mu)$$

is naturally satisfied in the context of Theorem B, in virtue of the nondegeneracy condition (1) - exactly as in Remark 2.1.6. Likewise, relying on the Young structures prescribed by the aforementioned theorem, we are able to deduce an entropy formula for partially hyperbolic systems with singularities in terms of this jacobian.

**Theorem C.** *For any ergodic physical SRB measure  $\mu \in \mathcal{F}_f$ , we have*

$$h_\mu(f) = \int \log |\det Df|_{E_x^{cu}}| d\mu \in \mathbb{R}.$$

The pivotal application upon which this abstract model is inspired - the Poincaré return maps of the Lorenz flow - will be shown in Chapter 5.

## Chapter 3

# Entropy formula for expanding endomorphisms with singular sets

In this chapter, we prove an entropy formula for a class of endomorphisms with singularities. We start by giving an overview of the strategy, strongly dependent upon the classical Gibbs-Markov structures we introduce in the sequel. The existence of these structures for the maps we consider in this chapter, stated in Theorem 3.3.1, is well known from the works [9, 64], but we recover this result here under a shared general framework to be used in the next chapter for diffeomorphisms. The entropy formula is then stated under abstract conditions in Proposition 3.3.5. The heart of our approach uses fairly standard methods in ergodic theory: we consider a tower extension associated with the Gibbs-Markov inducing scheme, deriving a corresponding entropy formula for it and finally relate back the entropies of these two semiconjugated systems. We refer the reader to the book [3] in order to support the elementary material and classical results of this chapter.

### 3.1 Gibbs-Markov structures

In the present section, we give some preliminary definitions and classical results concerning inducing schemes. For the purposes of this section, consider a map  $f : M \rightarrow M$  defined on a measurable space  $M$  with a finite *reference measure*  $m$ . We assume that there is a countable  $m$  mod 0 partition  $\mathcal{P}_*$  of  $M$  into *domains of invertibility*: each  $f(\omega)$  with  $\omega \in \mathcal{P}_*$  is measurable and  $f|_\omega : \omega \rightarrow f(\omega)$  is a bimeasurable bijection. We say that a measurable function  $J_f : M \rightarrow [0, \infty)$  is a *Jacobian of  $f$  (with respect to  $m$ )* if the restriction of  $J_f$  to any  $\omega \in \mathcal{P}_*$  is integrable with respect to  $m$  and for any measurable set  $A \subset \omega$  we have

$$m(f(A)) = \int_A J_f dm. \quad (3.1)$$

This definition does not depend on the choice of invertibility domains and the Jacobian is essentially unique; cf. [58, Exercise 9.7.1 & Proposition 9.7.2]. When  $f$  has a strictly positive Jacobian with respect to some partition, then  $f$  is *nonsingular with respect to  $m$* , meaning that both  $f$  and  $f^{-1}$  preserve

sets of measures zero. In that case,

$$\bigvee_{j=0}^{n-1} f^{-j}(\mathcal{P}_*) = \{\omega_0 \cap f^{-1}(\omega_1) \cap \dots \cap f^{-n+1}(\omega_n) : \omega_0, \dots, \omega_n \in \mathcal{P}_*\}.$$

defines an  $m \bmod 0$  partition on  $M$ , for each  $n \geq 1$ , and the map  $f^n$  also has a Jacobian  $J_f^n$  satisfying the usual *chain rule*:

$$J_f^n = \prod_{j=0}^{n-1} J_f \circ f^j. \quad (3.2)$$

Let  $\Delta_0 \subset M$  be a measurable set with  $m(\Delta_0) > 0$ . For simplicity, the restriction of  $m$  to  $\Delta_0$  will still be denote by  $m$ . Consider

- a countable  $m \bmod 0$  partition  $\mathcal{P}_*$  of  $\Delta_0$  into disjoint invertibility domains of  $f$ , which we will call the *natural partition*;
- a function  $R : \Delta_0 \rightarrow \mathbb{N}$  constant in the elements of  $\mathcal{P}_*$  such that

$$f^{R(\omega)}(\omega) \subset \Delta_0, \text{ for all } \omega \in \mathcal{P}_*. \quad (3.3)$$

We associate to these objects a new map  $F = f^R$ , defining, for each  $\omega \in \mathcal{P}_*$ ,

$$f^R|_{\omega} = f^{R(\omega)}|_{\omega}.$$

We shall refer to  $F = f^R : \Delta_0 \rightarrow \Delta_0$  as an *induced map* and to  $R$  as the *recurrence time* associated to  $f^R$ . We are interested in the case when the induced map  $f^R$  satisfies the properties (G<sub>1</sub>)-(G<sub>4</sub>) below:

(G<sub>1</sub>) **Markov:** each  $\omega \in \mathcal{P}_*$  is sent bijectively by  $F$  to a full  $m$  measure subset of  $\Delta_0$ .

(G<sub>2</sub>) **Nonsingular:**  $F$  has a strictly positive Jacobian  $J_F$ .

It follows from the properties (G<sub>1</sub>)-(G<sub>2</sub>) that there is a subset of  $\Delta_0$  with full  $m$  measure such that for all points  $x$  in that full measure subset of  $\Delta_0$ ,  $F^n(x)$  belongs in some element of  $\mathcal{P}_*$  for every  $n \in \mathbb{N}$ . For all  $x, y$  belonging in that full measure subset of  $\Delta_0$  we may define the *separation time*

$$s(x, y) := \min\{n \geq 0 \mid F^n(x) \text{ and } F^n(y) \text{ lie in distinct elements of } \mathcal{P}_*\}, \quad (3.4)$$

with the convention that  $\min(\emptyset) = \infty$ . As we aim at results in a measure theoretical sense with respect to the reference measure  $m$  (or some measure absolutely continuous with respect to  $m$ ), we may assume with no loss of generality that the separation time is defined for all  $x, y \in \Delta_0$ .

(G<sub>3</sub>) **Separation of points:**  $s(x, y) < \infty$  for all  $x, y \in \Delta_0$  with  $x \neq y$ .

(G<sub>4</sub>) **Bounded distortion:** there are constants  $C > 0$  and  $0 < \beta < 1$  such that for all  $\omega \in \mathcal{P}_*$  and  $x, y \in \omega$ , we have

$$\log \frac{J_F(x)}{J_F(y)} \leq C\beta^{s(F(x), F(y))}.$$



We shall refer to a map  $F : \Delta_0 \rightarrow \Delta_0$  satisfying the properties  $(G_i)$ ,  $i = 1, 2, 3, 4$ , as a *Gibbs-Markov map*. It is a classical folklore theorem (see, for instance, [3, Theorem 2.1]) that any such map admits a unique ergodic absolutely continuous invariant probability (a.c.i.p.) measure  $\nu_0$  equivalent to  $m$  with a density function  $d\nu_0/dm$  uniformly bounded from above and below by positive constants. This elementary fact is the basis for the construction of all the relevant measures in this thesis. For instance, it follows from the properties of  $\nu_0$  aforementioned that

$$\mu_* := \sum_{j=0}^{\infty} f_*^j(\nu_0|\{R > j\})$$

defines an ergodic absolutely continuous  $f$ -invariant measure on  $M$  and a direct calculation shows that  $\mu_*$  is finite if and only if

$$\sum_{j=0}^{\infty} \nu_0(\{R > j\}) = \int_{\Delta_0} R d\nu_0 < \infty \Leftrightarrow \int_{\Delta_0} R dm < \infty. \tag{3.5}$$

The control condition (3.5) is called the *integrability of the recurrence times* and, whenever it holds, the normalization

$$\mu := \frac{1}{\mu_*(M)} \mu_* \tag{3.6}$$

is the unique ergodic  $f$ -invariant probability measure on  $M$  with  $\mu \ll m$  and  $\mu(\Delta_0) > 0$ . An ergodic absolutely continuous  $f$ -invariant probability  $\mu$  on  $M$  derived from a Gibbs-Markov map  $F : \Delta_0 \rightarrow \Delta_0$  with integrable recurrence times by the process described above is called *liftable*.

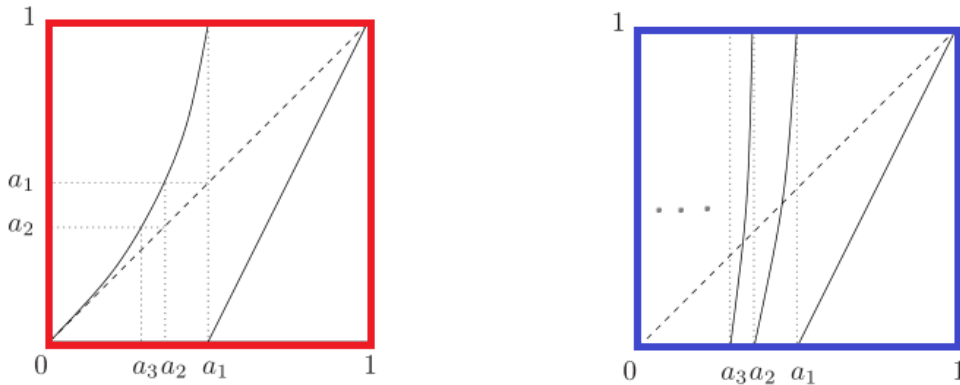

Fig. 3.1 An induced map (right) of the *intermittent* map (left).

### 3.2 Tower extension

The construction in this section can be performed under very general conditions from maps  $F : \Delta_0 \rightarrow \Delta_0$ , not necessarily induced maps. However, this is the special case we are interested in, so that the

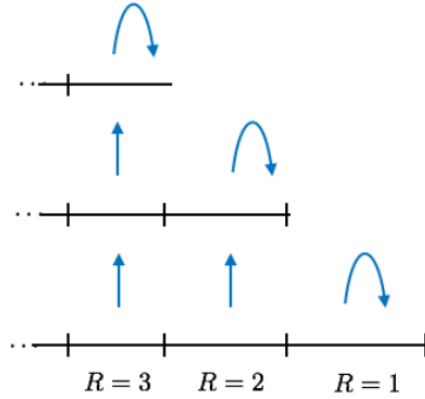

Fig. 3.2 Tower map.

concepts/notations in the previous section are inherited here as well. Indeed, let  $f : M \rightarrow M$  be a map admitting an induced map  $F = f^R : \Delta_0 \rightarrow \Delta_0$  with reference measure  $m$ , natural partition  $\mathcal{P}_*$  and recurrence time function  $R : \Delta_0 \rightarrow \mathbb{N}$ . We associate to these objects the *tower*

$$\Delta = \{(x, l) : x \in \Delta_0 \text{ and } 0 \leq l < R(x)\}$$

and the *tower map*  $T : \Delta \rightarrow \Delta$  given by

$$T(x, l) = \begin{cases} (x, l+1), & \text{if } l < R(x) - 1 \\ (F(x), 0), & \text{if } l = R(x) - 1 \end{cases}$$

The  $l^{\text{th}}$ -level of the tower is the set

$$\Delta_l := \{(x, l) \in \Delta\}, \quad l \in \mathbb{N}_0, \quad (3.7)$$

Observe we have used the notation  $\Delta_0$  to represent both the *base* (or *ground level*) of the tower and the inducing domain of  $F : \Delta_0 \rightarrow \Delta_0$  upon which it is built: they are naturally identified with each other. Moreover, under this identification it's straightforward from the definitions that  $T^{R(x)}(x, 0) = f^{R(x)}(x)$ , for  $x = (x, 0) \in \Delta_0$ . We call  $T^R : \Delta_0 \rightarrow \Delta_0$  the *return map* to the base  $\Delta_0$ , which in the case of the tower is actually a *first return* map. We shall refer to the set  $T^{-1}(\Delta_0)$  as the *roof* of the tower and to  $T^{-1}(\Delta_0) \cap \Delta_l$  as a the  $l^{\text{th}}$ -*roof level*. Therefore,  $T$  is an upward translation between tower levels, except on the roof, where its action is dictated by the return map  $F = f^R$ . In the same spirit, the  $l^{\text{th}}$  level of the tower is naturally identified with the set  $R_l^+ := \{x \in \Delta_0 \mid R(x) > l\} \subseteq \Delta_0$ . This natural identification of each tower level  $\Delta_l$  with a subset of  $\Delta_0$  allow us to extend the reference measure  $m$  of  $\Delta_0$  to a measure on  $\Delta$ , that we still denote by  $m$ . In general, this measure on  $\Delta$  is not finite. It actually happens that the integrability of  $R$  with respect to  $m$  (on  $\Delta_0$ ) is a necessary and sufficient condition for the finiteness of

$m$  on  $\Delta$ . Indeed, we have

$$m(\Delta) = \sum_{l \geq 0} m(\Delta_l) = \sum_{l \geq 0} m(\{R > l\}) = \sum_{l \geq 1} lm(\{R = l\}) = \int_{\Delta_0} R dm.$$

Under the hypothesis  $R \in L^1(m)$ , we can define a unique ergodic invariant probability measure  $\nu$  on  $\Delta$  lifting the measure  $\nu_0$  on  $\Delta_0$  by the tower map  $T$ : we start considering

$$\nu_* = \sum_{j=0}^{\infty} T_*^j(\nu_0|_{\{R > j\}})$$

and then normalize:  $\nu = \nu_*(\Delta)^{-1} \cdot \nu_*$ . Moreover, the density  $d\nu/dm$  is bounded from above and below by positive constants. A measure preserving system  $(f, M, \mu)$  is said to be a *factor* of another measure preserving system  $(T, \Delta, \nu)$  if there is a measure preserving map  $\pi: \Delta \rightarrow M$  such that  $\pi \circ T = f \circ \pi$  and  $\pi_* \nu = \mu$ . The map  $\pi$  is called the *projection map* or the *semiconjugacy*. In this case, we may say that  $(T, \Delta, \nu)$  is an *extension* of  $(f, M, \mu)$ . An important feature of tower maps coming from induced schemes as in (3.3) is that we are able to define a projection map  $\pi: \Delta \rightarrow M$  by  $\pi(x, l) = f^l(x)$  that semiconjugates the original system and the tower.

$$\begin{array}{ccc} (\Delta, \nu) & \xrightarrow{T} & (\Delta, \nu) \\ \downarrow \pi & & \downarrow \pi \\ (M, \mu) & \xrightarrow{f} & (M, \mu) \end{array}$$

The countable partition  $\mathcal{P}_*$  on  $\Delta_0$  naturally induces an  $m \bmod 0$  countable partition on each level  $\Delta_l$ . Collecting all these partitions, we obtain an  $m \bmod 0$  *natural partition*  $\mathcal{Q}_*$  of the whole tower  $\Delta$ . A sequence of dynamically generated partitions  $(\mathcal{Q}_n)_{n \geq 0}$  of  $\Delta$  is then defined in the usual way:

$$\mathcal{Q}_n = \bigvee_{i=0}^n T^{-i} \mathcal{Q}_*, \quad n \in \mathbb{N}. \quad (3.8)$$

By definition of Gibbs-Markov map,  $F$  has a strictly positive Jacobian  $J_F$ . It is straightforward to check that then the tower map also has a Jacobian with respect to the measure  $m$  on the tower given by

$$J_T(x, l) = \begin{cases} 1, & \text{if } R(x) > l + 1. \\ J_F(x), & \text{if } R(x) = l + 1. \end{cases}$$

Besides, associated to the Gibbs-Markov map  $F$ , we have a separation time  $s(x, y)$  defined for points  $x, y \in \Delta_0$  as in (3.4). This separation time extends to a separation time in  $\Delta$  in the following way:

$$s((x, l), (x', l')) = \begin{cases} s(x, x'), & \text{if } l = l'. \\ 0, & \text{otherwise.} \end{cases}$$

Finally, given  $0 < \beta < 1$  and a separation time function, we can define a metric  $d_\beta$  on  $\Delta \times \Delta$  by  $d_\beta((x, l), (x', l')) = \beta^{s((x, l), (x', l'))}$ .

### 3.3 Overview of the strategy

A striking and non-trivial feature of the measures  $\mu_1, \dots, \mu_l$  in (2.9) is that they can be associated with Gibbs-Markov maps, i.e., they are *liftable* according to our previous terminology. For the sake of completeness, the global picture is stated in Theorem 3.3.1 below, the first part of which may be regarded as a topological decomposition admitting [5, Theorem C] as its measure theoretical version (and corollary), with the attractors replaced by SRB measures.

**Theorem 3.3.1.** *Let  $f : M \rightarrow M$  be a  $C^{1+}$  local diffeomorphism out of a nondegenerate set  $S \subset M$ . Assume that  $H \subset M$  is an invariant set with  $\text{Leb}(H) > 0$  on which  $f$  is nonuniformly expanding and has slow recurrence to  $S$ . Then, there exist closed forward invariant sets  $\Omega_1, \dots, \Omega_l \subset M$  and  $r > 0$  such that:*

1. *for Leb almost every  $x \in H$  we have  $\omega(x) = \Omega_j$  for some  $1 \leq j \leq l$ ;*
2. *each  $\Omega_j$  is transitive and contains a ball  $\Sigma_j$  of radius  $r$  such that  $f$  is nonuniformly expanding and has slow recurrence to  $S$  for Lebesgue almost every point in  $\Sigma_j$ .*

*In addition,  $f$  has an induced Gibbs-Markov map defined on a ball  $\Delta_j \subset \Sigma_j$  with integrable recurrence times (with respect to Lebesgue).*

Each Gibbs-Markov map on  $\Delta_j$  admits a unique ergodic a.c.i.p.  $\nu_j$  which in turn gives rise to an ergodic a.c.i.p.  $\mu_j$  (for  $f$ ) whose basin contains Lebesgue almost every point in  $\Delta_j$ . The collection of measures derived in this way gives precisely the family  $\mathcal{F}_f$  in (2.9). Theorem 3.3.1 can be proved using a general approach (to be used in the next chapter for a more intricate class of partially hyperbolic systems with singularities), which combines important results and techniques of the foundational paper [5] and subsequent works [8, 9, 64]. In the remaining of this section, we outline the framework that allow us to obtain Markov structures for systems with singularities, highlighting only the main ingredients, clarifying how they are already present in the literature for the endomorphism case and postponing the actual full construction to Appendix B.

The first part of Theorem 3.3.1, i.e., the existence of a finite collection of transitive attractors  $\Omega_1, \dots, \Omega_l$  with the property that each  $\Omega = \Omega_j$  contains a ball  $\Sigma = \Sigma_j$  of some fixed radius (uniform on the family) on which  $f$  is nonuniformly expanding and has slow recurrence to the singular set  $S$  is not particularly significant here, being obtained in very much the same way as in the context of the next chapter, based on the fact that the set  $H$  is *incompressible* or *unshrinkable* in this situation as well; we refer the reader to [8, Sections 3 and 4] for details. The more substantial part, i.e., the construction of a Gibbs-Markov induced scheme with integrable recurrence times, is based on the assumption that there exists  $\Delta_0 \subset \Sigma$ , with the same dimension of  $\Sigma$ , for which the conditions (A<sub>1</sub>)-(A<sub>3</sub>) below hold. We stress

that these properties could be stated alternatively in terms of the set  $H$  alone, and only then derive the existence of  $\Delta_0$  - which as a subset of  $\Sigma$  will be contained Leb mod 0 in  $H$ . For the sake of notational simplicity, we denote for each  $n \geq 1$ ,

$$\text{dist}_n := \text{dist}_{f^n(\Sigma)} \text{ and } \text{Leb}_n = \text{Leb}_{f^n(\Sigma)},$$

where  $\text{dist}_{f^n(\Sigma)}$  stands for the distance in the submanifold  $f^n(\Sigma)$  and  $\text{Leb}_{f^n(\Sigma)}$  the Lebesgue measure on the Borel sets of  $f^n(\Sigma)$ , both induced by the Riemannian metric on  $M$ . When using this simplified notation, the underlying manifold  $\Sigma$  depends upon the context and it should be implicit that  $\Sigma$  is such that all the iterates  $f^k(\Sigma)$  with  $0 \leq k \leq n$  are submanifolds disjoint from  $\mathcal{S}$ . In general,  $f^n(\Sigma)$  might possibly be a submanifold with singularities or even a finite union of disjoint submanifolds.

(A<sub>1</sub>) There are compact sets  $H_1, H_2, \dots \subset \Delta_0$  such that for Lebesgue almost every  $x \in \Delta_0$

- a.  $x \in H_n \implies f^k(x) \in H_{n-k}$ , for all  $0 \leq k \leq n$ ,
- b.  $x$  belongs to  $H_n$  for infinitely many  $n$ .

This property is based on the notion of *hyperbolic times* [2, 5]. More precisely, given  $\sigma \in (0, 1)$  and  $r > 0$ , we say that  $n$  is a  $(\sigma, r)$ -hyperbolic time for  $x \in M$  if

$$\prod_{j=k}^{n-1} \|Df(f^j(x))^{-1}\| \leq \sigma^{n-k} \text{ and } \text{dist}_r(f^k(x), \mathcal{S}) \geq \sigma^{b(n-k)},$$

for all  $0 \leq k < n$ . In order to find the sets  $H_n$ , we recall that we assume that  $f$  is nonuniformly expanding and has slow recurrence to  $\mathcal{S}$  for Lebesgue almost every point in  $\Sigma$ . As we shall see in the next proposition, which can be found essentially in [5] (cf. also [3, Corollary 5.1]), these two properties ensure the existence of hyperbolic times.

**Proposition 3.3.2.** *Let  $f : M \rightarrow M$  be a  $C^{1+}$  local diffeomorphism out of a nondegenerate set  $\mathcal{S}$ . If  $f$  is nonuniformly expanding and has slow recurrence to  $\mathcal{S}$  on a set  $H$ , then there exists  $\sigma, r \in (0, 1)$  and  $\theta > 0$  such that for all  $x \in H$  we have*

$$\limsup_{n \rightarrow \infty} \frac{1}{n} \#\{1 \leq j \leq n : j \text{ is a } (\sigma, r)\text{-hyperbolic time for } x\} \geq \theta.$$

Defining, for each  $n \geq 1$ ,

$$H_n = \{x \in \Delta_0 \cap H : n \text{ is a } (\sigma, r)\text{-hyperbolic time for } x\}, \quad (3.9)$$

Proposition 3.3.2 gives upper density of  $(\sigma, r)$ -hyperbolic times: there exists  $\theta > 0$  such that for Lebesgue almost every  $x \in \Delta_0$  we have

$$\limsup_{n \rightarrow \infty} \frac{1}{n} \#\{1 \leq j \leq n : x \in H_j\} \geq \theta. \quad (3.10)$$

In particular, this property implies that Lebesgue almost every  $x \in \Delta_0$  belongs in infinitely many  $H_n$ . Recalling the definition of hyperbolic time, we easily conclude that condition (A<sub>1</sub>) holds in this context.

(A<sub>2</sub>) There is  $\delta_1 > 0$  such that for each  $x \in H_n$  there is a neighbourhood  $V_n(x)$  of  $x$  in  $\Sigma$  such that  $f^n$  maps diffeomorphically to a ball of radius  $\delta_1$  centered at  $f^n(x)$ . Moreover, there are  $C_0, \eta > 0$  and  $0 < \sigma < 1$  such that for all  $V_n(x)$  and all  $y, z \in V_n(x)$  we have

- $\text{dist}_{n-k}(f^{n-k}(y), f^{n-k}(z)) \leq \sigma^k \text{dist}_n(f^n(y), f^n(z))$ , for all  $1 \leq k \leq n$ .
- $\log \frac{|\det Df^n(y)|}{|\det Df^n(z)|} \leq C_0 \text{dist}_n(f^n(y), f^n(z))^\eta$ .

The sets  $V_n(x)$  are called *hyperbolic pre-balls* and their images  $f^n(V_n(x)) = B_{\delta_1}^u(f^n(x))$ , which are balls of fixed radius  $\delta_1 > 0$ , are called *hyperbolic balls*. Their construction is contained in the proposition below, which again is classical material having its roots at least in [5]; cf. also [3, Proposition 5.2].

**Proposition 3.3.3.** *Let  $f : M \rightarrow M$  be a  $C^{1+}$  local diffeomorphism out of a nondegenerate set  $S$ . Given  $\sigma \in (0, 1)$  and  $r > 0$ , there exists  $\delta_1 > 0$  such that if  $n$  is a  $(\sigma, r)$ -hyperbolic time for  $x \in M$ , then there exists a neighbourhood  $V_n(x)$  of  $x$  which is mapped by  $f^n$  diffeomorphically onto  $B_{\delta_1}(f^n(x))$ . Moreover, for all  $y, z \in V_n(x)$  and  $1 \leq k \leq n$  we have*

$$\text{dist}(f^{n-k}(y), f^{n-k}(z)) \leq \sigma^{k/2} \text{dist}(f^n(y), f^n(z)).$$

Also, there is  $C_0 > 0$  such that for every hyperbolic preball  $V_n(x)$  and every  $y, z \in V_n(x)$  we have the next bounded distortion property:

$$\log \frac{|\det Df^n(y)|}{|\det Df^n(z)|} \leq C_0 \text{dist}(f^n(y), f^n(z))^\beta.$$

We will consider the sets  $W_n(x) \subset \tilde{W}_n(x) \subset V_n(x)$  such that  $f^n$  maps  $W_n(x)$  diffeomorphically to the ball of radius  $\delta_1/9$  and  $\tilde{W}_n(x)$  to the ball of radius  $\delta_1/3$ , both centered at  $f^n(x)$ .

(A<sub>3</sub>) There are  $L, \delta_0 > 0$  such that for each  $x \in H_n$  we have  $0 \leq l = l(x) \leq L$  and domains  $\omega_{n,l}(x) \subset \tilde{\omega}_{n,l}(x) \subset W_n(x)$  with  $f^{n+l}$  mapping  $\omega_{n,l}$  diffeomorphically to a ball of radius  $\delta_0$  (actually, to  $\Delta_0$  itself) and mapping  $\tilde{\omega}_{n,l}$  to a ball of radius  $2\delta_0$  concentric with  $f^{n+l}(\omega_{n,l})$ . Moreover, there are  $C_1, \eta > 0$  such that for every  $\tilde{\omega}_{n,l}(x)$  and every  $y, z \in f^n(\tilde{\omega}_{n,l}(x))$  we have

- a.  $\frac{1}{C_1} \text{dist}(y, z) \leq \text{dist}_l(f^l(y), f^l(z)) \leq C_1 \text{dist}(y, z)$
- b.  $\log \frac{|\det Df^l(y)|}{|\det Df^l(z)|} \leq C_1 \text{dist}_l(f^l(y), f^l(z))^\eta$ .

This condition will follow as an easy consequence of [3, Lemma 5.5] presented below.

**Lemma 3.3.4.** *Under the hypothesis of Theorem 3.3.1, there exist  $p \in \Sigma$ ,  $L \in \mathbb{N}$  and  $C > 0$  such that for any small  $\delta_0 > 0$  and any ball  $B \subset \Omega$  of radius  $\delta_1/9$ , there exist  $U \subset B$  and an integer  $0 \leq l \leq L$  such that  $f^l$  maps  $U$  diffeomorphically onto  $B_{2\delta_0}(p)$ . Moreover, for all  $x, y \in U$  we have*

1.  $\frac{1}{C} \text{dist}(x, y) \leq \text{dist}_l(f^l(x), f^l(y)) \leq C \text{dist}(x, y)$ ;
2.  $\log \left| \frac{\det Df^l(x)}{\det Df^l(y)} \right| \leq C \text{dist}(f^l(x), f^l(y))^\beta$ .

The ball  $\Delta_0 = B_{\delta_0}(p)$  will be the domain of the inducing scheme, where  $p$  and  $\delta_0$  are given by Lemma 3.3.4. If conditions (A<sub>1</sub>)-(A<sub>3</sub>) hold, then we are able to construct a Gibbs-Markov map defined on  $\Delta_0$  with integrable recurrence times. The full construction from these properties as well as the integrability of the recurrence time, inspired in [8], is carried thoroughly to the end in Appendix B for a class of partially hyperbolic systems with singularities.

Our main Theorem A is a direct consequence of the abstract Proposition 3.3.5 applied to each induced Gibbs-Markov map defined on  $\Delta_j$  and the respective measure  $\mu_j$ , taking  $m = \text{Leb}$  for the reference measure.

**Proposition 3.3.5.** *Let  $f : M \rightarrow M$  be a measurable map admitting a strictly positive Jacobian  $J_f$  a.e. with respect to some finite reference measure  $m$  and  $\mu$  be a liftable ergodic absolutely continuous invariant probability measure on  $M$  such that  $\log J_f \in L^1(\mu)$ . Then, the entropy formula below holds:*

$$h_\mu(f) = \int \log J_f d\mu.$$

Recall from the previous section that  $(f, \mu)$  and  $(T, \nu)$  are semiconjugated systems. Our line of attack integrates this very fact in that it allows us to relate the entropies of the original system and the tower, deriving an entropy formula for the latter and passing this information down to the former by simple integral computations. Indeed, the proof of Theorem A consists in the next chain of equalities:

$$h_\mu(f) = h_\nu(T) = \int \log J_T d\nu = \int \log J_f d\mu, \quad (3.11)$$

where  $J_T$  and  $J_f$  are the Jacobians with respect to the reference measures on  $\Delta$  and  $M$  introduced before.

*Remark 3.3.6.* A natural question that may be prompted is whether we may implement a similar strategy directly with the induced Gibbs-Markov map, i.e., prove the analogous chain of inequalities for  $F = f^R : \Delta_0 \rightarrow \Delta_0$  without considering the tower map extension. This was actually our first approach, but owing to the advantage of a semiconjugacy and better support from previous literature we had at the time (see e.g. [1, 26, 32, 49, 52]), we found it simpler to implement the aforementioned strategy via tower maps. Only latter, in [80, Theorem 5.1], we found a relation between the entropy of the induced system and the original's one, which would provide a somewhat technically simpler approach in very much the same direction of (3.11). We stress, however, that the proof of [80, Theorem 5.1] relies strongly on a tower extension and the analogous relation for the tower map  $h_\mu(f) = h_\nu(T)$  - arguably, the most intricate part of the argument - so that in the end we opted to stick with the towers' approach.

### 3.4 Entropy formula for the tower map

We now prove Proposition 3.3.5 in a series of lemmas. Our first step is to derive an entropy formula for the expanding tower  $(T, \nu)$ , namely,

$$h_\nu(T) = \int \log J_T d\nu. \quad (3.12)$$

The Lemma 3.4.1 below relates the integral terms in the entropy formulas for towers and the original system, and implies that the integrability condition  $\log J_T \in L^1(\nu)$  is equivalent to  $\log J_f \in L^1(\mu)$  - which is assumed by hypothesis. The calculations follow a standard computational approach which can be found, for instance, in [10, Lemma 4.4].

**Lemma 3.4.1.**  $\int \log J_T d\nu = \int \log J_f d\mu.$

*Proof.* Since there can be several elements  $\omega \in \mathcal{P}_*$  with the same recurrence time, it will be useful to group them together and consider the measurable partitions  $\mathcal{P}_R = \{P_r\}_{r \in \mathbb{N}}$  on  $\Delta_0$  and  $\mathcal{Q}_R = \{\Delta_l^r\}$  on  $\Delta$ , defined by

$$P_r = \{x \in \Delta_0 \mid R(x) = r\}, \quad r \in \mathbb{N},$$

$$\Delta_l^r := \{(x, l) \in \Delta \mid x \in P_r \Leftrightarrow R(x) = r\}, \quad \text{for } l \in \mathbb{N}_0 \text{ and } r > l.$$

Clearly, the natural partition  $\mathcal{Q}_*$  is a refinement of  $\mathcal{Q}_R$ . Recall that, by definition, we have

$$J_T|_{\Delta_l^r}(x, l) = \begin{cases} J_F(x), & \text{if } r = l + 1. \\ 1, & \text{if } r > l + 1. \end{cases}$$

and, by the chain rule, for all  $r \in \mathbb{N}$  and  $x \in P_r$ , we have  $J_F(x) = J_f(f^{r-1}(x)) \cdots J_f(f(x)) \cdot J_f(x)$ . The previous observations together with suitable algebraic/combinatorial manipulations yield:

$$\begin{aligned} \int \log J_T d\nu &= \sum_{l=0}^{\infty} \int_{\Delta_l^{l+1}} \log J_T d\nu \\ &= \sum_{l=0}^{\infty} \sum_{k=0}^l \int_{\Delta_l^{l+1}} \log J_f \circ f^k d\nu \\ &= \sum_{l=0}^{\infty} \sum_{k=0}^l \int_{\Delta_k^{l+1}} \log J_f \circ f^k d\nu \\ &= \sum_{l=0}^{\infty} \sum_{m>l} \int_{\Delta_l^m} \log J_f \circ f^l d\nu \\ &= \sum_{l=0}^{\infty} \int_{\Delta_l} \log J_f \circ f^l d\nu \\ &= \sum_{l=0}^{\infty} \int_{\Delta_l} \log J_f \circ \pi d\nu \\ &= \int_{\Delta} \log J_f \circ \pi d\nu \end{aligned}$$



Finally, observing that  $\pi_* \nu = \mu$ , we have

$$\int_{\Delta} \log J_f \circ \pi \, d\nu = \int_M \log J_f \, d\pi_* \nu = \int_M \log J_f \, d\mu.$$

□

The strategy we follow to obtain (3.12) is based in [10, Proposition 4.3], where a similar result is obtained for inducing schemes of piecewise expanding maps. We start with two auxiliary propositions that will allow us to implement that strategy in the context of tower extensions. The first one asserts that the natural partition  $\mathcal{Q}_*$  is *generating*, in the Kolmogorov-Sinai sense that the entropy of the tower is realized there; cf. [61]. This is intimately connected with the classical fact below (see e.g. [29, pag. 401]) and the finiteness of the separation times.

*Fact 1.* Let  $(f, M, \mu)$  be a measure-preserving system. Assume there is a sequence  $\{\mathcal{P}_k\}_{k \in \mathbb{N}}$  of measurable partitions of  $M$  satisfying the separating property:

( $S_*$ ) given distinct points  $x, y \in M$ , there is  $s(x, y) \in \mathbb{N}_0$  such that  $\mathcal{P}_k(x) \neq \mathcal{P}_k(y)$ , for all  $k \geq s(x, y)$ , where  $\mathcal{P}_k(x)$  stands for the atom of the partition  $\mathcal{P}_k$  containing  $x$ .

Then  $h_\mu(f) = \sup_k h_\mu(f, \mathcal{P}_k)$ .

**Proposition 3.4.2.**  $h_\nu(T) = h_\nu(T, \mathcal{Q}_*)$

*Proof.* The separating property ( $G_3$ ) of the Gibbs-Markov system  $(F, \Delta_0, m_0)$  with respect to the natural partition  $\mathcal{P}_*$ , together with the very definition of the dynamically generated partitions

$$\mathcal{P}_k := \bigvee_{i=0}^k F^{-i} \mathcal{P}_*, \quad k \geq 0,$$

implies that for all  $x, y \in \Delta_0$ , there exists  $s(x, y) \in \mathbb{N}_0$  (the separating time thus defined), such that

$$\mathcal{P}_k(x) \neq \mathcal{P}_k(y) \text{ for all } k \geq s(x, y).$$

This separating property is clearly inherited to the tower map  $T$  and the natural partition  $\mathcal{Q}_*$ : for all  $(x, l), (x', l') \in \Delta$ , there is  $\hat{s}_*((x, l), (x', l')) \in \mathbb{N}_0$  such that

$$\mathcal{Q}_k(x, l) \neq \mathcal{Q}_k(x', l'), \text{ for all } k \geq \hat{s}_*((x, l), (x', l')),$$

where  $\mathcal{Q}_k := \bigvee_{i=0}^k T^{-i} \mathcal{Q}_*$ . Thus, by the Fact 1, we conclude that

$$h_\nu(T) = \sup_{k \in \mathbb{N}_0} h_\nu(T, \mathcal{Q}_k) = h_\nu(T, \mathcal{Q}_*).$$

□

On the second proposition, we will want to compare the volume  $m(\mathcal{Q}_k(x, l))$  with the Jacobian  $J_T^k(x, l)$ , at least for an infinite set of times  $k \in \mathbb{N}$ . This is the main technical difference between inducing

schemes and tower extensions we have to deal with in order to replicate the same approach, since in the former case, owing to the Markov property  $(G_1)$ , such comparison can be done for all times  $k \in \mathbb{N}$ . Such property does not pass down to the natural partition  $\mathcal{Q}_*$  of the tower but, fortunately, the strategy does not require all its strength. In the present situation, it suffices to observe that  $\mathcal{Q}_*$  is *quasi-Markovian* with respect to the measure  $m$  (cf. [14]), meaning that there exists  $\eta := m(\Delta_0) > 0$  such that for  $m$ -almost every  $(x, l) \in \Delta$  there are infinitely many  $k \in \mathbb{N}$  for which

$$m(T^{k+1}(\mathcal{Q}_k(x, l))) \geq \eta > 0. \quad (3.13)$$

The times  $k$  may be characterized by  $T^k(x, l) \in T^{-1}(\Delta_0)$ , the roof of the tower, a fact that can be deduced from the Markov property for the associated induced map  $F = f^R$  and the nature of the partition elements  $\mathcal{Q}_k(x, l)$ , which remains unchanged during the time elapsed from the base to the roof. Given an  $m$ -generic point  $(x, l) \in \Delta$ , let  $\mathcal{M}(x, l)$  be the set of times  $k \in \mathbb{N}$  where (3.13) holds. We are now in conditions to present a *volume lemma* at least for this set of times:

**Proposition 3.4.3.** *There exists a constant  $K_2 > 0$  such that for  $m$ -almost every  $(x, l) \in \Delta$  and all  $k \in \mathcal{M}(x, l)$ , we have*

$$K_2^{-1} \leq m(\mathcal{Q}_{k-1}(x, l)) \cdot J_T^k(x, l) \leq K_2.$$

*Proof.* The next auxiliary estimate on the Jacobian will prove itself useful in subsequent calculations. The reader may want to refer to [11, Lemma 3.4] where a proof can be found. From the bounded distortion property  $(G_4)$  and the computations in [11, Lemma 3.4], one can deduce that there exists a constant  $C_T > 0$  such that for all  $k \geq 1$  and  $(x, l), (y, l) \in \Delta$  belonging to the same element of  $\mathcal{Q}_{k-1}$  we have

$$\log \frac{J_T^k(x, l)}{J_T^k(y, l)} \leq C_T \beta^{\delta(T^k(x, l), T^k(y, l))}.$$

In particular, this implies that there exists a constant  $K_1 := e^{C_T \beta} > 0$  such that for all  $k \geq 0$  and all  $(x, l), (y, l) \in \Delta$  belonging to the same element of  $\mathcal{Q}_{k-1}$ , we have

$$K_1^{-1} \leq \frac{J_T^k(x, l)}{J_T^k(y, l)} \leq K_1. \quad (3.14)$$

Using the Jacobian's defining property (3.1), it follows that

$$\begin{aligned} m(T^k(\mathcal{Q}_{k-1}(x, l))) &= \int_{\mathcal{Q}_{k-1}(x, l)} J_T^k(y, l) dm(y, l) \\ &= \int_{\mathcal{Q}_{k-1}(x, l)} \frac{J_T^k(y, l)}{J_T^k(x, l)} J_T^k(x, l) dm(y, l). \end{aligned}$$

Now, on the one hand, using the bounded distortion property (3.14), we deduce that

$$m(\Delta) \geq m(T^k(\mathcal{Q}_{k-1}(x, l))) \geq K_1^{-1} \cdot J_T^k(x, l) \cdot m(\mathcal{Q}_{k-1}(x, l))$$

and consequently, for all  $k \in \mathbb{N}$ ,

$$J_T^k(x, l) \cdot m(\mathcal{Q}_{k-1}(x)) \leq m(\Delta) \cdot K_1.$$

On the other hand, for all the values of  $k \in \mathcal{M}(x, l)$ ,

$$\eta \leq m(T^k(\mathcal{Q}_{k-1}(x, l))) \leq K_1 \cdot J_T^k(x, l) \cdot m(\mathcal{Q}_{k-1}(x, l)),$$

and therefore,

$$\eta \cdot K_1^{-1} \leq J_T^k(x, l) \cdot m(\mathcal{Q}_{k-1}(x, l)).$$

Choosing  $K_2 := \max\{m(\Delta) \cdot K_1, (\eta \cdot K_1^{-1})^{-1}\}$ , we are done.  $\square$

**Lemma 3.4.4.**  $h_\nu(T) = \int \log J_T d\nu$ .

*Proof.* First, recall that the measure  $\nu$  is ergodic. By Proposition 3.4.2, the natural partition  $\mathcal{Q}_*$  on the tower realizes the entropy. Besides, the integrability of the recurrence times implies  $H_\nu(\mathcal{Q}_*) < \infty$ . Therefore, by the Shannon-McMillan-Breiman Theorem, for a  $\nu$ -generic point  $(x, l) \in \Delta$ , we have

$$h_\nu(T) = h_\nu(T, \mathcal{Q}_*) = \lim_{n \rightarrow \infty} -\frac{1}{n} \log \nu(\mathcal{Q}_n(x, l)) = \lim_{n \rightarrow \infty} -\frac{1}{n} \log m(\mathcal{Q}_n(x, l)),$$

where the last equality comes from the fact that  $\nu$  and  $m$  are equivalent measures with uniformly bounded densities. Finally, using Proposition 3.4.3, the chain rule property for the Jacobian and Birkhoff's Ergodic Theorem applied to the observable  $\phi = \log J_T \in L_1(\nu)$ , we conclude that

$$\begin{aligned} h_\nu(T) &= \lim_{n \rightarrow \infty} -\frac{1}{n} \log m(\mathcal{Q}_n(x, l)) \\ &= \lim_{\substack{k \rightarrow \infty \\ k \in \mathcal{M}(x, l)}} -\frac{1}{k-1} \log m(\mathcal{Q}_{k-1}(x, l)) \\ &= \lim_{\substack{k \rightarrow \infty \\ k \in \mathcal{M}(x, l)}} -\frac{1}{k} \log m(\mathcal{Q}_{k-1}(x, l)) \\ &= \lim_{\substack{k \rightarrow \infty \\ k \in \mathcal{M}(x, l)}} \frac{1}{k} \log J_T^k(x, l) \\ &= \lim_{\substack{k \rightarrow \infty \\ k \in \mathcal{M}(x, l)}} \frac{1}{k} \sum_{i=0}^{k-1} \log J_T(T^i(x, l)) \\ &= \lim_{n \rightarrow \infty} \frac{1}{n} \sum_{i=0}^{n-1} \log J_T(T^i(x, l)) \\ &= \int \log J_T d\nu \end{aligned}$$

$\square$

### 3.5 Original vs Tower map entropies

In this subsection, we relate the towers' and the original system entropies. The inequality  $h_\mu(f) \leq h_\nu(T)$  is immediate because it holds in general for semiconjugated systems. The Lemma 3.5.1 below, expounding the reverse inequality, is owed to [32, Proposition 2.8] since tower extensions have countable fibers. We will illustrate in slight more detail how the argument therein can be applied in this specific scenario, without claiming any significant novelty in the arguments.

**Lemma 3.5.1.**  $h_\mu(f) \geq h_\nu(T)$ .

*Proof.* First, we recall that  $(f, \mu)$  and  $(T, \nu)$  are ergodic. As observed in [32], we note alternatively that

$$h_\nu(T) = \sup_{\mathcal{Q} \in \mathcal{F}} h_\nu(T, \mathcal{Q}), \quad (3.15)$$

where  $\mathcal{F}$  is any family of finite measurable partitions  $\mathcal{Q}$  on  $\Delta$  which is stable by finite joining and generates the  $\sigma$ -algebra of  $\Delta$ .

We start by giving a precise description of the family  $\mathcal{F}$  to be used in the computation. Recall that for each  $r \in \mathbb{N}$  the set  $P_r = \{x \in \Delta_0 \mid R(x) = r\}$  is a union of elements  $\omega_{0,i}$  of the natural partition  $\mathcal{P}_*$  of  $\Delta_0$ . This union may possibly be countable, so, in order to make it finite, we will truncate it as follows: given  $r, n \in \mathbb{N}$  we denote by  $P_{r,n}$  any finite collection of domains  $\omega_{0,i} \subset P_r$  such that  $\bigcup_{\omega_{0,i} \in P_{r,n}} \omega_{0,i}$  has  $\mu$  measure at least  $(1 - 1/n) \cdot \mu(P_r)$ . Moreover, we can choose such collections in an increasing way:  $P_{r,n_1} \subseteq P_{r,n_2}$  for  $n_1 \leq n_2$ . Let  $\mathcal{Q}_* = \{\omega_{l,i}\}_{l,i}$  be the natural partition of  $\Delta$ , with  $\omega_{l,i} \in \Delta_l$  being the copy of  $\omega_{0,i}$  on the  $l^{\text{th}}$ -level for all  $i$ . Given  $R \in \mathbb{N}$ , define

$$\mathcal{Q}_*^{R^-} := \{\omega_{l,i} \in \mathcal{Q}_* \mid \omega_{0,i} \in P_{r,R} \text{ for some } 1 \leq r \leq R\} \text{ and } \Delta_{R^+} := \bigcup_{\omega_{l,i} \in \mathcal{Q}_* \setminus \mathcal{Q}_*^{R^-}} \omega_{l,i},$$

that is, we are looking at a fixed fraction  $(1 - 1/R)$  of the domains  $\omega_{0,i}$  which return before time  $R$  and consider all the copies  $\omega_{l,i}$  of  $\omega_{0,i}$  from the ground level to the roof of  $\Delta$ . Clearly,  $\mathcal{Q}_*^R := \mathcal{Q}_*^{R^-} \cup \{\Delta_{R^+}\}$  is a finite measurable partition which gets finer and finer as  $R$  increases. Let

$$\mathcal{F} := \{\mathcal{Q}_{\mathcal{P},R} := \pi^{-1}(\mathcal{P}) \vee \mathcal{Q}_*^R \mid \mathcal{P} \text{ finite measurable partition on } M \text{ and } R \in \mathbb{N}\}.$$

Clearly, each  $\mathcal{Q} \in \mathcal{F}$  is finite and measurable since it is the joining of two finite measurable partitions. Besides, the joining of a finite number of partitions in  $\mathcal{F}$  produces another partition in  $\mathcal{F}$ :

$$\mathcal{Q}_{\mathcal{P}_1, R_1} \vee \cdots \vee \mathcal{Q}_{\mathcal{P}_n, R_n} = \mathcal{Q}_{\mathcal{P}_1 \vee \cdots \vee \mathcal{P}_n, \max\{R_1, \dots, R_n\}},$$

Recalling that  $\pi|_{\omega_{l,i}} : \omega_{l,i} \rightarrow M$  defined by  $\pi(x, l) = f^l(x)$  is one-to-one due to the Markov property and the fact that  $R(x) > l$  for  $(x, l) \in \omega_{l,i}$ , we conclude that  $\sigma(\bigcup_{\mathcal{Q} \in \mathcal{F}} \mathcal{Q})$  is the  $\sigma$ -algebra of  $\Delta$  mod sets of

zero  $m$ -measure: just observe that given any measurable set  $\hat{B}$  (on the tower), we have

$$\hat{B} \cap \omega_{l,i} = f^{-l}(f^l(\hat{B} \cap \omega_{l,i})) \cap \omega_{l,i} = \pi^{-1}(\pi(\hat{B} \cap \omega_{l,i})) \cap \omega_{l,i},$$

and consequently  $\hat{B}$  can be written as the union of elements of the form  $\pi^{-1}(P) \cap \omega_{l,i} \in \mathcal{Q}$  for some  $Q \in \mathcal{F}$ , since  $(M, \mu)$  is a Lebesgue space and therefore the collection of all finite measurable partitions  $\mathcal{P}$  on  $M$  generates the  $\sigma$ -algebra of  $M$ . This completes the description of the family  $\mathcal{F}$  to be used in the calculation of the entropy.

In the light of (3.15), to derive the reverse inequality  $h_\nu(T) \leq h_\mu(f)$ , it is therefore sufficient to prove that given  $\varepsilon > 0$  arbitrarily small, we have

$$h_\nu(T, \mathcal{Q}) \leq h_\mu(f) + \varepsilon, \text{ for all } \mathcal{Q} \in \mathcal{F}. \quad (3.16)$$

We will achieve this using an interesting alternative way of computing the entropy derived from the Shannon-McMillan-Breiman Theorem. Given a finite measurable partition  $\mathcal{Q}$  of  $\Delta$  and  $0 < c < 1$ , let  $r(\mathcal{Q}, n, \nu, c)$  denote the minimum number of elements of  $\mathcal{Q}^n$  whose union has  $\nu$ -measure at least  $c$ . By Proposition A.1.1, we have

$$h_\nu(T, \mathcal{Q}) = \lim_{n \rightarrow \infty} \frac{1}{n} \log r(\mathcal{Q}, n, \nu, c). \quad (3.17)$$

In the light of this characterization, the heart of the proof is contained in the next claim.

*Claim 1.* Given any  $\varepsilon > 0$  and a partition  $\mathcal{Q} = \pi^{-1}(\mathcal{P}) \vee \mathcal{Q}_*^R \in \mathcal{F}$ , there exist a set  $\hat{B} \subset \Delta$  with  $c := \nu(\hat{B}) > 0$  and a constant  $C > 0$  such that, for all sufficiently large  $n$ , we can cover  $\hat{B}$  with at most  $C \cdot e^{n(h_\mu(f) + \varepsilon)}$  elements of  $\mathcal{Q}^n$ .

Note that, in particular, this implies

$$r(\mathcal{Q}, n, \nu, c) \leq C \cdot e^{n(h_\mu(f) + \varepsilon)}, \text{ for all sufficiently large } n,$$

and consequently, taking limits as  $n \rightarrow \infty$ , we have  $h_\nu(T, \mathcal{Q}) \leq h_\mu(f) + \varepsilon$ , which finishes the proof. Roughly speaking, a partition  $\mathcal{Q} = \pi^{-1}(\mathcal{P}) \vee \mathcal{Q}_*^R \in \mathcal{F}$  completely determines the partition  $\mathcal{P}$  which (partially) defines it, in the sense that the knowledge of  $\mathcal{Q}(x, l)$  contains all the information necessary to determine  $\mathcal{P}(\pi(x, l))$ . The reverse is however not true but, as it will be clear in the proof of Claim 1 to be given below, the knowledge of  $\mathcal{P}(\pi(x, l))$  conditions to a sufficiently large extent the possible choices for  $\mathcal{Q}(x, l)$ . Heuristically, this is fundamentally how one obtains (3.16) in the light of (3.17).

We now prove the Claim 1. Let  $\varepsilon > 0$  and  $\mathcal{Q} = \pi^{-1}(\mathcal{P}) \vee \mathcal{Q}_*^R \in \mathcal{F}$  be fixed. We will construct  $\hat{B}$  and exhibit  $C > 0$  as above in three steps.

1. **Determination up to the return time.** Given  $n \in \mathbb{N}$  and finite measurable partitions  $\mathcal{P} = \{P_1, \dots, P_j\}$  and  $\mathcal{Q} = \{Q_1, \dots, Q_j\}$  on  $M$  and  $\Delta$ , respectively, write

$$(i) = (i_0, \dots, i_n) := \bigcap_{k=0}^n f^{-k}(P_{i_k}),$$

$$(\underline{j}) = (j_0, \dots, j_n) := \bigcap_{k=0}^n F^{-k}(Q_{j_k}).$$

We say that an element  $(i) \in \mathcal{P}^n$  is  $\mathcal{Q}^n$ -deterministic on the base  $\Delta_0$  provided that there is a unique  $(j) \in \mathcal{Q}^n$  such that for all  $x \in (i)$  we have  $(x, 0) \in (j)$ . Given  $N \in \mathbb{N}$ , let

$$\mathcal{R}_{N^-} := \{\omega_{0,i} \in \mathcal{P}_0 \mid \omega_{0,i} \in P_{r,N} \text{ for some } 1 \leq r \leq N\}, \quad \Delta_{0,N^+} := \bigcup_{\omega_{0,i} \in \mathcal{P}_* \setminus \mathcal{R}_{N^-}} \omega_{0,i},$$

and consider the finite measurable partition on  $M$  defined by

$$\mathcal{R}_N := \mathcal{R}_{N^-} \cup \{\Delta_{0,N^+}\} \cup \{M \setminus \Delta_0\}.$$

We use this to further refine  $\mathcal{P}$ , thus obtaining a finite measurable partition  $\mathcal{P}_N := \mathcal{P} \vee \mathcal{R}_N$ . Given a partition  $\mathcal{Q} = \pi^{-1}(\mathcal{P}) \vee \mathcal{Q}_*^R \in \mathcal{F}$  it is straightforward to check from the construction that for all  $N \geq R$ , every element  $(i) \in \mathcal{P}_N^{R_i} \cap \omega_{0,i}$  for some  $\omega_{0,i} \in \mathcal{R}_{N^-}$  is  $\mathcal{Q}^{R_i}$ -deterministic, where  $R_i = R(\omega_{0,i})$ . We stress that this full determination property would not be true had we considered the partition  $\mathcal{P}$  instead of  $\mathcal{P}_N$ . For instance, knowing  $\mathcal{P}(f^k(x))$  uniquely determines the element  $\pi^{-1}(\mathcal{P}(f^k(x))) = \pi^{-1}(\mathcal{P}(\pi(T^k(x, 0)))) \in \pi^{-1}(\mathcal{P})$  but to determine  $\mathcal{Q}(T^k(x, 0))$  one would have to know additionally the element  $\mathcal{Q}_*^R(T^k(x, 0))$ , an information which can be found in  $\mathcal{R}_N$ .

2. **Construction of  $\hat{B}$ .** The construction of  $\hat{B}$  is based on the two observations below:

- (a) As a consequence of Remark A.1.2, there is a set  $A \subset M$  with  $\mu(A) > 3/4$  such that for all  $n$  sufficiently large,  $A$  is contained in the union of at most  $e^{n(h_\mu(f) + \varepsilon/3)}$  elements of  $\mathcal{P}_N^n$ .
- (b) Let  $R_M^- := \{(x, l) \in \Delta \mid R(x) \leq M\}$  and  $\Delta_{M^-} = \bigcup_{\omega_{l,i} \in \mathcal{Q}_*^{M^-}} \omega_{l,i}$ . By the integrability of the return time function  $R$ , given  $0 < \delta < 1$ , if  $M \in \mathbb{N}$  is sufficiently large, we have

$$v(\Delta_{M^-}) \geq (1 - 1/M)v(R_M^-) > 1 - \delta/2.$$

As a consequence of Birkhoff's Theorem, there is a set  $\hat{A} \subset \Delta$  with  $v(\hat{A}) > 3/4$  such that for all  $n$  sufficiently large and  $(x, l) \in \hat{A}$

$$\frac{1}{n} \#\{0 \leq k \leq n-1 \mid T^k(x, l) \in \Delta_{M^-}\} > v(\Delta_{M^-}) - \delta/2 > 1 - \delta.$$

Define  $\hat{B} = \hat{A} \cap \pi^{-1}(A) \subset \Delta$  and note that

$$\begin{aligned} v(\hat{B}) &= v(\hat{A}) + v(\pi^{-1}(A)) - v(\hat{A} \cup \pi^{-1}(A)) \\ &= v(\hat{A}) + \mu(A) - v(\hat{A} \cup \pi^{-1}(A)) \\ &> 3/4 + 3/4 - 1 \\ &= 1/2. \end{aligned}$$

3. **Combinatorial estimates.** Our final goal at this point is to bound the number of elements of  $\mathcal{Q}^n$  necessary to cover  $\hat{B}$  for all  $n$  sufficiently large as determined by the conditions appearing along the proof. We can do it by observing the following:

- (a) First, let  $(x, l) \in \hat{B}$  and consider its projection  $\pi(x, l) \in A$ . Let  $(\underline{i})$  be the element of  $\mathcal{P}_N^n$  containing  $\pi(x, l)$ .
- (b) Since,  $\pi(x, l) \in A$ , there are at most  $e^{n(h_\mu(f)+\varepsilon/3)}$  possible choices for the sequence  $(\underline{i})$ . For each of these, we want to further bound the number of possibilities for the sequence  $(\underline{j}) =$  the element of  $\mathcal{Q}^n$  that contains  $(x, l)$ .
- (c) Assume  $N \geq M \geq R$  and let  $n_1 < n_2 < \dots$  be the times  $k \in \mathbb{N}$  such that  $T^k(x, l) \in \Delta_0$ . Note that if  $T^{n_i}(x, l) \in \Delta_{M^-}$ , the indexes  $i_{n_k}, \dots, i_{n_k+R_{n_k}}$  completely determine the indexes  $j_{n_k}, \dots, j_{n_k+R_{n_k}}$  until the next return. Therefore, except possibly for the first  $M$  iterates in case  $l > 0$ , for all times  $k$  such that  $T^k(x, l) \in \Delta_{M^-}$  the index  $i_k$  determines  $j_k$ .
- (d) However, observe that, since  $(x, l) \in \hat{A}$ , for at most for  $[\delta n]$  times  $k$  we have  $T^k(x, l) \notin \Delta_{M^-}$ , where we may have some freedom of choice. There are at most  $C_{[\delta n]}^n$  possibilities for the position of such times  $k$  and for each such possibility, at most  $\#\mathcal{Q}^{[\delta n]}$  choices for the  $j_k$ .

Consequently, bounding the number of all the possibilities for  $(\underline{j})$ , we conclude that we can cover  $\hat{B}$  with at most

$$2 \cdot e^{n(h_\mu(f)+\varepsilon/3)} \cdot \#\mathcal{Q}^M \cdot C_{[\delta n]}^n \cdot \#\mathcal{Q}^{[\delta n]} \leq C \cdot e^{n(h_\mu(f)+\varepsilon)}$$

elements of  $\mathcal{Q}^n$ , provided  $0 < \delta < 1$  is sufficiently small [cf. Proposition A.1.3]. This completes the proof of the claim (and of the lemma).  $\square$





## Chapter 4

# Entropy formula for partially hyperbolic diffeomorphisms with singular sets

In this chapter, the spirit of the approach is the same as that of the previous chapter, but with increased complexity. In addition to the work done in the Chapter 3, where the existence of inducing schemes for a class of systems with singularities was essentially contained in previous literature and just recovered under a new perspective, here the main focus resides on the construction of *Young structures*, playing the same role for these systems as the Gibbs-Markov structures for endomorphisms. A main technical difference between them is the existence of contracting directions so that here the return of the partition elements only needs to stretch all the way over along the unstable direction, i.e., it does not need to be a *full return* in the previous sense. The general framework for the construction of Young structures is then provided. Accordingly, the relevant work consists on the construction of so-called *hyperbolic disks and times* for these maps as well as of a reference leaf serving as the basis for the domain of the Young structure. We postpone to the appendices the partitioning algorithm of the reference leaf and other more or less standard check-ups, as these do not contain any particular novelty or require substantial adaptations in this setting; however, the construction in [8, Section 5] from where it is drawn is improved, in the sense that clearer arguments and estimates are provided and it serves as well for the purpose of the construction of Gibbs-Markov structures for endomorphisms. In order to derive an entropy formula in terms of the *unstable Jacobian*, we essentially make use of the results and general approach of the previous chapter, but with more sophisticated tools. We introduce the *quotient dynamics* - obtained, roughly speaking, by collapsing stable leaves - and associated *tower extensions*. Perhaps more importantly, the notion of *natural extension* provides the formal way to express or deduce the heuristic and a priori expected idea that such compressing procedure - which neglects only the stable direction, where no new dynamical information is produced - preserves the entropy. We refer the reader to the reference [3] for additional background and details on the elementary material for this chapter.

## 4.1 Young structures

We say that a compact set  $\Lambda \subset M$  has a product structure if there is a family of  $C^1$  stable disks  $\Gamma^s = \{\gamma^s\}$  and a family of  $C^1$  unstable disks  $\Gamma^u = \{\gamma^u\}$  such that

- $\Lambda = (\cup \gamma^u) \cap (\cup \gamma^s)$ ;
- $\dim \gamma^u + \dim \gamma^s = \dim M$ ;
- each  $\gamma^s$  meets each  $\gamma^u$  in exactly one point;
- stable and unstable disks are transversal with angles bounded away from 0.

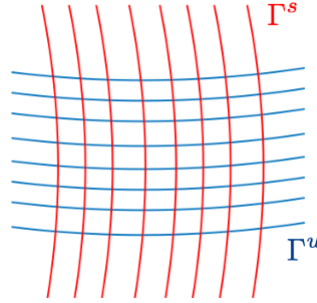

Fig. 4.1 Product structure.

Given  $x \in \Lambda$ , let  $\gamma^*(x)$  denote the disk in  $\Gamma^*$  containing  $x$ , for  $*$  =  $s, u$ . Given disks  $\gamma, \gamma' \in \Gamma^u$ , define  $\Theta_{\gamma, \gamma'} : \gamma \cap \Lambda \rightarrow \gamma' \cap \Lambda$  by

$$\Theta_{\gamma, \gamma'}(x) = \gamma^s(x) \cap \gamma', \quad (4.1)$$

and  $\Theta_\gamma : \Lambda \rightarrow \gamma \cap \Lambda$  by

$$\Theta_\gamma(x) = \Theta_{\gamma^u(x), \gamma}(x).$$

We say that the product structure is *measurable* if the maps  $\Theta_{\gamma, \gamma'}$  and  $\Theta_\gamma$  are measurable for all  $\gamma, \gamma' \in \Gamma^u$ .

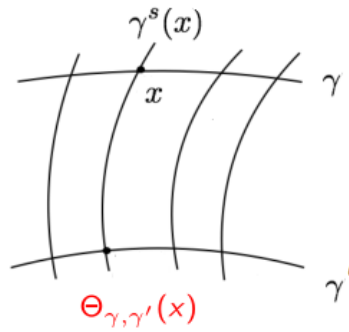

Fig. 4.2 Holonomies.

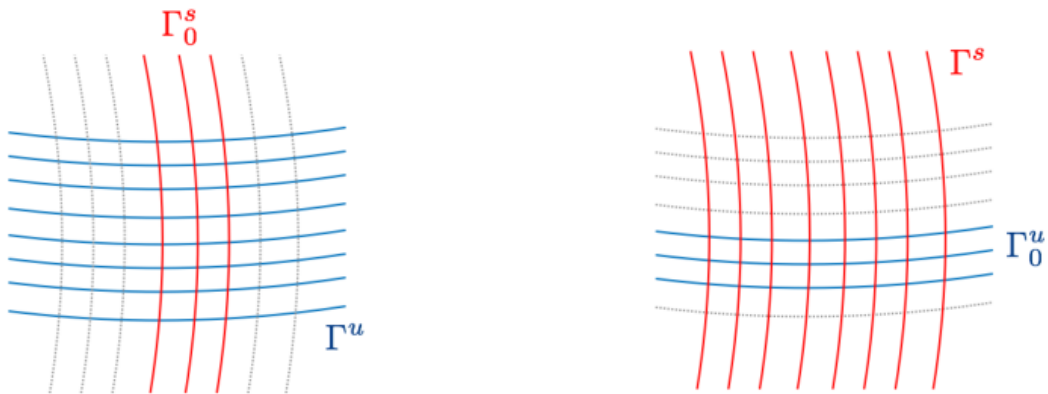

Fig. 4.3 s,u-subsets.

We say that  $\Lambda_0 \subset \Lambda$  is an *s-subset* if  $\Lambda_0$  has a product structure and its defining families  $\Gamma_0^s$  and  $\Gamma_0^u$  can be chosen with  $\Gamma_0^s \subset \Gamma^s$  and  $\Gamma_0^u = \Gamma^u$ ; *u-subsets* are defined analogously. We say that a compact subset  $\Lambda$  with a measurable product structure has a Young structure if properties (Y<sub>1</sub>)-(Y<sub>5</sub>) below hold, where the notation  $m_\gamma$  is used to denote the Lebesgue measure on the Borel sets of the submanifold  $\gamma$  induced by the Riemannian metric on  $M$ .

(Y<sub>1</sub>) *Markov*: there are pairwise disjoint *s*-subsets  $\Lambda_1, \Lambda_2, \dots \subset \Lambda$  such that

- $m_\gamma(\Lambda \cap \gamma) > 0$  and  $m_\gamma((\Lambda \setminus \cup_i \Lambda_i) \cap \gamma) = 0$  for all  $\gamma \in \Gamma^u$ ;
- for each  $i \in \mathbb{N}$  there is  $R_i \in \mathbb{N}$  such that  $f^{R_i}(\Lambda_i)$  is a *u*-subset and for all  $x \in \Lambda_i$

$$f^{R_i}(\gamma^s(x)) \subset \gamma^s(f^{R_i}(x)) \text{ and } f^{R_i}(\gamma^u(x)) \supset \gamma^u(f^{R_i}(x)).$$

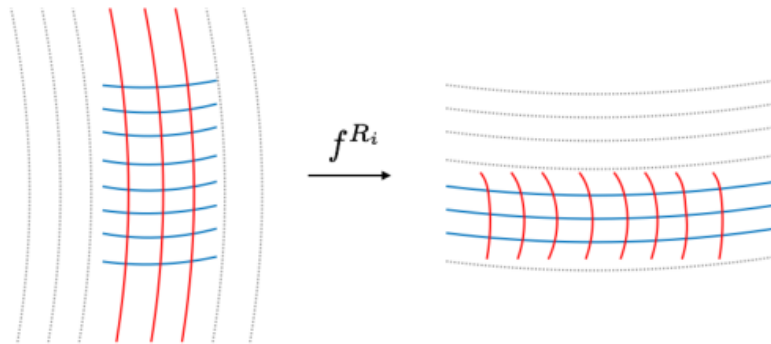

Fig. 4.4 Markov property.

The Markov property allows us to introduce a recurrence time function  $R$  and an induced map  $f^R : \Lambda \rightarrow \Lambda$ , defined respectively for each  $i \in \mathbb{N}$  as

$$R|_{\Lambda_i} = R_i \text{ and } f^R|_{\Lambda_i} = f^{R_i}|_{\Lambda_i}. \quad (4.2)$$

Observe that the functions  $R$  and  $f^R$  are defined on a full  $m_\gamma$  measure subset of  $\Lambda \cap \gamma$  for each  $\gamma \in \Gamma^u$ . Moreover,  $R$  is constant on stable disks. Since  $f$  is a diffeomorphism, it follows from (Y<sub>1</sub>) that there is  $\Lambda^* \subset \Lambda$  with  $m_\gamma(\Lambda^* \cap \gamma) = m_\gamma(\Lambda \cap \gamma)$  for each  $\gamma \in \Gamma^u$ , such that  $(f^R)^n(x)$  belongs in some  $\Lambda_i$  for every  $n \in \mathbb{N}$  and every  $x \in \Lambda^*$ . For all  $x, y \in \Lambda^*$  we may define the *separation time*

$$s(x, y) = \min\{n \geq 0 : (f^R)^n(x) \text{ and } (f^R)^n(y) \text{ lie in distinct } \Lambda_i \text{'s}\},$$

with the convention  $\min(\emptyset) = \infty$ . As we aim at results in a measure theoretical sense with respect to the measures  $m_\gamma$  (or some measures absolutely continuous with respect to  $m_\gamma$ ), we may assume with no loss of generality that the separation time is defined for all  $x, y \in \Lambda$ .

For the remaining properties, we assume that  $C > 0$  and  $0 < \beta < 1$  are constants only depending on  $f$  and  $\Lambda$ .

(Y<sub>2</sub>) *Contraction on stable disks*: for all  $\gamma^s \in \Gamma^s$  and  $x, y \in \gamma^s$  we have

- $\text{dist}(f^R(y), f^R(x)) \leq \beta \text{dist}(x, y)$ ;
- $\text{dist}(f^j(y), f^j(x)) \leq C \text{dist}(x, y)$ , for all  $1 \leq j \leq R(x)$ .

(Y<sub>3</sub>) *Expansion on unstable disks*: for all  $\gamma \in \Gamma^u$ , all  $\Lambda_i$  and  $x, y \in \gamma \cap \Lambda_i$  we have

- $\text{dist}(x, y) \leq \beta \text{dist}(f^R(y), f^R(x))$ ;
- $\text{dist}(f^j(y), f^j(x)) \leq C \text{dist}(f^R(x), f^R(y))$ , for all  $1 \leq j \leq R(x)$ .

(Y<sub>4</sub>) *Absolute continuity of  $\Gamma^s$* : for all  $\gamma, \gamma' \in \Gamma^u$ , the map  $\Theta_{\gamma, \gamma'}$  is absolutely continuous; moreover, letting  $\xi_{\gamma, \gamma'}$  denote the density of  $(\Theta_{\gamma, \gamma'})_* m_\gamma$  with respect to  $m_{\gamma'}$ , we have for all  $x, y \in \gamma' \cap \Lambda$

$$\frac{1}{C} \leq \xi_{\gamma, \gamma'}(x) \leq C \text{ and } \log \frac{\xi_{\gamma, \gamma'}(x)}{\xi_{\gamma, \gamma'}(y)} \leq C\beta^{s(x, y)}.$$

(Y<sub>5</sub>) *Bounded distortion*: there is  $\gamma_0 \in \Gamma^u$  such that for all  $\Lambda_i$  and all  $x, y \in \gamma_0 \cap \Lambda_i$ , we have

$$\log \frac{\det Df_0^R(x)}{\det Df_0^R(y)} \leq C\beta^{s(f^R(x), f^R(y))},$$

where  $f_0^R$  stands for the restriction of  $f^R$  to  $\gamma_0$ .

We say that the Young structure has *integrable recurrence times* if  $R$  is integrable with respect to  $m_{\gamma_0}$  for some (and hence all, by absolute continuity)  $\gamma_0 \in \Gamma^u$ .

## 4.2 Extensions and quotient dynamics

In this section, we review and summarize in a slightly different way classical material concerning a collapsing procedure along stable leaves which can be found in [76, 77] as well as useful extensions for the entropy formula.

### Tower extension

Given a Young structure  $\Lambda$ , let  $R : \Lambda \rightarrow \mathbb{N}$  be the recurrence time function and  $f^R : \Lambda \rightarrow \Lambda$  the induced map defined as in (4.2). Consider the tower

$$\hat{\Delta} = \{(x, l) : x \in \Lambda \text{ and } 0 \leq l < R(x)\},$$

and the tower map  $\hat{T} : \hat{\Delta} \rightarrow \hat{\Delta}$ , given by

$$\hat{T}(x, l) = \begin{cases} (x, l+1), & \text{if } l < R(x) - 1 \\ (f^R(x), 0), & \text{if } l = R(x) - 1 \end{cases}$$

Notice that the present situation is not exactly as in the tower extension for Gibbs-Markov maps, since we formally do not have a reference measure on  $\Lambda$  and a mod 0 partition into disjoint sets. Nevertheless, the Markov property (Y<sub>1</sub>) provides a countable collection of pairwise disjoint subsets of  $\Lambda$  that induces a  $m_\gamma$  mod 0 partition of  $\gamma \cap \Lambda$  for each  $\gamma \in \Gamma^u$ .

The base  $\hat{\Delta}_0$  of the tower  $\hat{\Delta}$  is naturally identified with the set  $\Lambda$ , and each level  $\hat{\Delta}_l$  with the set  $\{R > l\} \subset \Lambda$ . This allows us to refer to stable and unstable disks through points in the tower, naturally considering the corresponding disks for their representatives in the ground level. Also,  $\{\Lambda_1, \Lambda_2, \dots\}$  is a family of pairwise disjoint subsets of  $\hat{\Delta}_0$  whose union intersects each unstable disk  $\gamma \in \Gamma^u$  on a full  $m_\gamma$  measure subset of points in  $\gamma \cap \Lambda$ . This naturally gives rise to subfamilies on each level  $\hat{\Delta}_l$  with similar properties. Collecting all these families, we obtain a countable family  $\hat{\mathcal{Q}}$  into pairwise disjoint subsets of the tower  $\hat{\Delta}$  whose union intersects each unstable disk  $\gamma \in \Gamma^u$  on a full  $m_\gamma$  measure subset of points. Defining  $\pi : \hat{\Delta} \rightarrow M$  by  $\pi(x, l) = f^l(x)$ , we have  $f \circ \pi = \pi \circ \hat{T}$ .

### Quotient dynamics and tower

We introduce a *quotient map* of the induced map  $f^R$  of a Young structure  $\Lambda$ , by *collapsing* stable leaves. Given  $\gamma_0 \in \Gamma^u$  as in (Y<sub>5</sub>), consider the *quotient map*  $F : \gamma_0 \cap \Lambda \rightarrow \gamma_0 \cap \Lambda$  of  $f^R$ , defined as

$$F(x) = \Theta_{\gamma_1, \gamma_0} \circ f^R(x), \quad (4.3)$$

with  $\gamma_1 = \gamma^\mu(f^R(x))$  and  $\Theta_{\gamma_1, \gamma_0}$  as in (4.1). The quotient map  $F$  is Gibbs-Markov with respect to the  $m = m_{\gamma_0}$  mod 0 partition  $\mathcal{P} = \{\gamma_0 \cap \Lambda_1, \gamma_0 \cap \Lambda_2, \dots\}$  of  $\gamma_0 \cap \Lambda$ , as in Section 3.1. From this fact, it follows that the induced map of a Young structure  $f^R : \Lambda \rightarrow \Lambda$  has a unique ergodic SRB measure  $\nu$  whose densities of its conditionals with respect to Lebesgue conditionals on unstable disks are uniformly

bounded from above and below by positive constants and  $\nu_0 = (\Theta_{\gamma_0})_* \nu$  is the ergodic  $F$ -invariant probability measure such that  $\nu_0 \ll m_{\gamma_0}$ . Then, assuming the integrability of recurrence times, the measure

$$\mu = \frac{1}{\sum_{j \geq 0} \nu\{R > j\}} \sum_{j \geq 0} f_*^j(\nu|\{R > j\}) \quad (4.4)$$

is the unique ergodic SRB measure of  $f$  with  $\mu(\Lambda) > 0$ . Moreover, in that case  $\hat{T}$  has a unique ergodic SRB measure  $\hat{\nu}$  such that  $\mu = \pi_* \hat{\nu}$ .

Consider an unstable disk  $\gamma_0 \in \Gamma^u$  as in (Y5) and the quotient map  $F : \gamma_0 \cap \Lambda \rightarrow \gamma_0 \cap \Lambda$ . We can therefore consider a tower map  $T : \Delta \rightarrow \Delta$  associated to  $F$  with recurrence times  $R$  as in Subsection 3.2, and call it the *quotient tower*. Interpreting, as usual, each  $\gamma_0 \cap \Lambda_i$  as an element of the natural partition of the ground level of the tower  $\Delta_0$ , we clearly have

$$R|_{\gamma_0 \cap \Lambda_i} = R|_{\Lambda_i} = R_i, \text{ for all } i \geq 1.$$

Therefore, we may use the same recurrence time  $R$  for the two tower maps  $\hat{T}$  and  $T$ , and it is easy to see that we have  $\Delta \subset \hat{\Delta}$ . We introduce the *quotient projection map*  $\Theta : \hat{\Delta} \rightarrow \Delta$  given by  $\Theta(x, l) = (\Theta_{\gamma_0}(x), l)$ , which naturally semiconjugates the two towers:  $T \circ \Theta = \Theta \circ \hat{T}$  (observe that  $\Theta$  is not necessarily countable-to-one). In addition, if  $\hat{\nu}$  is the ergodic SRB measure of  $\hat{T}$ , the measure  $\Theta_* \hat{\nu}$  is the ergodic  $T$ -invariant probability measure absolutely continuous with respect to  $m_{\gamma_0}$  (on the tower). In other words, the m.p.s.  $(f, \mu)$  and  $(T, \Theta_* \hat{\nu})$  are factors of  $(\hat{T}, \hat{\nu})$ .

$$\begin{array}{ccccc} (M, \mu) & \xleftarrow{\pi} & (\hat{\Delta}, \hat{\nu}) & \xrightarrow{\Theta} & (\Delta, \Theta_* \hat{\nu}) \\ \downarrow f & & \hat{T} \downarrow \hat{T} & & T \downarrow \\ (M, \mu) & \xleftarrow{\pi} & (\hat{\Delta}, \hat{\nu}) & \xrightarrow{\Theta} & (\Delta, \Theta_* \hat{\nu}) \end{array}$$

### Natural extension

The *natural extension* of the tower system  $(\hat{\Delta}, \hat{\mathcal{B}}, \hat{\nu}, \hat{T})$  is a new measure preserving system  $(\hat{\Delta}^\#, \hat{\mathcal{B}}^\#, \hat{\nu}^\#, \hat{T}^\#)$  defined as follows: the phase space is

$$\hat{\Delta}^\# := \{(\dots, (x_{-1}, l_{-1}), (x_0, l_0)) \in \prod_{-\infty}^{i=0} \hat{\Delta} \mid \hat{T}(x_n, l_n) = (x_{n+1}, l_{n+1}) \text{ for all } n < 0\}$$

and the dynamics  $\hat{T}^\# : \hat{\Delta}^\# \rightarrow \hat{\Delta}^\#$  is defined by

$$\hat{T}^\#(\dots, (x_{-1}, l_{-1}), (x_0, l_0)) := (\dots, (x_{-1}, l_{-1}), (x_0, l_0), \hat{T}(x_0, l_0)).$$

The  $\sigma$ -algebra  $\hat{\mathcal{B}}^\#$  is the one generated by *cylinder sets* of the form

$$[A_k, \dots, A_0] := \{(x_n, l_n)_{n \leq 0} \in \hat{\Delta}^\# \mid (x_i, l_i) \in A_i \text{ for all } i = k, \dots, 0\},$$

where  $A_i \in \hat{\mathcal{B}}$  for all  $i = k, \dots, 0$ , so that the extended measure is given by

$$\hat{\nu}^\#([A_k, \dots, A_0]) := \hat{\nu}(A_k \cap \hat{T}^{-1}(A_{k-1}) \cap \dots \cap \hat{T}^{-k}(A_0)).$$

The natural extension  $(\Delta^\#, \mathcal{B}^\#, (\Theta_* \hat{\nu})^\#, T^\#)$  of the quotient tower, playing an important role in our arguments, is defined analogously. On the other hand, the associated natural projection maps on the  $0^{\text{th}}$  coordinate of the extended spaces are not particularly relevant here.

### 4.3 Theoretical framework

The existence of a finite collection of transitive attractors  $\Omega_1, \dots, \Omega_l$  in the hypothesis of Theorem B, with the property that each  $\Omega = \Omega_j$  contains a *cu-disk*  $\Sigma = \Sigma_j$  of some fixed radius on which  $f$  is nonuniformly expanding and has slow recurrence to the singular set  $\mathcal{S}$  follows very much along the same lines of the general argument to prove [8, Proposition 4.1]. The additional work required consists on construction of the so-called *hyperbolic disks* of radius  $\delta_1 > 0$  in the presence of a singular set - a fundamental part of the whole argument - which is properly done in Section 4.4. Having in mind natural adaptations coming from the introduction of the slow recurrence condition to deal with the presence of singularities - which is actually the basis for the construction of the aforementioned hyperbolic disks in that context - there is really nothing new to be done here and we restrain ourselves to the presentation of the general picture, that resembles that of the first part of Theorem 3.3.1.

**Proposition 4.3.1.** *Under the hypothesis of Theorem B,*

1. *there exist closed invariant sets  $\Omega_1, \dots, \Omega_l \subseteq K$  such that for Lebesgue almost every  $x \in H$  we have  $\omega(x) = \Omega_j$  for some  $1 \leq j \leq l$ ;*
2. *each  $\Omega_j$  is transitive and contains a cu-disk  $\Sigma_j$  of radius  $\delta_1/4$  on which  $f$  is nonuniformly expanding along  $E^{cu}$  and exhibits slow recurrence to the singular set for  $\text{Leb}_{\Sigma_j}$ -almost every point  $x \in \Sigma_j$ .*

We fix some  $\Omega = \Omega_j$  and  $\Sigma = \Sigma_j$  as in the previous proposition for the rest of the chapter and localize the construction of a Young structure on this region. Recall that we denote for each  $n \geq 1$ ,

$$\text{dist}_n := \text{dist}_{f^n(\Sigma)} \text{ and } \text{Leb}_n = \text{Leb}_{f^n(\Sigma)}, \quad (4.5)$$

where  $\text{dist}_{f^n(\Sigma)}$  stands for the distance in the submanifold  $f^n(\Sigma)$  and  $\text{Leb}_{f^n(\Sigma)}$  the Lebesgue measure on the Borel sets of  $f^n(\Sigma)$ , both induced by the Riemannian metric on  $M$ . When merely using the above notation, the manifold  $\Sigma$  considered depends upon the context: in general,  $f^n(\Sigma)$  might possibly be a submanifold with singularities or even a finite union of disjoint submanifolds. Therefore, whenever we use  $\text{dist}_n$  it should be implicit that  $\Sigma$  is such that all the iterates  $f^k(\Sigma)$  with  $0 \leq k \leq n$  are submanifolds disjoint from the singular set  $\mathcal{S}$ . From the assumption (E<sub>2</sub>), there is a constant  $\delta_s > 0$  so that local stable

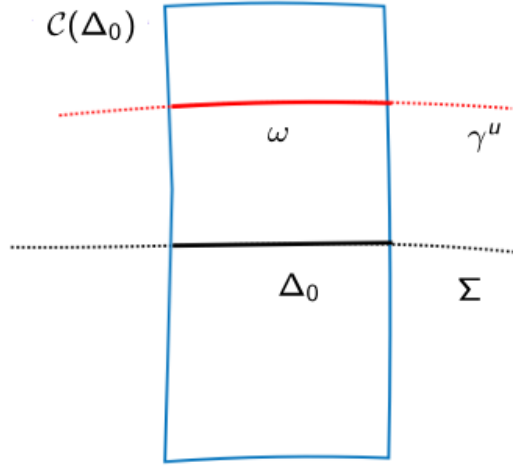
Fig. 4.5  $u$ -crossing.

manifolds  $W_{\delta_s}^s(x)$  are defined for Lebesgue almost all points  $x \in \Sigma$ . Moreover, for any subdisk  $\Delta_0 \subset \Sigma$  we define the *cylinder*

$$\mathcal{C}(\Delta_0) := \bigcup_{x \in \Delta_0} W_{\delta_s}^s(x), \quad (4.6)$$

and let  $\Theta$  denote the projection from  $\mathcal{C}(\Delta_0)$  onto  $\Delta_0$  along local stable leaves. We say that a centre-unstable disk  $\gamma^u \subset M$  *u-crosses*  $\mathcal{C}(\Delta_0)$  if there exists a connected component  $\omega$  of  $\gamma^u \cap \mathcal{C}(\Delta_0)$  such that  $\Theta(\omega) = \Delta_0$ . We will often be considering *cu*-disks which *u-cross*  $\mathcal{C}(\Delta_0)$  for some centre-unstable subdisk  $\Delta_0$ . By continuity of the stable foliation, if we choose  $\delta_s$  sufficiently small, then the diameter and Lebesgue measure of the intersection of such disks with  $\mathcal{C}(\Delta_0)$  are very close to those of  $\Delta_0$ , respectively. To simplify the notation and the calculations we will ignore this difference as it has no significant effect on the estimates. The core idea is then to show that there is an unstable disk  $\Delta_0 \subset \Sigma$  of the same dimension of  $\Sigma$  and sets for which the conditions (A<sub>1</sub>)-(A<sub>3</sub>) hold, namely:

(A<sub>1</sub>) There are compact sets  $H_1, H_2, \dots \subset \Delta_0$  such that for Lebesgue almost every  $x \in \Delta_0$

- a.  $x \in H_n \implies f^k(x) \in H_{n-k}$ , for all  $0 \leq k \leq n$ ,
- b.  $x$  belongs to  $H_n$  for infinitely many  $n$ .

(A<sub>2</sub>) There is  $\delta_1 > 0$  such that for each  $x \in H_n$  there is a neighbourhood  $V_n(x)$  of  $x$  in  $\Sigma$  such that  $f^n$  maps diffeomorphically to a disk of radius  $\delta_1$  centered at  $f^n(x)$ . Moreover, there are  $C_0, \eta > 0$  and  $0 < \sigma < 1$  such that for all  $V_n(x)$  and all  $y, z \in V_n(x)$  we have

- $\text{dist}_{n-k}(f^{n-k}(y), f^{n-k}(z)) \leq \sigma^k \text{dist}_n(f^n(y), f^n(z))$ , for all  $1 \leq k \leq n$ .
- $\log \frac{|\det Df^n|_{T_y \Sigma}}{|\det Df^n|_{T_z \Sigma}} \leq C_0 \text{dist}_n(f^n(y), f^n(z))^\eta$ .



The sets  $V_n(x)$  are called *hyperbolic pre-disks* and their images  $f^n(V_n(x)) = B_{\delta_1}^u(f^n(x))$  are called *hyperbolic disks*. As before, we will consider the sets  $W_n(x) \subset \tilde{W}_n(x) \subset V_n(x)$  such that  $f^n$  maps  $W_n(x)$  diffeomorphically to the disk of radius  $\delta_1/9$  and  $\tilde{W}_n(x)$  to the disk of radius  $\delta_1/3$ , both centered at  $f^n(x)$ .

(A<sub>3</sub>) There are  $L, \delta_0 > 0$  such that for each  $x \in H_n$  we have  $0 \leq l = l(x) \leq L$  and domains  $\omega_{n,l}(x) \subset \tilde{\omega}_{n,l}(x) \subset W_n(x)$  with  $f^{n+l}(\omega_{n,l}(x))$   $u$ -crossing the cylinder around a  $cu$ -disk of radius  $\delta_0$  and  $f^{n+l}(\tilde{\omega}_{n,l}(x))$   $u$ -crossing the cylinder around a concentric  $cu$ -disk of radius  $2\delta_0$ . Moreover, there are  $C_1, \eta > 0$  such that for every  $\tilde{\omega}_{n,l}(x)$  and every  $y, z \in f^n(\tilde{\omega}_{n,l}(x))$  we have

- a.  $\frac{1}{C_1} \text{dist}(x, y) \leq \text{dist}_l(f^l(y), f^l(z)) \leq C_1 \text{dist}(y, z)$
- b.  $\log \left| \frac{\det Df^l|_{T_y\Sigma}}{\det Df^l|_{T_z\Sigma}} \right| \leq C_1 \text{dist}_l(f^l(y), f^l(z))^\eta$ .

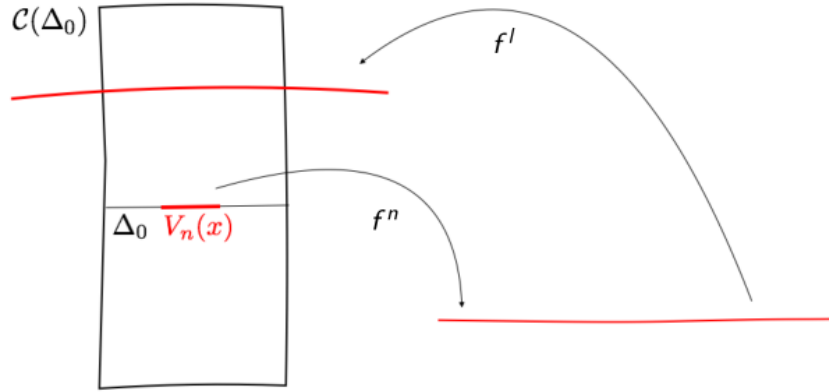

Fig. 4.6 Recurrence to the cylinder  $\mathcal{C}(\Delta_0)$ .

In this chapter, we concern ourselves only with the exhibition of  $\Delta_0$  and the verification of properties (A<sub>1</sub>)-(A<sub>3</sub>) above, which is the principal novelty for the class of partially hyperbolic systems with singularities we consider in this thesis. The remaining of the construction of a Young structure is postponed to Appendix B since it contains no significant novelty in comparison with previous works on partially hyperbolic systems; cf. [8]. The conditions (A<sub>1</sub>), (A<sub>2</sub>) are intimately related to the notion of *hyperbolic disks and times* that we explore in Section 4.4. These are the most fundamental mathematical objects to implement our strategy regarding the construction of Young structures. Roughly speaking, the sets  $V_n(x)$  will be obtained using some uniform expansion property for the points in  $H_n$  at time  $n$ , causing small neighbourhoods of such points to grow to disks of large scale. On the other hand, the property (A<sub>3</sub>) - which in particular allows us to define integrable recurrence times to some Young structure containing  $\Delta_0$  as an unstable leaf - is derived assuming some transitivity of the system akin to the endomorphism case and is carefully treated in Section 4.5.

## 4.4 Hyperbolic disks and times

In this section, aiming at establishing the properties (A<sub>1</sub>)-(A<sub>2</sub>) on an arbitrary centre-unstable disk  $\Sigma$ , we present the notion of *hyperbolic times* introduced by J. F. Alves in [2] and the intimately related geometric objects named *hyperbolic (pre-)disks*. Roughly speaking, these are neighbourhoods of points admitting hyperbolic times that are uniformly expanded by the respective hyperbolic time iterate of  $f$  onto a ball of fixed radius, with uniformly bounded distortion. For the sake of convenience, we fix once and for all  $\alpha, \beta, B > 0$  as in the definition of the nondegenerate singular set and take  $b > 0$  such that

$$b < \frac{1}{2} \min\{1, \alpha^{-1}\beta\}. \quad (4.7)$$

Given  $\sigma \in (0, 1)$  and  $r > 0$ , we say that  $n \in \mathbb{N}$  is a  $(\sigma, r)$ -hyperbolic time for a point  $x \in K$ , if for all  $1 \leq k \leq n$  we have

1.  $\prod_{j=n-k+1}^n \|Df^{-1}|E_{f^j(x)}^{cu}\| \leq \sigma^k$ ,
2.  $\text{dist}_r(f^{n-k}(x), \mathcal{S}) \geq \sigma^{bk} > 0$ .

Here, we use the letter  $r$  on the subscript of 'dist' to refer to the *truncated distance* to the singular set defined in (2.5), while reserving the letters  $k, n$  to denote the distance on the iterated disks as in (4.5). Observe that the first condition in the definition of  $(\sigma, r)$ -hyperbolic times implies that  $Df^{-k}|E_{f^n(x)}^{cu}$  is a  $\sigma^k$ -contraction for every  $1 \leq k \leq n$ . The second condition ensures that the iterates  $f^k(x)$  with  $0 \leq k < n$  are not too close to  $\mathcal{S}$ . In particular, all the points in the set

$$H_n := \{x \in H : n \text{ is } (\sigma, r)\text{-hyperbolic time for } x\} \quad (4.8)$$

are uniformly distant away from  $\mathcal{S}$ :  $\text{dist}(x, \mathcal{S}) \geq r_n := r \cdot \sigma^{bn} > 0$ . The next result asserts the existence of infinitely many  $(\sigma, r)$ -hyperbolic times for points satisfying the weak nonuniform expansion condition (2.20) and exhibiting slow recurrence to the singular set  $\mathcal{S}$  (2.21).

**Lemma 4.4.1.** *There are  $0 < \sigma, r < 1$  and  $\theta > 0$  such that for all  $x \in H \subset K$ ,*

$$\limsup_{n \rightarrow \infty} \frac{1}{n} \#\{1 \leq j \leq n \mid j \text{ is a } (\sigma, r)\text{-hyperbolic time for } x\} \geq \theta. \quad (4.9)$$

*Remark 4.4.2.* Under the weaker version of nonuniform expansivity expressed in (2.20), we are unable to prove the existence of a *positive frequency* of hyperbolic times at infinity for points  $x \in H$ , as is done in [5, Corollary 3.2]: by *positive frequency* we mean that there is  $\theta > 0$  such that given any  $x \in H$  and any sufficiently large  $N \geq 1$ , there exist  $(\sigma, r)$ -hyperbolic times  $1 \leq n_1 < \dots < n_l \leq N$  for  $x$ , with  $l \geq \theta \cdot N$ . In other words, we would be able to replace the limsup by a liminf in (4.9). For our purposes, the existence of infinitely many hyperbolic times for points satisfying (2.20) and (2.21), as implied by (4.9) is enough.

**Lemma 4.4.3.** [5, (Pliss) Lemma 3.1] Given  $A \geq c_2 > c_1$ , define  $\theta := (c_2 - c_1)/(A - c_1) \in (0, 1]$ . Assume that  $a_1, \dots, a_N$  are real numbers satisfying

1.  $a_j \leq A$  for every  $1 \leq j \leq N$ , and
2.  $\sum_{j=1}^N a_j \geq c_2 N$ .

Then, there are  $l \geq \theta \cdot N$  and natural numbers  $1 < n_1 < \dots < n_l \leq N$  satisfying

$$\sum_{j=n+1}^{n_i} a_j \geq c_1(n_i - n)$$

for every  $i = 1, \dots, l$  and  $0 \leq n < n_i$ .

*Proof.* Define  $S_0 = 0$  and

$$S_n = \sum_{j=1}^n (a_j - c_1), \text{ for each } 1 \leq n \leq N.$$

Take  $1 < n_1 < \dots < n_l \leq N$  a maximal sequence such that  $S_{n_i} \geq S_n$  for every  $0 \leq n < n_i$  and  $1 \leq i \leq l$ . Observe that such a sequence exists: since  $S_N > 0 = S_0$ , we must have  $l \geq 1$ . Moreover, for each  $1 \leq i \leq l$ , we have

$$\sum_{j=n+1}^{n_i} a_j \geq c_1(n_i - n), \text{ for } 0 \leq n < n_i.$$

We are left to verify that  $l \geq \theta \cdot N$ . Defining for convenience  $n_0 = 0$ , by the choice of the maximal sequence times we have, for each  $1 \leq i \leq l$ ,

$$S_{n_i-1} < S_{n_{i-1}}.$$

Therefore, adding  $A - c_1 \geq a_{n_i} - c_1$  to both sides we obtain for each  $1 \leq i \leq l$

$$S_{n_i} < S_{n_{i-1}} + (A - c_1) \Leftrightarrow S_{n_i} - S_{n_{i-1}} < (A - c_1).$$

Moreover, observing that  $S_{n_l} \geq S_N \geq N(c_2 - c_1)$ , we get

$$N(c_2 - c_1) \leq S_{n_l} = \sum_{i=1}^l S_{n_i} - S_{n_{i-1}} < l(A - c_1)$$

which completes the proof. □

Given  $x \in H$ , the strategy to prove Lemma 4.4.1 is to use Pliss' Lemma twice: first, for the sequence

$$D_j = -\log \|Df^{-1}|E_{f^j(x)}^{cu}\|, j \geq 1, \tag{4.10}$$

up to a cut off that makes it bounded from above, and then with

$$d_j = \log \text{dist}_r(f^{j-1}(x), \mathcal{S}), j \geq 1, \tag{4.11}$$

for a convenient choice of  $r > 0$ . A routine check shows that any time  $n_i$  for which the conclusions of Pliss' Lemma hold, simultaneously, for both of the sequences introduced above is actually a  $(\sigma, r)$ -hyperbolic time for  $x$  and we prove the 'frequency' of such  $n_i$  accords with (4.9). Recall that we have assumed that  $0 < b < \min\{1/2, 1/2\beta\}$ .

*Proof.* (of Lemma 4.4.1) We start with the sequence (4.10). First, observe that for  $x \in H$ , the non-uniform expansion condition (2.20) implies that

$$E(x) := \{N \in \mathbb{N} \mid \sum_{j=1}^N -\log \|Df^{-1}|E_{f^j(x)}^{cu}\| \geq \lambda N\}$$

is an infinite set. Given  $N \in E(x)$  sufficiently large, we define a sequence  $a_1, \dots, a_N$  by

$$a_j = \begin{cases} -\log \|Df^{-1}|E_{f^j(x)}^{cu}\| & \text{if } j \notin J_N \\ 0 & \text{if } j \in J_N \end{cases}$$

where  $J_N$  is a subset of times contained in  $\{1, \dots, N\}$  specified in the next steps:

1. by the condition (1) in the definition of singular set, we have

$$|\log \|Df^{-1}|E_{f(x)}^{cu}\|| \leq |\log B| + \alpha |\log \text{dist}(x, \mathcal{S})| \leq \rho |\log \text{dist}(x, \mathcal{S})|, \quad (4.12)$$

for every  $x \in K \setminus \mathcal{S}$  in a sufficiently small neighbourhood  $\mathcal{U}$  of  $\mathcal{S}$ , say

$$\text{dist}(x, \mathcal{S}) < \varepsilon < 1, \text{ for all } x \in \mathcal{U},$$

provided  $\rho > \alpha$  is large enough. Let  $M$  be an upper bound of  $-\log \|Df^{-1}|E_{f(x)}^{cu}\|$  for  $x$  on the (compact) complement of  $\mathcal{U}$  where the function is defined.

2. Given  $\varepsilon_1 > 0$  such that  $\rho\varepsilon_1 \leq \lambda/2$ , the slow recurrence condition (2.21) implies the existence of  $1 > r_1 > 0$  such that

$$\sum_{j=1}^N -\log \text{dist}_{r_1}(f^{j-1}(x), \mathcal{S}) \leq \varepsilon_1 N,$$

for all large  $N$ .

3. Let  $A \geq \max\{\rho|\log r_1|, M, \lambda\}$  and define

$$J_N := \{1 \leq j \leq N \mid -\log \|Df^{-1}|E_{f^j(x)}^{cu}\| > A\}.$$

We claim  $a_1, \dots, a_N$  satisfies the hypothesis of Lemma 4.4.3 with  $A$  as defined above,  $c_1 = \lambda/4$  and  $c_2 = \lambda/2$ . By definition, we have  $a_j \leq A$  for all  $1 \leq j \leq N$ . Moreover, observe that if  $j \in J_N$ , then

- $f^{j-1}(x) \in \mathcal{U}$ , and in particular,  $\text{dist}(f^{j-1}(x), \mathcal{S}) < 1$ ;

- $r_1 > \text{dist}(f^{j-1}(x), \mathcal{S}) = \text{dist}_{r_1}(f^{j-1}(x), \mathcal{S})$ , since

$$\rho |\log r_1| \leq A < -\log \|Df^{-1}|E_{f^j(x)}^{cu}\| < \rho |\log \text{dist}(f^{j-1}(x), \mathcal{S})|.$$

Using the previous observations, we conclude that

$$\begin{aligned} \sum_{j=1}^N a_j &= \sum_{j=1}^N -\log \|Df^{-1}|E_{f^j(x)}^{cu}\| - \sum_{j \in J_N} -\log \|Df^{-1}|E_{f^j(x)}^{cu}\| \\ &\geq \sum_{j=1}^N -\log \|Df^{-1}|E_{f^j(x)}^{cu}\| - \rho \sum_{j \in J_N} |\log \text{dist}_{r_1}(f^{j-1}(x), \mathcal{S})| \\ &\geq (\lambda - \rho \varepsilon_1)N \\ &\geq \frac{\lambda}{2}N = c_2N \end{aligned}$$

Therefore, the lemma provides a frequency  $\theta_1 > 0$  and  $l_1 \geq \theta_1 N$  times  $1 \leq p_1 < p_2 \cdots < p_{l_1} \leq N$  such that

$$\sum_{j=n+1}^{p_i} -\log \|Df^{-1}|E_{f^j(x)}^{cu}\| \geq \sum_{j=n+1}^{p_i} a_j \geq \frac{\lambda}{4}(p_i - n)$$

for every  $1 \leq i \leq l_1$  and  $0 \leq n \leq p_i - 1$ . Now, we turn our attention to the sequence (4.11). Again, given  $0 < \varepsilon_2 < \theta_1 b \lambda / 4$ , there is  $1 > r_2 > 0$  such that  $\sum_{j=1}^N \log \text{dist}_{r_2}(f^{j-1}(x), \mathcal{S}) \geq -\varepsilon_2 N$  for all large  $N$ . Applying Lemma 4.4.3 to the sequence  $a_j = \log \text{dist}_{r_2}(f^{j-1}(x), \mathcal{S})$  with  $1 \leq j \leq N$  and parameters  $c_1 = -b \lambda / 4$ ,  $c_2 = -\varepsilon_2$ ,  $A = 0$  and

$$\theta_2 = \frac{c_2 - c_1}{A - c_1} = 1 - \frac{4\varepsilon_2}{b\lambda} > 1 - \theta_1,$$

we conclude that there are  $l_2 \geq \theta_2 N$  times  $1 \leq q_1 < \cdots < q_2 \leq N$  such that

$$\sum_{j=n}^{q_i-1} \log \text{dist}_{r_2}(f^j(x), \mathcal{S}) \geq -b\lambda/4(q_i - n)$$

for every  $1 \leq i \leq l_2$  and  $0 \leq n < q_i$ . Finally, since  $\theta = \theta_1 + \theta_2 - 1 > 0$ , there exist  $l = (l_1 + l_2 - N) \geq \theta N$  times  $1 \leq n_1 < \cdots < n_l \leq N$  at which

$$\sum_{j=n+1}^{n_i} -\log \|Df^{-1}|E_{f^j(x)}^{cu}\| \geq \lambda/4(n_i - n) \text{ and } \sum_{j=n+1}^{n_i} \log \text{dist}_{r_2}(f^{j-1}(x), \mathcal{S}) \geq -b\lambda/4(n_i - n),$$

for every  $1 \leq i \leq l$  and  $0 \leq n < n_i$ . Letting  $\sigma = e^{-\lambda/4}$  and  $r = r_2$ , we easily obtain from the inequalities above that

$$\Pi_{j=n_i-k+1}^{n_i} \|Df^{-1}|E_{f^j(x)}^{cu}\| \leq \sigma^k \text{ and } \text{dist}_r(f^{n_i-k}(x), \mathcal{S}) \geq \sigma^{bk} > 0$$

for all  $1 \leq i \leq l$  and  $1 \leq k \leq n_i$ . In other words, all of those  $n_i$  are  $(\sigma, r)$ -hyperbolic times for  $x$ .  $\square$

The  $cu$ -disk  $\Sigma$  may be assumed to be almost everywhere contained in  $H$ , so, given any  $\Delta_0 \subset \Sigma$ , we define the sets

$$H_n := \{x \in H \cap \Delta_0 : n \text{ is a } (\sigma, r)\text{-hyperbolic time for } x\}.$$

We can easily check from the definition of hyperbolic times and Lemma 4.4.1 that for every  $x \in H \cap \Delta_0$  we have

- $x \in H_n \implies f^k(x) \in H_{n-k}$ , for all  $0 \leq k \leq n$ ;
- $x$  belongs to  $H_n$  for infinitely many  $n$ , more precisely, there is  $\theta > 0$  such that

$$\limsup_{n \rightarrow \infty} \frac{1}{n} \#\{1 \leq j \leq n \mid x \in H_j\} \geq \theta.$$

This is essentially the content of property (A<sub>1</sub>). Hyperbolic times naturally provide nontrivial pointwise information about the dynamics of the points where they are defined but, as we shall see below, these properties can be extended to an *unstable* neighbourhood of the reference point. This fact, which goes in the direction of (A<sub>2</sub>), is properly expressed in the result below, where  $0 < \sigma, r < 1$  are fixed once and for all according to the Lemma 4.4.1.

**Lemma 4.4.4.** *There exists  $\delta_1 > 0$  for which the following property holds: given any  $C^1$  centre-unstable disk  $\Sigma \subset \mathcal{V}$  with radius  $0 < r < \delta_1$ , there is  $n_0 := n_0(r, \delta_1, \sigma) \in \mathbb{N}$  such that if  $n \geq n_0$  is a  $(\sigma, r)$ -hyperbolic time for a point  $x \in \Sigma \cap H$  with  $\text{dist}_\Sigma(x, \partial\Sigma) > r/2$ , there exists a neighbourhood  $V_n(x)$  of  $x$  in  $\Sigma$  such that*

1.  $f^n$  maps  $V_n(x)$  diffeomorphically onto a (full)  $cu$ -disk  $B_{\delta_1}^{cu}(f^n(x))$  of radius  $\delta_1$  around  $f^n(x)$ .

More precisely,

$$B_{\delta_1}^{cu}(f^n(x)) := \{z \in f^n(\Sigma) \mid \text{dist}_n(z, f^n(x)) < \delta_1\}. \quad (4.13)$$

2. for every  $y, z \in V_n(x)$  and  $1 \leq k \leq n$ ,

$$\text{dist}_{n-k}(f^{n-k}(y), f^{n-k}(z)) \leq \sigma^{3k/4} \text{dist}_n(f^n(y), f^n(z)). \quad (4.14)$$

*Remark 4.4.5.* We recall that  $\mathcal{V}$ , the open neighbourhood where the cone fields are defined, is assumed to be forward invariant. In that case, all the iterates  $f^n(\Sigma)$  with  $n \geq 0$  are centre-unstable disks. In particular,  $B_{\delta_1}^{cu}(f^n(x))$  as defined in (4.13) is a  $cu$ -disk. The only potential problem that may arise is whether or not it has radius  $\delta_1$  in the sense that any point  $z \in \partial B_{\delta_1}^{cu}(f^n(x))$  satisfies  $\text{dist}_n(z, f^n(x)) = \delta_1$ . Observe that this is not necessarily true in general: for instance, if  $f^n(x)$  lies very close to  $\partial f^n(\Sigma)$  there is no chance for all the points in the border of  $B_{\delta_1}^{cu}(f^n(x))$  to be exactly at radial distance  $\delta_1$  from the center. Such difficulty may be overcome by considering only sufficiently large hyperbolic times of points with distance bounded away from the border of  $\Sigma$  as in the hypothesis of the lemma.

**Lemma 4.4.6** (Comparison of derivatives). *Given  $0 < \sigma, r < 1$ , there is  $\delta_1 := \delta_1(\sigma, r) > 0$  such that for any  $C^1$  centre-unstable disk  $\Sigma \subset \mathcal{V}$  and a  $(\sigma, r)$ -hyperbolic time  $n \geq 1$  for  $x \in \Sigma \cap K$ , we have*

$$\|Df^{-1}|_{T_{f(y)}f^{n-k+1}(\Sigma)}\| \leq \sigma^{-1/4} \|Df^{-1}|_{E_{f^{n-k+1}(x)}^{cu}}\|$$

and, hence,

$$m(Df|_{T_y f^{n-k}(\Sigma)}) \geq \sigma^{1/4} \|Df^{-1}|_{E_{f^{n-k+1}(x)}^{cu}}\|^{-1}$$

for all  $1 \leq k \leq n$  and any point  $y \in \Sigma_{n,k}(x) := \{z \in f^{n-k}(\Sigma) \mid \text{dist}_{n-k}(z, f^{n-k}(x)) < \delta_1 \sigma^{k/2}\} \subset \mathcal{V} \setminus \mathcal{S}$ .

*Proof.* The lemma is a direct consequence of condition (2a) in definition of nondegenerate set after we check the following claim:

*Claim 2.* For all  $\gamma > 0$  and  $\delta_1 < \gamma \cdot r < \gamma$ , if  $n$  is a  $(\sigma, r)$ -hyperbolic time for  $x$ , then

$$\text{dist}_{n-k}(y, f^{n-k}(x)) < \gamma \cdot \text{dist}(f^{n-k}(x), \mathcal{S}),$$

for all  $1 \leq k \leq n$  and  $y \in \Sigma_{n,k}(x)$ .

*Proof of the Claim.* Since  $n$  is a  $(\sigma, r)$ -hyperbolic time for  $x$ , we have by the slow approximation condition 2,

$$\text{dist}_r(f^{n-k}(x), \mathcal{S}) \geq \sigma^{bk}, \text{ for all } 1 \leq k \leq n.$$

By definition of truncated distance, this means that

$$\text{dist}(f^{n-k}(x), \mathcal{S}) \geq r \text{ or else } \text{dist}(f^{n-k}(x), \mathcal{S}) = \text{dist}_r(f^{n-k}(x), \mathcal{S}) \geq \sigma^{bk},$$

which implies

$$\text{dist}(f^{n-k}(x), \mathcal{S}) \geq \min\{r, \sigma^{bk}\} \geq r \sigma^{bk}.$$

Hence, taking  $\delta_1 < \gamma \cdot r < \gamma$ , and since we haven chosen  $b < 1/2$ , for any point  $y \in \Sigma_{n,k}(x)$  we have

$$\text{dist}_{n-k}(y, f^{n-k}(x)) \leq \delta_1 \sigma^{k/2} < \gamma \cdot \min\{\sigma^{bk}, r\} \leq \gamma \cdot \text{dist}(f^{n-k}(x), \mathcal{S}).$$

□

In particular, taking  $\gamma = 1/2$  we have for all  $1 \leq k \leq n$  and  $y \in \Sigma_{n,k}(x)$ ,

$$\text{dist}_{n-k}(y, f^{n-k}(x)) < \frac{1}{2} \text{dist}(f^{n-k}(x), \mathcal{S}),$$

Finally, from condition (2a) it follows that for all  $1 \leq k \leq n$  and  $y \in \Sigma_{n,k}(x)$

$$\log \frac{\|Df^{-1}|_{T_{f(y)}f^{n-k+1}(\Sigma)}\|}{\|Df^{-1}|_{E_{f^{n-k+1}(x)}^{cu}}\|} \leq \frac{B}{\text{dist}(f^{n-k}(x), \mathcal{S})^\alpha} \text{dist}_{n-k}(y, f^{n-k}(x))^\beta \leq B \delta_1 \frac{\sigma^{\beta k/2}}{\min\{\sigma^{\alpha b k}, r^\alpha\}}.$$

Since  $0 < \sigma, r < 1$  and we have chosen  $b$  as in (4.7), the term on the right hand side is bounded by  $B\delta_1 r^{-\alpha}$ . Choosing  $\delta_1 > 0$  sufficiently small so that  $B\delta_1 r^{-\alpha} < \log \sigma^{-1/4}$  we get the conclusion.  $\square$

*Remark 4.4.7.* For latter reference, we resume here the conditions on  $\delta_1 > 0$  coming from the proof of Lemma 4.4.4:

1.  $\delta_1 < B^{-1} r^\alpha \log \sigma^{-1/4}$ ;
2. the exponential map in the ball of radius  $\delta_1$  around any point  $x \in M$  is an isometry onto its image.

*Proof. (of Lemma 4.4.4)* Let  $\Sigma$  be a  $C^1$  centre-unstable disk of radius  $0 < r < \delta_1$  and  $n$  be a  $(\sigma, r)$ -hyperbolic time for a point  $x \in \Sigma \cap H$  with  $\text{dist}_\Sigma(x, \partial\Sigma) \geq r/2$ . Using an inductive argument, we prove that the sets

$$V_k(x) := f^{-k}(B_{\delta_1}^{cu}(f^n(x))), \text{ for } 0 \leq k \leq n,$$

with  $B_{\delta_1}^{cu}(f^n(x))$  as defined in (4.13), satisfy the properties below:

- (a)  $V_k(x)$  is a centre-unstable neighbourhood of  $f^{n-k}(x)$  in  $f^{n-k}(\Sigma)$  contained in

$$\Sigma_{n,k}(x) := \{z \in f^{n-k}(\Sigma) \mid \text{dist}_{n-k}(z, f^{n-k}(x)) < \delta_1 \sigma^{k/2}\},$$

- (b)  $f_{|V_k(x)}^k : V_k(x) \rightarrow V_0(x) = B_{\delta_1}^{cu}(x)$  is a  $\sigma^{-3k/4}$ -dilation: for all  $f^{n-k}(y), f^{n-k}(z) \in V_k(x)$ ,

$$\text{dist}_n(f^n(y), f^n(z)) \geq \sigma^{-3k/4} \text{dist}_{n-k}(f^{n-k}(y), f^{n-k}(z)).$$

Properties (a) and (b) are trivial for  $V_0(x) = B_{\delta_1}^{cu}(f^n(x)) = \Sigma_{n,0}(x)$ . Given  $1 \leq k \leq n$  we assume that

$$V_j(x) \text{ satisfies (a) and (b) for all } 0 \leq j \leq k-1,$$

and want to verify that the same properties hold for  $V_k(x)$ . Let  $f^{n-k}(y) \in V_k(x)$  be an arbitrary point. Since we choose  $\delta_1 > 0$  so that the exponential map in the ball of radius  $\delta_1$  around any point  $x \in M$  is an isometry onto its image, we have that

$$f^n(y) \in V_0(x) = B_{\delta_1}^{cu}(f^n(x)) \subset B_{\delta_1}(f^n(x))$$

can be joined to  $f^n(x)$  through a smooth curve of minimal length

$$\gamma_0 : [0, 1] \rightarrow V_0(x) = \Sigma_{n,0}(x) \subset f^n(\Sigma)$$

with  $\gamma_0(0) = f^n(x)$  and  $\gamma_0(1) = f^n(y)$ . For  $1 \leq j \leq k$ , let  $\gamma_j : [0, 1] \rightarrow V_j(x) \subset f^{n-j}(\Sigma)$  be the curve defined by  $\gamma_j = f^{-j} \circ \gamma_0$ , so that  $\gamma_j$  connects  $\gamma_j(0) = f^{n-j}(x)$  to  $\gamma_j(1) = f^{n-j}(y)$ , but is not necessarily of minimal length, i.e.,

$$\text{length}(\gamma_j) \geq \text{dist}_{n-j}(f^{n-j}(x), f^{n-j}(y)).$$



By the induction hypothesis, we have  $\gamma_j \subset V_j(x) \subset \Sigma_{n,j}(x)$ , for all  $0 \leq j \leq k-1$ , so let us demonstrate that  $\gamma_k \subset \Sigma_{n,k}(x)$ , i.e.,

$$\text{dist}_{n-k}(\gamma_k(t), f^{n-k}(x)) < \delta_1 \sigma^{k/2}, \text{ for all } 0 \leq t \leq 1.$$

Using Lemma 4.4.6 and the fact that  $n$  is a  $(\sigma, r)$ -hyperbolic time for  $x$ , we have the next estimate for all  $f^{n-k}(y') \in \mathcal{A}_k := \Sigma_{n,k} \cap V_k(x) \subseteq \bigcap_{j=1}^k f^{-(k-j)}(\Sigma_{n,j}(x))$ :

$$m(Df^k|_{T_{f^{n-k}(y')}} f^{n-k}(\Sigma)) \geq \prod_{j=1}^k m(Df|_{T_{f^{n-j}(y')}} f^{n-j}(\Sigma)) \geq \prod_{j=1}^k \sigma^{1/4} \|Df^{-1}|_{E_{f^{n-j+1}(x)}}\|^{-1} \geq \sigma^{-3k/4}.$$

In particular, we have  $m(Df^k|_{T_{\gamma_k(t)}} f^{n-k}(\Sigma)) \geq \sigma^{-3k/4}$  for all times  $0 \leq t \leq 1$  such that  $\gamma_k(t) \in \Sigma_{n,k}(x)$ . We have  $\gamma_k(0) = f^{n-k}(x) \in \Sigma_{n,k}(x) \cap V_k(x)$  so assume otherwise that there is a first moment  $0 < t_k \leq 1$  when  $\gamma_k(t_k) \notin \Sigma_{n,k}(x)$ , say,

$$\text{dist}_{n-k}(\gamma_k(t_k), f^{n-k}(x)) \geq \delta_1 \sigma^{k/2}.$$

In that case, one would derive a contradiction since then

$$\begin{aligned} \text{dist}_n(f^n(y), f^n(x)) &:= \text{length}(\gamma_0) \\ &\geq \text{length}(\gamma_0|[0, t_k]) \\ &:= \int_0^{t_k} \|\gamma_0'(t)\| dt \\ &= \int_0^{t_k} \|Df^k(\gamma_k(t)) \cdot \gamma_k'(t)\| dt \\ &\geq \int_0^{t_k} \sigma^{-3k/4} \|\gamma_k'(t)\| dt \\ &= \sigma^{-3k/4} \text{length}(\gamma_k|[0, t_k]) \\ &\geq \sigma^{-3k/4} \text{dist}_{n-k}(\gamma_k(t_k), f^{n-k}(x)) \\ &\geq \delta_1 \sigma^{-k/4} \\ &> \delta_1. \end{aligned} \tag{4.15}$$

Therefore, this implies that  $f^{n-k}(y) \in \Sigma_{n,k}(x)$  and since  $f^{n-k}(y) \in V_k(x)$  was arbitrary we actually have  $V_k(x) \subset \Sigma_{n,k}(x)$ . Moreover, it follows from (4.15) that for all  $f^{n-k}(y), f^{n-k}(z) \in V_k(x)$ ,

$$\text{dist}_n(f^n(y), f^n(z)) \geq \sigma^{-3k/4} \text{dist}_{n-k}(f^{n-k}(y), f^{n-k}(z)).$$

This completes the induction. Now, we prove that  $B_{\delta_1}^{cu}(f^n(x))$  is a 'full' *cu*-disk of radius  $\delta_1$ , in the sense that any point  $p \in \partial B_{\delta_1}^{cu}(f^n(x))$  satisfies  $\text{dist}_n(p, f^n(x)) = \delta_1$ , as long as

$$n \geq n_0 := 2 \frac{\log(r/(2\delta_1))}{\log(\sigma)}.$$

As remarked before, this is not necessarily true in general: for instance, if  $f^n(x)$  lies very close to  $\partial f^n(\Sigma)$  there is no chance for all the points in the border of  $B_{\delta_1}^{cu}(f^n(x))$  to be at radial distance  $\delta_1$  from the center. Let  $z = f^n(y) \in \partial f^n(\Sigma)$  and suppose by absurd that

$$\text{dist}_n(f^n(y), f^n(x)) < \delta_1.$$

Since in that case  $f^n(y) \in B_{\delta_1}^{cu}(f^n(x))$ , we conclude that  $y \in V_n(x)$  and in particular

$$\text{dist}_\Sigma(y, x) < \delta_1 \sigma^{n/2}. \quad (4.16)$$

Moreover, since  $y \in \partial \Sigma$ , we have

$$\text{dist}_\Sigma(y, x) \geq \text{dist}_\Sigma(x, \partial \Sigma) \geq r/2. \quad (4.17)$$

Hence, combining the inequalities (4.16) and (4.17), we conclude that

$$r/2 \leq \delta_1 \sigma^{n/2} \Rightarrow n < n_0 := 2 \frac{\log(r/(2\delta_1))}{\log(\sigma)}.$$

Since we are assuming  $n \geq n_0$ , we conclude that  $B_{\delta_1}^{cu}(f^n(x))$  is actually a full disk of radius  $\delta_1$  in the sense above.  $\square$

**Lemma 4.4.8.** *There is  $C_0 > 1$  such that for every hyperbolic pre-disk  $V_n(x)$  and every  $y, z \in V_n(x)$  we have the next bounded distortion property:*

$$\log \frac{|\det Df^n|_{T_y \Sigma}|}{|\det Df^n|_{T_z \Sigma}} \leq C_0 \text{dist}_n(f^n(y), f^n(z))^\beta.$$

*Proof.* Let  $y, z \in V_n(x) \subset \Sigma$  and  $0 \leq k \leq n$ . By construction,  $f^k(x), f^k(y), f^k(z) \in \Sigma_{n-k}(x)$  for all  $0 \leq k \leq n$ , so Claim 2 implies that

$$\begin{aligned} \text{dist}(f^k(y), \mathcal{S}) &\geq \text{dist}(f^k(x), \mathcal{S}) - \text{dist}_k(f^k(x), f^k(y)) \\ &> (1 - \gamma) \text{dist}(f^k(x), \mathcal{S}) \\ &> (1 - \gamma) r \sigma^{(n-k)b} \\ &> \frac{1 - \gamma}{2\gamma} 2\delta_1 \sigma^{(n-k)/2} \\ &\geq \frac{1 - \gamma}{2\gamma} \text{dist}_k(f^k(y), f^k(z)). \end{aligned} \quad (4.18)$$

Taking  $\gamma = 1/5$  we conclude that, for all  $0 \leq k \leq n$ ,

$$\text{dist}_k(f^k(y), f^k(z)) < \frac{1}{2} \text{dist}(f^k(y), \mathcal{S}).$$

Therefore, assumption (2b) in the definition of non-degenerate singular set, estimate (4.18) and the backward contraction property (4.14) imply that for all  $0 \leq k \leq n$  we have

$$\begin{aligned} \log \frac{|\det Df|_{T_{f^k(y)}f^k(\Sigma)}}{|\det Df|_{T_{f^k(z)}f^k(\Sigma)}} &\leq \frac{B}{\text{dist}(f^k(y), \mathcal{S})^\alpha} \text{dist}_k(f^k(y), f^k(z))^\beta \\ &\leq B5^\alpha (4r)^{-\alpha} \sigma^{(n-k)(3/4\beta - \alpha b)} \text{dist}_n(f^n(y), f^n(z))^\beta. \end{aligned} \quad (4.19)$$

Finally,

$$\begin{aligned} \log \frac{|\det Df^n|_{T_y \Sigma}}{|\det Df^n|_{T_z \Sigma}} &= \sum_{k=0}^{n-1} \log \frac{|\det Df|_{T_{f^k(y)}f^k(\Sigma)}}{|\det Df|_{T_{f^k(z)}f^k(\Sigma)}} \\ &\leq \sum_{k=0}^{n-1} B5^\alpha (4r)^{-\alpha} \sigma^{(n-k)(3/4\beta - \alpha b)} \text{dist}_n(f^n(y), f^n(z))^\beta \\ &\leq C_0 \text{dist}_n(f^n(y), f^n(z))^\beta, \end{aligned}$$

where  $C_1$  is any constant greater or equal to  $B5^\beta (4r)^{-\beta} \sum_{i=0}^{\infty} \sigma^{(3/4\beta - \alpha b)i} < +\infty$  (recall from (4.7) that  $3/4\beta > 1/2\beta > \alpha b$ ).  $\square$

It follows from Lemma 4.4.8 that there is  $C_1 := C_1(C_0, \delta_1) > 0$  such that for every hyperbolic pre-disk  $V_n(x)$  and any Borel sets  $Y, Z \subset V_n(x)$ , we have

$$\frac{1}{C_1} \frac{\text{Leb}_\Sigma(Y)}{\text{Leb}_\Sigma(Z)} \leq \frac{\text{Leb}_{f^n(\Sigma)}(f^n(Y))}{\text{Leb}_{f^n(\Sigma)}(f^n(Z))} \leq C_1 \frac{\text{Leb}_\Sigma(Y)}{\text{Leb}_\Sigma(Z)} \quad (4.20)$$

Indeed,

$$\begin{aligned} \frac{\text{Leb}_{f^n(\Sigma)}(f^n(Y))}{\text{Leb}_{f^n(\Sigma)}(f^n(Z))} &= \frac{\int_Y |\det Df^n|_{T_y \Sigma} d\text{Leb}_\Sigma(y)}{\int_Z |\det Df^n|_{T_z \Sigma} d\text{Leb}_\Sigma(z)} \\ &= \frac{\int_Y \frac{|\det Df^n|_{T_y \Sigma}}{|\det Df^n|_{T_x \Sigma}} d\text{Leb}_\Sigma(y)}{\int_Z \frac{|\det Df^n|_{T_z \Sigma}}{|\det Df^n|_{T_x \Sigma}} d\text{Leb}_\Sigma(z)} \\ &\leq C_1 \frac{\text{Leb}_\Sigma(Y)}{\text{Leb}_\Sigma(Z)}. \end{aligned}$$

and the other inequality is obtained reversing the roles of  $Y$  and  $Z$ .

*Remark 4.4.9 (Holder continuity of the Jacobian).* It follows from (4.19) that the functions

$$J_k : y_k \in f^k(V_n(x)) \mapsto \log |\det Df|_{T_y f^k(\Sigma)}, \quad 0 \leq k \leq n,$$

are  $(L_1, \zeta)$ -Hölder continuous, with  $L_1$  depending only on  $\alpha, \beta, B, r$  and  $\delta_1$ , provided  $0 < \zeta < 1$  satisfies  $3/4(\beta - \zeta) - \alpha b > 0$  (recall that from (4.7) it follows that  $3/4\beta - \alpha b > 0$ ). Actually, given points

$y_k, z_k \in f^k(V_n(x))$  and  $\delta_1$  as above, we have

$$\begin{aligned} \left| \log \frac{|\det Df|_{T_{y_k} f^k(\Sigma)}}{|\det Df|_{T_{z_k} f^k(\Sigma)}} \right| &\leq \frac{B}{\text{dist}(z_k, \mathcal{S})^\alpha} \text{dist}_k(y_k, z_k)^\beta \\ &\leq B5^\alpha (4r)^{-\alpha} \frac{\text{dist}_k(y_k, z_k)^{\beta-\zeta}}{\sigma^{(n-k)\alpha b}} \text{dist}_k(y_k, z_k)^\zeta \\ &\leq B5^\alpha (4r)^{-\alpha} \frac{\sigma^{3/4(n-k)(\beta-\zeta)} \delta_1^{\beta-\zeta}}{\sigma^{(n-k)\alpha b}} \text{dist}_k(y_k, z_k)^\zeta \\ &= B5^\alpha (4r)^{-\alpha} \sigma^{(n-k)(3/4(\beta-\zeta)-\alpha b)} \delta_1^{\beta-\zeta} \text{dist}_k(y_k, z_k)^\zeta \\ &\leq L_1 \text{dist}_k(y_k, z_k)^\zeta. \end{aligned}$$

where  $L_1$  is any constant greater or equal than  $B5^\alpha (4r)^{-\alpha} \delta_1^{\beta-\zeta}$ .

The next lemma is an important piece in the proof of the existence of finitely many transitive attractors containing disks contained Leb mod 0 in  $H$  (Proposition 4.3.1). It can be found in [12, Proposition 5.5] and despite the fact that the setting considered by the authors in that paper does not include the presence of critical/singular sets, the same arguments work here in a similar fashion after Lemmas 4.4.1 and 4.4.4, stating the existence of infinitely many hyperbolic times  $n$  for points  $x \in H$  and corresponding hyperbolic pre-disks  $V_n(x)$  with nice properties, have been obtained.

**Lemma 4.4.10.** *Let  $\Sigma$  be a  $cu$ -disk and  $U \subseteq H$  with  $\text{Leb}_\Sigma(U) > 0$ . Then there exists a sequence of sets*

$$\dots \subseteq W_2 \subseteq W_1 \subseteq \Sigma$$

and a sequence of integers  $n_1 < n_2 < \dots$  such that:

1.  $W_k$  is contained in some hyperbolic pre-disk with hyperbolic time  $n_k$ ;
2.  $\Sigma_k = f^{n_k}(W_k)$  is a  $cu$ -disk of radius  $\delta_1/4$ ;
3.  $\lim_{k \rightarrow \infty} \frac{\text{Leb}_{\Sigma_k} f^{n_k}(\Sigma \cap U)}{\text{Leb}_{\Sigma_k}(\Sigma_k)} = 1$ .

## 4.5 Construction of a reference leaf

At this step, we fix some arbitrary  $1 \leq j \leq l$ , let  $\Omega = \Omega_j$  be the closed transitive attractor and  $\Sigma = \Sigma_j$  be the centre-unstable disk as in Proposition 4.3.1. In particular,  $f$  is nonuniformly expanding and has slow recurrence to the singular set on  $\Sigma$  and therefore is *full* of hyperbolic pre-disks. The main result of this section concerns property (A<sub>3</sub>), providing both the existence of the  $cu$ -subdisk  $\Delta_0$  and the nice related recurrence properties. The reader may want to refer to [8, Lemmas 5.2 and 5.3], where a similar result is obtained for partially hyperbolic diffeomorphisms (without singularities). Owing to the possibility of unbounded derivative, we should adapt the arguments to deal with this situation as well.

**Lemma 4.5.1** (Recurrence Lemma). *There are  $p \in \Sigma$  and  $L \geq 1$  such that for all  $\delta_0 > 0$  sufficiently small and each hyperbolic pre-disk  $V_n(x) \subset \Sigma$  there is  $0 \leq l \leq L$  and domains  $\omega_{n,l}(x) \subset \tilde{\omega}_{n,l}(x) \subset W_n(x) \subset V_n(x)$  such that*

1.  $f^{n+l}(V_n(x))$  intersects  $W_{\delta_s/2}^s(p)$ ,
2.  $f^{n+l}(\omega_{n,l}(x))$   $u$ -crosses  $\mathcal{C}(\Delta_0)$  with  $\Delta_0 = B_{\delta_0}^u(p)$  and
3.  $f^{n+l}(\tilde{\omega}_{n,l}(x))$   $u$ -crosses  $\mathcal{C}(\Delta_1)$  with  $\Delta_1 = B_{2\delta_0}^u(p)$ ,

where  $B_r^u(p)$  is the disk in  $\Sigma$  of radius  $r$  centered at  $p$ . Moreover, there are  $C_1, \eta > 0$  such that for every  $\tilde{\omega}_{n,l}(x)$  and every  $y, z \in f^n(\tilde{\omega}_{n,l}(x))$  we have

- a.  $\frac{1}{C_1} \text{dist}(x, y) \leq \text{dist}_l(f^l(y), f^l(z)) \leq C_1 \text{dist}(y, z)$
- b.  $\log \frac{|\det Df^l|_{T_y \Sigma}}{|\det Df^l|_{T_z \Sigma}} \leq C_1 \text{dist}_l(f^l(y), f^l(z))^\eta$ .

*Proof.* First of all, observe that as the subbundles in the dominated splitting have angles uniformly bounded away from zero (property  $(E_1)$ ), given any sufficiently small  $\rho > 0$  there is  $\alpha = \alpha(\rho) > 0$  with  $\alpha \rightarrow 0$  as  $\rho \rightarrow 0$  for which the following holds:

(P) if  $x, y \in \Omega$  satisfy  $\text{dist}(x, y) < \rho$  and  $\text{dist}_{\gamma^\mu}(y, \partial \gamma^\mu) \geq \delta_1$  for some  $cu$ -disk  $\gamma^\mu \subseteq \Omega$ , then  $W_{\delta_s}^s(x)$  intersects  $\gamma^\mu$  in a point  $z$  with

$$\text{dist}_{W_{\delta_s}^s(x)}(z, x) < \alpha \text{ and } \text{dist}_{\gamma^\mu}(z, y) < \delta_1/2.$$

Take  $\rho > 0$  small enough so that  $\alpha < \delta_s/4$ . Since  $f|_\Omega$  is transitive, we may choose  $q \in \Omega$  and  $L \in \mathbb{N}$  such that:

1.  $W_{\delta_s/4}^s(q)$  intersects  $\Sigma$  in a point  $p$  with  $\text{dist}_\Sigma(p, \partial \Sigma) > 0$ ;
2.  $\{f^{-L}(q), \dots, f^{-1}(q), q\}$  is  $\rho$ -dense in  $\Omega$  and

$$\text{dist}(W_{\delta_s/4}^s(f^{-j}(q)), \mathcal{S}) > d_0 \tag{4.21}$$

for all  $0 \leq j \leq L$  and some  $d_0 > 0$  that we assume smaller than  $\delta_1$ .

Given a hyperbolic predisk  $V_n(x) \subseteq \Sigma$  we know by definition that  $f^n(V_n(x))$  is a  $cu$ -disk of radius  $\delta_1 > 0$  centered at  $y := f^n(x)$  inside  $\Omega$ . Consider some iterate  $f^{-l}(q)$ , with  $0 \leq l \leq L$ , such that  $\text{dist}(f^{-l}(q), y) < \rho$ . Then, by the choice of  $\rho$  and  $\alpha$  and property (P) above, we have that  $W_{\delta_s}^s(f^{-l}(q))$  intersects  $f^n(V_n(x))$  in a point  $z$  with

$$\text{dist}_{W_{\delta_s}^s(f^{-l}(q))}(z, f^{-l}(q)) < \alpha < \delta_s/4 \text{ and } \text{dist}_{f^n(V_n(x))}(z, y) < \delta_1/2.$$

In particular,  $f^n(V_n(x))$  contains a  $cu$ -disk  $\gamma^\mu$  of radius  $\delta_1/2$  centered at  $z$ . Since  $z \in W_{\delta_s/4}^s(f^{-l}(q))$ , from (4.21), we have that  $\text{dist}(z, \mathcal{S}) > d_0$  and therefore, from item (1) in the definition of non-degenerate set and (4.21), one can deduce that there is  $C = C(d_0) > 0$  such that

$$m(Df|_{T_{z'}\gamma^\mu}) \geq C \quad (4.22)$$

for all  $z'$  in a subdisk  $\gamma_0^\mu$  of  $\gamma^\mu$  of radius  $r_0 := d_0/2 \leq \delta_1/2$  centered at  $z$ . Without loss of generality, we may even assume that  $C \leq 1$ . From this fact, using an inductive argument, it will follow that  $f^l(\gamma_0^\mu)$  contains a  $cu$ -disk of radius  $r = r(L, r_0) > 0$  centered at  $f^l(z) \in W^s(p)$  for all  $0 \leq l \leq L$ . Indeed, let  $\gamma_1^\mu = f(\gamma_0^\mu)$  and  $z_1 = f(z_0)$  be a point in  $\partial\gamma_1^\mu$  minimizing the distance from  $f(z)$  to  $\partial\gamma_1^\mu$ . Consider a curve  $\eta_1$  of minimal length in  $\gamma_1^\mu$  connecting  $f(z)$  to  $z_1$  and set  $\eta_0 = f^{-1}(\eta_1) \subset \gamma_0^\mu$ , which is a curve connecting  $z$  to  $z_0 \in \partial\gamma_0^\mu$ . From (4.22), it follows that

$$\begin{aligned} \text{dist}_{\gamma_1^\mu}(z_1, f(z)) &:= \text{length}(\eta_1) \\ &:= \int_0^1 \|\eta_1'(t)\| dt \\ &= \int_0^1 \|Df(\eta_0(t)) \cdot \eta_0'(t)\| dt \\ &\geq C \int_0^1 \|\eta_0'(t)\| dt \\ &= C \cdot \text{length}(\eta_0) \\ &\geq C \cdot \text{dist}_{\gamma_0^\mu}(z_0, z) \\ &= C \cdot r_0. \end{aligned} \quad (4.23)$$

Therefore,  $\gamma_1^\mu = f(\gamma_0^\mu)$  contains a  $cu$ -disk of radius  $r_1 = C \cdot r_0 \leq r_0$  around  $f(z)$  that we denote again  $\gamma_1^\mu$  for simplicity.

Observe that  $f(z) \in W_{\delta_s/4}^s(f^{-l+1}(q))$  so that, in particular,  $\text{dist}(f(z), \mathcal{S}) > d_0$ . We can now replicate the previous estimates (4.22) and (4.23) with  $\gamma_1^\mu$  in the place of  $\gamma_0^\mu$  to conclude that  $\gamma_2^\mu = f^2(\gamma_0^\mu)$  contains a  $cu$ -disk of radius  $r_2 = C \cdot r_1 = C^2 \cdot r_0 \leq r_1$  centered at  $f^2(z)$ . Inductively, we prove that  $f^l(\gamma_0^\mu)$  contains a  $cu$ -disk of radius  $r_l = C^l \cdot r_0$  centered at  $f^l(z)$  for all  $0 \leq l \leq L$ . In particular, all of these disks contain a sub-disk of radius  $r = r_L = C^L \cdot r_0$ .

Moreover, as distances are not expanded under iteration of points in the same stable manifold, we have

$$\text{dist}_{W^s(p)}(f^l(z), p) \leq \text{dist}_{W^s(p)}(f^l(z), q) + \text{dist}_{W^s(p)}(q, p) \leq \delta_s/4 + \delta_s/4,$$

which means that  $f^{n+l}(V_n(x))$  intersects  $W_{\delta_s/2}^s(p)$ . Also, choosing  $\delta_0 > 0$  sufficiently small (depending only on  $r$ ), we see that  $f^{n+l}(V_n(x))$   $u$ -crosses  $\mathcal{C}(B_{\delta_0}^\mu(p))$ . From this fact and since we are considering all the  $\delta_0 > 0$  sufficiently small, we easily obtain the sets  $\omega_{n,l}(x)$  and  $\tilde{\omega}_{n,l}(x)$  in the statement.

Given that the number of iterations is finite, we may have the distance of the at most  $L$  iterates of  $f^n(\tilde{\omega}_{n,l}(x))$  at a distance from  $\mathcal{S}$  strictly positive (uniformly). Using the fact that  $f$  is  $C^{1+\beta}$  in subsets at positive distance from  $\mathcal{S}$ , the last two conclusions follow.  $\square$

## 4.6 Entropy formula

We have mentioned before that a diffeomorphism (possibly with singularities) admitting a Young structure  $\Lambda$  with integrable recurrence times has an ergodic SRB measure  $\mu$ , which is, a priori, of a special kind: in this case, we say that  $\mu$  is *liftable* (to the Young structure). Since for any ergodic SRB measure  $\mu \in \mathcal{F}_f$  the integrability condition

$$\log \|Df^{\pm 1}|_{E_x^{cu}}\| \in L^1(\mu),$$

holds true, in the light of Oseledets Theorem [59], we may look at the *Jacobian along the unstable direction at  $x$* , defined for  $\mu$ -almost every point  $x \in M$ , as

$$J_f^u(x) := |\det Df|_{E_x^u}|, \quad (4.24)$$

with  $E_x^u = E_x^{cu}$  coinciding with the direct sum  $\bigoplus_{\lambda_i > 0} E_x^i$  of the linear subspaces in the Oseledets decomposition associated to the (necessarily) positive Lyapunov exponents. Theorem C is then based on the next chain of equalities that we explain in the sequel:

$$h_\mu(f) = h_{\hat{\nu}}(\hat{T}) = h_{\Theta_* \hat{\nu}}(T) = \int \log J_T d\Theta_* \hat{\nu} = \int \log J_f^u d\mu. \quad (4.25)$$

The first equality follows directly from Lemma 3.5.1, exactly as before, since the fibers are countable in this situation as well. Now we shift our attention to the towers  $(T, \Theta_* \hat{\nu})$  and  $(\hat{T}, \hat{\nu})$ . Heuristically, one would expect these two systems to share the same entropy since we are in a sense just ignoring the stable direction, where no new *dynamical information* is produced. The formal way from which we will be able to deduce this fact is via the *natural* or *symbolic extension*, introduced at the beginning of this chapter. All the work necessary to prove this result is done in [35, B. Appendix.] and we just reproduce the main ingredients here for the reader's convenience.

**Proposition 4.6.1.** [35, B. Appendix.] *The map  $\Theta^\# : \hat{\Delta}^\# \rightarrow \Delta^\#$ , defined by*

$$\Theta^\#(\dots, (x_{-1}, l_{-1}), (x_0, l_0)) := (\dots, \Theta(x_{-1}, l_{-1}), \Theta(x_0, l_0)),$$

*is an ergodic isomorphism between the m.p.s.  $(\hat{T}^\#, \hat{\nu}^\#)$  and  $(T^\#, (\Theta_* \hat{\nu})^\#)$ .*

*Proof.* It is easy to check that  $\Theta^\#$  is a measurable surjection satisfying  $\Theta^\# \circ \hat{T}^\# = T^\# \circ \Theta^\#$  and  $(\Theta^\#)_* \hat{\nu}^\# = (\Theta_* \hat{\nu})^\#$ . The proposition follows once we show that  $\Theta^\#$  is one-to-one. In order to do that, first assume that  $\Theta^\#(\dots, (x_{-1}, l_{-1}), (x_0, l_0)) = \Theta^\#(\dots, (y_{-1}, l_{-1}), (y_0, l_0))$ . Letting  $\gamma^s(x_{-n}, l_{-n})$  denote the stable disk through  $(x_{-n}, l_{-n})$ , we have, by definition,  $(x_0, l_0) \in \bigcap_{n=1}^{\infty} \hat{T}^{n-1}(\gamma^s(x_{-n}, l_{-n}))$ . The uniform contraction of  $f^R$  along stable sets expressed in property (Y<sub>2</sub>) implies that this intersection consists of a single point. In the same vein,  $(y_0, l_0) \in \bigcap_{n=1}^{\infty} \hat{T}^{n-1}(\gamma^s(y_{-n}, l_{-n}))$ . Since  $\Theta(x_{-n}, l_{-n}) = \Theta(y_{-n}, l_{-n})$  is equivalent to  $\gamma^s(x_{-n}, l_{-n}) = \gamma^s(y_{-n}, l_{-n})$ , we have that  $(x_0, l_0) = (y_0, l_0)$ . Applying the same argument inductively to the remaining elements of the sequence, we conclude that  $(x_{-n}, l_{-n}) = (y_{-n}, l_{-n})$  for all  $n \geq 1$ .  $\square$

It is a classical fact that the entropies of a m.p.s.  $(\hat{T}, \hat{\nu})$  and its natural extension  $(\hat{T}^\#, \hat{\nu}^\#)$  are equal (see e.g. [35, 67]):

**Proposition 4.6.2.**  $h_{\hat{\nu}}(\hat{T}) = h_{\hat{\nu}^\#}(\hat{T}^\#)$ .

Besides, in this case it turns out that the two natural extensions in question are isomorphic and therefore share the same entropy. Bringing the previous result and observation together, it easily follows that

$$h_{\hat{\nu}}(\hat{T}) = h_{\hat{\nu}^\#}(\hat{T}^\#) = h_{(\Theta_{\gamma_0} \hat{\nu})^\#}(T^\#) = h_{\Theta_{\gamma_0} \hat{\nu}}(T),$$

which is the one-line proof for the second equality. Since the quotient tower is associated to a Gibbs-Markov quotient map, it follows from Lemma 3.4.4 that it satisfies:

$$h_{\Theta_{\gamma_0} \hat{\nu}}(T) = \int \log J_T d\Theta_{\gamma_0} \hat{\nu}.$$

Therefore, the entropy formula follows from the result below, establishing a relation between the integral expressions:

**Lemma 4.6.3.**  $\int \log J_T d\Theta_{\gamma_0} \hat{\nu} = \int \log J_F^u d\mu$ .

*Proof.* Let  $\pi_1 : \hat{\Delta} \rightarrow M$  be the projection on the first coordinate:  $\pi_1(x, l) = x$ . Using again the definition of the Jacobian, observing that  $(\pi_1)_* \hat{\nu}|_{\hat{\Delta}_l^{l+1}} = \sigma^{-1} \cdot \nu|_{\hat{\Delta}_l^{l+1}}$  and  $(\Theta_{\gamma_0})_* \nu = \nu_0$ , one deduces that

$$\begin{aligned} \int_{\Delta} \log J_T d\Theta_{\gamma_0} \hat{\nu} &= \int_{\hat{\Delta}} \log J_T \circ \Theta d\hat{\nu} \\ &= \sum_{l=0}^{\infty} \int_{\hat{\Delta}_l^{l+1}} \log J_T \circ \Theta d\hat{\nu} \\ &= \sum_{l=0}^{\infty} \int_{\hat{\Delta}_l^{l+1}} \log J_F \circ \Theta_{\gamma_0} \circ \pi_1 d\hat{\nu} \\ &= \sigma^{-1} \int_{\gamma_0 \cap \Lambda} \log J_F d\nu_0, \end{aligned}$$

where  $\sigma = \int_{\gamma_0 \cap \Lambda} R d\nu_0$ . As a consequence of Oseledets Theorem applied to the induced quotient system  $(F, \nu_0)$ , we have

$$\sigma^{-1} \int_{\gamma_0 \cap \Lambda} \log J_F d\nu_0 = \sigma^{-1} \sum_i \tilde{\lambda}_i \dim \tilde{E}_i,$$

where  $\tilde{\lambda}_i$  and  $\tilde{E}_i$  are the Lyapunov exponents and corresponding linear spaces given by Oseledets' decomposition. From [6, Lemma 2.6], we can relate the induced Oseledets decomposition back with the original one, following that

$$\sigma^{-1} \sum_i \tilde{\lambda}_i \dim \tilde{E}_i = \sum_{\lambda_i > 0} \lambda_i \dim E_i,$$



where  $\lambda_i$  and  $E_i = \tilde{E}_i$  are the positive Lyapunov exponents and corresponding Oseledets subspaces of the original system  $(f, \mu)$ . Therefore, as consequence of the same theorem, we have

$$\sum_{\lambda_i > 0} \lambda_i \dim E_i = \int \log |\det Df|_{E_x^u}| d\mu,$$

which finishes the proof, in the light of (4.24). □



## Chapter 5

# Applications

In this chapter, we present three families of systems with singularities enabling an illustration of our main theorems, namely: Lorenz maps [54] (both one- and two-dimensional), Rovella maps [68] and Luzzatto-Viana maps [55]. Although, to the best of our knowledge, entropy formulas for the maps in these families are not yet clearly covered in the previous literature, we stress that inducing schemes were already independently obtained combining results of several previous works [9, 16, 37, 38, 40, 72].

### 5.1 Lorenz maps

In the late 1970's, Guckenheimer and Williams [41] introduced the geometric description of a flow having a similar dynamical behavior as that of the classical Lorenz system, which we call the *Geometric Lorenz Attractor*. From this model, we will extract two interrelated families of systems: the first, consisting of two-dimensional Poincaré return maps, and a second one, consisting of one-dimensional maps derived from the first family by collapsing stable leaves. In this section, we confine ourselves to a brief description, referring the reader to [19] for a complete scholarly treatment.

The geometric model of the Lorenz attractor is obtained from a vector field  $X_0$  which is linear in a neighbourhood of the origin containing the unitary cube  $\{(x, y, z) : |x|, |y|, |z| \leq 1\}$ . It has a singularity at  $(0, 0, 0)$  and the real eigenvalues  $\lambda_1, \lambda_2$  and  $\lambda_3$  of  $DX(0)$ , with corresponding eigenvectors along the coordinate axis, satisfy  $0 < -\lambda_3 < \lambda_1 < -\lambda_2$ . We consider a square  $\Sigma$  on the top of the cube given by

$$\Sigma = \{(x, y, 1) : -1/2 \leq x, y \leq 1/2\}, \quad (5.1)$$

and let  $\Gamma$  be the intersection of  $\Sigma$  with the two-dimensional stable manifold of the singularity. The segment  $\Gamma$  divides  $\Sigma$  in two parts:

$$\Sigma^+ = \{(x, y, 1) \in \Sigma : x > 0\} \text{ and } \Sigma^- = \{(x, y, 1) \in \Sigma : x < 0\}.$$

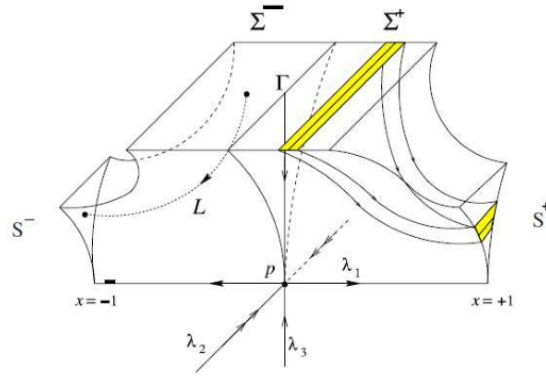

Fig. 5.1 Cross section.

Near the origin, the behavior of the flow can be described by the map

$$Q : \Sigma^\pm \rightarrow \{(\pm 1, y, z) : y, z \in \mathbb{R}\}$$

$$(x, y, 1) \mapsto (\text{sgn}(x), y|x|^r, |x|^s),$$

where  $r = -\frac{\lambda_2}{\lambda_1}$  and  $s = -\frac{\lambda_3}{\lambda_1}$  and  $\text{sgn}(x) = x/|x|$  for  $x \neq 0$ . The images of  $\Sigma^\pm$  by this map  $Q$  are curvilinear triangles  $S^\pm$  without the vertices  $(\pm 1, 0, 0)$  (corresponding to infinite contraction) and every line segment in  $\mathcal{F}_0 = \{\{x = \text{const}\} \cap \Sigma\}$  (except  $\Gamma$ ) is mapped to a segment in  $\mathcal{F}_1 = \{\{z = \text{const}\} \cap S^\pm\}$ ; see Figure 5.1.

The time  $\tau$  which takes for each  $(x, y, 1) \in \Sigma \setminus \Gamma$  to reach  $S^\pm$  is given by  $\tau(x, y, 1) = -\frac{1}{\lambda_1} \log |x|$ . Finally, we suppose that the flow takes the triangles back to  $\Sigma$  in a smooth way as it is shown in Figure 5.2.

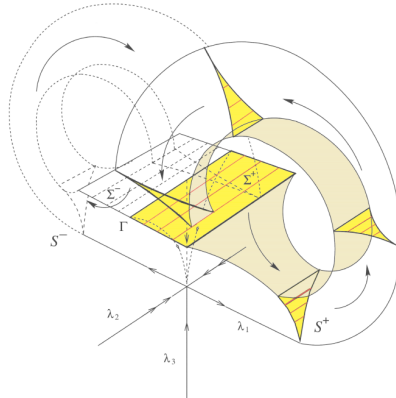

Fig. 5.2 Geometric Lorenz Flow.

The resulting Poincaré return map from  $\Sigma \setminus \Gamma$  back into  $\Sigma$  again has the skew-product form

$$P(x, y) = (f(x), g(x, y)), \tag{5.2}$$

for some  $f : I \setminus \{0\} \rightarrow I$  and  $g : I \setminus \{0\} \times I \rightarrow I$  with  $I = [-\frac{1}{2}, \frac{1}{2}]$ , as is shown in Figure 5.3 below. The one-dimensional map  $f$  is described in Figure 5.4 and satisfies the properties:

1.  $f$  is discontinuous at  $x = 0$  with side limits  $f(0^+) = -\frac{1}{2}$  and  $f(0^-) = \frac{1}{2}$ ;
2.  $f$  is differentiable on  $I \setminus \{0\}$  and  $f'(x) > \sqrt{2}$  for all  $x \in I \setminus \{0\}$ ;
3. the side limits of  $f'$  at  $x = 0$  are  $f'(0^+) = f'(0^-) = +\infty$ .

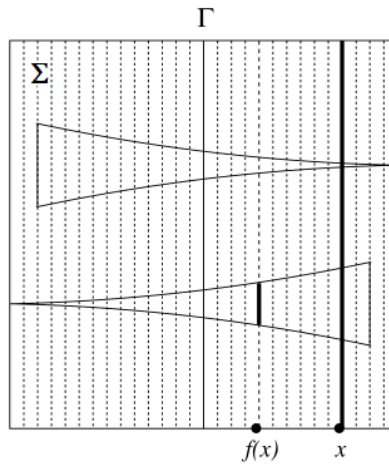

Fig. 5.3 Poincaré return map.

On the other hand, the map  $g$  satisfies  $|\frac{\partial g}{\partial y}| < k < 1/2$ , which implies that the foliation  $\mathcal{F}_0$  formed by the segments  $\{x = \text{const}\} \cap \Sigma$  is *uniformly contracting*: there exist constants  $C' > 0$  and  $0 < \rho < 1$  such that for any given leaf  $\gamma$  of the foliation,  $\zeta_1, \zeta_2 \in \gamma$  and  $n \geq 1$ ,

$$\text{dist}(P^n(\zeta_1), P^n(\zeta_2)) \leq C' \rho^n \text{dist}(\zeta_1, \zeta_2). \tag{5.3}$$

For many purposes, the study of the three dimensional flow can be reduced to the study of a bi-dimensional Poincaré return map  $P$  and the dynamics of this map can be further reduced to that of the one-dimensional map  $f$ , since the invariant contracting foliation  $\mathcal{F}_0$  enables us to identify two points on the same stable leaf: their orbits remain forever on the same leaf and the distance of their images tends to zero under iteration. We set  $\Lambda_P = \bigcap_{n \geq 0} P^n(\Sigma)$  and the *Geometric Lorenz attractor*  $\Lambda$  is given by the union of orbits of points in  $\Lambda_P$  by the flow of  $X_0$ .

A crucial fact about the geometric Lorenz attractor is that it is *robust*, i.e., vector fields sufficiently close in the  $C^1$  topology to the original one constructed above have strange attractors. In other words, there exist an open neighbourhood  $U \subset \mathbb{R}^3$  containing the geometric Lorenz attractor  $\Lambda$  and an open neighbourhood  $\mathcal{U}$  of  $X_0$  in the  $C^1$  topology such that for any vector field  $X \in \mathcal{U}$  the maximal invariant set  $\Lambda_X = \bigcap_{t \geq 0} X^t(U)$  is a transitive set and invariant under the flow of  $X$ .

We define the *family of Geometric Lorenz vector fields*, denoted by  $\mathcal{X}$ , as a  $C^2$  neighbourhood of  $X_0$  with the following properties:

1. for each  $X \in \mathcal{X}$ , the maximal forward invariant set  $\Lambda_X$  inside  $U$  is an attractor containing a hyperbolic singularity;
2. for each  $X \in \mathcal{X}$ ,  $\Sigma$  is the cross-section for the flow with a return time  $\tau_x$  and a Poincaré map  $P_X$ ;
3. for each  $X \in \mathcal{X}$ , the map  $P_X$  admits a  $C^2$  uniformly contracting invariant foliation  $\mathcal{F}_X$  on  $\Sigma$  with projection along the leaves of  $\mathcal{F}_X$  onto  $I_X$  given by a map  $\pi_X$ ;
4. for each  $X \in \mathcal{X}$ , the map  $f_X$  on the quotient space  $I_X$  by the leaves in  $\mathcal{F}_X$  is a transitive  $C^2$  piecewise expanding map with two branches and discontinuity point  $s_X$ ; moreover, there is  $c > 1$  such that  $f'_X(x) \geq c$  and  $\lim_{x \rightarrow s_X^\pm} f'_X(x) = \infty$
5. there is some constant  $C > 0$  such that for each  $X \in \mathcal{X}$

$$\tau_X(\zeta) \leq -C \log |\pi_X(\zeta) - O_X|.$$

Therefore, from the family  $\mathcal{X}$  we are able to extract a family  $\mathcal{L} = \{f_X\}_{X \in \mathcal{X}}$  of one-dimensional *Lorenz-like expanding maps*. Each element  $f_X : I_X \rightarrow I_X$  is a map of the interval  $I_X = [-r_X, r_X]$ , where  $r_X$  is a real number close to  $1/2$ , satisfying similar properties to those of  $f$ , namely:

- ( $l_0$ ) *existence of singular set*:  $f_X$  is a  $C^{1+}$  local diffeomorphism outside a singular set  $\mathcal{S}_X = \{s_X\}$  consisting of a single discontinuity point  $s_X$  close to 0 with unbounded derivative

$$\lim_{x \rightarrow s_X^\pm} f'_X(x) = \infty,$$

and finite side limits  $f(s_X^\pm)$ ;

- ( $l_1$ ) *order of singularity*: there are  $1/2 < \alpha < 1$  and  $B > 0$  such that for all  $x \in I_X \setminus \mathcal{S}_X$ , we have:

$$B^{-1}|x - s_X|^{-\alpha} \leq |f'_X(x)| \leq B|x - s_X|^{-\alpha};$$

- ( $l_2$ ) *local Hölder continuity of  $f'$* : there are  $\beta < \alpha$  and  $C > 0$  such that for all  $x, y \in I_X \setminus \{s_X\}$  we have

$$|f'_X(x) - f'_X(y)| \leq C|x - s_X|^{-\beta}|y - s_X|^{-\beta}|x - y|^\beta;$$

- ( $l_3$ ) *uniform expansion*: there is  $c > 1$  such that  $f'_X(x) \geq c$  for all  $x \in I_X \setminus \{s_X\}$ ;

- ( $l_4$ ) *transitivity*:  $f_X$  is transitive.

It is observed in [17, Section 2] that each  $f_X$  admits a unique ergodic invariant probability measure  $\mu_X$  which is absolutely continuous with respect to the Lebesgue measure  $\text{Leb}_X$  on  $I_X$  and whose density  $d\mu_X/d\text{Leb}_X$  is a bounded variation function - in particular, it is bounded and the bound can be uniformly chosen within the family  $\mathcal{L}$ ; cf. [17, Proposition 2.1]. In this section, we prove that  $\mu_X$  satisfies the entropy formula.

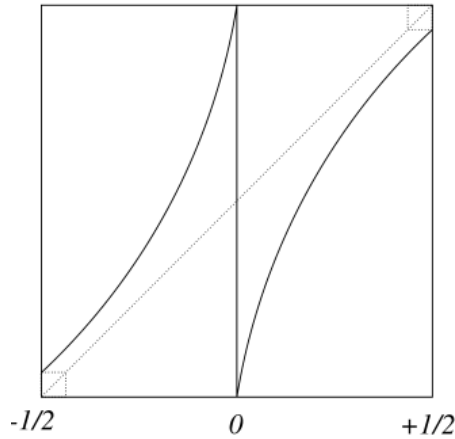

Fig. 5.4 Lorenz map.

**Theorem 5.1.1.** *Let  $\mathcal{L} = \{f_X\}_{X \in \mathcal{X}}$  be the family of Lorenz-like expanding maps introduced above. Then, for each map  $f_X \in \mathcal{L}$ , the entropy formula below holds:*

$$h_{\mu_X}(f_X) = \int \log |f'_X| d\mu_X.$$

*Proof.* This is a straightforward consequence of Theorem A. Given an arbitrary map in  $f_X \in \mathcal{L}$ , properties  $(l_1) - (l_3)$  can easily be seen to imply that  $S_X = \{s_X\}$  is a non-degenerate singular set. Moreover, the nonuniform expansion condition on a full Lebesgue measure subset of  $I_X$  is trivially satisfied since, owing to  $(l_3)$ ,  $f_X$  is actually (piecewise) uniformly expanding.

The slow recurrence condition on a full Lebesgue measure subset of  $I_X$  may be deduced using Birkhoff's Ergodic Theorem and the properties of  $\mu_X$ , as in [14, Lemma 3.3]. Define, for  $x \in I_X \setminus S_X$ , the function

$$\xi_X(x) = -\log \text{dist}(x, S_X).$$

Since  $S_X$  is a compact set, it follows from [4, Proposition 4.1] that  $\xi_X \in L^p(\text{Leb}_X)$  for every  $1 \leq p < \infty$ . Then, observing that  $d\mu_X/d\text{Leb}_X \in L^\infty(\text{Leb}_X)$ , Hölder inequality implies that  $\xi_X \in L^1(\mu_X)$  and consequently we have

$$\lim_{r \rightarrow 0^+} \int_{\{\xi_X > -\log r\}} \xi_X d\mu_X = 0.$$

Observing that  $\chi_{\{\xi_X > -\log r\}} \xi_X = -\log \text{dist}_r(\cdot, S_X)$ , where  $\chi_{\{\xi_X > -\log r\}} \xi_X$  stands for the characteristic function of the set  $\{\xi_X > -\log r\}$ , it follows that for all  $\varepsilon > 0$  there is  $r > 0$  such that

$$\int -\log \text{dist}_r(\cdot, S_X) d\mu_X < \varepsilon.$$

Hence, using the ergodicity of  $\mu_X$ , Birkhoff's Ergodic Theorem yields

$$\lim_{n \rightarrow \infty} \frac{1}{n} \sum_{j=0}^{n-1} -\log \text{dist}_r(f_X^j(x), S_X) = \int -\log \text{dist}_r(\cdot, S_X) d\mu_X < \varepsilon$$

for  $\mu_X$  almost every  $x \in I$ . □

On the other hand, associated to  $\mathcal{X}$  we derive another family  $\{P_X\}_{X \in \mathcal{X}}$  of two-dimensional Poincaré return maps to the cross-section  $\Sigma$ . Each element  $P_X : \Sigma \setminus \Gamma_X \rightarrow \Sigma$  is a partially hyperbolic map with approximately vertical singular line  $\Gamma_X$ , an approximately horizontal unstable direction  $E^u$  and approximately vertical stable one  $E^s$ ; see [19] for details. The properties of nonuniform expansion along the centre-unstable direction and slow recurrence to the nondegenerate singular set  $\Gamma_X$  are direct consequences of the corresponding properties for the Lorenz maps  $f_X$ . Based on techniques used in [20], the authors showed in [17, Lemma 2.2] that  $\mu_X$  can be lifted in a unique way to an ergodic SRB  $P_X$ -invariant probability measure  $\nu_X$  on  $\Sigma$ . As a corollary of the main Theorem B - and its inspiring application - we have

**Theorem 5.1.2.** *Let  $\{P_X\}_{X \in \mathcal{X}}$  be the family of Poincaré return maps of Lorenz flows introduced above. Then, for each map  $P_X$ , the entropy formula below holds:*

$$h_{\nu_X}(P_X) = \int \log |\det DP_X|_{E^u}| d\nu_X.$$

## 5.2 Rovella maps

By considering a vector field almost identical to that used by Guckenheimer and Williams [41], Rovella [68] introduced a somewhat different kind of attractor, named as *contracting Lorenz attractor*, which is no longer robust but persists in a measure-theoretical sense. In the sequel, the author derived a one parameter family  $\mathcal{R} = \{f_a\}_{a \in E}$  of interval maps now bearing his name. The parameter set  $E$  is a subset of the interval  $(0, 1)$  and has 0 as a full density point, i.e.,

$$\lim_{a \rightarrow 0} \frac{|E \cap (0, a)|}{a} = 1 \tag{5.4}$$

Each map  $f_a : I \rightarrow I$  defined on the interval  $I = [-1, 1]$  satisfies the following properties:

( $r_0$ ) *existence of singular set:*  $f_a$  is a  $C^{1+}$  local diffeomorphism outside a singular set  $\mathcal{S}_a = \{0\}$  where  $f_a$  has a discontinuity. We suppose that

$$\lim_{x \rightarrow 0^+} f_a(x) = -1, \quad \lim_{x \rightarrow 0^-} f_a(x) = 1;$$

( $r_1$ ) *order of singularity:* there are constants  $\alpha, B > 0$  such that for all  $x \in I$

$$B^{-1}|x|^\alpha \leq f'_a(x) \leq B|x|^\alpha,$$



where  $\alpha = \alpha(a)$  depends on the parameter  $a \in E$  (the constant  $B$  may be chosen uniformly in  $\mathcal{R}$ ). To simplify we shall assume  $\alpha$  fixed as in [68]. In particular, unlike to the Lorenz singularities, we have

$$\lim_{x \rightarrow 0^\pm} f'_a(x) = 0;$$

(r<sub>2</sub>) *negative Schwarzian derivative*: there is  $\gamma < 0$  such that in  $I \setminus \{0\}$

$$S(f_a) := \left( \frac{f''_a}{f'_a} \right)' - \frac{1}{2} \left( \frac{f''_a}{f'_a} \right)^2 < \gamma;$$

(r<sub>3</sub>) *positive Lyapunov exponents*: there is  $\lambda_c > 1$  (independent of  $a$ ) such that the points  $\pm 1$  have Lyapunov exponents greater than  $\lambda_c$ :

$$(f_a^n)'(\pm 1) > \lambda_c^n, \text{ for all } n \geq 0;$$

(r<sub>3</sub>) *basic assumption*: there is  $\rho > 0$  (small and independent of  $a$ ) such that:

$$|f_a^n(\pm 1)| > e^{-\rho n}, \text{ for all } n \geq 1;$$

(r<sub>4</sub>) *transitivity*: the forward orbits of the points  $\pm 1$  under  $f_a$  are dense in  $[-1, 1]$ .

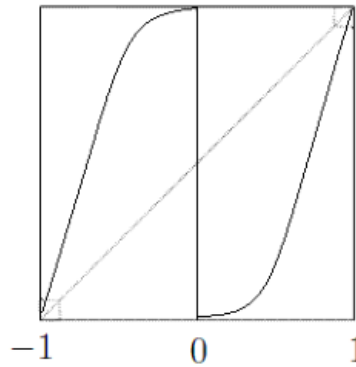

Fig. 5.5 Rovella map.

In [16, Theorem A], by considering a smaller set of the original Rovella parameters (that we also denote by  $E$ ), but still with full density at 0, the authors proved that Rovella maps  $f_a$  with  $a \in E$  are nonuniformly expanding and exhibit slow recurrence to the nondegenerate singular set. Moreover, in [16, Corollary B] they managed to prove the existence of a unique ergodic absolutely continuous invariant probability measure  $\mu_a$  for the maps in this smaller set; cf. [57]. Here, we obtain a formula for the entropy of  $\mu_a$ , illustrating once again Theorem A.

**Theorem 5.2.1.** *Let  $\mathcal{R} = \{f_a\}_{a \in E}$  be the family of Rovella maps considered above. Then, for each map  $f_a \in \mathcal{R}$ , the entropy formula holds:*

$$h_{\mu_a}(f_a) = \int \log |f'_a| d\mu_a.$$

### 5.3 Luzzatto-Viana maps

In this section, we present families of systems first introduced in [55], originally named *Lorenz-like families with criticalities*, since the authors aimed at a more global understanding of the Lorenz flow accounting for the interaction between singular and critical behavior. More precisely, we consider families  $\mathcal{LV}_f = \{f_a\}_{a \in \mathcal{A}}$  of real maps

$$f_a(x) = \begin{cases} f(x) - a, & \text{if } x > 0 \\ -f(-x) + a, & \text{if } x < 0 \end{cases} \quad (5.5)$$

derived from a smooth map  $f: \mathbb{R}^+ \rightarrow \mathbb{R}^+$  of the form  $f(x) = \psi(x^\lambda)$ , where  $0 < \lambda < 1/2$  and  $\psi$  is a smooth map defined on  $\mathbb{R}$  with  $\psi(0) = 0$  and  $\psi'(0) \neq 0$ . The function  $f$  has a critical point  $c > 0$  (where  $f'(c) = 0$ ) which is a full density point of the  $f$ -dependent parameter set  $\mathcal{A} = \mathcal{A}(f) \subseteq \mathbb{R}_{\geq c}^+$ :

$$\lim_{\varepsilon \rightarrow 0} \frac{\text{Leb}(\mathcal{A} \cap [c, c + \varepsilon])}{\varepsilon} = 1$$

Taking into account the several properties of the function  $f$  stated in [55] and a latter study [72] focused on a smaller parameter subset contained in  $[c + \rho\varepsilon, c + \varepsilon]$  with  $0 < \rho < 1$  (that we still denote by  $\mathcal{A}$ ), each element  $f_a \in \mathcal{LV}_f$  should satisfy:

(lv<sub>0</sub>) *existence of critical/singular set:*  $f_a: I_a \rightarrow I_a$  is a  $C^{1+}$  local diffeomorphism of the interval  $I_a = [-a, a]$  outside a critical/singular set  $\mathcal{S}_a = \{0, \pm c\}$  consisting of a singular point  $x = 0$  where  $f_a$  has a discontinuity with unbounded derivative and two critical points  $x = \pm c$ ;

(lv<sub>1</sub>) *order of critical/singular set:* there is  $\alpha > 0$  and  $B > 0$  such that for all  $x \in I_a \setminus \mathcal{S}_a$ , we have

$$B^{-1} \text{dist}(x, \mathcal{S}_a)^\alpha \leq |f'_a(x)| \leq B \text{dist}(x, \mathcal{S}_a)^{-\alpha};$$

(lv<sub>2</sub>) *local Hölder continuity of  $\log |f'_a|$ :* there are  $\beta, C > 0$  such that for all points  $x, y \in I \setminus \{0\}$  with  $|x - y| \leq \text{dist}(x, \mathcal{S}_a)/2$  we have

$$|\log |f'_a(x)| - \log |f'_a(y)|| \leq C \text{dist}(x, \mathcal{S}_a)^{-\alpha} |x - y|^\beta;$$

(lv<sub>3</sub>) *nonuniform expansion:* there is  $\sigma_1 > 0$  (independent of  $a$ ) such that for Lebesgue almost every point  $x \in I_a$ , we have

$$\limsup_{n \rightarrow \infty} \frac{1}{n} |\log (f_a^n)'(x)| \geq \sigma_1;$$

(lv<sub>4</sub>) *growth of derivative along the critical orbit*: there is  $\sigma > 0$  (independent of  $a$ ) such that

$$|(f_a^n)'(f_a(c))| \geq e^{\sigma n}, \text{ for all } n \geq 1;$$

(lv<sub>5</sub>) *transitivity*:  $f_a$  is transitive (actually, topologically mixing).

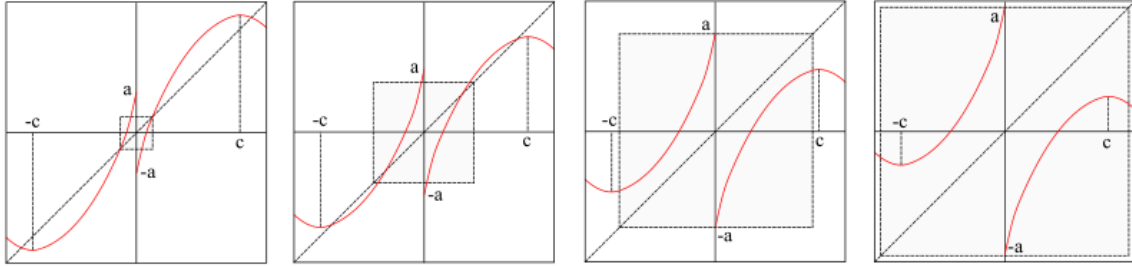

Fig. 5.6 Luzzatto-Viana maps, for several parameter values  $a > 0$ .

In a subsequent work [18], it was proved that there are a finite number of absolutely continuous invariant probability measures for the Luzzatto-Viana maps described above. This result was improved later in [72], where the authors obtained the uniqueness of the ergodic absolutely continuous probability measure  $\mu_a$  for the smaller subset of parameters that we consider here. This is actually implied by the main result in [72], stating nonuniform expansion (in the strong sense) and slow recurrence properties for the maps  $f_a \in \mathcal{LV}(f)$ , together with classical results from [5] on hyperbolic balls. We can now state our last application concerning Theorem A.

**Theorem 5.3.1.** *Let  $\mathcal{LV}_f = \{f_a\}_{a \in \mathcal{A}}$  be a family of Luzzatto-Viana maps introduced above. Then, for each map  $f_a \in \mathcal{LV}_f$ , the entropy formula below holds:*

$$h_{\mu_a}(f_a) = \int \log |f_a'| d\mu_a.$$



# Appendix A

## Background from ergodic theory

In this appendix, we briefly review some elementary concepts of ergodic theory, chiefly, the notion of *metric* or *measure-theoretic* or *Kolmogorov-Sinai entropy* [45] of a measure-preserving dynamical system, which can be understood heuristically as a measure of *chaos* or, more properly, the rate of increase in dynamical complexity as the system is iterated. Proposition A.1.1 provides an interesting alternative way of computing the entropy from a somewhat more combinatorial viewpoint and is proved in [69], under the assumption that the transformation is invertible. As communicated personally by J. Buzzi, such assumption is not necessary at all and we present here the proof of the result in full generality. We refer the reader to the introductory book [58] for supplementary background on ergodic theory necessary to this work, in particular for the classical theorems of Birkhoff, Oseledets and Shannon-McMillan-Breimann often cited.

### A.1 Entropy

A *measure-preserving system* (m.p.s.) is a quadruple  $(M, \mathcal{B}, \mu, f)$  consisting of a probability space  $(M, \mathcal{B}, \mu)$ , and a *measure-preserving transformation* (m.p.t)  $f : M \rightarrow M$ . This means that  $\mu$  is a probability measure defined on a  $\sigma$ -algebra  $\mathcal{B}$  of subsets of  $M$  and

$$f^{-1}(B) \in \mathcal{B} \text{ and } \mu(f^{-1}(B)) = \mu(B), \text{ for all } B \in \mathcal{B}.$$

A set  $B \in \mathcal{B}$  is called *invariant* if  $f^{-1}(B) = B$ . A m.p.s.  $(M, \mathcal{B}, \mu, f)$  is said to be *ergodic* if for all invariant sets  $B \in \mathcal{B}$  we have  $\mu(B) \in \{0, 1\}$ . In other words, a system is ergodic if it cannot be decomposed into two dynamical subsystems bearing measure-theoretical significance and therefore ergodic systems are like the ergodic theory's counterparts to the prime numbers in number theory. A  $\mu$  mod 0 *partition*  $\mathcal{P}$  on  $M$  is a finite or countable family of pairwise disjoint measurable subsets of  $M$  whose union has full  $\mu$ -measure. We denote by  $\mathcal{P}(x)$  the element of  $\mathcal{P}$  containing  $x$ . Given a finite or

countable family of partitions  $\mathcal{P}_1, \mathcal{P}_2, \dots$  on  $M$ , their *joining* is the partition

$$\bigvee_n \mathcal{P} := \left\{ \bigcap_n P_n \mid P_n \in \mathcal{P}_n \text{ for all } n \right\}.$$

In particular, given a partition  $\mathcal{P} = \{P_i\}$  on  $M$  and  $n \in \mathbb{N}$ , the *dynamically generated partition*

$$\mathcal{P}^n := \bigvee_{j=0}^n f^{-j}(\mathcal{P})$$

consists of sets of the form

$$[P_{i_0}, \dots, P_{i_n}] := \bigcap_{k=0}^n f^{-k}(P_{i_k}) = \{x \in M \mid x \in P_{i_0}, \dots, f^n(x) \in P_{i_n}\},$$

for some  $P_{i_0}, P_{i_1}, \dots, P_{i_n} \in \mathcal{P}$ . The *entropy of a partition*  $\mathcal{P}$  of  $M$  with respect to  $\mu$  is defined by

$$H_\mu(\mathcal{P}) := - \sum_{P \in \mathcal{P}} \mu(P) \log \mu(P),$$

and the *entropy of  $f$  and a partition*  $\mathcal{P}$  with respect to  $\mu$  is given by

$$h_\mu(f, \mathcal{P}) := \lim_{n \rightarrow \infty} \frac{1}{n} H_\mu(\mathcal{P}^n).$$

The *metric or measure-theoretic entropy* of  $f$  with respect to  $\mu$  is the number

$$h_\mu(f) := \sup_{\mathcal{P}} h_\mu(f, \mathcal{P}),$$

where the supremum is taken over all the (finite) measurable partitions of  $M$ .

The next result provides an interesting way of computing the entropy from a somewhat 'more' combinatorial viewpoint providing a very nice interpretation of this concept as well. Given a finite measurable partition  $\mathcal{P}$  of  $M$  and a real number  $0 < c < 1$ , denote by  $r(\mathcal{P}, n, \mu, c)$  the minimum number of elements of  $\mathcal{P}^n$  whose union has  $\mu$ -measure at least  $c$ .

**Proposition A.1.1.** *Let  $(M, \mathcal{B}, \mu, f)$  be an ergodic measure-preserving system and  $\mathcal{P}$  a finite partition of  $M$ . Then, for all  $0 < c < 1$ ,*

$$h_\mu(f, \mathcal{P}) = \lim_{n \rightarrow \infty} \frac{1}{n} \log r(\mathcal{P}, n, \mu, c).$$

*Proof.* Clearly,  $H_\mu(\mathcal{P}) < \infty$ . By the Shannon-McMillan-Breiman Theorem, for  $\mu$ -almost every  $x \in M$ , we have

$$h_\mu(f, \mathcal{P}) = \lim_{n \rightarrow \infty} -\frac{1}{n} \log \mu(\mathcal{P}^n(x)).$$

This implies that for all  $\varepsilon > 0$  and  $0 < \delta < 1$ , there is a set  $X \subseteq M$  and  $N \in \mathbb{N}$  such that:

1.  $\mu(X) > \delta$ , and

2. for all  $x \in X$  and  $n > N$ , we have  $e^{-n(h_\mu(f, \mathcal{P}) + \varepsilon)} \leq \mu(\mathcal{P}^n(x)) \leq e^{-n(h_\mu(f, \mathcal{P}) - \varepsilon)}$ .

In particular, if  $r(X, n)$  is the minimum number of elements of  $\mathcal{P}^n$  necessary to cover  $X$ , we have

$$\delta e^{n(h_\mu(f, \mathcal{P}) - \varepsilon)} \leq r(X, n) \leq e^{n(h_\mu(f, \mathcal{P}) + \varepsilon)}.$$

Moreover, given any  $0 < c < 1$  such that  $1 > \delta > \max\{c, 1 - c\} > 1/2$  and any set  $Y$  with  $\mu(Y) > c$ , we have

$$\mu(X \cap Y) > c + \delta - 1 > 0.$$

Therefore, for all  $\varepsilon > 0$ ,  $0 < c < 1$  and  $1 > \delta > \max\{c, 1 - c\} > 1/2$ , there is  $N \in \mathbb{N}$  such that, for all  $n \geq N$ ,

$$(c + \delta - 1) \cdot e^{n(h_\mu(f, \mathcal{P}) - \varepsilon)} < r(\mathcal{P}, n, \mu, c) \leq e^{n(h_\mu(f, \mathcal{P}) + \varepsilon)}.$$

From these inequalities, we get

$$h_\mu(f, \mathcal{P}) = \lim_{n \rightarrow \infty} \frac{1}{n} \log r(\mathcal{P}, n, \mu).$$

□

*Remark A.1.2.* A useful consequence of the proof above is this: for all  $\varepsilon > 0$  and  $0 < c < 1$ , there is a subset  $A \subseteq M$  with  $\mu(A) > c$  and  $N \in \mathbb{N}$  such that for all  $n \geq N$  the minimum number of elements of  $\mathcal{P}^n$  necessary to cover  $A$  is at most  $e^{n(h_\mu(f, \mathcal{P}) + \varepsilon)} \leq e^{n(h_\mu(f) + \varepsilon)}$ .

### Combinatorial estimates

Given  $n, k \in \mathbb{N}_0$ , the  $(n, k)$  *binomial coefficient* is the number

$$C_k^n := \frac{n!}{(n-k)!k!} = \frac{n(n-1)\cdots(n-k+1)}{k(k-1)\cdots 1}.$$

Proposition A.1.3 below will be useful to estimate the quantity  $r(\mathcal{P}, n, \mu, c)$  (and thus the entropy), providing an useful exponential upper bound for binomial coefficients based on the *Stirling approximation*:

$$n! \sim \sqrt{2\pi n} \left(\frac{n}{e}\right)^n,$$

with  $a_n \sim b_n$  meaning that the ratio  $a_n/b_n$  tends to 1 as  $n \rightarrow \infty$ .

**Proposition A.1.3.** *Given  $\varepsilon > 0$ , there are  $0 < \delta < 1$ ,  $N \in \mathbb{N}$  and  $C = C(N, \delta) > 0$  such that, for all  $n \geq N$ ,*

$$C_{[\delta n]}^n \leq C e^{\varepsilon n},$$

where  $[r]$  stands for the smallest integer greater or equal than  $r \in \mathbb{R}$ .





## Appendix B

# Constructing Young structures

In this appendix, for the sake of the reader's convenience, we present the partitioning algorithm of the reference leaf and other more or less standard check-ups, as these do not contain any particular novelty or require substantial adaptations in this setting; however, the construction in [8, Section 5], from where it is drawn, is improved here, in the sense that clearer arguments on the integrability of the recurrence times and satellite estimates are provided and it serves as well for the purpose of the construction of the Gibbs-Markov structures for endomorphisms. The material in this appendix comes from [3] nearly verbatim.

### B.1 Partition on the reference leaf

Our goal in this section is to introduce a partitioning algorithm of the reference leaf  $\Delta_0 = B_{\delta_0}^{cu}(p)$  given by Lemma 4.5.1 under the validity of (A<sub>1</sub>)-(A<sub>3</sub>). If necessary, we choose  $\delta_0 > 0$  smaller so that any  $cu$ -disk intersecting  $W_{3\delta_0/4}$  cannot reach the top or bottom parts of  $\mathcal{C}_0 = \mathcal{C}(\Delta_0)$ , i.e., the boundary points of the local stable manifolds  $W_{\delta_0}^s(x)$  through points  $x \in \Delta_0$ . Set  $\Delta_1 = B_{2\delta_0}^{cu}(p)$ ,  $\mathcal{C}_1 = \mathcal{C}(\Delta_1)$  and let  $\Theta: \mathcal{C}_1 \rightarrow \Delta_1$  be the projection along the stable disks.

From Lemma 4.5.1, given any  $x \in H_n$ , there are  $0 \leq l_x \leq L$  and sets  $\omega_{n,l}(x) \subset \tilde{\omega}_{n,l}(x) \subset W_n(x)$  such that  $f^{n+l_x}(\omega_{n,l}(x))$   $u$ -crosses  $\Delta_0$  and  $f^{n+l_x}(\tilde{\omega}_{n,l}(x))$   $u$ -crosses  $\Delta_1 = B_{2\delta_0}^{cu}(p)$ . Notice that a priori there may be several values of  $l = l_x \leq L$  satisfying the  $u$ -crossing condition; for the sake of definiteness, we will always assume that  $l$  takes the smallest possible value. Notice that the set  $\omega_{n,l}(x)$  is associated to the point  $x$ , by construction, but does not necessarily contain  $x$ .

We will lighten the notation and refer to the sets  $\omega_{n,l}(x)$  simply as  $\omega$  and to sets  $\tilde{\omega}_{n,l}(x)$  as  $\tilde{\omega}$ . In such cases, as before, we consider

$$W_n(\omega) = W_n(x), \tilde{W}_n(\omega) = \tilde{W}_n(x), V_n(\omega) = V_n(x) \text{ and } l_\omega = l, \quad (\text{B.1})$$

where the sets  $W_n(x) \subset \tilde{W}_n(x) \subset V_n(x)$  are such that  $f^n$  maps  $W_n(x)$  diffeomorphically to the disk of radius  $\delta_1/9$  and  $\tilde{W}_n(x)$  to the disk of radius  $\delta_1/3$ , both centered at  $f^n(x)$ . Given a domain  $\omega = \omega_{k,l}$

define for each  $n > k$  the annulus

$$A_n(\omega) = \{y \in \tilde{\omega} : \text{dist}_{k+l}(f^{k+l}(y), f^{k+l}(\omega)) \leq \delta_0 \sigma^{n-k}\}. \quad (\text{B.2})$$

It follows directly from the definition that  $A_n(\omega) \supset A_{n+1}(\omega) \supset \omega$  for all  $n > k$ . In addition to that, it follows that  $f^{k+l}(\tilde{\omega})$  contains a neighbourhood of the outer component of the boundary of  $f^{k+l}(A_n(\omega))$  of size at least  $2\delta_0 - \delta_0(1 + \sigma^{n-k}) = \delta_0(1 - \sigma^{n-k})$ . Then using (A3) we easily get that  $f^k(\tilde{\omega})$  contains a neighbourhood of the outer component of the boundary of  $f^k(A_n(\omega))$  of size at least  $\delta_0(1 - \sigma^{n-k})/C_1$ . Bearing in mind this, we consider  $\delta_1 > 0$  and  $0 < \sigma < 1$  as in (A2) and  $C_1, \delta_0 > 0$  as in (A3) and take

$$\delta_2 = \delta_0 + \frac{\delta_1}{2}C_1, \quad (\text{B.3})$$

a large  $N_0 \in \mathbb{N}$  such that

$$C_1 \sigma^{N_0} < 1 \quad (\text{B.4})$$

and a large  $N_1 \in \mathbb{N}$  such that

$$\delta_2 \sigma^{N_1} \leq \delta_0 \text{ and } \frac{2\delta_1}{9} \sigma^{N_1} \leq \frac{\delta_0(1 - \sigma^{N_1})}{C_1}. \quad (\text{B.5})$$

We will construct inductively sequences of objects  $(\mathcal{P}_n)_n$ ,  $(\Delta_n)_n$  and  $(S_n)_n$  related to the sets  $(H_n)_n$ . For each  $n$ , we take  $\mathcal{P}_n$  as the union of elements of the partition constructed at step  $n$  - all of them domains of the form  $\omega = \omega_{n,l}$  - and  $\Delta_n$  the set of points which do not belong to any element of the partition constructed until time  $n$ . The set  $S_n$  contains domains which could have been chosen for the partition but intersect already other elements previously chosen.

### First step

We start our inductive construction at time  $N_0$  for some  $N_0$  sufficiently large. Since  $H_{N_0}$  is a compact set by (A1), there must be a finite set  $F_{N_0} \subset H_{N_0}$  such that

$$H_{N_0} \subset \bigcup_{x \in F_{N_0}} W_{N_0}(x).$$

Consider  $x_1, \dots, x_{j_{N_0}} \in F_{N_0}$  and, for each  $1 \leq i \leq j_{N_0}$ , a domain  $\omega_{N_0, l_i} \subset W_{N_0}(x_i)$  as in (A3), such that

$$\mathcal{P}_{N_0} = \{\omega_{N_0, l_1}, \dots, \omega_{N_0, l_{j_{N_0}}}\}$$

is a maximal family of pairwise disjoint sets contained in  $\Delta_0$ . These are precisely the elements of the partition  $\mathcal{P}$  constructed in our first step of induction. Set

$$\Delta_{N_0} = \Delta_0 \setminus \bigcup_{\omega \in \mathcal{P}_{N_0}} \omega.$$

For each  $\omega \in \mathcal{P}_{N_0}$ , define

$$S_{N_0}(\omega) = \tilde{W}_{N_0}(\omega) \supset \omega,$$

with  $\tilde{W}_{N_0}(\omega)$  defined as in (B.1). Define

$$S_{N_0}(\Delta_0) = \bigcup_{\omega \in \mathcal{P}_{N_0}} S_{N_0}(\omega),$$

and for  $\Delta_0^c = \Sigma \setminus \Delta_0$

$$S_{N_0}(\Delta_0^c) = \{x \in \Delta_0 : \text{dist}(x, \partial \Delta_0) < 2\delta_1 \sigma^{N_0}\}.$$

Finally, set  $S_{N_0} = S_{N_0}(\Delta_0) \cup S_{N_0}(\Delta_0^c)$ . This completes the first step of the induction

### General step

Given  $n > N_0$ , assume that  $\mathcal{P}_k$ ,  $\Delta_k$  and  $S_k$  have already been defined for all  $k$  with  $N_0 \leq k \leq n-1$ . Let  $F_n$  be a finite subset of the compact set  $H_n$  such that

$$H_n \subset \bigcup_{x \in F_n} W_n(x). \quad (\text{B.6})$$

Consider  $x_1, \dots, x_{j_n} \in F_n$  and for each  $1 \leq i \leq j_n$  a domain  $\omega_{n,l_i} \subset W_n(x_i)$  as in (A3) for which

$$\mathcal{P}_n = \{\omega_{n,l_1}, \dots, \omega_{n,l_{j_n}}\}$$

is a maximal family of pairwise disjoint sets contained in  $\Delta_{n-1}$  such that for each  $1 \leq i \leq j_n$  we also have

$$\omega_{n,l_i} \cap \left( \bigcup_{k=N_0}^{n-1} \bigcup_{\omega \in \mathcal{P}_k} A_n(\omega) \right) = \emptyset. \quad (\text{B.7})$$

The sets in  $\mathcal{P}_n$  are the elements of the partition  $\mathcal{P}$  obtained in the  $n$ -th step of the construction. Set

$$\Delta_n = \Delta_0 \setminus \bigcup_{k=N_0}^n \bigcup_{\omega \in \mathcal{P}_k} \omega \quad (\text{B.8})$$

Finally, we define the sets  $S_n$ . Let  $N_0 \leq k \leq n$  and consider a domain  $\omega = \omega_{k,l} \in \mathcal{P}_k$ . If  $n < k + N_1$  define

$$S_n(\omega) = \tilde{W}_k(\omega)$$

and for  $n \geq k + N_1$ ,

$$S_n(\omega) = \{y \in \tilde{\omega} : 0 < \text{dist}_{k+l}(f^{k+l}(y), f^{k+l}(\omega)) \leq \delta_2 \sigma^{n-k}\}. \quad (\text{B.9})$$

Define in a similar way

$$S_n(\Delta_0) = \bigcup_{k=N_0}^n \bigcup_{\omega \in \mathcal{P}_k} S_n(\omega), \quad (\text{B.10})$$

and

$$S_n(\Delta_0^c) = \{x \in \Delta_0 : \text{dist}(x, \partial\Delta_0) < \delta_1 \sigma^n\}.$$

Let  $S_n = S_n(\Delta_0) \cup S_n(\Delta_0^c)$ . This completes the inductive step. For definiteness, set  $\Delta_n = S_n = \Delta_0$  for each  $1 \leq n < N_0$ . Finally, define

$$\mathcal{P} = \bigcup_{n \geq N_0} \mathcal{P}_n.$$

By construction, the elements in  $\mathcal{P}$  are pairwise disjoint and contained in  $\Delta_0$ . However, it is still not clear that they form a Leb mod 0 partition of  $\Delta_0$  since it is theoretically conceivable a priori that  $\mathcal{P}$  may not have full measure in  $\Delta_0$ . Nevertheless, this will follow from the results we present in the sequel.

### Key relations

Proposition B.1.1 below - stating that points in  $H_n$  which have not been taken by an element of the partition until the moment  $n$  necessarily belong to  $S_n$  - is a key property. First of all, observe that for each  $x \in H_k$  and  $y \in H_n$  with  $n \geq k$  we have

$$\begin{cases} W_n(y) \cap W_k(x) \neq \emptyset \Rightarrow W_n(y) \subset \tilde{W}_k(x) \\ \tilde{W}_n(y) \cap \tilde{W}_k(x) \neq \emptyset \Rightarrow \tilde{W}_n(y) \subset V_k(x) \end{cases} \quad (\text{B.11})$$

To see this, recall that by  $(A_2)$  we have

$$\text{diam}(f^k(W_n(y))) \leq \frac{2\delta_1}{9} \sigma^{n-k} \leq \frac{2\delta_1}{9}. \quad (\text{B.12})$$

Then assuming that  $W_n(y)$  intersects  $W_k(x)$ , we necessarily have that  $f^k(W_n(y))$  intersects  $f^k(W_k(x))$ , which by definition is a disk of radius  $\delta_1/9$  around  $f^k(x)$ . Together with (B.12), this implies that  $f^k(W_n(y))$  is contained in the disk of radius  $\delta_1/3$  centred at  $f^k(x)$ , and so, as  $W_n(y)$  and  $W_k(x)$  are both contained in  $\Sigma$ , the first case of (B.11) follows. The second case can be proved similarly.

By definition, for each  $\omega \in \mathcal{P}_k$ , with  $k \geq N_0$ , we have

$$\tilde{W}_k(\omega) \supset S_k(\omega) \supset S_{k+1}(\omega) \supset \dots \quad (\text{B.13})$$

and for  $n \geq k + N_1$  we even have

$$W_k(\omega) \supset S_n(\omega). \quad (\text{B.14})$$

It follows immediately from the definitions and B.11 that for all  $k_2 \geq k_1 \geq N_0$  and  $\omega_1 \in \mathcal{P}_{k_1}$ ,  $\omega_2 \in \mathcal{P}_{k_2}$  we have

$$S_{k_2}(\omega_2) \cap \tilde{W}_{k_1}(\omega_1) \neq \emptyset \Rightarrow S_{k_2}(\omega_2) \cup \omega_2 \subset V_{k_1}(\omega_1) \quad (\text{B.15})$$

and for all  $n \geq N_1$

$$S_{k_2+n}(\omega_2) \cap W_{k_1}(\omega_1) \neq \emptyset \Rightarrow S_{k_2+n}(\omega_2) \cup \omega_2 \subset \tilde{W}_{k_1}(\omega_1). \quad (\text{B.16})$$

**Proposition B.1.1.** *For all  $n \geq N_0$ , we have  $H_n \cap \Delta_n \subset S_n := S_n(\Delta_0) \cup S_n(\Delta_0^c)$ .*

*Proof.* Consider the finite set  $F_n \subset H_n$  used to define the elements in  $\mathcal{P}_n$ . Given  $z \in H_n \cap \Delta_n$ , there must be some  $y \in F_n$  such that  $z \in W_n(y)$ . Let  $\omega_{n,l}$  be the domain associated to  $W_n(y)$  as in (A<sub>3</sub>). It is enough to show that  $W_n(y) \subset S_n(\Delta_0) \cup S_n(\Delta_0^c)$ . If  $\omega_{n,l} \in \mathcal{P}_n$ , then  $S_n(\omega_{n,l}) = \tilde{W}_n(y) \supset W_n(y)$  and so we are done. If  $\omega_{n,l} \notin \mathcal{P}_n$ , then at least one of the following situations holds:

1.  $\omega_{n,l} \cap \omega \neq \emptyset$  for some  $\omega \in \mathcal{P}_n$ .

In this case, we have  $S_n(\omega) = \tilde{W}_n(\omega)$  and  $W_n(y) \cap W_n(\omega) \neq \emptyset$ . hence, using (B.11) we get

$$W_n(y) \subset \tilde{W}_n(\omega) = S_n(\omega) \subset S_n(\Delta_0).$$

2.  $\omega_{n,l} \cap A_n(\omega) \neq \emptyset$ , for some  $N_0 \leq k < n$  and  $\omega \in \mathcal{P}_k$ .

Observe that by definition we have  $A_n(\omega) \subset \tilde{\omega} \subset W_k(\omega)$ . Assume first that  $n - k < N_1$ . Then, as in the previous situation,

$$W_n(y) \subset \tilde{W}_k(\omega) = S_n(\omega) \subset S_n(\Delta_0).$$

Assume now that  $n - k \geq N_1$ . We claim that in this situation

$$W_n(y) \subset \tilde{\omega}. \tag{B.17}$$

Indeed, it follows from the observations after the Definition B.2 that the set  $f^k(\tilde{\omega})$  contains a neighbourhood of the outer component of the boundary of  $f^k(A_n(\omega))$  of size at least

$$\frac{\delta_0(1 - \sigma^{N_1})}{C_1}.$$

On the other hand, by definition of  $W_n(y)$  and (A<sub>2</sub>) we have

$$\text{diam}(f^k(W_n(y))) \leq \frac{2\delta_1}{9} \sigma^{n-k} \leq \frac{2\delta_1}{9} \sigma^{N_1}. \tag{B.18}$$

Recalling (B.5) and observing that in the situation we are considering the set  $f^k(W_n(y))$  intersects  $f^k(A_n(\omega))$ , we have  $f^k(W_n(y)) \subset f^k(\tilde{\omega})$ . Then, since  $W_n(y) \cap \tilde{\omega} \neq \emptyset$  and  $f^k$  maps  $\tilde{\omega}$  bijectively onto its image we deduce (B.17). Now, letting  $0 \leq l_\omega \leq L$  be the integer associated with the domain  $\omega$ , using (A<sub>3</sub>) and (B.18) we obtain

$$\text{diam}(f^{k+l_\omega}(W_n(y))) \leq \frac{2\delta_1}{9} C_1 \sigma^{n-k}. \tag{B.19}$$

Since the set  $f^{k+l_\omega}(W_n(y))$  intersects  $f^{k+l_\omega}(A_n(\omega))$ , we have for each  $w \in f^{k+l_\omega}(W_n(y))$ ,

$$\text{dist}_0(w, \Delta_0) \leq \delta_0 \sigma^{n-k} + \frac{2\delta_1}{9} C_1 \sigma^{n-k} = \delta_2 \sigma^{n-k}.$$

This shows that  $W_n(y) \subset S_n(\omega) \subset S_n(\Delta_0)$ .

3.  $\omega_{n,l} \cap \Delta_0^c$ .

This in particular implies that  $W_n(y)$  intersects  $\partial\Delta_0$ . From (A<sub>2</sub>) we get

$$\text{diam}(W_n(y)) \leq \frac{2\delta_1}{9} \sigma^n,$$

and so  $W_n(y) \subset S_n(\Delta_0^c)$ . □

### Metric estimates

Here we obtain some metric estimates concerning the satellites  $S_n$ . First of all, notice that there exists some uniform constant  $C_2 > 0$  such that for every  $n \geq 1$ , every hyperbolic predisk  $V_n(\omega)$  and every Borel sets  $A_1, A_2 \subset V_n(\omega)$  we have

$$\frac{1}{C_2} \frac{m(A_1)}{m(A_2)} \leq \frac{m_n(f^n(A_1))}{m_n(f^n(A_2))} \leq C_2 \frac{m(A_1)}{m(A_2)}, \quad (\text{B.20})$$

and for any Borel sets  $A_1, A_2 \subset f^n(\tilde{\omega}_{n,l})$ , with  $\omega_{n,l} \subset \tilde{\omega}_{n,l}$  as in (A<sub>3</sub>), we have

$$\frac{1}{C_2} \frac{m_n(A_1)}{m_n(A_2)} \leq \frac{m_{n+l}(f^l(A_1))}{m_{n+l}(f^l(A_2))} \leq C_2 \frac{m_n(A_1)}{m_n(A_2)}. \quad (\text{B.21})$$

This can be deduced easily from the distortion properties in (A<sub>2</sub>) and (A<sub>3</sub>).

**Lemma B.1.2.** *There exists  $C > 0$  such that for all  $n \geq k \geq N_0$  and all  $\omega \in \mathcal{P}_k$  we have*

$$m(S_n(\omega)) \leq C \sigma^{n-k} m(\omega).$$

*Proof.* Consider first the case  $n \geq k + N_1$ . Letting  $l = l_\omega$  recall that

$$S_n(\omega) = \{y \in \tilde{\omega} : 0 < \text{dist}_{k+l}(f^{k+l}(y), f^{k+l}(\omega)) \leq \delta_2 \sigma^{n-k}\}.$$

Moreover,  $f^{k+l}$  maps  $\tilde{\omega}$  diffeomorphically to a disk of radius  $2\delta_0$  and  $\omega$  to a disk of radius  $\delta_0$  concentric with  $f^{k+l}(\tilde{\omega})$ . Then, there must be some uniform constant  $D > 0$  such that

$$m_{k+l}(f^{k+l}(S_n(\omega))) \leq D \sigma^{n-k}.$$

Taking  $\delta > 0$  a uniform lower bound for the measure of disks of radius  $\delta_0$ , it follows from (B.20) and (B.21) that

$$\frac{m(S_n(\omega))}{m(\omega)} \leq C_2 \frac{m_{k+l}(f^{k+l}(S_n(\omega)))}{m_{k+l}(f^{k+l}(\omega))} \leq \frac{C_2^2 D}{\delta} \sigma^{n-k}. \quad (\text{B.22})$$

Consider now the case  $n < k + N_1$ . Since  $S_n(\omega) \subset V_k(\omega)$ , from (B.20) we get

$$m(S_n(\omega)) \leq C_2 m(\omega). \quad (\text{B.23})$$

Finally, choose  $C \geq C_2^2 D / \delta$  sufficiently large so that  $C_2 \leq C \sigma^{N_1}$ . Using (B.22), (B.23) and noticing that  $\sigma_1^N \leq \sigma^{n-k}$  for  $n < k + N_1$ , we easily obtain the desired conclusion.  $\square$

**Lemma B.1.3.**  $\sum_{n=N_0}^{\infty} m(S_n) < \infty$ .

*Proof.* First we consider the terms in  $S_n(\Delta_0)$ . Recalling (B.10) and using Lemma B.1.2, for each  $n \geq N_0$  we may write

$$\begin{aligned} m(S_n(\Delta_0)) &\leq \sum_{k=N_0}^n \sum_{\omega \in \mathcal{P}_k} m(S_n(\omega)) \\ &\leq \sum_{k=N_0}^n \sum_{\omega \in \mathcal{P}_k} C \sigma^{n-k} m(\omega) \\ &= C \sum_{k=N_0}^n \sigma^{n-k} m\left(\bigcup_{\omega \in \mathcal{P}_k} \omega\right). \end{aligned}$$

Hence

$$\sum_{n \geq N_0} m(S_n(\Delta_0)) = \sum_{n \geq N_0} \sum_{k \geq 0} \sigma^k m\left(\bigcup_{\omega \in \mathcal{P}_n} \omega\right) = \frac{1}{1-\sigma} m(\Delta_0).$$

On the other hand, recalling that

$$S_n(\Delta_0^c) = \{x \in \delta_0 : \text{dist}(x, \partial \Delta_0) < \delta_1 \sigma^n\},$$

we may find  $C > 0$  such that  $m(S_n(\Delta_0^c)) \leq C \sigma^n$ . This obviously gives that the sum of the corresponding terms is finite.  $\square$

## Conclusion

We can now conclude that  $\mathcal{P}$  is an  $m \bmod 0$  partition of  $\Delta_0$ . By definition of the sets  $\Delta_n$ , it is enough to show that the intersection of all these sets has zero Lebesgue measure. Assume by contradiction that

$$m\left(\bigcap_{n \geq N_0} \Delta_n\right) > 0.$$

It follows from (A<sub>1</sub>) that there must be some set  $B \subset \Delta_0$  with  $\text{Leb}(B) > 0$  such that for every  $x \in B$  we can find infinitely many times  $n_1 < n_2 < \dots$  (in principle depending on  $x$ ) so that  $x \in H_{n_k} \cap \Delta_{n_k}$  for each  $k \in \mathbb{N}$ . It follows from the Proposition B.1.1 that

$$x \in S_{n_k}(\Delta_0) \cup S_{n_k}(\Delta_0^c), \text{ for all } k \in \mathbb{N}_0. \quad (\text{B.24})$$

On the other hand, using Lemma B.1.3 and Borel Cantelli Lemma we easily deduce that for Lebesgue almost every  $x \in \Delta_0$  we cannot have  $x \in S_n(\Delta_0) \cup S_n(\Delta_0^c)$  for infinitely many values of  $n$ . Clearly, this gives a contradiction with the fact that  $m(B) > 0$  and (B.24) holds for every  $x \in B$ .

## B.2 The Young structure

Consider the  $m_{\Delta_0} \bmod 0$  partition  $\mathcal{P}$  into domains  $\omega_{n,l} \subset \Delta_0$  and the function  $R: \Delta_0 \rightarrow \mathbb{N}$  constant on the elements of  $\mathcal{P}$  given by  $R(\omega_{n,l}) = n + l$ . Define

$$\Gamma^s = \{W_{\delta_s^s}^s(x) : x \in \Delta_0\}, \quad (\text{B.25})$$

and  $\Gamma^u$  as the set of all local unstable manifolds contained in  $\mathcal{C}_0$  which  $u$ -cross  $\mathcal{C}_0$ . We thus define our set  $\Lambda$  with hyperbolic product structure as the intersection of these families of stable and unstable leaves. This hyperbolic structure is measurable since the stable disks  $\gamma_{\delta_s/2}^s(x)$  depend continuously (in the  $C^1$  topology) on  $x \in \Delta_0$ , and therefore the holonomy maps are measurable.

Defining  $\Lambda_\omega = \mathcal{C}(\omega) \cap \Lambda$ , for each  $\omega \in \mathcal{P}$ , we have a countable partition of  $\Lambda$  into  $s$ -subsets. Set  $R|\Lambda_\omega = R(\omega)$  for each  $\omega \in \mathcal{P}$ . Each  $\omega \in \mathcal{P}$  returns to  $\mathcal{C}_0$  intersecting the stable disk  $\gamma_{\delta_s/2}^s(p)$ . Also, we have chosen  $\delta_0 > 0$  so that any  $cu$ -disk intersecting  $\gamma_{\delta_s/2}^s(p)$  is at distance greater than  $\delta_s/4$  from the top and the bottom of  $\mathcal{C}_0$ . Since we may choose the recurrence time  $R$  arbitrarily large, we may ensure that the stable disks return inside  $\mathcal{C}_0$  in the corresponding recurrence time. Hence, the Markov property (Y<sub>1</sub>) is satisfied.

The contraction property (Y<sub>2</sub>) is obvious in this case, for stable disks are uniformly contracted when forward iterated.

The expansion property (Y<sub>3</sub>) is ensured by the conditions (A<sub>2</sub>)-(A<sub>3</sub>), but only for the domains in the unstable disk  $\Delta_0 \in \Gamma^u$ . Given any other  $\gamma \in \Gamma^u$  and  $\Lambda_\omega$ , we have  $\omega = \omega_{n,l}$  for some  $x \in H_n$  and  $0 \leq l \leq L$ . Then, by Lemma 4.4.4  $n$  is a  $(\sigma^{1/2}, r)$ -hyperbolic time for all  $z \in \omega$ . Since we have chosen  $\delta_s < \delta_1$ , it follows that  $n$  is a  $(\sigma^{1/4}, r)$ -hyperbolic time for the points in  $\omega' = \gamma \cap \Lambda_\omega$ . This shows that we may think of  $\omega'$  as a domain of the type  $\omega'_{n,l}$  for which (A<sub>3</sub>) holds, associated to predisks of points in a set  $H'_n$  satisfying (A<sub>1</sub>)-(A<sub>2</sub>) with  $n$  a  $(\sigma^{1/4}, r)$ -hyperbolic time. So, the expansion property (A<sub>3</sub>) follows for these domains. It is worth noticing that we also have  $C > 0$  and  $0 < \beta < 1$  such that

$$\log \frac{\det Df^R|_{T_x\gamma}}{\det Df^R|_{T_y\gamma}} \leq C\beta^{s(f^R(x), f^R(y))}. \quad (\text{B.26})$$

We may need to take bigger  $\beta < 1$ , but still uniform on all leaves  $\gamma \in \Gamma^u$  and  $x, y \in \gamma$ . Choosing  $\gamma_0 = \Delta_0$  in (Y<sub>5</sub>), the bounded distortion property follows.

It remains to show the absolute continuity property (Y<sub>4</sub>). Given  $\gamma, \gamma' \in \Gamma^u$ , consider  $\Theta_{\gamma, \gamma'}$  as in (4.1). Set  $\gamma_i = f^i(\gamma)$  and  $x_i = f^i(x)$  for each  $x \in \gamma$  and  $i \geq 0$  and similar for  $x' \in \gamma'$ . We have  $(\Theta_{\gamma, \gamma'})_* m_\gamma$



absolutely continuous with respect to  $m_{\gamma'}$  and its densities  $\xi_{\gamma, \gamma'}$  is given by

$$\xi_{\gamma, \gamma'}(x') = \prod_{i=0}^{\infty} \frac{\det Df|_{T_{x'_i} \gamma'_i}}{\det Df|_{T_{x_i} \gamma_i}},$$

for each  $x' \in \gamma'$ , where  $x$  is the point in  $\gamma$  such that  $\Theta_{\gamma, \gamma'}(x) = x'$ . Now observe that as  $f$  is a  $C^{1+\beta}$  diffeomorphism, the fiber bundles  $E^s$  and  $E^{cu}$  are Hölder continuous on  $\Omega$ . Thus, using that the stable disks are uniformly contracted, we may find  $C_0$  and  $0 < \beta_0 < 1$  such that for all  $x \in \gamma$  and  $x' \in \gamma'$  with  $x' \in \gamma^s(x)$  we have for all  $n \geq 0$

$$\log \prod_{i=n}^{\infty} \frac{\det Df|_{T_{x'_i} \gamma'_i}}{\det Df|_{T_{x_i} \gamma_i}} \leq C_0 \beta_0^n. \quad (\text{B.27})$$

Choose  $n \sim s(x, y)/2$ . For each  $x', y' \in \gamma'$  we may write

$$\log \frac{\xi_{\gamma, \gamma'}(x')}{\xi_{\gamma, \gamma'}(y')} = \sum_{i=0}^{n-1} \log \frac{\det Df|_{T_{x'_i} \gamma'_i}}{\det Df|_{T_{y'_i} \gamma'_i}} + \sum_{i=0}^{n-1} \log \frac{\det Df|_{T_{y_i} \gamma_i}}{\det Df|_{T_{x_i} \gamma_i}} + \sum_{i=n}^{\infty} \log \frac{\det Df|_{T_{x'_i} \gamma'_i}}{\det Df|_{T_{x_i} \gamma_i}} + \sum_{i=n}^{\infty} \log \frac{\det Df|_{T_{y_i} \gamma_i}}{\det Df|_{T_{y'_i} \gamma'_i}}. \quad (\text{B.28})$$

Denote  $J_i(x) = |\det Df|_{T_{f^i(x)} \gamma_i}|$ , for all  $0 \leq i < n$  and  $x \in \gamma$ . In the light of Remark 4.4.9, we have that  $\log J_i$  is  $(Z, \zeta)$ -Hölder continuous for some  $Z > 0$ . Then, there is some uniform constant  $C' > 0$  such that

$$\sum_{i=0}^{n-1} \log \frac{\det Df|_{T_{y_i} \gamma_i}}{\det Df|_{T_{x_i} \gamma_i}} = \sum_{i=0}^{n-1} (\log J_i(y) - \log J_i(x)) \leq \sum_{i=0}^{n-1} C' d((f^i(x), f^i(y)))^\zeta.$$

Since we have chosen  $n \sim s(x, y)/2$ , the points  $f^i(x)$  and  $f^i(y)$  have at least  $s(x, y) - i$  simultaneous returns to  $\Lambda$ , for  $0 \leq i < n$ . So, using (Y<sub>3</sub>) we easily find  $C'' > 0$  such that  $d(f^i(x), f^i(y))^\zeta \leq C'' \beta^\zeta (s(x, y) - i)$ . Recalling  $s(x, y) - n \sim s(x, y)/2$ , we get for  $\beta_1 = \beta^{\zeta/2}$  and some  $C_1 > 0$

$$\sum_{i=0}^{n-1} \log \frac{\det Df|_{T_{y_i} \gamma_i}}{\det Df|_{T_{x_i} \gamma_i}} \leq C_1 \beta_1^{s(x, y)}.$$

The same conclusion can be drawn to the finite sum involving  $x'_i, y'_i$  in (B.28) above. Using (B.27) and recalling that  $n \sim s(x, y)/2$ , we obtain appropriate bounds for the infinite sums in (B.28). Altogether, these estimates yield the second part of the absolute continuity property (Y<sub>4</sub>).

### B.3 Integrability of the recurrence time

In the previous sections we have constructed an  $m \bmod 0$  partition of the disk  $\Delta_0$

$$\mathcal{P} = \bigcup_{n \geq N_0} \mathcal{P}_n,$$

where each element of  $\mathcal{P}_n$  is a domain of the type  $\omega_{n, l}$  given in (A<sub>3</sub>), associated to some point in  $H_n$  and  $0 \leq l \leq L$ . Besides, we have introduced a recurrence time function  $R: \Delta_0 \rightarrow \mathbb{N}$ , defining for each

$n \geq N_0$  and each  $y \in \omega_{n,l} \in \mathcal{P}_n$

$$R(y) = n + l. \quad (\text{B.29})$$

The goal of this section is to prove that the recurrence time function  $R : \Delta_0 \rightarrow \mathbb{N}$  is integrable with respect to the Lebesgue measure  $m_0$  on  $\Delta_0$ . Recall that the quotient map  $F$  on  $\Delta_0$  introduced in (4.3) is Gibbs-Markov and therefore has a unique ergodic  $F$ -invariant measure  $\nu_0$  which is absolutely continuous with respect to  $m_0$ . Moreover, the density of  $\nu_0$  with respect to  $m_0$  is bounded away from zero and infinity by constants. Hence, it is enough to show that  $R$  is integrable with respect to  $\nu_0$ . Consider  $(H_n)_n$  as in (A1)-(A3). Define  $R_0 = 0$  and more generally  $R_k = \sum_{j=0}^{k-1} R \circ F^j$ , for each  $k \geq 1$ . We say that a sequence  $(H_n^*)_n$  of sets in  $\Delta_0$  is *F-concatenated* in  $(H_n)_n$  if

$$x \in H_n^* \implies F^i(x) \in H_{n-R_i},$$

whenever  $R_i(x) \leq n < R_{i+1}(x)$ , for some  $i \geq 0$ . While we may actually take  $H_n^* = H_n$  for all  $n \geq 1$ , in the endomorphisms' case of Chapter 3, this notion is nevertheless relevant in the partially hyperbolic context of Chapter 4, as we shall see, owing to the fact that points in the same stable leaf do not necessarily share the same hyperbolic times. We say that  $(H_n^*)_n$  is a *frequent sequence* if there exists  $\theta > 0$  such that for  $m_0$ -almost every  $x \in \Delta_0$  we have

$$\limsup_{n \rightarrow \infty} \frac{1}{n} \#\{1 \leq j \leq n : x \in H_j^*\} > \theta. \quad (\text{B.30})$$

The proposition below gives a useful abstract criteria to verify the integrability of the recurrence time function  $R$  in terms of the concepts just introduced.

**Proposition B.3.1.** *Let  $F : \Delta_0 \rightarrow \Delta_0$  be a Gibbs-Markov map with respect to a partition  $\mathcal{P}$ , and  $R : \Delta_0 \rightarrow \mathbb{N}$  be constant in the elements of  $\mathcal{P}$ . Assume that there exist*

1. *a frequent sequence  $(H_n^*)_n$  of sets in  $\Delta_0$  that is F-concatenated in  $(H_n)_n$ ;*
2. *a sequence  $(S_n)_n$  of sets in  $\Delta_0$  such that  $\sum_{n \geq 1} m_0(S_n) < \infty$ ;*
3.  *$L \in \mathbb{N}$  such that  $H_n \cap \{R > L + n\} \subset S_n$ , for all  $n \geq 1$ .*

*Then  $R$  is integrable with respect to  $m_0$ .*

*Proof.* As observed above, it is enough to show that  $R$  is integrable with respect to  $\nu_0$ . Assume by contradiction that  $R \notin L^1(\nu_0)$ . Since  $R$  is a positive function, it follows from Birkhoff's Ergodic Theorem that

$$\lim_{k \rightarrow \infty} \frac{1}{k} \sum_{i=0}^{k-1} R(F^i(x)) \rightarrow \int R d\nu_0 = \infty, \quad (\text{B.31})$$

for  $\nu_0$  almost every  $x \in \Delta_0$ . Since  $\sum_{n \geq 1} m_0(S_n) < \infty$ , it follows from Borel-Cantelli Lemma that  $\nu_0$  almost every  $x \in \Delta_0$  belongs in a finite number of sets  $S_n$ . Define  $s(x) = \#\{n \geq 1 : x \in S_n\}$  for  $x \in \Delta_0$ .

Using that  $d\nu_0/dm_0$  is bounded above by a positive constant and Birkhoff's Ergodic Theorem, we have for  $\nu_0$  almost every  $x \in \Delta_0$

$$\frac{1}{k} \sum_{i=0}^{k-1} s(F^i(x)) \rightarrow \int s d\nu_0 = \sum_{n \geq 1} \nu_0(S_n) < \infty. \quad (\text{B.32})$$

Since  $(H_n^*)_n$  is  $F$ -concatenated in  $(H_n)_n$ , given  $i \geq 0$  and  $R_i \leq j < R_{i+1}$ , we have  $F^i(x) \in H_{j-R_i}$ , whenever  $x \in H_j^*$ . We cannot have  $R(F^i(x)) < j - R_i$ , for otherwise we would have

$$R_{i+1} - R_i = R(F^i(x)) < j - R_i \leq R_{i+1} - R_i.$$

Set  $k = j - R_i$ . Since we assume  $H_k \cap \{R > k + L\} \subset S_k$ , we have  $F^i(x) \in S_k$  or  $R(F^i(x)) = k + l$  for some  $0 \leq l \leq L$ . Thus, the number of integers  $j$  with  $R_i \leq j < R_{i+1}$  such that  $x \in H_j^*$  is bounded by the number of integers  $k$  such that  $F^i(x) \in S_k$  or  $F^i(x) \in \{R = k + l\}$ , for some  $0 \leq l \leq L$ . This means that

$$\#\{R_i \leq j < R_{i+1} : x \in H_j^*\} \leq 1 + s(F^i(x)).$$

Given  $n \geq 1$ , define  $r(n) = \min\{R_i : R_i > n\}$ . For each  $n \geq 1$ , we have

$$\#\{1 \leq j \leq n : x \in H_j^*\} \leq \sum_{i=0}^{r(n)} (1 + s(F^i(x))) \leq r(n) + \sum_{i=0}^{r(n)} s(F^i(x)).$$

Therefore,

$$\frac{1}{n} \#\{j \leq n : x \in H_j^*\} \leq \frac{r(n)}{n} \left( 1 + \frac{1}{r(n)} \sum_{i=0}^{r(n)} s(F^i(x)) \right). \quad (\text{B.33})$$

Observe that if  $r(n) = k$ , then by definition we have  $R_{k-1} \leq n < R_k$ . Hence,

$$\frac{R_{k-1}}{k} \leq \frac{n}{r(n)} < \frac{R_k}{k} = \frac{R_k}{k+1} \left( 1 + \frac{1}{k} \right),$$

which together with (B.31) gives

$$\lim_{n \rightarrow \infty} \frac{n}{r(n)} = \lim_{k \rightarrow \infty} \frac{R_k}{k} = \lim_{k \rightarrow \infty} \frac{1}{k} \sum_{i=0}^{k-1} R(F^i(x)) = \infty. \quad (\text{B.34})$$

It follows from (B.32), (B.33) and (B.34) that

$$\lim_{n \rightarrow \infty} \frac{1}{n} \#\{1 \leq j \leq n : x \in H_j^*\} = \lim_{n \rightarrow \infty} \frac{r(n)}{n} = 0,$$

which clearly contradicts the fact that  $(H_n^*)_n$  is a frequent sequence.  $\square$

Now, it remains to check the properties of Proposition B.3.1 in the setting of partially hyperbolic systems with singularities. Indeed, we have the unstable disk  $\Delta_0$  belonging in  $\Gamma^u$  and the bounded distortion property (Y<sub>5</sub>) holding for  $\Delta_0$ . From the construction, we have seen that there exists a

sequence  $(S_n)_n$  of satellites in  $\Delta_0$  with  $\sum_{n \geq 1} m_0(S_n) < \infty$  such that  $H_n \cap \{R > N_0 + n\} \subset S_n$  for all  $n \geq 1$ . In order to apply Proposition B.3.1, we need to obtain a frequent sequence  $(H_n^*)_n$  of sets in  $\Delta_0$  that is  $F$ -concatenated in  $(H_n)_n$ . In order to do that, define for each  $n \geq 1$

$$H_n^* = \{x \in H : n \text{ is a } (\sigma, r)\text{-hyperbolic time for } x\}. \quad (\text{B.35})$$

It follows from Lemma 4.4.1 that for  $m_0$  almost every point  $x \in \Delta_0$  we have

$$\limsup_{n \rightarrow \infty} \frac{1}{n} \#\{1 \leq j \leq n : x \in H_j^*\} \geq \theta.$$

This shows that  $(H_n^*)_n$  is a frequent sequence of sets in  $\Delta_0$ . On the other hand, since we have  $\delta_s < \delta_1$ , and

$$x \in H_n \implies f^j(x) \in H_{n-j}, \text{ for all } 0 \leq j < n,$$

where  $H_n = \{x \in H : n \text{ is a } (\sigma^{3/4}, r)\text{-hyperbolic time for } x\}$ , it follows from Lemma 4.4.6 that

$$x \in H_n^*, y \in \gamma_{\delta_s}^s(f^j(x)) \implies y \in H_{n-j}, \text{ for all } 0 \leq j < n. \quad (\text{B.36})$$

Take as usual  $R_0 = 0$  and  $R_i = \sum_{k=0}^{i-1} R \circ F^k$  for  $i \geq 1$ . Given  $x \in H_n^*$ , let  $i \geq 0$  be such that  $R_i(x) \leq n < R_{i+1}(x)$ . We have  $F^i(x) = \Theta \circ f^{R_i(x)}(x)$ , where  $\Theta$  is the projection from  $\mathcal{C}(\Delta_0)$  to  $\Delta_0$  along stable disks. Hence,  $F^i(x) \in \gamma_{\delta_s}^s(f^{R_i(x)}(x))$ . It follows from (B.36) that  $F^i(x) \in H_{n-R_i}$ . Thus, the sequence  $(H_n^*)_n$  is  $F$ -concatenated in  $(H_n)_n$  and the integrability of the recurrence times follows from Proposition B.3.1.

# References

- [1] L. M. Abramov and V. A. Rokhlin. The entropy of a skew product of measure preserving transformations. *Amer. Math. Soc. Transl. Ser. 2* **48** (1966):255-265.
- [2] J. F. Alves. SRB measures for non-hyperbolic systems with multidimensional expansion. *Ann. Sci. École Norm. Sup., IV. Ser.* **33** (2000):1-32.
- [3] J. F. Alves. Nonuniformly hyperbolic attractors: Geometric and probabilistic aspects. *Springer*, book to appear.
- [4] J. F. Alves and V. Araújo. Hyperbolic times: frequency versus integrability. *Ergodic Theory and Dynamical Systems* **24**(2) (2004):329-346.
- [5] J. F. Alves, C. Bonatti and M. Viana. SRB measures for partially hyperbolic systems whose central direction is mostly expanding. *Invent. Math.* **140** (2000):351–398.
- [6] J. F. Alves, M. Carvalho and J. M. Freitas. Statistical stability and continuity of SRB entropy for systems with Gibbs-Markov structures. *Comm. Math. Phys.* **296** (2010):739–767.
- [7] J. F. Alves, M. Carvalho and J. M. Freitas. Statistical stability for Hénon maps of the Benedicks-Carleson type. *Ann. Inst. H. Poincaré Anal. Non Linéaire* **27**(2) (2010):595–637.
- [8] J. F. Alves, C. L. Dias, S. Luzzatto and V. Pinheiro. SRB measures for partially hyperbolic systems whose central direction is weakly expanding *J. Eur. Math. Soc.* **19** (2017):2911-2946.
- [9] J. F. Alves, S. Luzzatto and V. Pinheiro. Markov structures and decay of correlations for non-uniformly expanding dynamical systems. *Ann. Inst. H. Poincaré Anal. Non Linéaire* **22**(6) (2005):817-839.
- [10] J. F. Alves, K. Oliveira and A. Tahzibi. On the continuity of the SRB entropy for endomorphisms. *J. Stat. Phys.* **123**(4) (2006):763–785.
- [11] J. F. Alves and V. Pinheiro. Slow rates of mixing for dynamical systems with hyperbolic structures. *J. Stat. Phys.* **131** (2008):505-534.
- [12] J. F. Alves and V. Pinheiro. Topological structure of (partially) hyperbolic sets with positive volume. *Transactions of the American Mathematical Society* **360**(10) (2008):5551-5569.

- [13] J. F. Alves and V. Pinheiro. Gibbs-Markov structures and limit laws for partially hyperbolic attractors with mostly expanding central direction. *Adv Math.* **223** (2010):1706-1730.
- [14] J. F. Alves and A. Pumariño. Entropy formula and continuity of entropy for piecewise expanding maps. *arXiv preprint arXiv:1806.01095*, **2018**.
- [15] J. F. Alves, A. Pumariño, and E. Vigil. Statistical stability for multidimensional piecewise expanding maps. *Proc. Amer. Math. Soc.*, **145**(7) (2017):3057-3068.
- [16] J. F. Alves and M. Soufi. Statistical stability and limit laws for Rovella maps. *Nonlinearity* **25**(12) (2012):3527-3552.
- [17] J. F. Alves and M. Soufi. Statistical stability of geometric Lorenz attractors. *Fund. Math.* **224**(3) (2014):219-231.
- [18] V. Araújo, S. Luzzatto and M. Viana. Invariant measures for interval maps with critical points and singularities. *Advances in Mathematics* **221**(5) (2009):1428-1444.
- [19] V. Araújo and M. J. Pacifico. Three-dimensional flows. Vol. 53. Springer Science & Business Media, **2010**.
- [20] V. Araújo, M. J. Pacifico, E. R. Pujals and M. Viana. Singular-hyperbolic attractors are chaotic, *Trans. A.M.S.* **361**(5) (2009):2431-2485.
- [21] M. Benedicks and L. Carleson. On iterations of  $1 - ax^2$  on  $(-1, 1)$ . *Annals of Mathematics* **122** (1985):1-25.
- [22] M. Benedicks and L. Carleson. The dynamics of the Hénon map. *Annals of Mathematics* **133**(1) (1991):73-169.
- [23] M. Benedicks and L. S. Young. Sinai-Bowen-Ruelle measures for certain Hénon maps. *Inventiones Mathematicae* **112** (1993):541.
- [24] M. Benedicks and L. S. Young. Markov extensions and decay of correlations for certain Hénon maps. *Astérisque* **261** (2000):13-56.
- [25] A. B. Blaya and V. J. Lopez. On the relations between positive Lyapunov exponents, positive entropy, and sensitivity for interval maps. *Discrete Contin. Dyn. Syst* **32**(2) (2012):433-466.
- [26] T. Bogenschütz and H. Crauel. The Abramov-Rokhlin formula. *Ergodic Theory and Related Topics III. Lecture Notes in Mathematics, Springer, Berlin, Heidelberg* volume **1514** (1992):32-35.
- [27] C. Bonatti and M. Viana. SRB measures for partially hyperbolic systems whose central direction is mostly contracting. *Israel Journal of Mathematics* **115**(1) (2000):157-193.
- [28] R. Bowen. Markov partitions for Axiom A diffeomorphism. *Amer. J. Math.* **92** (1970):725-747.

- [29] R. Bowen. Entropy for group endomorphisms and homogeneous spaces. *Transactions of the American Mathematical Society* **153** (1971):401-412.
- [30] R. Bowen. Equilibrium states and the ergodic theory of Axiom A diffeomorphisms. *Lecture Notes in Mathematics* **480**, Springer, 1975.
- [31] R. Bowen and D. Ruelle. The ergodic theory of Axiom A flows. *Invent. Math.* **29** (1975):181-202.
- [32] J. Buzzzi. Markov extensions for multi-dimensional dynamical systems. *Israel Journal of Mathematics* **112**(1) (1999):357-380.
- [33] M. Carvalho. Sinai–Ruelle–Bowen measures for N-dimensional derived from Anosov diffeomorphisms. *Ergodic Theory and Dynamical Systems* **13**(1) (1993):21-44.
- [34] V. Climenhaga, S. Luzzatto and Y. Pesin. The geometric approach for constructing Sinai–Ruelle–Bowen measures. *Journal of Statistical Physics* **166**(3-4) (2017):467-493.
- [35] M. F. Demers, P. Wright and L.S. Young. Entropy, Lyapunov exponents and escape rates in open systems. *Ergodic Theory and Dynamical Systems* **32**(4) (2012):1270-1301.
- [36] M. Denker, G. Keller and M. Urbanski. On the uniqueness of equilibrium states for piecewise monotone mappings. *Studia Mathematica* **97**(1) (1990):27-36.
- [37] K. Díaz-Ordaz. Decay of correlations for non-Hölder observables for expanding Lorenz-like one-dimensional maps *Discrete & Continuous Dynamical Systems* **15** (2006):159-176.
- [38] K. Díaz-Ordaz, M.P. Holland and S. Luzzatto. Statistical properties of one-dimensional maps with critical points and singularities, *Stoch. Dyn.* **6**(4) (2006):423–458.
- [39] J. M. Freitas. Continuity of SRB measure and entropy for Benedicks-Carleson quadratic maps. *Nonlinearity* **18**(2) (2005):831.
- [40] S. Gouëzel. Decay of correlations for nonuniformly expanding systems. *Bull. Soc. Math. France* **134**(1) (2006):1-31
- [41] J. Guckenheimer and R. F. Williams. Structural stability of Lorenz attractors. *Publications Mathématiques de l’IHÉS* **50** (1979):59-72.
- [42] M. V. Jakobson. Absolutely continuous invariant measures for one-parameter families of one-dimensional maps. *Communications in Mathematical Physics* **81**(1) (1981):39-88.
- [43] A. Katok, J.-M. Strelcyn, F. Ledrappier, and F. Przytycki. *Invariant manifolds, entropy and billiards; smooth maps with singularities*, volume 1222 of *Lecture Notes in Mathematics*. Springer-Verlag, Berlin, 1986.
- [44] G. Keller. Lifting measures to Markov extensions. *Monatsh. Math.* **108**(2-3) (1989):183-200.

- [45] A.N. Kolmogorov. New Metric Invariant of Transitive Dynamical Systems and Endomorphisms of Lebesgue Spaces. *Doklady of Russian Academy of Sciences* **119** N5 (1958):861-864.
- [46] K. Krzyzewski and W. Szlenk. On invariant measures for expanding differentiable mappings. *Stud. Math.* **33** (1969):83–92
- [47] F. Ledrappier. Some properties of absolutely continuous invariant measures on an interval. *Ergodic Theory and Dynamical Systems* **1**(1) (1981):77-93.
- [48] F. Ledrappier and J.-M. Strelcyn. A proof of the estimation from below in Pesin’s entropy formula. *Ergodic Theory Dynam. Systems* **2**(2) (1982):203–219.
- [49] F. Ledrappier and P. Walters. A relativised variational principle for continuous transformations. *J. London Math. Soc.* **16**(2) (1977):568-576.
- [50] F. Ledrappier and L.-S. Young. The metric entropy of diffeomorphisms. I. Characterization of measures satisfying Pesin’s entropy formula. *Ann. of Math. (2)*, **122**(3) (1985):509–539.
- [51] P. D. Liu. Pesin’s entropy formula for endomorphisms. *Nagoya Math. J.* **150** (1998):197–209.
- [52] P. D. Liu. A note on the entropy of factors of random dynamical systems. *Ergodic Theory and Dynamical Systems* **25**(2) (2005):593-603.
- [53] P. D. Liu and M. Qian. Smooth ergodic theory of random dynamical systems (Lecture Notes in Mathematics 1606). *Springer*, **1995**.
- [54] E. N. Lorenz. Deterministic nonperiodic flow. *J. Atmosph. Sci.* **20** (1963):130-141
- [55] S. Luzzatto and M. Viana. Positive Lyapunov exponents for Lorenz-like families with criticalities. *Astérisque* **261** (2000):201-237.
- [56] R. Mañé. A proof of Pesin’s formula. *Ergodic Theory and Dynamical Systems* **1**(1) (1981):95-102.
- [57] R. J. Metzger. Sinai–Ruelle–Bowen measures for contracting Lorenz maps and flows. *Annales de l’Institut Henri Poincaré (C) Non Linear Analysis*. Vol. 17, No. 2, Elsevier Masson, **2000**.
- [58] K. Oliveira and M. Viana. Foundations of ergodic theory. *Cambridge Studies in Advanced Mathematics*, Vol. 151, Cambridge University Press, Cambridge, **2016**.
- [59] V. Oseledec. A multiplicative ergodic theorem. Liapunov characteristic number for dynamical systems. *Trans. Moscow Math. Soc.* **19** (1968): 197-231.
- [60] J. Palis. A global perspective for non-conservative dynamics. *Annales de l’IHP Analyse Non linéaire* **22**(4) (2005):485-507.
- [61] W. Parry. Entropy and generators in ergodic theory. *WA Benjamin*, **1969**.



- [62] Y. B. Pesin. Characteristic Lyapunov exponents and smooth ergodic theory. *Russian Mathematical Surveys* **32**(4) (1977):55-114.
- [63] Y. B. Pesin and Y. Sinai. Gibbs measures for partially hyperbolic attractors. *Ergodic theory Dynamical Systems* **2** (1982):417-438.
- [64] V. Pinheiro. Sinai–Ruelle–Bowen measures for weakly expanding maps. *Nonlinearity* **19**(5) (2006):1185.
- [65] M. Qian, J.-S. Xie and S. Zhu. Smooth ergodic theory for endomorphisms. *Springer*, **2009**.
- [66] M. Qian and S. Zhu. SRB measures and Pesin’s entropy formula for endomorphisms. *Transactions of the American Mathematical Society* **354**(4) (2002):1453-1471.
- [67] V. A. Rokhlin. Lectures on the theory of entropy of transformations with invariant measures. *Russian Math. Surveys* **22**(5) (1967):1-54.
- [68] A. Rovella. The dynamics of perturbations of the contracting Lorenz attractor. *Boletim da Sociedade Brasileira de Matemática-Bulletin/Brazilian Mathematical Society* **24**(2) (1993):233-259.
- [69] D. J. Rudolph. Fundamentals of dynamics: Ergodic theory on Lebesgue spaces. *Oxford University Press*, USA, **1990**.
- [70] D. Ruelle. A measure associated with axiom-A attractors. *American Journal of Mathematics* (1976):619-654.
- [71] D. Ruelle. An inequality for the entropy of differentiable maps. *Boletim da Sociedade Brasileira de Matematica-Bulletin/Brazilian Mathematical Society* **9**(1) (1978):83-87.
- [72] D. G. Santos. Statistical stability for Luzzatto-Viana maps. *PhD Thesis*, **2018**.
- [73] Y. G. Sinai. Markov partitions and C-diffeomorphisms. *Functional Analysis and Its Applications* **2**(1) (1968):61-82.
- [74] Y. G. Sinai. Gibbs measures in ergodic theory. *Russian Mathematical Surveys* **27**(4) (1972):21.
- [75] M. Viana. Multidimensional nonhyperbolic attractors. *Publications Mathématiques de l’Institut des Hautes Études Scientifiques* **85**(1) (1997):63-96.
- [76] L.S. Young. Statistical properties of dynamical systems with some hyperbolicity. *Annals of Mathematics* **147** (1998):585-650.
- [77] L. S. Young. Recurrence times and rates of mixing. *Israel J. Math.* **110** (1999):153-188.
- [78] L. S. Young. What are SRB measures and which dynamical systems have them? *Journal of Statistical Physics* **108**(5-6) (2002):733-754.

- [79] L. S. Young. Entropy in dynamical systems. *Entropy* **313** (2003).
- [80] R. Zweimüller. Invariant measures for general(ized) induced transformations. *Proceedings of the American Mathematical Society* **133**(8) (2005):2283-2295.