

Tensor product categorifications, Verma modules and the blob 2-category

Abel Lacabanne,¹ Grégoire Naisse,² and Pedro Vaz³

Abstract. We construct a dg-enhancement of KLRW algebras that categorifies the tensor product of a universal \mathfrak{sl}_2 Verma module and several integrable irreducible modules. When the integrable modules are two-dimensional, we construct a categorical action of the blob algebra on derived categories of these dg-algebras which intertwines the categorical action of \mathfrak{sl}_2 . From the above we derive a categorification of the blob algebra.

Mathematics Subject Classification (2020). Primary: 18N25; Secondary: 20G42.

Keywords. Higher representation theory, 2-Verma, blob algebra, dg-enhanced KLRW algebras.

Contents

1	Introduction	706
2	Quantum \mathfrak{sl}_2 and the blob algebra	716
3	Dg-enhanced KLRW algebras	724
4	A categorification of $M(\lambda) \otimes V(\underline{N})$	736
5	Cups, caps and double braiding functors	742
6	A categorification of the blob algebra	751
7	Variants and generalizations	764
	Appendices	776
A	Detailed proofs and computations	776
B	Homological toolbox	800
	References	809

¹ Fonds de la Recherche Scientifique - FNRS Grant no. MIS-F.4536.19.

² Fonds de la Recherche Scientifique - FNRS, under Grant no. 1.A310.16. Grégoire Naisse is also grateful to the Max Planck Institute for Mathematics in Bonn for its hospitality and financial support.

³ Fonds de la Recherche Scientifique - FNRS Grant no. MIS-F.4536.19.

1. Introduction

Dualities are fundamental tools in mathematics in general and in higher representation theory in particular. For example, Stroppel’s version of Khovanov homology [41, 42] and Khovanov’s HOMFLY–PT homology [19] can be seen as instances of higher Schur–Weyl duality (see also [43] for further explanations). In this paper we construct an instance of higher Schur–Weyl duality between $U_q(\mathfrak{sl}_2)$ and the blob algebra of Martin and Saleur [30] by using a categorification of the tensor product of a Verma module and several two-dimensional irreducibles.

1.1. State of the art

1.1.1. Schur–Weyl duality, $U_q(\mathfrak{sl}_2)$ and the Temperley–Lieb algebra. Schur–Weyl duality connects finite-dimensional modules of the general linear and symmetric groups. In particular, it states that over an algebraically closed field the actions of GL_m and \mathfrak{S}_r on the r -folded tensor power of the natural module V of GL_m commute and are the centralizers of each other. In the quantum version, GL_m and \mathfrak{S}_r are replaced respectively by the quantum general linear algebra $U_q(\mathfrak{gl}_m)$ and the Hecke algebra $\mathcal{H}_r(q)$. We note that these consequences of (quantum) Schur–Weyl duality remain true if one replaces the general linear with the special linear group. For example, in the case of $m = 2$, the centralizer of the action of $U_q(\mathfrak{sl}_2)$ on $V^{\otimes r}$ is the Temperley–Lieb algebra TL_r , a well-known quotient of the Hecke algebra. One of the applications of this connection is the construction of the Jones–Witten–Reshetikhin–Turaev $U_q(\mathfrak{sl}_2)$ -tangle invariant as a state-sum model (a linear combination of elements of TL_r) called *Kauffman bracket*, which was the version categorified by Khovanov [18] in the particular case of links.

1.1.2. The blob algebra. It was shown in [14] that, for a projective $U_q(\mathfrak{sl}_2)$ Verma module M with highest weight λ (in the sense that λ is the eigenvalue), the endomorphism algebra of $M \otimes V^{\otimes r}$ is the blob algebra $\mathcal{B}_r = \mathcal{B}_r(q, \lambda)$ of Martin and Saleur [30]. This algebra \mathcal{B}_r , which was unfortunately called *Temperley–Lieb algebra of type B* in [14], is in fact a quotient of the Temperley–Lieb algebra of type B [10, 11]. Note that the parameters λ and q in [14] are not algebraically independent but can be easily made independent by working with a universal Verma module as in [26].

The blob algebra \mathcal{B}_r can be given a diagrammatic presentation in terms of $\mathbb{Q}(q, \lambda)$ -linear combinations of flat tangle diagrams [14] on $r + 1$ strands, with

generators

$$u_i := \underbrace{\left| \begin{array}{c} | \\ | \\ \dots \\ | \end{array} \right.}_{i} \begin{array}{c} \cup \\ \cup \end{array} \left| \begin{array}{c} | \\ | \\ \dots \\ | \end{array} \right.$$

for $i = 1, \dots, r - 1$, and

$$\xi := \left| \begin{array}{c} \curvearrowright \\ \curvearrowright \end{array} \right. \left| \begin{array}{c} | \\ | \\ \dots \\ | \end{array} \right.$$

taken up to planar isotopy fixing the endpoints, and subject to the usual Temperley–Lieb relation of type A:

$$\bigcirc = -(q + q^{-1}),$$

and the blob relations:

$$\begin{aligned} \left| \begin{array}{c} \curvearrowright \\ \curvearrowright \end{array} \right. &= -(\lambda q + \lambda^{-1} q^{-1}) \left| \begin{array}{c} | \\ | \end{array} \right. \\ q^{-1} \left| \begin{array}{c} \curvearrowright \\ \curvearrowright \end{array} \right. &= (\lambda q + \lambda^{-1} q^{-1}) \left| \begin{array}{c} \curvearrowright \\ \curvearrowright \end{array} \right. - q \left| \begin{array}{c} | \\ | \end{array} \right. \end{aligned}$$

Note that this generators-relations definition of the blob algebra makes also sense over $\mathbb{Z}[q^{\pm 1}, \lambda^{\pm 1}]$.

Remark 1.1. In [30], the blob algebra is given a different presentation, where the generator of type B is pictured as a dot on the left-most strand, and is an idempotent. We use the presentation given in [14], which is isomorphic to the one in [30] over $\mathbb{Z}(q, \lambda)$ (but not over $\mathbb{Z}[q^{\pm 1}, \lambda^{\pm 1}]$). This presentation is closer to the representation theory of $U_q(\mathfrak{sl}_2)$ and is the one that arises from our categorification construction.

More generally, we consider the category \mathcal{B} with objects given by $M \otimes V^{\otimes r}$ for various $r \in \mathbb{N}$, and hom-spaces given by $U_q(\mathfrak{sl}_2)$ -intertwiners. This category, that we call the *blob category*, has a very similar diagrammatic description as the

blob algebra, where objects are collections of $r + 1$ points on the horizontal line. The hom-spaces are presented by flat tangles connecting these points, with the left-most point of the source always connected to the left-most point of the target, allowing 4-valent intersections between the first two strands. These diagrams are subject to the same relations as the blob algebra. We stress that, in contrast to the Temperley–Lieb category of type A, the blob category is not monoidal with respect to juxtaposition of diagrams since the blue strand in the pictures above needs to be on the left-hand side of any diagram.

1.1.3. Webster categorification. In a seminal paper [49], Webster has constructed categorifications of tensor products of integrable modules for symmetrizable Kac–Moody algebras, generalizing Lauda’s [27], Khovanov and Lauda [21, 22], and Chuang and Rouquier [6], and Rouquier’s [40] categorification of quantum groups, and their integrable modules. Webster further used his categorifications to give a link homology theory categorifying the Witten–Reshetikhin–Turaev invariant of tangles. The construction in [49] involves algebras, called *KLRW algebras* (or tensor product algebras), that are finite-dimensional algebras presented diagrammatically, generalizing cyclotomic KLR algebras. Categories of finitely generated modules over KLRW algebras come equipped with an action of Khovanov–Lauda–Rouquier’s 2-Kac–Moody category, and their Grothendieck groups are isomorphic to tensor products of integrable modules. Link invariants and categorifications of intertwiners are constructed using functors given by the derived tensor product with certain bimodules over KLRW algebras.

1.1.4. Verma categorification: dg-enhancements. In [36, 37, 34], the second and third authors have given a categorification of (universal, parabolic) Verma modules for (quantized) symmetrizable Kac–Moody algebras. In its more general form [34], the categorification is given as a derived category of dg-modules over a certain dg-algebra, similar to a KLR algebra but containing an extra generator in homological degree 1. This dg-algebra can also be endowed with a collection of different differentials, each of them turning it into a dg-algebra whose homology is isomorphic to a cyclotomic KLR algebra. This can be interpreted as a categorification of the projection of a universal Verma module onto an integrable module. Categorification of Verma modules was used by the second and third authors in [35] to give a quantum group higher representation theory construction of Khovanov–Rozansky’s HOMFLY–PT link homology.

1.2. The work in this paper. For λ a formal parameter, let $M(\lambda)$ be the universal $U_q(\mathfrak{sl}_2)$ -Verma module with highest weight λ , and $V(\underline{N}) := V(N_1) \otimes \cdots \otimes V(N_r)$,

where $V(N_j)$ is the irreducible of highest weight q^{N_j} , $N_j \in \mathbb{N}$. In this paper we combine Webster’s categorification with the Verma categorification to give a categorification of $M(\lambda) \otimes V(\underline{N})$. Then we construct a categorification of the blob algebra by categorifying the intertwiners of $M(\lambda) \otimes V(\underline{N})$ where all the N_j are 1.

1.2.1. Dg-enhanced KLRW algebras and categorification of tensor products

(§§ 3 and 4). Fix a commutative unital ring \mathbb{k} . The KLRW algebra is the \mathbb{k} -algebra spanned by planar isotopy classes of braid-like diagrams whose strands are of two types: there are black strands labeled by simple roots of a symmetrizable Kac–Moody algebra \mathfrak{g} and carrying dots, and there are red strands labeled by dominant integral weights. KLRW algebras are cyclotomic algebras in the sense that they generalize cyclotomic KLR algebras to a string of dominant integral weights, where the “violating condition” [49, Definition 4.3] plays the role of the cyclotomic condition. KLRW algebras were also defined without the violating condition, in which case we call them non-cyclotomic or affine KLRW algebras. In the case of \mathfrak{sl}_2 , for $b \in \mathbb{N}$ and $\underline{N} \in \mathbb{N}^r$, we denote by $T_b^{\underline{N}}$ (resp. $\tilde{T}_b^{\underline{N}}$) the (resp. affine) KLRW algebra spanned by b black strands (all labeled by the simple root of \mathfrak{sl}_2) and r red strands, labeled in order N_1, \dots, N_r from left to right.

Following a procedure analogous to [37, 34], we construct in §3 an algebra $T_b^{\lambda, \underline{N}}$, with λ a formal parameter, that contains the affine KLRW algebra $\tilde{T}_b^{\underline{N}}$ as a subalgebra. In a nutshell, $T_b^{\lambda, \underline{N}}$ is defined by putting a vertical blue strand labeled by λ on the left of the diagrams of $\tilde{T}_b^{\underline{N}}$, and adding a new generator that we call a nail (this corresponds with the “tight floating dots” of [37, 34]). We draw this new generator as

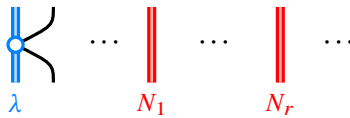

Note that a nail can only be placed on the left-most strand, which is always blue. The nails are subject to the following local relations:

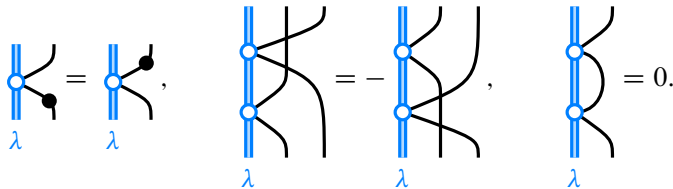

When $\underline{N} = \emptyset$ is the empty sequence, we recover the dg-enhanced nilHecke algebra from [37]. The subalgebra spanned by all diagrams without a nail is isomorphic to the affine KLRW algebra $\tilde{T}_b^{\underline{N}}$.

As we will see, the algebra $T_b^{\lambda, N}$ can be equipped with three \mathbb{Z} -gradings: two internal gradings, one as in Webster’s original definition and an additional grading (see Definition 3.2), as well as a homological grading. The first two of these gradings categorify the parameters q and λ respectively, and we call them q - and λ -gradings. As usual, the homological grading allows us to categorify relations involving minus signs. We write q^k (resp. λ^k) for a grading shift up by k in the q - (resp. λ -)grading, and $[k]$ for a grading shift up by k in the homological grading, for $k \in \mathbb{Z}$.

We let the nail be in homological degree 1, while diagrams without a nail are in homological degree 0. As in the categorification of Verma modules, if we endow the algebra $T_b^{\lambda, N}$ with a trivial differential, then it becomes a dg-algebra categorifying $M(\lambda) \otimes V(\underline{N})$ (see below). We can also equip $T_b^{\lambda, N}$ with a differential d_N , for $N \geq 0$, which acts trivially on diagrams without a nail, while

$$d_N \left(\begin{array}{c} \text{Diagram with a blue circle and a black strand} \\ \lambda \end{array} \right) := \begin{array}{c} \text{Diagram with a blue circle and a black strand} \\ \lambda \end{array} \bullet^N$$

and extending using the graded Leibniz rule. The dg-algebra $(T_b^{\lambda, N}, d_N)$ is formal with homology isomorphic to the KLRW algebra $T_b^{(N, N)}$ (see Theorem 3.13).

The usual framework using the algebra map $T_b^{\lambda, N} \rightarrow T_{b+1}^{\lambda, N}$ that adds a black strand at the right of a diagram gives rise to induction and restriction dg-functors E_b and F_b between the derived dg-categories $\mathcal{D}_{\text{dg}}(T_b^{\lambda, N}, 0)$ and $\mathcal{D}_{\text{dg}}(T_{b+1}^{\lambda, N}, 0)$. The following describes the categorical $U_q(\mathfrak{sl}_2)$ -action:

Theorem 4.1. There is a quasi-isomorphism

$$\text{Cone}(F_{b-1}E_{b-1} \longrightarrow E_bF_b) \xrightarrow{\cong} \bigoplus_{[\beta + |\underline{N}| - 2b]_q} \text{Id}_b,$$

of dg-functors.

As usual in the context of categorification, the notation $\bigoplus_{[\beta + |\underline{N}| - 2b]_q}$ on the right-hand side is an infinite coproduct categorifying multiplication by the rational fraction $(\lambda q^{|\underline{N}| - 2b} - \lambda^{-1} q^{-|\underline{N}| + 2b}) / (q - q^{-1})$ interpreted as a Laurent series.

Turning on the differential d_N gives endofunctors E_b^N, F_b^N on the derived category $\mathcal{D}_{\text{dg}}(\bigoplus_{b \geq 0} T_b^{\lambda, N}, d_N)$. In this case, the right-hand side in Theorem 4.1 becomes quasi-isomorphic to a finite sum and we recover the usual action on categories of modules over KLRW algebras (see Proposition 4.3).

In [33], the second author introduced the notion of an asymptotic Grothendieck group, which is a notion of a Grothendieck group for (multi)graded categories of objects admitting infinite iterated extensions (like infinite composition series or infinite resolutions) whose gradings satisfy some mild conditions. Denote by ${}_{\mathbb{Q}}\mathbf{K}_0^\Delta(-)$ the asymptotic Grothendieck group (tensoring over $\mathbb{Z}((q, \lambda))$ with $\mathbb{Q}((q, \lambda))$). The categorical $U_q(\mathfrak{sl}_2)$ -actions on the derived categories $\mathcal{D}_{\text{dg}}(\bigoplus_{b \geq 0} T_b^{\lambda, N}, 0)$ and $\mathcal{D}_{\text{dg}}(\bigoplus_{b \geq 0} T_b^{\lambda, N}, d_N)$ descend to the asymptotic Grothendieck group and we have the main result of §4, which reads as following:

Theorem 4.7. There are isomorphisms of $U_q(\mathfrak{sl}_2)$ -modules

$${}_{\mathbb{Q}}\mathbf{K}_0^\Delta(T^{\lambda, N}, 0) \cong M(\lambda) \otimes V(\underline{N}),$$

and

$${}_{\mathbb{Q}}\mathbf{K}_0^\Delta(T^{\lambda, N}, d_N) \cong V(N) \otimes V(\underline{N}),$$

for all $N \in \mathbb{N}$.

In §7.1 we prove that in the case of $b = 1, \underline{N} = 1, \dots, 1$ and $N = 1$, the dg-algebra $(T_1^{\lambda, 1, \dots, 1}, d_1)$ is isomorphic to a dg-enhanced zigzag algebra, generalizing [45, §4].

1.2.2. The blob 2-category (§§ 5 and 6). We study the case of $\underline{N} = 1, \dots, 1$ in more detail. We define several functors on $\mathcal{D}_{\text{dg}}(T^{\lambda, N}, 0)$ commuting with the categorical action of $U_q(\mathfrak{sl}_2)$. As in [49], these are defined as a first step via (dg-)bimodules over the above mentioned dg-enhancements of KLRW-like algebras. To simplify matters, let $T^{\lambda, r}$ be the dg-enhanced KLRW algebra with r strands labeled 1 and a blue strand labeled λ . The categorical Temperley–Lieb action is realized by a pair of biadjoint functors, constructed in the same way as in [49]. They are given by derived tensoring with the $(T^{\lambda, r}, T^{\lambda, r \pm 2})$ -bimodules B_i and \bar{B}_i generated respectively by the diagram



and its mirror along a horizontal axis. We stress again that the blue strand is on the left. Moreover, these diagrams are subjected to some local relations (see §5.1).

Taking the derived tensor product with these bimodules defines the coevaluation and evaluation dg-functors as

$$B_i := B_i \otimes_T^L -: \mathcal{D}_{\text{dg}}(T^{\lambda,r}, 0) \longrightarrow \mathcal{D}_{\text{dg}}(T^{\lambda,r+2}, 0),$$

$$\bar{B}_i := \bar{B}_i \otimes_T^L -: \mathcal{D}_{\text{dg}}(T^{\lambda,r+2}, 0) \longrightarrow \mathcal{D}_{\text{dg}}(T^{\lambda,r}, 0).$$

In §6.1 we extend [49] and prove that these functors satisfy the relations of the Temperley–Lieb algebra:

Corollaries 6.3 and 6.5. There are natural isomorphisms

$$\bar{B}_{i\pm 1} \circ B_i \cong \text{Id}, \quad \bar{B}_i \circ B_i \cong q \text{Id}[1] \oplus q^{-1} \text{Id}[-1].$$

We define the double braiding functor in the same vein, using the $(T^{\lambda,r}, T^{\lambda,r})$ -bimodule X generated by the diagram



modulo the defining relations of $T^{\lambda,r}$, and the extra local relations

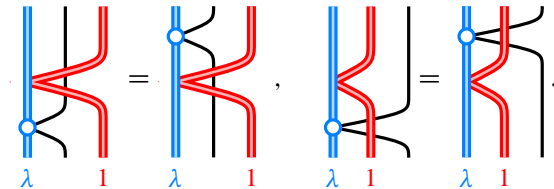

The *double braiding functor* is then defined as the derived tensor product

$$\Xi := X \otimes_T^L -: \mathcal{D}_{\text{dg}}(T^{\lambda,r}, 0) \longrightarrow \mathcal{D}_{\text{dg}}(T^{\lambda,r}, 0).$$

The functors B_i , \bar{B}_i and Ξ intertwine the categorical $U_q(\mathfrak{sl}_2)$ -action on $\mathcal{D}_{\text{dg}}(T^{\lambda,r}, 0)$:

Proposition 6.1. We have natural isomorphisms $E \circ \Xi \cong \Xi \circ E$ and $F \circ \Xi \cong \Xi \circ F$, and also $E \circ B_i \cong B_i \circ E$, $F \circ B_i \cong B_i \circ F$, and similarly for \bar{B}_i .

The first main result of §6 is that the blob algebra acts on $\mathcal{D}_{\text{dg}}(T^{\lambda,r}, 0)$. This follows from the Temperley–Lieb action in §6.1 and Corollary 6.11, Proposition 6.14, and Corollary 6.17, summarized below.

Corollary 6.11, Proposition 6.14, and Corollary 6.17. The functor

$$\Xi: \mathcal{D}_{\text{dg}}(T^{\lambda,r}, 0) \longrightarrow \mathcal{D}_{\text{dg}}(T^{\lambda,r}, 0)$$

is an autoequivalence, with inverse given by

$$\Xi^{-1} := \text{RHOM}_T(X, -): \mathcal{D}_{\text{dg}}(T^{\lambda,r}, 0) \longrightarrow \mathcal{D}_{\text{dg}}(T^{\lambda,r}, 0).$$

There are quasi-isomorphisms

$$\text{Cone}(\lambda q^2 \Xi[1] \longrightarrow q^2 \text{Id}[1])[1] \xrightarrow{\cong} \text{Cone}(\Xi \circ \Xi \longrightarrow \lambda^{-1} \Xi),$$

and

$$\lambda q(\text{Id}[1] \oplus \lambda^{-1} q^{-1}(\text{Id})[-1]) \xrightarrow{\cong} \bar{\mathbf{B}}_1 \circ \Xi \circ \mathbf{B}_1,$$

of dg-functors

One of the main difficulties in establishing the results above is that, in order to compute derived tensor products, we have to take left (resp. right) cofibrant replacements of several dg-bimodules. As observed in [29, §2.3], while the left (resp. right) module structure remains unchanged when passing to the left (resp. right) cofibrant replacement, the right (resp. left) module structure is preserved only in the A_∞ sense. As a consequence, constructing natural transformations between compositions of derived tensor product functors often requires to use A_∞ -bimodules maps. We have tried to avoid as much as possible to end up in this situation, replacing the potentially unwieldy A_∞ -bimodules by quasi-isomorphic dg-bimodules.

Let \mathfrak{B}_r be a certain subcategory (see §6.3) of the derived dg-category of $(T^{\lambda,r}, 0)$ - $(T^{\lambda,r}, 0)$ -bimodules generated by the dg-bimodules corresponding with the dg-functors identity, $\Xi^{\pm 1}$ and $\mathbf{B}_i \circ \bar{\mathbf{B}}_i$. Given two dg-bimodules in \mathfrak{B}_r , we can compose them in the derived sense by replacing both of them with a bimodule cofibrant replacement (i.e. a cofibrant replacement as dg-bimodule, and not only left or right dg-module), and taking the usual tensor product. This gives a dg-bimodule, isomorphic to the derived tensor product of the two initial dg-bimodules. In particular, it equips ${}_{\mathbb{Q}}\mathbf{K}_0^\Delta(\mathfrak{B}_r)$ with a ring structure. We show that \mathfrak{B}_r is a categorification of the blob algebra \mathcal{B}_r with ground ring extended to $\mathbb{Q}((q, \lambda))$:

Corollary 6.19. *There is an isomorphism of $\mathbb{Q}((q, \lambda))$ -algebras*

$${}_{\mathbb{Q}}\mathbf{K}_0^\Delta(\mathfrak{B}_r) \cong \mathcal{B}_r(q, \lambda).$$

This result generalizes to the blob category. However, a technical issue we find here is that dg-categories up to quasi-equivalence do not form a 2-nbdash category, but rather an $(\infty, 2)$ -category [9]. Concretely in our case, we consider a sub- $(\infty, 2)$ -category of this $(\infty, 2)$ -category, where the objects are the derived dg-categories $\mathcal{D}_{\text{dg}}(T^{\lambda, r}, 0)$ for various $r \in \mathbb{N}$, and the 1-hom are generated by the dg-functors identity, $\Xi^{\pm 1}$, \bar{B}_i and B_i . Moreover, these 1-hom are stable $(\infty, 1)$ -categories, and thus their homotopy categories are triangulated (see [28]). In particular, we write ${}_{\mathbb{Q}}\mathbf{K}_0^{\Delta}(\mathfrak{B})$ for the category with the same objects as \mathfrak{B} and with hom-spaces given by the asymptotic Grothendieck groups of the homotopy category of the 1-hom of \mathfrak{B} . By [9] and [46], we can compute these hom-spaces by considering usual derived categories of dg-bimodules, and we obtain the following, again after extending the ground rings to $\mathbb{Q}((q, \lambda))$:

Corollary 6.21. *There is an equivalence of categories*

$${}_{\mathbb{Q}}\mathbf{K}_0^{\Delta}(\mathfrak{B}) \cong \mathfrak{B}.$$

1.2.3. The general case: symmetrizable \mathfrak{g} . The definition of dg-enhanced KLRW algebras in §3 generalizes immediately to any symmetrizable \mathfrak{g} . We indicate this generalization in §7.2. We expect that the results of §3 and §4 extend to this case without difficulty.

1.2.4. Quiver Schur algebras. Quiver Schur algebras were introduced geometrically by Stroppel and Webster in [44] to give a graded version of the cyclotomic q -Schur algebras of Dipper, James and Mathas [7]. Independently, Hu and Mathas [13] constructed a graded Morita equivalent variant of the quiver Schur algebras in [44] as graded quasi-hereditary covers of cyclotomic KLR algebras for linear quivers. While the construction in [44] is geometric, the construction in [13] is combinatorial/algebraic.

More recently, Khovanov, Qi and Sussan [23] gave a variant of the quiver Schur algebras in [13] for the case of cyclotomic nilHecke algebras, and showed that Grothendieck groups of their algebras can be identified with tensor products of integrable modules of $U_q(\mathfrak{sl}_2)$. Following similar ideas, in §7.3 we construct a dg-algebra, which we conjecture to be the quiver Schur variant of the dg-enhanced KLRW algebra of §3 (Conjectures 7.15 and 7.17).

1.2.5. Appendix. We have moved the most computational proofs to §A, leaving only a sketch of some of the proofs in the main text. The reader can also find in §B some explanations and results about homological algebra, A_{∞} -structures and asymptotic Grothendieck groups.

1.3. Possible future directions and applications

1.3.1. Khovanov homology for tangles of type B. The topological interpretation of the blob algebra in [14, §3.4] gives rise to a Jones polynomial for tangles of type B (i.e. tangles in the annulus). We expect that by introducing braiding functors as in [49], we obtain a link homology of type B, yielding invariants of links in the annulus akin to ones introduced by Asaeda, Przytycki, and Sikora [3] (see also [4, 12, 38]).

Given a link in the annulus, the invariant obtained from our construction would be a dg-endofunctor of the derived dg-category of dg-modules over the dg-enhanced KLRW algebra $(T^{\lambda, \emptyset}, 0)$. This means that the empty link is sent to the dg-endomorphism space of the identity functor, which coincides with the Hochschild cohomology of $T^{\lambda, \emptyset}$, and is infinite-dimensional (the center of $T^{\lambda, \emptyset}$ is already infinite-dimensional). By restricting to the subcategory of dg-modules over $(T_0^{\lambda, \emptyset}, 0)$, it becomes 1-dimensional since $T_0^{\lambda, \emptyset} \cong \mathbb{k}$. With this restriction, we conjecture that our “would-be” invariant coincides with the usual annular Khovanov homology.

The following is a work in progress with A. Wilbert. As it is the case of using Webster’s machinery [49], computing the tangle invariant of type B using our framework could be unwieldy. A more computation-friendly alternative could be to use dg-bimodules over annular arc algebras constructed using the annular TQFT of [3], as done in [1, §5.3] (see also [8, §5]). Furthermore, evidences show there is a (at least weak) categorical action of the blob algebra on the derived category of dg-modules over these annular arc algebras.

In a different direction, one could try to extend our results to construct a Khovanov invariant for links in handlebodies, in the spirit of the handlebody HOMFLY–PT-link homology of Rose and Tubbenhauer in [39].

1.3.2. Constructions using homotopy categories. KLRW algebras are given diagrammatically, which is often an appropriate framework for constructions with an additive flavor. Nevertheless, the various functors realizing the various intertwiners and the braiding need to pass to derived categories of modules. This makes it harder to describe explicitly the 2-categories realizing these symmetries since a bimodule for two of those algebras induces an A_∞ -bimodule on the level of derived categories. This was pointed out by Mackaay and Webster in [29], who gave explicit constructions of categorified intertwiners in order to prove the equivalence between the several existing \mathfrak{gl}_n -link homologies. One of the things [29] tells us is how to construct homotopy versions of Webster’s categorifications.

A construction using homotopy categories for the results in this paper seems desirable from our point of view. We hope it can be done either by mimicking [29], which can turn out to be a technically challenging problem, or alternatively, by a construction of dg-enhancements for redotted Webster algebras, as considered in [25] and [20] to give a homotopical version of some of the above, but whose low-tech presentation might hide difficulties.

1.3.3. Generalized blob algebras and variants. The results of [14] were extended in [26], where the first and third authors have computed the endomorphism algebra of the $U_q(\mathfrak{gl}_m)$ -module $M^{\mathfrak{p}}(\Lambda) \otimes V^{\otimes n}$ for $M^{\mathfrak{p}}(\Lambda)$ a parabolic universal Verma modules and V the natural module of $U_q(\mathfrak{gl}_m)$, which is always a quotient of an Ariki–Koike algebra. As particular cases (depending on \mathfrak{p} and the relation between n and m) we obtain Hecke algebras of type B with two parameters, the generalized blob algebra of Martin and Woodcock [31] or the Ariki–Koike algebra itself. With this result in mind it is tantalizing to ask for an extension to \mathfrak{gl}_m of the work in this paper. Modulo technical difficulties the methods in this paper could work for \mathfrak{gl}_m in the case of a parabolic Verma module for a 2-block parabolic subalgebra, which is the case where the generators of the endomorphism algebra satisfy a quadratic relation. Constructing a categorification of the Ariki–Koike algebra or the generalized blob algebra as the blob 2-category in §6 looks quite challenging at the moment, in particular for a functor-realization of the cyclotomic relation and the relation $\tau = 0$ (for the generalized blob algebra in the presentation given in [26, Theorem 2.24]).

Acknowledgements. The authors thank Catharina Stroppel for interesting discussions, and for pointing us [30], helping to clarify the confusion with the terminology of “blob algebra” and “Temperley–Lieb algebra of type B.” The authors would also like to thank the referee for his/her numerous, detailed and helpful comments.

2. Quantum \mathfrak{sl}_2 and the blob algebra

2.1. Quantum \mathfrak{sl}_2 . Recall that *quantum \mathfrak{sl}_2* can be defined as the $\mathbb{Q}(q)$ -algebra $U_q(\mathfrak{sl}_2)$, with generic q , generated by K, K^{-1}, E and F with relations

$$\begin{aligned} KE &= q^2 EK, & KK^{-1} &= 1 = K^{-1}K, \\ KF &= q^{-2}FK, & EF - FE &= \frac{K - K^{-1}}{q - q^{-1}}. \end{aligned}$$

Quantum \mathfrak{sl}_2 becomes a bialgebra when endowed with comultiplication

$$\begin{aligned} \Delta(E) &:= E \otimes 1 + K^{-1} \otimes E, & \Delta(F) &:= F \otimes K + 1 \otimes F, \\ \Delta(K^{\pm 1}) &:= K^{\pm 1} \otimes K^{\pm 1}, \end{aligned}$$

and with counit $\varepsilon(K^{\pm 1}) := 1$, $\varepsilon(E) := \varepsilon(F) := 0$.

There is a $\mathbb{Q}(q)$ -linear anti-involution $\bar{\tau}$ of $U_q(\mathfrak{sl}_2)$ defined on the generators by

$$\bar{\tau}(E) := q^{-1} K^{-1} F, \quad \bar{\tau}(F) := q^{-1} E K, \quad \bar{\tau}(K) := K. \tag{1}$$

It is easily checked that

$$\Delta \circ \bar{\tau} = (\bar{\tau} \otimes \bar{\tau}) \circ \Delta. \tag{2}$$

2.1.1. Integrable modules. For each $N \in \mathbb{N}$, there is a finite-dimensional irreducible $U_q(\mathfrak{sl}_2)$ -module $V(N)$, called *integrable module*, with basis elements $\{v_{N,0}, v_{N,1}, \dots, v_{N,N}\}$ and action

$$\begin{aligned} K \cdot v_{N,i} &:= q^{N-2i} v_{N,i}, \\ F \cdot v_{N,i} &:= v_{N,i+1}, \\ E \cdot v_{N,i} &:= [i]_q [N - i + 1]_q v_{N,i-1}, \end{aligned}$$

where $[n]_q$ is the n -th *quantum integer*

$$[n]_q := \frac{q^n - q^{-n}}{q - q^{-1}} = q^{n-1} + q^{n-1-2} + \dots + q^{1-n}.$$

In particular, let $V := V(1)$ be the *fundamental* $U_q(\mathfrak{sl}_2)$ -module.

The module $V(N)$ can be equipped with the *Shapovalov form*

$$(-, -)_N: V(N) \times V(N) \longrightarrow \mathbb{Q}(q),$$

which is a non-degenerate bilinear form such that $(v_{N,0}, v_{N,0})_N = 1$ and which is $\bar{\tau}$ -Hermitian: for any $v, v' \in V(N)$ and $u \in U_q(\mathfrak{sl}_2)$, we have $(u \cdot v, v')_N = (v, \bar{\tau}(u) \cdot v')_N$. A computation shows that

$$(v_{N,i}, v_{N,j})_N = \delta_{i,j} q^{i(N-i)} \frac{[i]_q! [N]_q!}{[N-i]_q!},$$

where $[0]_q! := 1$ and $[n]_q! := [n]_q [n-1]_q \dots [2]_q [1]_q$.

2.1.2. Verma modules. Let β be a formal parameter and write $\lambda := q^\beta$ as a formal variable. Let \mathfrak{b} be the standard upper Borel subalgebra of \mathfrak{sl}_2 and $U_q(\mathfrak{b})$ be its quantum version. It is the $U_q(\mathfrak{sl}_2)$ -subalgebra generated by K, K^{-1} and E . Let K_λ be a 1-dimensional $\mathbb{Q}(\lambda, q)$ -vector space, with fixed basis element v_λ . We endow K_λ with an $U_q(\mathfrak{b})$ -action by declaring that

$$K^{\pm 1} v_\lambda := \lambda^{\pm 1} v_\lambda, \quad E v_\lambda := 0,$$

extending linearly through the obvious inclusion $\mathbb{Q}(q) \hookrightarrow \mathbb{Q}(q, \lambda)$. The universal Verma module $M(\lambda)$ is the induced module

$$M(\lambda) := U_q(\mathfrak{sl}_2) \otimes_{U_q(\mathfrak{b})} K_\lambda.$$

It is irreducible and infinite-dimensional with $\mathbb{Q}(q, \lambda)$ -basis elements

$$\{v_{\lambda,0} := v_\lambda, v_{\lambda,1}, \dots, v_{\lambda,i}, \dots\}$$

and action

$$\begin{aligned} K \cdot v_{\lambda,i} &:= \lambda q^{-2i} v_{\lambda,i}, \\ F \cdot v_{\lambda,i} &:= v_{\lambda,i+1}, \\ E \cdot v_{\lambda,i} &:= [i]_q [\beta - i + 1]_q v_{\lambda,i-1}, \end{aligned}$$

where

$$[\beta + k]_q := \frac{\lambda q^k - \lambda^{-1} q^{-k}}{q - q^{-1}}.$$

The Verma module $M(\lambda)$ can also be equipped with a Shapovalov form $(\cdot, \cdot)_\lambda$, which is again a non-degenerate bilinear form such that $(v_\lambda, v_\lambda)_\lambda = 1$ and which is $\bar{\tau}$ -Hermitian: for any $v, v' \in M(\lambda)$ and $u \in U_q(\mathfrak{sl}_2)$, we have $(u \cdot v, v')_\lambda = (v, \bar{\tau}(u) \cdot v')_\lambda$. One easily calculates that

$$(v_{\lambda,i}, v_{\lambda,j})_\lambda = \delta_{i,j} \lambda^i q^{-i^2} [i]_q! [\beta]_q [\beta - 1]_q \cdots [\beta - i + 1]_q.$$

2.1.3. Tensor products. Given W and W' two $U_q(\mathfrak{sl}_2)$ -modules, their tensor product $W \otimes W'$ is again a $U_q(\mathfrak{sl}_2)$ -module with the action induced by Δ . Explicitly, we have

$$\begin{aligned} K^{\pm 1} \cdot (w \otimes w') &:= K^{\pm 1} w \otimes K^{\pm 1} w', \\ F \cdot (w \otimes w') &:= F w \otimes K w' + w \otimes F w', \\ E \cdot (w \otimes w') &:= E w \otimes w' + K^{-1} w \otimes E w', \end{aligned}$$

for all $w \in W$ and $w' \in W'$.

For $\underline{N} = (N_1, \dots, N_r) \in \mathbb{N}^r$ we write

$$V(\underline{N}) := V(N_1) \otimes \cdots \otimes V(N_r)$$

and

$$M \otimes V(\underline{N}) := M(\lambda) \otimes V(N_1) \otimes \cdots \otimes V(N_r).$$

In the particular case $N_1 = \cdots = N_r = 1$, we write V^r for the r -th folded tensor product $V \otimes V \otimes \cdots \otimes V$.

2.1.4. Weight spaces. The module $M \otimes V(\underline{N})$ decomposes into *weight spaces*

$$M \otimes V(\underline{N})_{\lambda q^k} := \{v \in M \otimes V(\underline{N}) : Kv = \lambda q^k v\}.$$

Note that we have $M \otimes V(\underline{N}) \cong \bigoplus_{\ell \geq 0} M \otimes V(\underline{N})_{\lambda q^{|\underline{N}| - 2\ell}}$, where $|\underline{N}| := \sum_i N_i$.

2.1.5. Basis. Let \mathcal{P}_b^r be the set of weak compositions of b into $r + 1$ parts, that is

$$\mathcal{P}_b^r := \left\{ (b_0, b_1, \dots, b_r) \in \mathbb{N}^{r+1} : \sum_{i=0}^r b_i = b \right\}.$$

Consider also

$$\mathcal{P}_b^{r, \underline{N}} := \{ (b_0, b_1, \dots, b_r) \in \mathcal{P}_b^r : b_i \leq N_i \text{ for } 1 \leq i \leq r \} \subset \mathcal{P}_b^r.$$

In addition to the induced basis by the tensor product, the space $M \otimes V(\underline{N})$ admits a basis that will be particularly useful for categorification. For

$$\rho = (b_0, \dots, b_r) \in \mathcal{P}_b^r,$$

we write

$$v_\rho := F^{b_r} (\cdots F^{b_1} (F^{b_0} (v_\lambda) \otimes v_{N_1, 0}) \cdots \otimes v_{N_r, 0}).$$

Then, $M \otimes V(\underline{N})$ has a basis given by

$$\{v_\rho : \rho \in \mathcal{P}_b^{r, \underline{N}}, b \geq 0\}.$$

In particular, we have that $M \otimes V(\underline{N})_{\lambda q^{|\underline{N}| - 2b}}$ has a basis given by $\{v_\rho\}_{\rho \in \mathcal{P}_b^{r, \underline{N}}}$.

One can describe inductively the change of basis from $\{v_\rho\}_{\rho \in \mathcal{P}_b^{r, \underline{N}}}$ to the induced basis as follows:

$$v_{(b_0, \dots, b_r)} = \sum_{k=0}^{\min(b_r, N_r)} q^{(1-k)(b_r-k)} \begin{bmatrix} b_r \\ k \end{bmatrix} v_{(b_0, \dots, b_{r-1} + b_r - k)} \otimes v_{N_r, k},$$

for any $(b_0, \dots, b_r) \in \mathcal{P}_b^r$ and

$$v_{(b_0, \dots, b_{r-1})} \otimes v_{N_r, n} = \sum_{k=0}^n (-1)^{n-k} q^{(n-k)(n-2)} \begin{bmatrix} n \\ k \end{bmatrix} v_{(b_0, \dots, b_{r-1} + n-k, k)},$$

for any $(b_0, \dots, b_{r-1}) \in \mathcal{P}_b^{r-1}$ and $0 \leq n \leq N_r$, with $\begin{bmatrix} n \\ k \end{bmatrix}_q := \frac{[n]_q!}{[k]_q! [n-k]_q!}$.

We can also use these formulas to inductively rewrite a vector v_ρ with $\rho \in \mathcal{P}_b^r$ in terms of various v_κ for $\kappa \in \mathcal{P}_b^{r, N}$. Indeed, we have

$$v_{(b_0, \dots, b_r)} = \sum_{k=0}^{\min(b_r, N_r)} q^{(1-N_r)(b_r-k)} \frac{\prod_{j=1, j \neq k}^{N_r} [b_r - j]_q}{\prod_{j=1, j \neq k} [k - j]_q} v_{(b_0, \dots, b_{r-1} + b_r - k, k)},$$

for any $(b_0, \dots, b_r) \in \mathcal{P}_b^r$.

2.1.6. Shapovalov forms for tensor products. Following [49, §4.7], we consider a family of bilinear forms $(\cdot, \cdot)_{\lambda, \underline{N}}$ on tensor products of the form

$$M(\lambda) \otimes V(\underline{N})$$

satisfying the following properties:

- (1) each form $(\cdot, \cdot)_{\lambda, \underline{N}}$ is non-degenerate;
- (2) for any $v, v' \in M(\lambda) \otimes V(\underline{N})$ and $u \in U_q(\mathfrak{sl}_2)$,

$$(u \cdot v, v')_{\lambda, \underline{N}} = (v, \bar{\tau}(u) \cdot v')_{\lambda, \underline{N}};$$

- (3) for any $f \in \mathbb{Q}(q, \lambda)$ and $v, v' \in M(\lambda) \otimes V(\underline{N})$,

$$(fv, v')_{\lambda, \underline{N}} = (v, fv')_{\lambda, \underline{N}} = f(v, v')_{\lambda, \underline{N}};$$

- (4) if $v, v' \in M(\lambda) \otimes V(\underline{N})$, then

$$(v, v')_{\lambda, \underline{N}} = (v \otimes v_{N,0}, v' \otimes v_{N,0})_{\lambda, \underline{N}'},$$

where $\underline{N}' = (N_1, \dots, N_r, N)$.

Similarly to [49, Proposition 4.33] we have:

Proposition 2.1. *There exists a unique system of such bilinear forms which are given by*

$$(v, v')_{\lambda, \underline{N}} = (v, v')_{\lambda, \underline{N}}^\Pi,$$

for every $v, v' \in M(\lambda) \otimes V(\underline{N})$ where $(\cdot, \cdot)_{\lambda, \underline{N}}^\Pi$ is the product of the universal Shapovalov form on $M(\lambda)$ and of the Shapovalov forms on the various $V(N_i)$.

2.2. The blob algebra. Recall that the *blob algebra* \mathcal{B}_r is the $\mathbb{Q}(\lambda, q)$ -algebra with generators u_1, \dots, u_{r-1} and ξ , and subject to the relations of type A:

$$u_i u_j = u_j u_i, \quad \text{for } |i - j| > 1, \tag{3}$$

$$u_i u_{i+1} u_i = u_i, \quad \text{for } 1 \leq i \leq r - 2, \tag{4}$$

$$u_i u_{i-1} u_i = u_i, \quad \text{for } 2 \leq i \leq r - 1, \tag{5}$$

$$u_i^2 = -(q + q^{-1}), \quad \text{for } 1 \leq i \leq r - 1, \tag{6}$$

and to the blob relations:

$$\xi u_i = u_i \xi, \quad \text{for } 2 \leq i \leq r, \tag{7}$$

$$u_1 \xi u_1 = -(\lambda q + \lambda^{-1} q^{-1}) u_1, \tag{8}$$

$$q^{-1} \xi^2 = (\lambda q + \lambda^{-1} q^{-1}) \xi - q. \tag{9}$$

Note that ξ is invertible, with inverse given by $\xi^{-1} = \lambda + q^{-2} \lambda^{-1} - q^{-2} \xi$, and that the relations (3)–(6) imply that the generators u_1, \dots, u_{r-1} generate a subalgebra isomorphic to the Temperley–Lieb algebra of type A.

The blob algebra has several well-known diagrammatic presentations. The most classical one already appeared in [30], but (a slight modification of) the one in [14] is more convenient for our purposes. This presentation is given by setting

$$u_i = \underbrace{\left| \quad \left| \quad \cdots \quad \left| \quad \begin{array}{c} \cup \\ \cap \end{array} \quad \left| \quad \cdots \quad \left| \right. \right. \right.}_i,$$

$$\xi = \left| \begin{array}{c} \curvearrowright \\ \curvearrowleft \end{array} \right| \cdots \left| \right|,$$

where diagrams are taken up to planar isotopy and read from bottom to top, and with local relations

$$\bigcirc = -(q + q^{-1}), \tag{6}$$

$$\left| \begin{array}{c} \cup \\ \cap \end{array} \right| = -(\lambda q + \lambda^{-1} q^{-1}) \left| \right|, \tag{8}$$

$$q^{-1} \left| \begin{array}{c} \curvearrowright \\ \curvearrowleft \end{array} \right| = (\lambda q + \lambda^{-1} q^{-1}) \left| \begin{array}{c} \curvearrowleft \\ \curvearrowright \end{array} \right| - q \left| \right|, \tag{9}$$

corresponding to (6), (8), and (9) (explaining why we kept the same numbering). Note that the relations (3)–(5) and (7) are encoded by the planar isotopies.

Remark 2.2. In the graphical description of \mathcal{B}_r given in [14] the generator ξ is presented as a double braiding (see [14, Figure 1]). We don't follow that interpretation in our diagrammatics in order to simplify pictures, but we keep the terminology (see §5.3 ahead).

Remark 2.3. With respect to [14] our conventions switch (λ, q) and (λ^{-1}, q^{-1}) , which can be interpreted as exchanging the double braiding by the double inverse braiding.

There is an action of \mathcal{B}_r on $M \otimes V^r$ that intertwines with the quantum \mathfrak{sl}_2 -action. This action can be described locally, identifying the first vertical strand in \mathcal{B}_r with the identity on $M(\lambda)$, and the i th vertical strand with the identity on the i -th copy of V in $M \otimes V^r$. Then the action is given using the following maps

$$\begin{aligned}
 \text{⤵} : V \otimes V &\longrightarrow \mathbb{Q}(q, \lambda), & \begin{cases} v_{1,0} \otimes v_{1,0} \mapsto 0, \\ v_{1,0} \otimes v_{1,1} \mapsto 1, \\ v_{1,1} \otimes v_{1,0} \mapsto -q^{-1}, \\ v_{1,1} \otimes v_{1,1} \mapsto 0, \end{cases} \\
 \text{⤴} : \mathbb{Q}(q, \lambda) &\longrightarrow V \otimes V, & 1 \mapsto -qv_{1,0} \otimes v_{1,1} + v_{1,1} \otimes v_{1,0}, \\
 \text{⤵} : M \otimes V &\longrightarrow M \otimes V, & \begin{cases} v_{\lambda,k} \otimes v_{1,0} \mapsto \lambda^{-1}q^{2k}v_{\lambda,k} \otimes v_{1,0} \\ \qquad \qquad \qquad - q(q - q^{-1})[k]_q[\beta - k + 1]_q v_{\lambda,k-1} \otimes v_{1,1}, \\ v_{\lambda,k} \otimes v_{1,1} \mapsto (\lambda^{-1} + \lambda q^2 - \lambda^{-1}q^{2(k+1)})v_{\lambda,k} \otimes v_{1,1} \\ \qquad \qquad \qquad - \lambda^{-1}q^{2(k+1)}(q - q^{-1})v_{\lambda,k+1} \otimes v_{1,0}, \end{cases}
 \end{aligned}$$

where the formula for ξ is obtained by acting twice with an R -matrix. In our conventions, we have $\xi = f \circ \Theta_{21} \circ f \circ \Theta$ where Θ is given by the action of

$$\sum_{n=0}^{+\infty} (-1)^n q^{-n(n-1)/2} \frac{(q - q^{-1})^n}{[n]_q!} F^n \otimes E^n,$$

Θ_{21} by the action of

$$\sum_{n=0}^{+\infty} (-1)^n q^{-n(n-1)/2} \frac{(q - q^{-1})^n}{[n]_q!} E^n \otimes F^n,$$

and, for any, $k \in \mathbb{N}$,

$$f(v_{\lambda,k} \otimes v_{1,0}) := \lambda^{-1/2} q^k v_{\lambda,k} \otimes v_{1,0}$$

and

$$f(v_{\lambda,k} \otimes v_{1,1}) := \lambda^{1/2} q^{-k} v_{\lambda,k} \otimes v_{1,1}.$$

The following will be useful later:

Lemma 2.4. *The action of \mathcal{B}_r translates in terms of v_ρ -vectors of $M \otimes V^r$ as*

$$\underbrace{\begin{array}{c} | \quad | \quad \dots \quad | \\ \hline \end{array}}_i \quad \cap \quad | \quad \dots \quad | : \\ v_{(\dots, b_{i-1}, b_i, b_{i+1}, b_{i+2}, \dots)} \mapsto -q^{-1} [b_i]_q v_{(\dots, b_{i-1} + b_i + b_{i+1} - 1, b_{i+2}, \dots)}, \tag{10}$$

$$\underbrace{\begin{array}{c} | \quad | \quad \dots \quad | \\ \hline \end{array}}_i \quad \cup \quad | \quad \dots \quad | : \\ v_\rho \mapsto q[2]_q v_{(\dots, b_{i-1}, 1, 0, b_i, \dots)} - q v_{(\dots, b_{i-1} + 1, 0, 0, b_i, \dots)} - q v_{(\dots, b_{i-1}, 0, 1, b_i, \dots)}, \tag{11}$$

$$\begin{array}{c} \color{blue}{\left\langle \right.} \quad | \quad \dots \quad | : \\ v_{(b_0, b_1, \dots)} \mapsto (\lambda^{-1} q^{b_0} - \lambda q [b_0]_q) v_{(0, b_0 + b_1, \dots)} + \lambda q^2 [b_0]_q v_{(1, b_0 + b_1 - 1, \dots)}. \tag{12} \end{array}$$

Proof. A computational proof is given in §A. □

As a matter of fact, this completely determines $\text{End}_{U_q(\mathfrak{sl}_2)}(M \otimes V^r)$:

Theorem 2.5 ([14, Theorem 4.9]). *There is an isomorphism*

$$\mathcal{B}_r \cong \text{End}_{U_q(\mathfrak{sl}_2)}(M \otimes V^r). \tag{13}$$

The blob category \mathcal{B} is the $\mathbb{Q}(\lambda, q)$ -linear category given by

- objects are non-negative integers $r \in \mathbb{N}$;
- $\text{Hom}_{\mathcal{B}}(r, r')$ is given by $\mathbb{Q}(\lambda, q)$ -linear combinations of string diagrams connecting $r + 1$ points on the bottom to $r' + 1$ points on the top, with the first strand always connecting the left-most point to the left-most point, where the strings cannot intersect each other except for diagrams like ξ . Diagrams are considered up to planar isotopy and subject to the relations (6), (8), and (9).

Let \mathcal{TL} be the Temperley–Lieb category of type A , defined diagrammatically. It is a $\mathbb{Q}(q)$ -linear monoidal category equivalent to $\mathcal{Fund}(\mathfrak{sl}_2)$, the full monoidal subcategory of $U_q(\mathfrak{sl}_2)$ -mod generated by V . Note that \mathcal{B} can be endowed with a structure of module category over \mathcal{TL} , by gluing diagrams on the right.

Also consider the full subcategory $\mathcal{MV} \subset U_q(\mathfrak{sl}_2)$ -mod given by the modules $M(\lambda) \otimes V^{\otimes r}$ for all $r \in \mathbb{N}$. It is a module category over $\mathcal{Fund}(\mathfrak{sl}_2)$ by acting on the right with tensor product of $U_q(\mathfrak{sl}_2)$ -modules.

Theorem 2.6 ([14, Theorem 4.9]). *There are equivalences of categories such that*

$$\begin{array}{ccc}
 \mathcal{B} & \xleftarrow{\otimes_{acts}} & \mathcal{TL} \\
 \downarrow \wr & & \downarrow \wr \\
 \mathcal{MV} & \xleftarrow{\otimes_{acts}} & \mathcal{Fund}(\mathfrak{sl}_2)
 \end{array}$$

commutes.

Remark 2.7. Note that [14] considers projective Verma modules with integral highest weight. The case of universal Verma modules was studied in [26], albeit not in the categorical setup.

3. Dg-enhanced KLRW algebras

In [37] and [34] it was explained how to construct a “dg-enhancement” of cyclotomic nilHecke algebras to pass from a categorification of the integrable module $V(N)$ to a categorification of the Verma module $M(\lambda)$. This suggests that one might try to go from a categorification of $V(N) \otimes V(\underline{N})$ to a categorification of $M(\lambda) \otimes V(\underline{N})$ by constructing a dg-enhancement of KLRW algebras [49, §4], which we do next.

3.1. Preliminaries and conventions. Before defining the various algebras, we fix some conventions, and we recall some common facts about dg-structures (a reference for this is [15]). First, let \mathbb{k} be a commutative unital ring for the remaining of the paper.

3.1.1. Dg-algebras. A \mathbb{Z}^n -graded dg-(\mathbb{k} -)algebra (A, d_A) is a unital $\mathbb{Z} \times \mathbb{Z}^n$ -graded (\mathbb{k} -)algebra $A = \bigoplus_{(h, \mathbf{g}) \in \mathbb{Z} \times \mathbb{Z}^n} A_{\mathbf{g}}^h$, where we refer to the \mathbb{Z} -grading as homological (or h -degree) and the \mathbb{Z}^n -grading as \mathbf{g} -degree, with a differential $d: A \rightarrow A$ such that

- $d_A(A_{\mathbf{g}}^h) \subset A_{\mathbf{g}}^{h-1}$ for all $\mathbf{g} \in \mathbb{Z}^n, h \in \mathbb{Z}$;
- $d_A(xy) = d_A(x)y + (-1)^{\deg_h(x)}x d_A(y)$;
- $d_A^2 = 0$.

The *homology* of (A, d_A) is $H(A, d_A) := \ker(d)/\text{im}(d)$, which is a $\mathbb{Z} \times \mathbb{Z}^n$ -graded algebra that decomposes as $\bigoplus_{h \in \mathbb{Z}, \mathbf{g} \in \mathbb{Z}^n} H_{\mathbf{g}}^h(A, d_A) := H^h(A_{\mathbf{g}}, d_A)$. A morphism of dg-algebras $f: (A, d_A) \rightarrow (A', d_{A'})$ is a morphism of algebras that preserves the $\mathbb{Z} \times \mathbb{Z}^n$ -grading and commutes with the differentials. Such a morphism induces a morphism $f^*: H(A, d_A) \rightarrow H(A', d_{A'})$. We say that f is a *quasi-isomorphism* whenever f^* is an isomorphism. Also, we say that (A, d_A) is *formal* if there is a quasi-isomorphism $(A, d_A) \xrightarrow{\sim} (H(A, d_A), 0)$.

Remark 3.1. Note that, in contrast to [15], the differential decreases the homological degree instead of increasing it.

Similarly, a \mathbb{Z}^n -graded left dg-module is a $\mathbb{Z} \times \mathbb{Z}^n$ -graded module M with a differential d_M such that

- $d_M(M_{\mathbf{g}}^h) \subset M_{\mathbf{g}}^{h-1}$ for all $\mathbf{g} \in \mathbb{Z}^n, h \in \mathbb{Z}$;
- $d_M(x \cdot m) = d_A(x) \cdot y + (-1)^{\deg_h(x)}x \cdot d_M(y)$;
- $d_M^2 = 0$.

Homology, maps between dg-modules and quasi-isomorphisms are defined as above, and there are similar notions of \mathbb{Z}^n -graded right dg-modules and dg-bi-modules.

In our convention, a \mathbb{Z}^m -graded category is a category with a collection of m autoequivalences, strictly commuting with each others. The category (A, d_A) -mod of (left) \mathbb{Z}^n -graded dg-modules over a dg-algebra (A, d_A) is a $\mathbb{Z} \times \mathbb{Z}^n$ -graded abelian category, with kernels and cokernels defined as usual. The action of \mathbb{Z} is given by the *homological shift functor*

$$[1]: (A, d_A)\text{-mod} \longrightarrow (A, d_A)\text{-mod}$$

acting by

- increasing the degree of all elements in a module M up by 1, i.e. $\deg_h(m[1]) = \deg_h(m) + 1$;
- switching the sign of the differential $d_{M[1]} := -d_M$;
- introducing a sign in the left-action $r \cdot (m[1]) := (-1)^{\deg_h(r)}(r \cdot m)[1]$.

The action of $g \in \mathbb{Z}^n$ is given by increasing the \mathbb{Z}^n -degree of elements up by g , in the sense that

$$(gM)_{g_0+g} := (M)_{g_0},$$

or in other terms, an element $x \in M$ with degree g_0 becomes of degree $g_0 + g$ in gM . There are similar definitions for categories of right dg-modules and dg-bimodules, with the subtlety that the homological shift functor does not twist the right-action:

$$(m[1]) \cdot r := (m \cdot r)[1].$$

As usual, a short exact sequence of dg-(bi)modules induces a long exact sequence in homology.

Let $f: (M, d_M) \rightarrow (N, d_N)$ be a morphism of dg-(bi)modules. Then, one constructs the *mapping cone* of f as

$$\text{Cone}(f) := (M[1] \oplus N, d_C), d_C := \begin{pmatrix} -d_M & 0 \\ f & d_N \end{pmatrix}. \tag{14}$$

The mapping cone is a dg-(bi)module, and it fits in a short exact sequence:

$$0 \longrightarrow N \xrightarrow{\iota_N} \text{Cone}(f) \xrightarrow{\pi_{M[1]}} M[1] \longrightarrow 0,$$

where ι_N and $\pi_{M[1]}$ are the inclusion and projection $N \xrightarrow{\iota_N} M[1] \oplus N \xrightarrow{\pi_{M[1]}} M[1]$.

3.1.2. Hom and tensor functors. Given a left dg-module (M, d_M) and a right dg-module (N, d_N) , one constructs the tensor product

$$\begin{aligned} (N, d_N) \otimes_{(A, d_A)} (M, d_M) &:= ((M \otimes_A N), d_{M \otimes N}), \\ d_{M \otimes N}(m \otimes n) &:= d_M(m) \otimes n + (-1)^{\text{deg}_h(m)} m \otimes d_N(n). \end{aligned} \tag{15}$$

If (N, d_N) (resp. (M, d_M)) has the structure of a dg-bimodule, then the tensor product inherits a left (resp. right) dg-module structure.

Given a pair of left dg-modules (M, d_M) and (N, d_N) , one constructs the dg-hom space

$$\begin{aligned} \text{HOM}_{(A, d_A)}((M, d_M), (N, d_N)) &:= (\text{HOM}_A(M, N), d_{\text{HOM}(M, N)}), \\ d_{\text{HOM}(M, N)}(f) &:= d_N \circ f - (-1)^{\text{deg}_h(f)} f \circ d_M, \end{aligned} \tag{16}$$

where HOM_A is the $\mathbb{Z} \times \mathbb{Z}^n$ -graded hom space of maps between $\mathbb{Z} \times \mathbb{Z}^n$ -graded A -modules. Again, if (M, d_M) (resp. (N, d_N)) has the structure of a dg-bimodule, then it inherits a left (resp. right) dg-module structure.

In particular, given a dg-bimodule (B, d_B) over a pair of dg-algebras (S, d_S) - (R, d_R) , we obtain tensor and hom functors

$$B \otimes_{(R, d_R)} (-): (R, d_R)\text{-mod} \longrightarrow (S, d_S)\text{-mod},$$

$$\text{HOM}_{(S, d_S)}(B, -): (S, d_S)\text{-mod} \longrightarrow (R, d_R)\text{-mod},$$

which form a adjoint pair $(B \otimes_{(R, d_R)} -) \vdash \text{HOM}_{(S, d_S)}(B, -)$. Explicitly, the natural bijection

$$\Phi_{M, N}^B: \text{Hom}_{(S, d_S)}(B \otimes_{(R, d_R)} M, N) \xrightarrow{\cong} \text{Hom}_{(R, d_R)}(M, \text{HOM}_{(S, d_S)}(B, N)), \tag{17}$$

is given by

$$(f: B \otimes_{(R, d_R)} M \longrightarrow N) \longmapsto (m \longmapsto (b \longmapsto f(b \otimes m))).$$

3.1.3. Diagrammatic algebras. We always read diagram from bottom to top. We say that a diagram is *braid-like* when it is given by strands connecting a collection of points on the bottom to a collection of points on the top, without being able the turnback. Suppose these diagrams can have singularities (like dots, 4-valent crossings, or other similar decorations).

A *braid-like planar isotopy* is an isotopy fixing the endpoints and that does not create any critical point, in particular it means we can exchange distant singularities f and g :

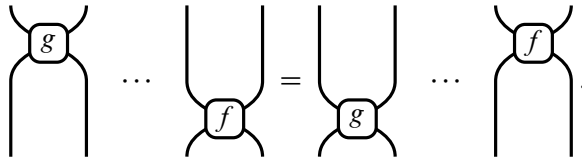

Suppose that the diagrams carry a homological degree (associated to singularities), and consider linear combination of such diagrams. Then, a *graded braid-like planar isotopy* is an isotopy fixing the endpoints, that does not create any critical point and such that we get a sign whenever we exchange two distant singularities f and g :

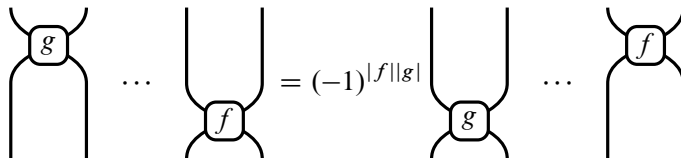

where $|f|$ (resp. $|g|$) is the homological degree of f (resp. g).

Multiplication is given by vertical concatenation of diagrams if the labels and colors of the strands agree, and is zero otherwise. As explained in [49, §4], the algebra T_b^N is finite-dimensional and \mathbb{Z} -graded (we refer to this grading as q -grading), with

$$\text{deg}_q \left(\begin{array}{c} \diagup \\ \diagdown \end{array} \right) = -2, \quad \text{deg}_q \left(\begin{array}{c} | \\ \bullet \\ | \end{array} \right) = 2, \tag{24}$$

$$\text{deg}_q \left(\begin{array}{c} \diagup \\ \diagdown \\ N_i \end{array} \right) = \text{deg}_q \left(\begin{array}{c} \diagdown \\ \diagup \\ N_i \end{array} \right) = N_i. \tag{25}$$

In the case of $\underline{N} = (N)$ the algebra $T_b^{(N)}$ contains a single red strand labeled N , and is isomorphic to the cyclotomic nilHecke algebra NH_b^N .

Definition 3.2. The *dg-enhanced KLRW algebra* $T_b^{\lambda, N}$ is the diagrammatic \mathbb{k} -algebra carrying an homological degree generated by braid-like diagrams on b black strands, r red strands and a blue strand on the left. Red strands are labeled from left to right by N_1, \dots, N_r and the blue strand is labeled λ . Black strands can carry dots and intersect transversely with black and red strands. Moreover, the left-most black strand can be *nailed* on the blue strand, giving a 4-valent vertex as follows:



We put the crossings and the dot in homological degree 0, while the nail is in homological degree 1. These diagrams are taken modulo graded braid-like planar isotopy, and subject to the local relations (18)–(23) of T_b^N , together with the local relations:

$$\begin{array}{c} \bullet \\ | \\ \lambda \end{array} = \begin{array}{c} | \\ \bullet \\ \lambda \end{array}, \quad \begin{array}{c} \diagup \\ \diagdown \\ \lambda \end{array} = - \begin{array}{c} \diagdown \\ \diagup \\ \lambda \end{array}, \quad \begin{array}{c} \diagup \\ \diagdown \\ \lambda \end{array} = 0. \tag{26}$$

Remark 3.3. Note that there can be no black or red strand at the left of the blue strand.

Remark 3.4. Note that since nails are stuck on the left, we can not exchange them using a graded braid-like planar isotopy. Thus, because nails are the only generators carrying a non-zero homological degree, we could consider diagrams up to usual braid-like planar isotopy. However, the homological degree of the nail will play an important role in the categorification of the structure constant $[\beta + k]_q$ appearing in $M(\lambda) \otimes V(\underline{N})$, and graded braid-like planar isotopy will play an important role in §5.

Clearly, there is an injection of algebra $\tilde{T}_b^{\underline{N}} \hookrightarrow T_b^{\lambda, \underline{N}}$ given by adding a vertical blue strand at the left of a diagram in $\tilde{T}_b^{\underline{N}}$.

We endow $T_b^{\lambda, \underline{N}}$ with an extra \mathbb{Z}^2 -grading, the first one being inherited from $\tilde{T}_b^{\underline{N}}$ and denoted q , the second is written λ . We declare that

$$\text{deg}_{q, \lambda} \left(\begin{array}{c} \text{K} \\ \lambda \end{array} \right) := (0, 2),$$

and the elements without a nail are all in degree λ zero and have the same q -degree as in (24) and (25), so that the inclusion $\tilde{T}_b^{\underline{N}} \hookrightarrow T_b^{\lambda, \underline{N}}$ preserves the q -grading. One easily checks that it is well defined.

In the case of $\underline{N} = \emptyset$, the algebra $T_b^{\lambda, \emptyset}$ contains only a blue strand labeled λ and no red strands, and is isomorphic to the dg-enhanced nilHecke algebra introduced in [37, Definition 2.3]. To match with the notation from [37], we write $A_b := T_b^{\lambda, \emptyset}$.

We will often endow $T_b^{\lambda, \underline{N}}$ with a trivial differential, turning it into a \mathbb{Z}^2 -graded dg-algebra $(T_b^{\lambda, \underline{N}}, 0)$.

3.3. Basis theorem. For any $\rho = (b_0, b_1, \dots, b_r) \in \mathcal{P}_b^r$, define the idempotent

$$1_\rho := \begin{array}{c} \begin{array}{|c|} \hline \color{blue}{\parallel} \\ \hline \lambda \end{array} \quad \underbrace{\begin{array}{|c|} \hline \dots \\ \hline \end{array}}_{b_0} \quad \color{red}{\parallel} \quad \underbrace{\begin{array}{|c|} \hline \dots \\ \hline \end{array}}_{b_1} \quad \color{red}{\parallel} \quad \dots \quad \color{red}{\parallel} \quad \underbrace{\begin{array}{|c|} \hline \dots \\ \hline \end{array}}_{b_r} \end{array}$$

of $T_b^{\lambda, \underline{N}}$. Note that $T_b^{\lambda, \underline{N}} \cong \bigoplus_{\kappa, \rho \in \mathcal{P}_b^r} 1_\kappa T_b^{\lambda, \underline{N}} 1_\rho$ as $\mathbb{Z} \times \mathbb{Z}^2$ -graded \mathbb{k} -module.

3.3.1. Polynomial action. We now define an action of the dg-algebra $T_b^{\lambda, \underline{N}}$ on

$$\text{Pol}_b^r := \bigoplus_{\rho \in \mathcal{P}_b^r} \text{Pol}_b \varepsilon_\rho,$$

the free module over the ring

$$\text{Pol}_b := \mathbb{Z}[x_1, \dots, x_b] \otimes \wedge^\bullet(\omega_1, \dots, \omega_b)$$

generated by ε_ρ for each $\rho \in \mathcal{P}_b^r$.

We recall the action of the symmetric group S_b on Pol_b used in [37, §2.2]. We view S_b as a Coxeter group with generators $\sigma_i = (i \ i + 1)$. The generator σ_i acts on Pol_b as follows,

$$\begin{aligned} \sigma_i(x_j) &:= x_{\sigma_i(j)}, \\ \sigma_i(\omega_j) &:= \omega_j + \delta_{i,j}(x_i - x_{i+1})\omega_{i+1}. \end{aligned}$$

For $\kappa, \rho \in \mathcal{P}_b^r$, an element of $1_\kappa T_b^{\lambda, N} 1_\rho$ acts by zero on any $\text{Pol}_b \varepsilon_{\rho'}$ for $\rho' \neq \rho$ and sends $\text{Pol}_b \varepsilon_\rho$ to $\text{Pol}_b \varepsilon_\kappa$. It remains to describe the action of the local generators of $T_b^{\lambda, N}$ on a polynomial $f \in \text{Pol}_b$. First, similarly as in [49, Lemma 4.12], we put

$$\begin{aligned} \dots \bullet \dots \cdot f &:= x_i f, \\ \dots \begin{array}{c} \diagup \quad \diagdown \\ \diagdown \quad \diagup \end{array} \dots \cdot f &:= \frac{f - \sigma_i(f)}{x_i - x_{i+1}}, \\ \dots \begin{array}{c} \text{red } \diagup \quad \text{red } \diagdown \\ \text{red } \diagdown \quad \text{red } \diagup \end{array} \dots \cdot f &:= f, \\ \dots \begin{array}{c} \text{red } \diagup \quad \text{red } \diagdown \\ \text{red } \diagdown \quad \text{red } \diagup \end{array} \dots \cdot f &:= x_i^N f, \end{aligned}$$

where we identify $x_i \in \text{Pol}_b \varepsilon_\rho$ with $x_i \in \text{Pol}_b \varepsilon_\kappa$, and where we only have drawn the i -th or the i -th and $(i + 1)$ -th black strands, counting from left to right. Furthermore, we put

$$\dots \begin{array}{c} \text{blue } \diagup \quad \text{blue } \diagdown \\ \text{blue } \diagdown \quad \text{blue } \diagup \end{array} \dots \cdot f := \omega_1 f.$$

Lemma 3.5. *The rules above define an action of $T_b^{\lambda, N}$ on Pol_b^r .*

Proof. We easily check that the relations (18)–(23) and (26) are satisfied. □

Fix $\rho = (b_0, \dots, b_r) \in \mathcal{P}_b^r$. Let NH_n be the nilHecke algebra on n -strands (it is described as a diagrammatic algebra with only black strands having dots and relations (18) and (19)). There is a map

$$\eta_\rho: A_{b_0} \otimes \text{NH}_{b_1} \otimes \dots \otimes \text{NH}_{b_r} \longrightarrow T_b^{\lambda, N},$$

diagrammatically given by

(27)

where we recall that A_{b_0} is isomorphic to the dg-enhanced nilHecke algebra of [37], identifying the nilHecke generators with each other and the nail with the “leftmost floating dot.” The tensor product $A_{b_0} \otimes \text{NH}_{b_1} \otimes \dots \otimes \text{NH}_{b_r}$ acts on Pol_b^r through η_ρ . This action is only non-zero on $\text{Pol}_b \varepsilon_\rho$ and it is readily checked that this action coincides with the tensor product of the polynomial actions of A_{b_0} on $\mathbb{Z}[x_1, \dots, x_{b_0}] \otimes \wedge^\bullet(\omega_1, \dots, \omega_{b_0}) \subset \text{Pol}_b$ from [37, §2.2], and of the usual action of the nilHecke algebra NH_{b_i} on $\mathbb{Z}[x_{b_0+\dots+b_{i-1}+1}, \dots, x_{b_0+\dots+b_i}] \subset \text{Pol}_b$ (see for example [21, §2.3]).

Lemma 3.6. *The map η_ρ is injective.*

Proof. It follows immediately from the faithfulness of the polynomial actions of A_{b_0} (see [37, Corollary 3.9]) and of NH_{b_i} (see [21, Corollary 2.6]). \square

3.3.2. Left-adjusted expressions. We recall the notion of a left-adjusted expression as in [37, §2.2.1]: a reduced expression $\sigma_{i_1} \dots \sigma_{i_k}$ of an element $w \in S_{r+b}$ is said to be *left-adjusted* if $i_1 + \dots + i_k$ is minimal. One can obtain a left-adjusted expression of any element of S_{r+b} by taking recursively its representative in the left coset decomposition

$$S_n = \bigsqcup_{t=1}^n S_{n-1} \sigma_{n-1} \dots \sigma_t.$$

As one easily confirms, if we think of permutations in terms of string diagrams, then a left-reduced expression is obtained by pulling every strand as far as possible to the left.

3.3.3. A basis of $T_b^{\lambda, N}$. We now turn to the diagrammatic description of a basis of $T_b^{\lambda, N}$ similar to [34, §3.2.3]. For an element $\rho \in \mathcal{P}_b^r$ and $1 \leq k \leq b$, we define the tightened nail $\theta_k \in 1_\rho T_b^{\lambda, N} 1_\rho$ as the following element:

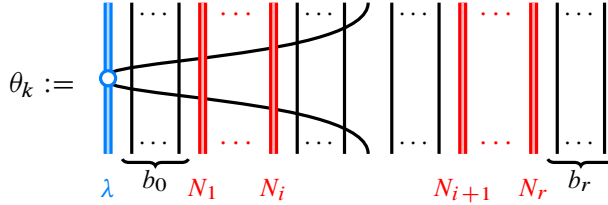

where the nailed strand is the k -th black strand counting from left to right. This element has degree $\deg_{\mathfrak{S}_{h,q,\lambda}}(\theta_k) = (1, -4(k - 1) + 2(N_1 + \dots + N_i), 2)$.

Lemma 3.7. Tightened nails anticommute with each other, up to terms with a smaller number of crossings:

$$\theta_k \theta_\ell = -\theta_\ell \theta_k + R, \quad \theta_k^2 = 0 + R',$$

where R (resp. R') is a sum of diagrams with strictly fewer crossings than $\theta_k \theta_\ell$ (resp. θ_k^2), for all $1 \leq k, \ell \leq b$.

Proof. Similar to [34, Lemma 3.12], and omitted. □

Remark 3.8. If $k, \ell \leq b_0$, then we have $\theta_k \theta_\ell = -\theta_\ell \theta_k$. Moreover, if $k \notin \{b_0 + 1, b_0 + b_1 + 1, \dots, b_0 + \dots + b_r + 1\}$, then we have $\theta_k^2 = 0$.

Now fix $\kappa, \rho \in \mathcal{P}_b^r$ and consider the subset of permutations ${}_\kappa S_\rho \subset S_{r+b}$, viewed as diagrams with a blue strand, b black strands and r red strands, such that

- the blue strand is always on the left of the diagram;
- the strands are ordered at the bottom by 1_ρ and at the top by 1_κ ;
- for any reduced expression of $w \in {}_\kappa S_\rho$, there are no red/red crossings.

Example 3.9. If $\kappa = \rho = (0, 1, 1)$, then the set ${}_\kappa S_\rho$ has two elements, namely

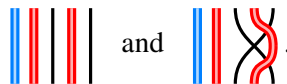

Note that the second element is not left-adjusted.

For each $w \in {}_\kappa S_\rho, \underline{l} = (l_1, \dots, l_b) \in \{0, 1\}^b$ and $\underline{a} = (a_1, \dots, a_b) \in \mathbb{N}^b$ we define an element $b_{w, \underline{l}, \underline{a}} \in 1_\kappa T_m^{\lambda, N} 1_\rho$ as follows:

- (1) we choose a left-reduced expression of w in terms of diagrams as above;
- (2) for each $1 \leq i \leq b$, if $l_i = 1$, then we nail the i -th black strand at the top, counting from the left, on the blue strand by pulling it from its leftmost position;
- (3) finally, for each $1 \leq i \leq b$, we add a_i dots on the i -th black strand at the top.

Let ${}_{\kappa}B_{\rho} := \{b_{w,\underline{l},\underline{a}} : w \in {}_{\kappa}S_{\rho}, \underline{l} \in \{0, 1\}^b, \underline{a} \in \mathbb{N}^b\}$.

Example 3.10. We continue the example of $\kappa = \rho = (0, 1, 1)$. If we choose $\underline{l} = (1, 0)$ and $\underline{a} = (0, 1)$ for w the permutation with a black/black crossing, after left-adjusting it, then we obtain

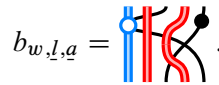

Theorem 3.11. *The set ${}_{\kappa}B_{\rho}$ is a basis of ${}_{1_{\kappa}}T_b^{\lambda,N} 1_{\rho}$ as a $\mathbb{Z} \times \mathbb{Z}^2$ -graded \mathbb{k} -module.*

Proof. By Lemma 3.7, with arguments similar to [34, Proposition 3.13], one shows that this set generates ${}_{1_{\kappa}}T_b^{\lambda,N} 1_{\rho}$ as a \mathbb{k} -module. The proof consists in an induction on the number of crossings, allowing to apply braid-moves in order to reduce diagrams. In order to show that this set is linearly independent over \mathbb{k} , we apply Lemma 3.6. □

In the following, we draw $T_b^{\lambda,N} 1_{\rho}$ with $\rho = (b_0, \dots, b_r)$ as a box diagram

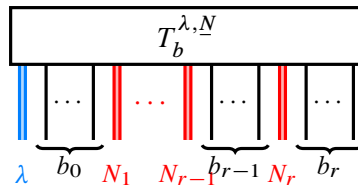

Moreover, when we draw something like

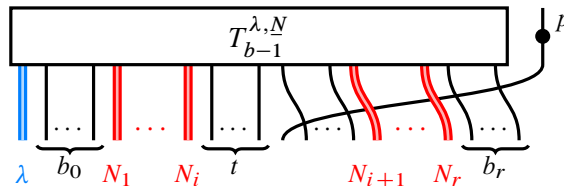

with $p \geq 0$ and $0 \leq t < b_i$, it means we consider the subset of $T_b^{\lambda,N} 1_{\rho}$ given replacing the box labeled $T_{b-1}^{\lambda,N}$ with any diagram of $T_{b-1}^{\lambda,N}$ in the diagram above, and consider it as a diagram of $T_b^{\lambda,N} 1_{\rho}$.

Corollary 3.12. *As a $\mathbb{Z} \times \mathbb{Z}^2$ -graded \mathbb{k} -module, $T_b^{\lambda, N} 1_\rho$ decomposes as a direct sum*

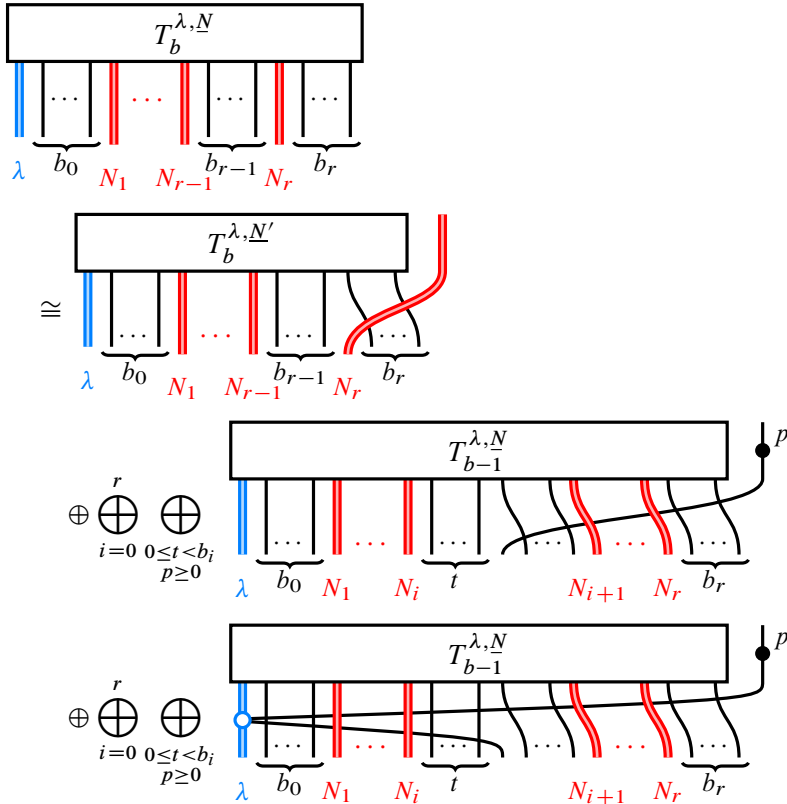

where $\underline{N}' = (N_1, \dots, N_{r-1})$, and the isomorphism is given by inclusion.

Proof. The claim follows immediately from Theorem 3.11. □

3.4. Dg-enhancement. For each $N \in \mathbb{N}$, we want to define a non-trivial differential d_N on $T_b^{\lambda, N}$. First, we collapse the \mathbb{Z}^2 -grading into a single \mathbb{Z} -grading, which we also call q -degree, through the map $\mathbb{Z}^2 \rightarrow \mathbb{Z}$, $(a, b) \mapsto a + bN$ (i.e. specializing $\lambda = q^N$). Then, we put

$$d_N \left(\begin{array}{c} \text{blob} \\ \lambda \end{array} \right) := \begin{array}{c} \text{strand} \\ \lambda \end{array} \text{ with a dot } N$$

and $d_N(t) := 0$ for all element t of $\tilde{T}_b^N \subset T_b^{\lambda, N}$, and extending by the graded Leibniz rule with respect to the homological grading. A straightforward computation shows that d_N respects all the defining relations of $T_b^{\lambda, N}$, and therefore is well defined.

Theorem 3.13. *The \mathbb{Z} -graded dg-algebra $(T_b^{\lambda, N}, d_N)$ is formal with*

$$H(T_b^{\lambda, N}, d_N) \cong T_b^{(N, \underline{N})},$$

where $(N, \underline{N}) := (N, N_1, \dots, N_r) \in \mathbb{N}^{r+1}$.

Proof. The proof follows by similar arguments as in [34, Theorem 4.4], by using Corollary 3.12. We leave the details to the reader. \square

4. A categorification of $M(\lambda) \otimes V(\underline{N})$

In this section we explain how derived categories of $(T_b^{\lambda, N}, 0)$ -dg-modules categorify the $U_q(\mathfrak{sl}_2)$ -module $M(\lambda) \otimes V(\underline{N})$. Since the construction is very similar to the one in [37] and [34], we will assume some familiarity with [37] and [34], and we will refer to these papers for several details.

We introduce the notations

$$\begin{aligned} \bigoplus_{[k]_q}(-) &:= \bigoplus_{p=0}^{k-1} q^{k-1-2p}(-), \\ \bigoplus_{[\beta+k]_q}(-) &:= \bigoplus_{p \geq 0} \lambda q^{1+2p+k}(-)[1] \oplus \lambda^{-1} q^{1+2p-k}(-), \end{aligned}$$

where we recall that $q^a \lambda^b(-)$ is a shift up by (a, b) in the \mathbb{Z}^2 -grading, and $(-)[1]$ is a shift up by 1 in the homological grading. We write \otimes for $\otimes_{\mathbb{k}}$, and \otimes_b for $\otimes_{(T_b^{\lambda, N}, 0)}$. We also write $\mathcal{D}_{\text{dg}}(T_b^{\lambda, N}, 0)$ for the dg-enhanced derived category of \mathbb{Z}^2 -graded dg-modules over $(T_b^{\lambda, N}, 0)$ (see §B.2 for a precise definition).

4.1. Categorical action. Let $1_{b,1} \in T_{b+1}^{\lambda, N}$ be the idempotent given by

$$1_{b,1} := \sum_{\rho \in \mathcal{P}_b^r} \left| \begin{array}{c} \color{blue}{\parallel} \\ \dots \\ \color{red}{\parallel} \\ \dots \\ \color{red}{\parallel} \end{array} \right| \cdot$$

λ b_0 N_1 b_1 N_2 \dots N_r b_r

There is a (non-unital) map of algebras $T_b^{\lambda,N} \rightarrow T_{b+1}^{\lambda,N}$ given by adding a vertical black strand to the right of a diagram from $T_b^{\lambda,N}$:

$$\begin{array}{c} \begin{array}{|c|c|c|c|c|c|} \hline \text{blue} & \dots & \text{red} & \dots & \text{red} & \dots \\ \hline \end{array} \xrightarrow{\quad} \begin{array}{|c|c|c|c|c|c|} \hline \text{blue} & \dots & \text{red} & \dots & \text{red} & \dots \\ \hline \end{array} \\ \begin{array}{c} \lambda \quad N_1 \quad N_{r-1} \quad N_r \end{array} \quad \begin{array}{c} \lambda \quad N_1 \quad N_{r-1} \quad N_r \end{array} \end{array} \quad (28)$$

sending the unit $1 \in T_b^{\lambda,N}$ to the idempotent $1_{b,1}$. This map gives rise to derived induction and restriction dg-functors

$$\begin{aligned} \text{Ind}_b^{b+1} &: \mathcal{D}_{\text{dg}}(T_b^{\lambda,N}, 0) \longrightarrow \mathcal{D}_{\text{dg}}(T_{b+1}^{\lambda,N}, 0), \\ \text{Ind}_b^{b+1}(-) &:= (T_{b+1}^{\lambda,N}, 0)1_{b,1} \otimes_b^L (-), \\ \text{Res}_b^{b+1} &: \mathcal{D}_{\text{dg}}(T_{b+1}^{\lambda,N}, 0) \longrightarrow \mathcal{D}_{\text{dg}}(T_b^{\lambda,N}, 0), \\ \text{Res}_b^{b+1}(-) &:= \text{RHOM}_{b+1}((T_{b+1}^{\lambda,N}, 0)1_{b,1}, -), \end{aligned}$$

which are adjoint (see §B.3). By Corollary 3.12, we know that $(T_{b+1}^{\lambda,N}, 0)$ is a cofibrant dg-module over $(T_b^{\lambda,N}, 0)$, so that we can replace derived tensor products (resp. derived homs) by usual tensor products

$$\begin{aligned} \text{Ind}_b^{b+1}(-) &\cong (T_{b+1}^{\lambda,N}, 0)1_{b,1} \otimes_b (-), \\ \text{Res}_b^{b+1}(-) &\cong 1_{b,1}(T_{b+1}^{\lambda,N}, 0) \otimes_{b+1} (-). \end{aligned}$$

Then, we define

$$\begin{aligned} F_b &:= \text{Ind}_b^{b+1}, \\ E_b &:= \lambda^{-1}q^{1+2b-|N|} \text{Res}_b^{b+1}, \end{aligned}$$

and Id_b is the identity dg-functor on $\mathcal{D}_{\text{dg}}(T_b^{\lambda,N}, 0)$.

Theorem 4.1. *There is a quasi-isomorphism*

$$\text{Cone}(F_{b-1}E_{b-1} \longrightarrow E_bF_b) \xrightarrow{\cong} \bigoplus_{[\beta+|N|-2b]_q} \text{Id}_b,$$

of dg-functors.

Proof. Consider the map

$$\psi: q^{-2}(T_b^{\lambda,N}1_{b-1,1} \otimes_{b-1} 1_{b-1,1}T_b^{\lambda,N}) \longrightarrow 1_{b,1}T_{b+1}^{\lambda,N}1_{b,1},$$

given by

$$x \otimes_{b-1} y \mapsto x \tau_b y,$$

where τ_b is a crossing between the b -th and $(b + 1)$ -th black strands. Diagrammatically, one can picture it as

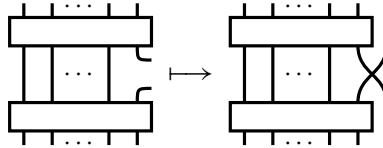

where the bent black strands informally depict the induction/restriction functors. Then, as in [34, Theorem 5.1], we obtain an exact sequence of $(T_b^{\lambda,N}, T_{b+1}^{\lambda,N})$ -bimodules

$$\begin{aligned} 0 \longrightarrow q^{-2} (T_b^{\lambda,N} 1_{b-1,1} \otimes_{b-1} 1_{b-1,1} T_b^{\lambda,N}) &\xrightarrow{\psi} 1_{b,1} T_{b+1}^{\lambda,N} 1_{b,1} \\ &\xrightarrow{\phi} \bigoplus_{p \geq 0} q^{2p} (T_b^{\lambda,N}) \oplus \lambda^2 q^{2p+2|\underline{N}|-4b} (T_b^{\lambda,N}) \longrightarrow 0, \end{aligned}$$

where ϕ is the projection onto the following summands

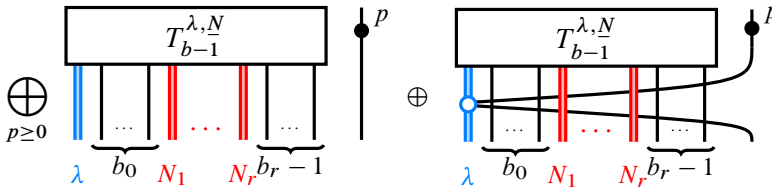

of Corollary 3.12 (i.e. when $i = r$ and $t = b_r - 1$). Note that, a priori, this only defines a map of left modules. Fortunately, by applying similar arguments as in [34, Lemma 5.4], it is possible to show that it defines a map of bimodules. Exactness follows from a dimensional argument using Corollary 3.12. \square

4.1.1. Recovering $V(N) \otimes V(\underline{N})$. Introducing the differential d_N from §3.4 in the picture, the map (28) lifts to a map of dg-algebras $(T_b^{\lambda,N}, d_N) \rightarrow (T_{b+1}^{\lambda,N}, d_N)$. Then we define dg-functors

$$\begin{aligned} F_b^N(-) &:= (T_{b+1}^{\lambda,N}, d_N) 1_{b,1} \otimes_b (-), \\ E_b^N(-) &:= q^{2b-|\underline{N}|-N} 1_{b,1} (T_{b+1}^{\lambda,N}, d_N) \otimes_{b+1} (-). \end{aligned}$$

These definitions corresponds with derived induction and (shifted) derived restriction dg-functors along (28), by Corollary 3.12 again.

Recall the notion of a strongly projective dg-module from [32] (or see §B.1.2).

Proposition 4.2. *As $(T_b^{\lambda, \underline{N}}, d_N)$ -module, $(T_{b+1}^{\lambda, \underline{N}}, d_N)$ is strongly projective.*

Proof. As in [34, Proposition 5.15], and omitted. □

By Proposition B.2, Theorem 4.1 can be seen as a quasi-isomorphism of mapping cones

$$\begin{aligned} \text{Cone}(F_{b-1}^N E_{b-1}^N \longrightarrow E_b^N F_b^N) \\ \xrightarrow{\simeq} \text{Cone}\left(\bigoplus_{p \geq 0} q^{1+2p+N+|\underline{N}|-2b} \text{Id}_b \xrightarrow{h_N} \bigoplus_{p \geq 0} q^{1+2p-N-|\underline{N} |+2b} \text{Id}_b\right), \end{aligned}$$

where h_N is given by multiplication by the element

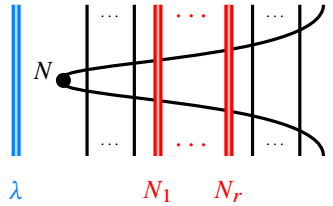

Proposition 4.3. *There is a quasi-isomorphism*

$$\text{Cone}\left(\bigoplus_{p \geq 0} q^{1+2p+N+|\underline{N}|-2b} \text{Id}_b \xrightarrow{h_N} \bigoplus_{p \geq 0} q^{1+2p-N-|\underline{N} |+2b} \text{Id}_b\right) \xrightarrow{\cong} \bigoplus_{[N+|\underline{N}|-2b]_q} \text{Id}_b,$$

where $\bigoplus_{[-k]_q} M := \bigoplus_{[k]_q} M[1]$.

Proof. As in [34, Proposition 5.9], and omitted. □

4.1.2. Induction along red strands. Take $\underline{N} = (N_1, \dots, N_r)$ and $\underline{N}' = (\underline{N}, N_{r+1})$. Consider the (non-unital) map of algebras $T_b^{\lambda, \underline{N}} \rightarrow T_b^{\lambda, \underline{N}'}$ that consists in adding a vertical red strand labeled N_{r+1} at the right a diagram:

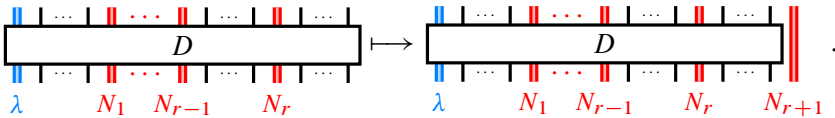

Let $\mathfrak{J}: \mathcal{D}_{\text{dg}}(T_b^{\lambda, \underline{N}}, 0) \rightarrow \mathcal{D}_{\text{dg}}(T_b^{\lambda, \underline{N}'}, 0)$ be the corresponding induction dg-functor, and let $\tilde{\mathfrak{J}}: \mathcal{D}_{\text{dg}}(T_b^{\lambda, \underline{N}'}, 0) \rightarrow \mathcal{D}_{\text{dg}}(T_b^{\lambda, \underline{N}}, 0)$ be the restriction dg-functor.

Proposition 4.4. *There is an isomorphism $\tilde{\mathfrak{J}} \circ \mathfrak{J} \cong \text{Id}$.*

Proof. The statement follows from Corollary 3.12. □

4.2. Categorification theorem. In this section we suppose that \mathbb{k} is a field. Recall the notation of an asymptotic Grothendieck group \mathbf{K}_0^Δ from [33, §8] (or §B.4). Since $(T_b^{\lambda,N}, 0)$ is a positive c.b.l.f. dimensional \mathbb{Z}^2 -graded dg-algebra (see Definition B.5), we have by Theorem B.6 that $\mathbf{K}_0^\Delta(T_b^{\lambda,N}, 0)$ is a free $\mathbb{Z}((q, \lambda))$ -module generated by the classes of projective $T_b^{\lambda,N}$ -modules with a trivial differential. Let

$${}_{\mathbb{Q}}\mathbf{K}_0^\Delta(-) := \mathbf{K}_0^\Delta(-) \otimes_{\mathbb{Z}((q,\lambda))} \mathbb{Q}((q, \lambda)).$$

For each $\rho \in \mathcal{P}_b^r$, there is a projective $T_b^{\lambda,N}$ -module given by

$$P_\rho := T_b^{\lambda,N} 1_\rho.$$

Recall the inclusion $\eta_\rho: A_{b_0} \otimes \text{NH}_{b_1} \otimes \cdots \otimes \text{NH}_{b_r} \hookrightarrow T_b^{\lambda,N}$ defined in (27). It is well known (see for example [21, §2.2.3]) that NH_n admits a unique primitive idempotent up to equivalence given by

$$e_n := \tau_{\vartheta_n} x_1^{n-1} x_2^{n-2} \cdots x_{n-1} \in \text{NH}_n,$$

where $\vartheta_n \in S_n$ is the longest element, $\tau_{w_1 w_2 \cdots w_k} := \tau_{w_1} \tau_{w_2} \cdots \tau_{w_k}$, with τ_i being a crossing between the i -th and $(i + 1)$ -th strands, and x_i is a dot on the i -th strand. There is a similar result for $\text{NH}_{b_0} \subset A_{b_0}$ (see [37, §2.5.1]). Moreover, for degree reasons, any primitive idempotent of $T_b^{\lambda,N}$ is the image of a collection of idempotents under the inclusion η_ρ for some ρ , and thus is of the form

$$e_\rho := \eta_\rho(e_{b_1} \otimes \cdots \otimes e_{b_n}).$$

It is also well known (see for example [21, §2.2.3]) that there is a decomposition

$$\text{NH}_n \cong q^{n(n-1)/2} \bigoplus_{[n]_q!} \text{NH}_n e_n,$$

as left NH_n -modules. For the same reasons, we obtain

$$P_\rho \cong q^{\sum_{i=0}^r b_i(b_i-1)/2} \bigoplus_{\prod_{i=0}^r [b_i]_q!} T_b^{\lambda,N} e_\rho.$$

4.2.1. Categorified Shapovalov form. Let $T^{\lambda,N} := \bigoplus_{b \geq 0} T_b^{\lambda,N}$. As in [21, §2.5], let $\psi: T^{\lambda,N} \rightarrow (T^{\lambda,N})^{\text{op}}$ be the map that takes the mirror image of diagrams along the horizontal axis. Given a left $(T^{\lambda,N}, 0)$ -module M , we obtain a right $(T^{\lambda,N}, 0)$ -module M^ψ with action given by $m^\psi \cdot r := (-1)^{\text{deg}_h(r) \text{deg}_h(m)} \psi(r) \cdot m$ for $m \in M$ and $r \in T^{\lambda,N}$. Then we define the dg-bifunctor

$$\begin{aligned} (-, -) &: \mathcal{D}_{\text{dg}}(T^{\lambda,N}, 0) \times \mathcal{D}_{\text{dg}}(T^{\lambda,N}, 0) \longrightarrow \mathcal{D}_{\text{dg}}(\mathbb{k}, 0), \\ (W, W') &:= W^\psi \otimes_{(T^{\lambda,N}, 0)}^L W'. \end{aligned}$$

Proposition 4.5. *The dg-bifunctor defined above satisfies:*

- $((T_0^{\lambda, \underline{N}}, d_N), (T_0^{\lambda, \underline{N}}, d_N)) \cong (\mathbb{k}, 0)$;
- $(\text{Ind}_b^{b+1} M, M') \cong (M, \text{Res}_b^{b+1} M')$ for all $M, M' \in \mathcal{D}_{\text{dg}}(T^{\lambda, \underline{N}}, 0)$;
- $(\bigoplus_f M, M') \cong (M, \bigoplus_f M') \cong \bigoplus_f (M, M')$ for all $f \in \mathbb{Z}((q, \lambda))$;
- $(M, M') \cong (\mathfrak{J}(M), \mathfrak{J}(M'))$.

Proof. Straightforward, except for the last point which follows from Proposition 4.4, together with the adjunction $\mathfrak{J} \vdash \bar{\mathfrak{J}}$. □

Comparing Proposition 4.5 to §2.1.6, we deduce that $(-, -)$ has the same properties on the asymptotic Grothendieck group of $(T^{\lambda, r}, 0)$ as the Shapovalov form on $M \otimes V^r$.

4.2.2. The categorification theorem. Let $E := \bigoplus_{b \geq 0} E_b$ and $F := \bigoplus_{b \geq 0} F_b$. By Theorem 4.1 and Proposition B.7, we know that ${}_{\mathbb{Q}}\mathbf{K}_0^\Delta(T^{\lambda, \underline{N}}, 0)$ is an $U_q(\mathfrak{sl}_2)$ -module, with action given by the pair $[F], [E]$.

Lemma 4.6. *We have*

$$\dim_{\mathbb{Q}((q, \lambda))}({}_{\mathbb{Q}}\mathbf{K}_0^\Delta(T_b^{\lambda, \underline{N}}, 0)) \leq \dim_{\mathbb{Q}((q, \lambda))}(M(\lambda) \otimes V(\underline{N})_{\lambda q^r - 2b}).$$

Moreover, ${}_{\mathbb{Q}}\mathbf{K}_0^\Delta(T^{\lambda, \underline{N}}, 0)$ is spanned by the classes $\{[P_\rho]\}_{\rho \in \mathcal{P}_b^r, \bar{N}}$.

Proof. It is well known (see for example [36, Lemma 7.2]) that whenever $k > n$, then the unit element in NH_k can be rewritten as a combination of elements having n consecutive dots somewhere on the left-most strand. Thus, for any $\rho' \in \mathcal{P}_b^r$, we obtain that $1_{\rho'}$ can be rewritten as a combination of elements factorizing through elements in $\{1_\rho\}_{\rho \in \mathcal{P}_b^r, \bar{N}}$. □

We consider $M(\lambda) \otimes V(\underline{N})$ over the ground ring $\mathbb{Q}((q, \lambda))$ instead of $\mathbb{Q}(q, \lambda)$.

Theorem 4.7. *There are isomorphisms of $U_q(\mathfrak{sl}_2)$ -modules*

$${}_{\mathbb{Q}}\mathbf{K}_0^\Delta(T^{\lambda, \underline{N}}, 0) \cong M(\lambda) \otimes V(\underline{N}),$$

and

$${}_{\mathbb{Q}}\mathbf{K}_0^\Delta(T^{\lambda, \underline{N}}, d_N) \cong V(N) \otimes V(\underline{N}),$$

for all $N \in \mathbb{N}$.

Proof. We have a $\mathbb{Q}((q, \lambda))$ -linear map

$$M(\lambda) \otimes V(\underline{N}) \longrightarrow {}_{\mathbb{Q}}\mathbf{K}_0^\Delta(T^{\lambda, \underline{N}}, 0), \quad v_\rho \longmapsto [P_\rho].$$

By Lemma 4.6, this map is surjective. It commutes with the action of $K^{\pm 1}$ and E because of Corollary 3.12. By Proposition 4.5, the map intertwines the Shapovalov form with the bilinear form induced by the bifunctor $(-, -)$ on ${}_{\mathbb{Q}}\mathbf{K}_0^\Delta(T^{\lambda, \underline{N}}, 0)$. Thus, it is a $\mathbb{Q}((q, \lambda))$ -linear isomorphism. Since the map intertwines the Shapovalov form with the bifunctor $(-, -)$, and commutes with the action of E and $K^{\pm 1}$, we deduce by non-degeneracy of the Shapovalov form that it also commutes with the action of F . Thus, it is a map of $U_q(\mathfrak{sl}_2)$ -modules.

The case ${}_{\mathbb{Q}}\mathbf{K}_0^\Delta(T^{\lambda, \underline{N}}, d_N)$ follows from Theorem 3.13 together with [49, Theorem 4.38]. \square

5. Cups, caps and double braiding functors

Throughout this section, we fix $\underline{N} = (1, 1, \dots, 1) \in \mathbb{N}^r$ and write $T^{\lambda, r} := T^{\lambda, \underline{N}}$, and $\otimes_T := \otimes_{(\oplus_{r \geq 0} T^{\lambda, r})}$. Also, when we will talk about (bi)modules, we will generally mean \mathbb{Z}^2 -graded dg-(bi)module, assuming it is clear from the context.

5.1. Cup and cap functors. Following [49, §7] (see also [48, §4.3]), we define the *cup bimodule* B_i for $1 \leq i \leq r + 1$ as the $(T^{\lambda, r+2}, 0)$ - $(T^{\lambda, r}, 0)$ -bimodule generated by the diagrams

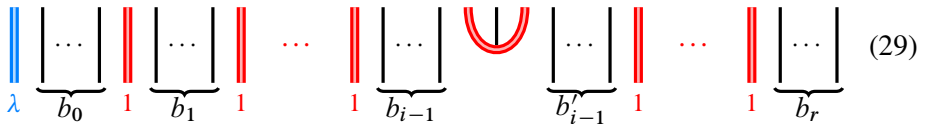

for all $(b_0, \dots, b_{i-2}, b_{i-1}, b'_{i-1}, b_i, \dots, b_r) \in \mathbb{N}^{r+2}$. Here, generated means that elements of B_i are given by taking the diagram above and gluing any diagram of $T^{\lambda, r+2}$ on the top, and any diagram of $T^{\lambda, r}$ on the bottom. The diagrams in B_i are considered up to graded braid-like planar isotopy, with the cup being in homological degree 0, and subject to the same local relations as the dg-enhanced KLRW algebra (20)–(23) and (26), together with the following extra local relations:





We set the \mathbb{Z}^2 -degree of the generator in (29) as

$$\text{deg}_{q,\lambda} \left(\text{cup} \right) := (0, 0).$$

Similarly, we define the *cap bimodule* \bar{B}_i by taking the mirror along the horizontal axis of B_i . However, we declare that the cap is in homological degree -1 , and with \mathbb{Z}^2 -degree given by

$$\text{deg}_{q,\lambda} \left(\text{cap} \right) := (-1, 0).$$

Note that since the red cap has a -1 homological degree, it anticommutes with the nails when applying a graded planar isotopy.

From this, one defines the *coevaluation* and *evaluation dg-functors* as

$$B_i := B_i \otimes_T^L -: \mathcal{D}_{\text{dg}}(T^{\lambda,r}, 0) \longrightarrow \mathcal{D}_{\text{dg}}(T^{\lambda,r+2}, 0),$$

$$\bar{B}_i := \bar{B}_i \otimes_T^L -: \mathcal{D}_{\text{dg}}(T^{\lambda,r+2}, 0) \longrightarrow \mathcal{D}_{\text{dg}}(T^{\lambda,r}, 0).$$

5.1.1. Biadjointness. Note that

$$\bar{B}_i \cong q \text{RHOM}_T(B_i, -)[1],$$

by Proposition 5.1 below. Thus, $q^{-1}\bar{B}_i[-1]$ is right adjoint to B_i . Similarly, we obtain that $q\bar{B}_i[1]$ is left-adjoint to B_i .

The unit and counit of $B_i \dashv q^{-1}\bar{B}_i[-1]$ gives a pair of maps of bimodules

$$\eta_i: q(T^{\lambda,r})[1] \longrightarrow \bar{B}_i \otimes_T^L B_i, \quad \varepsilon_i: B_i \otimes_T^L \bar{B}_i \longrightarrow q(T^{\lambda,r})[1],$$

and similarly $q\bar{B}_i[1] \dashv B_i$ gives

$$\bar{\eta}_i: q^{-1}(T^{\lambda,r})[-1] \longrightarrow B_i \otimes_T^L \bar{B}_i, \quad \bar{\varepsilon}_i: \bar{B}_i \otimes_T^L B_i \longrightarrow q^{-1}(T^{\lambda,r})[-1].$$

5.1.2. Tightened basis. Take $\kappa = (b_0, \dots, b_{r+2}) \in \mathcal{P}_b^{r+2}$ and $\rho \in \mathcal{P}_b^r$. Let $\bar{\kappa}^i$ be given by $(b_0, b_1, \dots, b_{i-2}, b_{i-1} + b_i - 1 + b_{i+1}, \hat{b}_i, \hat{b}_{i+1}, b_{i+2}, \dots, b_r) \in \mathcal{P}_b^r$. For each $1 \leq i \leq b_i$, consider the map

$$g_\ell: q^{b_i+1-2\ell}(1_{\bar{\kappa}^i} T^{\lambda,r} 1_\rho) \longrightarrow 1_\kappa B_i 1_\rho,$$

given by gluing on the top the following element:

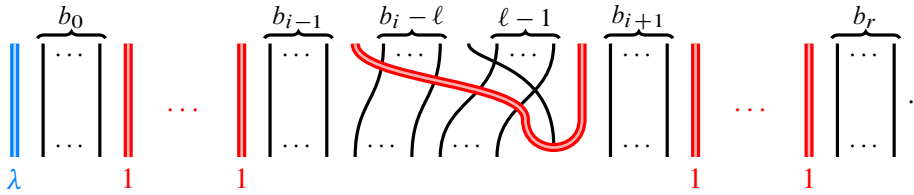

Recall the basis ${}_{\kappa} B_{\rho}$ of Theorem 3.11. We claim that

$$\bigsqcup_{\ell=1}^{b_i} g^{\ell}({}_{\kappa} B_{\rho}), \tag{32}$$

is a basis for $1_{\kappa} B_i 1_{\rho}$. We postpone the proof of this for later.

5.2. Cofibrant replacement of B_i . As explained in [48, §4.3], B_i admits an easily describable cofibrant replacement as a left module. But before describing it, let us introduce some extra notations. Let $T_{i, \parallel \parallel}$ be the left $(T^{\lambda, r}, 0)$ -module generated by the elements

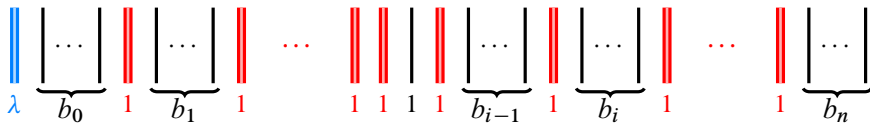

for all (b_0, b_1, \dots, b_r) . We define similarly $T_{i, | \parallel \parallel}$ and $T_{i, \parallel \parallel |}$.

Let $\mathbf{p}B_i$ be the left $(T^{\lambda, r+2}, 0)$ -module given by the dg-module

$$\mathbf{p}B_i := q^2(T_{i, \parallel \parallel})[2] \begin{matrix} \nearrow \text{X} \parallel q(T_{i, | \parallel \parallel})[1] \searrow \text{X} \parallel \\ \oplus \\ \searrow \parallel \text{X} q(T_{i, \parallel \parallel |})[1] \nearrow \parallel \text{X} \end{matrix} T_{i, \parallel \parallel}$$

where the differential is given by the arrows, which are the maps given by adding the term in the label at the bottom of $\parallel \parallel$, $\parallel \parallel |$ or $| \parallel \parallel$. Similarly, we define a right cofibrant replacement $\bar{B}_i \mathbf{q} \xrightarrow{\cong} \bar{B}_i$ by taking the symmetric along the horizontal line and shifting everything by $q^{-1}(-)[-1]$.

Proposition 5.1. *There is a surjective quasi-isomorphism of left \mathbb{Z}^2 -graded $(T^{\lambda, r+2}, 0)$ -modules*

$$\mathbf{p}B_i \xrightarrow{\cong} B_i.$$

Proof. Consider the surjective map $T_{i, \parallel | \parallel} \twoheadrightarrow B_i$ that closes the elements $\parallel | \parallel$ at the bottom by a cup:



This map is indeed surjective since any black strand going to the left of the cap factors through a black strand going to the right, using (31). Then the claim follows by observing that

$$0 \longrightarrow q^2 T_{i, \parallel | \parallel} \begin{matrix} \nearrow \text{ (crossing) } \\ \searrow \text{ (crossing) } \end{matrix} \begin{matrix} q T_{i, | \parallel \parallel} \\ \oplus \\ q T_{i, \parallel \parallel |} \end{matrix} \begin{matrix} \searrow \text{ (crossing) } \\ \nearrow \text{ (crossing) } \end{matrix} T_{i, \parallel | \parallel} \xrightarrow{\text{cup}} B_i \longrightarrow 0$$

is an exact sequence.

Indeed, by Theorem 3.11, we know that adding a black/red crossing is an injective operation, and thus the sequence is exact on $q^2 T_{i, \parallel | \parallel}$. For the same reason we also have that

$$\ker \left(\begin{matrix} q T_{i, | \parallel \parallel} \\ \oplus \\ q T_{i, \parallel \parallel |} \end{matrix} \begin{matrix} \searrow \text{ (crossing) } \\ \nearrow \text{ (crossing) } \end{matrix} T_{i, \parallel | \parallel} \right) \cong T_{i, \times \parallel} \cap T_{i, \parallel \times}$$

By Theorem 3.11, we know that if an element can be written as a diagram with a black strand crossing a red strand on the left, and as a different diagram with the same black strand crossing a red strand on the right, then it can be rewritten as a diagram with the same strand going straight, but carrying a dot. These elements correspond exactly with the image of the preceding map in the complex, which is thus exact at the second position. Finally, we observe that

$$B_i \cong T_{i, \parallel | \parallel} / (T_{i, \times \parallel} + T_{i, \parallel \times}),$$

by constructing an inverse of the map that adds a cup on the bottom, by pulling the cup to the bottom. It is not hard, but a bit lengthy, to check that it respects the defining relations of B_i in the quotient $T_{i, \parallel | \parallel} / (T_{i, \times \parallel} + T_{i, \parallel \times})$. \square

Corollary 5.2. *The elements in (32) form a $\mathbb{Z} \times \mathbb{Z}^2$ -graded \mathbb{k} -basis for $1_\kappa B_i 1_\rho$.*

Proof. As in Theorem 3.11, one can show that the elements in (32) span the space $1_\kappa B_i 1_\rho$, mainly using (31) and (23). Linear independence follows from a dimensional argument, using Proposition 5.1 and Theorem 3.11. The computation of the dimensions can be done at the non-categorified level, and thus is a consequence of (10) of Lemma 2.4. \square

Therefore, the map $\sum g_\ell: \bigoplus_{\ell=1}^{b_i} q^{b_i+1-2\ell} (1_{\bar{\rho}^i} T^{\lambda,r}) \xrightarrow{\cong} 1_\rho B_i$ of right modules is an isomorphism, where $\bar{\rho}^i$ and g_ℓ are as in §5.1.2. In particular, B_i is a cofibrant right dg-module.

With Theorem 4.7 in mind, this means that \bar{B}_i acts on ${}_{\mathbb{Q}}\mathbf{K}_0^\Delta(T^{\lambda,N}, 0)$ as the cap of \mathcal{B} on $M \otimes V^r$ (see (10)), and Proposition 5.1 means that B_i acts as the cup (see (11)).

5.3. Double braiding functor. Inspired by the definition of the braiding functor in [49, §6] (see also [48, §4.1]), we introduce a double braiding functor that will play the role of a categorification of the action of ξ on $M \otimes V^r$.

Definition 5.3. The *double braiding bimodule* X (see Remark 2.2 for an explanation about the terminology) is the $(T^{\lambda,r}, 0)$ - $(T^{\lambda,r}, 0)$ -bimodule generated by the diagrams

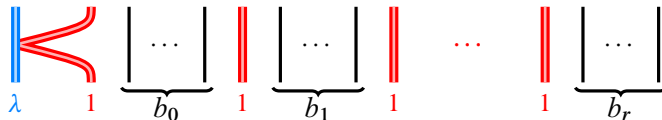

for all $(b_0, \dots, b_r) \in \mathbb{N}^{r+1}$. We consider diagrams in X up to graded braid-like planar isotopy with the generators being in homological degree 0, and subject to the relations(20)-(23) and (26), and the extra local relations

We set the \mathbb{Z}^2 -degree of the generator as

$$\text{deg}_{q,\lambda} \left(\begin{array}{c} \text{Diagram} \\ \lambda \quad 1 \end{array} \right) := (0, -1).$$

We define the *double braiding functor* as

$$\Xi := X \otimes_T^{\underline{l}} -: \mathcal{D}_{\text{dg}}(T^{\lambda,r}, 0) \longrightarrow \mathcal{D}_{\text{dg}}(T^{\lambda,r}, 0).$$

5.3.1. Tightened basis. Let us now describe a basis of the bimodule X , similar to the basis of $T_b^{\lambda,r}$ given in Theorem 3.11. We fix κ and ρ two elements of \mathcal{P}_b^r and recall the set ${}_{\kappa}S_{\rho}$ defined in §3.3.3. For each $w \in {}_{\kappa}S_{\rho}$, $\underline{l} = (l_1, \dots, l_b) \in \{0, 1\}^b$ and $\underline{a} = (a_1, \dots, a_b) \in \mathbb{N}^b$ we define an element $x_{w,\underline{l},\underline{a}} \in 1_{\kappa}X1_{\rho}$ as follows:

- (1) choose a left-reduced expression of w in terms of diagrams as above,
- (2) for each $1 \leq i \leq b$, if $l_i = 1$, nail the i -th black strand (counting on the top from the left) on the blue strand by pulling it from its leftmost position,
- (3) for each $1 \leq i \leq b$, add a_i dots on the i -th black strand at the top,
- (4) finally, attach the first red strand to the blue strand by pulling it from its leftmost position.

Definition 5.4. Define the *unbraiding map*

$$u: \lambda X \longrightarrow T^{\lambda,r},$$

as the map given by removing the double braiding

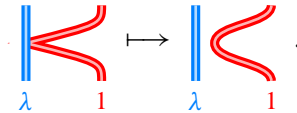

Note that the unbraiding map is a map of $(T_b^{\lambda,r}, 0)$ - $(T_b^{\lambda,r}, 0)$ -bimodules.

Theorem 5.5. *The set $\{x_{w,\underline{l},\underline{a}} : w \in {}_{\kappa}S_{\rho}, \underline{l} \in \{0, 1\}^b, \underline{a} \in \mathbb{N}^b\}$ is a $\mathbb{Z} \times \mathbb{Z}^2$ -graded \mathbb{k} -basis of $1_{\kappa}X1_{\rho}$.*

Proof. Showing that this set generates $1_{\kappa}X1_{\rho}$ is similar to [34, Proposition 3.13] and we leave the details to the reader.

To show that the elements $(x_{w,\underline{l},\underline{a}})_{w,\underline{l},\underline{a}}$ are linearly independent we consider a linear combination $\sum_{w,\underline{l},\underline{a}} \alpha_{w,\underline{l},\underline{a}} x_{w,\underline{l},\underline{a}} = 0$ and apply the unbraiding map u . We now pull the first red strand to its original position before the last step of the construction of $x_{w,\underline{l},\underline{a}}$. This has the effect of adding dots on some black strands because of (21).

We now rewrite $u(\sum_{w,\underline{l},\underline{a}} \alpha_{w,\underline{l},\underline{a}} x_{w,\underline{l},\underline{a}}) = 0$ in terms of the tightened basis of $T_b^{\lambda,r}$. We carefully look at the terms with the highest number of crossings:

We write

$$\begin{aligned}
 X_k &:= \bigoplus_{\ell \geq 0, \rho \in \mathcal{P}_b^{r-2}} X_{k,\ell,\rho}, \\
 Y_k^1 &:= \bigoplus_{\ell \geq 0, \rho \in \mathcal{P}_b^{r-2}} Y_{k,\ell,\rho}^1, \\
 Y_k^0 &:= \bigoplus_{\ell \geq 0, \rho \in \mathcal{P}_b^{r-2}} Y_{k,\ell,\rho}^0,
 \end{aligned}$$

and similarly for $Y_k^{1,t}$, $Y_k^{\prime 0}$ and $Y_k^{0,t}$.

Define the cofibrant $(T_b^{\lambda,r}, 0)$ -module $\mathbf{p}X_k$ given by the mapping cone

$$\mathbf{p}X_k := \text{Cone}(Y_k^1 \xrightarrow{\iota_k} Y_k^0),$$

where $\iota_k := \sum_{t=0}^{k-1} \iota_k^t$ for

$$\iota_k^t: Y_k^{1,t} \longrightarrow Y_k^{\prime 0} \oplus Y_k^{0,t},$$

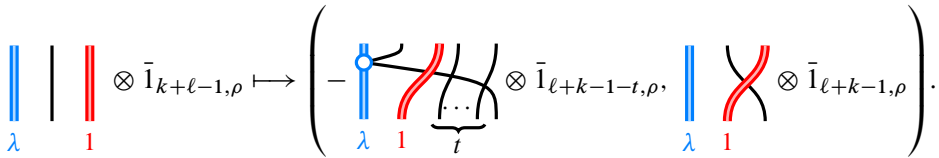

Note that each ι_k^t is injective, and therefore so is ι_k . Then, consider the left module map

$$\gamma_k: \mathbf{p}X_k \longrightarrow X_k,$$

given by $\gamma_k := \gamma'_k + \sum_{t=0}^{k-1} \gamma_k^t$ where

$$\gamma'_k: Y_k^{\prime 0} \longrightarrow X_k,$$

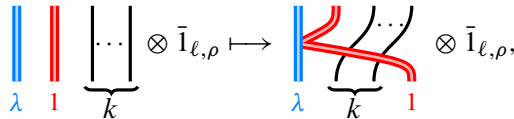

and

$$\gamma_k^t: Y_k^{0,t} \longrightarrow X_k,$$

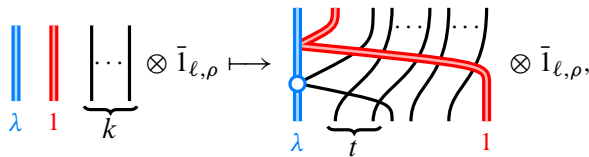

for all $0 \leq t \leq k - 1$.

Lemma 5.7. *The map $\gamma_k: \mathbf{p}X_k \rightarrow X_k$ is surjective.*

Proof. The statement can be proved by observing that X_k is generated as a left $(T_b^{\lambda,r}, 0)$ -module by the elements

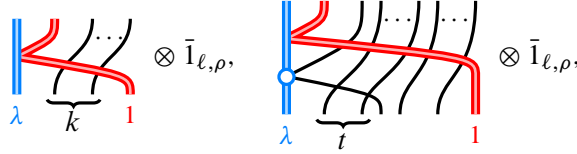

for all $0 \leq t \leq k - 1$. The details can be found in §A.2. □

Lemma 5.8. *The sequence*

$$0 \longrightarrow Y_k^1 \xrightarrow{\iota_k} Y_k^0 \xrightarrow{\gamma_k} X_k \longrightarrow 0,$$

is a short exact sequence of left \mathbb{Z}^2 -graded $(T^{\lambda,r}, 0)$ -modules.

Proof. Since we already have a complex with an injection and a surjection, it is enough to show that

$$\text{gdim } X_k = \text{gdim } Y_k^0 - \text{gdim } Y_k^1,$$

where gdim is the graded dimension in the form of a Laurent series belonging to $\mathbb{N}[[h^{\pm 1}, \lambda^{\pm 1}, q^{\pm 1}]]$. This can be shown by induction on k , and the details are in §A.2. □

From that, we induce a right $(T^{\lambda,r}, 0)$ - A_∞ -action on $\mathbf{p}X := \bigoplus_{k \geq 0} \mathbf{p}X_k$ (see §B.1.3), turning it into a \mathbb{Z}^2 -graded $(T^{\lambda,r}, 0)$ - $(T^{\lambda,r}, 0)$ - A_∞ -bimodule, and we obtain:

Proposition 5.9. *The map $\gamma := \sum_{k \geq 0} \gamma_k: \mathbf{p}X \twoheadrightarrow X$ is a quasi-isomorphism of \mathbb{Z}^2 -graded $(T^{\lambda,r}, 0)$ - $(T^{\lambda,r}, 0)$ - A_∞ -bimodules.*

Proof. It is an immediate consequence of Lemma 5.8. □

Again, having Theorem 4.7 in mind, it means Ξ acts on ${}_{\mathbb{Q}}\mathbf{K}_0^\Delta(T^{\lambda,N}, 0)$ as the element ξ of \mathcal{B} on $M \otimes V^r$ (see (12)).

6. A categorification of the blob algebra

As in [49, §7], the cup and cap functors respect a categorical instance of the Temperley–Lieb algebra relations (3)–(6). We additionally show that the double braiding functor respects a categorical version of the blob relations (8) and (9). Note that Webster also proves that the cup and cap functors intertwine the categorical $U_q(\mathfrak{sl}_2)$ -action, which categorifies the fact that the Temperley–Lieb algebra describes morphisms of $U_q(\mathfrak{sl}_2)$ -modules. We start by proving the same for these functors in the dg-setting as well as for the double braiding functors:

Proposition 6.1. *We have natural isomorphisms $E \circ \Xi \cong \Xi \circ E$ and $F \circ \Xi \cong \Xi \circ F$, and also $E \circ B_i \cong B_i \circ E$, $F \circ B_i \cong B_i \circ F$, and similarly for \bar{B}_i .*

Proof. Since E and F are given by derived tensor product with a dg-bimodule that is cofibrant both as left and as right module, all compositions are given by usual tensor product of dg-bimodules. Then, the first isomorphism is equivalent to

$$1_{b,1}(T_{b+1}^{\lambda,r}) \otimes_{b+1} X_{b+1} \cong X_b \otimes_b 1_{b,1}(T_{b+1}^{\lambda,r}),$$

which in turn follows from Theorem 5.5 and Corollary 3.12. The case with F is identical, and so is the proof for B_i using Corollary 5.2. \square

Then, we use all this to show that compositions of the functors B_i, \bar{B}_i and Ξ realize a categorification of \mathcal{B} .

6.1. Temperley–Lieb relations. This section is an extension of Webster’s results [49, §7] for the dg-enhanced KLRW algebra $T^{\lambda,r}$.

Proposition 6.2. *There is an isomorphism*

$$\bar{B}_{i\pm 1} \otimes_T^L B_i \cong T^{\lambda,r},$$

of \mathbb{Z}^2 -graded $(T^{\lambda,r}, 0)$ - $(T^{\lambda,r}, 0)$ - A_∞ -bimodules.

Proof. We prove $\bar{B}_{i-1} \otimes_T^L B_i \cong T^{\lambda,r}$, the other case follows similarly. Using Proposition 6.1 and the fact that $B_i \circ \mathcal{J} \cong \mathcal{J} \circ B_i$ for $i < r - 1$ (where we recall \mathcal{J} is the induction along a red strand defined in §4.1.2), we can work locally, supposing

that $i = r - 1$ and $b_i = 0$. Then, we have that $\bar{B}_{i-1} \otimes_T \mathbf{p}B_i$ looks like

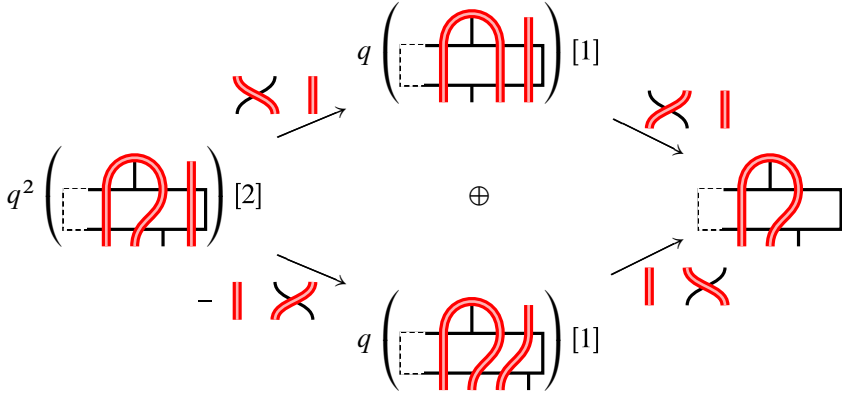

which is isomorphic to

$$\begin{array}{ccc}
 & T^{\lambda,r} & \\
 0 & \begin{array}{c} \nearrow \\ \oplus \\ \searrow \end{array} & 0 \\
 & 0 &
 \end{array}$$

because of (30). Note that it is an isomorphism of dg-bimodules, since all the higher composition maps of the A_∞ -structure must be zero by degree reasons, concluding the proof. \square

Corollary 6.3. *There is a natural isomorphism $\bar{B}_{i\pm 1} \circ B_i \cong \text{Id}$.*

Proposition 6.4. *There is a distinguished triangle*

$$q(T^{\lambda,r})[1] \xrightarrow{\eta_i} \bar{B}_i \otimes_T^L B_i \xrightarrow{\bar{\varepsilon}_i} q^{-1}(T^{\lambda,r})[-1] \xrightarrow{0}$$

of \mathbb{Z}^2 -graded $(T^{\lambda,r}, 0)$ - $(T^{\lambda,r}, 0)$ - A_∞ -bimodules.

Proof. We have

$$\bar{B}_i \otimes_T^L B_i \cong \bar{B}_i \mathbf{q} \otimes_T B_i,$$

which looks like

$$\begin{array}{ccc}
 & 0 & \\
 q(B_i \parallel \parallel)[1] & \begin{array}{c} \nearrow \\ \oplus \\ \searrow \end{array} & q^{-1}(B_i \parallel \parallel)[-1] \\
 & 0 &
 \end{array}$$

Thus, since $B_i^{\parallel \mid \parallel} \cong T^{\lambda,r}$, we have that

$$H(\bar{B}_i \otimes_T^L B_i) \cong q(T^{\lambda,r})[1] \oplus q^{-1}(T^{\lambda,r})[-1].$$

In order to compute η_i , recall (or see §B.3.1) that the unit of the adjunction $(B_i \otimes_T^L -) \vdash (\text{RHOM}_T(B_i, -))$ is given by

$$\begin{aligned} \eta'_i: T^{\lambda,r} &\longrightarrow \text{RHOM}_T(B_i, B_i \otimes_T^L T^{\lambda,r}) \cong \text{HOM}_T(\mathbf{p}B_i, B_i), \\ t &\longmapsto [x \longmapsto \bar{x} \cdot t], \end{aligned}$$

where \bar{x} is the image of x under the map $\mathbf{p}B_i \twoheadrightarrow B_i$. Moreover, $\text{HOM}_T(\mathbf{p}B_i, B_i)$ is given by

$$\begin{array}{ccc} & 0 & \\ & \swarrow & \searrow \\ q^{-2} \text{HOM}_T(T_{i, \parallel \mid \parallel}, B_i)[-2] & \oplus & \text{HOM}(T_{i, \parallel \mid \parallel}, B_i) \\ & \swarrow & \searrow \\ & 0 & \end{array}$$

and then, η'_i is the map $T^{\lambda,r} \xrightarrow{\cong} \text{HOM}(T_{i, \parallel \mid \parallel}, B_i) \cong B_i^{\parallel \mid \parallel}$ that adds a cup on the top. Thus, η_i identifies $q(T^{\lambda,r})[1]$ with $q(B_i^{\parallel \mid \parallel})[1] \subset H(\bar{B}_i \otimes_T^L B_i)$ in homology. Similarly, the counit of the adjunction $(\bar{B}_i \otimes_T^L -) \vdash (\text{RHOM}_T(\bar{B}_i, -))$ is

$$\begin{aligned} \bar{\varepsilon}': \bar{B}_i \otimes_T^L \text{RHOM}_T(\bar{B}_i, T^{\lambda,r}) &\cong \bar{B}_i \mathbf{q} \otimes_T \text{HOM}_T(\bar{B}_i, T^{\lambda,r}) \longrightarrow T^{\lambda,r}, \\ t \otimes f &\longmapsto f(\bar{t}). \end{aligned}$$

Then, we obtain that $\bar{B}_i \mathbf{q} \otimes_T \text{HOM}_T(\bar{B}_i, T^{\lambda,r})$ is isomorphic to

$$\begin{array}{ccc} & 0 & \\ & \swarrow & \searrow \\ q^2(B_i^{\parallel \mid \parallel})[2] & \oplus & B_i^{\parallel \mid \parallel} \\ & \swarrow & \searrow \\ & 0 & \end{array}$$

and thus, $\bar{\varepsilon}'$ is the isomorphism

$$B_i^{\parallel \mid \parallel} \xrightarrow{\cong} T^{\lambda,r}.$$

Therefore, $\bar{\varepsilon}$ identifies $q^{-1}(T^{\lambda,r})[-1]$ with $q^{-1}(B_i^{\parallel \mid \parallel})[-1] \subset H(\bar{B}_i \otimes_T^L B_i)$ in homology. □

Also define a map of left modules

$$\varphi_k^0: \bigoplus_{\ell, \rho} q^2(T_b^{\lambda, r} 1_{k, \ell, \rho})[1] \longrightarrow X \otimes_T Y_k^0,$$

as $\varphi_k^0 := \varphi_k^{0'} + \sum_{t=0}^{k-1} \varphi_k^{0, t}$, where each

$$\varphi_k^{0'}: \bigoplus_{\ell, \rho} q^2(T_b^{\lambda, r} 1_{k, \ell, \rho})[1] \longrightarrow X \otimes_T Y_k^{0'} \left(\cong \bigoplus_{\ell, \rho} \lambda^{-1} q^k(X 1_{0, k+\ell, \rho}) \right),$$

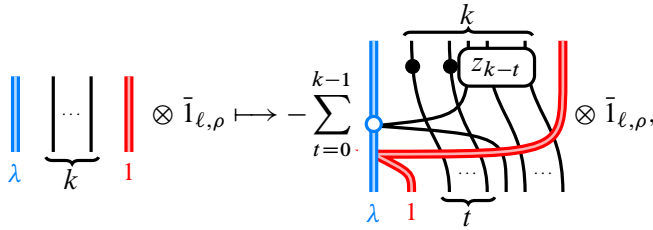

and where

$$\varphi_k^{0, t}: \bigoplus_{\ell, \rho} q^2(T_b^{\lambda, r} 1_{k, \ell, \rho})[1] \longrightarrow X \otimes_T Y_k^{0, t} \left(\cong \bigoplus_{\ell, \rho} \lambda q^{k-2t}(X 1_{0, k+\ell, \rho})[1] \right),$$

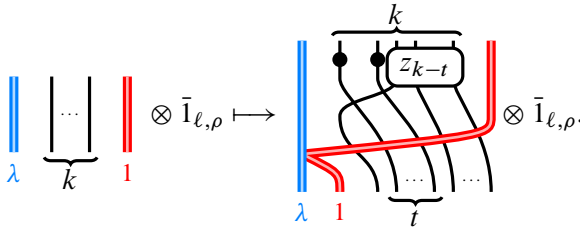

Recall that the unbraiding map (Definition 5.4)

$$u: \lambda X \hookrightarrow T_b^{\lambda, r},$$

is given by

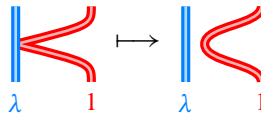

Lemma 6.6. *The diagram*

$$\begin{array}{ccccc} X \otimes_T Y_k^1 & \xleftarrow{1 \otimes i_k} & X \otimes_T Y_k^0 & \xrightarrow{u \otimes \gamma_k} & \lambda^{-1} X \\ \varphi_k^1 \uparrow & & \varphi_k^0 \uparrow & & \uparrow \\ \lambda q^2(X_k)[1] & \xleftarrow{u} & \bigoplus_{\ell, \rho} q^2(T_b^{\lambda, r} 1_{k, \ell, \rho})[1] & \longrightarrow & 0 \end{array}$$

commutes.

Proof. The proof is a straightforward computation using (20) and (22) together with (33). We leave the details to the reader. \square

Thus, there is an induced map

$$\begin{aligned} \varphi_k: \text{Cone}(\lambda q^2(X_k)[1]) &\xrightarrow{u} \bigoplus_{\ell, \rho} q^2(T_b^{\lambda, r} 1_{k, \ell, \rho}[1])[1] \\ &\longrightarrow \text{Cone}(X \otimes_T^L X_k \xrightarrow{1 \otimes u} \lambda^{-1} X_k), \end{aligned}$$

as left modules.

Theorem 6.7. *The map*

$$\begin{aligned} \varphi := \sum_{k=0}^m (-1)^k \varphi_k: \text{Cone}(\lambda q^2 X[1]) &\xrightarrow{u} q^2 T_b^{\lambda, r} [1][1] \\ &\longrightarrow \text{Cone}(X \otimes_T^L X \xrightarrow{1 \otimes u} \lambda^{-1} X), \end{aligned}$$

is a quasi-isomorphism.

Proof. The statement can be proven by showing that $\text{Cone}(\varphi)$ has a trivial homology, and thus is acyclic. This is done in details in §A.3.1. \square

The next step is to prove that φ defines a map of A_∞ -bimodules. Luckily, by the following proposition, we do not need to use any A_∞ -structure here.

Proposition 6.8. *The map*

$$X \otimes_T \mathbf{p}X \xrightarrow{1 \otimes \gamma} X \otimes_T X,$$

is a quasi-isomorphism of A_∞ -bimodules.

Proof. Tensoring to the left is a right-exact functor, thus Lemma 5.8 gives us an exact sequence

$$X \otimes_T Y_k^1 \xrightarrow{1 \otimes \iota_k} X \otimes_T Y_k^0 \xrightarrow{1 \otimes \gamma_k} X_k \longrightarrow 0.$$

It is not hard to see that $1 \otimes \iota_k$ is injective, and thus we have a short exact sequence

$$0 \longrightarrow X \otimes_T Y_k^1 \xrightarrow{1 \otimes \iota} X \otimes_T Y_k^0 \xrightarrow{1 \otimes \gamma_k} X_k \longrightarrow 0,$$

so that $1 \otimes \gamma_k$ is a quasi-isomorphism. \square

Taking a mapping cone preserves quasi-isomorphisms. Thus, we have a quasi-isomorphism

$$\text{Cone}(X \otimes_T^L X \xrightarrow{1 \otimes u} \lambda^{-1} X) \xrightarrow{\cong} \text{Cone}(X \otimes_T X \xrightarrow{1 \otimes u} \lambda^{-1} X). \quad (36)$$

Let

$$\tilde{\varphi}: \text{Cone}(\lambda q^2 X[1] \xrightarrow{u} q^2 T_b^{\lambda,r}[1])[1] \longrightarrow \text{Cone}(X \otimes_T X \xrightarrow{1 \otimes u} \lambda^{-1} X)$$

be the map given by composing φ with the quasi-isomorphism in (36). We also write $\tilde{\varphi}^0 := (1 \otimes \gamma) \circ \varphi^0$. Therefore, by Lemma B.3, proving that φ is a map of A_∞ -bimodules ends up being the same as proving that $\tilde{\varphi}^0$ is a map of dg-bimodules.

Theorem 6.9. *The map φ is a map of \mathbb{Z}^2 -graded $(T^{\lambda,r}, 0)$ - $(T^{\lambda,r}, 0)$ - A_∞ -bimodules.*

Proof. The statement follows by proving that $\tilde{\varphi}^0$ is a map of dg-bimodules, which is done in details in §A.3.2. □

Corollary 6.10. *There is an exact sequence*

$$0 \longrightarrow \lambda q^2(X)[1] \xrightarrow{u} q^2(T_b^{\lambda,r}[1]) \xrightarrow{\tilde{\varphi}^0} X \otimes_T X \xrightarrow{1 \otimes u} \lambda^{-1} X \longrightarrow 0,$$

of dg-bimodules.

Corollary 6.11. *There is a quasi-isomorphism*

$$\text{Cone}(\lambda q^2 \Xi[1] \longrightarrow q^2 \text{Id}[1])[1] \xrightarrow{\cong} \text{Cone}(\Xi \circ \Xi \longrightarrow \lambda^{-1} \Xi),$$

of dg-functors.

6.2.2. Inverse of Ξ . Recall the notations from §5.4.

Lemma 6.12. *As a right $(T^{\lambda,r}, 0)$ -module, $1_{1,k+\ell-1,\rho} X$ is generated by the elements*

$$\begin{array}{c} \text{Diagram 1} \end{array} \otimes \bar{1}_{\ell,\rho} \quad \text{and} \quad \begin{array}{c} \text{Diagram 2} \end{array} \otimes \bar{1}_{\ell+k-1,\rho}. \quad (37)$$

Proof. The statement can be proven using an induction on k , as done in details in §A.3. □

Lemma 6.13. *The map*

$$(- \circ \iota_k): \text{HOM}_T(Y_k^0, X) \longrightarrow \text{HOM}_T(Y_k^1, X),$$

is surjective.

Proof. We have

$$\begin{aligned} \text{HOM}_T(Y_k^0, X) &\cong \bigoplus_{\ell, \rho} \left(\lambda q^{-k} (1_{0, k+\ell, \rho} X) \oplus \bigoplus_{t=0}^{k-1} \lambda^{-1} q^{-(k-2t)} (1_{0, k+\ell, \rho} X)[-1] \right), \\ \text{HOM}_T(Y_k^1, X) &\cong \bigoplus_{\ell, \rho} \left(\bigoplus_{t=0}^{k-1} \lambda^{-1} q^{-(k-2t+1)} (1_{1, k+\ell-1, \rho} X)[-1] \right). \end{aligned}$$

Then, the map

$$\begin{aligned} (- \circ \iota_k): \lambda q^{-k} (1_{0, k+\ell, \rho} X) \oplus \lambda^{-1} q^{-(k-2t)} (1_{0, k+\ell, \rho} X)[-1] \\ \longrightarrow \lambda^{-1} q^{-(k-2t+1)} (1_{1, k+\ell-1, \rho} X)[-1] \end{aligned}$$

is given by gluing

$$\left(\begin{array}{c} \text{Diagram 1} \\ \otimes \bar{1}_{\ell+k-1-t, \rho} \end{array}, \begin{array}{c} \text{Diagram 2} \\ \otimes \bar{1}_{\ell+k-1, \rho} \end{array} \right)$$

on the top of diagrams, for all $0 \leq t \leq k - 1$.

Then we observe that the map

$$(- \circ \iota_k): \lambda q^{-k} (1_{0, k+\ell, \rho} X) \longrightarrow \lambda^{-1} q^{-(k-2t+1)} (1_{1, k+\ell-1, \rho} X)[-1]$$

sends

$$\left(\begin{array}{c} \text{Diagram 3} \\ \otimes \bar{1}_{\ell, \rho} \end{array}, \mapsto \begin{cases} 0 & \text{if } s < t, \\ \text{Diagram 4} \otimes \bar{1}_{\ell, \rho} & \text{if } s = t, \\ \text{Diagram 5} \otimes \bar{1}_{\ell, \rho} & \text{if } s > t, \end{cases} \right)$$

for all $0 \leq s \leq k - 1$. Thus, $(- \circ l_k): \text{HOM}_T(Y_k^0, X) \twoheadrightarrow \text{HOM}_T(Y_k^1, X)$ has a triangular form when applied to the elements above, and is surjective by Lemma 6.13. \square

Proposition 6.14. *The functor*

$$\Xi: \mathcal{D}_{\text{dg}}(T^{\lambda,r}, 0) \longrightarrow \mathcal{D}_{\text{dg}}(T^{\lambda,r}, 0)$$

is an autoequivalence, with inverse given by

$$\Xi^{-1} := \text{RHOM}_T(X, -): \mathcal{D}_{\text{dg}}(T^{\lambda,r}, 0) \longrightarrow \mathcal{D}_{\text{dg}}(T^{\lambda,r}, 0).$$

Proof. By Lemma 6.13 and Proposition 5.9, we have

$$\text{RHOM}_T(X1_\rho, X1_{\rho'}) \cong \text{HOM}_T(X1_\rho, X1_{\rho'}).$$

Then, we compute

$$\text{gdim } \text{HOM}_T(X1_\rho, X1_{\rho'}) = \text{gdim } \text{HOM}_T(\mathbf{P}_\rho, \mathbf{P}_{\rho'}),$$

using the fact that Ξ decategorifies to the action of ξ . More precisely, as in [49, §4.7], the bifunctor $\text{RHOM}_T(-, -)$ decategorifies to a sesquilinear version of the Shapovalov form when restricted to a particular subcategory of $\mathcal{D}_{\text{dg}}(T^{\lambda,r}, 0)$, and this sesquilinear form respects $(\xi w, \xi w') = (w, w')$. Finally, we observe that the map

$$\text{HOM}_T(\mathbf{P}_\rho, \mathbf{P}_{\rho'}) \xrightarrow{\text{Id}_X \otimes (-)} \text{HOM}_T(X1_\rho, X1_{\rho'}),$$

is injective, since the map $\mathbf{P}_\rho \rightarrow X1_\rho$ given by gluing

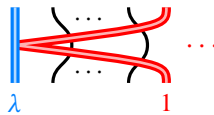

on the top of diagrams is injective. This can be seen by composing the above map $\mathbf{P}_\rho \rightarrow X1_\rho$ with the injection $u: X1_\rho \rightarrow \mathbf{P}_\rho$, and observing it yields an injective map. Therefore, $\text{RHOM}_T(X1_\rho, X1_{\rho'}) \cong {}_1\rho T^{\lambda,r} 1_{\rho'}$, and Ξ is an autoequivalence. \square

6.2.3. Categorification of relation (8)

Lemma 6.15. *There is a quasi-isomorphism*

$$X \otimes_T^{\text{L}} B_1 \cong X \otimes_T \mathbf{p}B_1 \xrightarrow{\cong} X \otimes_T B_1,$$

of A_∞ -bimodules.

Proof. Let us write $X_{\parallel\parallel\parallel} := X \otimes_T T_{1,\parallel\parallel\parallel}$. Then we have

$$X \otimes_T \mathbf{p}B_1 \cong q^2(X_{\parallel\parallel\parallel})[2] \begin{array}{c} \nearrow \\ \searrow \end{array} \begin{array}{c} q(X_{\parallel\parallel\parallel})[1] \\ \oplus \\ q(X_{\parallel\parallel\parallel})[1] \end{array} \begin{array}{c} \searrow \\ \nearrow \end{array} X_{\parallel\parallel\parallel}$$

The statement follows by observing that the first map is injective, and its image coincides with the kernel of the second one. \square

Our goal will be to show the following:

Proposition 6.16. *There is a quasi-isomorphism*

$$\lambda q(T^{\lambda,r})[1] \oplus \lambda^{-1} q^{-1}(T^{\lambda,r})[-1] \xrightarrow{\cong} \bar{B}_1 \otimes_T^L X \otimes_T^L B_1,$$

of A_∞ -bimodules.

For this, we will need to understand the left A_∞ -action on $B_1\mathbf{q}$:

$$B_1\mathbf{q} := q(T^{\parallel\parallel\parallel})[1] \begin{array}{c} \nearrow \\ \searrow \end{array} \begin{array}{c} T^{\parallel\parallel\parallel} \\ \oplus \\ T^{\parallel\parallel\parallel} \end{array} \begin{array}{c} \searrow \\ \nearrow \end{array} q^{-1}(T^{\parallel\parallel\parallel})[-1]$$

We start by constructing a composition map $T \otimes B_1\mathbf{q} \rightarrow B_1\mathbf{q}$, by defining it on each generator of T . We extend it by first rewriting elements in T as basis elements and then applying recursively the definition in terms of generating elements (so that it is well defined). Dots and crossings act on each of the summand by simply adding the three missing vertical strands between the λ -strand and the remaining of the diagram, and gluing on top. For example in $q^{-1}(T^{\parallel\parallel\parallel})[-1]$, we have

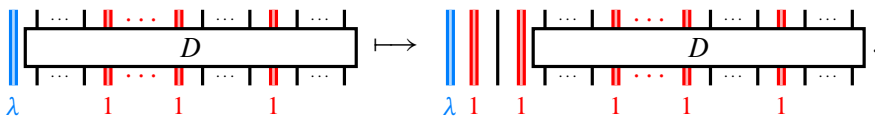

The action of the nail is a bit trickier. On $q(T^{\parallel\parallel\parallel})[1]$ and on $q^{-1}(T^{\parallel\parallel\parallel})[-1]$ it acts by gluing

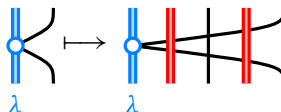

on the top of the diagrams. On $T^{\uparrow} \parallel \parallel$ it acts by

$$\begin{array}{c} \text{Diagram: A blue blob with two strands entering from the left and two exiting to the right. Below it is the symbol } \lambda. \end{array} \mapsto \left(\begin{array}{c} \text{Diagram: Blue blob with two strands, two red vertical lines, and two strands exiting. Below it is } \lambda. \\ \text{Diagram: Blue blob with two strands, two red vertical lines, and two strands exiting. Below it is } \lambda. \\ \text{Diagram: Blue blob with two strands, two red curved lines, and two strands exiting. Below it is } \lambda. \end{array} \right) \in T^{\uparrow} \parallel \parallel \oplus T^{\parallel \parallel \uparrow},$$

and on $T^{\parallel \parallel \uparrow}$ by

$$\begin{array}{c} \text{Diagram: A blue blob with two strands entering from the left and two exiting to the right. Below it is the symbol } \lambda. \end{array} \mapsto \left(\begin{array}{c} \text{Diagram: Blue blob with two strands, two red curved lines, and two strands exiting. Below it is } \lambda. \\ \text{Diagram: Blue blob with two strands, two red vertical lines, and two strands exiting. Below it is } \lambda. \end{array} \right) \in T^{\uparrow} \parallel \parallel \oplus T^{\parallel \parallel \uparrow}.$$

One can easily verify that this respects the differential in $B_1\mathfrak{q}$. The higher multiplication maps $T \otimes B_1\mathfrak{q} \otimes T \rightarrow B_1\mathfrak{q}$ and $T \otimes T \otimes B_1\mathfrak{q}$ compute the defect of the map $T \otimes B_1\mathfrak{q} \rightarrow B_1\mathfrak{q}$ for being a left T -action. Concretely, it means that we can compute these higher multiplication maps by looking how both side of each defining relation of T act on $B_1\mathfrak{q}$.

For example, the relation

$$\begin{array}{c} \text{Diagram: Blue blob with two strands, one black dot on the lower right strand, and one black dot on the lower left strand. Below it is } \lambda. \\ \text{Diagram: Blue blob with two strands, one black dot on the lower right strand, and one black dot on the upper right strand. Below it is } \lambda. \end{array} =$$

is respected on $q^{-1}(T^{\parallel \parallel \uparrow})[-1]$ up to adding the elements appearing in the right of the following equation:

$$\begin{array}{c} \text{Diagram: Blue blob with two strands, two red vertical lines, and one black dot on the lower right strand. Below it is } \lambda. \\ \text{Diagram: Blue blob with two strands, two red vertical lines, and one black dot on the lower right strand. Below it is } \lambda. \\ \text{Diagram: Blue blob with two strands, two red curved lines, and one black dot on the lower right strand. Below it is } \lambda. \\ \text{Diagram: Blue blob with two strands, two red curved lines, and one black dot on the lower right strand. Below it is } \lambda. \end{array} =$$

so that the higher multiplication map $T \otimes T \otimes q^{-1}(T^{\parallel \parallel \uparrow})[-1] \rightarrow B_1\mathfrak{q}$ gives

$$\begin{array}{c} \text{Diagram: Blue blob with two strands, one blue vertical line, and one black dot on the lower right strand. Below it is } \lambda. \\ \text{Diagram: Blue blob with two strands, one blue vertical line, and one black dot on the lower right strand. Below it is } \lambda. \end{array} \otimes \begin{array}{c} \text{Diagram: Blue vertical line. Below it is } \lambda. \\ \text{Diagram: Black dot on a vertical line. Below it is } 1. \end{array} \mapsto \left(\begin{array}{c} \text{Diagram: Blue blob with two strands, two red curved lines, and one black dot on the lower right strand. Below it is } \lambda. \\ \text{Diagram: Blue blob with two strands, two red vertical lines, and one black dot on the lower right strand. Below it is } \lambda. \end{array} \right) \in T^{\uparrow} \parallel \parallel \oplus T^{\parallel \parallel \uparrow}.$$

Note that it means the higher maps only involve elements coming from (26). Also, one can easily verify that the other two relations in (26) are already respected for the multiplication map $T \otimes q^{-1}(T \parallel \mid \parallel)[-1] \rightarrow B_1\mathbf{q}$, so that our computation above completely determine $T \otimes T \otimes q^{-1}(T \parallel \mid \parallel)[-1] \rightarrow B_1\mathbf{q}$. There is a similar higher multiplication map $T \otimes q^{-1}(T \parallel \mid \parallel)[-1] \otimes T \rightarrow B_1\mathbf{q}$, which is non-trivial in the case

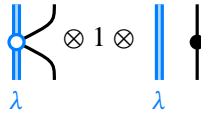

for similar reasons. We will not need to compute the other higher composition maps.

Proof of Proposition 6.16. Tensoring $B_1\mathbf{q}$ with $X \otimes_T B_1$ gives a complex where the elements are locally of the form

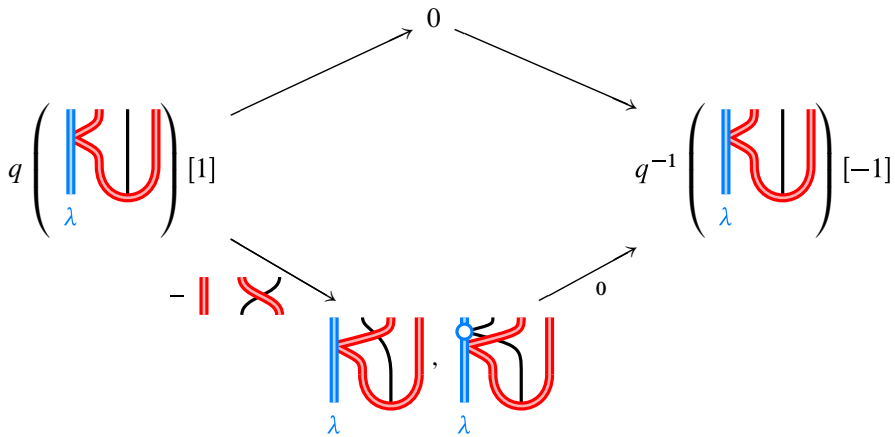

which, after eliminating the acyclic subcomplex, yields

$$\text{blue cup with red U-strand and dot on left, labeled } \lambda \oplus q^{-1} \left(\text{blue cup with red U-strand, labeled } \lambda \right) [-1].$$

All higher multiplications maps vanish: except for $T \otimes T \otimes (B_1\mathbf{q} \otimes_T X \otimes B_1) \rightarrow (B_1\mathbf{q} \otimes_T X \otimes B_1)$ and $T \otimes (B_1\mathbf{q} \otimes_T X \otimes B_1) \otimes T \rightarrow (B_1\mathbf{q} \otimes_T X \otimes B_1)$, all of these are zero for degree reasons, and the remaining two are zero by the calculations above. Therefore, what remains is isomorphic to $\lambda q(T^{\lambda,r})[1] \oplus \lambda^{-1}q^{-1}(T^{\lambda,r})[-1]$, as dg-bimodules. We conclude by applying Lemma 6.15. \square

Corollary 6.17. *There is a quasi-isomorphism*

$$\lambda q(\text{Id})[1] \oplus \lambda^{-1} q^{-1}(\text{Id})[-1] \xrightarrow{\cong} \bar{B}_1 \circ \Xi \circ B_1,$$

of dg-functors.

6.3. The blob 2-category. In this section, we suppose k is a field. Let $\mathfrak{B}(r, r')$ be the subcategory of dg-functors $\mathcal{D}_{\text{dg}}(T^{\lambda, r}, 0) \rightarrow \mathcal{D}_{\text{dg}}(T^{\lambda, r'}, 0)$ c.b.l.f. generated by all compositions of Ξ, B_i and \bar{B}_i , and identity functor whenever $r = r'$, where c.b.l.f. generated means it is given by certain (potentially infinite) iterated extensions of these objects (see Definition B.9 for a precise definition). As explained in §B.4.4, there is an induced morphism

$${}_{\mathbb{Q}}\mathbf{K}_0^\Delta(\mathfrak{B}(r, r')) \xrightarrow{(66)} \text{Hom}_{\mathbb{Q}((q, \lambda))}({}_{\mathbb{Q}}\mathbf{K}_0^\Delta(T^{\lambda, r}, 0), {}_{\mathbb{Q}}\mathbf{K}_0^\Delta(T^{\lambda, r'}, 0)),$$

sending the equivalence class of an exact dg-functor to its induced map on the asymptotic Grothendieck groups of its source and target (this is similar to the fact that an exact functor between triangulated categories induces a map on their triangulated Grothendieck groups).

Recall the blob category \mathfrak{B} , but consider it as defined over $\mathbb{Q}((q, \lambda))$ instead of $\mathbb{Q}(q, \lambda)$.

Theorem 6.18. *There is an isomorphism*

$$\text{Hom}_{\mathfrak{B}}(r, r') \cong {}_{\mathbb{Q}}\mathbf{K}_0^\Delta(\mathfrak{B}(r, r')).$$

Proof. Comparing the action of \mathfrak{B} on $M \otimes V^r$ from §2.2 with the cofibrant replacement $\mathfrak{p}X$ from §5.4, and $\mathfrak{p}B_i$ and $\mathfrak{p}\bar{B}_i$ from §5.2, we deduce there is a commutative diagram

$$\begin{array}{ccc} \text{Hom}_{\mathfrak{B}}(r, r') & \xleftarrow{(13)} & \text{Hom}_{\mathbb{Q}((q, \lambda))}(M \otimes V^r, M \otimes V^{r'}) \\ f \downarrow & & \uparrow \lambda \\ {}_{\mathbb{Q}}\mathbf{K}_0^\Delta(\mathfrak{B}(r, r')) & \xrightarrow{(66)} & \text{Hom}_{\mathbb{Q}((q, \lambda))}({}_{\mathbb{Q}}\mathbf{K}_0^\Delta(T^{\lambda, r}, 0), {}_{\mathbb{Q}}\mathbf{K}_0^\Delta(T^{\lambda, r'}, 0)) \end{array}$$

where the arrow f is the obvious surjective one, sending ξ to $[\Xi]$, and cup/caps to $[B_i]/[\bar{B}_i]$. Because the diagram commutes and using Theorem 2.5, we deduce that f is injective, and thus it is an isomorphism. \square

In particular, if we write $\mathfrak{B}_r := \mathfrak{B}(r, r)$, then we have:

Corollary 6.19. *There is an isomorphism of $\mathbb{Q}((q, \lambda))$ -algebras*

$${}_{\mathbb{Q}}\mathbf{K}_0^{\Delta}(\mathfrak{B}_r) \cong \mathfrak{B}_r.$$

By Faonte [9], we know that A_{∞} -categories form an $(\infty, 2)$ -category, where the hom-spaces are given by Lurie’s dg-nerves [28] of the dg-categories of A_{∞} -functors (or equivalently quasi-functors, see §B.2.1). Thus, we can define the following:

Definition 6.20. Let \mathfrak{B} be the $(\infty, 2)$ -category defined by

- objects are non-negative integers $r \in \mathbb{N}$ (corresponding to $\mathcal{D}_{\text{dg}}(T^{\lambda, r}, 0)$);
- $\text{Hom}_{\mathfrak{B}}(r, r')$ is Lurie’s dg-nerve of the dg-category $\mathfrak{B}(r, r')$.

We refer to \mathfrak{B} as the *blob 2-category*.

We define ${}_{\mathbb{Q}}\mathbf{K}_0^{\Delta}(\mathfrak{B})$ to be the category with objects being non-negative integers $r \in \mathbb{N}$ and homs are given by asymptotic Grothendieck groups of the homotopy categories of $\text{Hom}_{\mathfrak{B}}(r, r')$. These homs are equivalent to ${}_{\mathbb{Q}}\mathbf{K}_0^{\Delta}(\mathfrak{B}(r, r'))$.

Corollary 6.21. *There is an equivalence of categories*

$${}_{\mathbb{Q}}\mathbf{K}_0^{\Delta}(\mathfrak{B}) \cong \mathfrak{B}.$$

7. Variants and generalizations

7.1. Zigzag algebras. In [45, §4] it was proven that for $\mathfrak{g} = \mathfrak{sl}_2$ the KLRW algebra $T_1^{1, \dots, 1}$ with r red strands and only one black strand is isomorphic to a preprojective algebra A_r^1 of type A . It is a Koszul algebra, whose quadratic dual was used by Khovanov and Seidel in [24] to construct a categorical braid group action.

Let \mathbb{k} be a field of any characteristic and let \mathcal{Q}_r be the following quiver

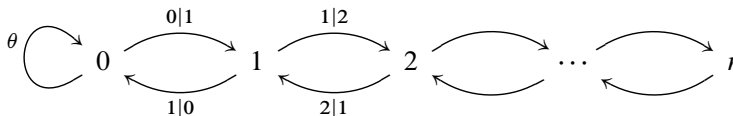

and $\mathbb{k}\mathcal{Q}_r$ its path algebra. We endow $\mathbb{k}\mathcal{Q}_r$ with a $\mathbb{Z} \times \mathbb{Z}^2$ -grading by declaring that

$$\text{deg}(i|i \pm 1) := (0, 1, 0), \quad \text{deg}(\theta) := (1, 0, 2).$$

We consider the first grading as homological, and the second and third gradings are called the q -grading and the λ -grading respectively. We denote the straight path that starts on i_1 and ends at i_n by $(i_1|i_2|\dots|i_{n-1}|i_n)$ and the constant path on i by (i) . The set $\{(0), \dots, (r)\}$ forms a complete set of primitive orthogonal idempotents in $\mathbb{k}\mathcal{Q}_r$.

Definition 7.1. Let $\mathcal{A}_r^!$ be algebra given by the quotient of the path algebra $\mathbb{k}\mathcal{Q}_r$ by the relations

$$\begin{aligned} (i|i-1|i) &= (i|i+1|i), \quad \text{for } i > 0, \\ \theta(0|1|0) &= (0|1|0)\theta, \\ \theta^2 &= 0. \end{aligned}$$

We usually consider $\mathcal{A}_r^!$ as a dg-algebra $(\mathcal{A}_r^!, 0)$ with zero differential. We can also consider a version of $\mathcal{A}_r^!$ with a non-trivial differential d given by

$$d(X) := \begin{cases} (0|1|0) & \text{if } X = \theta, \\ 0 & \text{otherwise,} \end{cases}$$

of which one easily checks that it is well defined.

Proposition 7.2. The $\mathbb{Z} \times \mathbb{Z}^2$ algebra $\mathcal{A}_r^!$ is isomorphic to the $\mathbb{Z} \times \mathbb{Z}^2$ algebra $T_1^{\lambda,r}$ in r red strands and 1 black strand by the map sending

$$(i) \mapsto \begin{array}{c} \color{blue}{\parallel} \color{red}{\parallel} \dots \color{red}{\parallel} \color{black}{\parallel} \dots \color{red}{\parallel} \\ \color{blue}{\lambda} \underbrace{\hspace{2cm}}_i \end{array},$$

where the black strand comes right after the i th red, and

$$(i-1|i) \mapsto \begin{array}{c} \color{blue}{\parallel} \color{red}{\parallel} \dots \color{red}{\parallel} \color{black}{\parallel} \dots \color{red}{\parallel} \\ \color{blue}{\lambda} \underbrace{\hspace{2cm}}_i \end{array},$$

$$(i+1|i) \mapsto \begin{array}{c} \color{blue}{\parallel} \color{red}{\parallel} \dots \color{red}{\parallel} \color{black}{\parallel} \dots \color{red}{\parallel} \\ \color{blue}{\lambda} \underbrace{\hspace{2cm}}_i \end{array},$$

$$\theta \mapsto \begin{array}{c} \color{blue}{\parallel} \color{black}{\parallel} \dots \color{red}{\parallel} \dots \color{red}{\parallel} \\ \color{blue}{\lambda} \end{array}.$$

Furthermore, the isomorphism upgrades to isomorphisms of dg-algebras

$$(\mathcal{A}_r^!, 0) \cong (T_1^{\lambda,r}, 0) \quad \text{and} \quad (\mathcal{A}_r^!, d) \cong (T_1^{\lambda,r}, d_1).$$

Proof. First, one can show by a straightforward computation that the map defined above respects all defining relations of $\mathcal{A}_r^!$. Moreover, by turning any dot in $T_1^{\lambda,r}$ to a double crossings using (21), it is not hard to construct an inverse of the map defined above. We leave the details to the reader. \square

Corollary 7.3. *The homology of $(\mathcal{A}_r^!, d)$ is concentrated in homological degree 0 and is isomorphic to the preprojective algebra $A_r^!$.*

Moreover, by Proposition 7.2, the results in §6 can be pulled to the derived category of \mathbb{Z}^2 -graded $(\mathcal{A}_r^!, 0)$ -modules, endowing $\mathcal{D}_{\text{dg}}(\mathcal{A}_r^!, 0) \cong \mathcal{D}_{\text{dg}}(T_1^{\lambda,r}, 0)$ with a categorical action of \mathcal{B}_r .

7.2. Dg-enhanced KLRW algebras: the general case. Fix a symmetrizable Kac–Moody algebra \mathfrak{g} with set of simple roots I and dominant integral weights $\underline{\mu} := (\mu_1, \dots, \mu_d)$.

7.2.1. Dg-enhanced KLRW algebras: \mathfrak{g} symmetrizable. We recall that the KLRW algebra [49, §4] $T_b^{\underline{\mu}}(\mathfrak{g})$ on b strands is the diagrammatic \mathbb{k} -algebra generated by braid-like diagrams on b black strands and r red strands. Red strands are labeled from left to right by μ_1, \dots, μ_r and cannot intersect each other, while black strands are labeled by simple roots and can intersect red strands transversally, they can intersect transversally among themselves and can carry dots. Diagrams are taken up to braid-like planar isotopy and satisfy the following local relations:

- the KLR local relations (2.5a)–(2.5g) in [49, Definition 2.4];
- the local black/red relations (38)–(41) for all $v \in \underline{\mu}$ and for all $\alpha_j, \alpha_k \in I$, given below;
- a black strand in the leftmost region is 0.

$$\begin{array}{c} \text{Black strand with dot} \\ \text{Red strand} \end{array} \times \begin{array}{c} \text{Red strand} \\ \text{Black strand} \end{array} = \begin{array}{c} \text{Red strand} \\ \text{Black strand with dot} \end{array} \times \begin{array}{c} \text{Black strand} \\ \text{Red strand} \end{array}, \quad (38)$$

$$\begin{array}{c} \text{Red strand} \\ \text{Red strand} \end{array} \times \begin{array}{c} \text{Red strand} \\ \text{Red strand} \end{array} = \begin{array}{c} \text{Red strand} \\ \text{Red strand} \end{array} \parallel \begin{array}{c} \text{Black strand with dot} \end{array}, \quad (39)$$

$$\begin{array}{c} \text{red} \\ \text{black} \end{array} \begin{array}{c} \diagup \\ \diagdown \end{array} = \begin{array}{c} \text{red} \\ \text{black} \end{array} \begin{array}{c} \diagdown \\ \diagup \end{array}, \quad \begin{array}{c} \text{red} \\ \text{black} \end{array} \begin{array}{c} \diagdown \\ \diagup \end{array} = \begin{array}{c} \text{red} \\ \text{black} \end{array} \begin{array}{c} \diagup \\ \diagdown \end{array}, \quad (40)$$

$$\begin{array}{c} \text{red} \\ \text{black} \end{array} \begin{array}{c} \diagup \\ \diagdown \end{array} = \begin{array}{c} \text{red} \\ \text{black} \end{array} \begin{array}{c} \diagdown \\ \diagup \end{array} + \delta_{j,k} \sum_{a+b=v_j-1} \begin{array}{c} a \\ \bullet \\ \text{red} \\ \bullet \\ b \end{array}. \quad (41)$$

Multiplication is given by concatenation of diagrams that are read from bottom to top, and it is zero if the labels do not match. The algebra $T_b^\mu(\mathfrak{g})$ is finite-dimensional and can be endowed with a \mathbb{Z} -grading (we refer to [49, Definition 4.4] for the definition of the grading).

In the case of $\underline{\mu} = \underline{\nu}$ the algebra $T_b^\nu(\mathfrak{g})$ contains a single red strand labeled ν and is isomorphic to the cyclotomic KLR algebra $R^\nu(b)$ for \mathfrak{g} in b strands.

Definition 7.4. Fix a \mathfrak{g} -weight $\lambda = (\lambda_1, \dots, \lambda_{|I|})$ with each λ_i being a formal parameter. The *dg-enhanced KLRW algebra* $T_b^{\lambda, \underline{\mu}}(\mathfrak{g})$ is defined as in Definition 3.2, with a blue strand labeled by λ and with the r red strands labeled by μ_1, \dots, μ_r and the black strands labeled by simple roots. The black strands can carry dots and be nailed on the blue strand:



with everything in homological degree 0, except that a nail is in homological degree 1. The diagrams are taken up to graded braid-like planar isotopy, and are required to satisfy the same local relations as $T_b^\mu(\mathfrak{g})$, together with the following extra local relations:

$$\begin{array}{c} \text{blue} \\ \text{black} \end{array} \begin{array}{c} \diagup \\ \diagdown \end{array} = \begin{array}{c} \text{blue} \\ \text{black} \end{array} \begin{array}{c} \diagdown \\ \diagup \end{array}, \quad \begin{array}{c} \text{blue} \\ \text{black} \end{array} \begin{array}{c} \diagdown \\ \diagup \end{array} = - \begin{array}{c} \text{blue} \\ \text{black} \end{array} \begin{array}{c} \diagup \\ \diagdown \end{array}, \quad \begin{array}{c} \text{blue} \\ \text{black} \end{array} \begin{array}{c} \diagdown \\ \diagup \end{array} = 0,$$

for all $\alpha_j, \alpha_k \in I$.

Note that we have an inclusion $T_b^\mu(\mathfrak{g}) \subset T_b^{\lambda, \underline{\mu}}(\mathfrak{g})$ by adding a vertical blue strand at the left of a diagram. The algebra $T_b^{\lambda, \underline{\mu}}(\mathfrak{g})$ can be endowed with the

q -grading inherited from $T_b^\mu(\mathfrak{g})$. It can be additionally endowed with a λ_k -grading for each $\alpha_k \in I$ such that $T_b^\mu(\mathfrak{g}) \subset T_b^{\lambda, \mu}(\mathfrak{g})$ sits in λ_k -degree zero for all k , and

$$\text{deg}_{\mathfrak{g}, \lambda_k} \left(\begin{array}{c} \text{K} \\ \lambda \quad \alpha_j \end{array} \right) := (0, 2\delta_{k,j}).$$

We usually consider $T_b^{\lambda, \mu}(\mathfrak{g})$ as a $\mathbb{Z}^{1+|I|}$ -graded dg-algebra $(T_b^{\lambda, \mu}(\mathfrak{g}), 0)$ with trivial differential. In the case of $\mu = \emptyset$ the algebra $T_b^{\lambda, \emptyset}(\mathfrak{g})$ contains a blue strand labeled λ and is isomorphic to the \mathfrak{b} -KLR algebra $R_{\mathfrak{b}}(b)$ introduced in [34, §3.1].

The results of §3 can be generalized to $T_b^{\lambda, \mu}(\mathfrak{g})$. In particular, one can prove it is free over \mathbb{k} and that it admits a basis similar to the one in Theorem 3.11. Moreover, by using induction and restriction functors that add a black strand, we obtain a categorical action of \mathfrak{g} on $\mathcal{D}_{\text{dg}}(T_b^{\lambda, \mu}(\mathfrak{g}), 0)$ (in the sense of [34]), which categorifies the $U_q(\mathfrak{g})$ -action on the tensor product of a universal Verma module and several integrable modules.

Fix an integrable dominant weight κ of \mathfrak{g} and define a differential d_κ on $T_b^{\lambda, \mu}(\mathfrak{g})$ (after specialization of the λ_j -grading to q^{κ_j}) by setting

$$d_\kappa \left(\begin{array}{c} \text{K} \\ \lambda \quad \alpha_j \end{array} \right) = \begin{array}{c} \parallel \\ \lambda \quad \alpha_j \end{array} \begin{array}{c} \bullet \\ \kappa_j \end{array}$$

and $d_\kappa(t) = 0$ for all $t \in T_b^\mu(\mathfrak{g}) \subset T_b^{\lambda, \mu}(\mathfrak{g})$, and extending by the graded Leibniz rule with respect to the homological grading. A straightforward computation shows that d_κ is well defined.

Proposition 7.5. *The dg-algebra $(T_b^{\lambda, \mu}(\mathfrak{g}), d_\kappa)$ is formal with*

$$H(T_b^{\lambda, \mu}(\mathfrak{g}), d_\kappa) \cong T_b^{(\kappa, \mu)}(\mathfrak{g}).$$

Proof. The proof follows by similar arguments as in [34, Theorem 4.4]. □

7.2.2. Dg-enhanced KLRW algebras for parabolic subalgebras. Let $\mathfrak{p} \subseteq \mathfrak{g}$ be a parabolic subalgebra with partition $I = I_f \sqcup I_r$ of the set of simple roots, and $(\lambda, n) = (\lambda_i)_{i \in I}$, with λ_i a formal parameter if $i \in I_r$, and $\lambda_i = q^{n_i}$ with $n_i \in \mathbb{N}$ if $i \in I_f$.

Introduce a differential $d_{\lambda,n}$ on $T_b^{\lambda,\mu}(\mathfrak{g})$ (after specialization of the λ_j -grading to q^{n_j} for each $\alpha_j \in I_r$) by setting

$$d_{\lambda,n} \left(\begin{array}{c} \text{Diagram: a blue vertical line labeled } \lambda \text{ and a black line labeled } \alpha_j \text{ meeting at a blue circle with a dot.} \\ \lambda \quad \alpha_j \end{array} \right) = \begin{cases} 0 & \text{if } \alpha_j \in I_r, \\ \begin{array}{c} \text{Diagram: a blue vertical line labeled } \lambda \text{ and a black line labeled } \alpha_j \text{ meeting at a black dot.} \\ \lambda \quad \alpha_j \end{array} & \text{if } \alpha_j \in I_f, \end{cases}$$

and $d_{\lambda,n}(t) = 0$ for all $t \in T_b^\mu(\mathfrak{g}) \subset T_b^{\lambda,\mu}(\mathfrak{g})$, and extending by the graded Leibniz rule with respect to the homological grading. As before, a straightforward computation shows that it is well defined.

Proposition 7.6. *The dg-algebra $(T_b^{\lambda,\mu}(\mathfrak{g}), d_{\lambda,n})$ is formal.*

Proof. The proof follows by similar arguments as in [34, Theorem 4.4]. □

Definition 7.7. We define the *dg-enhanced p-KLRW algebra* as

$$T_b^{\lambda,\mu}(\mathfrak{g}, \mathfrak{p}) := H(T_b^{\lambda,\mu}(\mathfrak{g}), d_{\lambda,n}).$$

Note that by Proposition 7.6 we have a quasi-isomorphism

$$(T_b^{\lambda,\mu}(\mathfrak{g}, \mathfrak{p}), 0) \cong (T_b^{\lambda,\mu}(\mathfrak{g}), d_{\lambda,n}).$$

Similarly as above, $\mathcal{D}_{\text{dg}}(T_b^{\lambda,\mu}(\mathfrak{g}), d_{\lambda,n})$ categorifies the tensor product of a parabolic Verma module and several integrable modules, and comes with a categorical action of \mathfrak{g} .

7.3. Dg-enhanced quiver Schur algebras. In order to define a quiver Schur algebra of type A_1 , we follow the approach of [23], which best suits our goals. We actually use a slightly different definition because theirs corresponds to a thick version of KLRW algebra (see [23, §9.2]), and we want to relate it to the version we use.

7.3.1. Cyclic modules and quiver Schur algebras. Recall that $\text{NH}_b^N \cong T_b^{(N)}$ is the N -cyclotomic nilHecke algebra on b strands. Fix $r \geq 0$ and $\bar{N} = (N_0, N_1, \dots, N_r) \in \mathbb{N}^r$ such that $\sum_i N_i = N$. For $\rho = (b_0, b_1, \dots, b_r)$ such that $\sum_i b_i = b$, we define the element

$$x_{\rho}^{\bar{N}} := \prod_{i=1}^r (x_{b_r+\dots+b_{i+1}+1}^{N_i+\dots+N_1} \cdots x_{b_r+\dots+b_{i+1}+b_i}^{N_i+\dots+N_1}) \in \text{NH}_b^N,$$

where we recall that x_b is a dot on the b th black strand. Then, we consider the cyclic right NH_b^N -module defined as

$$Y_\rho^{\bar{N}} := x_\rho^{\bar{N}} \text{NH}_b^N.$$

The *quiver Schur algebra* (of type A_1) is defined as the \mathbb{Z} -graded algebra:

$$Q_b^{\bar{N}} := \text{END}_{\text{NH}_b^N} \left(\bigoplus_{\rho \in \mathcal{P}_b^r} q^{-\deg_q(x_\rho^{\bar{N}})/2} Y_\rho^{\bar{N}} \right),$$

where END means the (\mathbb{Z} -)graded endomorphism ring. The \mathbb{Z} -graded algebra $Q_b^{\bar{N}}$ is isomorphic to $T_b^{\bar{N}}$ [49, Proposition 5.33]. The *reduced quiver Schur algebra* (of type A_1) is defined as

$$\text{red } Q := \text{END}_{\text{NH}_b^N} \left(\bigoplus_{\rho \in \mathcal{P}_b^{r, \bar{N}}} q^{-\deg_q(x_\rho^{\bar{N}})/2} Y_\rho^{\bar{N}} \right),$$

where $\mathcal{P}_b^{r, \bar{N}} := \{(b_0, b_1, \dots, b_r) : b_i \leq N_i \text{ for } 0 \leq i \leq r\} \subset \mathcal{P}_b^r$. It is Morita equivalent to $Q_b^{\bar{N}}$ (this can be shown by observing that if $b_i > N_i$ for some i , then $Y_\rho^{\bar{N}}$ is isomorphic to a direct sum of elements in $\{q^{-\deg_q(x_{\rho'}^{\bar{N}})/2} Y_{\rho'}^{\bar{N}} \mid \rho' \in \mathcal{P}_b^{r, \bar{N}}\}$), and thus to $T_b^{\bar{N}}$.

7.3.2. Dg-enhanced cyclic modules. Our goal is to construct a dg-enhancement of $Y_\rho^{\bar{N}}$ over $(T_b^{\lambda, \emptyset}, d_N)$, the dg-enhanced KLRW algebra without red strands. We will simply write T_b^λ for $T_b^{\lambda, \emptyset}$. Recall from Theorem 3.13 that (T_b^λ, d_N) is quasi-isomorphic to $T_b^{(N)} \cong \text{NH}_b^N$.

Let $T_b^{q^\ell \lambda}$ for $\ell \in \mathbb{Z}$ be the algebra defined similarly as T_b^λ (see Definition 3.2) except that the blue strand is labeled by $q^\ell \lambda$, and the nail is in \mathbb{Z}^2 -degree:

$$\deg_{q, \lambda} \left(\begin{array}{c} \text{K} \\ q^\ell \lambda \end{array} \right) = (2\ell, 2).$$

Whenever $\ell \geq \ell'$ and $b \leq b'$, there is an inclusion of algebras

$$T_b^{q^\ell \lambda} \hookrightarrow T_{b'}^{q^{\ell'} \lambda}, \tag{42}$$

given by first turning any $q^\ell \lambda$ -nail into a $q^{\ell'} \lambda$ -nail by adding dots:

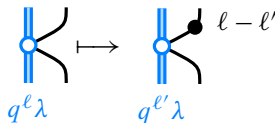

so that the blue strand labeled $q^\ell \lambda$ becomes labeled $q^{\ell'} \lambda$, and then adding $b' - b$ vertical black strands at the right:

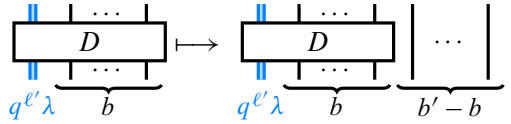

A straightforward computation shows that the map in (42) is well defined, and Theorem 3.11 shows that the map is injective.

By restriction, the inclusion $T_b^{q^\ell \lambda} \hookrightarrow T_{b'}^{q^{\ell'} \lambda}$ defines a left action of $T_b^{q^\ell \lambda}$ on any $T_{b'}^{q^{\ell'} \lambda}$ -module.

Definition 7.8. We define the right T_b^λ -modules

$$\tilde{G}_\rho^{\bar{N}} := T_{b_r}^{q^{-N_r - \dots - N_1 \lambda}} \otimes_{T_{b_r}^{q^{-N_{r-1} - \dots - N_1 \lambda}}} \dots \otimes_{T_{b_r + \dots + b_2}^{q^{-N_1 \lambda}}} T_{b_r + \dots + b_1}^{q^{-N_1 \lambda}} \otimes_{T_{b_r + \dots + b_1}^\lambda} T_b^\lambda,$$

and

$$G_\rho^{\bar{N}} := x_\rho^{\bar{N}} \tilde{G}_\rho^{\bar{N}}.$$

Note that we can endow $G_\rho^{\bar{N}}$ with either a differential of the form d_N (as in §3.4) or a trivial one, making it a right dg-module over (T_b^λ, d_N) or $(T_b^\lambda, 0)$ respectively.

Example 7.9. Take for example $r = 2$. Then, we picture $G_\rho^{\bar{N}}$ in terms of diagrams as

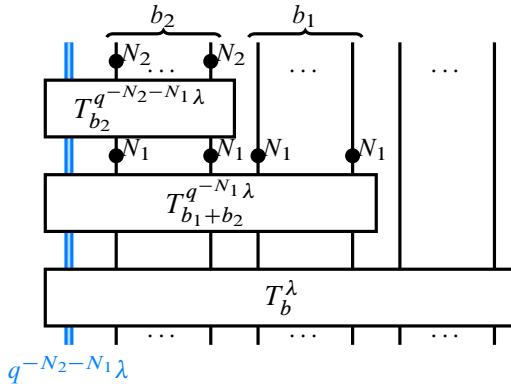

Note that whenever $N + \ell \geq 0$ we can equip $T_b^{q^\ell \lambda}$ with a differential d_N given by

$$d_N \left(\begin{array}{c} \text{K} \\ \text{---} \\ q^\ell \lambda \end{array} \right) := \begin{array}{c} \text{---} \\ \text{---} \\ q^\ell \lambda \end{array} \bullet^{N + \ell}$$

and it is compatible with the inclusion in (42).

We conjecture the following:

Conjecture 7.10. *There is a quasi-isomorphism*

$$(G_{\rho}^{\bar{N}}, d_N) \xrightarrow{\cong} (Y_{\rho}^{\bar{N}}, 0).$$

Lemma 7.11. *There is a decomposition as graded vector spaces*

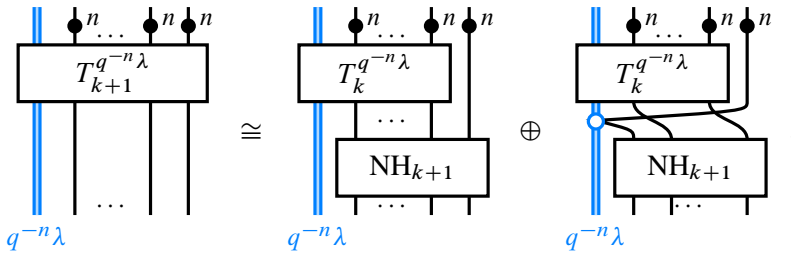

Proof. The claim follows from Theorem 3.11. □

Proposition 7.12. *Suppose ρ and ρ' are such that $b_i = b'_i$ for all $0 \leq i \leq m$ except $i = j$ and $i = j + 1$ where they respect $b_j = b'_j - 1$ and $b_{j+1} = b'_{j+1} + 1$. Then there is an inclusion of right dg-modules*

$$G_{\rho}^{\bar{N}} \hookrightarrow G_{\rho'}^{\bar{N}}.$$

Proof. We can work locally, and thus we want to prove that

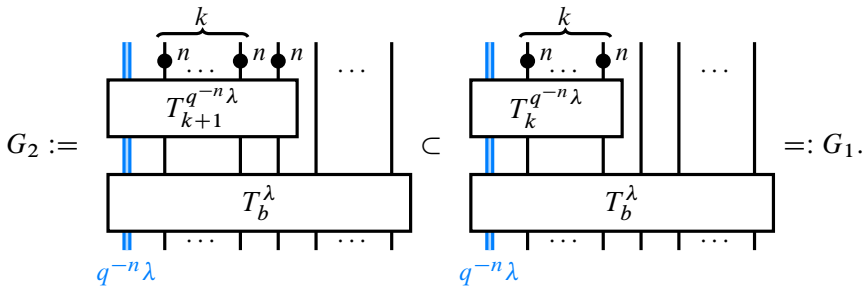

We apply Lemma 7.11 on $T_{k+1}^{q^{-n}\lambda}$ inside G_2 . The left summand is clearly in G_1 . For the right summand, it is less clear since the nails in T_b^λ all acts by adding a nail and n dots on the blue strand labeled $q^{-n}\lambda$. Thus, we want to show that

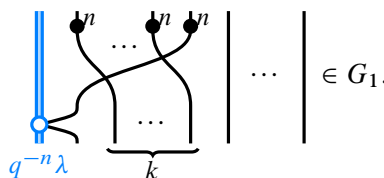

By (19), we have

$$\begin{array}{c}
 \text{Diagram 1} \\
 \text{Diagram 2} \\
 \text{Diagram 3} \\
 \text{Diagram 4}
 \end{array}
 =
 \begin{array}{c}
 \text{Diagram 5} \\
 \text{Diagram 6} \\
 \text{Diagram 7}
 \end{array}
 - \sum_{\ell=0}^k \sum_{r+s=n-1} \begin{array}{c} \text{Diagram 8} \\ \text{Diagram 9} \\ \text{Diagram 10} \end{array} \cdot$$

The term of the left is clearly in G_1 since there are n dots next to the nail, so that it can be obtained from a nail in T_b^λ . The terms on the right are also in G_1 since we can slide the nail and crossings on the left to the top, into $T_k^{q^{-n}\lambda}$. \square

Consider $(x_1^n \cdots x_k^n) T_k^{q^{-n}\lambda} \otimes_{T_k^\lambda} T_b^\lambda$. We obtain an inclusion

$$(x_1^n \cdots x_k^n) T_k^{q^{-n}\lambda} \hookrightarrow (x_1^n \cdots x_k^n x_{k+1}^n) T_{k+1}^{q^{-n}\lambda},$$

of q -degree $2n$ by adding a vertical strand on the right on which we put n dots (again, the fact it is an inclusion follows immediately from Theorem 3.11). In turns, it gives rise to a map of right (dg-)modules

$$(x_1^n \cdots x_k^n) T_k^{q^{-n}\lambda} \otimes_{T_k^\lambda} T_b^\lambda \longrightarrow (x_1^n \cdots x_k^n x_{k+1}^n) T_{k+1}^{q^{-n}\lambda} \otimes_{T_{k+1}^\lambda} T_b^\lambda.$$

In terms of diagrams, we can picture the inclusion above as

$$\begin{array}{c}
 \text{Diagram 1} \\
 \text{Diagram 2} \\
 \text{Diagram 3}
 \end{array}
 \hookrightarrow
 \begin{array}{c}
 \text{Diagram 4} \\
 \text{Diagram 5} \\
 \text{Diagram 6}
 \end{array}
 \subset
 \begin{array}{c}
 \text{Diagram 7} \\
 \text{Diagram 8} \\
 \text{Diagram 9}
 \end{array}
 \cdot$$

This generalizes into the following proposition:

Proposition 7.13. *Under the same hypothesis as in Proposition 7.12, we obtain a map of right dg-modules*

$$G_{\rho'}^{\bar{N}} \longrightarrow G_{\rho}^{\bar{N}},$$

of q -degree $2N_{j+1}$. Diagrammatically, this map is given by gluing on top the dots $x_{b'_r + \cdots + b'_{j+1} + 1}^{N_{j+1}}$

7.3.3. Dg-quiver Schur algebra

Definition 7.14. We define the *dg-quiver Schur algebras* as

$$(\text{dg } Q_b^{\bar{N}}, d_N) := \text{END}_{(T_b^\lambda, d_N)}^{\text{dg}} \left(\bigoplus_{\rho \in \mathcal{P}_b^r} q^{-\text{deg}_q(x_\rho^{\bar{N}})/2} (G_\rho^{\bar{N}}, d_N) \right),$$

and

$$(\text{dg } Q_b^{\bar{N}}, 0) := \text{END}_{(T_b^\lambda, 0)}^{\text{dg}} \left(\bigoplus_{\rho \in \mathcal{P}_b^r} q^{-\text{deg}_q(x_\rho^{\bar{N}})/2} (G_\rho^{\bar{N}}, 0) \right),$$

where END^{dg} is the \mathbb{Z}^2 -graded (\mathbb{Z} -graded in the first case) dg-endomorphism ring (see §3.1.2). We also define a reduced version as

$$(\text{red } Q_b^{\bar{N}}, 0) := \text{END}_{(T_b^\lambda, 0)}^{\text{dg}} \left(\bigoplus_{\rho \in \mathcal{P}_b^{r, \bar{N}}} q^{-\text{deg}_q(x_\rho^{\bar{N}})/2} (G_\rho^{\bar{N}}, 0) \right).$$

Conjecture 7.15. *There is a quasi-isomorphism*

$$(\text{dg } Q_b^{\bar{N}}, d_N) \xrightarrow{\simeq} (Q_b^{\bar{N}}, 0).$$

Our goal is to construct a graded map of algebras

$$T_b^{\lambda, \bar{N}} \longrightarrow \text{dg } Q_b^{\bar{N}}.$$

For $\rho = (b_0, b_1, \dots, b_r) \in \mathcal{P}_b^r$, we send

$$1_\rho \longmapsto \text{Id} \in \text{END}_{T_b^\lambda} (G_\rho^{\bar{N}}) \subset \text{dg } Q_b^{\bar{N}}.$$

Dots on the i th black strand (resp. black/black crossings on the i th and $(i + 1)$ th black strands) on 1_ρ is sent to multiplication on the left (i.e. gluing on top) by a dot on the i th black strand (resp. crossing) on $G_\rho^{\bar{N}}$. These are indeed maps of right T_b^λ -modules since the dots and crossing commutes with $x_i^n x_{i+1}^n$ for all $n \geq 0$. Similarly, a nail on the blue strand labeled λ in $T_b^{\lambda, \bar{N}}$ is sent to multiplication on the left by a nail on the blue strand labeled $q^{-N_r - \dots - N_1} \lambda$ in $G_\rho^{\bar{N}}$.

For black/red crossing τ_i , if the red strand goes from bottom left to top right, then we have $1_{\rho'} \tau_i 1_\rho$ where ρ and ρ' are as in Proposition 7.12. Then, we associate to it the map $G_\rho^{\bar{N}} \rightarrow G_{\rho'}^{\bar{N}}$ of Proposition 7.12. If the red strand goes from bottom right to top left, then we have $1_\rho \tau_i 1_{\rho'}$, and we associate to it the map $G_{\rho'}^{\bar{N}} \rightarrow G_\rho^{\bar{N}}$ of Proposition 7.13.

Proposition 7.16. *The map defined above gives rise to maps of \mathbb{Z} -graded dg-algebras*

$$(T_b^{\lambda, \bar{N}}, d_{N_0}) \longrightarrow (\text{dg } Q_b^{\bar{N}}, d_N),$$

and of \mathbb{Z}^2 -graded dg-algebras

$$(T_b^{\lambda, \bar{N}}, 0) \longrightarrow (\text{dg } Q_b^{\bar{N}}, 0).$$

Proof. We show the assignment given above is a map of algebras, the commutation with the differentials being obvious since the image by d_{N_0} of a nail on a blue strand labeled λ consists of N_0 dots on the first black strand; and the image by d_N of a nail on a blue strand labeled $q^{-N_r - \dots - N_1} \lambda$ consists of $N - N_r - \dots - N_1 = N_0$ dots.

Thus, we need to prove the map respects all the defining relations in Definition 3.2. Relations in (18) and (19) are immediate by construction. The relations in (20) follow from commutations of dots. Since the map in Proposition 7.13 is multiplication by n_{j+1} dots and the map in Proposition 7.12 is an inclusion, we have the relations in (21). For the left side of (22) both black/red crossings are given by an inclusion, and thus commutes with the multiplication on the left by the black/black crossing. For the right side, the black/red crossings give a multiplication by $x_i^{N_{j+1}} x_{i+1}^{N_{j+1}}$, which commutes with the black/black crossing. For (23), one the black/red crossing is an inclusion and the other one is multiplication by $x_i^{N_{j+1}}$ on both side of the equality, so that the relation follows from (19). Finally, the relation in (26) is immediate by construction. \square

Conjecture 7.17. *The maps in Proposition 7.16 are isomorphisms.*

We also conjecture that the reduced dg-quiver Schur algebra $(\text{red } Q_b^{\bar{N}}, 0)$ is dg-Morita equivalent to the non-reduced one $(\text{dg } Q_b^{\bar{N}}, 0)$.

Appendices

A. Detailed proofs and computations

We give the detailed computations used to prove various results of the paper.

A.1. Proofs of §2

Lemma 2.4. *The action of \mathcal{B}_r translates in terms of v_ρ -vectors of $M \otimes V^r$ as*

$$\begin{array}{c}
 \underbrace{\begin{array}{c} | \quad | \quad \dots \quad | \quad \cap \quad | \quad \dots \quad | \\ \hline \end{array}}_i \quad : \\
 v_{(\dots, b_{i-1}, b_i, b_{i+1}, b_{i+2}, \dots)} \mapsto -q^{-1} [b_i]_q v_{(\dots, b_{i-1} + b_i + b_{i+1} - 1, b_{i+2}, \dots)}, \quad (10)
 \end{array}$$

$$\begin{array}{c}
 \underbrace{\begin{array}{c} | \quad | \quad \dots \quad | \quad \cup \quad | \quad \dots \quad | \\ \hline \end{array}}_i \quad : \\
 v_\rho \mapsto q[2]_q v_{(\dots, b_{i-1}, 1, 0, b_i, \dots)} - q v_{(\dots, b_{i-1} + 1, 0, 0, b_i, \dots)} - q v_{(\dots, b_{i-1}, 0, 1, b_i, \dots)}, \quad (11)
 \end{array}$$

$$\begin{array}{c}
 \begin{array}{c} \color{blue}{\mathbb{K}} \quad | \quad \dots \quad | \\ \hline \end{array} \quad : \\
 v_{(b_0, b_1, \dots)} \mapsto (\lambda^{-1} q^{b_0} - \lambda q [b_0]_q) v_{(0, b_0 + b_1, \dots)} + \lambda q^2 [b_0]_q v_{(1, b_0 + b_1 - 1, \dots)}. \quad (12)
 \end{array}$$

Proof. We start with the cap. We have

$$\begin{aligned}
 & v_{(\dots, b_{i-1}, b_i, b_{i+1}, b_{i+2}, \dots)} \\
 &= [b_i]_q v_{(\dots, b_{i-1} + b_i - 1, 1, b_{i+1}, b_{i+2}, \dots)} - [b_i - 1]_q v_{(\dots, b_{i-1} + b_i, 0, b_{i+1}, b_{i+2}, \dots)},
 \end{aligned}$$

and we easily check that

$$\begin{aligned}
 v_{(\dots, b_{i-1} + b_i - 1, 1, b_{i+1}, b_{i+2}, \dots)} &\mapsto -q^{-1} v_{(\dots, b_{i-1} + b_i + b_{i+1} - 1, b_{i+2}, \dots)}, \\
 v_{(\dots, b_{i-1} + b_i, 0, b_{i+1}, b_{i+2}, \dots)} &\mapsto 0.
 \end{aligned}$$

We now turn to the cup. It suffices to do the computation for $i = r + 1$ because of the recursive definition of v_ρ . By definition,

$$v_{(b_0, \dots, b_n)} \mapsto -q v_{(b_0, \dots, b_n)} \otimes v_{1,0} \otimes F v_{1,0} + v_{(b_0, \dots, b_n)} \otimes F v_{1,0} \otimes v_{1,0}.$$

Since

$$\begin{aligned}
 & v_{(b_0, \dots, b_n)} \otimes v_{1,0} \otimes F v_{1,0} \\
 &= v_{(b_0, \dots, b_n, 0, 1)} - q^2 v_{(b_0, \dots, b_n + 1, 0, 0)} - q v_{(b_0, \dots, b_n)} \otimes F v_{1,0} \otimes v_{1,0},
 \end{aligned}$$

and

$$v_{(b_0, \dots, b_n)} \otimes F v_{1,0} \otimes v_{1,0} = v_{(b_0, \dots, b_n, 1, 0)} - q v_{(b_0, \dots, b_n + 1, 0, 0)},$$

one finds the expected formula.

Finally, we finish with ξ . Using the fact that ξ is a morphism of $U_q(\mathfrak{sl}_2)$ -modules, it suffices to consider the case of the vector $v_{(b_0, b_1)}$. One may check that

$$v_{(b_0, b_1)} = [b_0]_q v_{(1, b_0 + b_1 - 1)} - [b_0 - 1]_q v_{(0, b_0 + b_1)}$$

and therefore

$$\xi(v_{(b_0, b_1)}) = [b_0]_q F^{b_0 + b_1 - 1} \xi(v_{(1, 0)}) - [b_0 - 1]_q F^{b_0 + b_1} \xi(v_{(0, 0)}).$$

Using the definition of ξ we have

$$\xi(v_{(0, 0)}) = \lambda^{-1} v_{(0, 0)},$$

and

$$\xi(v_{(1, 0)}) = \lambda q^2 v_{(1, 0)} - q(\lambda - \lambda^{-1}) v_{(0, 1)}.$$

Hence we deduce that

$$\begin{aligned} \xi(v_{(b_0, b_1)}) &= \lambda q^2 [b_0]_q v_{(1, b_0 + b_1 - 1)} - (q(\lambda - \lambda^{-1}) [b_0]_q + \lambda^{-1} [b_0 - 1]_q) v_{(0, b_0 + b_1)}. \end{aligned}$$

We conclude by checking that $\lambda^{-1} q [b_0]_q - \lambda^{-1} [b_0 - 1]_q = \lambda^{-1} q^{b_0}$. □

A.2. Proofs of §5

Lemma 5.7. *The map $\gamma_k: \mathfrak{p}X_k \rightarrow X_k$ is surjective.*

Proof. First, we recall the following well-known relation

$$\left| \begin{array}{c} | \\ | \end{array} \right| = \begin{array}{c} \text{crossing with dot on top} \\ - \\ \text{crossing with dot on bottom} \end{array} \tag{43}$$

which follows easily from (18) and (19). We also observe

$$\begin{array}{c} \text{blob on blue line} \\ \text{blob on red line} \end{array} \stackrel{(21)}{=} \begin{array}{c} \text{blob on blue line} \\ \text{blob on red line} \end{array} \stackrel{(33)}{=} \begin{array}{c} \text{blob on blue line} \\ \text{blob on red line} \end{array} \tag{44}$$

Then, we compute

(43)

and

(22) (26)

Thus, using (44) we obtain

Consequently, using Theorem 5.5, we deduce that X_k is generated as left $(T_b^{\lambda,r}, 0)$ -module by the elements

for all $0 \leq t \leq k - 1$. In particular, γ_k is surjective. □

Lemma A.1. *Suppose $r = 1$ and $\ell = 0$. As a $\mathbb{Z} \times \mathbb{Z}^2$ -graded \mathbb{k} -module, $X1_{k,0}$ admits a decomposition*

$$\begin{aligned}
 X1_{k,0} &\cong \lambda^{-1} q^{2k} (T_k^{\lambda,0}) \\
 &\oplus \bigoplus_{\substack{0 \leq t < k \\ p \geq 0}} (q^{2p+1-2(k-t)} (X1_{k-1,0}) \oplus \lambda^2 q^{2p+1-2(k+t)} (X1_{k-1,0})[1]).
 \end{aligned}$$

Proof. It follows from Theorem 5.5 that we have a decomposition

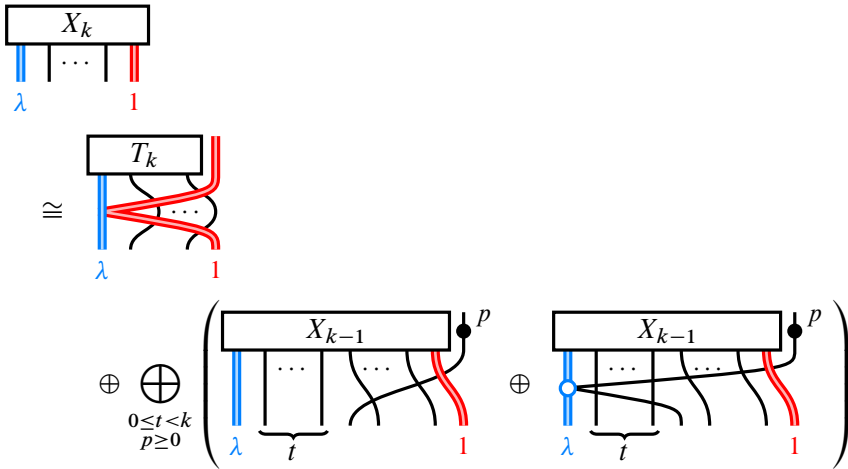

concluding the proof. □

Lemma 5.8. *The sequence*

$$0 \longrightarrow Y_k^1 \xrightarrow{i_k} Y_k^0 \xrightarrow{y_k} X_k \longrightarrow 0,$$

is a short exact sequence of left $(T^{\lambda,r}, 0)$ -modules.

Proof. Since we already have a complex with an injection and a surjection, it is enough to show that

$$\text{gdim } X_k = \text{gdim } Y_k^0 - \text{gdim } Y_k^1,$$

where gdim is the graded dimension in the form of a Laurent series in $\mathbb{N}[[h^{\pm 1}, \lambda^{\pm 1}, q^{\pm 1}]]$. We will show this by induction on k . When $k = 0$, this is immediate. Suppose it is true for k , and we will show it for $k + 1$.

Let

$$[\beta + t]_q^h := \frac{\lambda^{-1}q^{-t} + h\lambda q^t}{q^{-1} - q} = q \frac{\lambda^{-1}q^{-t} + h\lambda q^t}{1 - q^2}.$$

Note that

$$[k + 1]_q [\beta + t + k]_q^h = \sum_{r=0}^k [\beta + t - 2r]_q^h, \tag{45}$$

$$[k + 1]_q = q[k]_q + q^{-k}, \tag{46}$$

$$[\beta - k + 1]_q^h = q^{-1}[\beta - k]_q^h - h\lambda q^{-k}, \tag{47}$$

and

$$[k + 1]_q[\beta - k + 1]_q^h = [k]_q[\beta - k]_q^h + q^{-1-k}[\beta - k]_q^h - h\lambda q^{-k}[k + 1]_q. \quad (48)$$

We first restrict to the case $\ell = 0$ and $r = 1$. By Lemma A.1 using (45), followed by the induction hypothesis, we have

$$\begin{aligned} \text{gdim } X1_{k+1,0} &= \lambda^{-1}q^{2(k+1)} \text{gdim } T_{k+1}^{\lambda,0} + \lambda q^{-2k}[k + 1]_q[\beta - k]_q^h \text{gdim } X1_{k,0} \\ &= \lambda^{-1}q^{2(k+1)} \text{gdim } T_{k+1}^{\lambda,0} + \lambda q^{-2k}[k + 1]_q[\beta - k]_q^h \\ &\quad \times ((\lambda^{-1}q^k + h\lambda q[k]_q) \text{gdim } T_k^{\lambda,1}1_{0,k} - h\lambda q^2[k]_q \text{gdim } T_k^{\lambda,1}1_{1,k-1}). \end{aligned}$$

By definition, we have

$$\begin{aligned} \text{gdim } Y_{k+1,0}^0 &= (\lambda^{-1}q^{k+1} + h\lambda q[k + 1]_q) \text{gdim } T_{k+1}^{\lambda,1}1_{0,k+1}, \\ \text{gdim } Y_{k+1,0}^1 &= h\lambda q^2[k + 1]_q \text{gdim } T_{k+1}^{\lambda,1}1_{1,k}. \end{aligned}$$

By Corollary 3.12,

$$\begin{aligned} \text{gdim } T_{k+1}^{\lambda,1}1_{0,k+1} &= q^{k+1} \text{gdim } T_{k+1}^{\lambda,0} + \lambda q^{-2k}[k + 1]_q[\beta + 1 - k]_q^h \text{gdim } T_k^{\lambda,1}1_{0,k}, \\ \text{gdim } T_{k+1}^{\lambda,1}1_{1,k} &= q^k \text{gdim } T_{k+1}^{\lambda,0} + \lambda q^{-2k}[\beta]_q^h \text{gdim } T_k^{\lambda,1}1_{0,k} \\ &\quad + \lambda q^{-2k}[k]_q[\beta - k]_q^h \text{gdim } T_k^{\lambda,1}1_{1,k-1}. \end{aligned}$$

We now gather by $\text{gdim } T_{k+1}^{\lambda,0}$, $\text{gdim } T_k^{\lambda,1}1_{0,k}$ and $\text{gdim } T_k^{\lambda,1}1_{1,k-1}$. For $\text{gdim } T_{k+1}^{\lambda,0}$, we verify that

$$\lambda^{-1}q^{2(k+1)} = (\lambda^{-1}q^{k+1} + \lambda q[k + 1]_q)q^{k+1} - \lambda q^2[k + 1]_q q^k.$$

Gathering by $\text{gdim } T_k^{\lambda,1}1_{0,k}$, we obtain on one hand

$$\begin{aligned} \lambda q^{-2k}[k + 1]_q[\beta - k]_q^h (\lambda^{-1}q^k + h\lambda q[k]_q) \\ = q^{-k}[k + 1]_q[\beta - k]_q^h + h\lambda^2 q^{1-2k}[k]_q[k + 1]_q[\beta - k]_q^h, \end{aligned} \quad (49)$$

and on the other hand

$$\begin{aligned} (\lambda^{-1}q^{k+1} + h\lambda q[k + 1]_q)\lambda q^{-2k}[k + 1]_q[\beta + 1 - k]_q^h - h\lambda q^2[k + 1]_q\lambda q^{-2k}[\beta]_q^h \\ = q^{1-k}[k + 1]_q[\beta - k + 1]_q^h + h\lambda^2 q^{1-2k}[k + 1]_q[k + 1]_q[\beta - k + 1]_q^h \\ - h\lambda^2 q^{2-2k}[k + 1]_q[\beta]_q^h \end{aligned}$$

$$\begin{aligned}
 &= q^{-k}[\beta - k]_q^h[k + 1]_q - h\lambda q^{1-2k}[k + 1]_q \\
 &\quad + h\lambda^2 q^{1-2k}[k + 1]_q([k]_q[\beta - k]_q^h + q^{-1-k}[\beta - k]_q^h - h\lambda q^{-k}[k + 1]_q) \\
 &\quad - h\lambda^2 q^{2-2k}[k + 1]_q[\beta]_q^h,
 \end{aligned}$$

using (47) and (48). We remark that the first and third terms coincide with (49). We gather the remaining terms, putting $h\lambda q^{-2k}[k + 1]_q$ in evidence, so that we obtain

$$\begin{aligned}
 &-q + \lambda q^{-k}[\beta - k]_q^h - h\lambda^2 q^{1-k}[k + 1]_q - \lambda q^2[\beta]_q^h \\
 &= \frac{1}{q^{-1} - q}(-q(q^{-1} - q) + \lambda q^{-k}(\lambda^{-1}q^k + h\lambda q^{-k}) \\
 &\quad - h\lambda^2 q^{1-k}(q^{-k-1} - q^{k+1}) - \lambda q^2(\lambda^{-1} + h\lambda)) = 0.
 \end{aligned}$$

Finally, for $\text{gdim } T_k^{\lambda,1} 1_{1,k-1}$, we verify that

$$\lambda q^{-2k}[k + 1]_q[\beta - k]_q^h(-h\lambda q^2[k]_q) = -h\lambda q^2[k + 1]_q \lambda q^{-2k}[k]_q[\beta - k]_q^h,$$

concluding the proof in the case $\ell = 0$ and $r = 1$.

The case $\ell > 0$ comes from an induction on ℓ and using the case $\ell = 0$. Using a similar decomposition as in Lemma A.1, we obtain

$$\begin{aligned}
 \text{gdim } X_{k,\ell} &= \lambda^{-1}q^{2k+\ell} \text{gdim } T_{k+\ell}^{\lambda,0} + \lambda q^{-2\ell-2k-2}[k]_q[\beta - k + 1]_q^h \text{gdim } X_{k-1,\ell} \\
 &\quad + \lambda q^{-2k-2\ell}[\ell]_q[\beta - 2k - \ell]_q^h \text{gdim } X_{k,\ell-1},
 \end{aligned}$$

where $X_{k,\ell} := X_k 1_{k,\ell}$. Similarly, one can compute

$$\begin{aligned}
 \text{gdim } T_{k+\ell}^{\lambda,1} 1_{0,k+\ell} &= q^{k+\ell} \text{gdim } T_{k+\ell}^{\lambda,0} \\
 &\quad + \lambda q^{-2k-2\ell}[k + \ell]_q[\beta - k - \ell]_q^h \text{gdim } T_{k+\ell-1}^{\lambda,1} 1_{0,k+\ell-1},
 \end{aligned}$$

$$\begin{aligned}
 \text{gdim } T_{k+\ell}^{\lambda,1} 1_{1,k+\ell-1} &= q^{k+\ell-1} \text{gdim } T_{k+\ell}^{\lambda,0} + \lambda q^{2-2(k+\ell)}[\beta]_q^h \text{gdim } T_{k+\ell-1}^{\lambda,1} 1_{0,k+\ell-1} \\
 &\quad + \lambda q^{-2k-2\ell}[k + \ell - 1]_q[\beta - k - \ell - 1]_q^h \text{gdim } T_{k+\ell-1}^{\lambda,1} 1_{1,k+\ell-2}.
 \end{aligned}$$

By the same reasons as above, the part in $\text{gdim } T_{k+\ell}^{\lambda,0}$ annihilates each others. By induction hypothesis we know that

$$\begin{aligned}
 \text{gdim } X_{k,\ell-1} &= (\lambda^{-1}q^k + h\lambda q[k]_q) \text{gdim } T_{k+\ell-1}^{\lambda,1} 1_{0,k+\ell-1} \\
 &\quad - h\lambda q^2[k]_q \text{gdim } T_{k+\ell-1}^{\lambda,1} 1_{1,k+\ell-2}.
 \end{aligned}$$

Using the fact that

$$\begin{aligned}
 [k + \ell]_q [\beta - k - \ell]_q^h &= [k]_q [\beta - k]_q^h + [\ell]_q [\beta - 2k - \ell]_q^h, \\
 [k + \ell - 1]_q [\beta - k - \ell - 1]_q^h &= [k - 1]_q [\beta - k + 1]_q^h + [\ell]_q [\beta - 2k - \ell]_q^h,
 \end{aligned}$$

together with the induction hypothesis, we cancel the part given by $\text{gdim}(X_{k,\ell-1})$ in $X_{k,\ell}$ with the part given by

$$\lambda q^{-2k-2\ell} [\ell]_q [\beta - 2k - \ell]_q^h \text{gdim } T_{k+\ell-1}^{\lambda,1} 1_{0,k+\ell-1}$$

in $Y_{k,\ell}^0$ minus the part given by

$$\lambda q^{-2k-2\ell} [\ell]_q [\beta - 2k - \ell]_q^h \text{gdim } T_{k+\ell-1}^{\lambda,1} 1_{1,k+\ell-2}.$$

in $Y_{k,\ell}^1$.

The remaining terms yields the same computations as for the case $\ell = 0$ (replacing $k + 1$ by k), but shifting everything by $q^{-2\ell}$. Thus, it concludes the case $\ell > 0$.

The general case follows from a similar argument, using the fact that X decomposes similarly to $T_b^{\lambda,r}$ whenever $r > 1$, that is as in Corollary 3.12, replacing all T by X . We leave the details to the reader. \square

A.3. Proofs of §6

Lemma 6.12. *As a right $(T^{\lambda,r}, 0)$ -module, $1_{1,k+\ell-1,\rho} X$ is generated by the elements*

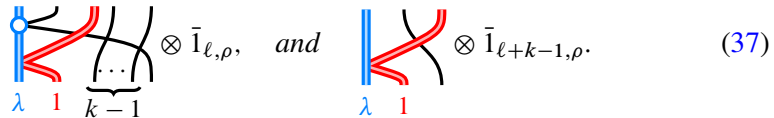

Proof. We prove this claim using an induction on k . The case $k = 1$ is obvious. We suppose it is true for $k - 1$, and thus it is enough to show that we can generate the element:

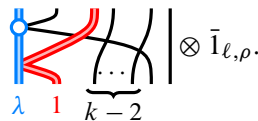

Using (19), we have

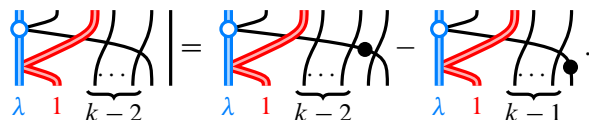

The second term on the right-hand side is generated by the second element in (37). For the first term of the right-hand side, we slide the dot to the left using repeatedly (19):

$$\begin{array}{c} \text{Diagram 1} \end{array} = \begin{array}{c} \text{Diagram 2} \end{array} - \sum_{j=1}^{k-2} \begin{array}{c} \text{Diagram 3} \end{array}$$

Because of the symmetric of (44), the first term on the right-hand side is generated by the second element in (37). We now prove that every element of the sum on the right-hand side is generated by elements in (37).

By applying the induction hypothesis, it suffices to show that for every $1 \leq j \leq k - 2$, the elements

$$\begin{array}{c} \text{Diagram 4} \end{array} \quad \text{and} \quad \begin{array}{c} \text{Diagram 5} \end{array}$$

are in the right module generated by the elements in (37), which is clear for the first diagram. Concerning the second one, we have by (19)

$$\begin{array}{c} \text{Diagram 6} \end{array} = \begin{array}{c} \text{Diagram 7} \end{array} - \begin{array}{c} \text{Diagram 8} \end{array}$$

For the first term of the right-hand side, we again slide the dot to the left using (19) and obtain

$$\begin{array}{c} \text{Diagram 9} \end{array} = \begin{array}{c} \text{Diagram 10} \end{array} - \sum_{l=0}^{k-j-3} \begin{array}{c} \text{Diagram 11} \end{array}$$

$$\stackrel{(18)}{=} \begin{array}{c} \text{Diagram 12} \end{array} - \sum_{l=0}^{k-j-3} \begin{array}{c} \text{Diagram 13} \end{array}$$

Another application of the symmetry of (44) deals with the first term, and every term of the sum is handled through a descending induction on j , noting that the sum is zero if $j = k - 2$.

For the second term, we apply once again (18) and obtain

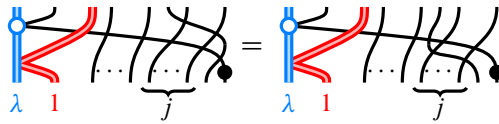

which has the desired form. □

A.3.1. Acyclicity of Cone(φ)

Theorem 6.7. *The map*

$$\varphi := \sum_{k=0}^m (-1)^k \varphi_k : \text{Cone}(\lambda q^2 X[1] \xrightarrow{u} q^2 T_b^{\lambda,r} [1])[1] \longrightarrow \text{Cone}(X \otimes_T^L X \xrightarrow{1 \otimes u} \lambda^{-1} X),$$

is a quasi-isomorphism.

The goal of this section is to prove Theorem 6.7, which we will achieve by showing that $\text{Cone}(\varphi_k)$ is acyclic. We have that $\text{Cone}(\varphi_k)$ is given by the complex

$$\begin{array}{ccccc} & & X \otimes_T Y_k^1 & & \\ & \nearrow \varphi_k^1 & & \searrow 1 \otimes \iota_k & \\ \lambda q^2(X_k)[1] & & & & X \otimes_T Y_k^0 \xrightarrow{u \otimes \gamma_k} \lambda^{-1} X_k \\ & \searrow -u & & \nearrow \varphi_k^0 & \\ & & \bigoplus_{\ell, \rho} q^2(T_b^{\lambda,r} 1_{k, \ell, \rho})[1] & & \end{array}$$

The map $\varphi_k^1 - u$ is injective since u is injective by Corollary 5.6, and the map $u \otimes \gamma_k$ is surjective. We want to first show that $\varphi_k^0 + 1 \otimes \iota_k$ is surjective on the kernel of $u \otimes \gamma_k$. This requires some preparation.

Lemma A.2. *For $k \geq 2$, the local relation*

$$\text{Diagram} = \sum_{s=0}^{k-2} (-1)^s \text{Diagram} = (-1)^{k-1} \text{Diagram} \tag{50}$$

holds in $T^{\lambda,r}$.

Proof. We prove the statement by induction on $k - 2$. If $k - 2 = 0$, then the claim follows from (23). Suppose by induction that (50) holds for $k - 3$. We compute

$$\begin{array}{c}
 \begin{array}{ccc}
 \text{Diagram 1} & \stackrel{(23)}{=} & \text{Diagram 2} - \text{Diagram 3} \\
 \underbrace{\hspace{1.5cm}}_{1 \quad k-2} & & \underbrace{\hspace{1.5cm}}_{1 \quad k-2} \quad \underbrace{\hspace{1.5cm}}_{1 \quad k-2}
 \end{array}
 \end{array} \tag{51}$$

and

$$\begin{array}{c}
 \begin{array}{ccc}
 \text{Diagram 4} & \stackrel{(19), (18)}{=} & \text{Diagram 5} \\
 \underbrace{\hspace{1.5cm}}_{1 \quad k-2} & & \underbrace{\hspace{1.5cm}}_{1 \quad k-3}
 \end{array}
 \end{array} \tag{52}$$

$$\begin{array}{c}
 \begin{array}{cccc}
 \text{Diagram 6} & \stackrel{(21)}{=} & \text{Diagram 7} & \stackrel{(23)}{=} & \text{Diagram 8} & \stackrel{(21)}{=} & \text{Diagram 9} \\
 \underbrace{\hspace{1.5cm}}_{1 \quad k-2} & & \underbrace{\hspace{1.5cm}}_{1 \quad k-2} & & \underbrace{\hspace{1.5cm}}_{1 \quad k-2} & & \underbrace{\hspace{1.5cm}}_{1 \quad k-2}
 \end{array}
 \end{array} \tag{53}$$

Applying the induction hypothesis on (52), and inserting the result together with (53) in (51) gives (50). \square

Lemma A.3. *We have*

$$\begin{array}{c}
 \text{Diagram 10} \\
 \underbrace{\hspace{1.5cm}}_{z_{t+2}}
 \end{array} = \begin{array}{c} \text{Diagram 11} \\ \dots \\ \text{Diagram 12} \end{array} \tag{54}$$

for all $t \geq 0$.

Proof. We prove the statement by induction on t . The claim is clearly true for $t = 0$. Suppose it is true for t . We compute

$$\begin{array}{c}
 \text{Diagram 13} \\
 \underbrace{\hspace{1.5cm}}_{z_{t+3}}
 \end{array} \stackrel{(34)}{=} \begin{array}{c} \text{Diagram 14} \\ \underbrace{\hspace{1.5cm}}_{z_{t+2}} \end{array} + \begin{array}{c} \text{Diagram 15} \\ \underbrace{\hspace{1.5cm}}_{z_{t+2}} \end{array}$$

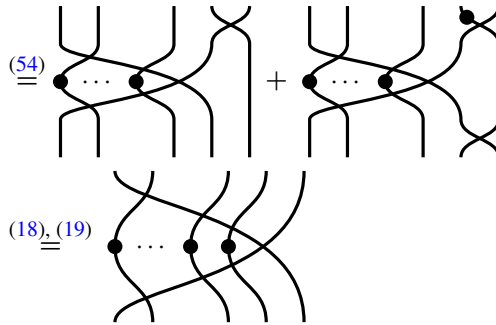

concluding the proof. □

Lemma A.4. *We have*

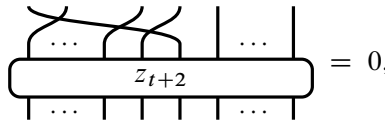

for all $t \geq 0$.

Proof. It is a direct consequence of Lemma A.3 together with (18). □

Lemma A.5. *We have*

$$\begin{aligned} \varphi_k^0 \left(\left[\text{Diagram with } \lambda, \overbrace{\dots}^{k-1}, 1 \right] \otimes \bar{1}_{\ell, \rho} \right) &= \sum_{s=0}^{k-2} (-1)^s (1 \otimes \iota_k^{k-1}) \left(\left[\text{Diagram with } \lambda, 1, \overbrace{\dots}^s \right] \otimes \bar{1}_{\ell, \rho} \right) \\ &= (-1)^{k-1} \left(- \left[\text{Diagram 1} \right] \otimes \bar{1}_{\ell, \rho} + \left[\text{Diagram 2} \right] \otimes \bar{1}_{\ell+k-1, \rho} \right) \\ &\in (X \otimes_T Y_k^{\prime 0}) \oplus (X \otimes_T Y_k^{0, k-1}). \end{aligned} \tag{55}$$

Proof. The case $k = 1$ is clear, thus we assume $k > 1$. First, let us write \star and \star_s for the inputs of φ_k^0 and of $1 \otimes \iota_k^{k-1}$ in (55), respectively. Then, on one hand, we note that $\varphi_k^{0, t'}(\star) = 0$ by Lemma A.4 whenever $t' \neq k - 1$, because of (18). For

$t' = k - 1$, we obtain

$$\varphi_k^{0,k-1}(\star) = \left(\text{Diagram} \right) \otimes \bar{1}_{\ell,\rho} \tag{56}$$

using (18) and (19). Similarly, using Lemma A.4, we get

$$\varphi_k^{0'}(\star) = \left(\text{Diagram} \right) \otimes \bar{1}_{\ell,\rho}. \tag{57}$$

On the other hand, we compute

$$\begin{aligned} & (1 \otimes t_k^{k-1})(\star_s) \\ &= (-1)^s \left(\left(\text{Diagram 1} \right) \otimes \bar{1}_{\ell,\rho}, \dots, \left(\text{Diagram 2} \right) \otimes \bar{1}_{\ell,\rho} \right) \\ &= (-1)^s \left(\left(\text{Diagram 1} \right) \otimes \bar{1}_{\ell,\rho}, \dots, \left(\text{Diagram 2} \right) \otimes \bar{1}_{\ell,\rho} \right) \end{aligned} \tag{58}$$

using (21) and (33). Then, we conclude by observing that (55) follows by applying Lemma A.2 on (56), (57), and (58) together. \square

Lemma A.6. *As a left $(T^{\lambda,r}, 0)$ -module, $\ker(u \otimes \gamma_k)$ is generated by the elements*

$$\left(- \left(\begin{array}{c} \text{Diagram 1} \\ \lambda \quad 1 \quad t \end{array} \right) \otimes \bar{1}_{\ell+k-1-t,\rho}, \quad \left(\begin{array}{c} \text{Diagram 2} \\ \lambda \quad 1 \end{array} \right) \otimes \bar{1}_{\ell+k-1,\rho} \right) \tag{59}$$

$$\in (X \otimes_T Y_k^0) \oplus (X \otimes_T Y_k^{0,t})$$

for all $0 \leq t \leq k - 1$.

Proof. Let $K \subset X \otimes_T Y_k^0$ be the submodule generated by the elements in (59). A straightforward computation shows that $K \subset \ker(u \otimes \gamma_k)$. Thus, we have a complex

$$0 \longrightarrow K \hookrightarrow X \otimes_T Y_k^0 \xrightarrow{u \otimes \gamma_k} \lambda^{-1} X_k \longrightarrow 0, \tag{60}$$

where the left arrow is an injection and the right arrow is a surjection. Furthermore, by Theorem 5.5, we have that

$$K \cong \lambda^{-1} Y_k^1, \quad X \otimes_T Y_k^0 \cong \lambda^{-1} Y_k^0.$$

Therefore, by Lemma 5.8 we obtain that the sequence in (60) is exact. In particular, we have $K = \ker(u \otimes \gamma_k)$. □

Proposition A.7. *We have $\ker(u \otimes \gamma_k) = \text{im}(\varphi_k^0 + 1 \otimes \iota_k)$.*

Proof. We will show by backward induction on t that the elements (59) are all in $\text{im}(\varphi_k^0 + 1 \otimes \iota_k)$. The case $t = k - 1$ is Lemma A.5. The induction step is essentially similar to the proof of Lemma A.5. In particular, we want to show that (59) is in $\bigcup_{t' \geq t} \text{im}(\varphi_k^0 + 1 \otimes \iota_k^{t'})$. For this, we write

$$\star := \left(\begin{array}{c} \text{Diagram 3} \\ \lambda \quad t \quad 1 \end{array} \right) \otimes \bar{1}_{\ell,\rho}$$

Then, we compute using Lemma A.4 and Lemma A.3

$$\varphi_k^{0,t'}(\star) = \begin{cases} \text{Diagram 1} & \text{if } t' < t, \\ \text{Diagram 2} \otimes \bar{1}_{\ell,\rho} & \text{if } t' = t, \\ \text{Diagram 3} \otimes \bar{1}_{\ell,\rho} & \text{if } t' > t, \end{cases}$$

Diagram 1: A vertical blue line on the left with a red line crossing it. Below the blue line are labels λ and 1 . To the right, a bracket groups $k-1$ strands. A red line loops around the top of these strands.

Diagram 2: Similar to Diagram 1, but with a red line that loops around the top of t strands.

Diagram 3: Similar to Diagram 2, but with a box labeled $z_{k-t'}$ on the right side of the t strands.

for $0 \leq t' \leq k-1$, and

$$\varphi_k^{\prime 0}(\star) = - \left(\text{Diagram 1} \otimes \bar{1}_{\ell,\rho} - \sum_{t'=t+1}^{k-1} \text{Diagram 3} \otimes \bar{1}_{\ell,\rho} \right)$$

Thus, since $t' > t$, by induction hypothesis we know that

$$\varphi_k^0(\star) \equiv \left(- \left(\text{Diagram 1} \otimes \bar{1}_{\ell,\rho} - \text{Diagram 2} \otimes \bar{1}_{\ell,\rho} \right) \right) + \text{im}(\varphi_k^0 + 1 \otimes l_k) \in (X \otimes_T Y_0') \oplus (X \otimes_T Y_k^{0,t}).$$

Then, by the same arguments as in Lemma A.5, that is using (50), we obtain (59).

□

Lemma A.8. *The map φ_k^0 is injective.*

Proof. Since adding black/red crossings is injective, it is enough because of Lemma A.3 to show that the left $T_k^{\lambda,0}$ -module map

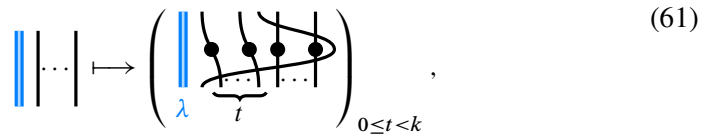
$$T_k^{\lambda,0} \longrightarrow \bigoplus_{t=0}^{k-1} q^{2(k-1-t)} T_k^{\lambda,0},$$

(61)

is injective. Since $T_k^{\lambda,0}$ is isomorphic to the dg-enhanced nilHecke algebra of [37], we know by the results in [37, Proposition 2.5] that there is a decomposition

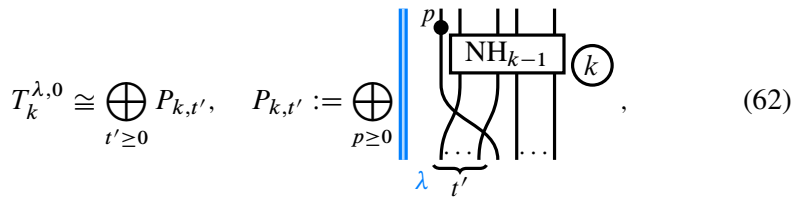
$$T_k^{\lambda,0} \cong \bigoplus_{t' \geq 0} P_{k,t'}, \quad P_{k,t'} := \bigoplus_{p \geq 0} \text{Diagram}(p, \lambda, t'),$$

(62)

where the box labeled NH_{k-1} is the nilHecke algebra, and the circle labeled k is the algebra generated by labeled floating dots in the rightmost region (see [37, §2.4]). These floating dots correspond to combinations of nails, dots and crossings, giving elements that are in the (graded with respect to the homological degree) center of $T_k^{\lambda,0}$.

Furthermore, the map

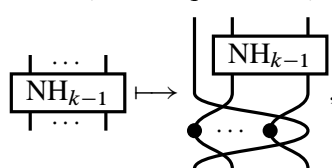
$$NH_{k-1} \longrightarrow q^{2k-2} NH_k,$$

is injective (this can be deduced by sliding all dots to the bottom using (19), and then using a basis theorem as for example in [21, Theorem 2.5] to see the map takes the form of a column echelon matrix with 1 as pivots).

Then, applying (61) on $P_{k,t'}$ yields

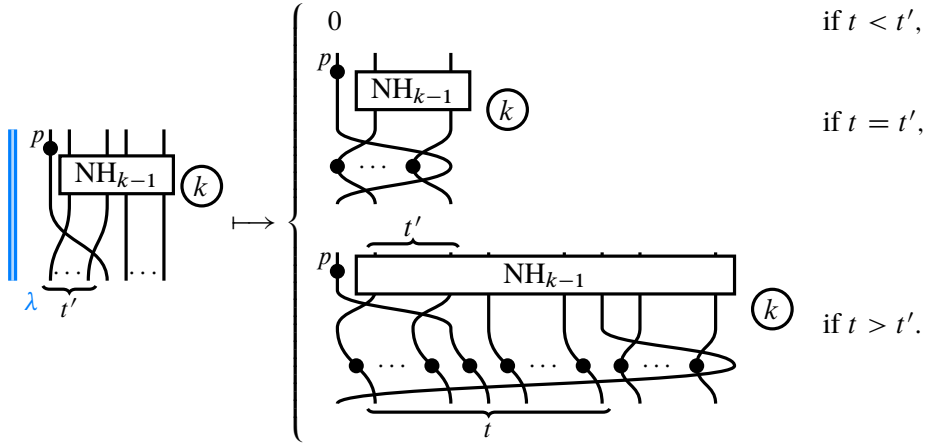

Therefore, after decomposing $T_k^{\lambda,0}$, (61) yields a column echelon form matrix with injective maps as pivots, and thus is injective. \square

Proposition A.9. We have $\ker((1 \otimes \iota_k) + \varphi_k^0) = \text{im}(\varphi_k^1 - u)$.

Proof. First, recall that ι_k is injective (as explained in §5.4). Thus, both $(1 \otimes \iota_k)$ and φ_k^0 are injective, and we get

$$\ker((1 \otimes \iota_k) + \varphi_k^0) \cong \text{im}(1 \otimes \iota_k) \cap \text{im}(\varphi_k^0).$$

We observe that $\text{im}(1 \otimes \iota_k) \cap \text{im}(\varphi_k^0) \cap (X \otimes_T Y_k^{0,t'})$ is generated by

$$\begin{aligned} \varphi_k^{0,t} \left(\begin{array}{c} \text{Diagram with blue strand } \lambda \text{ and red strand } 1 \end{array} \right) \otimes \bar{\Gamma}_{\ell,\rho} &= (1 \otimes \iota_k^t) \left(\begin{array}{c} \text{Diagram with blue strand } \lambda \text{ and red strand } 1 \end{array} \right) \otimes \bar{\Gamma}_{\ell,\rho} \\ &= \begin{array}{c} \text{Diagram with blue strand } \lambda \text{ and red strand } 1 \end{array} \otimes \bar{\Gamma}_{\ell,\rho}. \end{aligned}$$

and by

$$\varphi_k^{0,t} \left(\begin{array}{c} \text{Diagram with blue strand } \lambda \text{ and red strand } 1 \end{array} \right) \otimes \bar{\Gamma}_{\ell,\rho} = (1 \otimes \iota_k^t) \left(\begin{array}{c} \text{Diagram with blue strand } \lambda \text{ and red strand } 1 \end{array} \right) \otimes \bar{\Gamma}_{\ell,\rho}$$

$$= \text{Diagram} \otimes \bar{1}_{\ell, \rho}$$

Moreover, we have

$$\begin{aligned} \varphi_k^{1,t} \left(\text{Diagram} \otimes \bar{1}_{\ell, \rho} \right) &= \text{Diagram} \otimes \bar{1}_{\ell, \rho} \\ u \left(\text{Diagram} \otimes \bar{1}_{\ell, \rho} \right) &= \text{Diagram} \otimes \bar{1}_{\ell, \rho} \end{aligned}$$

The case with a nail is similar, concluding the proof. □

Proof of Theorem 6.7. Since $\varphi_k^1 - u$ is injective, and $u \otimes \gamma_k$ is surjective, and by Proposition A.7 and Proposition A.9, we conclude that $\text{Cone}(\varphi_k)$ is acyclic for all k . Consequently, φ is a quasi-isomorphism. □

A.3.2. The bimodule map $\tilde{\varphi}$

Theorem 6.9. *The map φ is a map of \mathbb{Z}^2 -graded $(T^{\lambda,r}, 0) - (T^{\lambda,r}, 0) - A_\infty$ -bimodules.*

The goal of this section is to prove Theorem 6.9. To this end, we first prove that the map $\tilde{\varphi}^0: q^2(T_b^{\lambda,r})[1] \rightarrow X \otimes_T X$ is a map of bimodules.

Proposition A.10. *We have*

$$\tilde{\varphi}^0 \left(\text{Diagram} \otimes \bar{1}_{\ell, \rho} \right) = (-1)^k \text{Diagram} \otimes \bar{1}_{\ell, \rho}$$

where

$$\tilde{\varphi}(0) := \text{Diagram} := 0$$

$$\begin{aligned}
 \tilde{\varphi}(1) &:= \boxed{\tilde{\varphi}(1)} := \text{Diagram 1} - \text{Diagram 2}, \\
 \tilde{\varphi}(t+2) &:= \boxed{\tilde{\varphi}(t+2)} := \boxed{\tilde{\varphi}(t+1)} + \boxed{\tilde{\varphi}(t+1)} + \boxed{\tilde{\varphi}(t+1)},
 \end{aligned}$$

for all $t \geq 0$.

Proof. Recall that

$$\tilde{\varphi}^0 := (1 \otimes \gamma) \circ \varphi^0.$$

Then, we obtain

$$\begin{aligned}
 &(1 \otimes \gamma) \circ \varphi^0 \left(\text{Diagram with } \lambda \text{ blue strands, } k \text{ black strands, and } 1 \text{ red strand} \otimes \bar{1}_{\ell, \rho} \right) \\
 &= (-1)^k \sum_{t=0}^{k-1} \left(\text{Diagram 1} \otimes \bar{1}_{\ell, \rho} - \text{Diagram 2} \otimes \bar{1}_{\ell, \rho} \right) \tag{63}
 \end{aligned}$$

We prove the statement by induction on k . The claim is clearly true for $k = 0$ and $k = 1$. Suppose it is true for $k + 1$, and we will show it is true for $k + 2$.

By definition of $\tilde{\varphi}(k + 2)$ and using (19), we have

$$\begin{array}{c} \lambda \quad \dots \quad \lambda \\ \hline \tilde{\varphi}(k + 2) \\ \hline \dots \quad \dots \quad 1 \end{array} = \begin{array}{c} \lambda \quad \dots \quad \lambda \\ \hline \tilde{\varphi}(k + 1) \\ \hline \dots \quad \dots \quad 1 \end{array} + \begin{array}{c} \lambda \quad \dots \quad \lambda \\ \hline \tilde{\varphi}(k + 1) \\ \hline \dots \quad \dots \quad 1 \end{array} \cdot \quad (64)$$

Applying the induction hypothesis on (64), we get

$$\begin{array}{c} \lambda \quad \dots \quad \lambda \\ \hline \tilde{\varphi}(k + 2) \\ \hline \dots \quad \dots \quad 1 \end{array} = \sum_{t=0}^{k-1} \left(\begin{array}{c} \dots \quad \dots \quad z_{k+1-t} \\ \hline \dots \quad \dots \quad \dots \\ \hline \lambda \quad \underbrace{\dots}_{t} \quad 1 \end{array} + \begin{array}{c} \dots \quad \dots \quad z_{k+1-t} \\ \hline \dots \quad \dots \quad \dots \\ \hline \lambda \quad \underbrace{\dots}_{t} \quad 1 \end{array} \right) \\
 + \begin{array}{c} \dots \quad \dots \quad \dots \\ \hline \dots \quad \dots \quad \dots \\ \hline \lambda \quad \underbrace{\dots}_{k} \quad 1 \end{array} + \begin{array}{c} \dots \quad \dots \quad \dots \\ \hline \dots \quad \dots \quad \dots \\ \hline \lambda \quad \underbrace{\dots}_{k} \quad 1 \end{array}$$

– (similar terms with the nail above).

Applying (34) on each pair of terms in the sum (including non-displayed terms) gives the part for $0 \leq t < k - 2$ in (63) for $k + 2$. The last two terms (including non-displayed terms) give $t = k$ and $t = k + 1$, since z_2 is a single crossing, concluding the proof. \square

Having Proposition A.10, proving Theorem 6.9 boils down to proving that the left and right action by the same element of $T_b^{\lambda,r}$ on

$$\sum_{k+\ell+|\rho|=b} (-1)^k \tilde{\varphi}(k) \otimes \bar{1}_{\ell,\rho}$$

coincide.

Lemma A.11. *We have*

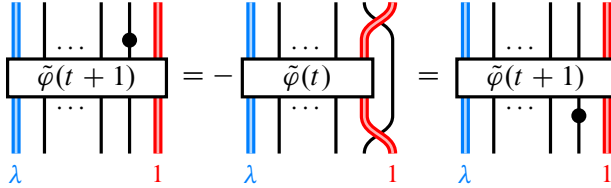

for all $t \geq 0$.

Proof. We show the first equality, and the second one follows by symmetry along the horizontal axis of the definition of $\tilde{\varphi}(t+1)$.

We prove the statement by induction on t . The case $t = 0$ follows from (44). Suppose the claim is true for $t \geq 0$. We compute using (64)

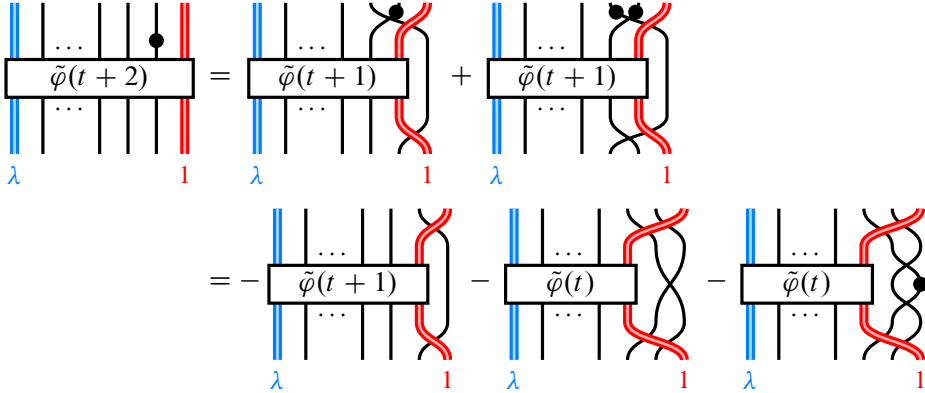

where the last two terms annihilate each other, concluding the proof. □

Lemma A.12. *We have*

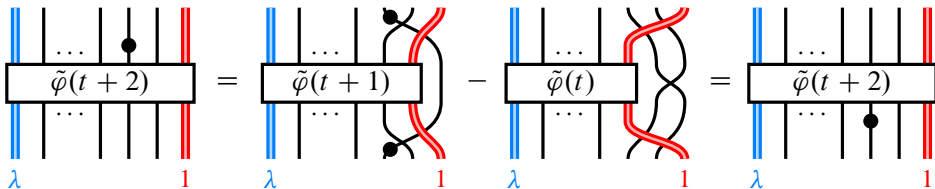

for all $t \geq 0$.

Proof. By (64), we have

$$\begin{array}{c}
 \begin{array}{|c|} \hline \tilde{\varphi}(t+2) \\ \hline \end{array} \\
 \begin{array}{c} \dots \\ \dots \\ \bullet \\ \dots \\ \dots \end{array} \\
 \begin{array}{c} \lambda \\ \dots \\ 1 \end{array}
 \end{array}
 =
 \begin{array}{c}
 \begin{array}{|c|} \hline \tilde{\varphi}(k+1) \\ \hline \end{array} \\
 \begin{array}{c} \dots \\ \dots \\ \bullet \\ \dots \\ \dots \end{array} \\
 \begin{array}{c} \lambda \\ \dots \\ 1 \end{array}
 \end{array}
 +
 \begin{array}{c}
 \begin{array}{|c|} \hline \tilde{\varphi}(k+1) \\ \hline \end{array} \\
 \begin{array}{c} \dots \\ \dots \\ \bullet \\ \dots \\ \dots \end{array} \\
 \begin{array}{c} \lambda \\ \dots \\ 1 \end{array}
 \end{array}
 .$$

We conclude by applying Lemma A.11. □

Lemma A.13. *We have*

$$\begin{array}{c}
 \begin{array}{|c|} \hline \tilde{\varphi}(t+2) \\ \hline \end{array} \\
 \begin{array}{c} \dots \\ \dots \\ \dots \\ \dots \end{array} \\
 \begin{array}{c} \lambda \\ \dots \\ 1 \end{array}
 \end{array}
 =
 \begin{array}{c}
 \begin{array}{|c|} \hline \tilde{\varphi}(t+1) \\ \hline \end{array} \\
 \begin{array}{c} \dots \\ \dots \\ \dots \\ \dots \end{array} \\
 \begin{array}{c} \lambda \\ \dots \\ 1 \end{array}
 \end{array}
 =
 \begin{array}{c}
 \begin{array}{|c|} \hline \tilde{\varphi}(t+2) \\ \hline \end{array} \\
 \begin{array}{c} \dots \\ \dots \\ \dots \\ \dots \end{array} \\
 \begin{array}{c} \lambda \\ \dots \\ 1 \end{array}
 \end{array}$$

for all $t \geq 0$.

Proof. This is immediate by applying (18) on the definition of $\tilde{\varphi}(t+2)$. □

Lemma A.14. *We have*

$$\begin{array}{c}
 \begin{array}{|c|} \hline \tilde{\varphi}(t+3) \\ \hline \end{array} \\
 \begin{array}{c} \dots \\ \dots \\ \dots \\ \dots \end{array} \\
 \begin{array}{c} \lambda \\ \dots \\ 1 \end{array}
 \end{array}
 =
 \begin{array}{c}
 \begin{array}{|c|} \hline \tilde{\varphi}(t+3) \\ \hline \end{array} \\
 \begin{array}{c} \dots \\ \dots \\ \dots \\ \dots \end{array} \\
 \begin{array}{c} \lambda \\ \dots \\ 1 \end{array}
 \end{array}$$

for all $t \geq 0$.

Proof. By (64) we have

$$\begin{array}{c}
 \begin{array}{|c|} \hline \tilde{\varphi}(t+3) \\ \hline \end{array} \\
 \begin{array}{c} \dots \\ \dots \\ \dots \\ \dots \end{array} \\
 \begin{array}{c} \lambda \\ \dots \\ 1 \end{array}
 \end{array}
 =
 \begin{array}{c}
 \begin{array}{|c|} \hline \tilde{\varphi}(t+2) \\ \hline \end{array} \\
 \begin{array}{c} \dots \\ \dots \\ \dots \\ \dots \end{array} \\
 \begin{array}{c} \lambda \\ \dots \\ 1 \end{array}
 \end{array}
 +
 \begin{array}{c}
 \begin{array}{|c|} \hline \tilde{\varphi}(t+2) \\ \hline \end{array} \\
 \begin{array}{c} \dots \\ \dots \\ \bullet \\ \dots \\ \dots \end{array} \\
 \begin{array}{c} \lambda \\ \dots \\ 1 \end{array}
 \end{array}
 .$$

Then, we compute

$$\begin{array}{c}
 \begin{array}{c} \dots \\ \boxed{\tilde{\varphi}(t+2)} \\ \dots \end{array} \\
 \lambda \qquad \qquad \qquad 1
 \end{array}
 =
 \begin{array}{c} \dots \\ \boxed{\tilde{\varphi}(t+1)} \\ \dots \end{array}
 +
 \begin{array}{c} \dots \\ \boxed{\tilde{\varphi}(t+1)} \\ \dots \end{array}
 +
 \begin{array}{c} \dots \\ \boxed{\tilde{\varphi}(t+1)} \\ \dots \end{array}$$

and

$$\begin{array}{c}
 \begin{array}{c} \dots \\ \boxed{\tilde{\varphi}(t+2)} \\ \dots \end{array} \\
 \lambda \qquad \qquad \qquad 1
 \end{array}
 =
 \begin{array}{c} \dots \\ \boxed{\tilde{\varphi}(t+1)} \\ \dots \end{array}
 +
 \begin{array}{c} \dots \\ \boxed{\tilde{\varphi}(t+1)} \\ \dots \end{array}
 +
 \begin{array}{c} \dots \\ \boxed{\tilde{\varphi}(t+1)} \\ \dots \end{array}$$

Furthermore, we compute mainly using (18) and (19),

$$\begin{array}{c} \dots \\ \boxed{\tilde{\varphi}(t+1)} \\ \dots \end{array}
 = -
 \begin{array}{c} \dots \\ \boxed{\tilde{\varphi}(t+1)} \\ \dots \end{array}$$

and

$$\begin{array}{c} \dots \\ \boxed{\tilde{\varphi}(t+1)} \\ \dots \end{array}
 =
 \begin{array}{c} \dots \\ \boxed{\tilde{\varphi}(t+1)} \\ \dots \end{array}$$

In conclusion, we get

$$\tilde{\varphi}(t+3) = \tilde{\varphi}(t+1) + \tilde{\varphi}(t+1) + \tilde{\varphi}(t+1) + \tilde{\varphi}(t+1)$$

which is symmetric with respect to taking the mirror image along the horizontal axis. Therefore, we get the same a crossing at the bottom of $\tilde{\varphi}(t+3)$, finishing the proof. \square

Lemma A.15. *We have*

$$\tilde{\varphi}(t+1) = -\tilde{\varphi}(t)$$

for all $t \geq 0$.

Proof. We prove the statement by induction on t . The case $t = 0$ follows from (33). We suppose the claim is true for $t \geq 0$. We compute using the mirror of (64),

$$\tilde{\varphi}(t+2) = \tilde{\varphi}(t+1) + \tilde{\varphi}(t+1)$$

$$\begin{aligned}
 &= \begin{array}{c} \dots \\ \boxed{\tilde{\varphi}(t+1)} \\ \dots \\ \lambda \quad \dots \quad 1 \end{array} + \begin{array}{c} \dots \\ \boxed{\tilde{\varphi}(t+1)} \\ \dots \\ \lambda \quad \dots \quad 1 \end{array} \\
 &\quad - \begin{array}{c} \dots \\ \boxed{\tilde{\varphi}(t+1)} \\ \dots \\ \lambda \quad \dots \quad 1 \end{array} .
 \end{aligned}$$

Then, we have

$$\begin{array}{c} \dots \\ \boxed{\tilde{\varphi}(t+1)} \\ \dots \\ \lambda \quad \dots \quad 1 \end{array} = - \begin{array}{c} \dots \\ \boxed{\tilde{\varphi}(t)} \\ \dots \\ \lambda \quad \dots \quad 1 \end{array} = 0,$$

by induction hypothesis. Finally, we obtain

$$\begin{array}{c} \dots \\ \boxed{\tilde{\varphi}(t+1)} \\ \dots \\ \lambda \quad \dots \quad 1 \end{array} - \begin{array}{c} \dots \\ \boxed{\tilde{\varphi}(t+1)} \\ \dots \\ \lambda \quad \dots \quad 1 \end{array} = - \begin{array}{c} \dots \\ \boxed{\tilde{\varphi}(t+1)} \\ \dots \\ \lambda \quad \dots \quad 1 \end{array}$$

finishing the proof. □

Proposition A.16. *The map $\tilde{\varphi}^0$ is a map of dg-bimodules.*

Proof. As already mentioned above, it is enough to show that the left and right action by the same element of $T_b^{\lambda,r}$ on

$$\sum_{k+\ell+|\rho|=b} (-1)^k \tilde{\varphi}(k) \otimes \bar{1}_{\ell,\rho}$$

coincide. We obtain commutation with dots and crossings by induction on k , using Lemmas A.11–A.15. The commutation with a nail also comes from a straightforward induction on k , where the base case is immediate by (26). □

B. Homological toolbox

The goal of this section is to recall and briefly explain the tools from homological algebra which we use in this paper. The main references for this section are [15], [46], and [33] (see also [47], [16] and [34, Appendix A]).

B.1. Derived category. Let (A, d_A) be a \mathbb{Z}^n -graded dg-algebra (with the same conventions as in §3.1).

The *derived category* $\mathcal{D}(A, d_A)$ of (A, d_A) is the localization of the category (A, d_A) -mod of \mathbb{Z}^n -graded (left) (A, d_A) -dg-modules along quasi-isomorphisms. It is a triangulated category with translation functor induced by the homological shift functor [1], and distinguished triangles are equivalent to

$$(M, d_N) \xrightarrow{f} (N, d_N) \xrightarrow{i_N} \text{Cone}(f) \xrightarrow{\pi_{M[1]}} (M, d_N)[1],$$

for every maps of dg-modules $f: (M, d_M) \rightarrow (N, d_N)$.

B.1.1. (Co)fibrant replacements. A *cofibrant* dg-module (P, d_P) is a dg-module such that P is projective as graded A -module. Equivalently, it is a dg-module (P, d_P) such that for every surjective quasi-isomorphism $(L, d_L) \xrightarrow{\cong} (M, d_M)$, every morphism $(P, d_P) \rightarrow (M, d_M)$ factors through (L, d_L) . For any dg-module (N, d_N) , we have

$$\text{Hom}_{\mathcal{D}(A, d_A)}((P, d_P), (N, d_N)) \cong H_0^0(\text{HOM}_{(A, d_A)}((P, d_P), (N, d_N))).$$

Moreover, tensoring with a cofibrant dg-module preserves quasi-isomorphisms.

Given a left (resp. right) dg-module (M, d_M) , there exists a cofibrant replacement $(\mathbf{p}M, d_{\mathbf{p}M})$ (resp. $(M\mathbf{q}, d_{M\mathbf{q}})$) together with a surjective quasi-isomorphism

$$\pi_M: \mathbf{p}M \xrightarrow{\cong} M \quad (\text{resp. } \pi'_M: M\mathbf{q} \xrightarrow{\cong} M).$$

Moreover, the assignment $M \mapsto \mathbf{p}M$ (resp. $M \mapsto M\mathbf{q}$) is natural. Thus, we can compute $\text{Hom}_{\mathcal{D}(A, d_A)}((M, d_M), (N, d_N))$ by taking

$$H_0^0(\text{HOM}_{(A, d_A)}((\mathbf{p}M, d_{\mathbf{p}M}), (N, d_N))) \cong \text{Hom}_{\mathcal{D}(A, d_A)}((M, d_M), (N, d_N)).$$

A dg-module (I, d_I) is *fibrant* if for every injective quasi-isomorphism

$$(L, d_L) \xrightarrow{\cong} (M, d_M),$$

every morphism $(L, d_L) \rightarrow (M, d_M)$ extends to (M, d_M) . Then,

$$\text{Hom}_{\mathcal{D}(A, d_A)}((M, d_M), (I, d_I)) \cong H_0^0(\text{HOM}_{(A, d_A)}((M, d_M), (I, d_I))).$$

Again, for every dg-module (M, d_M) there exists a fibrant replacement $(\mathbf{i}M, d_{\mathbf{i}M})$ with an injective quasi-isomorphism $\iota_M: (M, d_M) \xrightarrow{\cong} (\mathbf{i}M, d_{\mathbf{i}M})$.

B.1.2. Strongly projective modules. Let R be a unital commutative ring. The following was introduced in [32], but we use the definition given in [5].

Definition B.1 ([5, Definition 8.17]). A dg-module (P, d_P) over a dg- R -algebra (A, d_A) is *strongly projective* if it is a direct summand of some dg-module $(A, d_A) \otimes_R (Q, d_Q)$ where (Q, d_Q) is a $(R, 0)$ -dg-module such that both $H(Q, d_Q)$ and $\text{im}(d_Q)$ are projective R -modules.

Proposition B.2 ([5, Lemma 8.23]). *Let (P, d_P) be a strongly projective left dg-module. For any right dg-module (M, d_M) , we have an isomorphism*

$$H((M, d_M) \otimes_{(A, d_A)} (P, d_P)) \cong H(M, d_M) \otimes_{H(A, d_A)} H(P, d_P).$$

B.1.3. A_∞ -action. Let (B, d_B) be a dg-bimodule over a pair of dg-algebras (S, d_S) - (R, d_R) . As explained in [29, §2.3], there is (in general) no right (R, d_R) -action on $\mathbf{p}B_i$ compatible with the left (S, d_S) -action. However, there is an induced A_∞ -action (defined uniquely up to homotopy), so that the quasi-isomorphism $\pi_B: \mathbf{p}B \xrightarrow{\cong} B$ can be upgraded to a map of A_∞ -bimodules.

Lemma B.3. *Let (A, d_A) be a dg-algebra, and let U and V be dg-(bi)modules over (A, d_A) , with a fixed cofibrant replacement $\pi_V: \mathbf{p}V \rightarrow V$. Suppose*

$$(1 \otimes p_V): U \otimes_{(A, d_A)} \mathbf{p}V \xrightarrow{\cong} U \otimes_{(A, d_A)} V$$

is a quasi-isomorphism. If $f: Z \rightarrow U \otimes_{(A, d_A)} \mathbf{p}V$ is a map of complexes of graded \mathbb{k} -spaces, and $f \circ (1 \otimes p_V)$ is a map of dg-(bi)modules, then there is an induced map $\bar{f}: Z \rightarrow U \otimes^L V$ of A_∞ -(bi)modules whose degree zero part is f .

Proof. We take $\bar{f} := (1 \otimes p_V)^{-1} \circ (f \circ (1 \otimes p_V))$, as a composition of maps of A_∞ -(bi)modules, since any map of (bi)module can be considered as a map of A_∞ -(bi)modules with no higher composition. □

Note that the equivalent statement also holds for a cofibrant replacement

$$U \mathbf{q} \longrightarrow U$$

such that

$$(\pi_U \otimes 1): U \mathbf{q} \otimes_{(A, d_A)} V \xrightarrow{\cong} U \otimes_{(A, d_A)} V$$

is a quasi-isomorphism.

B.2. Dg-derived categories. One of the issues with triangulated categories is that the category of functors between triangulated categories is in general not triangulated. To fix this, we work with a dg-enhancement of the derived category. In particular, this allows us to talk about distinguished triangles of dg-functors.

Recall that a dg-category is a category where the hom-spaces are dg-modules over $(\mathbb{k}, 0)$, and compositions are compatible with this structure (see [15, §1.2] for a precise definition). Given such a dg-category \mathcal{C} with hom-spaces $\text{Hom}_{\mathcal{C}}(X, Y) = (\bigoplus_{h \in \mathbb{Z}} \text{Hom}^h(X, Y), d_{X,Y})$, we can consider its *underlying category* $Z^0(\mathcal{C})$, which is given by the same objects as \mathcal{C} and hom-spaces

$$\text{Hom}_{Z^0(\mathcal{C})}(X, Y) := \ker(d_{X,Y}: \text{Hom}^0(X, Y) \longrightarrow \text{Hom}^{-1}(X, Y)).$$

Similarly, the *homotopy category* $H^0(\mathcal{C})$ is given by

$$\text{Hom}_{H^0(\mathcal{C})}(X, Y) := H^0(\text{Hom}_{\mathcal{C}}(X, Y)).$$

A *dg-enhancement* of a category \mathcal{C}_0 is a dg-category \mathcal{C} such that $H^0(\mathcal{C}) \cong \mathcal{C}_0$.

The *dg-derived category* $\mathcal{D}_{\text{dg}}(A, d_A)$ of a \mathbb{Z}^n -graded dg-algebra (A, d_A) is the \mathbb{Z}^n -graded dg-category with objects being cofibrant dg-modules over (A, d_A) , and hom-spaces being subspaces of the graded dg-spaces $\text{HOM}_{(A, d_A)}$ from (16), given by maps that preserve the \mathbb{Z}^n -grading:

$$\text{Hom}_{\mathcal{D}_{\text{dg}}(A, d_A)}(M, N) := \text{HOM}_{(A, d_A)}(M, N)_0,$$

for (M, d_M) and (N, d_N) cofibrant dg-modules. By construction,

$$H^0(\mathcal{D}_{\text{dg}}(A, d_A)) \cong \mathcal{D}(A, d_A).$$

Moreover, $\mathcal{D}_{\text{dg}}(A, d_A)$ is a dg-triangulated category, meaning its homotopy category is canonically triangulated (see [46] for a precise definition, or [34, Appendix A] for a summary oriented toward categorification), and this triangulated structure matches with the usual one on $\mathcal{D}(A, d_A)$.

B.2.1. Dg-functors. A *dg-functor* between dg-categories is a functor commuting with the differentials. Given a dg-functor $F: \mathcal{C} \rightarrow \mathcal{C}'$, it induces a functor on the homotopy categories $[F]: H^0(\mathcal{C}) \rightarrow H^0(\mathcal{C}')$. We say that a dg-functor is a *quasi-equivalence* if it gives quasi-isomorphisms on the hom-spaces, and induces an equivalence on the homotopy categories. We want to consider dg-category up to quasi-equivalence. Let Hqe be the homotopy category of dg-categories up to quasi-equivalence, and we write $\mathcal{R}\mathcal{H}om_{\text{Hqe}}$ for the dg-space of quasi-functors between dg-categories (see [46], [47], or [34, Appendix A]). These quasi-functors induce honest functors on the homotopy categories. Whenever \mathcal{C}' is dg-triangulated, then $\mathcal{R}\mathcal{H}om_{\text{Hqe}}(\mathcal{C}, \mathcal{C}')$ is dg-triangulated.

Remark B.4. The space of quasi-functors is equivalent to the space of strictly unital A_∞ -functors.

It is in general hard to understand the space of quasi-functors. However, by the results of Toen [46], if \mathbb{k} is a field and (A, d_A) and $(A', d_{A'})$ are dg-algebras, then it is possible to compute the space of ‘coproduct preserving’ quasi-functors $\mathcal{R}\mathcal{H}om_{\text{Hqe}}^{\text{cop}}(\mathcal{D}_{\text{dg}}(A, d_A), \mathcal{D}_{\text{dg}}(A', d_{A'}))$, in the same way as the category of coproduct preserving functors between categories of modules is equivalent to the category of bimodules. Indeed, we have a quasi-equivalence

$$\mathcal{R}\mathcal{H}om_{\text{Hqe}}^{\text{cop}}(\mathcal{D}_{\text{dg}}(A, d_A), \mathcal{D}_{\text{dg}}(A', d_{A'})) \cong \mathcal{D}_{\text{dg}}((A', d_{A'}), (A, d_A)), \tag{65}$$

where $\mathcal{D}_{\text{dg}}((A', d_{A'}), (A, d_A))$ is the dg-derived category of dg-bimodules. Composition of functors is equivalent to derived tensor product, and understanding the triangulated structure of $\mathcal{R}\mathcal{H}om_{\text{Hqe}}^{\text{cop}}(\mathcal{D}_{\text{dg}}(A, d_A), \mathcal{D}_{\text{dg}}(A', d_{A'}))$ becomes as easy as to understand $\mathcal{D}((A, d_A), (A', d_{A'}))$. In particular, a short exact sequence of dg-bimodules gives a distinguished triangle of dg-functors.

B.3. Derived hom and tensor dg-functors. Let (R, d_R) and (S, d_S) be dg-algebras. Let M and N be (R, d_R) -module and (S, d_S) -module respectively. Let B be a dg-bimodule over (S, d_S) - (R, d_R) . Then, the *derived tensor product* is

$$B \otimes_{(R, d_R)}^{\text{L}} M := B \otimes \mathbf{p}M,$$

and the *derived hom space* is

$$\text{RHOM}_{(S, d_S)}(B, N) := \text{HOM}_{(S, d_S)}(B, \mathbf{i}N).$$

Note that we have quasi-isomorphisms as dg-spaces

$$\begin{aligned} B \otimes_{(R, d_R)}^{\text{L}} M &\cong B\mathbf{q} \otimes_{(R, d_R)} \mathbf{p}M \cong B\mathbf{q} \otimes_{(R, d_R)} M, \\ \text{RHOM}_{(S, d_S)}(B, N) &\cong \text{HOM}_{(S, d_S)}(\mathbf{p}B, \mathbf{i}N) \cong \text{HOM}_{(S, d_S)}(\mathbf{p}B, N). \end{aligned}$$

This defines in turns triangulated dg-functors

$$B \otimes_{(R, d_R)}^{\text{L}} (-): \mathcal{D}_{\text{dg}}(R, d_R) \longrightarrow \mathcal{D}_{\text{dg}}(S, d_S),$$

and

$$\text{RHOM}_{(S, d_S)}(B, -): \mathcal{D}_{\text{dg}}(S, d_S) \longrightarrow \mathcal{D}_{\text{dg}}(R, d_R).$$

They induce a pair of adjoint functors $B \otimes_{(R, d_R)}^{\text{L}} (-) \dashv \text{RHOM}_{(S, d_S)}(B, -)$ between the derived categories $\mathcal{D}_{\text{dg}}(R, d_R)$ and $\mathcal{D}_{\text{dg}}(S, d_S)$.

B.3.1. Computing units and counits. The natural bijection

$$\bar{\Phi}_{M,N}^B: \text{Hom}_{\mathcal{D}(S,d_S)}(B \otimes_{(R,d_R)}^L M, N) \xrightarrow{\simeq} \text{Hom}_{\mathcal{D}(R,d_R)}(M, \text{RHOM}_{(S,d_S)}(B, N)),$$

is obtained by making the following diagram commutative:

$$\begin{array}{ccc} \text{Hom}_{\mathcal{D}(S,d_S)}(B \otimes_{(R,d_R)}^L M, N) & \xrightarrow{\bar{\Phi}_{M,N}^B} & \text{Hom}_{\mathcal{D}(R,d_R)}(M, \text{RHOM}_{(S,d_S)}(B, N)) \\ \downarrow \wr & & \uparrow \wr \\ \text{Hom}_{(S,d_S)}(B \otimes_{(R,d_R)} \mathbf{p}M, \mathbf{i}N) & \xrightarrow{\Phi_{\mathbf{p}M, \mathbf{i}N}^B} & \text{Hom}_{(R,d_R)}(\mathbf{p}M, \text{HOM}_{(S,d_S)}(B, \mathbf{i}N)) \end{array}$$

where Φ is defined in (17).

For the sake of keeping notations short, we will write HOM instead of $\text{HOM}_{(S,d_S)}$, and \otimes instead of $\otimes_{(R,d_R)}$, and similarly for the derived versions.

We are interested in computing the unit

$$\eta_M: M \longrightarrow \text{RHOM}(B, B \otimes^L M),$$

which is given by $\eta_M = \bar{\Phi}_{M, B \otimes^L M}^B(\text{Id}_{B \otimes^L M})$. Composing with the isomorphisms $\text{RHOM}(B, B \otimes^L M) \cong \text{HOM}(B, \mathbf{i}(B \otimes \mathbf{p}M))$ and $\mathbf{p}M \cong M$, we can compute η_M as

$$\eta'_M = \Phi_{\mathbf{p}M, \mathbf{i}(B \otimes^L M)}^B(\iota_{B \otimes^L M}): \mathbf{p}M \longrightarrow \text{HOM}(B, \mathbf{i}(B \otimes \mathbf{p}M)),$$

which gives

$$\eta'_M(m) = (b \mapsto \iota_{B \otimes \mathbf{p}M}(b \otimes m)).$$

Using the quasi-isomorphisms

$$\begin{array}{ccc} & \text{HOM}(\mathbf{p}B, \mathbf{i}(B \otimes^L M)) & \\ \iota_{B \otimes^L M} \circ - \nearrow & & \nwarrow - \circ \pi_B \\ \text{HOM}(\mathbf{p}B, B \otimes^L M) & \xrightarrow{\simeq} & \text{HOM}(B, \mathbf{i}(B \otimes^L M)) \end{array}$$

we can compute η'_M through

$$\eta''_M: \mathbf{p}M \longrightarrow \text{HOM}(\mathbf{p}B, B \otimes \mathbf{p}M), \quad \eta''_M(m) := (b \mapsto \pi_B(b) \otimes m).$$

This is particularly useful, since it means we do not have to compute any fibrant replacement to understand η_M .

Similarly, for the counit

$$\varepsilon_M: B \otimes^L \text{RHOM}(B, M) \longrightarrow M,$$

we have $\varepsilon_M = (\bar{\Phi}_{\text{RHOM}(B, M), M}^B)^{-1}(\text{Id}_{\text{RHOM}(B, M)})$. We rewrite it as

$$\varepsilon'_M = \Phi_{\mathbf{p}\text{HOM}(B, \mathbf{i}M), \mathbf{i}M}^{-1}(\pi_{\text{HOM}(B, \mathbf{i}M)}): B \otimes \mathbf{p}\text{HOM}(B, \mathbf{i}M) \longrightarrow \mathbf{i}M,$$

with $\varepsilon'_M(b \otimes f) = (\pi_{\text{HOM}(B, \mathbf{i}M)}(f))(b)$. We consider the quasi-isomorphisms

$$\begin{array}{ccc} & B\mathbf{q} \otimes \mathbf{p}\text{HOM}(B, \mathbf{i}M) & \\ \pi_B \otimes 1 \swarrow \simeq & & \searrow 1 \otimes \pi_{\text{HOM}(B, \mathbf{i}M)} \simeq \\ B \otimes \mathbf{p}\text{HOM}(B, \mathbf{i}M) & & B\mathbf{q} \otimes \text{HOM}(B, \mathbf{i}M) \end{array}$$

Therefore, we can compute ε_M as

$$\varepsilon''_M: B\mathbf{q} \otimes \text{HOM}(B, \mathbf{i}M) \longrightarrow \mathbf{i}M, \quad \varepsilon''_M(b \otimes f) := f(\pi'_B(b)),$$

where $\pi'_B: B\mathbf{q} \xrightarrow{\simeq} B$.

If in addition B is already cofibrant as left dg-module, then we can suppose $\mathbf{p}B = B$ and $\pi_B = \text{Id}_B$, and we obtain a commutative diagram

$$\begin{array}{ccc} B\mathbf{q} \otimes \text{HOM}(B, \mathbf{i}M) & \xrightarrow{\varepsilon''_M} & \mathbf{i}M \\ 1 \otimes (-\circ \pi_B) \downarrow \wr & & \parallel \\ B\mathbf{q} \otimes \text{HOM}(\mathbf{p}B, \mathbf{i}M) & \longrightarrow & \mathbf{i}M \\ 1 \otimes (\iota_M \circ -) \downarrow \wr & & \wr \uparrow \iota_M \\ B\mathbf{q} \otimes \text{HOM}(\mathbf{p}B, M) & \xrightarrow{\varepsilon'''_M} & M \end{array}$$

where

$$\varepsilon'''_M: B\mathbf{q} \otimes \text{HOM}(B, M) \longrightarrow M, \quad \varepsilon'''_M(b \otimes f) := f(\pi'(b)).$$

This is useful, since it means we can compute ε_M using ε'''_M , which does not require any fibrant replacement.

B.4. Asymptotic Grothendieck group. The usual definition of the Grothendieck group of a triangulated category does not take into consideration relations coming from infinite iterated extensions. When \mathcal{C} is a triangulated subcategory of a triangulated category \mathcal{T} admitting countable products and coproducts, and these preserves distinguished triangles, then there exists a notion of *asymptotic Grothendieck group* $K_0^\Delta(\mathcal{C})$ of \mathcal{C} , given by modding out relations obtained from Milnor (co)limits (see §B.4.3 below) in the usual Grothendieck group $K_0(\mathcal{C})$ (see [33, §8] for a precise definition).

B.4.1. Ring of Laurent series. We follow the construction of the ring of formal Laurent series given in [2] (see also [33, §5]). The *ring of formal Laurent series* $\mathbb{k}((x_1, \dots, x_n))$ is given by first choosing a total additive order \prec on \mathbb{Z}^n . One says that a cone $C := \{\alpha_1 v_1 + \dots + \alpha_n v_n : \alpha_i \in \mathbb{R}_{\geq 0}\} \subset \mathbb{R}^n$ is *compatible with* \prec whenever $0 \prec v_i$ for all $i \in \{1, \dots, n\}$. Then, we set

$$\mathbb{k}((x_1, \dots, x_n)) := \bigcup_{e \in \mathbb{Z}^n} x^e \mathbb{k}_{\prec}[[x_1, \dots, x_n]],$$

where $\mathbb{k}_{\prec}[[x_1, \dots, x_n]]$ consists of formal Laurent series in $\mathbb{k}[[x_1, \dots, x_n]]$ such that the terms are contained in a cone compatible with \prec . It forms a ring when we equip $\mathbb{k}((x_1, \dots, x_n))$ with the usual addition and multiplication of series.

B.4.2. C.b.l.f. structures. We fix an arbitrary additive total order \prec on \mathbb{Z}^n . We say that a \mathbb{Z}^n -graded \mathbb{k} -vector space $M = \bigoplus_{g \in \mathbb{Z}^n} M_g$ is *c.b.l.f. (cone bounded, locally finite) dimensional* if

- $\dim M_g < \infty$ for all $g \in \mathbb{Z}^n$;
- there exists a cone $C_M \subset \mathbb{R}^n$ compatible with \prec and $e \in \mathbb{Z}^n$ such that $M_g = 0$ whenever $g - e \notin C_M$.

Let (A, d_A) be a \mathbb{Z}^n -graded dg-algebra. Suppose that (A, d) is concentrated in non-negative homological degrees, that is $A_g^h = 0$ whenever $h < 0$. The *c.b.l.f. derived category* $\mathcal{D}^{\text{cblf}}(A, d_A)$ of (A, d_A) is the triangulated full subcategory of $\mathcal{D}(A, d_A)$ given by dg-modules having homology being c.b.l.f. dimensional for the \mathbb{Z}^n -grading. There exists also a dg-enhanced version $\mathcal{D}_{\text{dg}}^{\text{cblf}}(A, d_A)$. We write

$$\mathbf{K}_0^\Delta(A, d) := \mathbf{K}_0^\Delta(\mathcal{D}^{\text{cblf}}(A, d_A)).$$

Definition B.5. We say that (A, d) is a *positive c.b.l.f. dg-algebra* if

- (1) A is c.b.l.f. dimensional for the \mathbb{Z}^n -grading;
- (2) A is non-negative for the homological grading;
- (3) A_0^0 is semi-simple;
- (4) $A_0^h = 0$ for $h > 0$;
- (5) (A, d_A) decomposes a direct sum of shifted copies of modules $P_i := Ae_i$ for some idempotent $e_i \in A$, such that P_i is non-negative for the \mathbb{Z}^n -grading.

In a \mathbb{Z}^n -graded triangulated category \mathcal{C} , we define the notion of *c.b.l.f. direct sum* as follows:

- take a finite collection of objects $\{K_1, \dots, K_m\}$ in \mathcal{C} ;
- consider a direct sum of the form

$$\bigoplus_{\mathbf{g} \in \mathbb{Z}^n} x^{\mathbf{g}} (K_{1,\mathbf{g}} \oplus \dots \oplus K_{m,\mathbf{g}}), \quad \text{with } K_{i,\mathbf{g}} = \bigoplus_{j=1}^{k_{i,\mathbf{g}}} K_i[h_{i,j,\mathbf{g}}],$$

where $k_{i,\mathbf{g}} \in \mathbb{N}$ and $h_{i,j,\mathbf{g}} \in \mathbb{Z}$ such that

- there exists a cone C compatible with \prec , and $\mathbf{e} \in \mathbb{Z}^n$ such that for all j we have $k_{j,\mathbf{g}} = 0$ whenever $\mathbf{g} - \mathbf{e} \notin C$;
- there exists $h \in \mathbb{Z}$ such that $h_{i,j,\mathbf{g}} \geq h$ for all i, j, \mathbf{g} .

If \mathcal{C} admits arbitrary c.b.l.f. direct sums, then $\mathbf{K}_0^\Delta(\mathcal{C})$ has a natural structure of $\mathbb{Z}((x_1, \dots, x_n))$ -module with

$$\sum_{\mathbf{g} \in \mathcal{C}} a_{\mathbf{g}} x^{\mathbf{e} + \mathbf{g}} [X] := \left[\bigoplus_{\mathbf{g} \in \mathcal{C}} x^{\mathbf{g} + \mathbf{e}} X^{\oplus a_{\mathbf{g}}} \right],$$

where $X^{\oplus a_{\mathbf{g}}} = \bigoplus_{\ell=1}^{|a_{\mathbf{g}}|} X[\alpha_{\mathbf{g}}]$ and $\alpha_{\mathbf{g}} = 0$ if $a_{\mathbf{g}} \geq 0$ and $\alpha_{\mathbf{g}} = 1$ if $a_{\mathbf{g}} < 0$.

Theorem B.6 ([33, Theorem 9.15]). *Let (A, d) be a positive c.b.l.f. dg-algebra, and let $\{P_j\}_{j \in J}$ be a complete set of indecomposable cofibrant (A, d) -modules that are pairwise non-isomorphic (even up to degree shift). Let $\{S_j\}_{j \in J}$ be the set of corresponding simple modules. There is an isomorphism*

$$\mathbf{K}_0^\Delta(A, d) \cong \bigoplus_{j \in J} \mathbb{Z}((x_1, \dots, x_\ell))[P_j],$$

and $\mathbf{K}_0^\Delta(A, d)$ is also freely generated by the classes of $\{[S_j]\}_{j \in J}$.

Proposition B.7 ([33, Proposition 9.18]). *Let (A, d) and (A', d') be two c.b.l.f. positive dg-algebras. Let B be a c.b.l.f. dimensional (A', d') - (A, d) -bimodule. The derived tensor product functor*

$$F: \mathcal{D}^{\text{cblf}}(A, d) \longrightarrow \mathcal{D}^{\text{cblf}}(A', d'), \quad F(X) := B \otimes_{(A,d)}^L X,$$

induces a map

$$[F]: \mathbf{K}_0^\Delta(A, d) \longrightarrow \mathbf{K}_0^\Delta(A', d'),$$

sending $[X]$ to $[F(X)]$.

B.4.3. C.b.l.f. iterated extensions. Using the terminology of [17], recall that the *Milnor colimit* $\text{MColim}_{r \geq 0}(f_r)$ of a collection of arrows $\{X_r \xrightarrow{f_r} X_{r+1}\}_{r \in \mathbb{N}}$ in a triangulated category \mathcal{T} is the mapping cone fitting inside the following distinguished triangle

$$\coprod_{r \in \mathbb{N}} X_r \xrightarrow{1-f_\bullet} \coprod_{r \in \mathbb{N}} X_r \longrightarrow \text{MColim}_{r \geq 0}(f_r) \longrightarrow$$

where the left arrow is given by the infinite matrix

$$1 - f_\bullet := \begin{pmatrix} 1 & 0 & 0 & 0 & \cdots \\ -f_0 & 1 & 0 & 0 & \cdots \\ 0 & -f_1 & 1 & 0 & \cdots \\ \vdots & \ddots & \ddots & \ddots & \ddots \end{pmatrix}$$

Definition B.8. Let $\{K_1, \dots, K_m\}$ be a finite collection of objects in \mathcal{C} , and let $\{E_r\}_{r \in \mathbb{N}}$ be a family of direct sums of $\{K_1, \dots, K_m\}$ such that $\bigoplus_{r \in \mathbb{N}} E_r$ is a c.b.l.f. direct sum of $\{K_1, \dots, K_m\}$. Let $\{M_r\}_{r \in \mathbb{N}}$ be a collection of objects in \mathcal{C} with $M_0 = 0$, such that they fit in distinguished triangles

$$M_r \xrightarrow{f_r} M_{r+1} \longrightarrow E_r \longrightarrow$$

Then, we say that an object $M \in \mathcal{C}$ such that $M \cong_{\mathcal{T}} \text{MColim}_{r \geq 0}(f_r)$ in \mathcal{T} is a *c.b.l.f. iterated extension* of $\{K_1, \dots, K_m\}$.

Note that under the conditions above, we have

$$[M] = \sum_{r \geq 0} [E_r],$$

in the asymptotic Grothendieck group $\mathbf{K}_0(\mathcal{C})$.

Definition B.9. Let \mathcal{T} be a \mathbb{Z}^n -graded (dg-)triangulated (dg-)category, and let $\{X_j\}_{j \in J}$ be a collection of objects in \mathcal{T} . The subcategory of \mathcal{T} *c.b.l.f. generated* by $\{X_j\}_{j \in J}$ is the triangulated full subcategory $\mathcal{C} \subset \mathcal{T}$ given by all objects $Y \in \mathcal{T}$ such that there exists a finite subset $\{X_k\}_{k \in K}$ such that Y is isomorphic to a c.b.l.f. iterated extension of $\{X_k\}_{k \in K}$ in \mathcal{T} .

Thus, under the conditions above, $\mathbf{K}_0(\mathcal{C})$ is generated as a $\mathbb{Z}\langle(x_1, \dots, x_n)\rangle$ -module by the classes of $\{[X_j]\}_{j \in J}$.

B.4.4. Dg-functors. Let (R, d_R) and (S, d_S) be $(\mathbb{Z}^n$ -graded) dg-algebras. The situation of (65) in §B.2.1 restricts to the c.b.l.f. version $\mathcal{D}_{\text{dg}}^{\text{cblf}}$ of §B.4.2, so that

$$\mathcal{R}\mathcal{H}om_{\text{Hqe}}^{\text{cop}}(\mathcal{D}_{\text{dg}}^{\text{cblf}}(R, d_R), \mathcal{D}_{\text{dg}}^{\text{cblf}}(S, d_S)) \cong \mathcal{D}_{\text{dg}}^{\text{cblf}}((S, d_S), (R, d_R)).$$

Then, we obtain an induced map

$$\begin{aligned} \mathbf{K}_0^\Delta(\mathcal{R}\mathcal{H}om_{\text{Hqe}}^{\text{cop}}(\mathcal{D}_{\text{dg}}^{\text{cblf}}(R, d_R), \mathcal{D}_{\text{dg}}^{\text{cblf}}(S, d_S)))r \\ \longrightarrow \text{Hom}_{\mathbb{Z}\langle(x_1, \dots, x_n)\rangle}(\mathbf{K}_0^\Delta(R, d_R), \mathbf{K}_0^\Delta(S, d_S)), \end{aligned} \quad (66)$$

by using Proposition B.7.

References

- [1] R. Anno and V. Nandakumar, Exotic t-structures for two-block Springer fibers. Preprint, 2016. [arXiv:1602.00768](https://arxiv.org/abs/1602.00768)
- [2] A. Aparicio-Monforte and M. Kauers, Formal Laurent series in several variables. *Expo. Math.* **31** (2013), no. 4, 350–367. [MR 3133710](https://doi.org/10.1007/s00036-013-0101-1) [Zbl 1283.13018](https://doi.org/10.1007/s00036-013-0101-1)
- [3] M. M. Asaeda, J. H. Przytycki, and A. S. Sikora, Categorification of the Kauffman bracket skein module of I -bundles over surfaces. *Algebr. Geom. Topol.* **4** (2004), 1177–1210. [MR 2113902](https://doi.org/10.1016/S1472-7480(04)00011-1) [Zbl 1070.57008](https://doi.org/10.1016/S1472-7480(04)00011-1)
- [4] D. Auroux, J. E. Grigsby, and S. M. Wehrli, Sutured Khovanov homology, Hochschild homology, and the Ozsváth–Szabó spectral sequence. *Trans. Amer. Math. Soc.* **367** (2015), no. 10, 7103–7131. [MR 3378825](https://doi.org/10.1090/S0002-9947-2015-06011-1) [Zbl 1365.57011](https://doi.org/10.1090/S0002-9947-2015-06011-1)
- [5] T. Barthel, J. May, and E. Riehl, Six model structures for DG-modules over DGAs: model category theory in homological action. *New York J. Math.* **20** (2014), 1077–1159. [MR 3291613](https://doi.org/10.1080/1079072X.2014.931111) [Zbl 1342.16006](https://doi.org/10.1080/1079072X.2014.931111)
- [6] J. Chuang and R. Rouquier, Derived equivalences for symmetric groups and \mathfrak{sl}_2 -categorification. *Ann. of Math. (2)* **167** (2008), no. 1, 245–298. [MR 2373155](https://doi.org/10.2307/2373155) [Zbl 1144.20001](https://doi.org/10.2307/2373155)
- [7] R. Dipper, D. James, and A. Mathas, Cyclotomic q -Schur algebras. *Math. Z.* **229** (1998), no. 3, 385–416. [MR 1658581](https://doi.org/10.1007/PL00004911) [Zbl 0934.20014](https://doi.org/10.1007/PL00004911)
- [8] M. Ehrig and D. Tubbenhauer, Relative cellular algebras. *Transform. Groups* **26** (2021), no. 1, 229–277. [MR 4229665](https://doi.org/10.1007/s00036-020-01500-1) [Zbl 07371500](https://doi.org/10.1007/s00036-020-01500-1)
- [9] G. Faonte, A_∞ -functors and homotopy theory of dg-categories. *J. Noncommut. Geom.* **11** (2017), no. 3, 957–1000. [MR 3713010](https://doi.org/10.1080/14747480.2017.1390180) [Zbl 1390.18034](https://doi.org/10.1080/14747480.2017.1390180)
- [10] J. Graham, *Modular representations of Hecke algebras and related algebras*. Ph.D. thesis. University of Sydney, Sydney, 1985.
- [11] R. M. Green, Generalized Temperley–Lieb algebras and decorated tangles. *J. Knot Theory Ramifications* **7** (1998), no. 2, 155–171. [MR 1618912](https://doi.org/10.1080/10689879808839205) [Zbl 0926.20005](https://doi.org/10.1080/10689879808839205)

- [12] J. E. Grigsby, A. M. Licata, and S. M. Wehrli, Annular Khovanov homology and knotted Schur–Weyl representations. *Compos. Math.* **154** (2018), no. 3, 459–502. [MR 3731256](#) [Zbl 1422.57036](#)
- [13] J. Hu and A. Mathas, Quiver Schur algebras for linear quivers. *Proc. Lond. Math. Soc.* (3) **110** (2015), no. 6, 1315–1386. [MR 3356809](#) [Zbl 1364.20038](#)
- [14] K. Iohara, G. Lehrer, and R. Zhang, Schur–Weyl duality for certain infinite dimensional $U_q(\mathfrak{sl}_2)$ -modules. Preprint, 2019. [arXiv:1811.01325v2](#)
- [15] B. Keller, Deriving DG categories. *Ann. Sci. École Norm. Sup.* (4) **27** (1994), no. 1, 63–102. [MR 12584060799.18007](#) [Zbl](#)
- [16] B. Keller, On differential graded categories. In M. Sanz-Solé, J. Soria, J. L. Varona, and J. Verdera (eds.), *International Congress of Mathematicians*. Vol. II. Invited lectures. Proceedings of the congress held in Madrid, August 22–30, 2006. European Mathematical Society (EMS), Zürich, 2006, 151–190. [MR 2275593](#) [Zbl 1140.18008](#)
- [17] B. Keller and P. Nicolàs, Weight structures and simple dg modules for positive dg algebras. *Int. Math. Res. Not. IMRN* **2013**, no. 5, 1028–1078. [MR 3031826](#) [Zbl 1312.18007](#)
- [18] M. Khovanov, A categorification of the Jones polynomial. *Duke Math. J.* **101** (2000), no. 3, 359–426. [MR 1740682](#) [Zbl 0960.57005](#)
- [19] M. Khovanov, Triply-graded link homology and Hochschild homology of Soergel bimodules. *Internat. J. Math.* **18** (2007), no. 8, 869–885. [MR 2339573](#) [Zbl 1124.57003](#)
- [20] M. Khovanov, A. Lauda, J. Sussan, and Y. Yonezawa, Braid group actions from categorical symmetric Howe duality on deformed Webster algebras. Preprint, 2020. [arXiv:1802.05358v2](#)
- [21] M. Khovanov and A. D. Lauda, A diagrammatic approach to categorification of quantum groups. I. *Represent. Theory* **13** (2009), 309–347. [MR 2525917](#) [Zbl 1188.81117](#)
- [22] M. Khovanov and A. D. Lauda, A diagrammatic approach to categorification of quantum groups. II. *Trans. Amer. Math. Soc.* **363** (2011), no. 5, 2685–2700. [MR 2763732](#) [Zbl 1214.81113](#)
- [23] M. Khovanov, Y. Qi, and J. Sussan, p -DG cyclotomic nilHecke algebras. Preprint, 2017. [arXiv:1711.07159v1](#)
- [24] M. Khovanov and P. Seidel, Quivers, Floer cohomology, and braid group actions. *J. Amer. Math. Soc.* **15** (2002), no. 1, 203–271. [MR 1862802](#) [Zbl 1035.53122](#)
- [25] M. Khovanov and J. Sussan, The Soergel category and the redotted Webster algebra. *J. Pure Appl. Algebra* **222** (2018), no. 8, 1957–2000. [MR 3771843](#) [Zbl 1418.16026](#)
- [26] A. Lacabanne and P. Vaz, Schur–Weyl duality, Verma modules, and row quotients of Ariki–Koike algebras. *Pacific J. Math.* **311** (2021), no. 1, 113–133. [MR 4241799](#)
- [27] A. Lauda, A categorification of quantum $\mathfrak{sl}(2)$. *Adv. Math.* **225** (2010), no. 6, 3327–3424. [MR 2729010](#) [Zbl 1219.17012](#)

- [28] J. Lurie, *Higher algebra*. Preprint, 2017.
<https://www.math.harvard.edu/~lurie/papers/HA.pdf>
- [29] M. Mackaay and B. Webster, Categorified skew howe duality and comparison of knot homologies. *Adv. Math.* **330** (2018), 876–945. [MR 3787560](#) [Zbl 1441.57014](#)
- [30] P. Martin and H. Saleur, The blob algebra and the periodic Temperley–Lieb algebra. *Lett. Math. Phys.* **30** (1994), no. 3, 189–206. [MR 1267001](#) [Zbl 0799.16005](#)
- [31] P. Martin and D. Woodcock, Generalized blob algebras and alcove geometry. *LMS J. Comput. Math.* **6** (2003), 249–296. [MR 2051586](#) [Zbl 1080.20004](#)
- [32] J. C. Moore, Algèbre homologique et homologie des espaces classifiants. In *Séminaire Henri Cartan, 12ième année: 1959/60. Périodicité des groupes d’homotopie stables des groupes classiques, d’après Bott*. Deuxième édition, corrigée. École Normale Supérieure. Secrétariat mathématique, Paris, 1961, 1–37. [Zbl 0115.17205](#)
- [33] G. Naisse, Asymptotic Grothendieck groups and cone bounded locally finite dg-algebras. Preprint, 2019. [arXiv:1906.07215v1](#)
- [34] G. Naisse and P. Vaz, 2-Verma modules. Preprint, 2019. [arXiv:1710.06293v2](#)
- [35] G. Naisse and P. Vaz, 2-Verma modules and the Khovanov–Rozansky link homologies. Preprint, 2020. [arXiv:1704.08485v3](#)
- [36] G. Naisse and P. Vaz, An approach to categorification of Verma modules. *Proc. Lond. Math. Soc.* (3) **117** (2018), no. 6, 1181–1241. [MR 3893177](#) [Zbl 1454.81114](#)
- [37] G. Naisse and P. Vaz, On 2-Verma modules for quantum \mathfrak{sl}_2 . *Selecta Math. (N.S.)* **24** (2018), no. 4, 3763–3821. [MR 3848033](#) [Zbl 1452.17020](#)
- [38] H. Queffelec and D. E. V. Rose, Sutured annular Khovanov–Rozansky homology. *Trans. Amer. Math. Soc.* **370** (2018), no. 2, 1285–1319. [MR 3729501](#) [Zbl 1435.57010](#)
- [39] D. Rose and D. Tubbenhauer, HOMFLYPT homology for links in handlebodies via type A Soergel bimodules. *Quantum Topol.* **12** (2021), no. 2, 373–410. [MR 4261661](#) [Zbl 07377320](#)
- [40] R. Rouquier, 2-Kac–Moody algebras. Preprint, 2008. [arXiv:0812.5023v1](#)
- [41] C. Stroppel, Categorification of the Temperley–Lieb category, tangles, and cobordisms via projective functors. *Duke Math. J.* **126** (2005), no. 3, 547–596. [MR 2120117](#) [Zbl 1112.17010](#)
- [42] C. Stroppel, Parabolic category \mathcal{O} , perverse sheaves on Grassmannians, Springer fibres and Khovanov homology. *Compos. Math.* **145** (2009), no. 4, 954–992. [MR 2521250](#) [Zbl 1187.17004](#)
- [43] C. Stroppel, Schur–Weyl dualities and link homologies. In R. Bhatia, A. Pal, G. Rangarajan, V. Srinivas, and M. Vanninathan (eds.), *Proceedings of the International Congress of Mathematicians*. Volume III. Invited lectures. Held in Hyderabad, August 19–27, 2010. Hindustan Book Agency, New Delhi, 2010, 1344–1365. [MR 2827844](#) [Zbl 1244.17006](#)

- [44] C. Stroppel and B. Webster, Quiver Schur algebras and Fock space. Preprint, 2014. [arXiv:1110.1115v2](#)
- [45] J. Sussan and Y. Qi, A categorification of the Burau representation at prime roots of unity. *Selecta Math. (N.S.)* **22** (2016), no. 3, 1157–1193. [MR 3518548](#)
[Zbl 1345.81061](#)
- [46] B. Toën, The homotopy theory of dg-categories and derived Morita theory. *Invent. Math.* **167** (2007), no. 3, 615–667. [MR 2276263](#) [Zbl 1118.18010](#)
- [47] B. Toën, Lectures on dg-categories. In G. Cortiñas (ed.), *Topics in algebraic and topological K-theory*. Lecture Notes in Mathematics, 2008. Springer-Verlag, Berlin, 2011, 243–302. [MR 2762557](#) [Zbl 1216.18013](#)
- [48] B. Webster, Tensor product algebras, grassmannians and khovanov homology. In S. Gukov, M. Khovanov, and J. Walcher (eds.), *Physics and mathematics of link homology*. Papers from the summer school held as part of the Séminaire de Mathématiques Supérieures at the Centre de Recherches Mathématiques, Université de Montréal, Montreal, QC, June 24–July 5, 2013. Contemporary Mathematics, 680. Centre de Recherches Mathématiques Proceedings. American Mathematical Society, Providence, R.I., 2016, 23–58. [MR 3591642](#) [Zbl 1408.57017](#)
- [49] B. Webster, Knot invariants and higher representation theory. *Mem. Amer. Math. Soc.* **250** (2017), no. 1191, v+141 pp. [MR 3709726](#) [Zbl 1446.57001](#)

Received June 9, 2020

Abel Lacabanne, Université Clermont Auvergne, CNRS, LMBP,
63000 Clermont-Ferrand, France
e-mail: abel.lacabanne@uca.fr

Grégoire Naisse, Max-Planck Institute for Mathematics, Vivatsgasse 7, 53111 Bonn,
Germany
e-mail: gregoire.naisse@gmail.com

Pedro Vaz, Institut de Recherche en Mathématique et Physique,
Université Catholique de Louvain, Chemin du Cyclotron 2, 1348 Louvain-la-Neuve,
Belgium
e-mail: pedro.vaz@uclouvain.be