

January 2014

LOSS ALLOCATION OF TRANSMISSION LINE AND MINIMIZATION OF LOSS FOR 5 BUS,14 BUS &30 BUS SYSTEMS

SUNIL KUMAR A.V.

Electrical & Electronics dept., ACIT, Bangalore, Karnataka, avsgowda@gmail.com

KUMUDEESH K.C

Electrical & Electronics dept., ACIT, Bangalore, Karnataka, kumudeesh@acharya.ac.in

REKHA C.M

Electrical & Electronics dept., IMPACT, Bangalore, Karnataka, cmrekhaiyer@gmail.com

DR.SHIVASHARANAPPAG .C

Electrical & Electronics dept., DBIT, Bangalore, Karnataka, shivsharanapa@gmail.com

Follow this and additional works at: <https://www.interscience.in/ijeee>



Part of the [Power and Energy Commons](#)

Recommended Citation

A.V., SUNIL KUMAR; K.C, KUMUDEESH; C.M, REKHA; and .C, DR.SHIVASHARANAPPAG (2014) "LOSS ALLOCATION OF TRANSMISSION LINE AND MINIMIZATION OF LOSS FOR 5 BUS,14 BUS &30 BUS SYSTEMS," *International Journal of Electronics and Electrical Engineering*: Vol. 2 : Iss. 3 , Article 1.

DOI: 10.47893/IJEEE.2014.1087

Available at: <https://www.interscience.in/ijeee/vol2/iss3/1>

This Article is brought to you for free and open access by the Interscience Journals at Interscience Research Network. It has been accepted for inclusion in International Journal of Electronics and Electrical Engineering by an authorized editor of Interscience Research Network. For more information, please contact sritampatnaik@gmail.com.

LOSS ALLOCATION OF TRANSMISSION LINE AND MINIMIZATION OF LOSS FOR 5 BUS,14 BUS &30 BUS SYSTEMS

¹SUNIL KUMAR A.V., ²KUMUDEESH K.C, ³REKHA C.M, ⁴DR.SHIVASHARANAPPAG.C

^{1&2}Electrical & Electronics dept., ACIT, Bangalore, Karnataka

³Electrical & Electronics dept., IMPACT, Bangalore, Karnataka

Electrical & Electronics dept., DBIT, Bangalore, Karnataka

E-Mail : ¹avsgowda@gmail.com, ²kumudeesh@acharya.ac.in

³cmrekhaiyer@gmail.com, ⁴shivsharanapa@gmail.com

Abstract- The paper focuses on the issue of transmission loss allocation and transmission loss minimization by incorporating UPFC injection model using load flow analysis. To investigate the effect of the UPFC on the steady state condition of the system and load flow, different models can be used. These models are usually based on modification of traditional load flow methods. In this project, a mathematical model for UPFC referred as UPFC injection model is used. Since accurate power tracing is very difficult, allocation of losses for a particular transaction (in power business it is buying and selling system) may not be effectively realized. However loss allocation is an important aspect in determining the cost of transmission. Thus a methodology to find the losses accurately is vital. It is imperative to make sure that all users of the transmission network are charged proportionate to their usage and this aspect is all the more important because of the common infrastructure they use. The Z-bus loss allocation method is used to achieve the required objective. This method will promote more efficient network operations when implemented in deregulated electric industries. The Unified Power Flow Controller (UPFC) injection model is incorporated in Load Flow Model by the method of Newton Raphson Algorithm to study its effects for power flow control and losses minimization in the power system. In this project optimal placement of UPFC is conducted based on active power loss Sensitivity factors. Based on these sensitivity factors the UPFC is optimally placed in the required transmission line to investigate the impact of UPFC in the system. The changes in the system are studied to see the impact of the UPFC. The impact of UPFC are analyzed by using 5-Bus, IEEE 14-bus, and IEEE 30-bus Test systems. The analysis is achieved through developing of software program using MATLAB.

I. INTRODUCTION

1. UNIFIED POWER FLOW CONTROLLER (UPFC)

Fast progress of power electronics has made Flexible AC Transmission Systems (FACTS) as a promising concept. Researches on FACTS technologies are being performed very actively. Along with advanced control techniques on FACTS devices, power flow among transmission networks is more and more controllable. Among a variety of FACTS controllers, the Unified Power Controller(UPFC) is a new device in FACTS family, which has been introduced by Gyugiy(1991)[13]. It can be used in power systems for several purposes, such as shunt compensation, series compensation, phase shifting, power flow control and voltage control. With the adoption of UPFCs in power systems, the traditional power flow analysis will face new challenges in modeling and solution techniques.

The UPFC consists of two voltage source converters, which are connected back to back through a DC link. The series voltage converter is connected to the transmission line by means of a series transformer and the shunt voltage converter by means of shunt transformer. The series voltage converter injects an AC voltage into the transmission line with controllable magnitude and phase angle. The shunt converter can exchange active and reactive powers with the system, which enables the system to do shunt compensation independently. To investigate the effect of the UPFC on the steady state condition of the

system and load flow, different models have been introduced. These models are usually based on modification of traditional load flow methods. The UPFC injection model is easily incorporated in Newton Raphson power flow model to study its effect for power flow control and losses minimization in the power system. The program is written using MATLAB software.

1.1 Basic circuit arrangement of UPFC:

Basically, the unified power flow controller (UPFC) consists of two switching converters. These converters are operated from a common DC link provided by a DC storage capacitor as shown in the Figure 2.

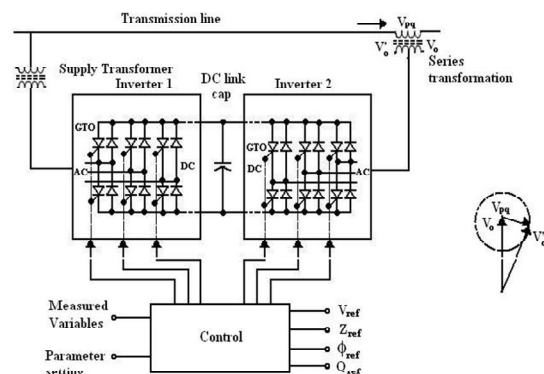

Fig.2. Basic circuit arrangement of UPFC

Converter 2 provides the main function of the UPFC by injecting an AC voltage with controllable

magnitude and phase angle in series with the transmission line via a series transformer. The basic function of converter 1 is to supply or absorb the real power demand by converter 2 at the common DC link. It can also generate or absorb controllable reactive power and provide independent shunt reactive compensation for the line. Converter 2 supplies or absorbs locally the required reactive power and exchanges the active power as a result of the series injection voltage.

1.2 UPFC MODEL:

The schematic representation of the UPFC is shown in Fig.3. It consists of two voltage source converters and a dc circuit represented by the capacitor. Converter 1 is primarily used to provide the real power demand of converter 2 at the common dc link terminal from the ac power system. Converter 1 can also generate or absorb reactive power at its ac terminal, which is independent of the active power transfer to (or from) the dc terminal. Therefore, with proper control, it can also fulfil the function of an independent advanced static VAR compensator providing reactive power compensation for the transmission line and thus executing indirect voltage regulation at the input terminal of the Converter 2 is used to generate a voltage source at the fundamental frequency with variable amplitude ($0 \leq V_T \leq V_{TMAX}$) and phase angle ($0 \leq \phi_T \leq 2\pi$), which is added to the ac transmission line by the series-connected boosting transformer.

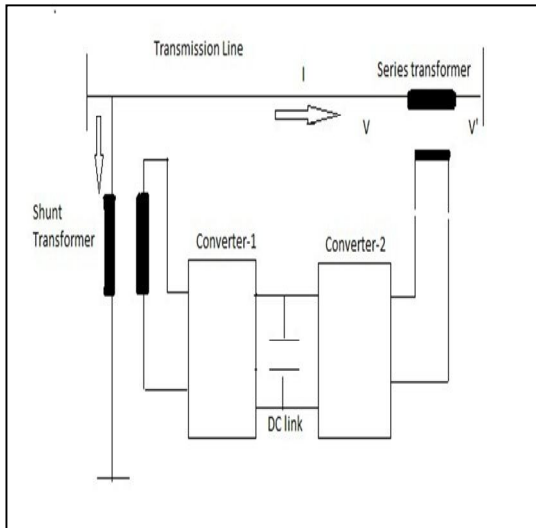

Fig.3. Schematic diagram of UPFC.

The inverter output voltage injected in series with line can be used for direct voltage control, series compensation, phase shifter, and their combinations. This voltage source can internally generate or absorb all the reactive power required by the different type of controls applied and transfers active power at its dc terminal.

1.3 UPFC injection model for power flow studies.

In this study, a model for UPFC, which will be referred as UPFC injection model [1] is derived. This model is helpful in understanding the impact of the UPFC on the power system in the steady state. Furthermore, the UPFC injection model can easily be incorporated in the steady state power flow model. Since the series voltage source converter does the main function of the UPFC, first derive the modelling of a series voltage source converter.

Series connected voltage source converter model:

Suppose a series connected voltage source is located between nodes i and j in a power system. The series voltage source converter can be modeled with an ideal series voltage V_s in series with a reactance X_s as shown in fig below,

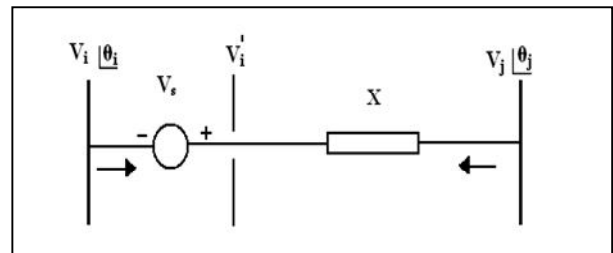

Fig.4. Representation of a series connected VSC

$$V_i^1 = V_s + V_i \quad (1)$$

where V_i^1 = fictitious voltage behind the series reactance.

V_s = series source voltage.

V_i = voltage at i'th node.

The series voltage source V_s is controllable in magnitude and phase, i.e,

$$V_s = rV_i e^{i\gamma} \quad (2)$$

where r = series voltage source coefficient. ($0 < r < r_{max}$)

γ = series voltage source angle. ($0 < \gamma < 2\pi$)

The injection model is obtained by replacing the equivalent circuit of series connected voltage source as Norton's equivalent circuit as shown in fig.5 .The current source,

$$I_s = -jb_s V_s \quad (3)$$

where $b_s = 1/X_s$

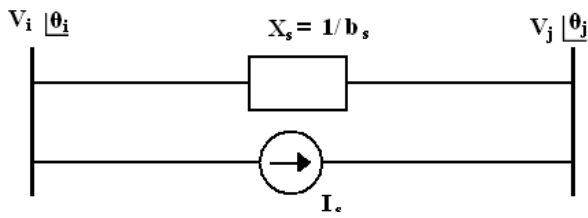

Fig.5. Equivalent Norton's circuit of a series connected VSC.

The power injected into the i^{th} bus

$$\begin{aligned} \overline{S_{is}} &= \overline{V_i}(-\overline{I_s})^* \\ S_{is} &= V_i [j b_s r \overline{V_i} e^{j\gamma}]^* \\ S_{is} &= -b_s r V_i^2 \sin(\gamma) - j b_s r V_i^2 \cos(\gamma) \end{aligned} \quad (4)$$

The power injected into the j^{th} bus

$$\begin{aligned} \overline{S_{js}} &= \overline{V_j}(-\overline{I_s})^* \\ S_{js} &= V_j [-j b_s r \overline{V_i} e^{j\gamma}]^* \\ S_{js} &= b_s r V_i V_j \sin(\theta_{ij} + \gamma) + j b_s r V_i V_j \cos(\theta_{ij} + \gamma) \end{aligned} \quad (5)$$

Where $\theta_{ij} = \theta_i - \theta_j$

From above equations, the injection model of series connected voltage source can be sent as two dependent loads as shown in fig.6.

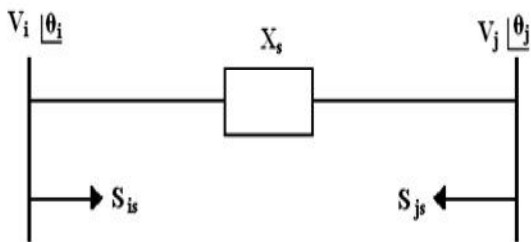

Fig.6. Injection model for a series connected VSC.
Shunt connected voltage source converter model:

In UPFC, the shunt connected voltage source (converter1) is used mainly to provide the active power, which is injected to the network via the series connected voltage source. When the losses are neglected

$$P_{conv1} = P_{conv2}$$

The apparent power supplied by the series voltage source converter is

$$S_{conv2} = \overline{V_s} I_{ij}^* = r e^{j\gamma} \overline{V_i} \left[\frac{\overline{V_i} - \overline{V_j}}{iX_s} \right]^* \quad (6)$$

After simplification, the active and reactive power supplied by converter 2 is

$$P_{conv2} = r b_s V_i V_j \sin(\theta_i - \theta_j + \gamma) - r b_s V_i^2 \sin(\gamma)$$

$$Q_{conv2} = -r b_s V_i V_j \cos(\theta_i - \theta_j + \gamma) + r b_s V_i^2 \cos(\gamma) + r^2 b_s V_i^2 \quad (7)$$

The reactive power delivered or absorbed by converter 1 is independently controllable by UPFC and can be modelled as a separate controllable shunt reactive source. In view of above, it is assumed that $Q_{conv1} = 0$. The UPFC injection model is constructed from the series connected voltage source model with the addition of a power equivalent to $P_{conv1} + j0$ to node i.

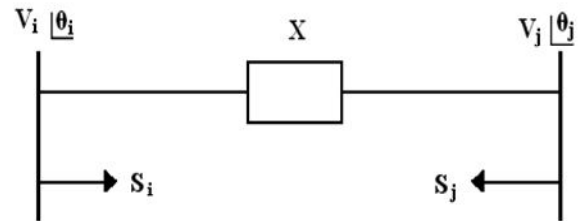

Fig.7. Complete UPFC model.

Thus, the complete UPFC injection model is shown in fig.7.

$$Q_{si} = r b_s V_i^2 \cos(\gamma) + Q_{shunt}$$

$$Q_{sj} = -r b_s V_i V_j \cos(\theta_{ij} + \gamma)$$

$$P_{si} = r b_s V_i V_j \sin(\theta_{ij} + \gamma)$$

$$P_{sj} = -r b_s V_i V_j \sin(\theta_{ij} + \gamma) \quad (8)$$

1.4 Modification of Jacobian matrix:

The UPFC injection model can easily be incorporated in a load flow program. If a UPFC is located between node i and node j in a power system, the Jacobian matrix is modified by addition of appropriate injection powers. The linearized load flow model is

$$\begin{bmatrix} \Delta P \\ \Delta Q \end{bmatrix} = \begin{bmatrix} H \dots\dots N \\ J \dots\dots L \end{bmatrix} \begin{bmatrix} \Delta \theta \\ \Delta V/V \end{bmatrix} \quad (9)$$

The Jacobian matrix which is modified is given below, the superscript '0' denotes the Jacobian elements without UPFC.

2. METHODOLOGY

The main objective of the project is to study the effects of Unified Power Flow Controller on loss minimization and loss allocations. To achieve the main objective of the project the UPFC injection model is incorporated in the Newton Raphson algorithm. Thus, in this chapter a detail explanation about UPFC incorporation in load flow is shown. Optimal placement of the UPFC is achieved from active power loss sensitivity factors with respect to the UPFC control parameters. A brief explanation is also given about sensitivity analysis. From the solved load flow model, losses are obtained and these losses are allocated at each bus by the Z-Bus loss allocation method, which is also explained in detail further.

2.1 Incorporation of UPFC in Newton Raphson Power Flow Algorithm:

2.1.1 Newton Raphson Power Flow Algorithm:

From the mathematical modelling point of view, the set of nonlinear, algebraic equations that describe the electrical power network under the steady state conditions are solved for the power flow solutions. Over the years, several approaches have been put forward to solve for the power flow equations. Early approaches were based on the loop equations and methods using Gauss-type solutions. This method was laborious because the network loops has to be specified by hand by the systems engineer. The drawback of these algorithms is that they exhibit poor convergence characteristics when applied to the solution of the networks. To overcome such limitations, the Newton-Raphson method and derived formulations were developed in the early 1970s and since then it became firmly established throughout the power system industry. In the project a Newton Raphson power flow algorithm [2] is used to solve for the power flow problem in a transmission line with UPFC [1]

- **Steps to Incorporate UPFC in Newton-Raphson Algorithm:**

- Step 1: Read the system input data; line data, bus data, generator and load data.
- Step 2: Formation of admittance matrix 'Y' bus of the transmission line between the bus i and j.

Step 3: Combining the UPFC power equations with network equation, the conventional power flow equation is given as:

$$P_i + jQ_i = \sum_{j=1}^n V_i V_j Y_{ij} \angle(\theta_{ij} - \delta_i + \delta_j) + P_i^1 + jQ_i^1$$

- Step 4: The conventional jacobian matrix are formed due to the inclusion of UPFC. The inclusion of these variables increases the dimensions of the jacobian matrix.
- Step 5: In this step, the jacobian matrix is modified and power equations are mismatched.
- Step 6: The Bus bar voltages are updated at each iteration and convergence is checked. If convergence is not achieved in the next step the algorithm goes back to the step 5 and the jacobian matrix is modified and the power equations are mismatched until convergence is attained.
- Step 7: If the convergence achieved in Step 6, the output load flow is calculated for PQ bus that includes the Bus bar voltages, generation, transmission line flow and losses.

Sensitivity analysis of total active power loss

- A method based on the sensitivity of the total system active power loss with respect to the control variables of the FACTS device i.e, UPFC is considered.
- For UPFC placed between buses i and bus j, the considered control parameter is the injected series voltage, of controllable magnitude and its phase angle. The active power loss sensitivity factor with respect to these control variables may be given as, loss sensitivity with respect to control parameter of UPFC placed between

$$a_{ij} = \frac{\partial P_L}{\partial V_{ij}}$$

buses i and bus j.

- And this can be deduced from the above equation as,

$$\frac{\partial P_L}{\partial V_{ij}} = 2V_i V_j \cos(\delta_i - \delta_j) + 2V_i V_j \sin(\delta_i - \delta_j)$$

- Thus from the above equation the sensitivity factors with respect to active power loss are obtained.

Z-Bus loss allocation method:

- The goal of the Z-bus loss allocation method, is to take a solved power flow and systematically distribute the system transmission losses, among

the network buses according to, **14 BUS SYSTEM**

$$P_{loss} = \sum_{k=1}^n L_k$$

- The loss component, L_k is the fraction of the system losses allocated to the net real power injection at bus K.
- This is assigned to each individual bus- K, the responsibility of paying for L_k at the market marginal price, λ the extra cost due to loss allocation must then be subtracted from the revenue of the generators and added to the load payments so that the pool remains revenue-neutral.

Z-BUS LOSS ALLOCATION ALGORITHM:

Step 1: Solve load flow; get bus voltage vector V and total power loss.

Step 2: Obtain bus current vector I from V and complex power injection.

$$S = (P_i + jQ_i)$$

Step 3: Obtain the vector RI.

$$RI = \text{Re} \{Z\} I.$$

$$RI = \text{Re} \{Z [\text{Re} (I)]\} + \text{Re} \{Z [\text{Im} (I)]\}.$$

Step 4: Calculate the component of total loss due to current injection I_k at the j^{th} bus.

$$L_k = \Re \left[I_k^* \left(\sum_{j=1}^{nb} R_{kj} I_j \right) \right]$$

Step 5: Compute L_k for all buses. L_k is the loss allocated to bus K calculated using the Z-Bus loss allocation method.

Simulation results: [5-Bus system]:The simulation study is done initially for without UPFC device in the 5-Bus test system.

Voltage profile without UPFC.

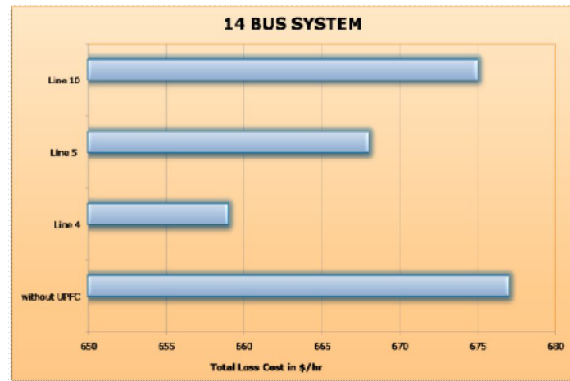
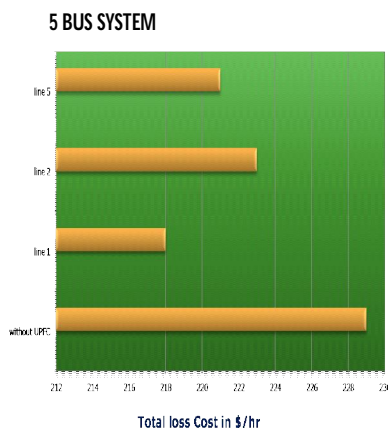

30 BUS SYSTEM

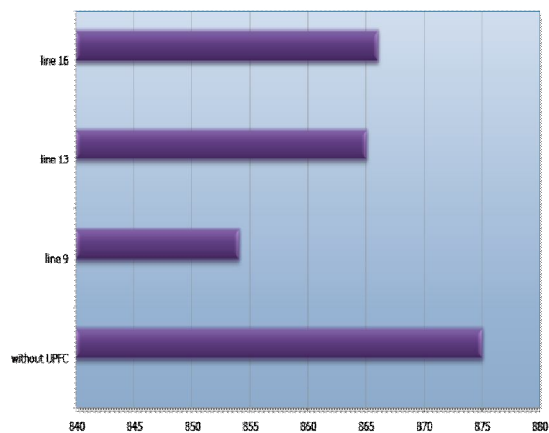

CONCLUSION:

FACTS devices are conventionally used in the power system for voltage profile improvement, helps real and reactive power flow, enhanced transmission capability. Unified power flow controller is used in this project. In this project, steady state UPFC injection model is incorporated in the load flow model. UPFC is optimally placed using active power loss sensitivity factors which were calculated after performing the load flow analysis. UPFC’s role in loss minimization and its influence for loss allocation is verified. Z-Bus loss allocation methodology is used in the project for loss allocation. The impact of UPFC device is tested for 5-bus system, IEEE 14 bus system and IEEE 30 bus system. The results with and without UPFC for the test systems are tabulated and compared. It is found that generally the system loss would decrease after incorporating UPFC. Thus the loss allocation to each participant would be comparatively lower. MATLAB program was used to cross verify the theoretical results.

SCOPE FOR FUTURE WORK

In the project, UPFC’s effectiveness for loss minimization is verified. Similarly other FACTS device’s role in loss minimization can be checked. In

the current project, standard test systems were used. UPFC working in practical systems can be further be evaluated. The loss allocation results using Z-Bus loss allocation can be compared with allocation using alternate methods such as incremental transmission loss allocation, pro-rata and proportional sharing methodologies. A dynamic model of UPFC can be realized for usage in the Optimal Power Flow.

REFERENCES:

- [1] Loss minimization by incorporation of UPFC in load flow studies, s.v. ravi kumar and s. Siva nagaraju. International journal of electrical and power engineering 1(3):321-327.
- [2] Power Flow Control with UPFC in Power Transmission System, Samina Elyas Mubeen, R. K. Nema, and Gayatri Agnihotri, World Academy of Science, Engineering and Technology 47 2008.
- [3] Load Flow Management in the Interconnected Power Systems Using UPFC Devices C. Bulac Member IEEE, M. Eremia Senior Member IEEE, R. Balaurescu, and V. Ștefănescu.
- [4] Steady State Analysis of Unified Power Flow Controller: Mathematical Modeling and Simulation Studies A.M. Vural, Student Member, IEEE, and M. Tumay.
- [5] Analysis and Modeling of UNIFIED POWER FLOW CONTROLLER: Modification of NEWTON-RAPHSON Algorithm and user-defined modeling approach for POWER FLOW STUDIES, M. Tumay and A. M. Vural, October 2004 The Arabian Journal for Science and Engineering, Volume 29, Number 2B.
- [6] A Novel Method of UPFC Location Based on Sensitivity Factors, Anshul Chaudhary, Manish Jain, P.S.Venkataramu, T.Ananthapadmanabha. Proceedings of the 7th WSEAS International Conference on Power Systems, Beijing, China, September 15-17, 2007.
- [7] The modeling of UPFC based on circuit elements in an exact transmission line model, Ali akbar Motiebirjandi Faculty of Electrical Engineering / assistant professor, Kauomars Sabzawari Faculty of Electrical Engineering / M.Sc ,Shahid Rajaei University/ Tehran, 67616, Iran.
- [8] Study and Effects of UPFC and its Control System for Power Flow Control and Voltage Injection in a Power System, Vibhor Gupta / International Journal of Engineering Science and Technology Vol. 2(7), 2010, 2558-2566.
- [9] Control Setting of UNIFIED POWER FLOW CONTROLLER through Load Flow Calculation. C.H Chengaiah, G. V. Marutheswar and R. V. S. Satyanarayana, ARPN Journal of Engineering and Applied Sciences.
- [10] "Estimation of UPFC value using Sensitivity Analysis" by Seungwon An,Thomas W. Gedra.
- [11] "A unified power flow controller concept for flexible AC transmission systems," in Proc. 5th Int. Conf. AC DC Transmission, London, U.K., Sep. 17–20, 1991, pp. 19–26.
- [12] N. G. Hingorani, "Flexible AC transmission," IEEE Spectr., vol. 30, no. 4, pp. 40–45, Apr. 1993.
- [13] L.Gyugyi, "A unified power flow control concept for flexible AC transmission systems," Proc. Inst. Elect. Eng., pt. C, vol. 39, no. 4, pp. 323–331, Jul. 1992.
- [14] Clodomiro Unsuhay and Osvaldo R.Saavedra,"Transmission Loss Unbundling and Allocation Under Pool Electricity Markets"IEEE Trans Power Syst,vol 21,o1,feb 2006.
- [15] A.J Conejo et al,"Z Bus Loss Allocation," IEEE Trans. Power Syst., vol 16 no.1,pp.105-110, feb,2001.
- [16] F.D Galiana et al,"Incremental Transmission loss allocation under pool dispatch,"IEEE Trans Power Syst,vol 17,no1,pp 26-33,feb 2002.
- [17] A.M Leite da silva and J.G.C Costa,"Transmission loss allocation:part 1-single energy market"IEEE Trans Syst.,vol 18,no4,pp 1389-1394,Nov 2003.
- [18] J-H Teng,"Power flow and loss allocation for deregulated transmission systems,"Int.J.Elect .Power Energy Syst.,vol 27,no 4,327-333,may 2005.
- [19] Optimal location of unified power flow controller (UPFC) in Nigerian Grid System, Mark Ndubuka Nwohu, International journal of electrical and Power Engineering, medwell journals,2010.

