

Fabricating and Testing of Porous Magnesium Through Powder Metallurgy Technique using TWSH (Titanium Wire Space Holder) for Biodegradable Bone Scaffold Material

I Sukmana^{1*}, S Savetlana¹, Y Burhanudin¹, M A Wicaksono¹, and H Nur²

¹ Department of Mechanical Engineering, Faculty of Engineering, Universitas Lampung, Building A, Lt 2 FT, Jl. Prof. Soemantri Brojonegoro 1, Bandar Lampung 35145, Indonesia

² Ibnu Sina Institute, Universiti Teknologi Malaysia, UTM Skudai, Johor Bahru, Malaysia

*Email: irza.sukmana@gmail.com

Article Information	Abstract
<p>Received: 3 October 2019</p> <p>Received in revised form: 22 November 2019</p> <p>Accepted: 30 November 2019</p> <p>Volume 1, Issue 2, December 2019 pp. 78 – 83</p> <p>©Universitas Lampung</p> <p>http://dx.doi.org/10.23960/jesr.v1i2.18</p>	<p><i>Magnesium (Mg) and its alloys seem to be a potential biodegradable bone scaffold materials as their biocompatibility and mechanical properties fit to natural bone. Magnesium alloys as biomaterials have higher mechanical properties that may close to cancellous bone once composed and produced in a specific production route. Fabricating porous magnesium for bone scaffold material aims to reduce the rigidity and strength of the material by which the porous density can be adjusted to the original nature of the bone. It forms interconnected porosity, has physical and mechanical properties similar to cancellous bone. This paper describes the production and characterization of porous magnesium material for the potential application as bone scaffold through powder metallurgy technique with pieces of Titanium Wire Space Holder. Mg containing titanium pieces were then compacted and sintered before immersed in hydro fluoride acid solution to form a porous magnesium structure. Density and porosity, micro Vickers hardness, micro structure test and SEM-EDX were performed to prove the existing porous structure inside Mg metal. The result finds out that a good cooperation and a potential application for the fabrication of an inter-connected porous magnesium samples for cancellous bone implant.</i></p> <p>Keywords: porous Magnesium, cancellous bone, bone scaffold, space holder</p>

I. INTRODUCTION

Most people have recently been affected by bone defect regeneration and other organic tissues problems as in fractured or broken bones caused by any factors of accidents, hard hitting, or aging that lead to failure of bone structure tissue regeneration. To handle such problems, it is necessary that bone tissue implantation is performed in order to make it function as it is. Bone implantation applies biomedical material as commonly known as biomaterial.

Biomaterial is a material that interacts with human tissue and body fluids to treat, improve, replace, and regenerate anatomical elements of the human body or so-called implants. The application of *biodegradable* biomaterial is purposed not to remove back the biomaterial implanted in human body, as its properties

of non toxicity, biocompatible, and naturally degradable [1].

Porous metal has low weight with adjustable density (Lefevbre et al, 2008). The well-combined metal and pores make it suitable for structural and functional application (Chiras et al, 2002). The use of porous metal is very supporting for metal implant of cancellous bone structure, as it stimulates the growth of bone tissues, and not hinder its growth. Besides, material implanted in the bone will act as bone scaffold or temporary bone structure material which can strengthen it from corrosion.

To make use of its natural degradable property, magnesium (Mg) is used as a porous metal material as its property of natural degradable in human body [2]. Magnesium (Mg) appears as a safe bone implant material as it has biodegradability, non-toxic, and supporting physical and mechanical functions

properties, which are similar to the nature of bone, as presented by others [3].

Magnesium (Mg) is combined with Titanium (Ti) since its light and supporting chemical and mechanical nature [4]. Porous Magnesium is produced from magnesium powder materials combined with titanium (wire), as space holder [5].

The specimen was produced through compacting-sintering method using *squeeze casting* device. Then, macro-structure analysis and corrosive testing were performed to identify corrosive acceleration. The production of porous magnesium was through titanium wire corrosion process.

The density-porosity testing, followed by micro Vickers hardness, micro-structure analysis, and SEM-EDX testing were performed to achieve porous magnesium properties close to the nature of porous *cancellous bone*, as biomedical bone implant material.

II. MATERIAL AND METHOD

Fabricating porous magnesium made use of powder combined with titanium *wire (space holder)* by applying compacting-sintering method and titanium corrosion used hydrofluoride (HF) acid solution, after that, physical and mechanical were performed.

A. Device and Material

Material used is the powder of magnesium AZ31 with the size of powder 100 μm, 200 μm and 250 μm and titanium *wire* 32 GA (AWG) 200 μm, compacting-sintering device, and hydrofluoride acid (HF) 1 M. Compacting-sintering device consists of *press hydraulic machine* with capacity of 20 tons, *heater coil machine* with temperature capacity of 800°C, *unit control heater TC4M*, *dies-punch*, and argon gas as shown in Fig. 1 [6].

B. Method of Research

Method of research applied is based on parameter and variables of research as shown in Table 1.

Table 1. Research variables

No.	Powder Mg size	Powder Ti size	Comp. Mg:Ti	Press. (Mpa)	T (°C)
1	100 μm	100 μm			
2	200 μm	200 μm	3 to 1	250	400
3	250 μm	250 μm			

Procedure of research conducted is as followed: first, assembling *squeeze casting* device as shown in figure 2. Then, mixing the powder of magnesium with the size of 100 μm, 200 μm and 250 μm with the powder of titanium wire of 200 μm with weight fraction of 3:1.

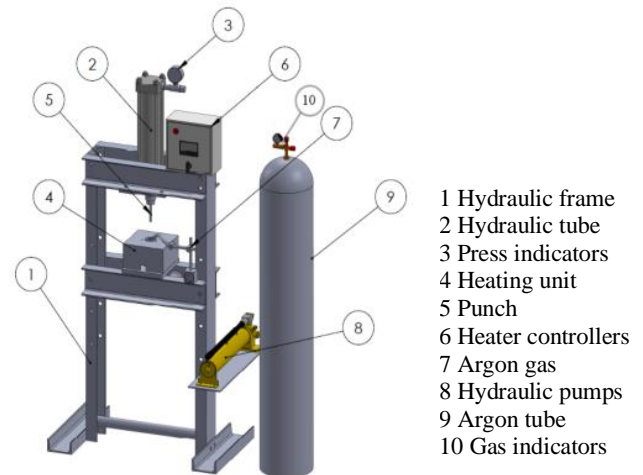
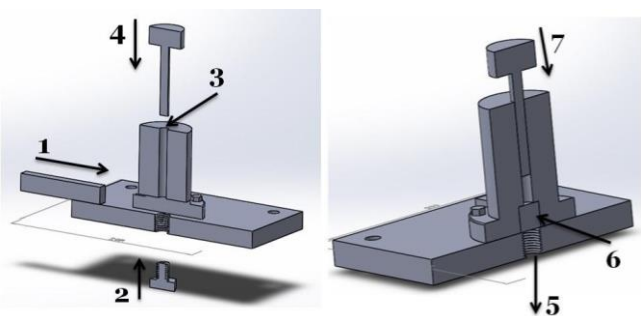

Figure 1. Squeeze casting technique [6]

After that, the powder is put into *dies* and compacted for 250 MPa during 2 minutes. Next, the specimen is removed from *dies* and put again into dies with sintering for 400°C during 5 minutes, and finally the specimen is removed from the dies.



1 Slide ejector; 2 Locking Bolt; 3 Inserting PM; 4 Hydraulic Pump; 5 Unlocking Bolt; 6 Ejector; 7 Pressure out

Figure 2. Procedure of Compacting-Sintering

III. RESULTS AND DISCUSSION

The result of research data is in the form of micro-structure testing, corrosion testing, density-porosity testing, macro hardness testing, micro-structure testing and SEM-EDX.

A. Analysis of Macro-Structure

Analysis of macro-structure is purposed to identify the spreading of titanium and the binding powder Mg at 100μm, 200 μm and 250μm in size respectively (see Figure 3).

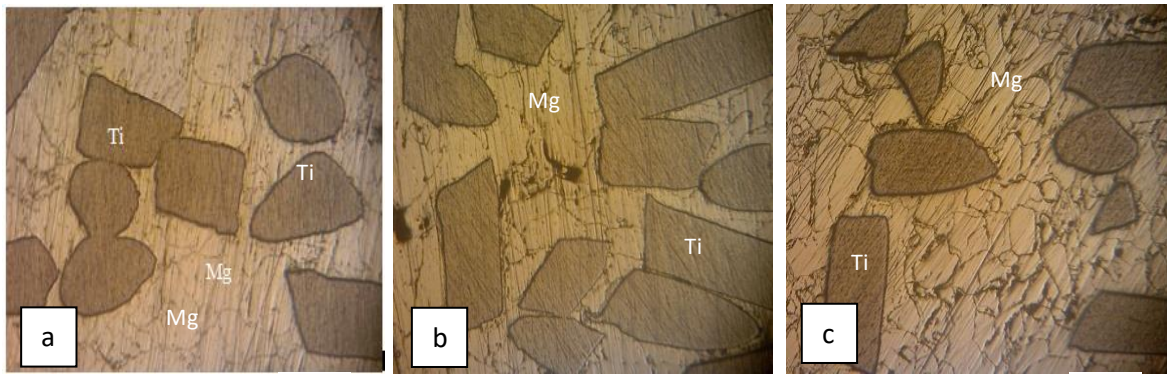

Figure 3. Macro-structure of Mg-Ti composite of (a) 100µm, (b) 200µm, and (c) 250µm powder size (bar is 100µm)

B. Corrosive Testing

Corrosive testing is purposed to identify mass-decreasing acceleration, corrosive acceleration, and the forming of porous magnesium with mass-decreasing estimation (CPR) *corrosion per rate* as shown in Figure 4. Mass specimen (gram) after corrosion of Ti and total mass specimen in soaking time for several minutes.

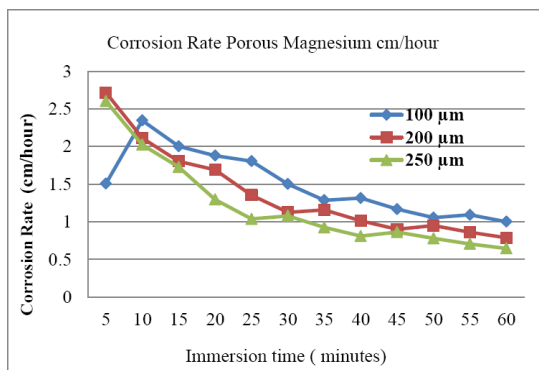

Figure 4. Mass-decreasing Titanium at (a). P-Mg 100 µm, (b). P-Mg 200 µm, and (c). P-Mg 250 µm

C. Density-Porosity Testing

Density-porosity testing is purposed to identify the density and porosity of porous magnesium. The result of research using ASTM C373-88 standard is based on Archimedes law. The result of density-porosity testing is shown in Figure 5.

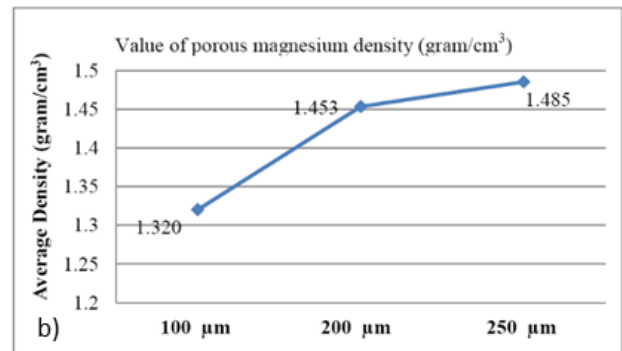
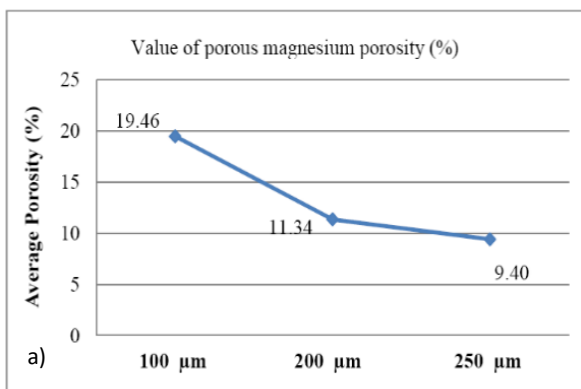

Figure 5 Graphic of density (a) and porosity (b) over the magnesium powder size

D. Micro Vickers Hardness Testing

Hardness testing is purposed to identify the value of hardness with JIS B 7725:2010 testing standard. Hardness testing was performed with the weight of 0.1 N pressure during 12 seconds and 6 times testing with different position. The result of hardness testing is as shown in Figure 6.

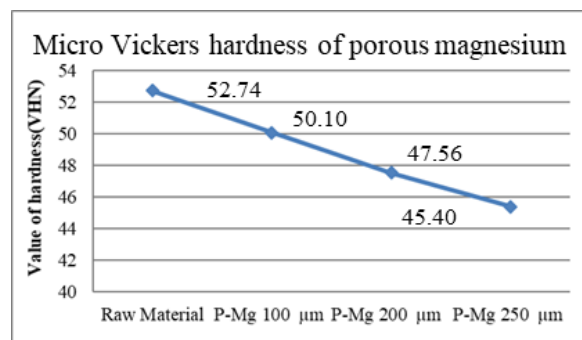

Figure 6. Micro hardness value of Mg-Ti composite with 100 µm, 200 µm and 250 µm magnesium powder size

E. Analysis of Micro-structure

The micro-structure analysis is aim to identify the structure and metallography of the casting Mg-Ti composite product. The microstructure of Mg-Ti composite before degradation process of titanium space holder is shown on Figure 7.

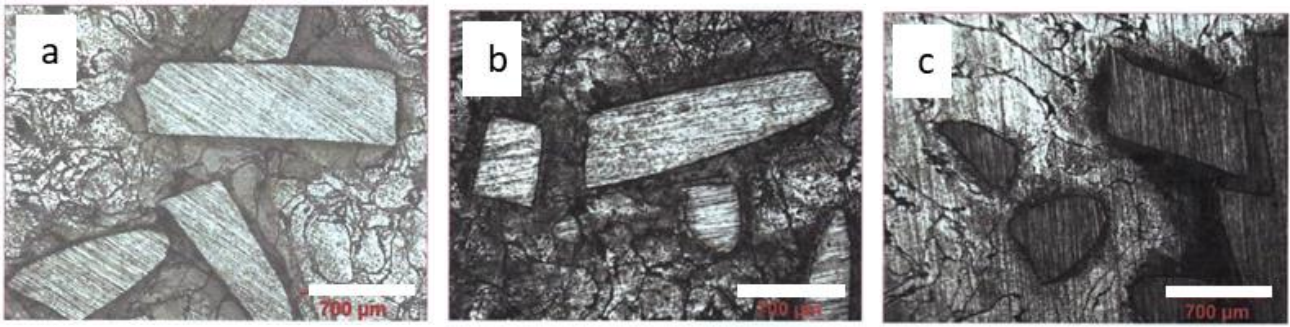

Figure 7. Structure of Micro-Specimen (a). P-Mg 100 μm, P-Mg 200 μm and (c). P-Mg 250 μm

F. SEM-EDX

SEM-EDX testing is purposed to identify micro-structure and the properties of structure composites of

Mg-Ti using sample P-Mg 200 μm after corrosion process is shown on Fig. 8 to Fig. 10.

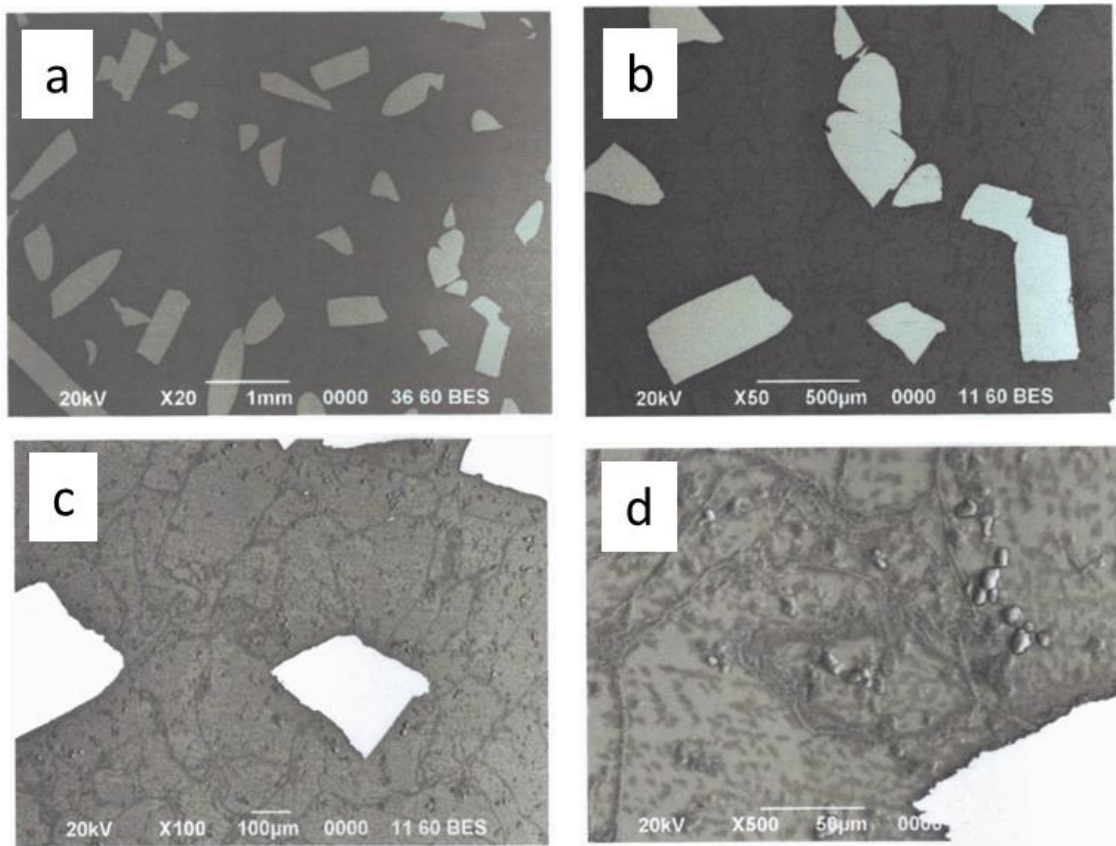

Figure 8. Microscope photo of electron P-Mg 200 μm enlarging (a) 20x, (b). 50 x, (c) 100x, and (d) 500x

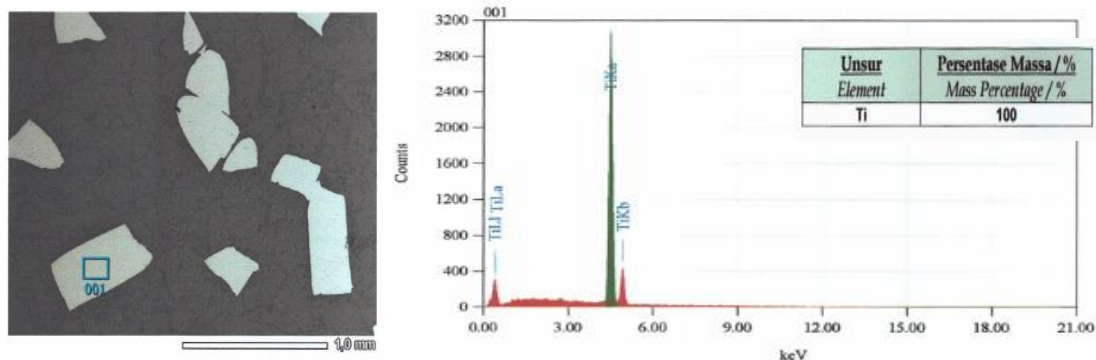

Figure 9. Qualitative analysis of powder magnesium (P-Mg) 200 μm, bar is 1,0 mm

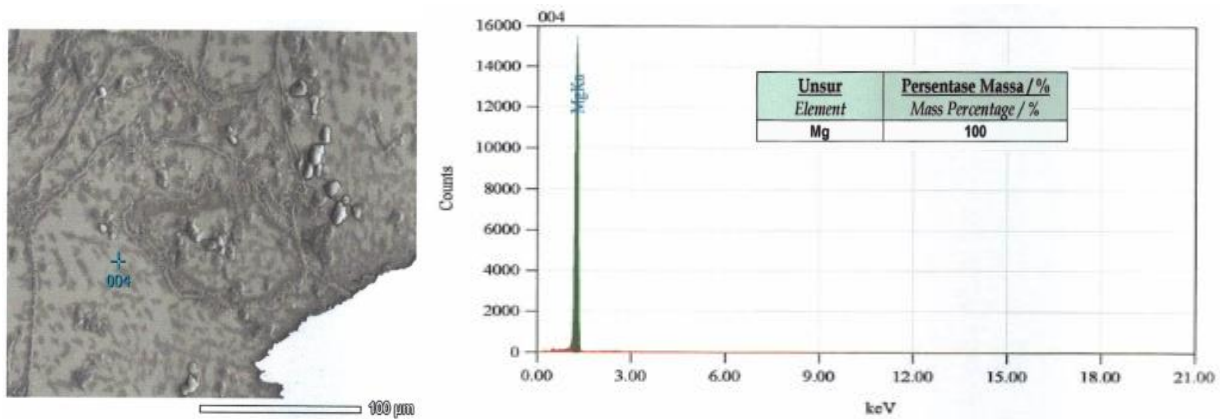

Figure 10. Qualitative analysis of P-Mg 200 µm, bar is 100 µm

G. DISCUSSION

The result of fabricating and testing porous magnesium from macro-structure analysis shows that the spreading of Ti (*wire*) will settle as sediment at the middle and bottom part of specimen, as it is caused by the higher density of Ti compared to Mg. The result of corrosion testing shows that mass-decreasing specimen occurs due to corrosion of Ti using fluids of HF. Specimen of P-Mg 250 µm indicates that specimen has the highest corrosion acceleration rate, which is 0.08 gram/hour and its corrosion acceleration rate is 1.001 cm/hour. The result of density-porosity testing shows that specimen P-Mg 250 µm has value of density of 1.453 gram/cm³ and value of porosity of 11.34 %, however, that value is less than cancellous bone porosity, which is 15-30 %, meaning that, the bigger the size of Mg powder combined with Ti (*wire*) powder, the lower the density, and the higher the porosity.

The result of micro hardness testing shows that the value of hardness of raw material 52.74 VHN, P-Mg 100 µm is 50.10 VHN, P-Mg 200 µm is 47.56 VHN and P-Mg 250 µm is 45.40 VHN. Those values are still much higher than the value of cancellous bone [3,6]. The result of micro-structure testing shows that the bind of Mg powder is very satisfactory through compacting-sintering process, yet the remains found in Ti specimen indicates that Ti corrosion only occurs at the surface of specimen. The result of SEM-EDX testing shows that metallography specimen was in good condition when compare to others [5,7].

EDX result shows a high concentration Titanium due to the hydrofluoride acid liquid can't penetrate inside the specimen, therefore the corrosion process of Ti wire space holder was not the same as in the surface area. This was due to Ti powder combined with Mg powder did not spread well thus causing it difficult to make Ti

corrosive in its inner part of specimen as connectivity among Ti powder did not occurs.

IV. CONCLUSIONS

Several points can be concluded that the corrosion of Ti at corrosion testing indicates that specimen P-Mg 250 µm has high corrosive rate, which is 0.07 gram/hour, and its corrosion acceleration rate is 0.7916 mmpy. Density-porosity testing shows that specimen with powder size of 250 µm has value of density of 1.453 gram/cm³ and value of porosity of 11.34 %, which is close to the nature of porosity of *cancellous bone*, which is 15-30 %. Further hardness testing shows that the Mg-Ti composite is still has higher hardness number when compare to natural bone (about 10.20 VHN). SEM-EDX results show a potential production of Mg-Ti composite for porous degradable bone scaffold using Magnesium powder metallurgy.

ACKNOWLEDGEMENT

The writer would like to express his gratitude for the grant of International Collaboration Grant BLU Universitas Lampung FY2019.

REFERENCES

- [1] X. Navarro, et.al. *Neural Plasticity After Peripheral Nerve Injury and Regeneration*. Group of Neuroplasticity and Regeneration, Institute of Neurosciences and Department of Cell Biology, Physiology and Immunology. Universitat Autònoma de Barcelona, Report 2008.
- [2] I. Sukmana, "Ilmu dan Teknologi Biomaterial". Yogyakarta, Indonesia: Teknosain Publishing, 2nd ed., 2019, pp. 87-110.
- [3] F. Witte, J. Fischer, J. Nellesen, H. A. Crostack, V. Kaese, A. Pisch, F. Beckmann, and H. Windhagen. (2006). In vitro and in vivo corrosion measurements of magnesium alloys. *Biomaterials*. Vol. 27 ed. 7, pp. 1013-1018.
- [4] P. Li, I. Kangasniemi, and K. De Groot. (1994). Hydroxyapatite Induction by a Gel-Derived Titania on

- a Titanium Substrate. *Journal of the Ceramic Society*. Vol.77, no.5, pp. 1307-1312.
- [5] M. Q. Cheng, T. Wahafu, G. F. Jiang, W. Liu, Y. Q. Qiao, C.X. Peng, T. Cheng, X. L. Zhang, G. He, and X. Y. Liu. (2016). A Novel Open-Porous Magnesium Scaffold with Controllable Microstructures and Properties for Bone Regeneration. *Scientific Reports*. Vol. 6 (24143), pp. 1-14.
- [6] N. Wakhid, “Rancang Bangun Perangkat Squeeze Casting untuk Pembuatan Bahan Dasar Material Baut Tulang Berbasis Magnesium AZ31” Degree theses, Dept. Mech. Eng. Univ. Lampung, Indoneisa, 2018.
- [7] S. Chiras, *et al.* (2002). The Structural Performance of Near-Optimized Truss Core Panels. *Int. Journal of Solids and Structures*. Vol. 39, pp. 4093-4115.