



Analysis of Pressure Effects for Current Density and Electric Field Performance of Gas Insulations.

N. A. M. Jamail^{1*}, M. A. N. M. Hisham¹, M. S. Kamarudin¹, M. F. M. Yousof¹,
Q. E. Kamarudin², M. A. M. Piah³, N. S. M. Jamail⁴

¹Faculty of Electrical and Electronic Engineering,
Universiti Tun Hussein Onn Malaysia, 86400 Batu Pahat, Johor, MALAYSIA

²Faculty of Mechanical and Manufacturing Engineering,
Universiti Tun Hussein Onn Malaysia, 86400 Batu Pahat, Johor, MALAYSIA

³Institute of High Voltage & High Current (IVAT), Faculty of Electrical Engineering,
Universiti Teknologi Malaysia, 83000 Johor Bahru, Johor, MALAYSIA

⁴College of Computer and Information Sciences,
Prince Sultan University, P.O Box No. 66833, Rafha Street, Riyadh, SAUDI ARABIA

*Corresponding Author

DOI: <https://doi.org/10.30880/ijie.2020.12.02.011>

Received 29 December 2019; Accepted 27 January 2020; Available online 28 February 2020

Abstract: Gas insulation had been used widely in high voltage industry as a dielectric component. According to the arrangement of gas particles that far apart from each other, lead to the movement of gas particles react fast with high temperature and pressure. Hence when breakdown occurred in a system, it will quickly protect the system by diminished the sparks to avoid flashover occurred. The intention of this research is to determine relationship between current density and electric field of gas insulations that have been used in the insulator. HV experimental test has been conducted, to obtain breakdown voltage of air to use as applied voltage in the simulation for breakdown purpose of three insulation gasses, which are Sulphur Hexafluoride (SF_6), Octafluoropropane (C_3F_8), and Nitrogen (N_2). Physical properties such as thermal conductivity, electrical conductivity, and temperature of each gasses are require to identify value of current density and electric field of each insulation gasses. Furthermore, two pressure spots were placed symmetrically between two electrodes in the insulator. Based on simulation's results, C_3F_8 is the best gas insulation because in normal condition and when presence of pressures it had lowest current density compared to SF_6 and N_2 . Thus, C_3F_8 had the highest value of electric field among the insulation gasses. Electrical insulator is an internal electrical charger that cannot move freely and its contrast with semiconductors and conductors that can conduct electrical current easily. When the insulating material was used to avoid electrical discharges, it's called insulation. High voltage insulation has been used widely in industry at electrical equipment such as switchgear and circuit breaker. The importance of applied high voltage in the electrical equipment is to prevent it from damage when faulty or breakdown occurs. From the results that have been obtained, the best gas insulation can be applied in the insulator as a protective component in electrical industry.

Keywords: Breakdown voltage, pressure, SF_6 , N_2 , current density, electric field

1. Introduction

High voltage insulation act as a protection system to insulate equipment or machines such as switchgear that have been used in industry to prevent it from experiencing damage when electrical breakdown occurs (Abdel-Salam, 2000). Insulation have been divided into three types that are in solid, liquid, and gaseous form (Davies, 1899-1911).

Air is a good insulator because it is abundance and can self-restored after breakdown process. In these modern days, the demand of electricity is increases. Therefore, a new gas insulation technology was created (Okabe *et al.*, 2007).

SF₆, C₃F₈ and N₂ are most common gas insulation that used in industry due to its characteristics that are colourless, odourless, non-flammable and extremely strong greenhouse gas which is good electrical insulator (Christophorou *et al.*, 1997, Shigemitsu Okabe *et al.*, 1997, Masanori Hara *et al.*, 1989).

SF₆ is widely used in electrical industry as a dielectric medium for HV circuit breakers, as example majority substation unit in Malay-sia used gas insulated switchgear (GIS) for protect their electrical protection equipment parts from being damage. This is because it has good dielectric strength compared to other type of gas (Christophorou *et al.*, 1997). Moreover, C₃F₈ is an organic compound which is a product from cobalt fluoride during Fowler process. C₃F₈ also used as refrigera-tion mixtures in other industries (Shigemitsu Okabe *et al.*, 1997). N₂ is a colourless gas which is located at group 15 and period 2 and lightest among its group member in the periodic table. N₂ also a common element where it's oc-curred in all organisms. It also presents in the solar system (Masanori Hara *et al.*, 1989).

Electric field is a vector field that when it combines with magnetic field and electromagnetic field will produced. It being generated by electric charges that have been discussed in Maxwell's equations (Clemmow, 1973). Current density is important in the electrical and electronic de-sign systems. Current density is calculated in amperes per square metre. It also has been used to investigate the physics underlying nature of solids, semiconductors, and insulators (Geurolt *et al.*, 2011). This paper aims to analyse about effects of pressure towards the current densi-ty and electric field. The relationship between electric field and current density had been analysed and compared. SF₆, C₃F₈, and N₂ had been used in this project.

2. Materials and Methods

2.1 Experimental Setup

An experiment has been conducted in HV laboratory. Breakdown voltage of air has been obtained to use as applied voltage in the simulation to breakdown the insulation gasses. The gap distance between electrodes was fixed to 5cm. Furthermore, COMSOL Multiphysics software was used to simulate the gas insulations in two conditions, which are: (1) normal condition; (2) when presence of pressure. COMSOL Multiphysics software able to show condition of current density and electric field in normal condition and when presence of pressure. Fig. 1 shows the arrangement of equipment for single stage circuit in HV laboratory.



Fig. 1 - Basic single stage circuit equipment's arrangement (TERCO, 2011)

2.2 Up and Down Test Method

Based on the standard used, minimum requirement for this testing was 20 shots (European Commitee, 2010). First voltage was obtained when voltage has been increased until the spark gap and load capacitor breakdown (Hughes, 2005). Once breakdown occurred, voltage has been decreased until breakdown was occurred at spark gap only, hence the second voltage was obtained (Hae-Eun JUNG *et al.*, 2008).

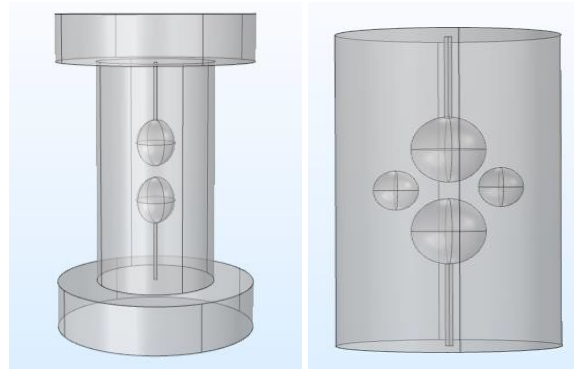

Fig. 2 - Design of HVDC insulator of (a) normal condition; (b) Presence of pressure

COMSOL Multiphysics are finite element analysis and simulation software, it acts as a commercial application that widely used especially in engineering field. Types of problem supported are in electrical, mechanical, fluid and chemical formed. Analysis in electrical parts are electrostatics and low-frequency application. Capabilities in multiphysics analysis includes electromagnetic structure, thermal structure and fluid structure.

In this research, COMSOL Multiphysics software have been used to design the insulator in 3D. The radius for sphere electrode is 10 cm while rod has radius of 1 cm. Moreover, gap distance between electrodes is same as used for testing that fixed to 5 cm. Two pressure spots have been applied symmetrically between the electrodes, where left side is 1000 Pa and right side is 2000 Pa. Fig. 2 shows design of HVDC insulator.

3. Results and Discussion

This section shows results that obtained from Up and Down Test method. Besides that, condition of gas insulations also has been monitored. First results, current density and electric field have been analyses in normal condition. Then, current density and electric field have been analyses when pressure presence in each of the insulation gasses. Indirectly from the results obtained, the best gas also will have a good potential to reduce pollution at our atmosphere. Hence, it will control diseases that give effect to human’s health and avoid or reduce paint colour on the building from damaged example colour faded slowly day by day. For factory industry, it will help to save cost for service and maintenance department to hire contractor for painting purpose.

3.1 Simulations of the Model

Simulations are carried out to obtain the current density, J and electric field, E for each insulation gasses by using COMSOL Multiphysics software. The current density can be defined as equation below:

$$I = \int_s J \cdot dS \tag{1}$$

While, E is electric field that flow in each insulation gasses when voltage was injected. Thus, E can be defined as force exerted per charge and the equation is stated below:

$$E = F/q \tag{2}$$

Ohm’s Law has been used to approve the analysis of this paper (Hughes, 2005).

$$J = \sigma \cdot E \tag{3}$$

Where σ is electrical conductivity of the insulation gasses.

3.2 Test Results for Breakdown Voltage of Air

Fig. 3 shows the value of breakdown voltage for air after 20 shots at 5 cm gap distance between electrodes. The breakdown voltage is linearly decreasing from first shot until eighth shot. Then, the breakdown voltage started to increase until tenth shot and it decreased again at eleventh shot. From eleventh shot, the breakdown voltage increasing linearly until twelfth shot. Start from twelfth shot until fourteenth shot the breakdown voltage slightly decreasing, then slightly increasing until sixteenth shot. From sixteenth shot to eighteenth shot, the breakdown voltage decreased again. For last two shots, the breakdown voltage does not show any drastic changes. From the test results, the average breakdown voltage has been obtained which is 66.47 kV.

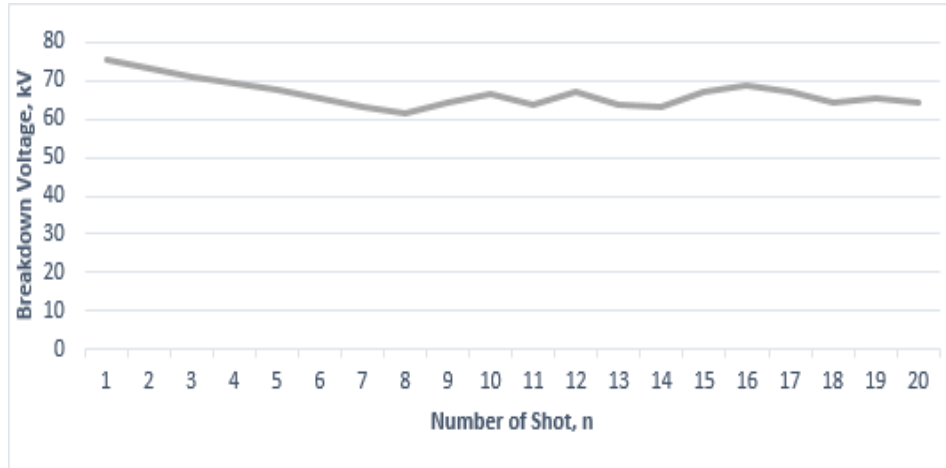
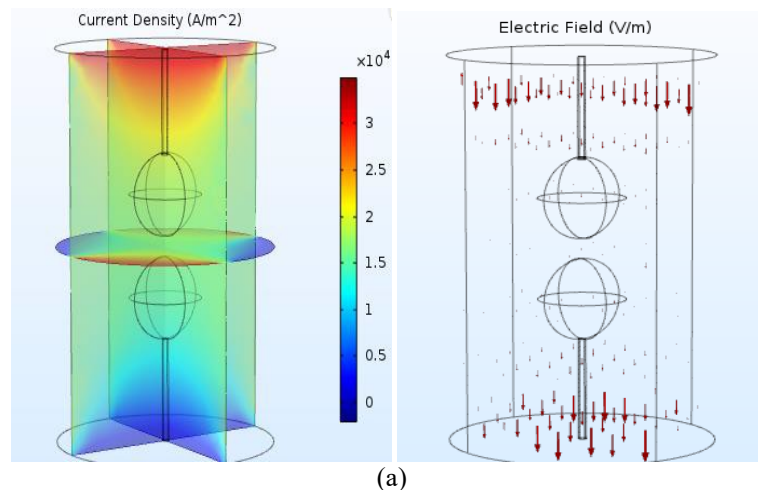

Fig. 3 - Breakdown voltage after 20 shots

3.3 Current Density and Electric Field Performance for Gas Insulations

Main objective of the study is to analyse current density and electric field in normal condition and when pressure been applied in the HVDC insulator. Two pressure spots have been applied which are 1000 Pa and 2000 Pa. Besides that, three insulation gasses were used to differentiate relationship between current density and electric field. Those insulation gasses were Sulphur Hexafluoride (SF₆), Octafluoropropane (C₃F₈), and Nitrogen (N₂). Breakdown voltage of air is used as applied voltage to solve the problem which is 66.47 kV. COMSOL Multiphysics software is used to simulate current density and electric field.

Electrical conductivity of SF₆ is 1.75×10^3 S/m (Christophorou *et al.*, 1997). SF₆ considered as a well-known insulation medium in high voltage industry because of its good insulating properties (Fowler, 1947), strong dielectric strength when at low pressure (Huang, 2006), and its stability in thermal and chemical properties (Zahran *et al.*, 1999). Based on the Fig. 4 (a) shows condition of current density and electric field for SF₆ in normal condition. The value of current density is 28.92×10^6 A/m² and value of electric field is 17.15 kV/m. Fig. 4 (b) shows condition of current density and electric field for SF₆ when presence of pressure. By referring to the quadrant I, II, III and IV, it shows quadrant I has the highest current density. The value of current density at pressure spot 1 was 29.60×10^6 A/m² while at pressure spot 2 was 30.01×10^6 A/m². Hence, value of electric field at pressure spot 1 was 16.91 kV/m while at pressure spot 2 was 16.53 kV/m. Fig. 5 shows the relationship between current density and electric field in all conditions. This phenomenon occurred because the pressure has increased the conductivity of the SF₆ that causes from the collision of gas particles (Xiao *et al.*, 2018).



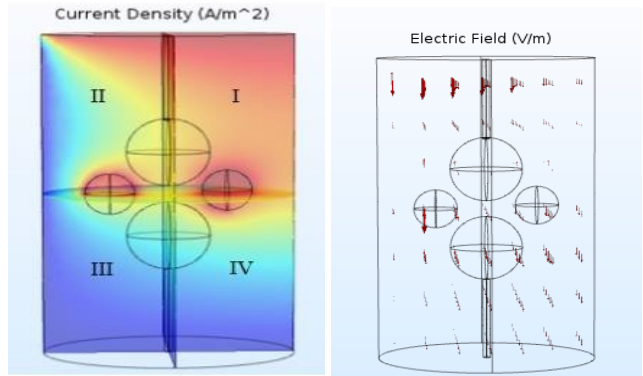

(b)
Fig. 4 - Pattern of electric field and current density of SF₆ for (a) Normal condition; (b) Presence of pressure

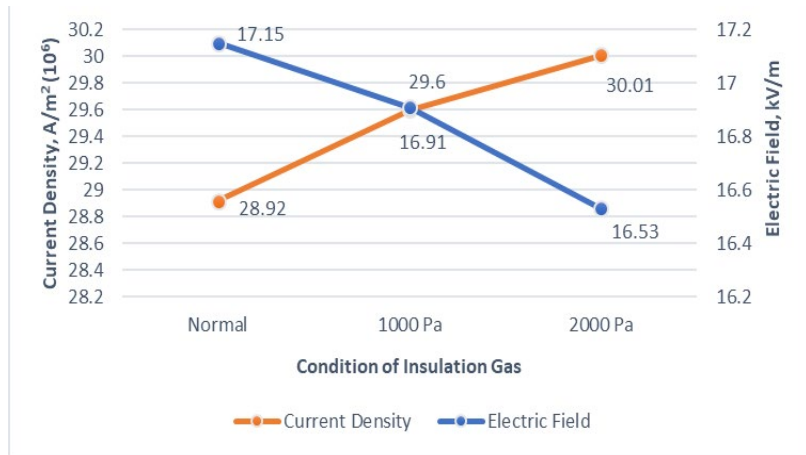
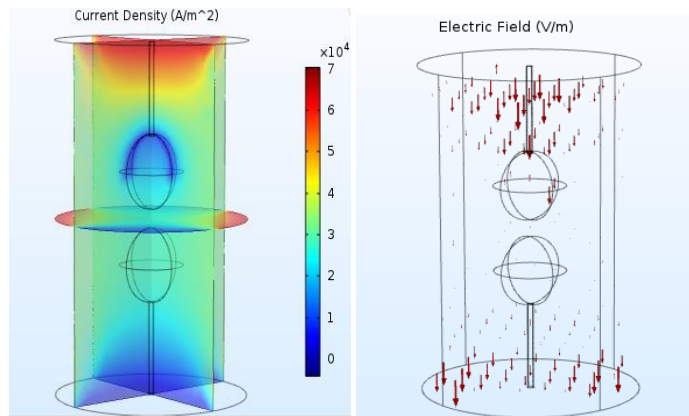

Fig. 5 - Electric field and current density against condition of SF₆

C₃F₈ is a non-flammable fluorocarbon gas. This mixture is non-toxic (Munir *et al.*, 2006). Electrical conductivity of C₃F₈ is 1.64x10³ S/m (Wang *et al.*, 2011). Based on the Figure 6 (a) shows condition of current density and electric field for C₃F₈ in normal condition. The value of current density was 27.75x10⁶ A/m² and value of electric field was 17.20 kV/m. Figure 6 (b) shows condition of current density and electric field for C₃F₈ when presence of pressure. By referring to the quadrant I, II, III and IV, it shows quadrant I has the highest current density. The value of current density at pressure spot 1 was 28.08x10⁶ A/m² while at pressure spot 2 was 28.21x10⁶ A/m². Thus, value of electric field at pressure spot 1 was 17.12 kV/m while at pressure spot 2 was 16.92 kV/m. Figure 7 shows the relationship between current density and electric field in all conditions. Based on results obtained, C₃F₈ has lowest current density than SF₆. This is because differences electrical conductivity between both gasses are 0.11 S/m. Therefore, it has potential to reduce global warming potential (Yamamoto *et al.*, 2001) and also as an alternative way to replace SF₆ gas in the future (Devins *et al.*, 1980).



(a)

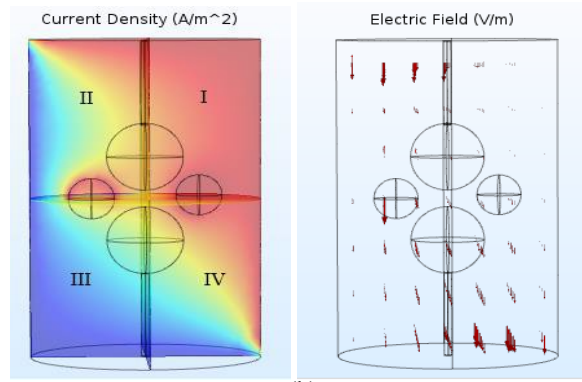

Fig. 6 - Electric field and current density pattern of C_3F_8 in (a) Normal condition; (b) Presence of pressure

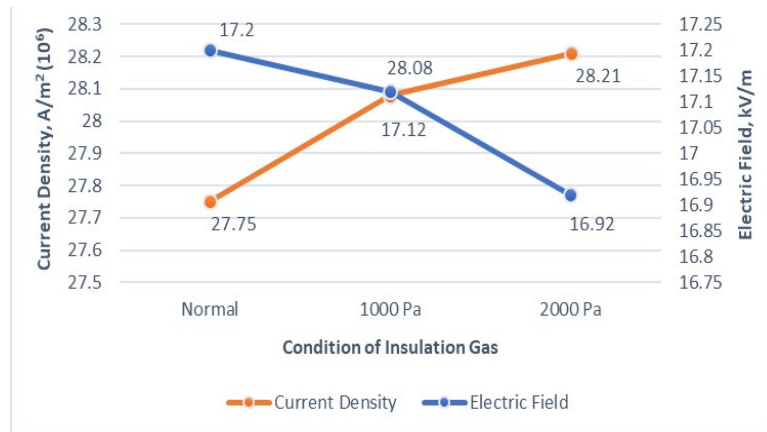
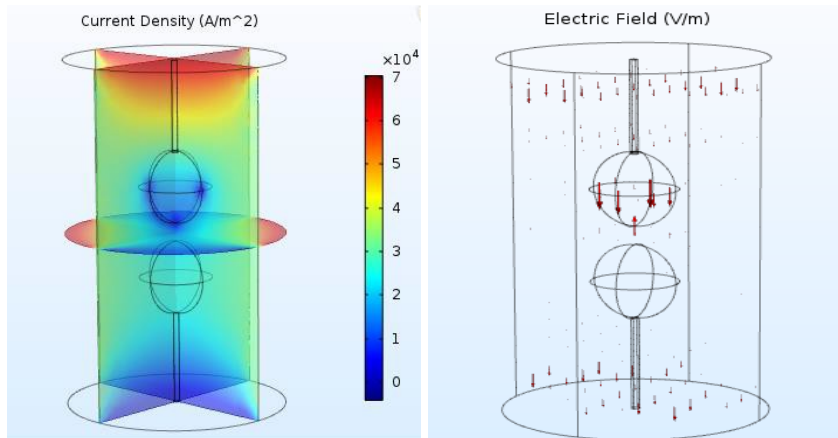

Fig. 7 - Electric field and current density against condition of C_3F_8

N_2 similar with SF_6 where it has been used widely in industry (Christophorou *et al.* 1997). N_2 is combination between living organism and atmosphere but the electrical conductivity of N_2 is five times higher than SF_6 which is 8.74×10^3 S/m (Wada *et al.*, 2016). Based on the Fig. 8 (a) shows condition of current density and electric field for C_3F_8 in normal condition. The value of current density was 142.73×10^6 A/m² and value of electric field was 16.93 kV/m. Fig. 8 (b) shows condition of current density and electric field for C_3F_8 when presence of pressure. By referring to the quadrant I, II, III and IV, it shows quadrant I has the highest current density. The value of current density at pressure spot 1 was 147.07×10^6 A/m² while at pressure spot 2 was 147.98×10^6 A/m². Thus, value of electric field at pressure spot 1 was 16.83 kV/m while at pressure spot 2 was 16.33 kV/m. Fig. 9 shows the relationship between current density and electric field in all conditions. N_2 has the highest current density because it is a heavy gas that required higher voltage to breakdown it (Peters *et al.*, 1993). In this case, it can cause diseases to human and also bring damages to building when it exposed to surrounding (Woelke *et al.*, 2018). Hence, it not suitable to act as an insulation gas (Bremmer *et al.*, 1965).



(a)

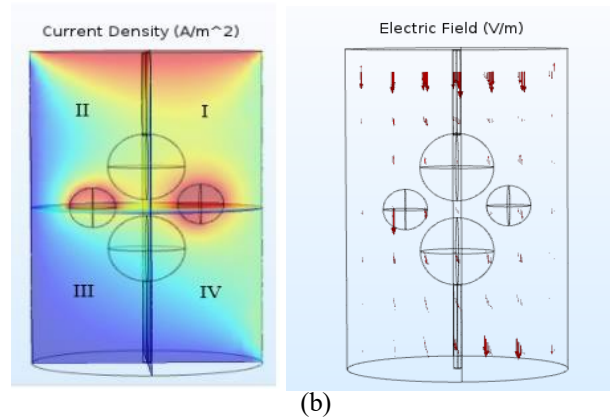

Fig. 8 - Electric field and current density pattern of N₂. (a) Normal condition; (b) Presence of pressure

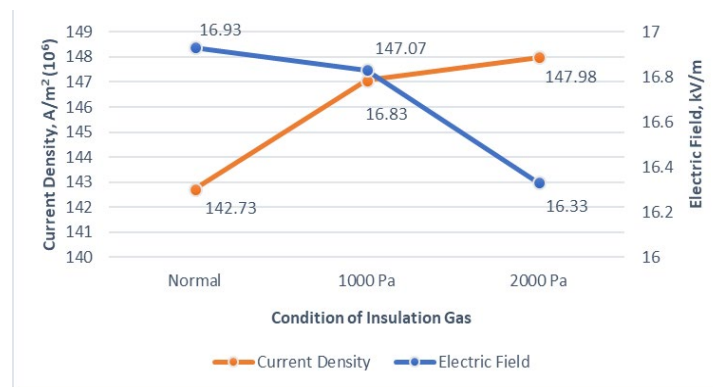

Fig. 9 - Electric field and current density against condition of N₂

4. Conclusion

The result is analysed on the relationship between pressure spots that appeared in the insulator. Hence, the value of current density and electric field depends on the pressure values and the type of insulation gasses been used in the insulator. Thus, the results that obtained from simulation is identified.

C₃F₈ is the best choice for gas insulation because it has lowest current density during normal condition compared to SF₆ and N₂ which is 27.75x10⁶ A/m². Furthermore during at pressure 1000 Pa and 2000 Pa, C₃F₈ also have lowest current density which are 28.08x10⁶ A/m² and 28.21x10⁶ A/m² respectively. Hence, the electric field of C₃F₈ have the highest value in all conditions compared to other insulation gasses, in normal condition the electric field was 17.20 kV/m whereas during at pressure 1 and pressure 2 were 17.12 kV/m and 16.92 kV/m.

As a conclusion, the situation occurred because of electrical conductivity of insulation gas increased at the pressure spot's region. Therefore, electric field that flows toward the pressure spot has been decreased because the electric field became denatured when experienced of high pressure. Based on the results obtained, C₃F₈ is the best gas insulation to replace SF₆ in future because level of GWP (Global Warming Potential) is half than SF₆. Hence, it will protect the ozone layer and reduced greenhouse effect occurred at our beloved earth.

Acknowledgement

The authors gratefully acknowledge the Kvolt Focus Group Team, Universiti Tun Hussein Onn Malaysia and the equipment support from High Voltage Laboratory UTHM.

Author's Note

The author(s) declare(s) that there is no conflict of interest regarding the publication of this article. Authors confirmed that the data and the paper are free of plagiarism.

References

- [1] Abdel-Salam, M. (2000). High-voltage engineering: theory and practice, revised and expanded. CRC Press, 115.
- [2] Davies, G. J. (1899-1911.). Metallic foams: their production, properties and applications. Journal of Materials Science, 18(7).

- [3] Okabe, S., Hisashi, G., Arata, T., Shinichirou, T., Yuji, Y., Eiji, F., & Hitoshi, O. (February 2007). Fundamental insulation characteristic of high-pressure. *IEEE Transactions on Dielectrics and Electrical Insulation*, 14(1).
- [4] Christophorou, G. L., Olthoff, J., & Brunt, R. V. (Sept.-Oct. 1997). Sulfur hexafluoride and the electric power industry, 20-24.
- [5] Shigemitsu Okabe, J. W. (September 2014). Dielectric properties of gas mixtures. *IEEE Transactions on Dielectrics and Electrical Insulation*, 22(4).
- [6] Masanori Hara, J. S. (August 1989). Breakdown characteristics of cryogenic gaseous nitrogen and estimation of its electrical insulation properties. *IEEE Transactions on Electrical Insulation*, 24(4).
- [7] Clemmow, C. P. (1973). *Introduction to electromagnetic theory*. Wiley Interscience, 297.
- [8] R. Gueroult, P. Q. (2011). Investigation of the current density properties of an ion beam extracted from a low-pressure wire discharge.
- [9] TERCO AB, HV 9000 (2011). High voltage modular training set.
- [10] European Committee for Electrotechnical Standardization, BS EN 60060-1:2010 (2010). High-voltage test techniques, Part 1: General definition and test requirements. BSI Standards Publication.
- [11] Hughes, S. (24 February 2005). Ohm's law. In D. o. Physics, Current, continuity equation, resistance, Ohm's law. Massachusetts Institute of Technology, 63-71.
- [12] Hae-Eun JUNG, Jae-Hun YUN, Chung LEE, Seong-Hwa KANG, Kyu-Boek CHO and Kee-Joe LIM. (April, 2008). Analysis of ac breakdown of composite-insulation depending on gas pressure and solid insulation thickness. International Conference on Condition Monitoring and Diagnosis, Beijing, China.
- [13] L. Chen, H. Griffiths, A. Haddad, and M. S. Kamarudin (2016). Breakdown of CF3I gas and its mixtures under lightning impulse in coaxial-gil geometry. *IEEE Trans. Dielectr. Electr. Insul.*, 23.
- [14] R.D. Fowler, W. Buford III, J. Hamilton, Jr., R. Sweet, C. Weber, J. Kasper, I. Litant. (March 1947). Synthesis of Fluorocarbons. *Industrial & Engineering Chemistry*.
- [15] Huang, E., Mittal, G. S., & Griffiths, M. W. (2006). Inactivation of Salmonella enteritidis in liquid whole egg using combination treatments of pulsed electric field, high pressure and ultrasound. *Biosystems Engineering*, 94(3), 403-413.
- [16] Zahran, H. H. (1999). Rhizobium-legume symbiosis and nitrogen fixation under severe conditions and in an arid climate. *Microbiology and molecular biology reviews*, 63(4), 968-989.
- [17] Xiao, D. (2018). Development prospect of gas insulation based on environmental protection. In *Simulation and Modelling of Electrical Insulation Weaknesses in Electrical Equipment*. IntechOpen.
- [18] Munir, Z. A., Anselmi-Tamburini, U., & Ohyanagi, M. (2006). The effect of electric field and pressure on the synthesis and consolidation of materials: A review of the spark plasma sintering method. *Journal of Materials Science*, 41(3), 763-777.
- [19] Wang, W., Rong, M., Wu, Y., Spencer, J. W., & Yan, J. D. (2011, October). Transport coefficients of high temperature CF 4, C 2 F 6, and C 3 F 8 as candidate of SF 6. In 2011 1st International Conference on Electric Power Equipment-Switching Technology, 621-625.
- [20] Yamamoto, O., Takuma, T., Hamada, S., Yamakawa, Y., & Yashima, M. (2001). Applying a gas mixture containing C_4F_8 as an insulation medium. *IEEE Transactions on Dielectrics and Electrical Insulation*, 8(6), 1075-1081.
- [21] Devins, J. C. (1980). Replacement gases for SF6. *IEEE Transactions on Electrical Insulation*, 2 81-86.
- [22] Christophorou, L. G., Olthoff, J. K., & Van Brunt, R. J. (1997). Sulfur hexafluoride and the electric power industry. *IEEE Electrical Insulation Magazine*, 13(5), 20-24.
- [23] Wada, J., Ueta, G., Okabe, S., & Hikita, M. (2016). Dielectric properties of gas mixtures with per-fluorocarbon gas and gas with low liquefaction temperature. *IEEE Transactions on Dielectrics and Electrical Insulation*, 23(2), 838-847.
- [24] Peters, T. M., Chein, H., Lundgren, D. A., & Keady, P. B. (1993). Comparison and combination of aerosol size distributions measured with a low-pressure impactor, differential mobility particle sizer, electrical aerosol analyzer, and aerodynamic particle sizer. *Aerosol Science and Technology*, 19(3), 396-405.
- [25] Woelke, B., Ramesh, M., & Lemke, F. (2018, November). Application of an environmentally friendly SF6 free medium voltage switchgear technology in a pilot setup. In *VDE High Voltage Technology 2018; ETG-Symposium*, 1-6. VDE.
- [26] Bremner, J. M. (1965). *Alliance of Crop, Soil, and Environmental Science Societies*. USA: Access DL.