

# Homological mirror symmetry for invertible curve singularities

*Matthew Habermann*

A dissertation submitted in partial fulfillment  
of the requirements for the degree of  
**Doctor of Philosophy**  
of  
**University College London.**

Department of Mathematics  
University College London

October 11, 2021



I, Matthew Habermann, confirm that the work presented in this thesis is my own, except for the content of Chapter 3, which is based on work completed in collaboration with Jack Smith. Where information has been derived from other sources, I confirm that this has been indicated in the work.



# Abstract

The central theme of this thesis is homological mirror symmetry for curve singularities defined by invertible polynomials. The main results are contained in Chapters 3, 4, and 5. Chapter 3 is based on joint work with Jack Smith, and establishes homological Berglund–Hübsch mirror symmetry for invertible polynomials in two variables by matching generating collections on both sides. Along the way, we show that the category of graded matrix factorisations has a tilting object, confirming a conjecture of Lekili and Ueda ([LU18, Conjecture 1.3]) in the case of curves.

In Chapter 4, we build on the results of Chapter 3 to establish a derived equivalence between the Fukaya category of the Milnor fibre and the derived category of perfect complexes on the proposed mirror. The strategy of proof builds on that of Lekili and Ueda in [LU18], and uses a moduli of  $A_\infty$ -structures argument. A key step in the proof of this result is to reconstruct the Milnor fibres by a gluing procedure.

In Chapter 5, we prove homological mirror symmetry for a framework which generalises that of invertible curve singularities. Namely, the B–model is taken to be a chain or ring of weighted projective lines joined nodally such that each irreducible component is allowed to have non-trivial generic stabiliser, and the A–model is built using the gluing construction of Chapter 4. As a special case, this completely resolves a conjecture of Lekili and Ueda on invertible polynomials ([LU18, Conjecture 1.4]) in complex dimension one. This also re-establishes the results of Chapter 4 by different methods and generalises the results of [LP17b]. As a corollary, we prove some derived equivalences between categories of sheaves on the B–models by studying when the corresponding A–models are graded symplectomorphic.



*To my parents, Helen and Peter, with love and gratitude.*





# Impact Statement

The work in this thesis sits at the intersection of three prominent areas of modern mathematics: symplectic topology, algebraic geometry, and representation theory. The main results uniformly establish several homological mirror symmetry conjectures in the first non-trivial dimension – that of curves. Thus, I believe that the results of this thesis will find application due to the interest of the mathematical community in these conjectures. I also believe the techniques in this thesis are able to be further developed to provide new tools in their respective fields, independent of applications to homological mirror symmetry.

In order to achieve this impact, the paper on which Chapter 3 is based has already appeared in a peer-reviewed journal, whilst the paper on which Chapter 4 is based has been accepted for publication. In addition, the paper on which Chapter 5 is based is publicly available on the arXiv, and has been submitted for peer-review. Interest in this work is evidenced by citations of subsequent work by various authors, as well as my recent invitations to present the findings of my thesis in, for example, seminars at the Korean Institute of Advanced Study, the University of Hamburg, and the FD Seminar (Bonn).



# Acknowledgements

First and foremost, I would like to thank my advisor, Yankı Lekili, for his guidance, patience, and enthusiasm throughout my PhD. I have benefited enormously from his wealth of expertise, and his generosity in sharing it. I am also grateful to my second advisor, Jack Smith, for his constant support and encouragement, as well as for his collaboration on the work presented in Chapter 3.

I am indebted to Huy Nguyen, whose guidance began during my honours year at the University of Queensland in 2016, and has continued through to the present day. I was only at the very beginning of my mathematical journey then, but his encouragement and support contributed greatly not just to my desire to pursue a PhD, but also to the belief that I was able to. I hope that I can be forgiven for turning away from geometric analysis.

I have learnt a lot from conversations with many people, particularly during the Symplectic Cut seminar, where the guidance of Jonny Evans, Steven Sivek, Ed Segal, Sam Gunningham, and Tim Magee were invaluable to me as a graduate student in geometry. I have also appreciated conversations with Brad Doyle, Federico Barbacovi, Angela Wu, and Dougal Davis, who have been very willing to share their respective expertise with me.

I would also like to thank my examiners, Ed Segal and Ailsa Keating, for their careful reading of this thesis and subsequent corrections and suggestions which have greatly improved it.

I would like to thank my family for their constant support, not just during my PhD, but in all of my endeavours. In particular, I am grateful to my parents, Helen

and Peter, to whom I dedicate this work. It has been the opportunities they have provided which have allowed me to write this thesis.

I am also grateful to my grandparents, in particular to Clive, for sparking my interest in science, and always being willing to share his knowledge. I would also like to thank my aunt and uncle, Lesley and Andrew, whose increased presence in our lives since moving to the UK has been most welcome.

Also deserving of special thanks is my wife, Bridget, whose companionship has made the good times better and the hard times bearable. I am also grateful to John, Wendy, and the rest of my new family in the US for welcoming me with such open arms.

My studies were funded by the Engineering and Physical Sciences Research Council [EP/L015234/1], The EPSRC Centre for Doctoral Training in Geometry and Number Theory (The London School of Geometry and Number Theory), University College London.

# Contents

<b>1</b>	<b>Introduction</b>	<b>19</b>
1.1	Homological mirror symmetry for invertible polynomials . . . . .	21
1.2	Statement of results . . . . .	28
1.3	Conventions . . . . .	34
<b>2</b>	<b>Preliminaries</b>	<b>35</b>
2.1	Symplectic preliminaries . . . . .	35
2.1.1	Fukaya categories of exact symplectic manifolds . . . . .	36
2.1.2	Background on Picard–Lefschetz theory . . . . .	46
2.2	Preliminaries on invertible polynomials . . . . .	53
<b>3</b>	<b>Homological Berglund–Hübsch mirror symmetry for curve singularities</b>	<b>61</b>
3.1	Introduction . . . . .	61
3.1.1	Proof outline . . . . .	61
3.1.2	Structure of the chapter . . . . .	64
3.2	B-model for loop polynomials . . . . .	64
3.2.1	Graded matrix factorisations . . . . .	64
3.2.2	The basic objects . . . . .	66
3.2.3	Morphisms between $K_x$ 's, between $K_y$ 's, and from $K_w$ to itself	68
3.2.4	Morphisms between $K_x$ 's, $K_y$ 's, and $K_w$ . . . . .	71
3.2.5	Morphisms between $K_w$ and $K_0$ 's . . . . .	72
3.2.6	Morphisms between $K_x$ 's and $K_y$ 's and $K_0$ 's . . . . .	74

3.2.7	Morphisms between $K_0$ 's . . . . .	74
3.2.8	The total endomorphism algebra of the basic objects . . . . .	75
3.2.9	Generation . . . . .	77
3.3	A-model for loop polynomials . . . . .	81
3.3.1	A resonant Morsification . . . . .	81
3.3.2	The zero-fibre and its smoothing $\Sigma$ . . . . .	83
3.3.3	The preliminary vanishing cycles . . . . .	85
3.3.4	Modifying the vanishing paths . . . . .	90
3.3.5	Isotoping the vanishing cycles and computing the morphisms . . . . .	94
3.3.6	Composition . . . . .	97
3.3.7	Gradings and completing the proof . . . . .	100
3.4	B-model for chain polynomials . . . . .	103
3.4.1	The basic objects . . . . .	103
3.4.2	Morphisms between the $K_y$ 's and $K_w$ . . . . .	104
3.4.3	Morphisms between $K_y$ 's and $K_w$ and $K_0$ 's . . . . .	104
3.4.4	Morphisms between the $K_0$ 's . . . . .	105
3.4.5	The total endomorphism algebra of the basic objects . . . . .	106
3.4.6	Generation . . . . .	107
3.5	A-model for chain polynomials . . . . .	109
3.5.1	The setup . . . . .	109
3.5.2	The vanishing cycles . . . . .	110
3.5.3	Composition and gradings . . . . .	112
3.6	Brieskorn–Pham polynomials . . . . .	113
3.6.1	B-model . . . . .	113
3.6.2	A-model . . . . .	115
<b>4</b>	<b>Homological mirror symmetry for Milnor fibres of invertible curve singularities</b>	<b>119</b>
4.1	Introduction . . . . .	119
4.1.1	Strategy of proof . . . . .	119
4.1.2	Structure of the chapter . . . . .	125

4.2	Unfoldings of invertible polynomials in two variables . . . . .	125
4.2.1	Unfoldings of loop polynomials . . . . .	128
4.2.2	Unfoldings of chain polynomials . . . . .	129
4.2.3	Unfoldings of Brieskorn–Pham polynomials . . . . .	131
4.3	Symplectic topology of the Milnor fibre . . . . .	133
4.3.1	Graded symplectomorphisms . . . . .	133
4.3.2	Gluing cylinders . . . . .	142
4.3.3	Symplectic cohomology of the Milnor fibre . . . . .	151
4.3.4	Graded symplectomorphisms between Milnor fibres . . . . .	153
4.4	Hochschild cohomology via matrix factorisations . . . . .	156
4.4.1	Loop polynomials . . . . .	159
4.4.2	Chain Polynomials . . . . .	162
4.4.3	Brieskorn–Pham Polynomials . . . . .	165
4.4.4	Unfoldings of invertible polynomials . . . . .	167
4.5	Generators and formality . . . . .	169
4.6	Homological mirror symmetry for invertible curve singularities . . . . .	171
<b>5</b>	<b>Homological mirror symmetry for nodal stacky curves</b>	<b>175</b>
5.1	Introduction . . . . .	175
5.1.1	Structure of the chapter . . . . .	182
5.2	Root stacks . . . . .	182
5.2.1	Root stacks and stacky fans . . . . .	192
5.3	Auslander orders . . . . .	196
5.4	The partially wrapped Fukaya category . . . . .	203
5.4.1	Computation of the partially wrapped Fukaya category . . . . .	203
5.5	Localisation . . . . .	208
5.5.1	Localisation on the B–side . . . . .	208
5.5.2	Localisation on the A–side . . . . .	210
5.6	Characterisation of perfect derived categories . . . . .	214
5.6.1	The derived category of perfect complexes . . . . .	214
5.6.2	Characterisation of the compact Fukaya category . . . . .	215

5.7 Applications . . . . . 216  
5.7.1 Invertible polynomials . . . . . 219

**Bibliography** . . . . . **237**



# List of Figures

1.1	A chain of $n$ curves. . . . .	31
3.1	The quiver describing the category $\mathcal{B}$ for loop polynomials. . . . .	76
3.2	The critical values of $\check{w}_\varepsilon$ (crosses), the vanishing path for critical value 0, and three of the preliminary vanishing paths, when $(p, q) = (4, 6)$ . . . . .	83
3.3	The fibre $\check{w}_\varepsilon^{-1}(0)$ for loop polynomials. . . . .	84
3.4	Schematic picture of some preliminary vanishing cycles in $\Sigma'$ for loop polynomials. . . . .	86
3.5	The $\check{x}$ -projection of the preliminary vanishing cycles ${}^{1,0}V_0^{\text{pr}}$ (left) and ${}^{1,1}V_0^{\text{pr}}$ (right) in the $\check{x}$ -axis part of $\Sigma'$ and the $V_{\check{x}\check{y}}$ - and ${}^lV_{\check{y}\check{w}}$ -necks, with $(p, q) = (4, 3)$ . . . . .	89
3.6	The paths $\gamma'_{l,m}$ in modulus-(argument $+\pi$ ) space, when $(p, q) = (4, 6)$ . . . . .	91
3.7	The path $\gamma''_{2,4}$ when $(p, q) = (4, 6)$ . . . . .	93
3.8	The $\check{x}$ -projection of the final vanishing cycles ${}^{1,0}V_0$ and ${}^{1,1}V_0$ in the $\check{x}$ -axis part of $\Sigma'$ and the $V_{\check{x}\check{y}}$ - and ${}^lV_{\check{y}\check{w}}$ -necks, with $(p, q) = (4, 3)$ . . . . .	95
3.9	The $V_{\check{x}\check{y}}$ -neck regions of the curves ${}^{l,m}V_0$ and ${}^{l,M}V_0$ before (left) and after (right) perturbing and isotoping. . . . .	96
3.10	The obvious triangles in the $V_{\check{x}\check{y}}$ -neck contributing to the product in the first (left) and fourth (right) cases. . . . .	98
3.11	The $\check{x}$ -projection of the obvious triangle between ${}^{1,0}V_0$ , ${}^{1,1}V_0$ , and ${}^lV_{\check{y}\check{w}}$ , when $(p, q) = (4, 3)$ . . . . .	98
3.12	Foliations defining the line field $\ell$ used to grade $\Sigma$ . . . . .	101
3.13	The quiver describing the category $\mathcal{B}$ for chain polynomials. . . . .	107

3.14	The fibre $\check{\mathfrak{w}}_{\varepsilon}^{-1}(0)$ for chain polynomials. . . . .	110
3.15	The quiver describing the category $\mathcal{B}$ for Brieskorn–Pham polynomials. . . . .	114
3.16	The fibre $\check{\mathfrak{w}}_{\varepsilon}^{-1}(0)$ for Brieskorn–Pham polynomials. . . . .	116
3.17	The quiver describing the intersection pattern. . . . .	117
4.1	Example of surface glued from cylinders . . . . .	143
4.2	Milnor fibre for $\check{\mathfrak{w}} = \check{x}^4\check{y} + \check{x}\check{y}^3$ . . . . .	146
4.3	Ribbon graph for $\Gamma(\check{V}) = \Gamma(\Sigma_{\text{loop}}(4, 3))$ . . . . .	148
5.1	A collection of generating Lagrangians for $\mathbb{D}^2$ with $m$ stops. . . . .	205
5.2	A collection of generating Lagrangians for $A(a, b; 0)$ . . . . .	206
5.3	Quiver for $A(a, b; 0)$ . . . . .	206
5.4	Generating collections of Lagrangians for linear gluing of $A(2, 2; 2)$ to $A(4, 3; 1)$ via $\sigma_1 : (0, 1, 2, 3) \mapsto (0, 2, 1, 3)$ . . . . .	207
5.5	Quiver describing the endomorphism algebra of the generating col- lection of Figure 5.4. . . . .	208
5.6	Part of the ribbon graph corresponding to $\check{V}$ for $\check{\mathfrak{w}} = \check{x}^5\check{y} + \check{y}^5\check{x}$ . . . . .	228
5.7	Ribbon graph corresponding to $\check{V}/\mu_2$ for $\check{\mathfrak{w}} = \check{x}^5\check{y} + \check{y}^5\check{x}$ . . . . .	229
5.8	Ribbon graph corresponding to $\check{V}/\mu_4$ for $\check{\mathfrak{w}} = \check{x}^5\check{y} + \check{y}^5\check{x}$ . . . . .	229

## Chapter 1

# Introduction

There has always been an interplay between mathematics and theoretical physics, although this relationship has grown stronger in recent decades. In particular, mathematical ideas which have arisen from string theory have proven to be truly revolutionary, providing a deep insight into relationships between areas of mathematics which were previously thought to be unconnected. One of the most consequential ideas which has arisen is *homological mirror symmetry*. Roughly speaking, this posits an equivalence between certain categories arising in the study of the symplectic topology of one space, possibly equipped with some extra data, and the algebraic geometry of another. These are known as the A– and B–models, respectively.

Before mirror symmetry, symplectic topology and algebraic geometry were not seen as being intimately linked. Topology is a global study, and any two symplectic manifolds of the same dimension are locally equivalent. On the other hand, this is far from true in algebraic geometry, where the objects of study are more rigid. It therefore stands to reason that these geometries should not be closely related (if at all); however, this conventional wisdom was overturned in [CdILOGP91], where symplectic enumerative invariants were correctly predicted using the principle of mirror symmetry.

Several years after this initial breakthrough, the original enumerative predictions were refined by Maxim Kontsevich in his 1994 ICM address ([Kon95]) to

conjecture that a *categorical* version of mirror symmetry should hold. The resulting homological mirror symmetry (HMS) conjecture proposed that certain categories arising in the study of symplectic topology and algebraic geometry of a mirror pair of Calabi–Yau varieties should be equivalent, and that this should be the underlying phenomenon explaining the previously observed dualities. Subsequently, there have been numerous generalisations to predict equivalences between the categories arising from the A– and B– models in the setting of, for example, Fano or general type varieties, stacks, or Landau–Ginzburg models on these spaces (cf. [HV00], [KKOY09], [KL03], [Sei01]).

There is now a significant body of evidence towards the HMS conjecture in all of its interpretations, where important cases have been proven in, for example, [PZ98], [Sei03], [She15], [AKO08], [AAE<sup>+</sup>13], [LP17a]. Nevertheless, there is still not even a conjectural mirror partner for many A– or B–models, and examples of the correspondence have remained difficult to prove, even in cases where the conjectured mirror pair is explicitly understood.

Recently, homological mirror symmetry for *invertible polynomials* has gained a lot of attention. In this context, HMS is a series of conjectures which postulate a relationship between the symplectic topology and algebraic geometry of two polynomials which are related by a very elementary operation – matrix transposition. The precise and simple formulation of HMS for invertible polynomials allows one to overcome the first major obstacle of mirror symmetry – predicting what the mirror model should be – although the conjectures are still sufficiently broad in scope to provide new and interesting examples. The main results of this thesis provide a uniform treatment of the first non-trivial case of these conjectures – that of curves.

## 1.1 Homological mirror symmetry for invertible polynomials

Consider an  $n \times n$  matrix  $A$  with non-negative integer entries  $a_{ij}$ . From this, we can define a polynomial  $\mathbf{w} \in \mathbb{C}[x_1, \dots, x_n]$  given by

$$\mathbf{w}(x_1, \dots, x_n) = \sum_{i=1}^n \prod_{j=1}^n x_j^{a_{ij}}.$$

In what follows,  $\mathbf{w}$  will always be quasi-homogeneous, and so we can associate to it a *weight system*  $(d_0, d_1, \dots, d_n; h_{\mathbf{w}})$ , where

$$\mathbf{w}(t^{d_1}x_1, \dots, t^{d_n}x_n) = t^{h_{\mathbf{w}}} \mathbf{w}(x_1, \dots, x_n),$$

and  $d_0 := h_{\mathbf{w}} - d_1 - \dots - d_n$ . There is a trichotomy of cases depending on  $d_0$ :

- Log Fano:  $d_0 < 0$ ,
- Log Calabi–Yau:  $d_0 = 0$ ,
- Log general type:  $d_0 > 0$ .

In the case of two variables, which is the primary focus of this thesis, all invertible polynomials are of log general type with the exception of  $\mathbf{w} = x^2 + y^2$ . In [BH93], the authors define the transpose of  $\mathbf{w}$ , denoted by  $\check{\mathbf{w}}$ , to be the polynomial associated to  $A^T$ ,

$$\check{\mathbf{w}}(\check{x}_1, \dots, \check{x}_n) = \sum_{i=1}^n \prod_{j=1}^n \check{x}_j^{a_{ji}},$$

and we call this the *Berglund–Hübsch transpose*. One can associate a weight system for  $\check{\mathbf{w}}$ , denoted by  $(\check{d}_0, \check{d}_1, \dots, \check{d}_n; \check{h}_{\check{\mathbf{w}}})$ , in the same way. We call a polynomial  $\mathbf{w}$  *invertible* if the matrix  $A$  is invertible, and if both  $\mathbf{w}$  and  $\check{\mathbf{w}}$  define isolated singularities at the origin. Such polynomials are automatically quasi-homogeneous and the systems of weights associated to  $\mathbf{w}$  and  $\check{\mathbf{w}}$  are unique (see Chapter 2).

Recall that for  $f \in \mathbb{C}[x_1, \dots, x_n]$  and  $g \in \mathbb{C}[y_1, \dots, y_m]$ , their Thom–Sebastiani sum is defined as

$$f \boxplus g = f \otimes 1 + 1 \otimes g \in \mathbb{C}[x_1, \dots, x_n, y_1, \dots, y_m]. \quad (1.1)$$

A corollary of Kreuzer–Skarke’s classification of quasi-homogeneous polynomials, [KS92], is that any invertible polynomial can be decoupled into the Thom–Sebastiani sum of *atomic* polynomials of the following three types:

- Fermat:  $\mathbf{w} = x_1^{p_1}$ ,
- Loop:  $\mathbf{w} = x_1^{p_1} x_2 + x_2^{p_2} x_3 + \dots + x_n^{p_n} x_1$ ,
- Chain:  $\mathbf{w} = x_1^{p_1} x_2 + x_2^{p_2} x_3 + \dots + x_{n-1}^{p_{n-1}} x_n + x_n^{p_n}$ .

The Thom–Sebastiani sums of polynomials of Fermat type are also called Brieskorn–Pham.

**Remark 1.1.1.** *In this thesis, when we refer to an ‘invertible polynomial’, we will always mean a polynomial of loop, chain, or Brieskorn–Pham type unless otherwise stated, and also assume that each  $p_i \geq 2$ .*

To any invertible polynomial, one can associate its *maximal symmetry group*

$$\Gamma_{\mathbf{w}} := \{(t_1, \dots, t_{n+1}) \in (\mathbb{C}^*)^{n+1} \mid \mathbf{w}(t_1 x_1, \dots, t_n x_n) = t_{n+1} \mathbf{w}(x_1, \dots, x_n)\}. \quad (1.2)$$

In general,  $\Gamma_{\mathbf{w}}$  contains  $\mathbb{C}^*$  as a subgroup of finite index, and we consider certain *admissible subgroups*  $\mathbb{C}^* \subseteq \Gamma \subseteq \Gamma_{\mathbf{w}}$  (see Definition 2.2.4). Correspondingly, one must consider a group  $\check{\Gamma}$  which acts on the mirror, defined in (2.12).

**Remark 1.1.2.** *In this thesis, we will be careful to write  $\Gamma$  when what we say is valid for any admissible subgroup, and  $\Gamma_{\mathbf{w}}$  when we specifically mean the maximal symmetry group.*

**Conjecture 1.** *Let  $\mathbf{w}$  be an invertible polynomial and  $\Gamma \subseteq \Gamma_{\mathbf{w}}$  an admissible subgroup of the maximal group of symmetries of  $\mathbf{w}$ . Then, there is a quasi-equivalence*

$$\mathrm{mf}(\mathbb{A}^n, \Gamma, \mathbf{w}) \simeq D^{\pi} \mathcal{FS}(\check{\mathbf{w}}, \check{\Gamma})$$

*of pre-triangulated  $A_{\infty}$  categories over  $\mathbb{C}$ .*

Here, the B–model is the category  $\mathrm{mf}(\mathbb{A}^n, \Gamma, \mathbf{w})$  of  $\Gamma$ -equivariant matrix factorisations of  $\mathbf{w} : \mathbb{A}^n \rightarrow \mathbb{A}$ . In the maximally graded case, this is equivalent to considering *graded* matrix factorisations with respect to the maximal grading group for which  $\mathbf{w}$  is homogeneous, namely the abelian group  $L$  freely generated by elements  $\vec{x}_1, \dots, \vec{x}_n$  (the degrees of  $x_1, \dots, x_n$  respectively) and  $\vec{c}$  (the degree of  $\mathbf{w}$ ) modulo the relations

$$\sum_{j=1}^n a_{ij} \vec{x}_j = \vec{c} \quad \text{for all } i. \quad (1.3)$$

The situation where  $\Gamma \subseteq \Gamma_{\mathbf{w}}$  follows by considering graded matrix factorisations with respect to a quotient of  $L$ .

The A–model is the category  $D^{\pi} \mathcal{FS}(\check{\mathbf{w}}, \check{\Gamma})$ , which is the (split-closed, derived) orbifold Fukaya–Seidel category of  $\check{\mathbf{w}} : \mathbb{C}^n \rightarrow \mathbb{C}$ , equivariant with respect to the action of  $\check{\Gamma}$  on the total space. In the maximally graded case, taking the split-closure is not necessary since the (derived) Fukaya–Seidel category has a full exceptional collection; however, this is not known to be true in the orbifold case. It is worth noting that the study of orbifold Fukaya–Seidel categories is still in its infancy, although a definition of a  $\mathbb{Z}_2$ -graded version was given in [CCJ20], which the authors then use to establish the corresponding  $\mathbb{Z}_2$ -graded version of Conjecture 1 in the case of curves. The maximally graded case of Conjecture 1 goes back to [T<sup>+</sup>10] and [Ued06], and there have recently been many results in the direction of establishing it. It has been proven in several cases – in particular, for Brieskorn–Pham polynomials in any number of variables in [FU11], and for Thom–Sebastiani sums of polynomials of type  $A$  and  $D$  in [FU13]. For further discussion and background on Conjecture 1, see [Ebe16], and references therein.

Recall that the *derived category of singularities* of a stack  $X_0$  is defined to be the quotient

$$D_{\text{sing}}^b(X_0) := D^b \text{Coh}(X_0) / \text{perf} X_0$$

of the derived category of coherent sheaves on  $X_0$  by the category of perfect complexes (those complexes quasi-isomorphic to bounded complexes of vector bundles). Buchweitz ([Buc86], cf. Orlov [Orl09, Theorem 39]) showed that when  $X_0$  is a hypersurface in a regular scheme, its singularity category can be expressed in terms of matrix factorisations of the defining equation. This can be extended to stacks [PV11, Proposition 3.19] and in our setting we obtain an equivalence of triangulated categories

$$\text{HMF}(\mathbb{A}^n, \Gamma_{\mathbf{w}}, \mathbf{w}) \rightarrow D_{\text{sing}}^b([\mathbf{w}^{-1}(0)/\Gamma_{\mathbf{w}}]), \quad (1.4)$$

where  $\text{HMF}(\mathbb{A}^n, \Gamma_{\mathbf{w}}, \mathbf{w})$  denotes the homotopy category of  $\text{mf}(\mathbb{A}^n, \Gamma_{\mathbf{w}}, \mathbf{w})$ . Conjecture 1 therefore relates the algebraic geometry of the singularity  $\mathbf{w}$  to the symplectic topology of the singularity  $\check{\mathbf{w}}$ .

On the A–side in the maximally graded case, a famous result of Seidel ([Sei08b, Theorem 18.24]) shows that the Fukaya–Seidel category is generated by Lagrangian thimbles, and so Conjecture 1 implies that the category  $\text{mf}(\mathbb{A}^n, \Gamma_{\mathbf{w}}, \mathbf{w})$  has a full exceptional collection of length  $\mu(\check{\mathbf{w}})$ , the Milnor number of the transpose polynomial. This is proven in [FKK20]. In fact, this collection is conjectured to also be *strong* ([HO18, Conjecture 1.3]), which would imply the following:

**Conjecture 2** ([LU18, Conjecture 1.3]). *Let  $\mathbf{w}$  be an invertible polynomial with maximal symmetry group  $\Gamma_{\mathbf{w}}$ . Then,  $\text{mf}(\mathbb{A}^n, \Gamma_{\mathbf{w}}, \mathbf{w})$  has a tilting object  $\mathcal{E}$ .*

Recall that an object  $\mathcal{E} \in \text{mf}(\mathbb{A}^n, \Gamma_{\mathbf{w}}, \mathbf{w})$  is *tilting* if

- $\text{End}^i(\mathcal{E}) = 0$  for all  $i > 0$ , and
- $\text{hom}^\bullet(\mathcal{E}, X) = 0$  implies  $X \simeq 0$ .



If such a tilting object  $\mathcal{E}$  exists, then it implies that  $\mathrm{mf}(\mathbb{A}^n, \mathbf{w}, \Gamma_{\mathbf{w}}) \simeq D^b(\mathrm{end}(\mathcal{E})^{\mathrm{op}})$ , allowing the computation of the category of matrix factorisations as the category of modules over an algebra. Since the A–model is known to have a tilting object, a common strategy for proving mirror symmetry, and the strategy which we in fact follow, is to prove that the B–model has a tilting object, and then match it with that of the A–model.

The stronger claim that  $\mathrm{mf}(\mathbb{A}^n, \Gamma_{\mathbf{w}}, \mathbf{w})$  has a full, strong, exceptional collection was proven for all chain-type invertible polynomials in [HO18]. It was also proven in [Kra19] for  $n \leq 3$  variables. Moreover, Kravets’ proof is constructive, and should also be adaptable to higher dimensions. It would be interesting to study analogues of Conjecture 2 in the case of non-maximally graded symmetry groups, since in this case it is not known whether the relevant orbifold Fukaya–Seidel category of the mirror pair,  $(\check{\mathbf{w}}, \check{\Gamma})$ , possesses a full exceptional collection.

As well as the homological mirror symmetry statement for the Landau–Ginzburg models  $(\mathbf{w}, \Gamma)$  and  $(\check{\mathbf{w}}, \check{\Gamma})$ , it is natural to study the corresponding mirror symmetry statement for the Milnor fibre of  $\check{\mathbf{w}}$ . In particular, we define

$$\check{V} := \check{\mathbf{w}}^{-1}(1)$$

to be the (completion of) the Milnor fibre of  $\check{\mathbf{w}}$ . This differs from the usual definition of the Milnor fibre, although is equivalent, since all invertible polynomials under consideration are tame (see Lemma 2.2.2) and have only one critical point. On the B–side, the action of  $\Gamma$  is extended to  $\mathbb{A}^{n+1}$  in a prescribed way (see (2.11)). In [LU18], Lekili–Ueda made the following conjecture:

**Conjecture 3** ([LU18, Conjecture 1.4]). *For any pair of invertible polynomials  $\mathbf{w}$ ,  $\check{\mathbf{w}}$ , and admissible subgroup  $\Gamma \subseteq \Gamma_{\mathbf{w}}$  with corresponding dual group  $\check{\Gamma}$ , there is a*

quasi equivalence

$$D^\pi \mathcal{W}([\check{V}/\check{\Gamma}]) \simeq \text{mf}(\mathbb{A}^{n+1}, \Gamma, \mathbf{w} + x_0 x_1 \dots x_n).$$

of  $\mathbb{Z}$ -graded pre-triangulated  $A_\infty$ -categories over  $\mathbb{C}$ .

Here,  $\text{mf}(\mathbb{A}^{n+1}, \Gamma, \mathbf{w} + x_0 x_1 \dots x_n)$  is the dg-category of  $\Gamma$ -equivariant matrix factorisations of  $\mathbf{w} + x_0 \dots x_n$  on  $\mathbb{A}^{n+1}$ . In the maximally graded case, this conjecture was recently established in the case of  $n \geq 3$  for all simple singularities in [LU21], and a  $\mathbb{Z}_2$ -graded equivalence was given for the Milnor fibre of any invertible polynomial in [Gam20]. Recently, a proof of the  $\mathbb{Z}$ -graded version of the conjecture in the maximally graded case was given in [Li21] for Brieskorn–Pham polynomials of the form  $x_1^2 + x_2^2 + x_3^{p_3} + \dots + x_n^{p_n}$ .

In the case of invertible polynomials of log general type, an adaptation of Orlov’s theorem to the present setting gives a quasi-equivalence:

$$\text{mf}(\mathbb{A}^{n+1}, \Gamma, \mathbf{w} + x_0 x_1 \dots x_n) \simeq D^b \text{Coh}(Z_{\mathbf{w}, \Gamma}), \quad (1.5)$$

where

$$Z_{\mathbf{w}, \Gamma} := [(\text{Spec } \mathbb{C}[x_0, x_1, \dots, x_n]/(\mathbf{w} + x_0 x_1 \dots x_n) \setminus (\mathbf{0})) / \Gamma]. \quad (1.6)$$

The generalisation to the case where  $\Gamma$  is a finite extension of  $\mathbb{C}^*$  is straightforward, and the extension to the setting of dg-categories was studied in [Shi12], [Isi10], [CT13]. There is no such equivalence for the log Calabi–Yau and log Fano cases since extending the action of  $\Gamma$  to  $\mathbb{A}^{n+1}$  in these cases doesn’t have strictly positive weights.

It is known that the subcategory  $\text{perf } Z_{\mathbf{w}, \Gamma} \subseteq D^b \text{Coh}(Z_{\mathbf{w}, \Gamma})$  consists precisely of compact objects ([HR17]), since  $Z_{\mathbf{w}, \Gamma}$  is a proper stack with finite stabilisers. On the symplectic side, it is clear that compact Lagrangians yield compact objects in the

category. On the other hand, it is not known in general that the compact objects in the category are *precisely* the compact Lagrangians (cf. [Gan21]); however, this is the case in all known circumstances. In the equivariant setting, morphisms should be given by the  $\check{\Gamma}$ -invariant morphisms of the standard morphisms. Therefore, in the case that the (derived) Fukaya category is precisely the compact objects in the (derived) wrapped Fukaya category, Conjecture 3 in the log general type case would imply an equivalence

$$D^\pi \mathcal{F}([\check{V}/\check{\Gamma}]) \simeq \text{perf} Z_{\mathbf{w}, \Gamma}. \quad (1.7)$$

In the maximally graded case, the first instance of this was given in [LP11b] for  $x_1^3 + x_2^2$ . The equivalence was subsequently established in the cases of  $\mathbf{w} = \sum_{i=1}^n x_i^{n+1}$  and  $\mathbf{w} = x_1^2 + \sum_{i=2}^n x_i^{2n}$ , both for any  $n > 1$ , in [LU18].

## 1.2 Statement of results

Chapter 3 is based on joint work with Jack Smith, [HS20], and we study Conjecture 1 in the maximally graded case. Our main result is:

**Theorem 1** (Theorem 3.1.1). *Conjecture 1 is true in the case of  $\Gamma = \Gamma_{\mathbf{w}}$  and  $n = 2$ .*

As part of the proof, we construct a full exceptional collection on the B–side whose length is  $\mu(\check{\mathbf{w}})$ , and show that the direct sum of these objects is tilting, thus confirming Conjecture 2 in the maximally graded case and  $n = 2$ .

**Theorem 2** (Theorem 3.1.2). *Conjecture 2 is true in the case of  $\Gamma = \Gamma_{\mathbf{w}}$  and  $n = 2$ .*

In Chapter 4, which is based on [Hab], we build on a strategy of Lekili and Ueda in [LU18] to deduce the quasi-equivalence (1.7) in the maximally graded case. Our main result is

**Theorem 1.2.1** (Theorem 4.1.1). *Let  $\mathbf{w}$  be an invertible polynomial in two variables with maximal symmetry group  $\Gamma_{\mathbf{w}}$ , and  $\check{\mathbf{w}}$  its transpose. Then there is a quasi-equivalence*

$$D^\pi \mathcal{F}(\check{V}) \simeq \text{perf } Z_{\mathbf{w}, \Gamma_{\mathbf{w}}}$$

of  $\mathbb{Z}$ -graded pre-triangulated  $A_\infty$ -categories over  $\mathbb{C}$ , where  $Z_{\mathbf{w}, \Gamma_{\mathbf{w}}}$  is as in (1.6),  $\check{V} := \check{\mathbf{w}}^{-1}(1)$  is the Milnor fibre of  $\check{\mathbf{w}}$ , and  $D^\pi \mathcal{F}(\check{V})$  and  $\text{perf } Z_{\mathbf{w}, \Gamma_{\mathbf{w}}}$  are as in Section 1.3.

A key step in the proof Theorem 1.2.1 is to eliminate the potential mirrors by showing that their Hochschild cohomology isn't isomorphic to the symplectic cohomology of the Milnor fibre. In order to do this, the Milnor fibres are reconstructed by an explicit gluing procedure, allowing the symplectic cohomology to be easily computed. These computations suggest a more general pattern of HMS which should include Milnor fibres of invertible polynomials as a special case. In Chapter 5, which is based on [Hab21], we show that this is indeed true, establishing the following theorem:

**Theorem 3** (Theorem 5.1.4). *Let  $\mathbf{w}$  be an invertible polynomial in two variables with admissible symmetry group  $\Gamma \subseteq \Gamma_{\mathbf{w}}$  and corresponding dual group  $\check{\Gamma}$ . Then, the action of  $\check{\Gamma}$  on  $\check{V}$  is free, and there are quasi-equivalences*

$$\begin{aligned} D^\pi \mathcal{F}(\check{V}/\check{\Gamma}) &\simeq \text{perf } Z_{\mathbf{w},\Gamma} \\ D^\pi \mathcal{W}(\check{V}/\check{\Gamma}) &\simeq D^b \text{Coh}(Z_{\mathbf{w},\Gamma}) \end{aligned}$$

of  $\mathbb{Z}$ -graded pre-triangulated  $A_\infty$ -categories over  $\mathbb{C}$ .

**Remark 1.2.2.** *It should be reiterated that, although the quotients of the Milnor fibre by the dual group  $\check{\Gamma}$  should a-priori be a stack, in the case at hand the quotient is a genuine manifold and standard techniques in symplectic geometry can be applied.*

As already mentioned, Theorem 3 is a special case of a more general HMS result, in particular regarding rings and chains<sup>1</sup> of certain Deligne–Mumford stacks, generalising the work of Lekili and Polishchuk [LP17b]. In particular, we consider Deligne–Mumford stacks whose irreducible components meet nodally and are allowed to have a generic stabiliser given by the cyclic group  $\mu_d$ . Additionally, we demand that the underlying orbifold<sup>2</sup> of an irreducible component be a weighted projective line of the form  $\mathbb{P}_{a,b}$ . This is the orbifold whose coarse moduli space is  $\mathbb{P}^1$ , and such that the point 0 has a stabiliser of  $\mu_a$  and  $\infty$  has a stabiliser of  $\mu_b$ . In the case that  $\gcd(a,b) = 1$ , this is  $[(\mathbb{C}^2 \setminus (0,0))/\mathbb{C}^*]$ , where  $\mathbb{C}^*$  acts with weights  $a$  and  $b$  on the coordinates  $x$  and  $y$ , respectively. The case of general  $a$  and  $b$  is discussed in Section 5.2.

In what follows, we let  $\mathbb{P}_{r_{i,-}, r_{i,+}}$  denote the orbifold  $\mathbb{P}^1$  with precisely two distinct orbifold points  $(q_{i,-}, q_{i,+})$  such that  $\text{Aut } q_{i,-} \simeq \mu_{r_{i,-}}$  and  $\text{Aut } q_{i,+} \simeq \mu_{r_{i,+}}$ . Here, the subscript  $\pm$  refers to which end of the orbifold the points  $q_{i,\pm}$  are at; we have that the point  $q_{i,+} \in \mathcal{C}_i$  intersects  $\mathcal{C}_{i+1}$  at  $q_{i+1,-}$ . In the case of a chain of curves,

<sup>1</sup>In this thesis, we will use the word chain to refer to both a cycle of (stacky) projective lines which are in an  $A_n$ -configuration, as well as an invertible polynomial of chain type (whose B-model is in fact a ring of curves). We hope that this distinction is clear from context.

<sup>2</sup>Recall that an orbifold is a Deligne–Mumford stack with trivial generic stabiliser, and that the underlying orbifold results from ‘removing’ the generic stabiliser (cf. Section 5.2).

we also allow  $r_{1,-} = 0$ , or  $r_{n,+} = 0$ , so that the corresponding irreducible component is a (stacky)  $\mathbb{A}^1$ . The irreducible components of the curve are notated as  $\mathcal{C}_i$ , and their generic stabiliser groups as  $\mu_{d_i}$ .

In addition to what the irreducible components are, a crucial piece of information is how the nodes are locally presented. Namely, if  $H_i$  is the isotropy group of the node where the irreducible components  $\mathcal{C}_i$  and  $\mathcal{C}_{i+1}$  meet, then there exists a surjective map  $H_i \rightarrow \mu_{r_{i,+}}$  whose kernel is a torsor for  $\mu_{d_i}$  and a surjective map  $H_i \rightarrow \mu_{r_{i+1,-}}$  whose kernel is a torsor for  $\mu_{d_{i+1}}$ . Rephrased, this says that  $H_i$  is able to be constructed as an extension of  $\mu_{r_{i,+}}$  by  $\mu_{d_i}$  and an extension of  $\mu_{r_{i+1,-}}$  by  $\mu_{d_{i+1}}$ . Note that the extension class is not part of the data – one can only conclude the isomorphism class of the extensions as complexes. The groups  $H_i$  are abelian metacyclic groups.

**Remark 1.2.3.** *It is worth reiterating the subtle difference in terminology here between ‘equivalence of extensions’ and ‘isomorphism of complexes’. The first is the usual notion of equivalence of extension, which requires a chain map between extensions to be the identity on the first and third groups. The second notion is an isomorphism of extensions in the category of chain complexes, meaning that the chain map on the first and third terms must only be an isomorphism. In particular, two extensions of abelian cyclic groups are isomorphic as complexes if and only if the middle term in the extensions are isomorphic. This is clearly a much weaker notion than two extensions being equivalent. Correspondingly, we will take care to be precise in using the terms ‘equivalence of extensions’ and ‘isomorphism of complexes’ in this thesis.*

**Example 1.2.4.** *The group  $\mu_8 \times \mu_2$  can be viewed as a non-trivial extension of  $\mu_4$  by  $\mu_4$ , and as the trivial extension of  $\mu_8$  by  $\mu_2$ . In the former case, there are two inequivalent extensions which yield  $\mu_8 \times \mu_2$ , although both extensions are isomorphic as complexes.*

Given an intersection of  $\mathcal{C}_i$  and  $\mathcal{C}_{i+1}$ , this is modelled locally as the stack quotient of  $\{xy = 0\}$  by  $H_i$ . How the group  $H_i$  acts will be important; it is possible

to have the same intersection point with different actions by  $H_i$  yielding non-derived equivalent categories of  $H_i$ -equivariant sheaves.



**Figure 1.1:** A chain of  $n$  curves. Each irreducible component has generic stabiliser  $\mu_{d_i}$ , and the intersection of  $C_i$  and  $C_{i+1}$  has isotropy group  $H_i$ . An analogous picture can be drawn for a ring of curves by intersecting the first and last irreducible components.

**Example 1.2.5.** For a simple example which captures the key points of the construction, consider

$$\{xy = 0\} \subseteq \mathbb{P}(d_1, d_2, d_3),$$

where  $\gcd(d_1, d_2, d_3) = 1$ . This is a chain of curves with two components. The component  $C_1 = \{x = 0\}$  has generic stabiliser  $\gcd(d_2, d_3)$ , whilst the curve  $C_2 = \{y = 0\}$  has generic stabiliser  $\gcd(d_1, d_3)$ . The node  $|C_1| \cap |C_2| = [0 : 0 : 1]$  is presented as the quotient of  $\{xy = 0\}$  by  $\mu_{d_3}$  acting as

$$t \cdot (x, y) = (t^{d_1}x, t^{d_2}y).$$

In general, one does not need to present the curves as being hypersurfaces in a weighted projective plane, and can consider the intersection of two abstract curves. To get a chain of curves with more components, we intersect the point at infinity of  $C_2$  with the zero of another curve,  $C_3$ , and similarly with  $C_4$  etc. To get a ring of curves, we close up a chain by intersecting  $C_1$  with  $C_n$ .

**Theorem 4.** [Theorem 5.1.1] Let  $\mathcal{C}$  be a Deligne–Mumford stack such that:

- The coarse moduli space of  $\mathcal{C}$  is a ring or chain of  $n$   $\mathbb{P}^1$ 's.
- Each irreducible component,  $C_i$ , has underlying orbifold  $\mathbb{P}_{r_{i,-}, r_{i,+}}$  and generic stabiliser  $\mu_{d_i}$  such that  $r_{i,+}d_i = r_{i+1,-}d_{i+1}$  (we allow  $r_{1,-}$  and/ or  $r_{n,+} = 0$  in the case of a chain of curves).

- The node  $q_i := |\mathcal{C}_i| \cap |\mathcal{C}_{i+1}|$  has isotropy group  $H_i$ , an abelian metacyclic group, and is presented as the quotient of  $\text{Spec } \mathbb{C}[x, y]/(xy)$  by  $H_i$ , where the action is given by

$$h \cdot (x, y) = (\psi_{i,+}(h)x, \psi_{i+1,-}(h)y)$$

for some surjective  $\psi_{i,+} : H_i \rightarrow \mu_{r_{i,+}}$  and  $\psi_{i+1,-} : H_i \rightarrow \mu_{r_{i+1,-}}$ .

Then

$$D^b(\mathcal{A}_{\mathcal{C}} - \text{mod}) \simeq D^b\mathcal{W}(\Sigma; \Lambda)$$

is a  $\mathbb{Z}$ -graded quasi-equivalence of pre-triangulated  $A_\infty$ -categories over  $\mathbb{C}$ , where  $\Sigma$  is a  $\mathbb{Z}$ -graded,  $b$ -times punctured surface of genus  $g$  such that the genus, boundary components, and collection of stops,  $\Lambda \subseteq \partial\Sigma$ , are determined by the  $r_{i,\pm}$ ,  $d_i$ , and the local presentation of the nodes as the quotient by  $H_i$ .

In the above,  $D^b(\mathcal{A}_{\mathcal{C}} - \text{mod})$  is the bounded derived category of (left) modules of a certain sheaf of non-commutative  $\mathcal{O}_{\mathcal{C}}$ -algebras, first introduced in [BD09], and  $D^b\mathcal{W}(\Sigma; \Lambda)$  is the derived partially wrapped Fukaya category with respect to the collection of stops  $\Lambda \subseteq \partial\Sigma$  ([Aur10], [Syl16]). As part of the proof of this theorem, we show that  $\text{Tw } \mathcal{W}(\Sigma; \Lambda)$  has a full, strong, exceptional collection, so is automatically split-closed ([Sei08b, Remark 5.14]).

The category  $D^b(\mathcal{A}_{\mathcal{C}} - \text{mod})$  (resp.  $D^b\mathcal{W}(\Sigma; \Lambda)$ ) admits a functor to  $D^b\text{Coh}(\mathcal{C})$  (resp.  $D^\pi\mathcal{W}(\Sigma)$ ) which is given by localising at a certain full subcategory. We show that these categories are identified with each other under the equivalence of Theorem 4. By localising on both sides and also characterising the inclusion of  $\text{perf } \mathcal{C}$  in  $D^b(\mathcal{A}_{\mathcal{C}} - \text{mod})$  (resp.  $D^\pi\mathcal{F}(\Sigma)$  in  $D^b\mathcal{W}(\Sigma; \Lambda)$ ) we find:



**Theorem 5.** [Theorem 5.1.3] *Let  $\mathcal{C}$  and  $\Sigma$  be as in Theorem 4. Then*

$$\begin{aligned} \mathrm{perf}\mathcal{C} &\simeq D^\pi \mathcal{F}(\Sigma) \\ D^b \mathrm{Coh}\mathcal{C} &\simeq D^\pi \mathcal{W}(\Sigma), \end{aligned}$$

*are quasi-equivalences of  $\mathbb{Z}$ -graded pre-triangulated  $A_\infty$ -categories over  $\mathbb{C}$  in the case of a ring of curves. In the case of a chain of curves, there are quasi-equivalences of  $\mathbb{Z}$ -graded pre-triangulated  $A_\infty$ -categories over  $\mathbb{C}$*

$$\begin{aligned} \mathrm{perf}_c \mathcal{C} &\simeq D^\pi \mathcal{F}(\Sigma; (r_{1,-})^{d_1}, (0)^{b-d_1-d_n}, (r_{n,+})^{d_n}) \\ D^b \mathrm{Coh}(\mathcal{C}) &\simeq D^\pi \mathcal{W}(\Sigma; (r_{1,-})^{d_1}, (0)^{b-d_1-d_n}, (r_{n,+})^{d_n}), \end{aligned}$$

*where  $\mathrm{perf}_c \mathcal{C}$  is the full subcategory of  $\mathrm{perf}\mathcal{C}$  consisting of objects with proper support.*

In the above,  $D^\pi \mathcal{F}(\Sigma; (r_{1,-})^{d_1}, (0)^{b-d_1-d_n}, (r_{n,+})^{d_n})$  is the (derived) *infinitesimally wrapped Fukaya category* ([NZ06], cf. [GPS18]). To reiterate, the motivation for studying the curves appearing in Theorems 4 and 5 is that this class of curves includes the B–models of invertible polynomials in two variables. It is then a consequence of these theorems which establishes the remaining cases of Theorem 3 not covered in Chapter 4.

As a corollary of our main theorems, we establish derived equivalences between certain curves appearing in the B–model of Conjecture 3.

**Corollary 1.** [Corollary 5.1.5] *For each  $n \geq 1$  and  $q \geq 2$ , let  $\mathbf{w}_{\mathrm{loop}} = x^{n(q-1)+1}y + y^q x$  and  $\mathbf{w}_{\mathrm{chain}} = x^{nq+1}y + y^q$ , each with the maximal symmetry group. We then have quasi-equivalences*

$$D^b \mathrm{Coh}(Z_{\mathbf{w}_{\mathrm{loop}}}) \simeq D^b \mathrm{Coh}(Z_{\mathbf{w}_{\mathrm{chain}}})$$

*of  $\mathbb{Z}$ -graded pre-triangulated  $A_\infty$ -categories over  $\mathbb{C}$ .*

Similarly, for each  $n \geq 1$  and  $p \geq 2$ , or  $n \geq p = 2$ , let  $\mathbf{w}'_{\text{chain}} = x^p y + y^{n(p-1)}$ ,  $\mathbf{w}_{\text{BP}} = x^p + y^{np}$ , each with the maximal symmetry group. We then have quasi-equivalences

$$D^b \text{Coh}(Z_{\mathbf{w}'_{\text{chain}}}) \simeq D^b \text{Coh}(Z_{\mathbf{w}_{\text{BP}}})$$

of  $\mathbb{Z}$ -graded pre-triangulated  $A_\infty$ -categories over  $\mathbb{C}$ .

This corollary was previously proven in [FK19, Corollary 5.15] using purely algebro-geometric means. Our proof is obtained by first showing that the Milnor fibres corresponding to the relevant Berglund–Hübsch transposes are graded symplectomorphic, implying that their Fukaya categories are quasi-equivalent. By Theorem 3, this proves that the derived categories of sheaves of their mirrors are too.

### 1.3 Conventions

We work over  $\mathbb{C}$  throughout. For a two dimensional Liouville manifold  $\Sigma$  with stops on the boundary  $\Lambda \subseteq \partial\Sigma$ , we refer to the split-closed derived Fukaya, wrapped Fukaya, and partially wrapped Fukaya categories as  $D^\pi \mathcal{F}(\Sigma)$  and  $D^\pi \mathcal{W}(\Sigma)$ , and  $D^\pi \mathcal{W}(\Sigma; \Lambda)$ , respectively. We refer to the derived Fukaya–Seidel category of  $\check{\mathbf{w}} : \mathbb{C}^n \rightarrow \mathbb{C}$  as  $D^b \mathcal{FS}(\check{\mathbf{w}})$ . For a Deligne–Mumford (DM) stack  $\mathcal{X}$  we write  $x \in \mathcal{X}$  to mean  $x : \text{Spec } \mathbb{C} \rightarrow \mathcal{X}$ , and let  $|\mathcal{X}|$  be its underlying topological space. We denote the bounded derived category of coherent sheaves, its full subcategory of perfect complexes, considered as pretriangulated dg-categories, as  $D^b \text{Coh}(\mathcal{X})$  and  $\text{perf } \mathcal{X}$ , respectively. We refer to a DM stack with trivial generic stabiliser as an orbifold. For a sheaf of algebras  $\mathcal{A}$ , we denote the bounded derived category of finitely generated left modules, considered as a pretriangulated dg-category, as  $D^b(\mathcal{A} - \text{mod})$ . By  $\mathbb{Z}_n$  we mean  $\mathbb{Z}/n\mathbb{Z}$ , and by  $\mathbb{Z}_{(2)}$  we mean the local ring of rational numbers with odd denominator. All (co)homology groups are assumed to have coefficients in  $\mathbb{Z}$  unless otherwise specified.

## Chapter 2

# Preliminaries

In this chapter, we briefly review the relevant material on the various flavours of Fukaya categories which will be needed, as well as the background material on invertible polynomials. Everything in this chapter is well-known – comprehensive references for the symplectic geometry are [CE12], [Sei08b], [AS07], [Aur10], and [Syl16], and references for invertible polynomials include [Kra10], [LU18], and [T<sup>+</sup>10].

In this thesis, all of the Fukaya categories we consider will not have orbifold structures, and so we do not review the background of the various orbifold Fukaya(–Seidel) categories. The interested reader can find a definition of an orbifold Fukaya category in [Sei11] for the case of curves, and the definition of the wrapped Fukaya category of an orbifold is given in [CCJ20, Definition 4.7]. Building on this, the authors of [CCJ20] give a definition of an orbifold Fukaya–Seidel category ([CCJ20, Theorem 4.14 and Definition 4.15]), and conjecture ([CCJ20, Conjecture 5.6]) that it agrees with the standard definition of the Fukaya–Seidel category which is outlined here in the case that the quotient group is trivial.

### 2.1 Symplectic preliminaries

We begin this section by introducing the categories arising in symplectic geometry which will be of most interest in this thesis. We first introduce the various Fukaya

categories which are associated to Liouville manifolds before reviewing some Picard–Lefschetz theory and the Fukaya–Seidel category.

### 2.1.1 Fukaya categories of exact symplectic manifolds

Throughout this thesis, the symplectic manifolds of interest will be examples of *Liouville manifolds*, which are, in particular, exact. We therefore restrict ourselves to this case in our exposition of Fukaya categories and do not discuss some of the subtleties which are relevant in the non-exact setting. Moreover, we will not discuss technical issues in detail which arise in Floer theory such as, for example, transversality and compactness issues, relative gradings, or the orientations of moduli spaces. For a complete and detailed construction of Floer theory, as well as a comprehensive account of the relevant homological algebra, we refer to the book [Sei08b]. A very nice and accessible introduction to the subject can be found at [Aur14].

#### 2.1.1.1 Liouville manifolds

As already mentioned, all of the manifolds which will be considered in this thesis are examples of Liouville manifolds. The topology and geometry of these manifolds is of great interest in all areas of symplectic topology, and we refer to [CE12] for a detailed account. To begin with, we define a *Liouville domain* to be a pair,  $(\overline{M}, \lambda)$ , such that

1.  $\overline{M}$  is a compact  $2n$ -dimensional manifold with contact boundary,
2.  $\lambda$  is a one-form such that  $d\lambda = \omega$  is a symplectic form for  $\overline{M}$  and  $\lambda|_{\partial\overline{M}} = \alpha$  is a contact form on  $\partial\overline{M}$ , where the orientation defined by  $\alpha \wedge d\alpha^{n-1}$  agrees with the orientation as the boundary of  $\overline{M}$ . The one-form  $\lambda$  is called the *Liouville form*.

To each Liouville domain there is a vector field  $X$  defined as the  $\omega$ -dual to  $\lambda$ , meaning the vector field  $X$  such that

$$\iota_X \omega = \lambda.$$

Moreover, this vector field intersects  $\partial\overline{M}$  transversally and points outwards. We define a *Liouville manifold* as the completion of the Liouville domain by attaching cylindrical ends, i.e.

$$M = \overline{M} \cup_{\partial\overline{M}} (\partial\overline{M} \times [1, \infty)),$$

and extend the Liouville form  $\lambda$  to the attached ends by defining it to be  $e^r(\lambda|_{\partial\overline{M}})$ , where  $r$  is the coordinate on  $[1, \infty)$ . The two notions of Liouville domain and manifold are intimately linked, and we will frequently pass between the two.

A compact exact Lagrangian submanifold of a Liouville manifold  $L \subseteq M$  is a Lagrangian submanifold such that the Liouville form has a primitive when restricted to  $L$ , i.e.  $\lambda|_L = df$  for some  $f \in C^\infty(L)$ . In this thesis, we will never consider Lagrangians which are not exact. As explained in, for example, [Aur14, Remark 1.7], exactness will allow us to avoid the necessity of working over a Novikov field when constructing Floer complexes and work directly over the complex numbers instead.

A key piece of additional data on a symplectic manifold is a *grading* [Sei00], [Sei08b, Section 11j]. The important point is that a symplectic manifold  $(M, \omega)$  is gradable if and only if  $2c_1(M) = 0$ , and a grading is a choice of trivialisation of  $K_M^{\otimes -2}$ . Choosing a grading defines a lift of the Lagrangian Grassmannian bundle over  $M$ ,  $\text{LGr}(TM)$ , to its fibrewise universal cover  $\widetilde{\text{LGr}}(TM)$ . Given a grading on  $M$ , we say that a Lagrangian is graded if the natural map

$$\begin{aligned} L &\rightarrow \text{LGr}(TM) \\ x &\mapsto T_x L \end{aligned}$$

lifts to  $\widetilde{\text{LGr}}(TM)$ . Given a (transverse) intersection point  $p \in L_1 \pitchfork L_2$ , one can then define  $\deg p$  as the winding number of a path in  $\text{LGr}(T_p M)$  connecting  $T_p L_1$  to  $T_p L_2$  determined by the lifts of the respective tangent spaces to  $\widetilde{\text{LGr}}(T_p M)$ . We discuss

the issue of grading in more detail in Section 3.3.7 and 4.3.1, focusing on the case at hand of symplectic surfaces. The take-home message is that grading Lagrangians will allow one to give the Floer complex a  $\mathbb{Z}$ -grading.

**Remark 2.1.1.** *It should be emphasised that computing the degree of a point  $p \in L_1 \pitchfork L_2$  is not the same as computing the degree of the same point, considered as an intersection  $L_2 \pitchfork L_1$ . Indeed, if  $p \in L_1 \pitchfork L_2$  has degree  $i$ , then  $p \in L_2 \pitchfork L_1$  has degree  $n - i$  for  $n = \dim_{\mathbb{R}} L$ .*

### 2.1.1.2 Fukaya categories of compact Lagrangians

Given a graded Liouville manifold, one of the central objects of study is the *Floer complex*, which is a differential graded algebra associated to the intersection of two graded, exact, Lagrangians  $L_i$  equipped additionally with spin structures and flat complex line bundles  $\mathcal{L}_i \rightarrow L_i$  with unitary holonomy (i.e. rank one unitary local systems). We call such a tuple of data a *Lagrangian brane*. The inclusion of a local system as part of the data is not always necessary, depending on the applications one has in mind; however, this enriched version will be necessary when one considers mirror symmetry. Assuming transversality of intersections, we define a  $\mathbb{Z}$ -graded vector space as

$$\mathrm{CF}^i(L_1, L_2) = \bigoplus_{p \in L_1 \pitchfork L_2} \mathrm{hom}^{i - \deg p}(\mathcal{L}_1|_p, \mathcal{L}_2|_p),$$

and take  $\mathrm{CF}^\bullet(L_1, L_2)$  to be the direct sum of these graded pieces. One of the features of Floer theory is that it is invariant under Hamiltonian isotopy, meaning isotopies induced from the flow of a Hamiltonian vector field. This provides us with a method of circumventing transversality issues in the case where  $L_1 \cap L_2$  is not transverse. Namely, one can Hamiltonian isotope  $L_1$  by considering the image under the time one flow of  $H$ , denoted by  $\phi_H^1$ , such that it intersects  $L_2$  transversally. We then define the Floer complex as being the sum over the intersection points of  $\phi_H^1(L_1) \pitchfork L_2$ .

It is a remarkable property of Floer theory that the Floer cochain complexes

come with maps<sup>3</sup>

$$\mu_n : \mathrm{CF}^\bullet(L_{n-1}, L_n) \otimes \mathrm{CF}^\bullet(L_{n-2}, L_{n-1}) \otimes \cdots \otimes \mathrm{CF}^\bullet(L_0, L_1) \rightarrow \mathrm{CF}^\bullet(L_0, L_n)[2-n], \quad (2.1)$$

which satisfy the  $A_\infty$ -equations [Sei08b, Equation 1.2]. This was initially proven by Fukaya in [Fuk93], resulting in the  $A_\infty$ -category whose objects are Lagrangian branes and morphisms are Floer cochain complexes bearing his name.

To define these maps, equip  $M$  with an  $\omega$ -compatible<sup>4</sup> almost complex structure  $J$ , let  $D_{n+1}$  be the disc with the  $n+1$  cyclically ordered points  $\xi_0, \dots, \xi_n$  removed, and suppose  $p_i \in L_{i-1} \pitchfork L_i$  for  $i = 1, \dots, n$  and  $q \in L_0 \pitchfork L_n$ . Roughly speaking, parallel transport along the boundary of the disc, together with the elements  $\mathrm{hom}(\mathcal{L}_{i-1}|_{p_i}, \mathcal{L}_i|_{p_i})$  corresponding to  $L_{i-1} \pitchfork L_i$ , determines an element in  $\mathrm{hom}(\mathcal{L}_0|_q, \mathcal{L}_n|_q)$  whose coefficient in  $\mu_n(p_1, \dots, p_n)$  is the signed count of rigid  $J$ -holomorphic<sup>5</sup> discs such that the puncture at  $\xi_i$  for  $1 \leq i \leq n$  is mapped to  $p_i$ , the puncture at  $\xi_0$  is mapped to  $q$ , and the boundary between  $\xi_i$  and  $\xi_{i+1}$  is mapped to  $L_i$ . The brane structure determines the sign of this count. Of course, there are numerous transversality and compactness issues which need to be addressed, although we defer to [Sei08b, Chapter 12] for the details when local systems are not included; the case where local systems are included follows by the same arguments by keeping track of twisting by the contributions from the line bundles.

Of particular note is that the first  $A_\infty$ -equation states that  $\mu_1$  is a degree one map such that  $\mu_1 \circ \mu_1 = 0$ , i.e. is a differential. With this, one can define the Floer

---

<sup>3</sup>Composition is done right-to-left.

<sup>4</sup>Recall  $\omega$ -compatible means that  $\omega(\cdot, J\cdot)$  is a Riemannian metric, such an almost complex structure always exists, and that the space of  $\omega$ -compatible almost complex structures is non-empty and contractible [MS98, Section 4.1].

<sup>5</sup>A disc  $u : D_{n+1} \rightarrow M$  is  $J$ -holomorphic if it satisfies Floer's equation (for example, [Sei08b, Equation 8.9]).

cohomology groups

$$\mathrm{HF}^\bullet(L_1, L_2) = \mathrm{H}^\bullet(\mathrm{CF}^\bullet(L_1, L_2), \mu_1).$$

Related to Remark 2.1.1, there is a natural Poincaré duality isomorphism

$$\mathrm{HF}^i(L_1, L_2) \simeq \mathrm{HF}^{n-i}(L_2, L_1)^\vee, \quad (2.2)$$

induced by the non-degenerate pairing

$$\mathrm{HF}^{n-i}(L_2, L_1) \otimes \mathrm{HF}^i(L_1, L_2) \rightarrow \mathrm{HF}^n(L_1, L_1) \simeq \mathrm{H}^n(L_1; \mathbb{C}) \simeq \mathbb{C}.$$

We are now in a position to define the Fukaya category. For  $(M, \lambda)$  a Liouville manifold, the Fukaya category of compact Lagrangian branes, denoted by  $\mathcal{F}(M)$  is as follows:

- The objects of  $\mathcal{F}(M)$  are compact Lagrangian branes.
- The morphisms are defined as

$$\mathrm{hom}_{\mathcal{F}(M)}(L_i, L_j) := \mathrm{CF}^\bullet(L_i, L_j).$$

This is an  $A_\infty$ -category with structure maps given by (2.1).

The main invariant we will be interested in will be the *derived* Fukaya category, which we define to be the pretriangulated<sup>6</sup>  $A_\infty$ -category over  $\mathbb{C}$

$$D^\pi \mathcal{F}(M) := \mathrm{Tw}^\pi \mathcal{F}(M).$$

Here  $\mathrm{Tw}^\pi \mathcal{F}(M)$  is the split-closure<sup>7</sup> of the category of twisted complexes of  $\mathcal{F}(M)$  ([Sei08b, Chapter 3I]), which is its split-closed pretriangulated envelope.

---

<sup>6</sup>Recall that a category is pretriangulated if its homotopy category is canonically triangulated.

<sup>7</sup>Recall that a category is split-closed if it contains all images of idempotent endomorphisms. The split closure is a formal enlargement to include such objects, and always exists for an  $A_\infty$ -category [Sei08b, Lemma 4.7].



- Remark 2.1.2.** • *We should reiterate that all derived categories considered in this thesis will be the appropriate  $A_\infty$ - or, equivalently, dg-enhancements. Some authors (for example, in [Kon95] and [PZ98]) define the derived Fukaya category as  $H^0(\mathrm{Tw}^\pi \mathcal{F}(M))$ , yielding a triangulated category in the classical sense; however, it is more common in modern approaches to homological mirror symmetry to work with pretriangulated, rather than triangulated, categories. Such categories are also referred to as ‘triangulated  $A_\infty$ -categories’ (for example, in [Sei08b] and [She15]). Either way, the point is that the  $A_\infty$ -structure of the category is crucial information, and this is not remembered when passing to the homotopy category.*
- *There are certain circumstances where the category of twisted complexes of a Fukaya category is already split-closed, such as when the category has a full exceptional collection ([Sei08b, Remark 5.14]). For an  $A_\infty$ -category  $\mathcal{A}$  such that  $\mathrm{Tw} \mathcal{A}$  is already split closed, taking the split closure does nothing. Therefore, there is no harm in defining the  $D^\pi(\mathcal{A})$  as  $\mathrm{Tw}^\pi \mathcal{A}$  and including the cases when  $\mathrm{Tw} \mathcal{A}$  is already split-closed in this definition. We will, however, write  $D^b(\mathcal{A}) = \mathrm{Tw} \mathcal{A}$  when we work with a specific category which is known to be split closed (for example, when  $\mathrm{Tw} \mathcal{A}$  has a full exceptional collection).*

### 2.1.1.3 Wrapped Fukaya categories

The second flavour of Fukaya category we will be interested in is the *wrapped Fukaya category*, as introduced in [AS07], which is denoted by  $\mathcal{W}(M)$ . It contains  $\mathcal{F}(M)$  as a full subcategory, as well as non-compact admissible Lagrangian branes, which we define below.

We call a non-compact, orientated, exact Lagrangian  $L \subseteq M$  *admissible* if  $L$  coincides with  $(1, \infty) \times \partial L$  on the non-compact ends of  $M$  for  $\partial L \subseteq \partial \overline{M}$  a Legendrian submanifold. A brane structure on an admissible Lagrangian is the additional data of a grading and spin structure. There is a generalisation due to Abouzaid ([Abo10]) which equips non-compact Lagrangian branes with local systems. Strictly

speaking, this is the version of the wrapped Fukaya category which we make use of; however, since all non-compact Lagrangians which we consider in this thesis will be simply connected, any local system on it must be trivial, and wrapped Floer theory reduces to the case of [AS07]. We will therefore not notate the local systems on the non-compact Lagrangians, although note that they are present in the computation of the Floer cochain complexes associated to intersection points contained entirely in the interior of  $\overline{M}$ .

As already noted, one is free to do Floer theory up to Hamiltonian isotopy. In the case of wrapped Floer cochain complexes, the Hamiltonian vector fields whose flow yields the desired isotopy must be of a specific form in order to obtain the required a-priori bounds on  $J$ -holomorphic curves required for Floer theory. Namely, outside of a compact set, the Hamiltonian must be of the form

$$H = r^2,$$

where  $r$  is again the coordinate on  $[1, \infty)$  of the cylindrical end of the Liouville manifold. In particular, the corresponding Hamiltonian vector field must be

$$X_H = 2R_\alpha.$$

where, as before,  $\alpha = \lambda|_{\partial\overline{M}}$  is the contact form on  $\partial\overline{M}$  and  $R_\alpha$  is its Reeb vector field.

Let  $L_1, L_2$  be non-compact Lagrangian branes and  $\mathfrak{X}(L_1, L_2)$  the set of time one Hamiltonian flow lines of  $H$  which start on  $L_1$  and end on  $L_2$ . Analogously to the case of grading geometric intersection points, grading the Lagrangians  $L_1$  and  $L_2$  determines a degree for each  $x \in \mathfrak{X}(L_1, L_2)$ . The set  $\mathfrak{X}(L_1, L_2)$  is equivalent to the number of geometric intersection points of  $\varphi_H^1(L_0) \cap L_1$ , where  $\varphi_H^1$  is the time one flow associated to  $X_H$ . Rephrasing, this is the number of (perturbed by  $H$ ) intersection points of  $L_0$  and  $L_1$  which are contained in  $\overline{M}$ , together with Reeb chords of arbitrary length between  $\partial L_0$  and  $\partial L_1$  in  $\partial\overline{M}$ . It is this latter perspective

which we will find most useful – in practice, we will compute morphisms between non-compact Lagrangians in a Liouville manifold by counting the number of Reeb chords<sup>8</sup> of arbitrary length between their respective boundaries in the boundary of the Liouville domain, as well as any geometric intersection points in the interior.

As a vector space, the wrapped Floer cochain complex for  $L_1, L_2$  non-compact admissible Lagrangians is defined as

$$\mathrm{CW}^i(L_1, L_2) = \bigoplus_{\substack{x \in \mathfrak{X}(L_1, L_2) \\ \deg x = i}} \mathbb{C} \cdot x.$$

The construction of the  $A_\infty$  structure maps in the wrapped case is heuristically analogous to the structure maps for compact Lagrangians. Namely, they are defined by counts of rigid  $J$ -holomorphic discs with prescribed boundary conditions; however, we refer to [AS07] for the details of the construction. The case of morphisms between a compact and non-compact Lagrangian is computed entirely within  $\overline{M}$ , as in the case of the intersection of two compact Lagrangians.

The wrapped Fukaya category  $\mathcal{W}(M)$  is defined as

- The objects are
  - The compact Lagrangian branes as in the Fukaya category of compact objects, and
  - The non-compact admissible Lagrangian branes
- The morphisms are

$$\mathrm{hom}_{\mathcal{W}(M)}(L_1, L_2) = \begin{cases} \mathrm{CW}^\bullet(L_1, L_2) & \text{if both } L_i \text{ are non-compact, and} \\ \mathrm{CF}^\bullet(L_1, L_2) & \text{if at least one } L_i \text{ is compact.} \end{cases}$$

---

<sup>8</sup>We assume that Reeb chords between  $\partial L_0$  and  $\partial L_1$  are non-degenerate, otherwise one must perturb the Hamiltonian  $H$  to achieve this. This is analogous to perturbing intersections by a Hamiltonian to achieve transversality in the Floer theory of compact Lagrangians.

As in the case of the Fukaya category of compact objects, our primary interest will be in the derived wrapped Fukaya category, where we define

$$D^\pi \mathcal{W}(M) := \mathrm{Tw}^\pi \mathcal{W}(M).$$

#### 2.1.1.4 Partially wrapped Fukaya categories

The final flavour of Fukaya category which will be important to us is the *partially wrapped Fukaya category*. This category was originally introduced by Auroux [Aur10], and studied in generality by [Syl16]. We restrict ourselves to the case of surfaces with boundary here, which not only simplifies the exposition, but it is also the only case which will be relevant to us in this thesis.

Let  $(\Sigma, \lambda)$  be a two dimensional Liouville domain, i.e. a compact surface with boundary such that each boundary component is diffeomorphic to  $S^1$ . Let  $\Lambda \subseteq \partial\Sigma$  be a collection of stops on the boundary, which is simply a collection of points in this case. Then, the *partially wrapped Fukaya category*,  $\mathcal{W}(\Sigma; \Lambda)$  is defined as follows:

- $\mathrm{Ob} \mathcal{W}(\Sigma; \Lambda) = \mathrm{Ob} \mathcal{W}(\Sigma)$
- The morphisms  $\mathrm{hom}_{\mathcal{W}(\Sigma; \Lambda)}(L_1, L_2)$  are the same as in the wrapped Fukaya category, but where Reeb chords from  $\partial L_1$  to  $\partial L_2$  which pass through a stop are disallowed.

It is the fact that Reeb chords which pass through stops in the boundary are disallowed which leads to the name ‘partially’ wrapped Fukaya category (and also the name ‘stop’); indeed, one can recover the wrapped Fukaya category as the partially wrapped Fukaya category with  $\Lambda = \emptyset$ . Moreover, by including enough stops, all morphism spaces must be cohomologically finite, meaning, by definition, that the category is proper.

We define the derived partially wrapped Fukaya category as

$$D^\pi \mathcal{W}(\Sigma; \Lambda) := \text{Tw}^\pi \mathcal{W}(\Sigma; \Lambda).$$

This is an extremely useful intermediate category between the Fukaya category of compact Lagrangians and the wrapped Fukaya category. In particular, the former category is proper, but does not contain enough objects to be homologically smooth<sup>9</sup>. The latter category, on the other hand, is homologically smooth ([Gan12]), but not proper.

Given a collection of stops  $\Lambda' \subseteq \Lambda$ , there is a stop-removal functor

$$D^\pi \mathcal{W}(\Sigma; \Lambda) \rightarrow D^\pi \mathcal{W}(\Sigma; \Lambda')$$

which is given by localising at Lagrangians supported near the stops ([Syl16, Theorem 4.21] in generality, and [HKK14, Proposition 3.6] for the case of surfaces). In particular, this gives a functor to the (derived) wrapped Fukaya category of  $\Sigma$ .

A powerful theorem due to Haiden, Kontsevich, and Katzarkov ([HKK14]) is that, for a surface, one can always choose a collection of stops  $\Lambda$  such that there exists a generator  $\bigoplus_i L_i$  of  $D^b \mathcal{W}(\Sigma; \Lambda)$  whose endomorphism algebra

$$A := \text{end}\left(\bigoplus_i L_i\right)$$

is *formal*, meaning that all  $A_\infty$ -structure maps are zero except for  $\mu_2$  (which is the product on the algebra). Moreover, it is shown in [HKK14, Corollary 3.1] that the resulting category  $D^b(A^{\text{op}}) \simeq D^b \mathcal{W}(\Sigma; \Lambda)$  is smooth and proper. This reduces the study of derived partially wrapped Fukaya categories to categories of modules over an algebra. Moreover, it means that the derived partially wrapped Fukaya category is a *categorical resolution* of the derived Fukaya category of compact Lagrangians,

---

<sup>9</sup>Recall a category is homologically smooth if it is perfect as a bimodule over itself.

where the functor

$$D^\pi \mathcal{F}(\Sigma) \rightarrow D^b \mathcal{W}(\Sigma; \Lambda) \simeq D^b(A^{\text{op}})$$

is induced from the inclusion on objects.

Combining localisation with the fact that one can find a collection of stops and generating collection such that  $D^b(A^{\text{op}}) \simeq D^b \mathcal{W}(\Sigma; \Lambda)$  gives a functor

$$D^b(A^{\text{op}}) \rightarrow D^\pi \mathcal{W}(\Sigma),$$

which can be used to understand the more complicated derived wrapped Fukaya category.

We end this subsection with the comment that, although our discussion of partially wrapped Fukaya categories was restricted to case of surfaces for convenience, and because this is the relevant case for us, the theorem of Haiden, Katzarkov, and Kontsevich is specific to this dimension. An analogous theorem in higher dimensions would be an extremely useful tool.

### 2.1.2 Background on Picard–Lefschetz theory

We begin this subsection by studying some topological properties of polynomial maps  $f : \mathbb{C}^n \rightarrow \mathbb{C}$  by first introducing the notion of the *Milnor fibre* of a singularity. This is closely related to the notion of a *Lefschetz fibration*, which is the central object of study in Picard–Lefschetz theory. Roughly speaking, the Milnor fibre records how a singularity degenerates, and Picard–Lefschetz theory can be viewed as a complex analogue of Morse theory. Our main references for the classical treatment of Picard–Lefschetz theory are [AIG<sup>+</sup>98] and [Mil68]. As in the case of Fukaya categories of Liouville manifolds, a detailed treatment of Picard–Lefschetz theory can be found in [Sei08b].

**Definition 2.1.3** ([AIG<sup>+</sup>98, Chapter 1.4]). *Let  $[f] \in \mathbb{C}[[x_1, \dots, x_n]]$  be the germ at*

the origin of a non-constant polynomial  $f : \mathbb{C}^n \rightarrow \mathbb{C}$  such that  $df|_0 = 0$ . We define the Jacobian of  $[f]$  as

$$Jac_{[f]} := \mathbb{C}[[x_1, \dots, x_n]] / \langle \partial_{x_1} f, \dots, \partial_{x_n} f \rangle,$$

and the Milnor number as

$$\mu([f]) := \dim_{\mathbb{C}} Jac_{[f]}.$$

We say that  $f$  has an isolated hypersurface singularity at the origin if  $\mu([f]) < \infty$ .

**Remark 2.1.4.** *i) The above definition of Jacobian and Milnor number is independent of the representative of germ ([AIG<sup>+</sup>98, Chapter 1.4]). Moreover, in the case when the only critical point of  $f : \mathbb{C}^n \rightarrow \mathbb{C}$  is at the origin, it is not necessary to complete the Jacobian algebra before computing its dimension, so we write  $\mu(f)$  for its Milnor number. By an abuse of notation, we will refer to the polynomial  $f$  as having an isolated hypersurface singularity, rather than the equivalence class of germ at the origin which it defines.*

*ii) The above definition can be extended to general holomorphic functions ([AIG<sup>+</sup>98, Chapter 1]); however, the case of polynomials will suffice for us.*

**Theorem 2.1.5** ([Mil68, Theorem 4.8]). *Let  $f : \mathbb{C}^n \rightarrow \mathbb{C}$  have an isolated hypersurface singularity at the origin. Then, there exists  $\varepsilon_0 > 0$  such that*

$$S_\varepsilon(0) \pitchfork f^{-1}(0)$$

*for any  $\varepsilon < \varepsilon_0$ , where  $S_\varepsilon(0)$  is the sphere of radius  $\varepsilon$  centred at the origin, and that there is a smooth fibration*

$$\begin{aligned} \varphi : S_\varepsilon(0) \setminus f^{-1}(0) &\rightarrow S^1 \\ x &\longmapsto \frac{f(x)}{|f(x)|}. \end{aligned}$$

*Moreover, the smooth fibre of this mapping is independent of  $\varepsilon$  and  $\varepsilon_0$ .*

The smooth fibre of this fibration, denoted by  $V_f$ , is known as the *Milnor fibre* of the singularity. It captures information about the topology of a fibre close to the singularity, as well as how this fibre degenerates. Moreover, it is a Liouville domain as defined in Section 2.1.1.1, where the Liouville form is given by the restriction of the standard Liouville form

$$\lambda_{\mathbb{C}^n} = \frac{\sqrt{-1}}{4} \sum_i^n z_i d\bar{z}_i - \bar{z}_i dz_i$$

on  $\mathbb{C}^n$ . The way in which the Milnor fibre captures the behaviour of a function as it degenerates into a singularity is elucidated by the following theorem of Milnor:

**Theorem 2.1.6** ([Mil68, Theorem 5.11]). *Let  $f$  have an isolated hypersurface singularity at the origin, and  $\varepsilon_0, \varepsilon > 0$  as in Theorem 2.1.5. Then, for  $c > 0$  sufficiently small, the manifold*

$$f^{-1}(c) \cap B_\varepsilon(0)$$

*is diffeomorphic to  $V_f = \varphi^{-1}(\arg(c))$ , where  $B_\varepsilon(0)$  is the ball of radius  $\varepsilon$  centred at the origin.*

Smoothly, the Milnor fibre  $V_f$  is independent of all choices. It is a remarkable result of Milnor [Mil68, Theorem 6.5] that the Milnor number entirely controls the topology of the Milnor fibre. In particular, he showed that there is a homotopy equivalence

$$V_f \simeq \bigvee_{i=1}^{\mu(f)} S^n.$$

On the other hand, this is far from the end of the story when one considers Milnor fibres in the symplectic category.

Our main interest will be in the *completed Milnor fibre*, considered as a symplectic manifold. This is the Liouville manifold constructed from the Liouville domain defined by the Milnor fibre. By an abuse of notation, we also denote the



completed Milnor fibre by  $V_f$ . The resulting completed Milnor fibre is a Liouville manifold, and is independent of all choices (including holomorphic representative of the equivalence class of germ), up to exact symplectomorphism (cf., for example, [Kea15, Lemmas 2.6 and 2.7]). We will therefore refer to *the* Milnor fibre of a singularity.

The second notion which we study will be that of a *Lefschetz fibration*, which is the central tool in Picard–Lefschetz theory. For a classical treatment of the subject, we refer to [AIG<sup>+</sup>98, Chapter 2]. Floer theory in the context of Lefschetz fibrations was introduced and systematically studied by Seidel, where a comprehensive account is provided in [Sei08b]. In particular, we refer to [Sei08b, Section 15d] for the general definition of a Lefschetz fibration. We will take the working definition to be a proper holomorphic map

$$f : X \rightarrow V \subseteq \mathbb{C},$$

where  $X$  is a complex manifold and  $V$  is open, having only Morse critical points<sup>10</sup>.

Our main interest will be even more elementary. In particular, consider  $f : \mathbb{C}^n \rightarrow \mathbb{C}$  a polynomial map with an isolated hypersurface singularity at the origin and no other critical points, and assume that it is tame in the sense of [Bro88]. Then,

$$\tilde{f} : \mathbb{C}^n \rightarrow \mathbb{C},$$

where  $\tilde{f}$  is *any* Morsification of  $f$ , is a Lefschetz fibration, and

$$|\text{crit}(\tilde{f})| = \mu(f).$$

This will be the only case of interest to us, and so we work directly with Lefschetz fibrations whose domain and codomain are  $\mathbb{C}^n$  and  $\mathbb{C}$ , respectively, from now on.

---

<sup>10</sup>Recall that Morse critical points are those such that the Hessian is non-degenerate.

**Remark 2.1.7.** *The number of non-degenerate critical points of any Morsification of an isolated hypersurface singularity is an equivalent definition of the Milnor number.*

For a Lefschetz fibration  $f : \mathbb{C}^n \rightarrow \mathbb{C}$ , there is a well-defined notion of *vanishing path*, *vanishing cycle*, and *Lefschetz thimble*. For  $p \in \text{crit}(f) \subseteq \mathbb{C}^n$ , we define a *vanishing path* as

$$\gamma : [0, 1] \rightarrow \mathbb{C}$$

such that  $\gamma(1) = f(p)$  and  $\gamma(t) \notin \text{crit}(f) \subseteq \mathbb{C}$  for all  $t \in [0, 1)$ . The corresponding *Lefschetz thimble*,  $\Delta_\gamma$ , is the unique embedded Lagrangian  $n$ -ball such that

- $f(\Delta_\gamma) = \gamma([0, 1])$ ,
- $f(\partial\Delta_\gamma) = \gamma(0)$ , and
- $\Delta_\gamma|_{f^{-1}(f(p))} = p$ .

We define the corresponding *vanishing cycle* as  $V_\gamma = \partial\Delta_\gamma$ . Equivalently, the vanishing cycle  $V_\gamma$  is the unique Lagrangian  $n$ -sphere in  $f^{-1}(\gamma(0))$  which collapses to  $p$  under symplectic parallel transport along  $\gamma$ . There is no reason to assume that there is at most one critical point in each fibre, although doing so simplifies the situation. We will therefore assume from now on that this is the case in order to ease the exposition.

Supposing we have a Lefschetz fibration, choose a distinguished point  $* \in V \setminus \text{crit}(f)$ . We define a *distinguished basis*<sup>11</sup> of vanishing paths  $\{\gamma_1, \dots, \gamma_N\}$  for  $N = |\text{crit}(f)|$  as any collection of vanishing paths such that

- For each  $i \in \{1, \dots, N\}$ ,  $\gamma_i(0) = *$  and  $\gamma_i(1) = p_i \in \text{crit}(f)$ .
- The paths only intersect at the distinguished point  $*$ .

---

<sup>11</sup>Here, the word ‘distinguished’ does not refer to any sort of canonical choice of basis, but rather, that the vanishing paths only intersect at the distinguished point  $*$ .

- The tangent directions  $\dot{\gamma}_i(0)$  at the distinguished point are all distinct in  $T_*\mathbb{C}$  and carry a clockwise ordering according to their argument.

All choices made will lead to equivalent categories at the derived level.

Of course, Lefschetz thimbles must be decorated with a brane structure in order to do Floer theory. Namely, one must equip the Lefschetz thimbles with a grading and spin structure. Moreover, the brane structure on a vanishing cycle  $V_i = \partial\Delta_i$  must be induced by restricting the brane structure of the Lefschetz thimble to its boundary<sup>12</sup>. This is explained in detail in [Sei08b, Section 18e], and we refer there for a complete construction. What will be most relevant to us is the following:

- The grading of the Lefschetz thimbles is with respect to the canonical (and unique up to homotopy) grading of  $\mathbb{C}^n$  given by the trivialising section  $(\partial_{x_1} \wedge \cdots \wedge \partial_{x_n})^{\otimes 2} \in K_{\mathbb{C}^n}^{\otimes -2}$ . Correspondingly, the grading of the vanishing cycles is induced by restricting the grading of the thimbles to the smooth fibre.
- In low dimensions, which is the case of interest to us, framings of the vanishing cycles (i.e. fixing a diffeomorphism  $S^n \xrightarrow{\sim} V_i$ ) do not play a role by [Sei08b, Remark 16.2]
- In the case of  $n = 2$ , which will be the case we focus on in this thesis, spin structures of vanishing cycles correspond to double covers of  $S^1$ , of which there are two – one trivial and one non-trivial. The spin structure on the vanishing cycle must bound a spin structure on the corresponding Lefschetz thimble, which can have no spin structure which restricts trivially on the boundary. Therefore, the spin structures on the vanishing cycles in this case must be the non-trivial ones.

After choosing a distinguished bases, one can associate to a Lefschetz fibration the *Fukaya–Seidel category*, which is denoted by  $\mathcal{FS}(f)$ . Roughly speaking, this is a

---

<sup>12</sup>Strictly speaking, a Lefschetz thimble also has a rank one local system; however, the contractibility of the thimble necessitates its triviality, and so we do not notate it. Since the local system on a vanishing cycle is induced by restriction, it must also be trivial.

category which is built from the Lefschetz thimbles with brane structures. As usual, the derived category

$$D^b\mathcal{FS}(f) = \text{Tw}\mathcal{FS}(f)$$

will be of most interest to us. Up to equivalence, this is independent of all choices made in the construction, and so is an invariant of the fibration. We refer to [Sei08b, Section 18] for a precise definition and detailed discussion. Instead of constructing this category from first principles, we utilise a theorem of Seidel which significantly simplifies its computation. An important step in the reformulation of the Fukaya–Seidel category is [Sei08b, Theorem 18.14], which, amongst other things, shows that the Lefschetz thimbles associated to a distinguished collection of vanishing paths forms an exceptional collection, allowing the category to be computed as modules over an  $A_\infty$ -algebra (an also implying that it is automatically split-closed). Moreover, by considering the vanishing cycles as exact Lagrangian branes in the distinguished fibre, where the brane structure is induced by restricting the brane structure on a thimble to its boundary, the morphisms between thimbles can be computed from the Floer theory of the vanishing cycles. To remember the order of the distinguished basis of vanishing paths, one imposes a directedness on these objects.

Following Seidel, we define a directed  $A_\infty$ -category  $\mathcal{A}_f$  such that

1. The objects of  $\mathcal{A}_f$  are the vanishing cycles  $V_i$  with the induced brane structure. A total ordering on the vanishing cycles is imposed by stipulating a starting point of the cyclic ordering of the corresponding  $\dot{\gamma}_i(0)$  (there is no preferred starting point).

2. The morphisms in the category are:

$$\mathrm{hom}_{\mathcal{A}_f}(V_i, V_j) = \begin{cases} 0 & \text{if } i > j \\ \mathbb{C} \cdot \mathrm{id} & \text{if } i = j \\ \mathrm{CF}^\bullet(V_i, V_j) & \text{if } i < j. \end{cases}$$

Here, the Floer cochain complex is calculated in the smooth fibre.

Seidel famously showed ([Sei08b, Theorem 18.24]) that there is a quasi-equivalence of pretriangulated  $A_\infty$ -categories over  $\mathbb{C}$

$$\mathrm{Tw} \mathcal{A}_f \simeq D^b \mathcal{FS}(f).$$

In practice, we will use this as our definition of the Fukaya–Seidel category.

In this thesis, our only source of Lefschetz fibrations will come from the Morsification of a tame isolated hypersurface singularity which has no other singular points. To such a Morsification, one can associate its Fukaya–Seidel category as above, and this is independent of the choice of Morsification. Therefore, we can speak of *the* Fukaya–Seidel category of an isolated hypersurface singularity. This will be one of the categories of central interest in this thesis, and is studied in the case of invertible polynomials in two variables in Section 3.

## 2.2 Preliminaries on invertible polynomials

Recall the definition of invertible polynomials from Chapter 1.1. The weights  $(d_0, d_1, \dots, d_n; h_{\mathbf{w}})$  can be constructed canonically by considering the unique solution to

$$A \begin{pmatrix} w_1 \\ w_2 \\ \vdots \\ w_n \end{pmatrix} = \det(A) \begin{pmatrix} 1 \\ 1 \\ \vdots \\ 1 \end{pmatrix}, \quad (2.3)$$

and then defining  $d_i := \frac{w_i}{d_{\mathbf{w}}}$  and  $h_{\mathbf{w}} := \frac{\det(A)}{d_{\mathbf{w}}}$ , where

$$d_{\mathbf{w}} = \gcd(w_1, \dots, w_n; \det(A)). \quad (2.4)$$

Note that  $\det(A) = \prod_{i=1}^n p_i - (-1)^n$  in the loop case, and  $\det(A) = \prod_{i=1}^n p_i$  in the chain and Brieskorn–Pham cases. In particular, we have:

**Lemma 2.2.1.** *Let  $\mathbf{w}$  be an invertible polynomial associated to a matrix  $A$ . Then, we have*

$$\begin{aligned} w_i &= \sum_{k=1}^n (-1)^{k-1} \prod_{j=k}^{n-1} p_{i+j} \quad \text{for loop polynomials,} \\ w_i &= \sum_{k=1}^{n+1-i} (-1)^{k-1} \prod_{j=k}^{n-1} p_{i+j} \quad \text{for chain polynomials, and} \\ w_i &= \prod_{j=1}^{n-1} p_{i+j} \quad \text{for Brieskorn–Pham polynomials,} \end{aligned}$$

where we interpret the empty product as 1 and count the subscripts of  $i+j$  modulo  $n$ .

*Proof.* It is straightforward to verify that the vector  $(w_1 \ w_2 \ \dots \ w_n)^T$  satisfies (2.3) in each case.  $\square$

Similarly, the Milnor numbers of invertible polynomials admit simple descriptions:

**Lemma 2.2.2.** *Let  $\mathbf{w}$  be an invertible polynomial of loop, chain, or Brieskorn–Pham type. Then*

$$\begin{aligned} \mu(\mathbf{w}_{\text{loop}}) &= \prod_{i=1}^n p_i, \\ \mu(\mathbf{w}_{\text{chain}}) &= \sum_{i=1}^{n+1} \prod_{j \geq i} (-1)^{j-1} p_j, \\ \mu(\mathbf{w}_{\text{BP}}) &= \prod_{i=1}^n (p_i - 1). \end{aligned}$$

Moreover,  $\mathbf{w}$  is tame in the sense of [Bro88].

*Proof.* By the assumption that each  $p_i \geq 2$ , any invertible polynomial has exactly one critical point, and so the calculation of the Milnor numbers is a dimension count of  $\mathbb{C}[x_1, \dots, x_n]/\text{Jac}_{\mathbf{w}}$  in each case. It is straightforward to check that the Milnor number of  $\mathbf{w}^{\mathbf{v}} = \mathbf{w} + v_1x_1 + \dots + v_nx_n$  for all  $\mathbf{v} \in \mathbb{C}^n$  sufficiently small matches that of  $\mathbf{w}$ , and so the tameness of  $\mathbf{w}$  follows from [Bro88, Proposition 3.1].  $\square$

**Remark 2.2.3.** *It should be emphasised that the Milnor numbers given in Lemma 2.2.2 are for the polynomials  $\mathbf{w}$ . In the case of loop and Brieskorn–Pham polynomials, the Milnor number of  $\mathbf{w}$  and  $\check{\mathbf{w}}$  will be the same, although this is not in general the case for chain polynomials.*

In general, a Morsification of  $\check{\mathbf{w}}$ , given by

$$\check{\mathbf{w}}_{\varepsilon} : \mathbb{C}^n \rightarrow \mathbb{C},$$

restricts to a Lefschetz fibration for suitable open subsets of the domain and codomain; however, combining the fact that our assumption that all  $p_i \geq 2$  implies that each  $\mathbf{w}$  (and therefore also  $\check{\mathbf{w}}$ ) has only one isolated critical point with the fact that invertible polynomials are tame, we can take these open subsets to be the entire domain and codomain. In this case, we can define the (completion of) the Milnor fibre as

$$\check{V} := \check{\mathbf{w}}^{-1}(c) \tag{2.5}$$

for any  $c \in \mathbb{C}^*$ . Similarly, the generic fibre of  $\check{\mathbf{w}}_{\varepsilon}$  is exact symplectomorphic to  $\check{V}$  (cf., for example, [Kea15, Lemma 2.18] for a closely related result). In what follows, we take  $c = 1$ .

Recall the definition of the maximal symmetry group (1.2), and define the corresponding group of characters as

$$\hat{\Gamma}_{\mathbf{w}} := \mathbb{Z}\chi_1 \oplus \dots \oplus \mathbb{Z}\chi_{n+1} / \{a_{i1}\chi_1 + a_{i2}\chi_2 \dots + a_{in}\chi_n - \chi_{n+1}\}_{i \in \{1, \dots, n\}}, \tag{2.6}$$

where

$$\begin{aligned} \chi_i : \Gamma_{\mathbf{w}} &\rightarrow \mathbb{C}^* \\ (t_1, \dots, t_{n+1}) &\mapsto t_i, \end{aligned} \tag{2.7}$$

and set  $\chi_{n+1} = \chi_{\mathbf{w}}$ . With this definition, we can view  $\Gamma_{\mathbf{w}}$  as the group of transformations of  $\mathbb{A}^n$  which keeps  $\mathbf{w}$  semi-invariant with respect to  $\chi_{\mathbf{w}}$ . Moreover, since  $t_{n+1}$  is determined by the other  $t_i$ , we consider  $\Gamma_{\mathbf{w}}$  to be a subgroup of  $(\mathbb{C}^*)^n$ ; in general, it is a finite extension of  $\mathbb{C}^*$ .

Since  $\mathbf{w}$  is quasi-homogeneous, there is an injective map

$$\begin{aligned} \varphi : \mathbb{C}^* &\rightarrow \Gamma_{\mathbf{w}} \\ t &\mapsto (t^{d_1}, \dots, t^{d_n}). \end{aligned} \tag{2.8}$$

The group  $\text{im } \varphi \cap \ker \chi_{\mathbf{w}}$  is cyclic of order  $h_{\mathbf{w}}$ , and is generated by  $\varphi(e^{\frac{2\pi\sqrt{-1}}{h}}) = j_{\mathbf{w}}$ , which we call the *grading element*. This fits into a short exact sequence

$$0 \rightarrow \mathbb{C}^* \xrightarrow{\varphi} \Gamma_{\mathbf{w}} \rightarrow \ker \chi_{\mathbf{w}} / \langle j_{\mathbf{w}} \rangle \rightarrow 0. \tag{2.9}$$

There is a bijection between subgroups  $\Gamma \subseteq \Gamma_{\mathbf{w}}$  of finite index containing  $\varphi(\mathbb{C}^*)$  and subgroups  $\bar{\Gamma} \subseteq \ker \chi_{\mathbf{w}}$  which contain the grading element. We call  $\ker \chi_{\mathbf{w}}$  the *maximal group of diagonal symmetries*.

**Definition 2.2.4.** *Let  $\mathbf{w}$  be an invertible polynomial and  $\ker \chi_{\mathbf{w}}$  its maximal group of diagonal symmetries. We call a subgroup  $\bar{\Gamma} \subseteq \ker \chi_{\mathbf{w}}$  admissible if  $\langle j_{\mathbf{w}} \rangle \subseteq \bar{\Gamma}$ .*

**Remark 2.2.5.** *i) It should be noted that this definition of admissible differs slightly from that given in [FJR13, Definition 2.3.2]; however, [Kra10, Proposition 3.4] shows that Definition 2.2.4 implies admissible in the sense of [FJR13].*

*ii) Since admissible subgroups of  $\ker \chi_{\mathbf{w}}$  are in bijection with subgroups of  $\Gamma_{\mathbf{w}}$  containing the image of  $\varphi$  in (2.9), we will also refer to such subgroups as admissible.*



The definition of  $j_{\check{w}}$  and  $\ker \chi_{\check{w}}$  are completely analogous. Given an admissible subgroup  $\Gamma \subseteq \Gamma_{\mathbf{w}}$ , we define

$$\chi := \chi_{\mathbf{w}}|_{\Gamma}. \quad (2.10)$$

In order to extend the action of any admissible  $\Gamma$  to  $\mathbb{A}^{n+1} = \text{Spec } \mathbb{C}[x_0, x_1, \dots, x_n]$ , as in Conjecture 3, we define the weight of  $\Gamma$  on the  $x_0$  variable to be

$$\chi_0 = \chi - \sum_{i=1}^n \chi_i. \quad (2.11)$$

This is done precisely so that  $x_0^{\vee} \wedge x_1^{\vee} \wedge \dots \wedge x_n^{\vee} \simeq \chi$  as  $\Gamma$ -modules, generalising the fact that a degree  $n + 1$  hypersurface in  $\mathbb{P}^n$  is Calabi–Yau.

**Lemma 2.2.6.** *Let  $\mathbf{w}$  be an invertible polynomial. Then*

$$\ker \chi_{\mathbf{w}_{loop}} \simeq \mu_{p_1 p_2 \dots p_n - (-1)^n}$$

$$\ker \chi_{\mathbf{w}_{chain}} \simeq \mu_{p_1 p_2 \dots p_n}$$

$$\ker \chi_{\mathbf{w}_{BP}} \simeq \prod_{i=1}^n \mu_{p_i}.$$

*Proof.* In each case, observe that  $\ker \chi_{\mathbf{w}}$  can be identified with the cokernel of the map  $\mathbb{Z}^n \xrightarrow{A} \mathbb{Z}^n$ . In the loop and chain cases, the result follows from computing the Smith normal form of the matrix, and in the Brieskorn–Pham case the claimed identification is immediate.  $\square$

To provide an explicit description of the action of  $\ker \chi_{\mathbf{w}}$  on  $\mathbb{A}^n$ , consider

$$A^{-1} = \begin{pmatrix} \varphi_1^{(1)} & \varphi_1^{(2)} & \cdots & \varphi_1^{(n)} \\ \varphi_2^{(1)} & \varphi_2^{(2)} & \cdots & \varphi_2^{(n)} \\ \vdots & \vdots & \ddots & \vdots \\ \varphi_n^{(1)} & \varphi_n^{(2)} & \cdots & \varphi_n^{(n)} \end{pmatrix} = \begin{pmatrix} \rho_1 & \rho_2 & \cdots & \rho_n \end{pmatrix}$$

$$= \begin{pmatrix} \check{\rho}_1 \\ \check{\rho}_2 \\ \vdots \\ \check{\rho}_n \end{pmatrix},$$

where  $\rho_k$  and  $\check{\rho}_k$  are the columns and rows of this matrix, respectively. In [Kra10], it is shown that the group  $\ker \chi_{\mathbf{w}}$  is generated by the  $\rho_i$ , where

$$\rho_k \cdot x_i = \exp(2\pi\sqrt{-1}\varphi_i^{(k)})x_i.$$

To see this, note that  $g = (g_1, \dots, g_n)^T$  is a diagonal symmetry of  $\mathbf{w}$  if and only if

$$A \begin{pmatrix} g_1 \\ \vdots \\ g_n \end{pmatrix} \in \mathbb{Z}^n.$$

Therefore,  $g$  is a linear combination of the columns of  $A^{-1}$ , i.e. the  $\rho_i$ . Moreover, it is immediate that

$$j_{\mathbf{w}} = \prod_{i=1}^n \rho_i.$$

Dual to the action of  $\rho_i$  on  $\mathbb{A}^n$ , we have that  $\ker \chi_{\check{\mathbf{w}}}$  is generated by the  $\check{\rho}_k$ , where

$$\check{\rho}_k \cdot \check{x}_i = \exp(2\pi\sqrt{-1}\varphi_k^{(i)})\check{x}_i.$$

(Note the transpose of the indices of  $\varphi_i^{(k)}$  in this action with respect to the action of

$\rho_k!$ ) For any admissible subgroup  $\bar{\Gamma} \subseteq \ker \chi_{\mathbf{w}}$ , we then define the dual group as

$$\check{\Gamma} = \left\{ \prod_{j=1}^n (\check{\rho}_j)^{r_j} \mid \prod_{j=1}^n x_j^{r_j} \in (\mathbb{C}[x_1, \dots, x_n])^{\bar{\Gamma}} \right\}. \quad (2.12)$$

By [ET12, Proposition 3], there is an isomorphism

$$\mathrm{Hom}(\ker \chi_{\mathbf{w}} / \bar{\Gamma}, \mathbb{C}^*) \simeq \check{\Gamma} \subseteq \ker \chi_{\check{\mathbf{w}}}. \quad (2.13)$$

Some immediate consequences are:

**Lemma 2.2.7.** *Let  $\bar{\Gamma} \subseteq \ker \chi_{\mathbf{w}}$  be an admissible subgroup. Then*

- i)  $\check{\Gamma} \subseteq \mathrm{SL}_n(\mathbb{C}) \cap \ker \chi_{\check{\mathbf{w}}}$ , and
- ii) *The action of  $\check{\Gamma}$  is free away from the divisor  $\{\check{x}_1 \dots \check{x}_n = 0\}$ .*
- iii) *In the case of  $\bar{\Gamma} \subseteq \ker \chi_{\mathbf{w}} \cap \mathrm{SL}_n(\mathbb{C})$ , we have  $\langle j_{\check{\mathbf{w}}} \rangle \subseteq \check{\Gamma}$ .*
- iv) *For  $\Gamma = \Gamma_{\mathbf{w}}$ , the dual group is trivial.*

*Proof.* To prove part i), observe that, by definition,  $\check{g} = \check{\rho}_1^{r_1} \dots \check{\rho}_n^{r_n} \in \check{\Gamma}$  if and only if  $x_1^{r_1} \dots x_n^{r_n} \in (\mathbb{C}[x_1, \dots, x_n])^{\bar{\Gamma}}$ . In turn, this is true if and only if

$$\frac{\sum_{i=1}^n r_i w_i}{\det(A)} \in \mathbb{Z},$$

and so  $\det(\check{g}) = e^{2\pi\sqrt{-1} \frac{\sum_{i=1}^n r_i w_i}{\det(A)}} = 1$ .

Part ii) follows from the definition of  $\check{\Gamma} \subseteq \ker \chi_{\check{\mathbf{w}}}$ . In particular,  $\ker \chi_{\check{\mathbf{w}}}$  is generated by elements  $(\check{t}_1, \dots, \check{t}_n) \in (\mathbb{C}^*)^n$  such that  $\check{\mathbf{w}}(\check{t}_1 \check{x}_1, \dots, \check{t}_n \check{x}_n) = \mathbf{w}(\check{x}_1, \dots, \check{x}_n)$ , and so the only element which fixes any point in  $(\mathbb{C}^*)^n = \mathbb{C}^n \setminus \{\check{x}_1 \dots \check{x}_n\}$  is  $\check{t}_i = 1$  for each  $i = 1, \dots, n$ .

The fact that  $\langle j_{\check{\mathbf{w}}} \rangle \subseteq \Gamma_{\check{\mathbf{w}}}$  in the case that  $\bar{\Gamma} \subseteq \mathrm{SL}_n(\mathbb{C})$  follows from the fact that  $x_1 \dots x_n$  is  $\bar{\Gamma}$ -invariant for any such gamma. Therefore  $j_{\check{\mathbf{w}}} = \prod_{i=1}^n \check{\rho}_i \in \check{\Gamma}$ .

The proof of statement *iv*) follows directly from the presentation of  $\check{\Gamma}$  in (2.13). □

Before moving on, we briefly note here that there are interesting classes of singularities which fall into the framework of invertible polynomials. For example, all ADE singularities are invertible, although not necessarily atomic, polynomials. In fact, Arnol'd's strange duality can be understood in the context of invertible polynomials, and demonstrates one of the earliest manifestations of what we now view as mirror symmetry. In particular, the Hodge-theoretic statement of mirror symmetry for Arnol'd's list of 14 exceptional unimodal singularities was established in [Kra10, Corollary 1.3]. More recently, invertible polynomials have appeared in the context of compound Du Val (cDV) singularities in [EL21]. Here, the authors observed that there are families of such singularities which are invertible, allowing techniques available in this setting to be exploited. This provides motivation and evidence for a conjecture relating the existence of small resolutions of a singularity with constraints on the symplectic cohomology of its Milnor fibre.

These applications demonstrate what one hopes is a general phenomenon of invertible polynomials: they can be used to suggest and provide evidence for more general patterns and conjectures. Indeed, Chapter 5 can also be viewed in this context, in the sense that the procedure for gluing the Milnor fibres of invertible curve singularities in Chapter 4 suggests a more general story of which the Milnor fibres are a special case, leading to Theorems 3, 4, and 5 .

## Chapter 3

# Homological Berglund–Hübsch mirror symmetry for curve singularities

### 3.1 Introduction

In this chapter, which presents the results of [HS20], completed in joint work with Jack Smith, we study Conjecture 1 for the case of invertible polynomials in two variables with maximal symmetry group, as defined in (1.2). Our main result is:

**Theorem 3.1.1.** *Let  $\mathbf{w}$  be an invertible polynomial and  $\Gamma \subseteq \Gamma_{\mathbf{w}}$  an admissible subgroup of the maximal group of symmetries of  $\mathbf{w}$ . Then, there is a quasi-equivalence*

$$\mathrm{mf}(\mathbb{A}^n, \Gamma_{\mathbf{w}}, \mathbf{w}) \simeq D^b \mathcal{FS}(\check{\mathbf{w}})$$

*of pre-triangulated  $A_{\infty}$  categories over  $\mathbb{C}$ .*

As a by-product of our proof, we also show:

**Theorem 3.1.2.** *For every two variable invertible polynomial, the category  $\mathrm{mf}(\mathbb{A}^2, \Gamma_{\mathbf{w}}, \mathbf{w})$  has a tilting object.*

#### 3.1.1 Proof outline

In what follows, we restrict attention to  $n = 2$ , and use variables  $x$  and  $y$  rather than  $x_i$ , and  $p$  and  $q$  in place of  $p_i$ . By the classification of atomic invertible polynomials

in Section 1.1, we need to deal with the following cases:

- Brieskorn–Pham:  $\mathbf{w} = x^p + y^q$ ,  $\check{\mathbf{w}} = \check{x}^p + \check{y}^q$
- chain:  $\mathbf{w} = x^p y + y^q$ ,  $\check{\mathbf{w}} = \check{x}^p + \check{x}\check{y}^q$
- loop:  $\mathbf{w} = x^p y + x y^q$ ,  $\check{\mathbf{w}} = \check{x}^p \check{y} + \check{x}\check{y}^q$ .

We treat all three families in a uniform way, and obtain new proofs of the results of Futaki–Ueda for the two-variable Brieskorn–Pham and type  $D$  (chain,  $q = 2$ ) singularities. As in Chapter 1 shall always assume that  $p$  and  $q$  are at least 2. In the Brieskorn–Pham and chain cases these inequalities are necessary in order for the origin to be a critical point of both  $\mathbf{w}$  and  $\check{\mathbf{w}}$ , whilst if  $p$  or  $q$  is 1 in the loop case then  $\mathbf{w}$  and  $\check{\mathbf{w}}$  can be reduced to  $x^2 + y^2$  and  $\check{x}^2 + \check{y}^2$  by a change of variables.

The general strategy of proof is familiar: we match up explicit collections of generators on the two sides. Concretely, on the A-side, we compute the directed  $A_\infty$ -category  $\mathcal{A}$  associated to a basis of vanishing cycles in the Milnor fibre of  $\check{\mathbf{w}}$ , as outlined in Section 2.1.2. In the cases at hand, the Milnor numbers given in Lemma 2.2.2 are

$$(p-1)(q-1)$$

in the Brieskorn–Pham case,

$$pq - p + 1 = (p-1)(q-1) + (q-1) + 1$$

in the chain case, and

$$pq = (p-1)(q-1) + (p-1) + (q-1) + 1$$

in the loop case. The reasons for expressing them in this way will fall out of our computations.

Meanwhile, on the B-side, we identify a collection of objects in  $\text{mf}(\mathbb{A}^2, \Gamma_{\mathbf{w}}, \mathbf{w})$  whose corresponding full subcategory  $\mathcal{B}$  is quasi-equivalent to  $\mathcal{A}$ . Since the matrix

factorisation category is already pretriangulated we obtain a functor

$$\mathrm{Tw} \mathcal{B} \rightarrow \mathrm{mf}(\mathbb{A}^2, \Gamma_{\mathbf{w}}, \mathbf{w}),$$

and by a generation result (see Lemma 3.2.17 and Remark 3.2.18) this becomes a quasi-equivalence after taking the idempotent completion. Our calculations will actually show that the objects in  $\mathcal{B}$  form a full exceptional collection so by [Sei08b, Remark 5.14] the categories are in fact already idempotent complete. Putting everything together we obtain a sequence of quasi-equivalences

$$D^b \mathcal{FS}(\check{\mathbf{w}}) \simeq \mathrm{Tw} \mathcal{A} \simeq \mathrm{Tw} \mathcal{B} \simeq \mathrm{mf}(\mathbb{A}^2, \Gamma_{\mathbf{w}}, \mathbf{w}),$$

proving Theorem 3.1.1. The sum of the objects in  $\mathcal{B}$  gives the tilting object of Theorem 3.1.2.

The choice of generators on the B-side is fairly natural; the main difficulty in proving Theorem 3.1.1 is to construct a Morsification and basis of vanishing paths for  $\check{\mathbf{w}}$  such that the category  $\mathcal{A}$  built from the corresponding vanishing cycles matches up with  $\mathcal{B}$ . In order to do this systematically, we make a preliminary perturbation of  $\check{\mathbf{w}}$  by subtracting  $\varepsilon \check{x}\check{y}$  for small positive real  $\varepsilon$ . This has Morse critical points but not, in general, distinct critical values—following a suggestion of Yankı Lekili, we call this a *resonant* Morsification. The central fibre is nodal and upon passing to a nearby regular fibre the nodes are smoothed to thin necks, each supporting a vanishing cycle as the waist curve. These cycles naturally pair up with the B-side generators supported along components of  $\mathbf{w}^{-1}(0)$ .

Understanding the remaining vanishing cycles, which are mirror to sheaves supported at the origin in  $\mathbf{w}^{-1}(0)$ , requires most of the work. There is an obvious ‘real’ vanishing cycle, and by acting by roots of unity on the  $\check{x}$ - and  $\check{y}$ -coordinates we obtain curves which are almost the other vanishing cycles. The problem is that they live in different regular fibres, and carrying them to the same fibre requires explicit analysis of the parallel transport equation on the thin neck regions. The resulting vanishing paths overlap each other, so we carefully perturb them to reduce

to a small set of transverse intersections, and then eliminate these intersections by large deformations of the paths which do not affect the vanishing cycles. Finally we modify the vanishing cycles by Hamiltonian perturbations to resolve the remaining ambiguities in their intersection pattern.

### 3.1.2 Structure of the chapter

We first consider the case of loop polynomials in detail, describing the B-model in Section 3.2 and the A-model in Section 3.3, culminating in proofs of Theorems 3.1.2 and 3.1.1 (in the loop case) respectively. In Sections 3.4 and 3.5 we describe the minor modifications needed to deal with chain polynomials, and finally in Section 3.6 we summarise the further modifications needed for Brieskorn–Pham polynomials. We emphasise that these modifications are essentially just simplifications of the argument – the general approach is identical and all of the ingredients are contained in the loop case.

## 3.2 B-model for loop polynomials

### 3.2.1 Graded matrix factorisations

Our goal in this section is to understand the category  $\text{mf}(\mathbb{A}^2, \Gamma_{\mathbf{w}}, \mathbf{w} = x^p y + xy^q)$  of equivariant matrix factorisations for the loop polynomial. Recall that here  $p$  and  $q$  are assumed to be at least 2. We begin by briefly reviewing the definition, following [FU13]. As mentioned in Section 1.1, we encode equivariance as respect for the grading by the abelian group  $L$ . In two variables, this is the group freely generated by elements  $\vec{x}$ ,  $\vec{y}$  and  $\vec{c}$  modulo the relations

$$p\vec{x} + \vec{y} = \vec{x} + q\vec{y} = \vec{c},$$

given in (1.3). Equivalently,  $L$  is the quotient of  $\mathbb{Z}^2$  by the subgroup generated by  $(p-1, 1-q)$ : the elements  $\vec{x}$ ,  $\vec{y}$  and  $\vec{c}$  correspond to  $(1, 0)$ ,  $(0, 1)$  and  $(p, 1) = (1, q)$  respectively. Note that the quotient  $L/\mathbb{Z}\vec{c}$  is isomorphic to  $\mathbb{Z}_{pq-1}$ , generated by  $\vec{x}$  or equivalently by  $\vec{y} = -p\vec{x}$ .



Let  $S$  denote the  $L$ -graded algebra  $\mathbb{C}[x, y]$  in which  $x$  has degree  $\vec{x}$  and  $y$  has degree  $\vec{y}$ . The polynomial  $\mathbf{w} = x^p y + xy^q$  is a homogeneous element of degree  $\vec{c}$ , and we write  $R$  for the quotient  $S/(\mathbf{w})$ . Given an  $L$ -graded  $R$ - or  $S$ -module  $M$ , and an element  $l$  of  $L$ , we write  $M(l)$  for the module obtained from  $M$  by shifting the degree of each element downwards by  $l$ . We shall use subscripts to denote  $L$ -graded pieces, so that  $M(l)_i = M_{i+l}$  and  $S_{\vec{x}} = \mathbb{C} \cdot x$ , for example. Note that our notation for  $R$  and  $S$  is consistent with Futaki–Ueda [FU13], but opposite to that of Dyckerhoff [Dyc11].

By an  *$L$ -graded matrix factorisation* of  $\mathbf{w}$ , we mean a sequence

$$K^\bullet = (\cdots \rightarrow K^i \xrightarrow{k^i} K^{i+1} \xrightarrow{k^{i+1}} K^{i+2} \rightarrow \cdots)$$

of  $L$ -graded free  $S$ -modules of finite rank such that  $K^\bullet[2]$  is identified with  $K^\bullet(\vec{c})$  – i.e.  $K^{i+2}$  with  $K^i(\vec{c})$  and  $k^{i+2}$  with  $k^i(\vec{c})$  for all  $i$  – and such that under these identifications the composition of any two consecutive maps in the sequence is multiplication by  $\mathbf{w}$ . A finitely generated  $L$ -graded  $R$ -module  $M$  gives rise to a matrix factorisation by taking a free resolution, which eventually stabilises (becomes 2-periodic to the left, up to shifting the  $L$ -grading by  $\vec{c}$  every two terms), then extending this 2-periodic part indefinitely to the right, and replacing the free  $R$ -modules by the corresponding free  $S$ -modules; see [Dyc11, Sections 2.1 and 2.2]. This is the *stabilisation* of  $M$ .

The set of  $L$ -graded matrix factorisations forms a  $\mathbb{Z}$ -graded dg-category  $\text{mf}(\mathbb{A}^2, \Gamma_{\mathbf{w}}, \mathbf{w})$  as follows:  $\text{hom}^i(K^\bullet, H^\bullet)$  comprises sequences  $(f^\bullet : K^\bullet \rightarrow H^\bullet[i])$  satisfying  $f^\bullet[2] = f^\bullet(\vec{c})$ , the differential

$$d : \text{hom}^i(K^\bullet, H^\bullet) \rightarrow \text{hom}^{i+1}(K^\bullet, H^\bullet)$$

is given by [Dyc11, Definition 2.1], namely

$$df = h \circ f - (-1)^i f \circ k,$$

and composition is component-wise. We shall write  $\text{Hom}^i$  for the degree  $i$  cohomology of  $\text{hom}^\bullet$ .

Finitely generated  $L$ -graded  $R$ -modules correspond to coherent sheaves on the stack  $[\mathbf{w}^{-1}(0)/\Gamma_{\mathbf{w}}]$ , and this gives a natural equivalence between  $D_{\text{sing}}^b([\mathbf{w}^{-1}(0)/\Gamma_{\mathbf{w}}])$  and the derived category of singularities of graded  $R$ -modules

$$D_{\text{sing}}^b(\text{gr}R) := D^b(\text{gr}R)/\text{perf}(\text{gr}R),$$

where  $\text{perf}$  now refers to complexes of projective modules ( $D^b(\text{gr}R)$  is the usual derived category of finitely-generated  $L$ -graded  $R$ -modules). The equivalence (1.4) then becomes an equivalence

$$\text{HMF}(\mathbb{A}^2, \Gamma_{\mathbf{w}}, \mathbf{w}) \rightarrow D_{\text{sing}}^b(\text{gr}R). \quad (3.1)$$

Stabilisation of a module gives an inverse to this equivalence, and we will frequently switch between talking about matrix factorisations, modules, and sheaves on  $[\mathbf{w}^{-1}(0)/\Gamma_{\mathbf{w}}]$ .

### 3.2.2 The basic objects

The stack  $[\mathbf{w}^{-1}(0)/\Gamma_{\mathbf{w}}]$  has three components: the lines  $x = 0$  and  $y = 0$  and the curve  $x^{p-1} + y^{q-1} = 0$ . Note that the third component is reducible if  $\text{gcd}(p-1, q-1) > 1$ . For brevity we will denote  $x^{p-1} + y^{q-1}$  by  $w$ , so that  $\mathbf{w} = xyw$ . The matrix factorisations corresponding to the structure sheaves of these components are

$$\begin{aligned} K_x^\bullet &= (\cdots \rightarrow S(-\vec{c}) \xrightarrow{yw} S(-\vec{x}) \xrightarrow{x} S \rightarrow \cdots), \\ K_y^\bullet &= (\cdots \rightarrow S(-\vec{c}) \xrightarrow{xw} S(-\vec{y}) \xrightarrow{y} S \rightarrow \cdots), \end{aligned}$$

and

$$K_w^\bullet = (\cdots \rightarrow S(-\vec{c}) \xrightarrow{xy} S(-\vec{c} + \vec{x} + \vec{y}) \xrightarrow{w} S \rightarrow \cdots)$$

respectively, obtained by applying the stabilisation procedure of Section 3.2.1 to the  $L$ -graded  $R$ -modules  $R/(x)$ ,  $R/(y)$  and  $R/(w)$ . In each case, the third of the three

terms written lies in degree 0 within the sequence. We will be particularly interested in the shifts

$${}^i K_x = K_x((i+1-p)\vec{x}) \quad \text{for } i = 1, \dots, p-1$$

and

$${}^j K_y = K_y((j+1-q)\vec{y}) \quad \text{for } j = 1, \dots, q-1$$

of the  $K_x$  and  $K_y$  objects.

The unique singular point of the stack is the origin, and the other main objects we will be interested in are  $L$ -grading shifts of the structure sheaf of its fattenings. Specifically, for  $i = 1, \dots, p-1$  and  $j = 1, \dots, q-1$  let  ${}^{i,j}K_0^\bullet$  be the matrix factorisation

$$\begin{array}{ccccccc} S(\vec{x} + \vec{y}) & \xrightarrow{y^j} & S(\vec{x} + (j+1)\vec{y}) & \xrightarrow{xy^{q-j}} & S(\vec{c} + \vec{x} + \vec{y}) & & \\ & \searrow^{-x^i} & \nearrow & \searrow^{x^i} & \nearrow & & \\ \dots & \oplus & & \oplus & & \oplus & \dots \\ & \nearrow^{x^{p-i}y} & \searrow & \nearrow^{-x^{p-i}y} & \searrow & & \\ S(-\vec{c} + (i+1)\vec{x} + (j+1)\vec{y}) & \xrightarrow{xy^{q-j}} & S((i+1)\vec{x} + \vec{y}) & \xrightarrow{y^j} & S((i+1)\vec{x} + (j+1)\vec{y}) & & \end{array}$$

corresponding to the  $R$ -module  $R((i+1)\vec{x} + (j+1)\vec{y})/(x^i, y^j)$ . This stabilisation can be computed by starting with the obvious first steps of an  $R$ -free resolution

$$R(\vec{x} + (j+1)\vec{y}) \oplus R((i+1)\vec{x} + \vec{y}) \xrightarrow{\begin{pmatrix} x^i & y^j \end{pmatrix}} R((i+1)\vec{x} + (j+1)\vec{y})$$

and extending by hand. Shifts of the object  $R/(x, y)$  appear in the work of Dyckerhoff [Dyc11, Section 4.1], who calls it  $k^{\text{stab}}$  ( $k$  is the ground field), and Seidel [Sei11, Section 11]; here the resolution is described abstractly as a Koszul complex. A concrete example close to our setting is given by Futaki–Ueda [FU13, Section 4].

**Remark 3.2.1.** *The motivation for considering these objects is Orlov’s result [Orl09, Theorem 40(ii)], extended to the present setting in [HO18, Theorem B.2], which gives a semi-orthogonal decomposition*

$$D_{\text{sing}}^b(\text{gr}R) = \langle \mathcal{C}, D^b(Y) \rangle,$$

where  $Y$  is the projectivised stack  $[(\mathbf{w}^{-1}(0) \setminus (\mathbf{0})) / \Gamma_{\mathbf{w}}]$  and  $\mathcal{C}$  is the full subcategory

generated by a certain collection of grading shifts of the structure sheaf of the origin. In our case  $Y$  is the zero locus of  $\mathbf{w}$  inside the weighted projective line  $\text{Proj } S$ , and it consists of three points: one is smooth and its structure sheaf corresponds to a mutation of  $K_w$  (although we do not explicitly compute which, since this decomposition is purely motivational); the other two are stacky and their structure sheaves, twisted by characters of their isotropy groups, are given by the  ${}^i K_x$  and  ${}^j K_y$ . We replace  $\mathcal{C}$  by the related category  $\langle {}^{i,j} K_0 \rangle$  to give the correct pattern of morphisms.

Let  $\mathcal{B}$  be the full  $A_\infty$ -subcategory of  $\text{mf}(\mathbb{A}^2, \Gamma_{\mathbf{w}}, \mathbf{w})$  generated by the  $pq$  objects

$$\{ {}^{i,j} K_0, {}^i K_x[3], {}^j K_y[3], K_w[3] \}_{i=1, \dots, p-1; j=1, \dots, q-1}.$$

The reason for the shifts is so that all morphisms turn out to have degree 0. In Sections 3.2.3 to 3.2.7, we compute the morphisms between these objects in the homotopy category  $\text{HMF}(\mathbb{A}^2, \Gamma_{\mathbf{w}}, \mathbf{w})$ . The reader willing to take these calculations on trust may skip immediately to Section 3.2.8, where we assemble the results and deduce that  $\mathcal{B}$  is quasi-equivalent to a specific quiver algebra with relations and formal  $A_\infty$ -structure. Then, in Section 3.2.9, we address the issue of generation, and show that  $\text{Tw } \mathcal{B} \rightarrow \text{mf}(\mathbb{A}^2, \Gamma_{\mathbf{w}}, \mathbf{w})$  is a quasi-equivalence. We conclude that the sum of the objects in  $\mathcal{B}$  is a tilting object for  $\text{mf}(\mathbb{A}^2, \Gamma_{\mathbf{w}}, \mathbf{w})$ , proving Theorem 3.1.2 for loop polynomials.

### 3.2.3 Morphisms between $K_x$ 's, between $K_y$ 's, and from $K_w$ to itself

We wish to compute morphisms in the homotopy category  $\text{HMF}(\mathbb{A}^2, \Gamma_{\mathbf{w}}, \mathbf{w})$ , and a priori this involves taking the cohomology of the morphism complexes described in Section 3.2.1. Thinking of matrix factorisations as stabilisations of  $R$ -modules, this corresponds to computing module  $\text{Ext}$ 's by (projectively) resolving both the domain and codomain. One might expect the latter to be unnecessary, and Buchweitz [Buc86, Section 1.3, Remark (a)] showed that this is indeed the case: given  $L$ -graded

$R$ -modules  $M$  and  $M'$  with stabilisations  $K$  and  $K'$ , we have

$$\mathrm{Hom}_{\mathrm{HMF}(\mathbb{A}^2, \Gamma_{\mathbf{w}}, \mathbf{w})}^{\bullet}(K, K') \simeq \mathbf{H}^{\bullet}(\mathrm{Hom}_{\mathrm{gr}R}(K \otimes_S R, M')).$$

The Hom on the right-hand side is taken component-wise on the complex  $K \otimes_S R$ .

For any  $l$  in  $L$  we therefore have

$$\mathrm{Hom}^{\bullet}(K_x, K_x(l)) \simeq \mathbf{H}^{\bullet}(\cdots \rightarrow (R/(x))_l \xrightarrow{x} (R/(x))_{l+\vec{x}} \xrightarrow{yw} (R/(x))_{l+\vec{c}} \rightarrow \cdots),$$

where the first of the three written terms now lives in degree 0 (we have taken  $L$ -graded module homomorphisms from  $K_x^{\bullet} \otimes_S R$  into  $R(l)/(x)$ ). This gives

$$\mathrm{Hom}^{2m}(K_x, K_x(l)) \simeq (R/(x, yw))_{m\vec{c}+l}$$

for any integer  $m$ , whilst  $\mathrm{Hom}^{2m+1}(K_x, K_x(l)) = 0$ .

One can easily compute a basis of  $\mathrm{Hom}^{2m}$  by hand in this situation, but, since we will repeatedly make similar arguments, we record the following general facts relating gradings and divisibility:

**Lemma 3.2.2.** *Suppose that  $a$  and  $b$  are integers satisfying  $a \leq p-1$  and  $b \leq q-1$ , and that  $s$  is an element of  $S$  (or  $R$ ) which is homogeneous modulo  $\vec{c}$ , of degree  $a\vec{x} + b\vec{y} \bmod \vec{c}$ . Then:*

- (i) *The element  $s$  lies in the ideal  $(x^a, y^{q-1+b}) \cap (x^{p-1+a}, y^b)$ .*
- (ii) *If  $a \leq p-2$ , then  $s$  also lies in  $(x^a, y^{q+b})$ .*
- (iii) *If  $b \leq q-2$ , then  $s$  also lies in  $(x^{p+a}, y^b)$ .*

*Proof.* Assume  $a \leq p-1$  and  $b \leq q-1$ , and let  $x^u y^v$  be a monomial in  $s$ , so that

$$(u-a)\vec{x} + (v-b)\vec{y} \equiv 0 \bmod \vec{c}. \quad (3.2)$$

We claim first that  $u \geq a$  or  $v \geq q-1+b$ , so suppose for contradiction that neither

holds. Then

$$-(p-1) \leq u-a \leq -1 \quad \text{and} \quad -(q-1) \leq v-b \leq q-2,$$

so  $(u-a) - p(v-b)$  is non-zero (by reducing modulo  $p$ ) and lies strictly between  $\pm(pq-1)$ . Substituting  $\vec{y} = -p\vec{x} \bmod \vec{c}$  into (3.2) tells us that  $(u-a) - p(v-b) \equiv 0 \pmod{pq-1}$ , which gives the desired contradiction, and we deduce that  $u \geq a$  or  $v \geq q-1+b$ , and hence that  $s$  lies in  $(x^a, y^{q-1+b})$ . The other arguments are analogous.  $\square$

**Lemma 3.2.3.** *Suppose  $s$  is an element of degree  $0 \bmod \vec{c}$ . Then the non-constant terms in  $s$  lie in the ideal  $(x^{pq-1}, x^p y, xy^q, y^{pq-1})$ .*

*Proof.* Let  $x^u y^v$  be a non-constant monomial in  $s$ . If  $u = 0$  (or  $v = 0$ ) then one easily obtains  $v \geq pq-1$  (respectively  $u \geq pq-1$ ), so suppose now that  $u$  and  $v$  are both positive. We have  $u - pv \equiv 0 \pmod{pq-1}$ , so if  $u < p$  then we must have  $u - pv \leq -(pq-1)$  and hence  $v \geq q$ .  $\square$

From these we conclude:

**Lemma 3.2.4.** *In  $\text{HMF}(\mathbb{A}^2, \Gamma_{\mathbf{w}}, \mathbf{w})$  the objects  ${}^1K_x, \dots, {}^{p-1}K_x$  are exceptional (the endomorphisms of each are just the scalar multiples of the identity) and pairwise orthogonal.*

*Proof.* By the above computation, the morphisms from  ${}^iK_x$  to  ${}^lK_x$  are given by the elements of  $R/(x, yw)$  of degree  $(I-i)\vec{x} \bmod \vec{c}$ . If  $I-i > 0$  then Lemma 3.2.2(ii) tells us that all such elements lie in  $(x, y^q) = (x, yw)$ , and hence vanish in the quotient. If  $I-i < 0$ , then the same argument applies but using Lemma 3.2.2(i) instead, after rewriting the degree as  $(p+I-i)\vec{x} + \vec{y} \bmod \vec{c}$ . Finally, if  $I=i$  then Lemma 3.2.3 tells us that only constants survive in the quotient.  $\square$

Likewise. we have:

**Lemma 3.2.5.** *The objects  ${}^1K_y, \dots, {}^{q-1}K_y$  are exceptional and pairwise orthogonal.*

Similar calculations give

$$\mathrm{Hom}^{2m}(K_w, K_w) \simeq (R/(xy, w))_{m\vec{c}}$$

and  $\mathrm{Hom}^{2m+1}(K_w, K_w) = 0$ , so by Lemma 3.2.3 we deduce:

**Lemma 3.2.6.** *The object  $K_w$  is exceptional.*

### 3.2.4 Morphisms between $K_x$ 's, $K_y$ 's, and $K_w$

For all  $l$  and  $m$  we have

$$\mathrm{Hom}^{2m+1}(K_x, K_y(l)) \simeq (R/(x, y))_{m\vec{c}+l+\vec{x}}$$

whilst  $\mathrm{Hom}^{2m}(K_x, K_y(l)) = 0$ . This gives:

**Lemma 3.2.7.** *Each  ${}^i K_x$  is orthogonal to each  ${}^j K_y$ .*

*Proof.* For morphisms  ${}^i K_x$  to  ${}^j K_y$  we need to show that there are no (non-zero) elements in  $R/(x, y)$  of degree  $(1-i)\vec{x} + j\vec{y} \bmod \vec{c}$ , and this follows from Lemma 3.2.2(i). The argument is similar for morphisms in the opposite direction.  $\square$

Analogous computations yield

$$\mathrm{Hom}^{2m+1}(K_x(l), K_w) \simeq (R/(x, w))_{m\vec{c}-l+\vec{x}}$$

and  $\mathrm{Hom}^{2m}(K_x(l), K_w) = 0$  for all  $l$  and  $m$ . Similarly

$$\mathrm{Hom}^{2m+1}(K_w, K_x(l)) \simeq (R/(x, w))_{(m+1)\vec{c}+l-\vec{y}}$$

whilst  $\mathrm{Hom}^{2m}(K_w, K_x(l)) = 0$ .

Likewise

$$\mathrm{Hom}^{2m+1}(K_y(l), K_w) \simeq (R/(y, w))_{m\vec{c}-l+\vec{y}},$$

$$\mathrm{Hom}^{2m+1}(K_w, K_y(l)) \simeq (R/(y, w))_{(m+1)\vec{c}+l-\vec{x}},$$

$$\mathrm{Hom}^{2m}(K_y(l), K_w) = \mathrm{Hom}^{2m}(K_w, K_y(l)) = 0.$$

In particular:

**Lemma 3.2.8.** For each  $i$  and  $j$  the objects  ${}^iK_x$  and  ${}^jK_y$  are orthogonal to  $K_w$ .

*Proof.* For orthogonality of  ${}^iK_x$  and  $K_w$  we need to check that elements of degree  $(p-i)\bar{x}$  or  $(i+1)\bar{x}$  modulo  $\bar{c}$  lie in the ideal  $(x, w) = (x, y^{q-1})$ . This follows immediately from Lemma 3.2.2(i), except that for  $(i+1)\bar{x}$  with  $i = p-1$  we must first rewrite the degree as  $\bar{x} + (q-1)\bar{y} \bmod \bar{c}$ . The argument for  ${}^jK_y$  is analogous.  $\square$

**Remark 3.2.9.** These results match our expectation from Remark 3.2.1 that the objects  ${}^iK_x$  and  ${}^jK_y$  correspond to structure sheaves of disjoint points in the projective stack  $Y$ , twisted by characters of their isotropy groups, and hence should be exceptional and orthogonal. Moreover, since the object  $K_w$  corresponds to a mutation of the structure sheaf of the smooth point, this should also be orthogonal to the  ${}^iK_x$  and  ${}^jK_y$ .

### 3.2.5 Morphisms between $K_w$ and $K_0$ 's

We now fix  $(i, j)$  with  $1 \leq i \leq p-1$  and  $1 \leq j \leq q-1$ , and see that

$$\mathrm{Hom}^\bullet(K_w, {}^{i,j}K_0) \simeq \mathbf{H}^\bullet(\cdots \rightarrow (R/(x^i, y^j))_l \xrightarrow{w} (R/(x^i, y^j))_{l+\bar{c}-\bar{x}-\bar{y}} \xrightarrow{xy} (R/(x^i, y^j))_{l+\bar{c}} \rightarrow \cdots),$$

where  $l = (i+1)\bar{x} + (j+1)\bar{y}$ . The terms in odd positions in the complex have degree  $i\bar{x} + j\bar{y} \bmod \bar{c}$ , so by Lemma 3.2.2(i) they lie in  $(x^i, y^j)$  and therefore vanish. The same holds in even positions after rewriting the degree  $(i+1)\bar{x} + (j+1)\bar{y} \bmod \bar{c}$  as  $(i+1-p)\bar{x} + j\bar{y} \bmod \bar{c}$ .

In the other direction,  $\mathrm{Hom}^\bullet({}^{i,j}K_0, K_w)$  is the cohomology of the complex

$$\begin{array}{ccccccc} & & \xrightarrow{xy^{q-j}} & & \xrightarrow{y^j} & & \\ & & (R/(w))_{-\bar{c}-\bar{x}-\bar{y}} & \rightarrow & (R/(w))_{-\bar{x}-(j+1)\bar{y}} & \rightarrow & (R/(w))_{-\bar{x}-\bar{y}} \\ & \nearrow & & \searrow & & \nearrow & \\ \cdots & \oplus & & \oplus & & \oplus & \cdots \\ & \searrow & & \nearrow & & \searrow & \\ & & (R/(w))_{-(i+1)\bar{x}-(j+1)\bar{y}} & \xrightarrow{y^j} & (R/(w))_{-(i+1)\bar{x}-\bar{y}} & \xrightarrow{xy^{q-j}} & (R/(w))_{\bar{c}-(i+1)\bar{x}-(j+1)\bar{y}} \end{array}$$

For each  $m$ ,  $\mathrm{Hom}^{2m}({}^{i,j}K_0, K_w)$  is therefore given by

$$\mathrm{Ker} \begin{pmatrix} xy^{q-j} & x^i \\ -x^{p-i}y & y^j \end{pmatrix} \quad \text{modulo} \quad \mathrm{Im} \begin{pmatrix} y^j & -x^i \\ x^{p-i}y & xy^{q-j} \end{pmatrix}$$



in  $(R/(w))_{(m-1)\bar{c}-\bar{x}-\bar{y}} \oplus (R/(w))_{m\bar{c}-l}$ . Ignoring gradings for a second, this kernel is spanned by those  $f, g$  in  $R$  such that there exist  $h, k$  in  $R$  with

$$xy^{q-j}f + x^i g = (x^{p-1} + y^{q-1})h \quad \text{and} \quad -x^{p-i}yf + y^j g = (x^{p-1} + y^{q-1})k.$$

Subtracting  $x^i$  times the latter from  $y^j$  times the former we see that  $h = xh'$  and  $k = yk'$  for some polynomials  $h'$  and  $k'$ , and that  $f = y^{j-1}h' - x^{i-1}k'$ . Plugging this back in gives  $g = x^{p-i}h' + y^{q-j}k'$ , so  $\text{Hom}^{2m}(i, j K_0, K_w)$  is parametrised by

$$\begin{pmatrix} y^{j-1} & -x^{i-1} \\ x^{p-i} & y^{q-j} \end{pmatrix} \begin{pmatrix} h' \\ k' \end{pmatrix} \quad \text{modulo} \quad \text{Im} \begin{pmatrix} y^j & -x^i \\ x^{p-i}y & xy^{q-j} \end{pmatrix} \quad (\text{and modulo } w),$$

with  $h' \in R_{(m-2)\bar{c}+(q-j)\bar{y}}$  and  $k' \in R_{(m-2)\bar{c}+(p-i)\bar{x}}$ . It is clear from this description that  $h'$  and  $k'$  only matter modulo  $(y, w) = (y, x^{p-1})$  and  $(x, w) = (x, y^{q-1})$ , but  $h'$  and  $k'$  must lie in these ideals by Lemma 3.2.2(i), so we conclude that  $\text{Hom}^{2m}(i, j K_0, K_w)$  vanishes.

Similarly,  $\text{Hom}^{2m+1}(i, j K_0, K_w)$  is parametrised by

$$\begin{pmatrix} y^{q-j-1} & x^i \\ -x^{p-i-1} & y^j \end{pmatrix} \begin{pmatrix} h' \\ k' \end{pmatrix} \quad \text{modulo} \quad \text{Im} \begin{pmatrix} xy^{q-j} & x^i \\ -x^{p-i}y & y^j \end{pmatrix} \quad (\text{and } w),$$

with  $h' \in R_{m\bar{c}-\bar{x}-(j+1)\bar{y}}$  and  $k' \in R_{m\bar{c}-(i+1)\bar{x}-\bar{y}}$ . Since  $k'$  can be eliminated and we're left with

$$\text{Hom}^{2m+1}(i, j K_0, K_w) \simeq (R/(xy, w))_{(m-1)\bar{c}} \begin{pmatrix} y^{q-j-1} \\ -x^{p-i-1} \end{pmatrix},$$

and by Lemma 3.2.3  $(R/(xy, w))_{(m-1)\bar{c}}$  has only constants. The upshot is:

**Lemma 3.2.10.** *In  $\text{HMF}(\mathbb{A}^2, \Gamma_w, \mathbf{w})$  the only morphisms between  $K_w$  and  $i, j K_0$  are from the latter to the former, spanned by  $(y^{q-j-1}, -x^{p-i-1})$  in degree 3 in the above complex.*

### 3.2.6 Morphisms between $K_x$ 's and $K_y$ 's and $K_0$ 's

For each  $I$  we have that  $\text{Hom}^\bullet({}^I K_x, {}^{i,j} K_0)$  vanishes since again the whole complex is zero by Lemma 3.2.2(i). Morphisms the other way are computed by the complex

$$\begin{array}{ccccccc}
 & & (R/(x))_{-2\bar{c}+I\bar{x}} & \xrightarrow{xy^{q-j}} & (R/(x))_{-\bar{c}+I\bar{x}-j\bar{y}} & \xrightarrow{y^j} & (R/(x))_{-\bar{c}+I\bar{x}} \\
 & & \searrow^{-x^{p-i}y} & & \searrow^{x^{p-i}y} & & \\
 \cdots & \oplus & & & \oplus & & \oplus & \cdots \\
 & & \nearrow^{x^i} & & \nearrow^{-x^i} & & \\
 & & (R/(x))_{-\bar{c}+(I-i)\bar{x}-j\bar{y}} & \xrightarrow{y^j} & (R/(x))_{-\bar{c}+(I-i)\bar{x}} & \xrightarrow{xy^{q-j}} & (R/(x))_{(I-i)\bar{x}-j\bar{y}}
 \end{array}$$

All differentials vanish except  $y^j$ , which is injective, so we get

$$\begin{aligned}
 \text{Hom}^{2m}({}^{i,j} K_0, {}^I K_x) &\simeq (R/(x, y^j))_{(m-2)\bar{c}+I\bar{x}}, \\
 \text{Hom}^{2m+1}({}^{i,j} K_0, {}^I K_x) &\simeq (R/(x, y^j))_{(m-1)\bar{c}+(I-i)\bar{x}}.
 \end{aligned}$$

The former is zero by Lemma 3.2.2(i), whilst the latter is zero unless  $I = i$ , when it contains only constants, by the argument used in the proof of Lemma 3.2.4. From this we get:

**Lemma 3.2.11.** *In  $\text{HMF}(\mathbb{A}^2, \Gamma_{\mathbf{w}}, \mathbf{w})$  there are no morphisms from  ${}^I K_x$  to  ${}^{i,j} K_0$ . There are no morphisms in the other direction unless  $I = i$ , in which case the morphism space is spanned by  $(0, 1)$  in degree 3 in the above complex. Similarly for morphisms between  ${}^J K_y$  and  ${}^{i,j} K_0$ .*

### 3.2.7 Morphisms between $K_0$ 's

The complex computing  $\text{Hom}^\bullet({}^{i,j} K_0, {}^{I,J} K_0)$  is

$$\begin{array}{ccccccc}
 & & (R/(x^I, y^J))_{-\bar{c}+I\bar{x}+J\bar{y}} & \xrightarrow{xy^{q-j}} & (R/(x^I, y^J))_{I\bar{x}+(J-j)\bar{y}} & \xrightarrow{y^j} & (R/(x^I, y^J))_{I\bar{x}+J\bar{y}} \\
 & & \searrow^{-x^{p-i}y} & & \searrow^{x^{p-i}y} & & \\
 \cdots & \oplus & & & \oplus & & \oplus & \cdots \\
 & & \nearrow^{x^i} & & \nearrow^{-x^i} & & \\
 & & (R/(x^I, y^J))_{(I-i)\bar{x}+(J-j)\bar{y}} & \xrightarrow{y^j} & (R/(x^I, y^J))_{(I-i)\bar{x}+J\bar{y}} & \xrightarrow{xy^{q-j}} & (R/(x^I, y^J))_{\bar{c}+(I-i)\bar{x}+(J-j)\bar{y}}
 \end{array}$$

By Lemma 3.2.2(i) all of the terms vanish except the bottom term in the even positions, giving

$$\begin{aligned}\mathrm{Hom}^{2m}({}^{i,j}K_0, {}^{I,J}K_0) &\simeq (R/(x^I, y^J))_{(I-i)\vec{x}+(J-j)\vec{y}}, \\ \mathrm{Hom}^{2m+1}({}^{i,j}K_0, {}^{I,J}K_0) &= 0.\end{aligned}$$

If  $I < i$  then we can rewrite  $(I-i)\vec{x} + (J-j)\vec{y}$  as  $(p+I-i)\vec{x} + (J-j+1)\vec{y}$  modulo  $\vec{c}$  and apply Lemma 3.2.2(i) to see that  $\mathrm{Hom}^{2m}$  vanishes. Likewise if  $J < j$ .

Now assume that  $I \geq i$  and  $J \geq j$ . By Lemma 3.2.2(i), any element of degree  $(I-i)\vec{x} + (J-j)\vec{y} \bmod \vec{c}$  is divisible by  $x^{I-i}y^{J-j}$  modulo  $(x^I, y^J)$ . So we can rewrite  $\mathrm{Hom}^{2m}$  as

$$(R/(x^i, y^j))_0 \cdot x^{I-i}y^{J-j},$$

and by Lemma 3.2.3 the only surviving term is  $\mathbb{C} \cdot x^{I-i}y^{J-j}$ . We deduce:

**Lemma 3.2.12.** *For all  $(i, j)$  and  $(I, J)$  we have that*

$$\mathrm{Hom}^\bullet({}^{i,j}K_0, {}^{I,J}K_0) \simeq \begin{cases} \mathbb{C} \cdot x^{I-i}y^{J-j} & \text{if } I \geq i, J \geq j \text{ and } \bullet = 0 \\ 0 & \text{otherwise.} \end{cases}$$

### 3.2.8 The total endomorphism algebra of the basic objects

Combining the results of Sections 3.2.3 to 3.2.7, we see that, in  $\mathrm{HMF}(\mathbb{A}^2, \Gamma_{\mathbf{w}}, \mathbf{w})$ , the basic objects  ${}^iK_x$ ,  ${}^jK_y$ ,  $K_w$  and  ${}^{i,j}K_0$  are all exceptional, and that the morphisms between distinct objects are spanned by:

- $(0, 1)$  in degree 3 from each  ${}^{i,j}K_0$  to  ${}^iK_x$
- $(0, 1)$  in degree 3 from each  ${}^{i,j}K_0$  to  ${}^jK_y$
- $(y^{q-j-1}, -x^{p-i-1})$  in degree 3 from each  ${}^{i,j}K_0$  to  $K_w$
- $x^{I-i}y^{J-j}$  in degree 0 from  ${}^{i,j}K_0$  to  ${}^{I,J}K_0$  whenever  $I \geq i$  and  $J \geq j$ .

We immediately see that morphisms between the  ${}^{i,j}K_0$  compose in the obvious way so that their total endomorphism algebra is the tensor product  $A_{p-1} \otimes A_{q-1}$  of the

path algebras of the  $A_{p-1}$ - and  $A_{q-1}$ -quivers (this is the path algebra of the obvious product quiver subject to the relations which say that the squares commute). In fact, we have:

**Theorem 3.2.13.** *The cohomology-level total endomorphism algebra of the objects  ${}^i K_x[3]$ ,  ${}^j K_y[3]$ ,  $K_w[3]$  and  ${}^{i,j} K_0$  in  $\mathcal{B}$  is the path algebra of the quiver-with-relations described in Figure 3.1, with all arrows living in degree zero. In particular,  $\mathcal{B}$  is a  $\mathbb{Z}$ -graded  $A_\infty$ -algebra concentrated in degree 0, so is intrinsically formal.*

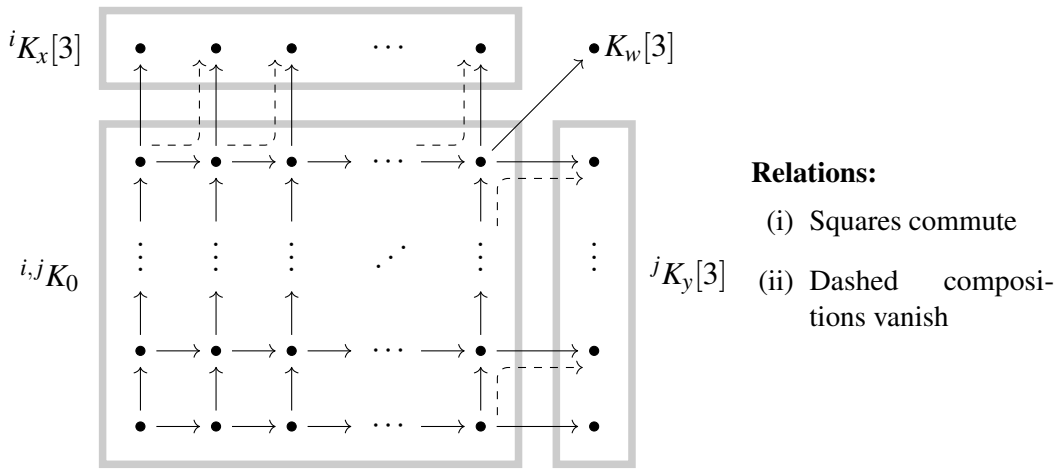

**Figure 3.1:** The quiver describing the category  $\mathcal{B}$  for loop polynomials.

*Proof.* To prove the cohomology statement we just need to check that the morphisms compose correctly, namely, that for  $I \geq i$  and  $J \geq j$ , the compositions

$$\begin{aligned} \text{Hom}^3({}^{I,J} K_0, K_w) \otimes \text{Hom}^0({}^{i,j} K_0, {}^{I,J} K_0) &\rightarrow \text{Hom}^3({}^{i,j} K_0, K_w), \\ \text{Hom}^3({}^{i,J} K_0, {}^i K_x) \otimes \text{Hom}^0({}^{i,j} K_0, {}^{i,J} K_0) &\rightarrow \text{Hom}^3({}^{i,j} K_0, {}^i K_x), \\ \text{Hom}^3({}^{I,j} K_0, {}^j K_y) \otimes \text{Hom}^0({}^{i,j} K_0, {}^{I,j} K_0) &\rightarrow \text{Hom}^3({}^{i,j} K_0, {}^j K_y) \end{aligned}$$

send generators to generators. This is immediate from the explicit descriptions of the morphisms above after noting that the generator

$$R((i+1)\vec{x} + (j+1)\vec{y}) / (x^i, y^j) \xrightarrow{x^I y^{J-j}} R((I+1)\vec{x} + (J+1)\vec{y}) / (x^I, y^J)$$

of  $\text{Hom}^0({}^{i,j}K_0, {}^{l,j}K_0)$  induces the maps

$$\begin{pmatrix} 1 & 0 \\ 0 & x^{J-i}y^{J-j} \end{pmatrix} \text{ in even degree and } \begin{pmatrix} y^{J-j} & 0 \\ 0 & x^{J-i} \end{pmatrix} \text{ in odd degree}$$

between the matrix factorisations (the degree 3 matrix is the only one we actually need).

The final claim, about the  $A_\infty$ -structure, follows from the fact that a directed algebra concentrated in degree zero is formal – there is no room for non-trivial higher  $A_\infty$ -operations.  $\square$

**Remark 3.2.14.** *This is an example of a collection which was subsequently constructed by Kravets ([Kra19]). The extension to three variables is also a direct computation.*

### 3.2.9 Generation

We have now computed the quasi-isomorphism type of the full  $A_\infty$ -subcategory  $\mathcal{B} \subset \text{mf}(\mathbb{A}^2, \Gamma_{\mathbf{w}}, \mathbf{w})$  on the basic objects  ${}^iK_x, {}^jK_y, K_w, {}^{i,j}K_0$ . The goal of this subsection is to prove:

**Proposition 3.2.15.** *The functor*

$$\Pi(\text{Tw } \mathcal{B}) \rightarrow \Pi(\text{mf}(\mathbb{A}^2, \Gamma_{\mathbf{w}}, \mathbf{w}))$$

*is a quasi-equivalence, where  $\Pi$  denotes  $A_\infty$ - (or dg-) idempotent completion.*

**Remark 3.2.16.** *As mentioned in Section 3.1.1, the  $\Pi$ 's can be removed from this statement (and this is what we need to prove Theorem 3.1.1) using the fact that the objects in  $\mathcal{B}$  form a full exceptional collection in  $\text{Tw } \mathcal{B}$ , so that the category is already idempotent complete by [Sei08b, Remark 5.14].*

For a triangulated category  $\mathcal{C}$  and a collection  $V$  of objects in  $\mathcal{C}$ , let  $\langle V \rangle$  denote the smallest full triangulated subcategory of  $\mathcal{C}$  which contains the objects in  $V$  and is closed under isomorphism, and let superscript  $\pi$  denote idempotent completion.

We'll say that  $V$  *split-generates*  $\mathcal{C}$  if the functor  $\langle V \rangle^\pi \rightarrow \mathcal{C}^\pi$  induced by the obvious inclusion of  $\langle V \rangle$  in  $\mathcal{C}$  is an equivalence.

The content of Proposition 3.2.15 is that the set

$$V = \{ {}^i K_x, {}^j K_y, K_w, {}^{i,j} K_0 \}$$

split-generates  $\mathcal{C} = \text{HMF}(\mathbb{A}^2, \Gamma_{\mathbf{w}}, \mathbf{w})$ . The key to establishing this is the following application of a result of Polishchuk–Vaintrob:

**Lemma 3.2.17** ([PV16, Proposition 2.3.1]). *The category  $\text{HMF}(\mathbb{A}^2, \Gamma_{\mathbf{w}}, \mathbf{w})$  is split-generated by the  $L$ -grading shifts of the stabilisation of the module  $R/(x, y)$ .*

**Remark 3.2.18.** *The cited result is a simple modification of the non-equivariant case, previously obtained by several authors including Schoutens [Sch03], Dyckerhoff [Dyc11, Corollary 5.3], Seidel [Sei11, Lemma 12.1] (building on work of Orlov [Orl11]), and Murfet [KMVdB11, Proposition A.2].*

*Proof of Proposition 3.2.15.* By Lemma 3.2.17 it suffices to show that under the equivalence (3.1) the category  $\langle V \rangle$  contains all of the  $L$ -grading shifts of  $R/(x, y)$ . In other words, it is enough to prove that for all  $l$  in  $L$  the  $L$ -graded  $R$ -module  $R(l)/(x, y)$  can be built from the objects

$$R((i+1-p)\vec{x})/(x), R((j+1-q)\vec{y})/(y), R/(w), \text{ and } R((i+1)\vec{x} + (j+1)\vec{y})/(x^i, y^j)$$

with  $1 \leq i \leq p-1$  and  $1 \leq j \leq q-1$ , by taking cones and shifts (in the triangulated category sense, rather than in the  $L$ -grading). Since [2] is equivalent to  $(\vec{c})$ , we actually only need consider  $l$  in a set of representatives of  $L/\mathbb{Z}\vec{c}$ .

For any  $1 \leq i \leq p-1$  and  $1 \leq j \leq q-1$  we have a morphism (of  $L$ -graded  $R$ -modules)

$$R(i\vec{x} + j\vec{y})/(x^{i-1}, y^{j-1}) \xrightarrow{x} R((i+1)\vec{x} + j\vec{y})/(x^i, y^{j-1}) \quad (3.3)$$

whose cone – which is just the cokernel in this case – is the module  $R((i+1)\vec{x} + j\vec{y})/(x, y^{j-1})$ . Both objects in (3.3) lie in  $V$  unless  $i$  or  $j$  is 1, in which case the

offending objects are zero, so we conclude that this cone lies in  $\langle V \rangle$ . Similarly  $R((i+1)\vec{x} + (j+1)\vec{y})/(x, y^j)$  is in  $\langle V \rangle$ , and hence

$$R((i+1)\vec{x} + (j+1)\vec{y})/(x, y) \simeq \text{Cone} \left( R((i+1)\vec{x} + j\vec{y})/(x, y^{j-1}) \xrightarrow{y} R((i+1)\vec{x} + (j+1)\vec{y})/(x, y^j) \right)$$

is also in  $\langle V \rangle$ . This gives  $(p-1)(q-1)$  of the  $pq-1$  objects we need.

Next consider the extension

$$0 \rightarrow R((i+1)\vec{x} + \vec{y})/(x) \xrightarrow{y^j} R((i+1)\vec{x} + (j+1)\vec{y})/(x) \rightarrow R((i+1)\vec{x} + (j+1)\vec{y})/(x, y^j) \rightarrow 0.$$

The outer terms are in  $\langle V \rangle$  (the first is  ${}^i K_x[2]$  and the last is built from  $R(a\vec{x} + b\vec{y})/(x, y)$  for  $a = i+1$  and  $b = 2, 3, \dots, j+1$  by taking cones), so the middle term is in  $\langle V \rangle$ . In particular, taking  $j = q-1$  we see that

$$R(i\vec{x})/(x) = R((i+1)\vec{x} + q\vec{y})[-2]/(x)$$

lies in  $\langle V \rangle$ . If  $i$  is at least 2 then  $R(i\vec{x} + \vec{y})/(x) = {}^{i-1} K_x[2]$  is also in  $\langle V \rangle$ , and hence so is

$$R(i\vec{x} + \vec{y})/(x, y) \simeq \text{Cone} \left( R(i\vec{x})/(x) \xrightarrow{y} R(i\vec{x} + \vec{y})/(x) \right).$$

One can make a similar argument with the roles of  $x$  and  $y$  interchanged to construct  $R(\vec{x} + j\vec{y})/(x, y)$  when  $2 \leq j \leq p-1$ .

So far we have thus seen that  $R(a\vec{x} + b\vec{y})/(x, y)$  lies in  $\langle V \rangle$  for  $1 \leq a \leq p$  and  $1 \leq b \leq q$ , except for the cases  $(a, b) = (1, 1)$ ,  $(1, q)$  and  $(p, 1)$ . If we can fill in these missing three cases (the latter two are in fact equivalent – both correspond to  $R(\vec{c})/(x, y)$ ) then we will have constructed shifts of  $R/(x, y)$  by representatives of each class in  $L/\mathbb{Z}\vec{c}$ , and will therefore be done.

To build  $R(\vec{x} + \vec{y})/(x, y)$  note that it is the cokernel of

$$R(\vec{x})/(x) \oplus R(\vec{y})/(y) \xrightarrow{\binom{y}{x}} R(\vec{x} + \vec{y})/(xy).$$

The two summands in the domain were constructed above, whilst the codomain is

$K_w[1]$ . Finally, to get  $R(\vec{c})/(x, y)$  observe that  $R/(x, y)$  is the cokernel of

$$R(-\vec{y})/(x, y^{pq-2}) \xrightarrow{y} R/(x, y^{pq-1}). \quad (3.4)$$

The domain can be built from  $R(-b\vec{y})/(x, y)$  for  $b = 1, \dots, pq - 2$  by taking cones, and these objects are all (up to repeated applications of  $[\pm 2]$ ) ones that we have already constructed. The codomain, meanwhile, is given by

$$\text{Cone} \left( R(-(p-1)\vec{c})/(x) \xrightarrow{y^{pq-1}} R/(x) \right),$$

and the two terms inside the cone are  ${}^{p-1}K_x[-2(p-1)]$  and  ${}^{p-1}K_x$ . This means that both objects in (3.4) lie in  $\langle V \rangle$ , and hence so does the cokernel  $R/(x, y)$ . Shifting by  $[2]$  gives the object  $R(\vec{c})/(x, y)$  that we need.  $\square$

**Remark 3.2.19.** We proved that  $\mathcal{B}$  generates  $\text{mf}(\mathbb{A}^2, \Gamma_{\mathbf{w}}, \mathbf{w})$  by showing that it generates the objects  $R(l)/(x, y)$ , which split-generate the category, and then invoking the fact that  $\text{Tw } \mathcal{B}$  is idempotent complete. The  $R(l)/(x, y)$  themselves cannot possibly generate (as opposed to split-generate), for the following reason:  $\text{mf}(\mathbb{A}^2, \Gamma_{\mathbf{w}}, \mathbf{w})$  has a full exceptional collection of size  $pq$ , so its Grothendieck group is free of rank  $pq$ , whereas the span of the  $R(l)/(x, y)$  has rank at most  $|L/\mathbb{Z}\vec{c}| = pq - 1$ .

As a corollary of Proposition 3.2.15, we obtain:

**Theorem 3.2.20** (Theorem 3.1.1, loop polynomial case). *The object*

$$\mathcal{E} := \left( \bigoplus_{\substack{i=1, \dots, p-1 \\ j=1, \dots, q-1}} {}^{i,j}K_0 \right) \oplus \left( \bigoplus_{i=1}^{p-1} {}^iK_x[3] \right) \oplus \left( \bigoplus_{j=1}^{q-1} {}^jK_y[3] \right) \oplus K_w[3]$$

is a tilting object for  $\text{mf}(\mathbb{A}^2, \Gamma_{\mathbf{w}}, \mathbf{w})$ .

*Proof.* We need to show that  $\text{End}^i(\mathcal{E}) = 0$  for all  $i \neq 0$  and that  $\text{hom}^\bullet(\mathcal{E}, X) \simeq 0$  implies  $X \simeq 0$ . The first statement follows immediately from Theorem 3.2.13, whilst the second is a consequence of Proposition 3.2.15: if  $\text{hom}^\bullet(\mathcal{E}, X) \simeq 0$  then there are no non-zero morphisms from  $\langle V \rangle^\pi$  to  $X$  in  $\text{HMF}(\mathbb{A}^2, \Gamma_{\mathbf{w}}, \mathbf{w})$ , which forces  $X$  to be quasi-isomorphic to 0.  $\square$



**Remark 3.2.21.** *As mentioned in the introduction, the existence of this tilting object defines an equivalence*

$$\mathrm{mf}(\mathbb{A}^2, \Gamma_{\mathbf{w}}, \mathbf{w}) \simeq D^b(\mathrm{end}(\mathcal{E})^{op}).$$

*This forms basis of our strategy for proving homological mirror symmetry. In particular, the proof follows by showing that the tilting object which is known to exist on the A-side precisely matches  $\mathcal{E}$ .*

### 3.3 A-model for loop polynomials

#### 3.3.1 A resonant Morsification

We are now interested in the polynomial  $\check{\mathbf{w}} = \check{x}^p \check{y} + \check{x} \check{y}^q$  as a map  $\mathbb{C}^2 \rightarrow \mathbb{C}$ . To construct the category  $\mathcal{A}$  we should Morsify  $\check{\mathbf{w}}$  by adding a small perturbation, fix a regular value  $*$ , then pick a *distinguished basis of vanishing paths*  $(\gamma_1, \dots, \gamma_N)$  in the base  $\mathbb{C}$ , where  $\gamma_i$  is a smooth embedded path from  $*$  the  $i^{\mathrm{th}}$  critical value. We require that the  $\gamma_i$  are pairwise disjoint except for their common initial point  $\gamma_i(0) = *$ , that the vectors  $\dot{\gamma}_i(0)$  in  $T_*\mathbb{C}$  are non-zero and distinct, and that the corresponding directions are in clockwise order as  $i$  increases from 1 to  $N$  (we are free to choose the starting direction for this clockwise ordering). We then consider the corresponding vanishing cycles in the fibre  $\Sigma$  over  $*$  (strictly we should take  $\Sigma$  to be the Liouville completion of the Milnor fibre, but this is equivalent in our case), and define  $\mathcal{A}$  to be the directed  $A_\infty$ -category on these cycles whose morphisms and compositions in the allowed direction are given by those in the compact Fukaya category  $\mathcal{F}(\Sigma)$ . Note that we are free to modify the vanishing cycles by Hamiltonian isotopy in order to compute  $\mathcal{A}$  up to quasi-equivalence.

In order to implement this, we first consider the perturbation

$$\check{\mathbf{w}}_\varepsilon := \check{\mathbf{w}} - \varepsilon \check{x} \check{y} = \check{x} \check{y} (\check{x}^{p-1} + \check{y}^{q-1} - \varepsilon)$$

of  $\check{\mathbf{w}}$ , where  $\varepsilon$  is a small positive real number; in analogy with Section 3.2 we shall denote  $\check{x}^{p-1} + \check{y}^{q-1}$  by  $\check{w}$ . We call this a resonant Morsification, since its critical

points are Morse but the critical values are not all distinct. In fact, the critical points fall into four types:

$$(i) \quad \check{x}^{p-1} = \varepsilon, \check{y} = 0$$

$$(ii) \quad \check{x} = 0, \check{y}^{q-1} = \varepsilon$$

$$(iii) \quad \check{x} = \check{y} = 0$$

$$(iv) \quad (\check{x}^{p-1}, \check{y}^{q-1}) = \frac{\varepsilon}{pq-1}(q-1, p-1).$$

The critical points of the types (i)–(iii) all lie over the critical value zero, whilst for type (iv) the critical value is  $-\check{x}\check{y}\varepsilon(p-1)(q-1)/(pq-1)$  so is non-zero and lies on the ray through  $-\check{x}\check{y}$ .

We denote the unique positive real critical point of type (iv) by  $(\check{x}_{\text{crit}}^+, \check{y}_{\text{crit}}^+)$ , with corresponding critical value  $c_{\text{crit}}$  (this is *negative* real). Letting  $\zeta$  and  $\eta$  denote the roots of unity

$$\zeta = e^{2\pi\sqrt{-1}/(p-1)} \quad \text{and} \quad \eta = e^{2\pi\sqrt{-1}/(q-1)},$$

the full set of type (iv) critical points is then given by

$$\{(\zeta^l \check{x}_{\text{crit}}^+, \eta^m \check{y}_{\text{crit}}^+) : 0 \leq l \leq p-2, 0 \leq m \leq q-2\}.$$

The critical value corresponding to  $(\zeta^l \check{x}_{\text{crit}}^+, \eta^m \check{y}_{\text{crit}}^+)$  is  $\zeta^l \eta^m c_{\text{crit}}$ , so there are  $\gcd(p-1, q-1)$  critical points in each of these critical fibres.

We now fix our regular fibre  $\Sigma$  to be  $\check{\mathbf{w}}_\varepsilon^{-1}(-\delta)$ , where  $\delta$  is a positive real number much less than  $\varepsilon$  (in other words, we take  $* = -\delta$ ). The condition  $\delta \ll \varepsilon$  is to allow us to understand  $\Sigma$  as a smoothing of  $\check{\mathbf{w}}_\varepsilon^{-1}(0)$ . For the critical points of types (i)–(iii) we choose the vanishing path given by the straight line segment from  $-\delta$  to 0. For the critical point  $(\zeta^l \check{x}_{\text{crit}}^+, \eta^m \check{y}_{\text{crit}}^+)$ , meanwhile, we define the *preliminary vanishing path*  $\gamma_{l,m}$  by following the circular arc  $-\delta e^{\sqrt{-1}\theta}$  as  $\theta$  increases from 0 to

$$\theta_{l,m} := 2\pi \left( \frac{l}{p-1} + \frac{m}{q-1} \right)$$

and then following the radial straight line segment from  $-\zeta^l \eta^m \delta$  to  $\zeta^l \eta^m c_{\text{crit}}$ . As the name suggests, we will later modify these preliminary vanishing paths (they currently do not form a distinguished basis since they intersect and overlap each other), but they serve an important intermediate role.

Figure 3.2 shows the critical values of  $\check{w}_\varepsilon$ , the vanishing path for the type (i)–(iii) critical points, and the preliminary vanishing paths for  $(l, m) = (0, 0)$ ,  $(1, 0)$  and  $(1, 2)$ , all in the case  $(p, q) = (4, 6)$ . We have slightly separated the arcs for clarity – really they both have radius  $\delta$ . Note that  $\theta_{l,m}$  may be greater than  $2\pi$ , in

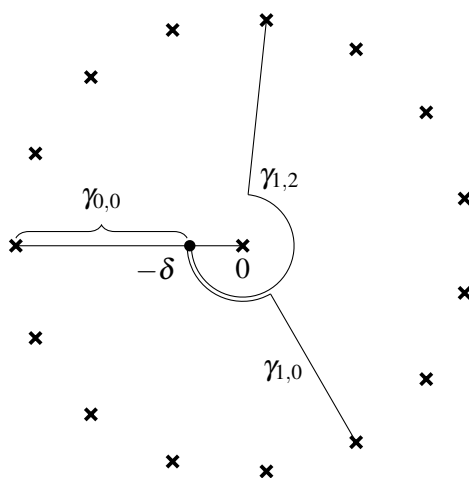
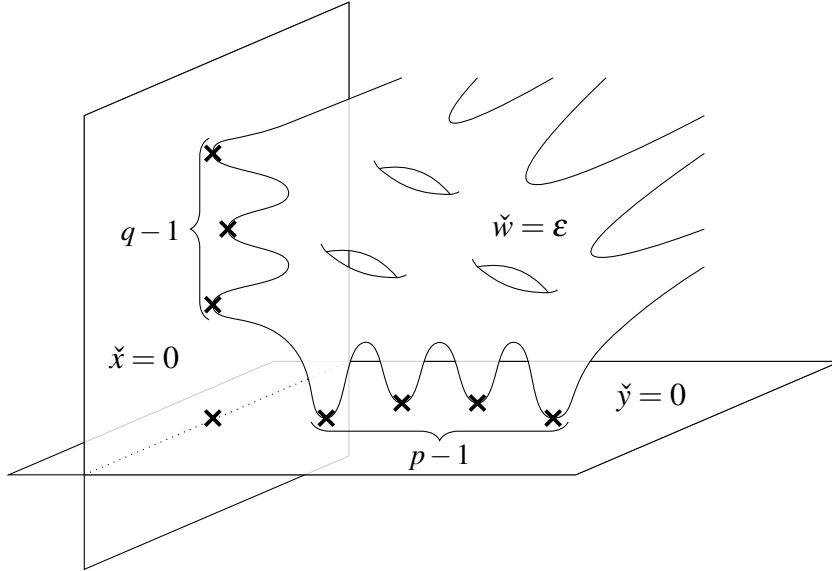

**Figure 3.2:** The critical values of  $\check{w}_\varepsilon$  (crosses), the vanishing path for critical value 0, and three of the preliminary vanishing paths, when  $(p, q) = (4, 6)$ .

which case  $\gamma_{l,m}$  covers more than a full circle, but these paths are difficult to indicate on a diagram. Note also that different values of  $(l, m)$  may give rise to different preliminary vanishing paths, even if the critical values are the same.

### 3.3.2 The zero-fibre and its smoothing $\Sigma$

The fibre of  $\check{w}_\varepsilon$  over zero has three components: the lines  $\{\check{x} = 0\}$  and  $\{\check{y} = 0\}$ , and the smooth curve  $\{\check{w} = \varepsilon\}$ . Schematically the picture is as in Figure 3.3. The crosses denote transverse intersections between the components, and the dotted line where the planes appear to meet is to indicate that they are actually disjoint in  $\mathbb{C}^2$  except for the intersection at the origin. In  $\Sigma$ , each of the nodes is smoothed to a thin neck whose waist curve is the corresponding vanishing cycle. We denote these vanishing cycles by  ${}^l V_{\check{y}\check{w}}$ ,  ${}^m V_{\check{x}\check{w}}$  and  $V_{\check{x}\check{y}}$  for  $l = 0, \dots, p - 2$  and  $m = 0, \dots, q - 2$ , corresponding



**Figure 3.3:** The fibre  $\check{w}_\epsilon^{-1}(0)$  for loop polynomials.

to critical points  $(\zeta^l \epsilon^{1/(p-1)}, 0)$ ,  $(0, \eta^m \epsilon^{1/(q-1)})$  and  $(0, 0)$  respectively.

**Remark 3.3.1.** We can compute the genus and number of punctures of  $\Sigma$  as follows. The punctures correspond to boundary components at infinity, where the defining equation looks like  $\check{x}^p \check{y} + \check{x} \check{y}^q = 0$ . The lines  $\{\check{x} = 0\}$  and  $\{\check{y} = 0\}$  each give rise to a boundary component, whilst  $\{\check{x}^{p-1} + \check{y}^{q-1} = 0\}$  gives  $\gcd(p-1, q-1)$  components. We deduce

$$\# \text{ punctures of } \Sigma = \gcd(p-1, q-1) + 2.$$

The  $pq$  vanishing cycles form a basis for  $H_1(\Sigma)$ , whose rank is

$$2g(\Sigma) + \# \text{ punctures} - 1,$$

so we obtain

$$g(\Sigma) = \frac{1}{2} (pq - \gcd(p-1, q-1) - 1).$$

If  $\delta$  is chosen sufficiently small then the monodromy of parallel transport around the circle of radius  $\delta$  is supported in small neighbourhoods of these  $p+q-1$  curves, and is simply the product of the Dehn twists in them. It is not *strictly* true that the monodromy is supported in these neighbourhoods, but as explained in [Sei97, Section 19] it can be made so by a small deformation of the fibration, which does

not affect the categories and which we will not explicitly notate. After deleting these neighbourhoods (and corresponding neighbourhoods in the other fibres) we may therefore trivialise the fibration  $\check{w}_\varepsilon$  over the disc of radius  $\delta$ , and identify each fibre with the curve  $\Sigma'$  obtained from  $\check{w}_\varepsilon^{-1}(0)$  by removing neighbourhoods of the critical points marked in Figure 3.3. Equivalently, we may think of  $\Sigma'$  as being obtained from  $\Sigma$  by removing the neck regions. Concretely, it consists of: a complex line (the  $\check{x}$ -axis) with small balls around the origin and the  $(p-1)^{\text{th}}$  roots of  $\varepsilon$  removed; a complex line (the  $\check{y}$ -axis) with small balls around the origin and the  $(q-1)^{\text{th}}$  roots of  $\varepsilon$  removed; and a  $(p-1)(q-1)$ -fold cover of the line  $\{u+v=\varepsilon\}$  with small balls about  $(\varepsilon, 0)$  and  $(0, \varepsilon)$  removed, with the covering map given by  $(u, v) = (\check{x}^{p-1}, \check{y}^{q-1})$ . All of the interesting parallel transport occurs in the neck regions which we have deleted, and is described by ‘partial Dehn twists’ which we explicitly describe later in a local model.

### 3.3.3 The preliminary vanishing cycles

Let  ${}^{l,m}V_0^{\text{pr}}$  denote the preliminary vanishing cycle in  $\Sigma$  corresponding to the critical point  $(\zeta^l \check{x}_{\text{crit}}^+, \eta^m \check{y}_{\text{crit}}^+)$  and the preliminary vanishing path  $\gamma_{l,m}$ . The goal of this subsection is to describe these cycles by a combination of symmetry considerations and parallel transport computations.

Since  $\check{w}_\varepsilon$  has real coefficients, we can temporarily view it as a function  $\mathbb{R}^2 \rightarrow \mathbb{R}$ . This function has a local minimum at  $(\check{x}_{\text{crit}}^+, \check{y}_{\text{crit}}^+)$ , where it attains the value  $c_{\text{crit}} < 0$ . There are no critical values in the interval  $(c_{\text{crit}}, 0)$ , so the level sets  $\check{w}_\varepsilon^{-1}(c)$  for  $c$  in this range have a component which is a smooth loop encircling  $(\check{x}_{\text{crit}}^+, \check{y}_{\text{crit}}^+)$ , and which shrinks down to this point as  $c \searrow c_{\text{crit}}$ . As  $c \nearrow 0$  this loop, which we’ll denote by  $\Lambda_c$ , converges to the boundary of the region in the upper right quadrant of  $\mathbb{R}^2$  that is bounded on the left by  $\check{x} = 0$ , below by  $\check{y} = 0$ , and above and to the right by  $\check{w} = \varepsilon$ . We’ll denote this piecewise smooth limiting loop by  $\Lambda_0$ .

Now return from this purely real discussion to the full complex picture. Symplectic parallel transport between the fibres of  $\check{w}_\varepsilon$  over a path  $c(t)$  is described by

the ODE

$$\begin{pmatrix} \dot{\check{x}} \\ \dot{\check{y}} \end{pmatrix} = \frac{\dot{c}}{|\mathbf{d}\check{\mathbf{w}}_\varepsilon|^2} \begin{pmatrix} \overline{\partial_{\check{x}}\check{\mathbf{w}}_\varepsilon} \\ \overline{\partial_{\check{y}}\check{\mathbf{w}}_\varepsilon} \end{pmatrix}. \tag{3.5}$$

This obviously preserves the real part of the fibre when  $c$  moves along the real axis, as it did in the previous paragraph, so we see that the loops  $\Lambda_c$  are carried to one another by parallel transport. In particular,  $\Lambda_{-\delta}$  is exactly the preliminary vanishing cycle  ${}^{0,0}V_0^{\text{pr}}$ .

Just as we viewed  $\Sigma$  as a smoothing of  $\check{\mathbf{w}}_\varepsilon^{-1}(0)$ , we shall understand  ${}^{0,0}V_0^{\text{pr}} = \Lambda_{-\delta}$  as a smoothing of  $\Lambda_0$ . In  $\Sigma'$  it comprises: the real line segment joining the deleted ball about 0 to the deleted ball about  $\varepsilon^{1/(p-1)}$  in the  $\check{x}$ -axis; the real line segment joining the deleted ball about 0 to the deleted ball about  $\varepsilon^{1/(q-1)}$  in the  $\check{y}$ -axis; the positive real lift of the line segment joining the deleted balls about  $(\varepsilon, 0)$  and  $(0, \varepsilon)$  in  $\{u + v = \varepsilon\}$ , under the covering map  $(\check{x}, \check{y}) \mapsto (u, v)$  described above. It enters three of the neck regions, namely those corresponding to  ${}^0V_{\check{y}\check{w}}$ ,  ${}^0V_{\check{x}\check{w}}$  and  $V_{\check{x}\check{y}}$ , in each of which it is given by the positive real locus in  $(\check{x}, \check{y})$ -coordinates. This is indicated in Figure 3.4, where the deleted balls are indicated by the grey blobs and the three segments of  ${}^{0,0}V_0^{\text{pr}}$  are respectively the horizontal dash-dotted line, the vertical dotted line, and the dotted diagonal arc.

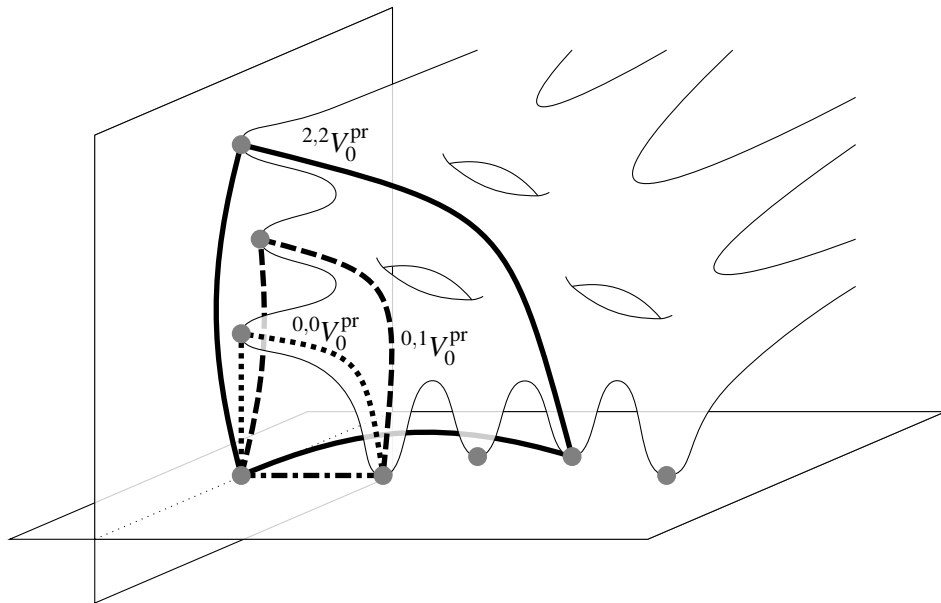

**Figure 3.4:** Schematic picture of some preliminary vanishing cycles in  $\Sigma'$  for loop polynomials.

To compute the other  ${}^{l,m}V_0^{\text{pr}}$ , we decompose the path  $\gamma_{l,m}$  into its radial segment and its circular arc. The map

$$f_{l,m} : (\check{x}, \check{y}) \mapsto (\zeta^l \check{x}, \eta^m \check{y})$$

gives a symplectomorphism of  $\mathbb{C}^2$  which  $\check{w}_\varepsilon$  intertwines with multiplication by  $\zeta^l \eta^m$  on  $\mathbb{C}$ , so the curve  $f_{l,m}({}^{0,0}V_0^{\text{pr}})$  is the vanishing cycle in the fibre over  $-\zeta^l \eta^m \delta$  that corresponds to the critical point  $(\zeta^l \check{x}_{\text{crit}}^+, \eta^m \check{y}_{\text{crit}}^+)$  and the vanishing path given by the radial segment of  $\gamma_{l,m}$ . This means that  ${}^{l,m}V_0^{\text{pr}}$  is obtained from  $f_{l,m}({}^{0,0}V_0^{\text{pr}})$  by parallel transporting around the circular arc of  $\gamma_{l,m}$ .

We can therefore immediately describe the part of  ${}^{l,m}V_0^{\text{pr}}$  lying in  $\Sigma'$ , since it is obtained from the corresponding part of  ${}^{0,0}V_0^{\text{pr}}$  by applying  $f_{l,m}$ . In full detail, it comprises: the radial line segment joining the deleted ball about 0 to the deleted ball about  $\zeta^l \varepsilon^{1/(p-1)}$  in the  $\check{x}$ -axis; the real line segment joining the deleted ball about 0 to the deleted ball about  $\eta^m \varepsilon^{1/(q-1)}$  in the  $\check{y}$ -axis; the lift to  $\zeta^l \mathbb{R}_+ \times \eta^m \mathbb{R}_+ \subset \mathbb{C}^2$  of the line segment joining the deleted balls about  $(\varepsilon, 0)$  and  $(0, \varepsilon)$  in  $\{u + v = \varepsilon\}$ , under the covering map  $(\check{x}, \check{y}) \mapsto (u, v)$ . This is shown in Figure 3.4, where  ${}^{2,2}V_0^{\text{pr}}$  is drawn in solid black and  ${}^{0,1}V_0^{\text{pr}}$  is drawn dashed (the segment along which it overlaps with  ${}^{0,0}V_0^{\text{pr}}$  is shown dash-dotted). The segments lying in the two coordinate axes should all really be straight, with the grey blobs lying on a circle about the origin, but we have deformed the picture in order to draw it in two dimensions.

To see what  ${}^{l,m}V_0^{\text{pr}}$  looks like in the three neck regions it meets, namely those corresponding to  ${}^lV_{\check{y}\check{w}}$ ,  ${}^mV_{\check{x}\check{w}}$  and  $V_{\check{x}\check{y}}$ , we simply have to take the  $(\zeta^l \mathbb{R}_+ \times \eta^m \mathbb{R}_+)$ -locus in each of these necks over  $-\zeta^l \eta^m \delta$  and parallel transport clockwise through angle  $\theta_{l,m}$  around the circle of radius  $\delta$ ; this is our next task. Near the critical point  $(0, 0)$ , where  $\check{x}$  and  $\check{y}$  are both small, we may approximate  $\check{w}_\varepsilon$  by  $-\varepsilon \check{x} \check{y}$ . This corresponds to the  $V_{\check{x}\check{y}}$ -neck region in  $\Sigma$ , and in this approximation the parallel transport equation (3.5) simplifies to

$$\begin{pmatrix} \dot{\check{x}} \\ \dot{\check{y}} \end{pmatrix} = \frac{-\dot{c}}{\varepsilon(|\check{x}|^2 + |\check{y}|^2)} \begin{pmatrix} \check{y} \\ \check{x} \end{pmatrix}. \quad (3.6)$$

We may also approximate the  $(\zeta^l \mathbb{R}_+ \times \eta^m \mathbb{R}_+)$ -locus in the  $V_{\check{x}\check{y}}$ -neck over  $-\zeta^l \eta^m \delta$  by the hyperbola

$$(\check{x}, \check{y}) = \sqrt{\delta/\varepsilon}(\zeta^l e^s, \eta^m e^{-s})$$

parametrised by a small real variable  $s$ . We want to parallel transport over the path  $c(t) = -\delta e^{\sqrt{-1}t}$  as  $t$  decreases from  $\theta_{l,m}$  to 0, and we postulate a solution of the form  $(\check{x}, \check{y}) = \sqrt{\delta/\varepsilon}(e^{s+\sqrt{-1}\varphi}, e^{-s+\sqrt{-1}(t-\varphi)})$  where  $\varphi$  is a real function of  $s$  and  $t$ .

Plugging this into (3.6) we obtain

$$\begin{pmatrix} \dot{\varphi} \check{x} \\ (1 - \dot{\varphi}) \check{y} \end{pmatrix} = \frac{\check{x} \check{y}}{|\check{x}|^2 + |\check{y}|^2} \begin{pmatrix} \check{y} \\ \check{x} \end{pmatrix},$$

so after imposing the initial condition  $\varphi(s, \theta_{l,m}) = 2\pi l / (p - 1)$  we get the unique solution

$$\varphi = \frac{2\pi l}{p-1} + \frac{e^{-2s}(t - \theta_{l,m})}{e^{2s} + e^{-2s}}. \quad (3.7)$$

In particular, the value of  $\varphi$  at the end of the parallel transport ( $t = 0$ ), which we denote by  $\varphi_{l,m}$ , is given by

$$\varphi_{l,m}(s) := \varphi(s, 0) = \frac{2\pi}{e^{2s} + e^{-2s}} \left( \frac{e^{2sl}}{p-1} - \frac{e^{-2sm}}{q-1} \right). \quad (3.8)$$

This is supposed to describe the argument of the  $\check{x}$ -component of  ${}^{l,m}V_0^{\text{pr}}$  (or minus the argument of the  $\check{y}$ -component) on the  $V_{\check{x}\check{y}}$ -neck region of  $\Sigma$ , and note that it is consistent with the description we already have on  $\Sigma'$ : when  $s$  becomes large this neck joins the  $\check{x}$ -axis, where we know that the  $\check{x}$ -component of  ${}^{l,m}V_0^{\text{pr}}$  has argument  $2\pi l / (p - 1)$ ; when  $s$  becomes small the neck joins the  $\check{y}$ -axis, where we know that  $\check{y}$ -component of  ${}^{l,m}V_0^{\text{pr}}$  has argument  $2\pi m / (q - 1)$ .

We can run analogous arguments on the other two necks that  ${}^{l,m}V_0^{\text{pr}}$  passes through. To combine this information into a visualisable format, note that we can coordinatise the union of the  $\check{x}$ -axis part of  $\Sigma'$  and the  $V_{\check{x}\check{y}}$ - and  $V_{\check{y}\check{w}}$ -necks by  $\check{x}$ . The  $\check{x}$ -projection of this region consists of the complex plane with a puncture at 0, a puncture at  $\zeta^l \check{x}_{\text{crit}}^+$ , and small balls about all other  $\zeta^j \check{x}_{\text{crit}}^+$  removed. Small balls



around the two punctures represent the two necks. Strictly speaking, the punctures are extremely tiny deleted balls, but we will not make this distinction.

Away from the two neck regions in this picture, we are simply on the  $\check{x}$ -axis part of  $\Sigma'$ , so  ${}^{l,m}V_0^{\text{pr}}$  is given by the radial segment connecting them. On the  $V_{\check{x}\check{y}}$ -neck, near the puncture at 0, the computation above shows that as we approach the puncture the argument of  $\check{x}$  interpolates from  $2\pi l/(p-1)$  to  $-2\pi m/(q-1)$ . We can do the same on the  ${}^lV_{\check{y}\check{w}}$  neck, near the puncture at  $\zeta^l\check{x}_{\text{crit}}^+$ , but now the local coordinate is  $\check{x}'$  where  $\check{x} = \zeta^l\check{x}_{\text{crit}}^+ - \check{x}'$ , and this time it is the argument of  $\check{x}'$  which interpolates from  $2\pi l/(p-1)$  to  $-2\pi m/(q-1)$  as we approach the puncture. The cases  $(l,m) = (1,0)$  and  $(l,m) = (1,1)$  with  $(p,q) = (4,3)$  are shown in Figure 3.5. We have drawn separate diagrams for the two choices of  $(l,m)$  since the cycles overlap along their central segment and so would be difficult to distinguish if drawn on top of each other. The dashed circles represent the boundaries of the deleted

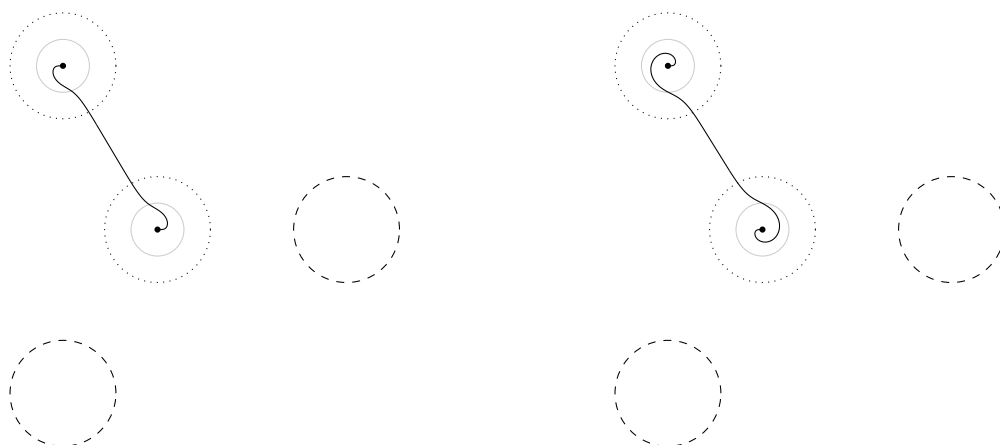

**Figure 3.5:** The  $\check{x}$ -projection of the preliminary vanishing cycles  ${}^{1,0}V_0^{\text{pr}}$  (left) and  ${}^{1,1}V_0^{\text{pr}}$  (right) in the  $\check{x}$ -axis part of  $\Sigma'$  and the  $V_{\check{x}\check{y}}$ - and  ${}^lV_{\check{y}\check{w}}$ -necks, with  $(p,q) = (4,3)$ .

balls, the dotted circles represent the boundaries of the neck regions, and the blobs represent the punctures. The faint solid circles are the waist curves  $V_{\check{x}\check{y}}$  and  ${}^lV_{\check{y}\check{w}}$ .

There is a corresponding picture for the  $\check{y}$ -projection of the  $\check{y}$ -axis part of  $\Sigma'$  and the  $V_{\check{x}\check{y}}$ - and  ${}^mV_{\check{x}\check{w}}$ -necks. The picture on  $\{\check{w} = \varepsilon\}$  part of  $\Sigma'$  is essentially uninteresting since the  ${}^{l,m}V_0^{\text{pr}}$  are pairwise disjoint there. This is because, on that part, the different  ${}^{l,m}V_0^{\text{pr}}$  are different lifts of the same segment in  $\{u+v = \varepsilon\}$ . Combining the pictures on these three parts of  $\Sigma$  gives a complete description of all of the

preliminary vanishing cycles.

**Remark 3.3.2.** *There are some obvious points to note here, which are clear parallels of the structure of the generating set on the B-side. First, the vanishing cycles  $V_{\check{x}\check{y}}$ ,  ${}^l V_{\check{y}\check{w}}$  and  ${}^m V_{\check{x}\check{w}}$  are all pairwise disjoint. Second, each  ${}^{l,m} V_0^{\text{pr}}$  intersects  $V_{\check{x}\check{y}}$  exactly once, transversely. Third,  ${}^{l,m} V_0^{\text{pr}}$  and  ${}^L V_{\check{y}\check{w}}$  intersect once, transversely, if  $l = L$  and are disjoint otherwise (similarly for  ${}^M V_{\check{x}\check{w}}$ ). And finally, if  $l \neq L$  and  $m \neq M$  then  ${}^{l,m} V_0^{\text{pr}}$  and  ${}^{L,M} V_0^{\text{pr}}$  are disjoint except on the  $V_{\check{x}\check{y}}$ -neck region, where (3.8) tells us that they intersect once, transversely, if  $l > L$  and  $m > M$  or vice versa, and are disjoint otherwise (as  $|\check{x}|$  increases, the difference in their  $\check{x}$ -arguments varies monotonically from  $2\pi(m - M)/(q - 1)$  to  $2\pi(L - l)/(p - 1)$ ).*

### 3.3.4 Modifying the vanishing paths

As already noted, the preliminary vanishing paths (plus the vanishing paths connecting  $-\delta$  to zero) do not form a distinguished basis of vanishing paths because they intersect and overlap each other. In this subsection, we describe how to remedy this, which also involves perturbing  $\check{w}$  to separate the critical values in such a way that the vanishing cycles are basically unaffected.

By plotting modulus and argument  $+\pi$ , we may view the preliminary paths  $\gamma_{l,m}$  as right-angled paths in  $\mathbb{R}^2$  from  $(\delta, 0)$  to  $(\delta, \theta_{l,m})$  to  $(-c_{\text{crit}}, \theta_{l,m})$ . We define modified paths  $\gamma'_{l,m}$  using this picture to be the piecewise linear paths as follows:

- From  $(\delta, 0)$  to  $(\delta + \delta', \theta_{l,m})$  to  $(-c_{\text{crit}}, \theta_{l,m})$  for some small positive  $\delta'$ , if  $\theta_{l,m} < 2\pi$ .
- From  $(\delta, 0)$  to  $(\delta + \delta', 2\pi + \lambda(\theta_{l,m} - 4\pi))$  to  $(\delta + 2\delta', 2\pi + \lambda(\theta_{l,m} - 4\pi))$  to  $(\delta + 3\delta', \theta_{l,m} - \theta')$  to  $(-c_{\text{crit}}, \theta_{l,m} - \theta')$  for some small positive  $\lambda$  and  $\theta'$ , if  $\theta_{l,m} \geq 2\pi$ .

In the second case, we have moved the end-point of the path so we correspondingly perturb the fibration so that the critical point  $(\zeta^l \check{x}_{\text{crit}}^+, \eta^m \check{y}_{\text{crit}}^+)$  has its critical value  $\zeta^l \eta^m c_{\text{crit}}$  rotated by  $e^{-\sqrt{-1}\theta'}$ . The paths are illustrated in the case  $(p, q) = (4, 6)$  in Figure 3.6. The faint lines are the preliminary paths  $\gamma_{l,m}$  and the dashed line is at

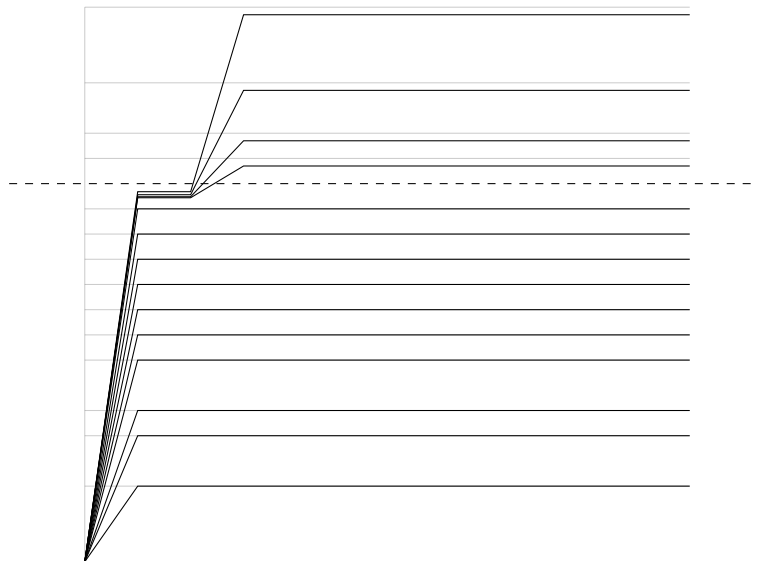

**Figure 3.6:** The paths  $\gamma'_{l,m}$  in modulus-(argument $+\pi$ ) space, when  $(p, q) = (4, 6)$ .

height  $2\pi$ .

This construction has the following key properties:

- The clockwise ordering of the tangent directions  $\dot{\gamma}'_{l,m}(0)$  is by decreasing value of  $\theta_{l,m}$ .
- If  $\theta_{l,m} = \theta_{L,M}$ , then  $\gamma'_{l,m} = \gamma'_{L,M}$ .
- If  $\theta_{l,m} \neq \theta_{L,M}$ , then  $\gamma'_{l,m}$  and  $\gamma'_{L,M}$  are disjoint unless  $\theta_{l,m} > \theta_{L,M} + 2\pi$  (or vice versa), in which case they intersect once, transversely, close to  $-\zeta^L \eta^M \delta$  (respectively  $-\zeta^l \eta^m \delta$ ).

The control on the position of the intersection point in the third property is the reason for the curious kink in the paths  $\gamma'_{l,m}$  for  $\theta_{l,m} \geq 2\pi$ . If we had instead taken these paths to be  $(\delta, 0)$  to  $(\delta + \delta', \theta_{l,m} - \theta')$  to  $(-c_{\text{crit}}, \theta_{l,m} - \theta')$  then the intersection between  $\gamma'_{l,m}$  and  $\gamma'_{L,M}$  when  $\theta_{l,m} > \theta_{L,M} + 2\pi$  would have occurred on the sloping regions of both paths, and therefore been awkward to locate.

Our next task is to explain how to modify those  $\gamma'_{l,m}$  for which  $\theta_{l,m} > 2\pi$  in order to remove the transverse intersections just described. The key observation is:

**Lemma 3.3.3.** *Suppose  $\theta_{l,m} > \theta_{L,M} + 2\pi$ , and let  $z$  denote the intersection point of  $\gamma'_{l,m}$  and  $\gamma'_{L,M}$ . Inside the fibre  $\Sigma_z = \check{\mathbf{w}}_\varepsilon^{-1}(z)$  there are vanishing cycles corresponding*

to the critical points  $(\zeta^l \check{x}_{\text{crit}}^+, \eta^m \check{y}_{\text{crit}}^+)$  and  $(\zeta^L \check{x}_{\text{crit}}^+, \eta^M \check{y}_{\text{crit}}^+)$  and the truncations of the vanishing paths  $\gamma'_{l,m}$  and  $\gamma'_{L,M}$ . Denoting these by  $V_1$  and  $V_2$  respectively, we have

$$V_1 \cap V_2 = \emptyset.$$

*Proof.* First note that if  $l \leq L$  then  $\theta_{l,m} - \theta_{L,M}$  is at most  $2\pi(q-2)/(q-1)$ , so we must have  $l > L$  and similarly  $m > M$ . By applying  $f_{L,M}^{-1}$  we may then assume without loss of generality that  $L = M = 0$  and  $l, m > 0$ . The former means that  $z$  is approximately  $-\delta$ , and that  $V_2 \subset \Sigma_z$  is approximately  ${}^{0,0}V_0^{\text{pr}} \subset \Sigma$ . The curve  $V_1$ , meanwhile, is constructed in approximately the same way as  ${}^{l,m}V_0^{\text{pr}}$  but with the parallel transport around the circle of radius  $\delta$  done from  $\theta_{l,m}$  to  $2\pi$ , rather than to 0. For the rest of the argument, we take these approximations to be exact. Since the cycles  $V_1$  and  $V_2$  are compact, once we show that they are disjoint after our small approximation we automatically deduce that they were disjoint before (compact and disjoint implies separated by a positive distance).

Since  $l$  and  $m$  are both positive we see that  $V_1$  and  $V_2 = {}^{0,0}V_0^{\text{pr}}$  are disjoint on  $\Sigma' \subset \Sigma$ , and that the only neck region that they both pass through is that corresponding to  $V_{\check{x}\check{y}}$ . This means that the only possible intersections occur in this neck, which we can coordinatise by projection to  $\check{x}$ . In this projection we know that  ${}^{0,0}V_0^{\text{pr}}$  and  $V_1$  are parametrised by

$$\check{x} = \sqrt{\delta/\varepsilon} e^s \quad \text{and} \quad \check{x} = \sqrt{\delta/\varepsilon} e^{s+\sqrt{-1}\varphi},$$

respectively, where  $\varphi$  is given by setting  $t = 2\pi$  in (3.7). It therefore suffices to show that this function  $\varphi$  never hits  $2\pi\mathbb{Z}$ . To prove this, simply note that the function is monotonically increasing from  $2\pi - 2\pi m/(q-1)$ , which is strictly positive, to  $2\pi l/(p-1)$ , which is strictly less than  $2\pi$ .  $\square$

Now, let  $\gamma''_{l,m}$  denote the path obtained from  $\gamma'_{l,m}$  by introducing a long thin finger which loops around the radial segment of  $\gamma'_{L,M}$ , for each  $(L, M)$  with  $\theta_{l,m} > \theta_{L,M} + 2\pi$ . Figure 3.7 illustrates  $\gamma''_{2,4}$  in the case  $(p, q) = (4, 6)$ . The faint lines show the paths  $\gamma'_{L,M}$  which we have had to loop around. In principle, each time we go around one

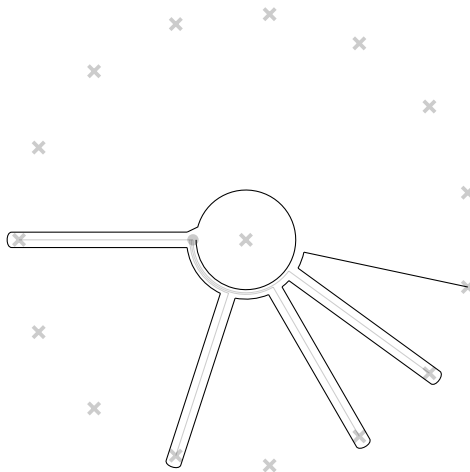

**Figure 3.7:** The path  $\gamma''_{2,4}$  when  $(p, q) = (4, 6)$ .

of the fingers the ‘intermediate vanishing cycle’  $V_1$  is changed by the monodromy around  $\zeta^L \eta^M c_{\text{crit}}$ , which is precisely the Dehn twist in  $V_2$  (or, more accurately, the product of the Dehn twists in all cycles constructed in the same way as  $V_2$  as  $(L, M)$  ranges over all pairs with the same value of  $\theta_{L,M}$ ), but by Lemma 3.3.3 this has no effect. We conclude that the vanishing cycles for the new paths  $\gamma''_{l,m}$  coincide with those of the previous paths  $\gamma'_{l,m}$ , which in turn are small perturbations of those of the preliminary paths  $\gamma_{l,m}$ . Note also that we can construct the new paths so as not to introduce any new intersections between them (for example, we can make sure the fingers for  $\gamma''_{2,3}$  go *outside* the fingers for  $\gamma''_{2,4}$  shown in Figure 3.7).

The upshot is that we now have vanishing paths  $\gamma''_{l,m}$ , plus the vanishing paths connecting  $-\delta$  to 0, which form a distinguished basis except for the fact that some of the paths coincide with each other. This is straightforwardly fixed by making a small perturbation of the fibration to separate the critical values, and corresponding small perturbations of the paths. The precise way in which this is done will affect the ordering of the paths, and hence the ordering of the vanishing cycles in  $\mathcal{A}$ , but this is irrelevant since the ambiguity is always between cycles which are disjoint and therefore orthogonal in the category.

We conclude:

**Proposition 3.3.4.** *There exists a Morsification of  $\check{\mathfrak{w}}$  and a distinguished basis of vanishing paths such that the corresponding vanishing cycles are arbitrarily small*

perturbations of the  ${}^{l,m}V_0^{\text{pr}}$ ,  ${}^lV_{\check{y}\check{w}}$ ,  ${}^mV_{\check{x}\check{w}}$  and  $V_{\check{x}\check{y}}$  as constructed above. The  ${}^{l,m}V_0^{\text{pr}}$  are ordered by decreasing value of  $\theta_{l,m}$ , and by choosing the starting direction for our clockwise ordering to be  $e^{\sqrt{-1}\theta}$ , for  $\theta$  a small positive angle, they occur before all of the other vanishing cycles.

### 3.3.5 Isotoping the vanishing cycles and computing the morphisms

Let us refer to the small perturbations of the preliminary vanishing cycles  ${}^{l,m}V_0$  that appear in Proposition 3.3.4 as *temporary* vanishing cycles. In order to compute the category  $\mathcal{A}$  we need to understand the intersection pattern of these temporary cycles. Some pairs of these cycles were already transverse before perturbing, as described in Remark 3.3.2 – in fact, all pairs except those of the form  ${}^{l,m}V_0^{\text{pr}}$ ,  ${}^{L,M}V_0^{\text{pr}}$  with  $l = L$  or  $m = M$  – so their intersections are unaffected by the small perturbations. For the non-transverse pairs of preliminary cycles, however, which actually overlap along segments, we cannot pin down the intersections of the corresponding temporary cycles without keeping more careful track of the perturbations, which is impractical.

In order to overcome this, we shall modify these problematic temporary cycles, which are small perturbations of the  ${}^{l,m}V_0^{\text{pr}}$ , by Hamiltonian isotopies to obtain *final* vanishing cycles  ${}^{l,m}V_0$  which we will use to compute  $\mathcal{A}$ . This does not affect the quasi-equivalence type of the category. These isotopies will be small in the absolute sense, and in particular will only affect intersections between pairs of cycles which were non-transverse before perturbing from preliminary to temporary, but will not be small compared with these perturbations. Indeed, their very point is to undo any uncertainty in the intersection pattern which these perturbations introduced.

**Remark 3.3.5.** *Since each waist curve  ${}^lV_{\check{y}\check{w}}$ ,  ${}^mV_{\check{x}\check{w}}$ , and  $V_{\check{x}\check{y}}$  was already transverse to all other cycles, the corresponding perturbed curve in Proposition 3.3.4 has the same intersection pattern. We therefore do not notationally distinguish between the waist curves and their perturbations.*

We only need to describe the isotopies on the regions where the preliminary cycles were non-transverse. This means that, for each  ${}^{l,m}V_0^{\text{pr}}$ , we may focus on

neighbourhoods of its segments lying in the  $\check{x}$ -axis and  $\check{y}$ -axis regions of  $\Sigma'$ . So fix an  $(l, m)$  and consider the part of  ${}^{l,m}V_0^{\text{Pr}}$  (strictly the temporary cycle obtained from this) lying in the  $\check{x}$ -axis part of  $\Sigma'$  and the  $V_{\check{x}\check{y}}$ - and  ${}^lV_{\check{y}\check{w}}$ -necks. We view this in the  $\check{x}$ -projection, as in Figure 3.5.

We first isotope the  $\check{x}$ -axis segment, between the two necks, anticlockwise about  $\check{x} = 0$  by an amount proportional to  $m$ . This of course requires corresponding small modifications at the boundaries of the neck regions to keep the curve continuous. To make the isotopy Hamiltonian, we then push the curve slightly clockwise just inside the  $V_{\check{x}\check{y}}$ -neck. The result is shown schematically in Figure 3.8 for the  $(l, m) = (1, 0)$  and  $(1, 1)$  cycles with  $(p, q) = (4, 3)$ . We then do a similar thing on the  $\check{y}$ -axis part

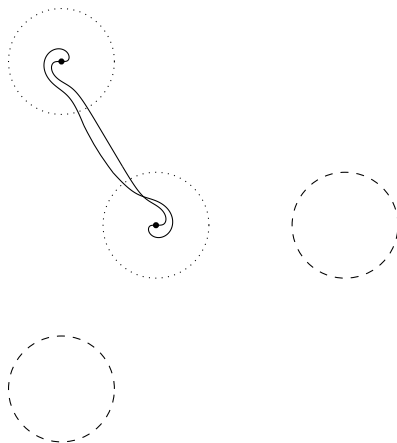

**Figure 3.8:** The  $\check{x}$ -projection of the final vanishing cycles  ${}^{1,0}V_0$  and  ${}^{1,1}V_0$  in the  $\check{x}$ -axis part of  $\Sigma'$  and the  $V_{\check{x}\check{y}}$ - and  ${}^1V_{\check{y}\check{w}}$ -necks, with  $(p, q) = (4, 3)$ .

of  $\Sigma'$  and the  $V_{\check{x}\check{y}}$ - and  ${}^lV_{\check{y}\check{w}}$ -necks.

The result is that the final cycles  ${}^{l,m}V_0$  are all pairwise disjoint, except on the  $V_{\check{x}\check{y}}$ -neck. Inside this neck, the intersections between  ${}^{l,m}V_0$  and  ${}^{L,M}V_0$  remain as described in Remark 3.3.2 when  $l \neq L$  and  $m \neq M$ . When  $l = L$  and (without loss of generality)  $m > M$  the effect is as follows. Before perturbing and isotoping, the  $\check{x}$ -arguments of the curves on the  $V_{\check{x}\check{y}}$ -neck are described by (3.8) and illustrated in the left-hand part of Figure 3.9. In particular, the curves converge as  $|\check{x}|$  becomes large. The isotoped curves are shown schematically in the right-hand part of the same diagram, and we see that now they intersect once, transversely, where  ${}^{l,m}V_0$  has been pushed further anticlockwise than  ${}^{l,M}V_0$ .

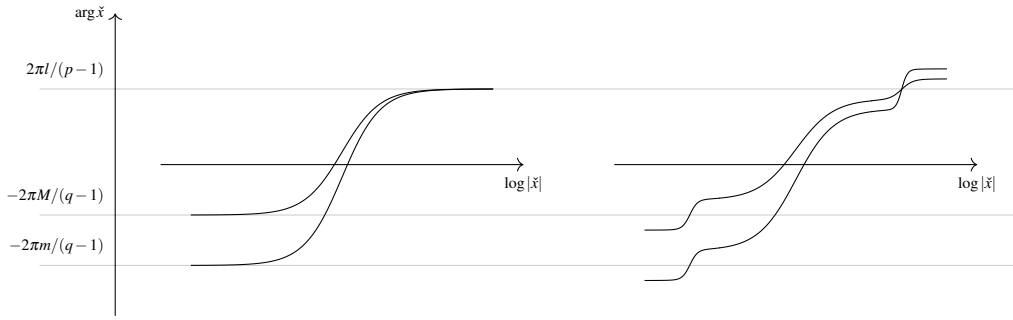

**Figure 3.9:** The  $V_{\tilde{x}\tilde{y}}$ -neck regions of the curves  ${}^{l,m}V_0$  and  ${}^{l,M}V_0$  before (left) and after (right) perturbing and isotoping.

Combining this with Remark 3.3.2 and Proposition 3.3.4 (with the  ${}^{l,m}V_0$  now being used in place of the  ${}^{l,m}V_0^{\text{pr}}$ ) we obtain a model for  $\mathcal{A}$  with precisely the following basis of morphisms:

- An identity morphism for each object.
- A morphism from  ${}^{l,m}V_0$  to  ${}^{L,M}V_0$  whenever  $(l,m) \neq (L,M)$  but both  $l \geq L$  and  $m \geq M$ .
- A morphism from each  ${}^{l,m}V_0$  to each of  $V_{\tilde{x}\tilde{y}}$ ,  ${}^lV_{\tilde{y}\tilde{w}}$  and  ${}^mV_{\tilde{x}\tilde{w}}$ .

This is a chain-level description, but for any pair of objects the morphism complexes are either one- or zero-dimensional, so all differentials trivially vanish. Additively the cohomology algebra therefore matches exactly with the quiver description of  $\mathcal{B}$  in Figure 3.1, under the identification

$$\begin{aligned}
 {}^{l,m}V_0 &\leftrightarrow {}^{i,j}K_0 \\
 {}^lV_{\tilde{y}\tilde{w}} &\leftrightarrow {}^iK_x[3] \\
 {}^mV_{\tilde{x}\tilde{w}} &\leftrightarrow {}^jK_y[3] \\
 V_{\tilde{x}\tilde{y}} &\leftrightarrow K_w[3]
 \end{aligned}
 \quad \text{with} \quad
 \begin{aligned}
 i+l &= p-1 \\
 j+m &= q-1.
 \end{aligned}
 \tag{3.9}$$

To complete the proof of Theorem 3.1.1 in the loop case, we just need to check that the compositions agree, and that the vanishing cycles can be graded so as to place all morphisms in degree 0. These are the subjects of the next two subsections.



**Remark 3.3.6.** *The identification (3.9) is between the objects of  $\mathcal{A} \subset \mathcal{F}(\Sigma)$  and  $\mathcal{B} \subset \text{mf}(\mathbb{A}^2, \Gamma_{\mathbf{w}}, \mathbf{w})$ . In the ultimate equivalence  $D^b \mathcal{F}\mathcal{S}(\check{\mathbf{w}}) \simeq \text{mf}(\mathbb{A}^2, \Gamma_{\mathbf{w}}, \mathbf{w})$  the vanishing cycles in (3.9) should be replaced by their images under the equivalence  $\text{Tw } \mathcal{A} \rightarrow D^b \mathcal{F}\mathcal{S}(\check{\mathbf{w}})$ , which are the corresponding Lefschetz thimbles.*

### 3.3.6 Composition

Suppose  $L_0, L_1$  and  $L_2$  are three (final) vanishing cycles such that  $L_0 < L_1 < L_2$  with respect to the ordering on the category  $\mathcal{A}$  (we are calling them  $L$  rather than  $V$  to avoid conflict with our earlier notation for specific cycles). We need to compute the composition

$$\text{HF}^\bullet(L_1, L_2) \otimes \text{HF}^\bullet(L_0, L_1) \rightarrow \text{HF}^\bullet(L_0, L_2), \quad (3.10)$$

which is defined by counting pseudo-holomorphic triangles, and Seidel [Sei08b, Section (13b)] shows that this can be done combinatorially by simply counting triangular regions bounded by the  $L_i$ . The crucial point is that one can do without Hamiltonian perturbations or perturbations of the complex structure because the directedness of the category automatically rules out contributions from constant discs. (It also rules out discs in which the ordering of the Lagrangians around the boundary does not match their ordering in the category.)

In order for this composition to have a chance of being non-zero (i.e. in order for all three  $\text{HF}^\bullet$  groups to be non-zero) we must have  $L_0 = {}^{l,m}V_0$  and  $L_1 = {}^{L,M}V_0$  for some distinct  $(l, m)$  and  $(L, M)$  with  $l \geq L$  and  $m \geq M$ . We then have four cases, depending on whether  $L_2$  is  $V_{\check{x}\check{y}}$ ,  ${}^L V_{\check{y}\check{w}}$ ,  ${}^M V_{\check{x}\check{w}}$ , or of the form  ${}^{r,s}V_0$  for some  $(r, s) \neq (L, M)$  with  $r \leq L$  and  $s \leq M$ . We restrict our attention to these four cases from now on.

In each case, there is a single obvious holomorphic triangle contributing to the product. In the first and fourth cases the triangle lies in the  $V_{\check{x}\check{y}}$ -neck region, as illustrated in Theorem 3.10, whilst in the second (respectively third) case it stretches between the  $V_{\check{x}\check{y}}$ - and  ${}^L V_{\check{y}\check{w}}$ - (respectively  ${}^M V_{\check{x}\check{w}}$ -) neck regions in the  $\check{x}$ - (respectively  $\check{y}$ -) axis part of  $\Sigma'$  as shown in Figure 3.11. We claim that there are no other triangles, whence (3.10) is the non-degenerate multiplication  $e_{12} \otimes e_{01} \mapsto \pm e_{02}$ , where  $e_{ij}$  is

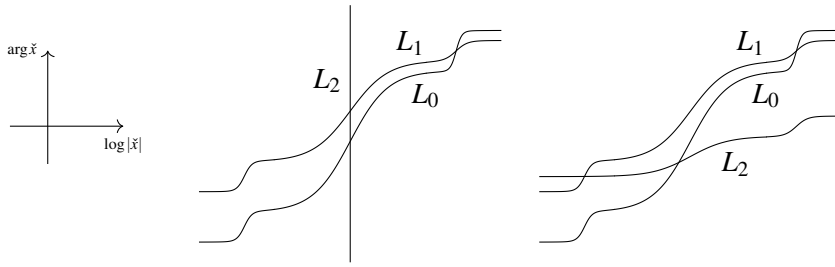

**Figure 3.10:** The obvious triangles in the  $V_{\check{x}y}$ -neck contributing to the product in the first (left) and fourth (right) cases.

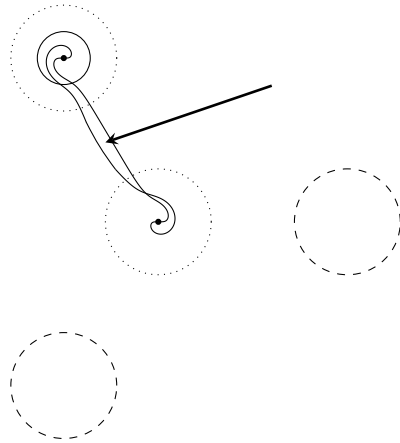

**Figure 3.11:** The  $\check{x}$ -projection of the obvious triangle between  ${}^{1,0}V_0$ ,  ${}^{1,1}V_0$ , and  ${}^1V_{\check{y}\check{w}}$ , when  $(p, q) = (4, 3)$ .

the generator of  $\text{HF}^\bullet(L_i, L_j)$  corresponding to the unique intersection point of  $L_i$  and  $L_j$ . In fact, there are two natural generators, differing by sign, and the  $\pm$  in the multiplication depends on the specific generators chosen, as well as the orientation on the moduli space of holomorphic triangles, but we shall argue shortly that all signs can be arranged to be positive.

To prove the claim, suppose  $u$  is a non-constant holomorphic triangle with boundary on  $L_U$ , defined to be the union of the  $L_i$ . By the open mapping theorem, after deleting  $L_U$  the image of  $u$  consists of a union of components of  $\Sigma \setminus L_U$  whose closures in  $\Sigma$  are compact. Such components naturally correspond to generators of  $H_2(\Sigma/L_U) \simeq H_2(\Sigma, L_U)$ , which the long exact sequence of the pair tells us is isomorphic to the kernel of the inclusion pushforward  $H_1(L_U) \rightarrow H_1(\Sigma)$ . In all of our cases, the space  $L_U$  is homeomorphic to three circles that touch pairwise, so its  $H_1$  has rank four. Its image in  $H_1(\Sigma)$  meanwhile, contains the classes of  $L_0, L_1$  and

$L_2$ , which are linearly independent since the vanishing cycles form a basis for  $H_1(\Sigma)$ . We conclude that  $H_2(\Sigma, L_U)$  has rank at most one, so there is at most one component of  $\Sigma \setminus L_U$  that  $u$  can enter. We have already seen that there is at least one component, and counted the obvious triangle that it contributes, so we conclude that there are no other triangles.

To compute the signs, we should equip each  $L_i$  with an orientation and the non-trivial spin structure (this is the one that is induced by viewing  $L_i$  as the boundary of a Lefschetz thimble in the total space of our Morsified fibration), and then calculate the induced orientation on the moduli space of holomorphic triangles. As mentioned above, however, we can choose the generators of the morphism spaces so that all of the signs turn out to be positive. We make these choices by induction on the *length* of the morphism, defined to be the maximal length of a chain of non-identity morphisms whose composition is the given morphism (so, for example, the length of a generator of  $\mathrm{HF}^\bullet(l, m V_0, L, M V_0)$  is  $l - L + m - M$ ).

First, choose arbitrary signs for the generators of length 1. Now modify these as follows. Start at the bottom left-hand square in the quiver picture Figure 3.1 – explicitly this corresponds to the square

$$\begin{array}{ccc} p^{-1, q-2} V_0 & \longrightarrow & p^{-2, q-2} V_0 \\ \uparrow & & \uparrow \\ p^{-1, q-1} V_0 & \longrightarrow & p^{-2, q-1} V_0 \end{array}$$

If this commutes then do nothing, otherwise reverse the sign of the morphism along the top edge. Then consider the next square to the right and do the same, and continue all the way along to the bottom right-hand square. Now run the same procedure on the next row of squares up, and then the next, all the way to the top. In this way we obtain sign choices for all generators of length 1 such that the small squares commute.

For each morphism space of length  $k > 1$ , we choose its generator by expressing the space as a composition of  $k$  morphism spaces of length 1 and taking the positive generator of each factor. There may be several different ways of decomposing the

space into length 1 factors, but any two can be joined by a chain of moves where one commutes across a small square. We have arranged it so that these moves have no effect, so there is no ambiguity in the overall procedure. This proves that all signs can be taken to be  $+$ .

We conclude:

**Proposition 3.3.7.** *There is a model for  $\mathcal{A}$  which, under the identification (3.9), is described by the quiver in Figure 3.1 up to yet-to-be-determined gradings.*

### 3.3.7 Gradings and completing the proof

Recall from [Sei00, Sei08b] that to equip the Fukaya category of a symplectic manifold  $X$  with a  $\mathbb{Z}$ -grading one must choose a homotopy class of trivialisation of the square  $K_X^{-2}$  of the anticanonical bundle of  $X$ ; this is possible if and only if  $2c_1(X)$  vanishes in  $H^2(X)$ , and in this case the set of choices forms a torsor for  $H^1(X)$ . We are interested in the Fukaya–Seidel category  $\mathcal{FS}(\check{w})$  and the subcategory  $\mathcal{A}$  of the compact Fukaya category of the smooth fibre, for which the relevant choices of  $X$  are  $\mathbb{C}^2$  and  $\Sigma$  respectively. The former has a unique grading, defined by the section  $\sigma = (\partial_{\check{x}} \wedge \partial_{\check{y}})^{\otimes 2}$  of  $K_{\mathbb{C}^2}^{-2}$ , which induces a grading of the latter, and it is with respect to this induced grading that the quasi-equivalence  $\text{Tw } \mathcal{A} \rightarrow \mathcal{FS}(\check{w})$  is graded.

Trivialisations of  $K_{\Sigma}^{-2}$  correspond naturally to line fields  $\ell$  on  $\Sigma$ , i.e. sections of the real projectivisation  $\mathbb{P}_{\mathbb{R}}T\Sigma$  of the tangent bundle, and given a choice of  $\ell$  the Lagrangian  $L$  represented by an embedded curve  $\gamma: S^1 \rightarrow \Sigma$  is gradable if and only if the sections  $\gamma^*\ell$  and  $\gamma^*TL$  of  $\gamma^*\mathbb{P}_{\mathbb{R}}T\Sigma$  are homotopic. In this case a *grading* of  $L$  is a homotopy class of homotopy between them. At each point of  $L$  we can measure the anticlockwise angle from  $\ell$  to  $TL$ , and we denote this by  $\pi\alpha$ , where  $\alpha$  is an element of  $\mathbb{R}/\mathbb{Z}$ . The gradings of  $L$  are then in bijection with lifts  $\alpha^{\#}$  of this element to  $\mathbb{R}$ . Given two graded Lagrangians  $L_0$  and  $L_1$ , which intersect transversely at a point  $x$ , let their corresponding lifts at  $x$  be  $\alpha_0^{\#}$  and  $\alpha_1^{\#}$  respectively. By [Sei08b, Example 11.20], the grading of  $x$  as a generator of the Floer complex  $\text{CF}^{\bullet}(L_0, L_1)$  is then given by

$$\lfloor \alpha_1^{\#} - \alpha_0^{\#} \rfloor + 1. \tag{3.11}$$

From now on we will use  $\ell$  to denote the specific (homotopy class of) line field corresponding to the grading on  $\Sigma$  induced by the grading on  $\mathbb{C}^2$ .

To compute  $\ell$ , note that each Lefschetz thimble  $\Delta$  is gradable with respect to  $\sigma$  ( $\Delta$  is contractible so the grading obstruction trivially vanishes), and each choice of grading induces a grading of the corresponding vanishing cycle  $V \subset \Sigma$  with respect to  $\ell$ . In particular, all of the vanishing cycles  $V$  are gradable with respect to  $\ell$ , and since they form a basis for  $H_1(\Sigma)$  this property determines  $\ell$  uniquely (cf. Section 4.3.1).

**Remark 3.3.8.** *Recall that the ordering on  $\mathcal{A}$  is determined by a choice of starting direction in the base  $\mathbb{C}$ , and, strictly speaking, this choice enters into the construction of the bijection between gradings of a thimble  $\Delta$  and of the corresponding vanishing cycle  $V$ . This is unimportant for our present purposes, but we will see a manifestation of it in Section 3.6.2, where a change in this direction leads to a change in the grading of a vanishing cycle.*

Using this characterisation, one can draw  $\ell$  as shown in Figure 3.12: the left-hand diagram depicts a foliation of the line  $\{u + v = \varepsilon\}$  with the points  $(\varepsilon, 0)$  and  $(0, \varepsilon)$  deleted, and we lift its tangent distribution to give the line field on the branched cover comprising the  $\{\check{w} = \varepsilon\}$  part of  $\Sigma'$  and the attached neck regions; the right-hand diagram depicts a foliation whose tangent distribution gives the line field on the  $\check{x}$ -axis part of  $\Sigma'$  and the attached neck regions in the case  $q = 4$  – it is clear how this generalises to other values of  $q$  and that a similar picture can be drawn for the  $\check{y}$ -axis part.

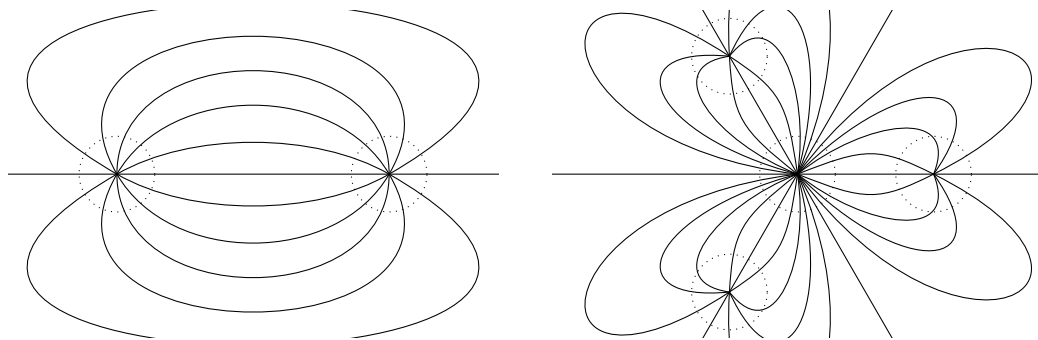

**Figure 3.12:** Foliations defining the line field  $\ell$  used to grade  $\Sigma$ .

As usual, the dotted circles represent the boundaries of the neck regions. Note that on each neck region the line field is longitudinal, so the different pictures glue together.

Each  ${}^{l,m}V_0$  is approximately tangent to  $\ell$  along its approximately straight segments in the three components of  $\Sigma'$ , and we choose to grade it so that the homotopy from  $TL$  to  $\ell$  is approximately constant on these regions. This is consistent, in the sense that these homotopies patch together across the neck regions. On each neck region, the lift  $\alpha^\#$  is valued approximately between 0 and  $1/2$ , and where two of these cycles intersect the one with the greater value of  $\theta_{l,m}$  is ‘steeper’ and hence has greater  $\alpha^\#$ . We conclude that for distinct  $(l,m)$  and  $(L,M)$  with  $l \geq L$  and  $m \geq M$  the generator of  $\mathrm{HF}^\bullet({}^{l,m}V_0, {}^{L,M}V_0)$  lies in degree 0 (in the notation of (3.11) we have  $1/2 > \alpha_0^\# > \alpha_1^\# > 0$ ).

Each of the other vanishing cycles is a waist curve on a neck region and as such is orthogonal to the line field. We grade it so that the lift  $\alpha^\#$  is  $-1/2$ . This puts the generators of

$$\mathrm{HF}^\bullet({}^{l,m}V_0, {}^lV_{\check{y}\check{w}}), \mathrm{HF}^\bullet({}^{l,m}V_0, {}^mV_{\check{x}\check{w}}), \text{ and } \mathrm{HF}^\bullet({}^{l,m}V_0, V_{\check{x}\check{y}})$$

all in degree 0. This means that the identification (3.9) matches up gradings, and we deduce:

**Theorem 3.3.9** (Theorem 3.1.1, loop polynomial case). *Under (3.9), the  $\mathbb{Z}$ -graded  $A_\infty$ -category  $\mathcal{A}$  is described by the quiver with relations in Figure 3.1 and is formal. In particular, by Theorem 3.2.13 it is quasi-equivalent to  $\mathcal{B}$ , and hence there is an induced quasi-equivalence*

$$\mathrm{mf}(\mathbb{A}^2, \Gamma_{\mathbf{w}}, \mathbf{w}) \simeq D^b \mathcal{FS}(\check{w}).$$

*Proof.* The cohomology-level version of the first statement follows from Proposition 3.3.7 plus the above grading computations. Formality then follows immediately from directedness and the fact that the morphisms are concentrated in degree 0 as in Theorem 3.2.13. This shows that  $\mathcal{A}$  and  $\mathcal{B}$  are quasi-equivalent, and the final

statement then follows from the argument outlined in Section 3.1.1.  $\square$

### 3.4 B-model for chain polynomials

#### 3.4.1 The basic objects

We now deal with the case of the chain polynomial  $\mathbf{w} = x^p y + y^q$ . This time the maximal grading group  $L$  is the abelian group freely generated by  $\vec{x}$ ,  $\vec{y}$  and  $\vec{c}$  modulo the relations

$$p\vec{x} + \vec{y} = q\vec{y} = \vec{c}.$$

In contrast to the loop case, we have  $L/\mathbb{Z}\vec{c} \simeq \mathbb{Z}_{pq}$ , generated by  $\vec{x}$  but not by  $\vec{y} = -p\vec{x}$ . In keeping with our earlier notation, let  $S$  be the  $L$ -graded algebra,  $\mathbb{C}[x, y]$ , with  $x$  and  $y$  in degrees  $\vec{x}$  and  $\vec{y}$  respectively, and let  $R = S/(\mathbf{w})$ . Let  $w$  now denote  $x^p + y^{q-1}$  so that  $\mathbf{w} = yw$ .

The stack  $[\mathbf{w}^{-1}(0)/\Gamma_{\mathbf{w}}]$  has two components, whose structure sheaves correspond to the matrix factorisations

$$K_y^\bullet = (\cdots \rightarrow S(-\vec{c}) \xrightarrow{w} S(-\vec{y}) \xrightarrow{y} S \rightarrow \cdots),$$

and

$$K_w^\bullet = (\cdots \rightarrow S(-\vec{c}) \xrightarrow{y} S(-\vec{c} + \vec{y}) \xrightarrow{w} S \rightarrow \cdots).$$

We will need the shifts

$${}^j K_y = K_y((j+1-q)\vec{y}) \quad \text{for } j = 1, \dots, q-1.$$

Note that  $K_w[1] \simeq K_y(\vec{y})$ .

The unique singular point of the stack is still the origin, and the objects we need that are supported at this point are the  ${}^{i,j}K_0$  defined by

$$\begin{array}{ccccccc} S(\vec{y}) & \xrightarrow{y^j} & S((j+1)\vec{y}) & \xrightarrow{y^{q-j}} & S(\vec{c} + \vec{y}) & & \\ \oplus & \searrow^{-x^i} & \oplus & \searrow^{x^i} & \oplus & & \\ \cdots & & & & & & \cdots \\ S(-\vec{c} + i\vec{x} + (j+1)\vec{y}) & \xrightarrow{y^{q-j}} & S(i\vec{x} + \vec{y}) & \xrightarrow{y^j} & S(i\vec{x} + (j+1)\vec{y}) & & \end{array}$$

for  $i = 1, \dots, p-1$  and  $j = 1, \dots, q-1$ , obtained by stabilising  $R(i\vec{x} + (j+1)\vec{y})/(x^i, y^j)$ .

### 3.4.2 Morphisms between the $K_y$ 's and $K_w$

For all  $l$  in  $L$ , and all integers  $m$ , we have  $\text{Hom}^{2m}(K_y, K_y(l)) \simeq (R/(y, w))_{m\vec{c}+l}$  and  $\text{Hom}^{2m-1}(K_y, K_y(l)) = 0$ . The analogue of Lemma 3.2.2 and Lemma 3.2.3, proved by similar arguments, is now:

**Lemma 3.4.1.** *Suppose  $a$  and  $b$  are integers, with  $a \leq p-1$ , and  $s$  is an element of  $S$  (or  $R$ ) which is homogeneous modulo  $\vec{c}$ , of degree  $a\vec{x} + b\vec{y} \pmod{\vec{c}}$ . Then:*

- (i) *The element  $s$  is divisible by  $x^a$ .*
- (ii) *If also  $b \leq q-1$ , then  $s$  lies in the ideal  $(x^a y^b, x^{p+a})$ .*
- (iii) *If  $a = b = 0$ , then the non-constant terms of  $s$  lie in  $(x^{pq}, x^p y, y^q)$ .*

Applying this to the above computation we obtain:

**Lemma 3.4.2.** *The objects  ${}^1K_y, \dots, {}^{q-1}K_y$  are exceptional and pairwise orthogonal.*

Using the fact that  $K_w[1] \simeq K_y(\vec{y})$ , we also get:

**Lemma 3.4.3.** *The object  $K_w$  is exceptional and is orthogonal to the  ${}^jK_y$ .*

### 3.4.3 Morphisms between $K_y$ 's and $K_w$ and $K_0$ 's

For all  $l$  and all  $(i, j)$ ,  $\text{Hom}^\bullet(K_y(l), {}^{i,j}K_0)$  is given by the cohomology of the complex

$$\cdots \rightarrow (R/(x^i, y^j))_{i\vec{x}+(j+1)\vec{y}-l} \xrightarrow{y} (R/(x^i, y^j))_{i\vec{x}+(j+2)\vec{y}-l} \xrightarrow{w} (R/(x^i, y^j))_{\vec{c}+i\vec{x}+(j+1)\vec{y}-l} \rightarrow \cdots$$

By Lemma 3.4.1(i) we see that for all  $J$

$$\text{Hom}^\bullet({}^J K_y, {}^{i,j}K_0) = \text{Hom}^\bullet(K_w, {}^{i,j}K_0) = 0.$$

Morphisms in the other directions are computed by the complex



$$\begin{array}{ccccccc}
 (R/(y))_{-\vec{c}-\vec{y}+l} & \xrightarrow{y^{q-j}} & (R/(y))_{-(j+1)\vec{y}+l} & \xrightarrow{y^j} & (R/(y))_{-\vec{y}+l} & & \\
 & \searrow^{-x^{p-i}y} & \nearrow & \searrow^{x^{p-i}y} & \nearrow & & \\
 \dots & \oplus & & \oplus & & \oplus & \dots \\
 & \nearrow^{x^i} & \searrow & \nearrow^{-x^i} & \searrow & & \\
 (R/(y))_{-i\vec{x}-(j+1)\vec{y}+l} & \xrightarrow{y^j} & (R/(y))_{-i\vec{x}-\vec{y}+l} & \xrightarrow{y^{q-j}} & (R/(y))_{\vec{c}-i\vec{x}-(j+1)\vec{y}+l} & & 
 \end{array}$$

The only non-vanishing differentials are  $x^i$ , so we get

$$\begin{aligned}
 \mathrm{Hom}^{2m}(i,jK_0, {}^J K_y) &\simeq (R/(x^i, y))_{(m-2)\vec{c}+J\vec{y}}, \\
 \mathrm{Hom}^{2m+1}(i,jK_0, {}^J K_y) &\simeq (R/(x^i, y))_{(m-1)\vec{c}+(J-j)\vec{y}}, \\
 \mathrm{Hom}^{2m}(i,jK_0, K_w) &\simeq (R/(x^i, y))_{(m-1)\vec{c}-j\vec{y}}, \\
 \mathrm{Hom}^{2m+1}(i,jK_0, K_w) &\simeq (R/(x^i, y))_{(m-1)\vec{c}},
 \end{aligned}$$

and hence:

**Lemma 3.4.4.** *In  $\mathrm{HMF}(\mathbb{A}^2, \Gamma_w, \mathbf{w})$  there are no morphisms from  ${}^J K_y$  or  $K_w$  to  ${}^{i,j} K_0$ . The morphism spaces in the other direction are spanned by*

$$(1, 0) \in \mathrm{Hom}^3(i,jK_0, {}^J K_y)$$

and

$$(0, 1) \in \mathrm{Hom}^3(i,jK_0, K_w)$$

in the above complexes.

*Proof.* The even degree morphisms all vanish by Lemma 3.4.1(ii), and if  $j \neq J$  then the same holds for  $\mathrm{Hom}^{2m+1}(i,jK_0, {}^J K_y)$  (if  $J < j$  then rewrite the grading as  $(q+J-j)\vec{y} \bmod \vec{c}$ ). Lemma 3.4.1(iii) tells us that the only surviving odd morphisms are the constants.  $\square$

### 3.4.4 Morphisms between the $K_0$ 's

The complex computing  $\mathrm{Hom}^\bullet(i,jK_0, {}^{l,j} K_0)$  is

$$\begin{array}{ccccccc}
 (R/(x^I, y^J))_{-\vec{c}+I\vec{x}+J\vec{y}} & \xrightarrow{y^{q-j}} & (R/(x^I, y^J))_{I\vec{x}+(J-j)\vec{y}} & \xrightarrow{y^j} & (R/(x^I, y^J))_{I\vec{x}+J\vec{y}} & & \\
 \oplus & \searrow^{-x^{p-i}y} & \oplus & \swarrow^{x^{p-i}y} & \oplus & & \\
 \dots & & & & & & \dots \\
 (R/(x^I, y^J))_{(I-i)\vec{x}+(J-j)\vec{y}} & \xrightarrow{y^j} & (R/(x^I, y^J))_{(I-i)\vec{x}+J\vec{y}} & \xrightarrow{y^{q-j}} & (R/(x^I, y^J))_{\vec{c}+(I-i)\vec{x}+(J-j)\vec{y}} & & \\
 \oplus & \swarrow^{x^i} & \oplus & \searrow^{-x^i} & \oplus & & \\
 \dots & & & & & & \dots
 \end{array}$$

The top row vanishes by Lemma 3.4.1(i), and the same is true of the bottom row if  $I < i$  (after adding  $p\vec{x} + \vec{y} \bmod \vec{c}$  to the gradings), so assume that  $I \geq i$ . The complex becomes

$$\dots \rightarrow (R/(x^I, y^J))_{(I-i)\vec{x}+(J-j)\vec{y}} \xrightarrow{y^j} (R/(x^I, y^J))_{(I-i)\vec{x}+J\vec{y}} \xrightarrow{y^{q-j}} (R/(x^I, y^J))_{\vec{c}+(I-i)\vec{x}+(J-j)\vec{y}} \rightarrow \dots$$

and the odd position terms vanish by Lemma 3.4.1(ii), so  $\text{Hom}^{2m+1}(i, j K_0, I, J K_0) = 0$ , and

$$\text{Hom}^{2m}(i, j K_0, I, J K_0) \simeq (R/(x^I, y^J))_{m\vec{c}+(I-i)\vec{x}+(J-j)\vec{y}}.$$

If  $J < j$  then this is zero by Lemma 3.4.1(ii) (after adding  $q\vec{y} \bmod \vec{c}$  to the grading), so assume  $J \geq j$ . Lemma 3.4.1(ii) tells us that any element is divisible by  $x^{I-i}y^{J-j}$  modulo  $(x^I, y^J)$ , and then Lemma 3.4.1(iii) tells us that only constant multiples survive. We conclude:

**Lemma 3.4.5.** *For all  $(i, j)$  and  $(I, J)$  we have that*

$$\text{Hom}^\bullet(i, j K_0, I, J K_0) \simeq \begin{cases} \mathbb{C} \cdot x^{I-i}y^{J-j} & \text{if } I \geq i, J \geq j \text{ and } \bullet = 0 \\ 0 & \text{otherwise.} \end{cases}$$

### 3.4.5 The total endomorphism algebra of the basic objects

It is easy to compute the compositions between the morphisms and obtain the following description of the full subcategory  $\mathcal{B}$  of  $\text{mf}(\mathbb{A}^2, \Gamma_{\mathbf{w}}, \mathbf{w})$  on the objects  ${}^j K_y[3], K_w[3], {}^i K_0$ :

**Theorem 3.4.6.** *The homotopy category  $\text{H}^0(\mathcal{B})$  is the path algebra of the quiver-with-relations described in Figure 3.13. Any  $\mathbb{Z}$ -graded  $A_\infty$ -structure on this algebra*

– and hence in particular that induced from the dg-structure on  $\text{mf}(\mathbb{A}^2, \Gamma_{\mathbf{w}}, \mathbf{w})$  – is formal.

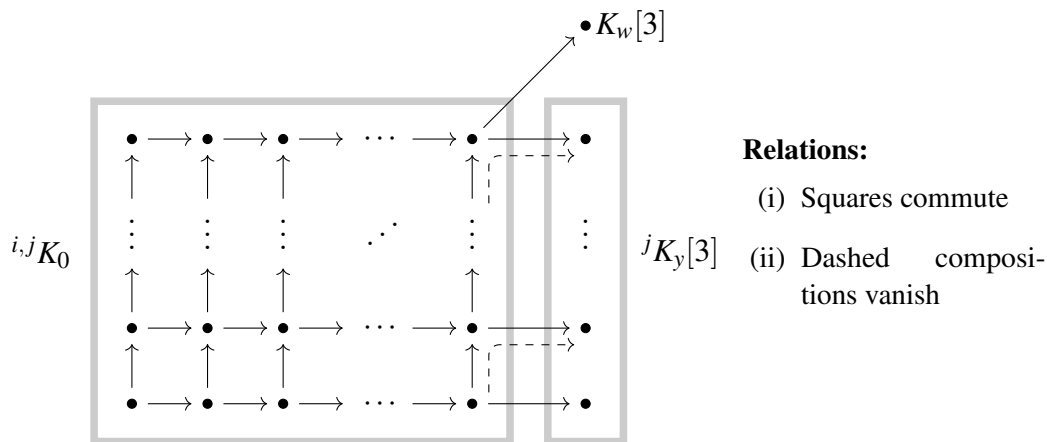

Figure 3.13: The quiver describing the category  $\mathcal{B}$  for chain polynomials.

### 3.4.6 Generation

The final thing we need to check is:

**Lemma 3.4.7.** *The objects in  $\mathcal{B}$  split-generate  $\text{HMF}(\mathbb{A}^2, \Gamma_{\mathbf{w}}, \mathbf{w})$ .*

*Proof.* Let  $V = \{^j K_y, K_w, {}^{i,j} K_0\}$ . As in the loop case, it suffices to prove that the category  $\langle V \rangle$  contains all of the  $L/\mathbb{Z}\vec{c}$ -grading shifts of  $R/(x, y)$ . Again following the loop case, we easily have that  $R(i\vec{x} + (j+1)\vec{y})/(x, y)$  lies in  $\langle V \rangle$  for any  $1 \leq i \leq p-1$  and  $1 \leq j \leq q-1$ .

By combining  $K_w \simeq K_y(\vec{y})[-1]$ , the  $^j K_y$ , and all of their  $[\cdot]$ -shifts, we see that  $\langle V \rangle$  contains  $R(l)/(y)$  for all  $l$  in  $\mathbb{Z}\vec{y} + \mathbb{Z}\vec{c}$  (the  $\mathbb{Z}\vec{c}$  is redundant here but we include it for clarity). Consequently, for each integer  $j$  we have that  $\langle V \rangle$  contains the cokernel of

$$R((j+1)\vec{y} - \vec{c})/(y) \xrightarrow{x^p} R(j\vec{y})/(y),$$

which is  $R(j\vec{y})/(x^p, y)$ . Peeling off one-dimensional pieces  $R(i\vec{x} + j\vec{y})/(x, y)$  for  $i = -1, \dots, -(p-1)$  by taking cones, we're left with  $R(j\vec{y})/(x, y)$ . If  $j$  lies in  $1, \dots, q-1$  then (after applying the trivial operation  $(p\vec{x} + \vec{y})[-2]$ ) each of these pieces is in  $\langle V \rangle$  by the previous paragraph. The conclusion is that  $R(j\vec{y})/(x, y)$  lies in  $\langle V \rangle$  for all such  $j$ .

We have therefore constructed  $R(a\vec{x} + b\vec{y})/(x, y)$  for  $0 \leq a \leq p-1$  and  $0 \leq b \leq q-1$  except for  $(a, b) = (0, 0)$  and  $(a, b) = (1, 1), \dots, (1, p-1)$ . To obtain the latter, consider the extension

$$0 \rightarrow R/(w) \xrightarrow{x^i} R(i\vec{x})/(w) \rightarrow R(i\vec{x})/(x^i, y^{q-1}) \rightarrow 0$$

for  $i = 1, \dots, p-1$ . The outer terms lie in  $\langle V \rangle$  (they are  $K_w$  and  ${}^{i, q-1}K_0[-2]$ ), so we deduce that  $R(i\vec{x})/(w)$  also lies in  $\langle V \rangle$ . Again using the fact that  $K_w \simeq K_y(\vec{y})[-1]$ , we get that  $R(i\vec{x} + \vec{y})/(y)$  is in  $\langle V \rangle$  for  $i = 0, \dots, p-1$  (the  $i = 0$  case comes from  $K_w[1]$  itself, not from the preceding argument). From these we see that

$$R(i\vec{x} + \vec{y})/(x, y) \simeq \text{Cone} \left( R((i-1)\vec{x} + y)/(y) \xrightarrow{x} R(i\vec{x} + \vec{y})/(y) \right)$$

lies in  $\langle V \rangle$  for  $i = 1, \dots, p-1$ .

All that is left to show now is that we have  $R/(x, y)$  in  $\langle V \rangle$ , and this closely follows the loop case: we can realise this module as the cokernel of

$$R(-\vec{x})/(x^{pq-1}, y) \xrightarrow{x} R/(x^{pq}, y),$$

and the domain can be built of the shifts of  $R/(x, y)$  that we already have. The codomain, meanwhile, is given by

$$\text{Cone} \left( R(-(q-1)\vec{c})/(y) \xrightarrow{x^{pq}} R/(y) \right). \quad \square$$

**Remark 3.4.8.** *The  $R(l)/(x, y)$  still only split-generate the category (which we saw for loop polynomials in Remark 3.2.19), since the above proof shows that they are annihilated by the homomorphism*

$$K_0(\text{mf}(\mathbb{A}^2, \Gamma_{\mathbf{w}}, \mathbf{w})) \rightarrow \mathbb{Z}_2$$

which sends the basis elements  ${}^{i, j}K_0$  to 0 but  ${}^jK_y$  and  $K_w$  to 1.

As in the loop case, we deduce:

**Theorem 3.4.9** (Theorem 3.1.2, chain polynomial case). *The object*

$$\mathcal{E} := \left( \bigoplus_{\substack{i=1, \dots, p-1 \\ j=1, \dots, q-1}}^{i,j} K_0 \right) \oplus \left( \bigoplus_{j=1}^{q-1} K_y[3] \right) \oplus K_w[3]$$

is a tilting object for  $\text{mf}(\mathbb{A}^2, \Gamma_{\mathbf{w}}, \mathbf{w})$ .

This was proved by Futaki–Ueda [FU13, Section 4] in the case  $q = 2$ .

## 3.5 A-model for chain polynomials

### 3.5.1 The setup

Just as for the B-model, our basic strategy for understanding the A-model will closely follow the loop polynomial case. This time the Berglund–Hübsch transpose is  $\check{\mathbf{w}} = \check{x}^p + \check{x}\check{y}^q$ , and our starting point is once more the resonant Morsification  $\check{\mathbf{w}}_\varepsilon = \check{\mathbf{w}} - \varepsilon\check{x}\check{y}$  for small positive real  $\varepsilon$ . We denote  $\check{x}^{p-1} + \check{y}^q$  by  $\check{\mathbf{w}}$ . The critical points now fall into three types:

- (i)  $\check{x} = 0, \check{y}^{q-1} = \varepsilon$
- (ii)  $\check{x} = \check{y} = 0$
- (iii)  $\check{y}^{q-1} = \frac{\varepsilon}{q}, \check{x}^{p-1} = \frac{(q-1)\varepsilon\check{y}}{pq}$ .

The first two types have critical value zero, whilst the third type has critical value

$$-\check{x}\check{y}\varepsilon(p-1)(q-1)/pq,$$

on the ray through  $-\check{x}\check{y}$ . These critical points are indeed all Morse.

There is a unique positive real solution to (iii) which we denote by  $(\check{x}_{\text{crit}}^+, \check{y}_{\text{crit}}^+)$ , and again we call the corresponding (negative real) critical value  $c_{\text{crit}}$ . Still letting  $\zeta$  and  $\eta$  denote the roots of unity

$$\zeta = e^{2\pi\sqrt{-1}/(p-1)} \quad \text{and} \quad \eta = e^{2\pi\sqrt{-1}/(q-1)},$$

but now also letting  $\mu = e^{2\pi\sqrt{-1}/(p-1)(q-1)}$ , the type (iii) critical points are

$$\{(\zeta^l \mu^m \check{x}_{\text{crit}}^+, \eta^m \check{y}_{\text{crit}}^+) : 0 \leq l \leq p-2, 0 \leq m \leq q-2\},$$

with critical values  $\mu^{(q-1)l+pm} c_{\text{crit}}$ .

Taking regular fibre  $\Sigma = \check{w}_\varepsilon^{-1}(-\delta)$  with  $0 < \delta \ll \varepsilon$ , we again choose the straight line segment from  $-\delta$  to 0 as the vanishing path for the critical points over zero, and denote the corresponding vanishing cycles by  ${}^m V_{\check{x}\check{w}}$  and  $V_{\check{x}\check{y}}$ . We also choose the same preliminary vanishing paths  $\gamma_{l,m}$  as before, but with  $\theta_{l,m}$  now given by

$$\theta_{l,m} = 2\pi \left( \frac{l}{p-1} + \frac{pm}{(p-1)(q-1)} \right),$$

and write  ${}^{l,m} V_0^{\text{pr}}$  for the preliminary vanishing cycles.

### 3.5.2 The vanishing cycles

The central fibre  $\check{w}_\varepsilon^{-1}(0)$ , shown in Figure 3.14, now has only two components, namely the line  $\{\check{x} = 0\}$  and the smooth curve  $\{\check{w} = \varepsilon\check{y}\}$ . The  $q$  nodes are smoothed to thin necks in  $\Sigma$ , whose complement we again refer to as  $\Sigma'$ , and we trivialise the fibration  $\check{w}_\varepsilon$  on this complement over the disc of radius  $\delta$ . This time we compute

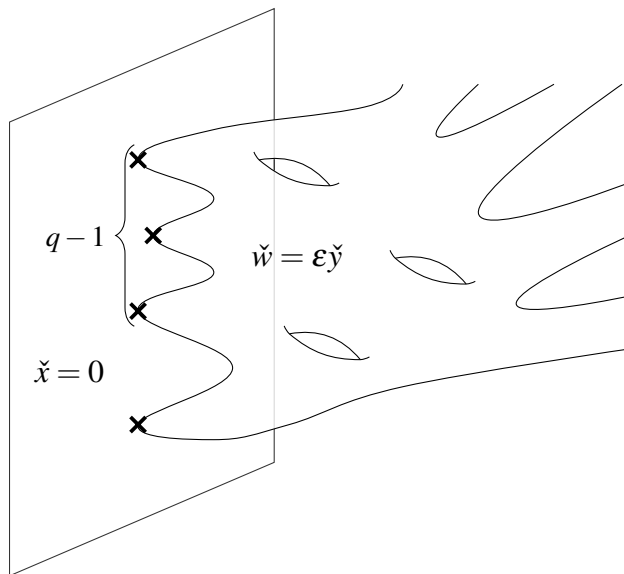

Figure 3.14: The fibre  $\check{w}_\varepsilon^{-1}(0)$  for chain polynomials.

$$\begin{aligned} \# \text{ punctures of } \Sigma &= \gcd(p-1, q) + 1 \\ g(\Sigma) &= \frac{1}{2}(pq - p + 1 - \gcd(p-1, q)). \end{aligned}$$

Just as in the loop case, the preliminary cycle  ${}^{0,0}V_0^{\text{pr}}$  is given by the loop in the positive quadrant of the real part of  $\Sigma$ . On  $\Sigma'$ , the other preliminary cycles are given by the action of  $(\zeta^l \mu^m, \eta^m)$ . In particular, they are pairwise disjoint on the  $\{\check{w} = \varepsilon \check{y}\}$  part of  $\Sigma'$  (since  $\check{x}$  and  $\check{y}$  are both nowhere-zero here). The only intersections on the  $\{\check{x} = 0\}$  part occur when the  $m$ -values coincide, and in this case the cycles overlap (at least in the limit  $\delta \searrow 0$ ) exactly as before.

On the  $V_{\check{x}\check{y}}$ -neck region, the argument of the  $\check{y}$ -component of  ${}^{l,m}V_0^{\text{pr}}$  interpolates from

$$-2\pi \left( \frac{l}{p-1} + \frac{m}{(p-1)(q-1)} \right) \quad \text{to} \quad \frac{2\pi m}{q-1}$$

as  $|\check{y}|$  increases, whilst on the  ${}^mV_{\check{x}\check{w}}$ -neck the argument of  $\check{y} - \eta^m \check{y}_{\text{crit}}^+$  interpolates back the other way as its argument decreases. This is completely analogous to the picture in Figure 3.5.

We modify the preliminary paths, and correspondingly perturb the fibration, exactly as in Section 3.3.4. The chain polynomial version of Lemma 3.3.3 is:

**Lemma 3.5.1.** *Suppose  $\theta_{l,m} > \theta_{L,M} + 2\pi$ , and let  $z = \gamma'_{l,m} \cap \gamma'_{L,M}$ . Inside  $\Sigma_z = \check{w}_\varepsilon^{-1}(z)$  we have vanishing cycles  $V_1$  and  $V_2$  corresponding to the critical points  $(\zeta^l \mu^m \check{x}_{\text{crit}}^+, \eta^m \check{y}_{\text{crit}}^+)$  and  $(\zeta^L \mu^M \check{x}_{\text{crit}}^+, \eta^M \check{y}_{\text{crit}}^+)$  and the truncations of  $\gamma'_{l,m}$  and  $\gamma'_{L,M}$ . These cycles are disjoint.*

*Proof.* We must have  $l \geq L$  and  $m > M$ , so we can apply  $f_{L,M}^{-1}$  to get  $(L, M) = (0, 0)$  with  $m > 0$ . The latter ensures that  $V_1$  and  $V_2$  are disjoint on  $\Sigma' \subset \Sigma \approx \Sigma_z$ , and that their only possible intersection is in the  $V_{\check{x}\check{y}}$ -neck region. On this region the argument of  $\check{y}$  is approximately 0 for  $V_2$ , and interpolates between

$$2\pi \left( 1 - \frac{l}{p-1} - \frac{m}{(p-1)(q-1)} \right) \quad \text{and} \quad \frac{2\pi m}{q-1}$$

for  $V_1$ , so they are disjoint there too. □

This allows us to introduce fingers to the vanishing paths  $\gamma'_{l,m}$ , as before, without affecting the vanishing cycles. We then make Hamiltonian isotopies as in Section 3.3.5 (but now only in the  $\check{y}$ -axis part of  $\Sigma'$  and the  $V_{\check{x}\check{y}}$ - and  ${}^mV_{\check{x}\check{w}}$ -necks) to obtain the final vanishing cycles. This gives a model for  $\mathcal{A}$  with the following basis of morphisms:

- An identity morphism for each object.
- A morphism from  ${}^{l,m}V_0$  to  ${}^{L,M}V_0$  whenever  $(l,m) \neq (L,M)$  but both  $l \geq L$  and  $m \geq M$ .
- A morphism from each  ${}^{l,m}V_0$  to  $V_{\check{x}\check{y}}$  and to  ${}^mV_{\check{x}\check{w}}$ .

As in the loop case, the differentials on morphism complexes trivially vanish so we are left to check compositions and gradings.

### 3.5.3 Composition and gradings

Once more we have one obvious triangle contributing to each non-trivial product, and by the same homology computation as for loop polynomials there can be no others. We can also run the same inductive argument to ensure that all of the signs in the compositions are positive.

To grade the category we must again take the unique homotopy class of line field  $\ell$  on  $\Sigma$  whose winding number along each vanishing cycle  $V$  is zero, and then pick a homotopy from  $\ell|_V$  to  $TV$ . By homotoping  $\ell$  we may assume it points longitudinally in each neck region, orthogonal to the waist curves, and then up to homotopy it must look like the right-hand diagram in Figure 3.12 in the union of the neck regions and the  $\check{y}$ -axis part of  $\Sigma'$ . We can then define the gradings in the same way as in the loop case, and see that all morphisms then lie in degree 0.

The conclusion is:

**Theorem 3.5.2** (Theorem 3.1.1, chain polynomial case). *Under the correspondence*

$$\begin{aligned} {}^{l,m}V_0 &\leftrightarrow {}^{i,j}K_0 \\ {}^mV_{\check{x}\check{w}} &\leftrightarrow {}^jK_y[3] \\ V_{\check{x}\check{y}} &\leftrightarrow K_w[3] \end{aligned} \quad \text{with} \quad \begin{aligned} i+l &= p-1 \\ j+m &= q-1 \end{aligned}$$



the  $\mathbb{Z}$ -graded  $A_\infty$ -category  $\mathcal{A}$  is described by the quiver with relations in Figure 3.13 and is formal, so there is a quasi-equivalence

$$\mathrm{mf}(\mathbb{A}^2, \Gamma_{\mathbf{w}}, \mathbf{w}) \simeq D^b \mathcal{F}\mathcal{S}(\check{\mathbf{w}}).$$

This was also proved by Futaki–Ueda for  $q = 2$ , as a special case of [FU13, Theorem 1.2]. They state the result at the level of derived categories, i.e. after passing to cohomology, but, as we have seen, it is trivial to upgrade from this to the full  $A_\infty$  result.

## 3.6 Brieskorn–Pham polynomials

### 3.6.1 B-model

Now  $\mathbf{w}$  is given by  $x^p + y^q$ , and the maximal grading group  $L$  is generated by  $\vec{x}$ ,  $\vec{y}$  and  $\vec{c}$  modulo

$$p\vec{x} = q\vec{y} = \vec{c},$$

so is simply  $\mathbb{Z}_p \oplus \mathbb{Z}_q$ , generated by  $\vec{x} = (1, 0)$  and  $\vec{y} = (0, 1)$ . Let  $S = \mathbb{C}[x, y]$ , graded by  $L$  in the obvious way, and let  $R = S/(\mathbf{w})$ .

The stack  $[\mathbf{w}^{-1}(0)/\Gamma_{\mathbf{w}}]$  has only one component this time, and the objects that we need are the matrix factorisations  ${}^{i,j}K_0$  given by

$$\begin{array}{ccccccc} & & S & \xrightarrow{y^j} & S(j\vec{y}) & \xrightarrow{y^{q-j}} & S(\vec{c}) \\ & & \searrow^{-x^i} & & \searrow^{x^i} & & \searrow \\ \dots & \oplus & & & \oplus & & \oplus & \dots \\ & & \nearrow^{x^{p-i}} & & \nearrow^{-x^{p-i}} & & \nearrow \\ & & S(-\vec{c} + i\vec{x} + j\vec{y}) & \xrightarrow{y^{q-j}} & S(i\vec{x}) & \xrightarrow{y^j} & S(i\vec{x} + j\vec{y}) \end{array}$$

for  $i = 1, \dots, p-1$  and  $j = 1, \dots, q-1$ , stabilising  $R(i\vec{x} + j\vec{y})/(x^i, y^j)$ .

For any  $(i, j)$  and  $(I, J)$  the morphism space  $\mathrm{Hom}^\bullet({}^{i,j}K_0, {}^{I,J}K_0)$  is computed by the complex

$$\begin{array}{ccccccc}
 (R/(x^I, y^J))_{-\vec{c}+I\vec{x}+J\vec{y}} & \xrightarrow{y^{q-j}} & (R/(x^I, y^J))_{I\vec{x}+(J-j)\vec{y}} & \xrightarrow{y^j} & (R/(x^I, y^J))_{I\vec{x}+J\vec{y}} & & \\
 \oplus & \searrow^{-x^{p-i}} & \oplus & \searrow^{x^{p-i}} & \oplus & & \\
 \dots & & & & & & \dots \\
 (R/(x^I, y^J))_{(I-i)\vec{x}+(J-j)\vec{y}} & \xrightarrow{y^j} & (R/(x^I, y^J))_{(I-i)\vec{x}+J\vec{y}} & \xrightarrow{y^{q-j}} & (R/(x^I, y^J))_{\vec{c}+(I-i)\vec{x}+(J-j)\vec{y}} & & \\
 \oplus & \swarrow^{x^i} & \oplus & \swarrow^{-x^i} & \oplus & & \\
 \dots & & & & & & \dots
 \end{array}$$

By considering gradings modulo  $\vec{x}$  and modulo  $\vec{y}$ , one sees that the top row and the odd position terms in the bottom row vanish, and the remaining terms vanish if  $I < i$  or  $J < j$ . We therefore assume that  $I \geq i$  and  $J \geq j$ , and read off that  $\text{Hom}^{2m+1}(i, j K_0, I, J K_0) = 0$  and

$$\text{Hom}^{2m}(i, j K_0, I, J K_0) \simeq (R/(x^I, y^J))_{(I-i)\vec{x}+(J-j)\vec{y}}.$$

Arguing as in the loop and chain cases, this is spanned by  $x^{I-i}y^{J-j}$ .

The full  $A_\infty$ -subcategory of  $\text{mf}(\mathbb{A}^2, \Gamma_{\mathbf{w}}, \mathbf{w})$  generated by the objects  $i, j K_0$  is therefore described by the quiver with relations in Figure 3.15, and is formal as before. This is the tensor product of the  $A_{p-1}$  and  $A_{q-1}$  quivers, which describe the

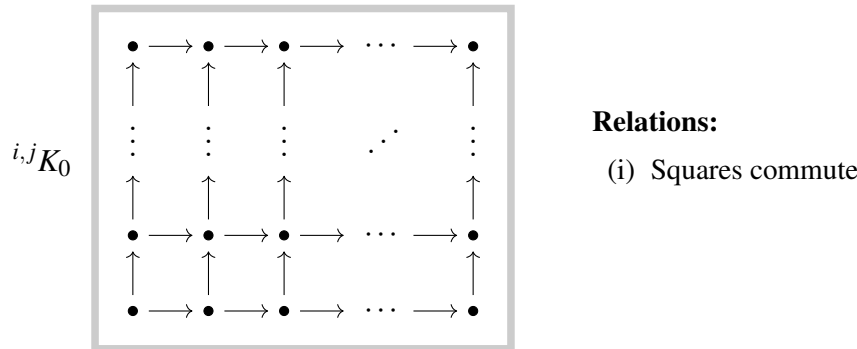

**Figure 3.15:** The quiver describing the category  $\mathcal{B}$  for Brieskorn–Pham polynomials.

one-variable graded matrix factorisations of  $x^p$  and  $y^q$  respectively.

To prove these objects generate, we just need to check that we can build all  $L/\mathbb{Z}\vec{c}$ -shifts of  $R/(x, y)$  from them. One easily constructs  $R(a\vec{x} + b\vec{y})/(x, y)$  for  $a = 1, \dots, p - 1, b = 1, \dots, q - 1$  by taking cones on these generators as in the previous cases. To construct the remaining shifts, note that the modules  $R(i\vec{x} + j\vec{y})/(x^i, y^j)$  and  $R(\vec{c})/(x^{p-i}, y^{q-j})$  are isomorphic in the singularity category, as they give rise to equivalent matrix factorisations. Taking  $i = p - 1$  and  $j = q - 1, q - 2, \dots, 1$  in

turn, we can inductively build the  $a = 0$  shifts from  $R(\vec{c})/(x^{p-i}, q^{q-j})$ . Reversing the roles of  $x$  and  $y$  gives the remaining shifts. In contrast to Remark 3.2.19 and Remark 3.4.8, the  $R(l)/(x, y)$  now generate the category, rather than just split-generate.

We conclude the following well-known result, which goes back to at least [FU09, Theorem 6], [FU11, Theorem 1.2]:

**Theorem 3.6.1** (Theorem 3.1.2, Brieskorn–Pham polynomial case). *The object*

$$\mathcal{E} := \bigoplus_{\substack{i=1, \dots, p-1 \\ j=1, \dots, q-1}}^{i,j} K_0$$

is a tilting object for  $\text{mf}(\mathbb{A}^2, \Gamma_{\mathbf{w}}, \mathbf{w})$ .

### 3.6.2 A-model

We consider the resonant Morsification  $\check{\mathbf{w}}_{\varepsilon} := \check{x}^p + \check{y}^q - \varepsilon \check{x} \check{y}$  of the Berglund–Hübsch transpose  $\check{\mathbf{w}} = \check{x}^p + \check{y}^q$ . The critical points are:

- (i)  $\check{x} = \check{y} = 0$
- (ii)  $\check{x}^{p-1} = \frac{\varepsilon \check{y}}{p}, \check{y}^{q-1} = \frac{\varepsilon \check{x}}{q}$ .

These are Morse, with critical values 0 and  $-\check{x} \check{y} \varepsilon (pq - p - q)/pq$  respectively. The equations (ii) reduce to

$$\check{x}^{(p-1)(q-1)-1} = \frac{\varepsilon^q}{p^{q-1}q} \quad \text{and} \quad \check{y} = \frac{p \check{x}^{p-1}}{\varepsilon},$$

so there is a unique positive real solution  $(\check{x}_{\text{crit}}^+, \check{y}_{\text{crit}}^+)$  whose critical value we denote by  $c_{\text{crit}}$  as before. All other critical points differ by the action of  $(pq - p - q)^{\text{th}}$  roots of unity with weights  $(q - 1, 1)$ , or equivalently  $(1, p - 1)$ , on  $(\check{x}, \check{y})$ . We parametrise these critical points, and the associated vanishing paths and cycles, by

$$(l, m) \in (\{0, \dots, p - 2\} \times \{0, \dots, q - 2\}) \setminus \{(p - 2, q - 2)\}$$

as

$$(\mu^{(q-1)l+m} \check{x}_{\text{crit}}^+, \mu^{l+(p-1)m} \check{y}_{\text{crit}}^+),$$

where  $\mu = e^{2\pi\sqrt{-1}/(pq-p-q)}$ .

The fibre  $\check{w}_\varepsilon^{-1}(0)$  is shown in Figure 3.16. This time it is irreducible. At infinity

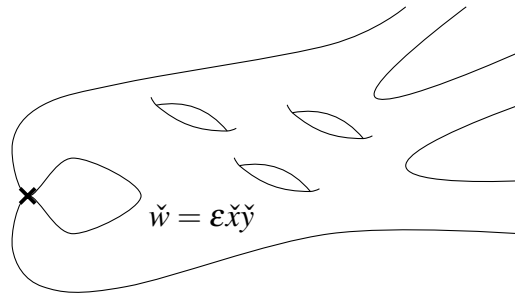

**Figure 3.16:** The fibre  $\check{w}_\varepsilon^{-1}(0)$  for Brieskorn–Pham polynomials.

the defining equation looks like  $\check{x}^p + \check{y}^q = 0$  so the smooth fibre  $\Sigma = \check{w}_\varepsilon^{-1}(-\delta)$  satisfies

$$\begin{aligned} \# \text{ punctures of } \Sigma &= \gcd(p, q) \\ g(\Sigma) &= \frac{1}{2}((p-1)(q-1) - \gcd(p, q) + 1). \end{aligned}$$

We divide  $\Sigma$  into  $\Sigma'$  and a single neck region, and trivialise the fibration on  $\Sigma'$  over a small disc. We define preliminary vanishing paths and cycles  $V_{\check{x}\check{y}}$  and  ${}^{l,m}V_0^{\text{pr}}$  as usual, taking

$$\theta_{l,m} = \frac{2\pi(ql + pm)}{pq - p - q}.$$

Note that by our bounds on  $l$  and  $m$  this lies in  $[0, 4\pi)$ . The cycle  $V_{\check{x}\check{y}}$  is the waist curve on the neck, whilst  ${}^{0,0}V_0^{\text{pr}}$  lives in the positive quadrant of the real part of  $\Sigma$ . The other  ${}^{l,m}V_0^{\text{pr}}$  are obtained from  ${}^{0,0}V_0^{\text{pr}}$  by the action of roots of unity on  $\Sigma'$  and by a local parallel transport computation on the neck. In particular, all intersections between the vanishing cycles occur on the neck. We modify the vanishing paths (and correspondingly perturb the fibration), introducing fingers to remove their intersections, in the familiar way.

There is now no need to isotope the cycles further, since they are already all transverse. In particular, on the  $V_{\check{x}\check{y}}$ -neck the argument of  $\check{x}$  along  ${}^{l,m}V_0^{\text{pr}}$  interpolates from

$$-2\pi \frac{l + (p-1)m}{pq - p - q} \quad \text{to} \quad 2\pi \frac{(q-1)l + m}{pq - p - q}$$

as its modulus increases. The intersection pattern is thus described by the morphisms in the quiver Figure 3.17, in the sense that the number of intersections between two curves is the dimension of the corresponding morphism space; the  $l$  and  $m$  indices decrease from bottom left to top right. This is not quite the pattern we want, but this

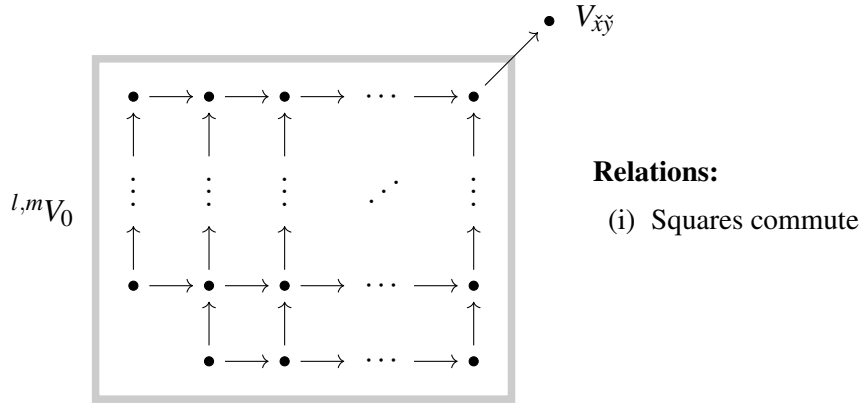

**Figure 3.17:** The quiver describing the intersection pattern.

can be rectified as follows. Recall that the ordering of the cycles is determined by the clockwise ordering of the directions of their vanishing paths as they emanate from the reference base point  $-\delta$ . We have so far been starting the ordering from the direction  $e^{\sqrt{-1}\theta}$  for  $0 < \theta \ll 2\pi$ , but we now change this to  $e^{-\sqrt{-1}\theta}$ . This has the effect of moving  $V_{x\check{y}}$  from last to first in the ordering, and hence modifying the quiver from Figure 3.17 to Figure 3.15.

**Remark 3.6.2.** *Alternatively, one can leave the starting direction as  $e^{\sqrt{-1}\theta}$  and instead replace the indexing set*

$$(\{0, \dots, p-2\} \times \{0, \dots, q-2\}) \setminus \{(p-2, q-2)\},$$

over which  $(l, m)$  ranges, by

$$(\{0, \dots, p-2\} \times \{0, \dots, q-2\}) \setminus \{(0, 0)\}.$$

*This moves the top right vertex inside the rectangle in Figure 3.17 to the bottom left. Now  $\theta_{l,m}$  lies in  $(0, 4\pi]$ , rather than  $[0, 4\pi)$ , so the prescription given at the start of*

Section 3.3.4 has to be modified so that  $\gamma'_{l,m}$  is described in modulus-(argument $+\pi$ ) space by the piecewise linear path:

- From  $(\delta, 0)$  to  $(\delta + \delta', \theta_{l,m})$  to  $(-c_{\text{crit}}, \theta_{l,m})$  for some small positive  $\delta'$ , if  $\theta_{l,m} \leq 2\pi$ .
- From  $(\delta, 0)$  to  $(\delta + \delta', 2\pi + \lambda \theta_{l,m})$  to  $(\delta + 2\delta', 2\pi + \lambda \theta_{l,m})$  to  $(\delta + 3\delta', \theta_{l,m} - \theta')$  to  $(-c_{\text{crit}}, \theta_{l,m} - \theta')$  for some small positive  $\lambda$  and  $\theta'$ , if  $\theta_{l,m} > 2\pi$ .

Note that the inequalities  $< 2\pi$  and  $\geq 2\pi$  have become  $\leq 2\pi$  and  $> 2\pi$ , whilst the  $\lambda(\theta_{l,m} - 4\pi)$  terms have become  $\lambda\theta_{l,m}$ , so that the short horizontal segments in Figure 3.6 are pushed slightly above the dashed  $2\pi$  line.

Compositions are non-degenerate by the standard argument, and we can arrange all signs to be positive. To fix gradings, we take the unique homotopy class of line field  $\ell$  on  $\Sigma$  with respect to which all vanishing cycles are gradable. We may assume  $\ell$  is longitudinal on the neck, and equip the  ${}^{l,m}V_0$  with the standard gradings (we choose the lift  $\alpha^\#$  to be approximately between 0 and  $1/2$ ). We previously gave  $V_{\check{x}\check{y}}$  the grading with  $\alpha^\# = -1/2$ , but now that we have changed the ordering we should choose  $\alpha^\# = 1/2$  to put all morphisms in degree 0.

We arrive at the following result Futaki–Ueda [FU09, Theorem 5], [FU11, Theorem 1.3]:

**Theorem 3.6.3** (Theorem 3.1.1, Brieskorn–Pham polynomial case). *Under the correspondence*

$$\begin{array}{l} {}^{l,m}V_0 \leftrightarrow {}^{i,j}K_0 \quad \text{with} \quad i+l = p-1 \\ V_{\check{x}\check{y}} \leftrightarrow {}^{1,1}K_0 \quad \quad \quad j+m = q-1 \end{array}$$

the  $\mathbb{Z}$ -graded  $A_\infty$ -category  $\mathcal{A}$  is described by Figure 3.15 and is formal, so there is a quasi-equivalence

$$\text{mf}(\mathbb{A}^2, \Gamma_{\mathbf{w}}, \mathbf{w}) \simeq D^b \mathcal{FS}(\check{\mathbf{w}}).$$

## Chapter 4

# Homological mirror symmetry for Milnor fibres of invertible curve singularities

### 4.1 Introduction

In this chapter, we study homological mirror symmetry where the A–models are Milnor fibres of invertible polynomials in two variables, and where we take the grading group on the B–side to be maximal. Our main theorem in this chapter is:

**Theorem 4.1.1.** *Let  $w$  be an invertible polynomial in two variables with maximal symmetry group  $\Gamma_w$ , and  $\check{w}$  its transpose. Then there is a quasi-equivalence*

$$D^\pi \mathcal{F}(\check{V}) \simeq \text{perf } Z_{w, \Gamma_w}$$

*of  $\mathbb{Z}$ -graded pretriangulated  $A_\infty$ -categories over  $\mathbb{C}$ , where  $Z_{w, \Gamma_w}$  is as in (1.6), and  $\check{V} := \check{w}^{-1}(1)$  is the Milnor fibre of  $\check{w}$ .*

#### 4.1.1 Strategy of proof

Our strategy follows that of [LU18], where one reduces the proof of Theorem 4.1.1 to a deformation theory argument. We give an overview of the general strategy here, although extrapolate on arguments as required in the case of curves in the subsequent sections. For the case at hand, this approach is predicated on the proof of Theorem

3.1.1 given in Chapter 3.

On the A–side of the correspondence, we have that there is a restriction functor

$$\begin{aligned} D^b \mathcal{FS}(\check{w}) &\rightarrow D^\pi \mathcal{F}(\check{V}) \\ S^\rightarrow &\mapsto \partial S^\rightarrow =: S, \end{aligned} \tag{4.1}$$

where we equip the vanishing cycle  $\partial S^\rightarrow$  with the induced (non-trivial) spin structure and (trivial) local system<sup>13</sup> and the trivial local system. Suppose that  $(S_i^\rightarrow)_{i=1}^{\check{\mu}}$  is a collection of thimbles which generates  $D^b \mathcal{FS}(\check{w})$ , where  $\check{\mu} = \mu(\check{w})$  is the Milnor number of  $\check{w}$ , and that  $\mathcal{S}^\rightarrow$  is the corresponding full subcategory of  $D^b \mathcal{FS}(\check{w})$  whose objects are  $(S_i^\rightarrow)_{i=1}^{\check{\mu}}$ . Denote its  $A_\infty$ -endomorphism algebra by

$$\mathcal{A}^\rightarrow := \bigoplus_{i,j}^{\check{\mu}} \text{hom}_{\mathcal{S}^\rightarrow}(S_i^\rightarrow, S_j^\rightarrow), \tag{4.2}$$

and its cohomology algebra  $A^\rightarrow := H^\bullet(\mathcal{A}^\rightarrow)$ . Correspondingly, let  $\mathcal{S}$  be the collection  $(S_i)_{i=1}^{\check{\mu}}$  of vanishing cycles equipped with the non-trivial spin structure, considered as a full subcategory of the compact Fukaya category of the Milnor fibre, and  $\mathcal{A}$  its  $A_\infty$ -endomorphism algebra. Poincaré duality, (2.2), tells us that we can identify  $H^\bullet(\mathcal{A})$  with

$$A := A^\rightarrow \oplus (A^\rightarrow)^\vee[1-n] \tag{4.3}$$

as a vector space. In our case, we will deduce in Section 4.5 that the algebra structure on  $A$  is induced purely from the  $A^\rightarrow$ -bimodule structure of  $(A^\rightarrow)^\vee[1-n]$ . Namely, we have

$$(a, f) \cdot (b, g) = (ab, ag + fb). \tag{4.4}$$

This is known as a trivial extension algebra of degree  $n - 1$ . By the argument of

---

<sup>13</sup>We use the notation  $S^\rightarrow$  here for vanishing cycles to distinguish from the specific vanishing cycles  $V$  studied in the previous chapter.



[Sei03, Lemma 5.4], when the weight  $\check{d}_0 \neq 0$ ,  $\mathcal{S}$  split generates the compact Fukaya category of the Milnor fibre, meaning

$$\mathrm{Tw}^\pi \mathcal{A} \simeq D^\pi \mathcal{F}(\check{V}).$$

Therefore, in order to characterise this category, it is sufficient to identify the  $A_\infty$ -structure on  $A$  which is given by  $\mathcal{A}$ , up to gauge transformation (a.k.a. formal diffeomorphism).

On the algebro-geometric side of the correspondence, again consider an admissible  $\Gamma \subseteq \Gamma_{\mathbf{w}}$  (we will later restrict ourselves to the maximally graded case). One can consider the Jacobi algebra,

$$\mathrm{Jac}_{\mathbf{w}} = \mathbb{C}[x_1, \dots, x_n] / (\partial_1 \mathbf{w}, \dots, \partial_n \mathbf{w}). \quad (4.5)$$

Since the singularity is isolated, this algebra has dimension  $\mu < \infty$ , the Milnor number of  $\mathbf{w}$ . Let  $J_{\mathbf{w}}$  be the set of exponents for a basis of this algebra (not to be confused with the grading element, which we are denoting by  $j_{\mathbf{w}}$ ), and consider the semi-universal unfoldings of  $\mathbf{w}$ ,

$$\tilde{\mathbf{w}} := \mathbf{w} + \sum_{\mathbf{j} \in J_{\mathbf{w}}} u_{\mathbf{j}} x_1^{j_1} \dots x_n^{j_n}. \quad (4.6)$$

Such unfoldings are universal in the sense that every other unfolding of  $\mathbf{w}$  is induced from  $\tilde{\mathbf{w}}$  by a change of coordinates; however, this change of coordinates is not necessarily unique. These semi-universal unfoldings are parametrised by  $\mu$  complex parameters, and we set

$$U := \mathrm{Spec} \mathbb{C}[u_1, \dots, u_\mu]. \quad (4.7)$$

We can therefore consider  $\tilde{\mathbf{w}}$  as a map

$$\tilde{\mathbf{w}} : \mathbb{A}^n \times U \rightarrow \mathbb{A}^1, \tag{4.8}$$

and define

$$\mathbf{w}_u := \tilde{\mathbf{w}}|_{\mathbb{A}^n \times \{u\}}. \tag{4.9}$$

To such a polynomial  $\mathbf{w}_u$ , we associate a stack  $V_u$ , defined in the case of two variables in (4.16). In the case where the weight  $d_0 > 0$ , we want to compactify  $V_u$  to a Calabi–Yau hypersurface in a quotient of weighted projective space by a finite group, although this is not possible for every  $u \in U$ . We extend the action of  $\Gamma$  on  $\mathbb{A}^n$  to  $\mathbb{A}^{n+1}$  as in (2.11), and define  $U_+ \subseteq U$  to be the subspace such that  $\mathbf{w}_u$  can be quasi-homogenised to  $\mathbf{W}_u \in \mathbb{C}[x_0, x_1, \dots, x_n]$  with respect to this action. Following [LU18], one then defines

$$Z_u := [(\mathbf{W}_u^{-1}(0) \setminus \{\mathbf{0}\})/\Gamma] \tag{4.10}$$

for each  $u \in U_+$ . It goes back to the work of Pinkham ([Pin74]), that the fact that  $\mathbf{w}$  is quasi-homogeneous forces there to be a  $\mathbb{C}^*$ -action on  $U_+$ . We therefore have that  $Z_u \simeq Z_v$  if and only if  $v = t \cdot u$  for some  $t \in \mathbb{C}^*$ . We then have that  $Z_u$  is a compactification of  $V_u$ , and its dualising sheaf is, by construction, trivial.

For each  $u \in U_+$  and fixed admissible group  $\Gamma$ , there is a functor

$$\mathrm{mf}(\mathbb{A}^n, \Gamma, \mathbf{w}) \rightarrow D^b \mathrm{Coh}(Z_u) \tag{4.11}$$

which is to be expounded upon in Section 4.2 for the case of curves. In any case where  $\mathrm{mf}(\mathbb{A}^n, \Gamma, \mathbf{w})$  has a tilting object,  $\mathcal{E}$ , denote by  $\mathcal{S}_u$  the image of  $\mathcal{E}$  by (4.11). It is then a theorem of Lekili and Ueda ([LU18, Theorem 4.1]) that  $\mathcal{S}_u$  split-generates  $\mathrm{perf} Z_u$ . Let  $\mathcal{A}_u$  be the minimal  $A_\infty$ -endomorphism algebra of  $\mathcal{S}_u$ . Then, by the work of Ueda in [Ued14], we have that  $A_u := H^\bullet(\mathcal{A}_u)$  is also given by the degree  $n - 1$

trivial extension algebra of the endomorphism algebra of  $\mathcal{E}$ , and is, in particular, independent of  $u$ .

In the maximally graded case ( $\Gamma = \Gamma_{\mathbf{w}}$ ), if Conjecture 1 is solved by exactly matching generators, as in Chapter 3, we have that, at the level of cohomology, the endomorphism algebra of the generators on both the A–, and B–sides are given by the same algebra, which we denote by  $A$ . In light of this, establishing the equivalence (1.7) boils down to identifying the  $A_{\infty}$ -structure given by the chain level endomorphism algebra on the B–side which matches with that of the A–side. With this perspective, homological mirror symmetry for Milnor fibres of invertible polynomials turns into a deformation theory problem.

Recall that for a graded algebra,  $A$ , the Hochschild cochain complex has a bigrading. Namely, we consider  $\mathrm{CC}^{r+s}(A, A)_s$  to be the space of maps  $A^{\otimes r} \rightarrow A[s]$ . In general, if  $\mu_{\bullet}$  is a minimal<sup>14</sup>  $A_{\infty}$ -structure on  $A$ , then deformations which keep  $\mu_k$  for  $1 \leq k \leq m$  fixed are controlled by  $\bigoplus_{i>m-2} \mathrm{HH}^2(A)_{-i}$  (see, for example, [Sei03, Section 3a]). In particular, the deformations of  $A$  to a minimal  $A_{\infty}$ -model with prescribed  $\mu_2$  are controlled by  $\mathrm{HH}^2(A)_{<0} = \bigoplus_{i>1} \mathrm{HH}^2(A)_{-i}$ . It is natural to consider the functor which takes an algebra to the set of gauge equivalence classes of  $A_{\infty}$ -structures on that algebra, and a theorem of Polishchuk ([Pol17, Corollary 3.2.5]) shows that if  $\mathrm{HH}^1(A)_{<0} = 0$ , then this functor is represented by an affine scheme,  $\mathcal{U}_{\infty}(A)$ . Moreover, if  $\dim \mathrm{HH}^2(A)_{<0} < \infty$ , then [Pol17, Corollary 3.2.6] shows that this scheme is of finite type. This functor was first studied in the context of homological mirror symmetry in [LP17a]. There is a natural  $\mathbb{C}^*$ -action on  $\mathcal{U}_{\infty}(A)$  given by sending  $\{\mu_k\}_{k=1}^{\infty}$  to  $\{t^{k-2}\mu_k\}_{k=1}^{\infty}$ , and this is denoted by  $\mathcal{A} \mapsto t^* \mathcal{A}$ . Note that the formal  $A_{\infty}$ -structure is the fixed point of this action. For each  $t \neq 0$ , we have that  $\mathcal{A}$  and  $t^* \mathcal{A}$  are quasi-isomorphic, although not through a gauge transformation ([Sei03, Section 3]).

---

<sup>14</sup>Recall that an  $A_{\infty}$ -structure is minimal if  $\mu_1 = 0$ .

Now, for each  $u \in U_+$ , we have that  $\mathcal{A}_u$  defines a minimal  $A_\infty$ -structure on  $A$  with  $\mu_2$  given as in (4.4). Therefore, it defines a point in  $\mathcal{U}_\infty(A)$ , and so we get a map

$$U_+ \rightarrow \mathcal{U}_\infty(A). \tag{4.12}$$

If we can show that (4.12) is an isomorphism, then we know that every  $A_\infty$ -structure on  $A$  is realised as the  $A_\infty$ -endomorphism algebra of  $\mathcal{S}_u$  for a unique  $u \in U_+$ . In the case that the pair  $(\mathbf{w}, \Gamma)$  is untwisted (see Definition 4.4.2), we have by a theorem of Lekili and Ueda ([LU18, Theorem 1.6], cf. Theorem 4.6.1) that there is a  $\mathbb{C}^*$ -equivariant isomorphism of affine varieties  $U_+ \xrightarrow{\sim} \mathcal{U}_\infty(A)$  which sends the origin to the formal  $A_\infty$ -structure. By removing the fixed point of the action on both sides, we have that this isomorphism descends to an isomorphism

$$(U_+ \setminus \{\mathbf{0}\})/\mathbb{C}^* \xrightarrow{\sim} (\mathcal{U}_\infty(A) \setminus \{\mathbf{0}\})/\mathbb{C}^* =: \mathcal{M}_\infty(A). \tag{4.13}$$

Therefore, in the maximally graded case where  $\mathbf{w}$  is untwisted, we have that, up to scaling, there is a unique  $u \in U_+$  for which (1.7) holds.

We end this section by briefly remarking that the moduli of  $A_\infty$ -structures argument employed in this chapter fits into a broader framework which has proven to be a fruitful approach to HMS, and whose scope is more wide-reaching than that of invertible polynomials. In [LP11b] and [LP11a], the authors establish HMS for the once punctured torus by studying the moduli space of  $A_\infty$ -structures on the degree one trivial extension algebra of the  $A_2$  quiver. Interestingly, it was proven that  $\mathcal{M}_\infty(A) \simeq \overline{\mathcal{M}}_{1,1}$ , the moduli space of elliptic curves. Further connection was made to the moduli theory of curves in [LP17c], where the authors show the moduli space of  $A_\infty$ -structures on a particular algebra coincides with the modular compactification of genus 1 curves with  $n$  marked points, as constructed in [Smy11]. This then leads them to prove homological mirror symmetry for the  $n$ -punctured torus in [LP17a].

### 4.1.2 Structure of the chapter

In Section 4.2, we recall some basic facts about unfoldings invertible polynomials in two variables, as well as compute  $U_+$  in the relevant cases. In Section 4.3.1, we study the symplectic topology of the Milnor fibre. In Section 4.4, we compute the relevant Hochschild cohomology for invertible polynomials in two variables. In Section 4.5, we recall some facts about generators and formality for Fukaya categories and the proper algebraic stacks under consideration. Section 4.6 is then a proof of Theorem 4.1.1.

## 4.2 Unfoldings of invertible polynomials in two variables

As in Chapter 3, we restrict ourselves to the case of invertible polynomials in two variables, and consider the variables  $x, y, z$  rather than  $x_1, x_2$ , and  $x_0$ , respectively. The purpose of this section is to extrapolate on some of the technical details of Section 4.1.1, and then to calculate the spaces of semi-universal unfoldings of the invertible polynomials under consideration.

As in Section 1.1 and Chapter 2, let  $\mathbf{w}$  be an invertible polynomial in two variables,  $\Gamma \subseteq \Gamma_{\mathbf{w}}$  an admissible subgroup of the maximal group of symmetries, and  $\hat{\Gamma}$  the corresponding group of characters. The Jacobi algebra of  $\mathbf{w}$  with Milnor number  $\mu$  is given in (4.5). Let  $J_{\mathbf{w}}$  be as in Section 4.1.1, and semi-universal unfoldings of  $\mathbf{w}$  be as in (4.6). Let  $U$  and  $\mathbf{w}_u$  be as in (4.7) and (4.9), respectively. As already noted, Pinkham ([Pin74]) observed that  $\mathbf{w}$  being quasi-homogeneous means that the space  $U$  comes with a natural  $\mathbb{C}^*$ -action on it. Namely, the action on  $u_{ij}$  is given by  $t \cdot u_{ij} = t^{h-d_1i-d_2j} u_{ij}$  where  $d_1$  and  $d_2$  are the weights of  $x$  and  $y$ , respectively, and  $u_{ij}$  is the coefficient of  $x^i y^j$  in the semi-universal unfolding. For a fixed  $u \in U$ , define  $\bar{R}_u := \mathbb{C}[x, y]/(\mathbf{w}_u)$ , and observe that by scaling  $x, y$ , one can identify  $\bar{R}_u \simeq \bar{R}_{t \cdot u}$  for  $t \in \mathbb{C}^*$ . The origin is the only fixed point of this action.

For a fixed  $\Gamma \subseteq \Gamma_{\mathbf{w}}$ , we would like to quasi-homogenise  $\mathbf{w}_u$  by extending the

action of  $\Gamma$  to  $\mathbb{A}^3$  according to (2.11). Therefore, the action on the  $z$  variable is given by setting

$$\chi_0(t_1, t_2) = \chi(t_1, t_2)t_1^{-1}t_2^{-1}. \quad (4.14)$$

With this weight, we want to restrict ourselves to the subspace  $U_+ \subseteq U$  for which  $\mathbf{w}_u$  is quasi-homogenisable. We define  $U_+$  to be the subset of  $u_{ij}$  in  $U$  for which there exists a positive integer  $w_{ij}$  such that

$$\chi = w_{ij}\chi_0 + i\chi_1 + j\chi_2,$$

which is equivalent to

$$\chi^{w_{ij}-1} = t_1^{w_{ij}-i}t_2^{w_{ij}-j}. \quad (4.15)$$

We then define  $\mathbf{W}_u$  to be the quasi-homogenisation of  $\mathbf{w}_u$  for each  $u \in U_+$ , and let  $J_+ \subseteq J_{\mathbf{w}}$  be the subset corresponding to the  $u_{ij}$  satisfying this condition. Unravelling the definition, this means that  $(i, j) \in J_+$  (equivalently,  $u_{ij} \in U_+$ ) if and only if there exists an integer  $w_{ij} > 0$  such that the monomial

$$u_{ij}x^i y^j z^{w_{ij}}$$

has weight  $\chi$ .

For a fixed  $u \in U_+$ , we set  $R_u := \mathbb{C}[x, y, z]/(\mathbf{W}_u)$ . By an abuse of notation, we will also denote the pullback of  $\mathbf{w}$  to  $\mathbb{A}^3$  by  $\mathbf{w}$ . We have that  $Z_u$  is defined as in (4.10), each  $Z_u$  is the compactification of

$$V_u := [(\mathrm{Spec} \bar{R}_u \setminus (\mathbf{0})) / \ker \chi_0], \quad (4.16)$$

and the divisor at infinity  $X_u = Z_u \setminus V_u$  is isomorphic to  $X = [(\mathrm{Spec} \bar{R}_0 \setminus (\mathbf{0})) / \Gamma]$  for each  $u \in U_+$ . The condition  $d_0 > 0$  ensures that each  $Z_u$  is a proper stack.

These  $\mathbf{W}_u$  fit together to form a family

$$\mathbf{W}_+ := \mathbf{w}(x, y) + \sum_{(i,j) \in J_+} u_{ij} x^i y^j z^{w_{ij}} : \mathbb{A}^3 \times U_+ \rightarrow \mathbb{A}^1$$

such that  $\mathbf{W}_u := \mathbf{W}_+|_{\mathbb{A}^3 \times \{u\}}$ . Following [LU18], we can then define

$$\mathcal{Z} := [(\mathbf{W}_+^{-1}(0) \setminus (\mathbf{0} \times U_+)) / \Gamma],$$

and this gives us a family

$$\pi_{\mathcal{Z}} : \mathcal{Y} \rightarrow U_+$$

of stacks over  $U_+$  such that  $\pi_{\mathcal{Z}}^{-1}(u) = Z_u$  for each  $u \in U_+$ . Note that since each fibre is the compactification of  $V_u$  by  $X$ , and  $V_u \simeq V_{t \cdot u}$  for  $t \in \mathbb{C}^*$ , we have that the fibres above points in the same  $\mathbb{C}^*$ -orbit of  $U_+$  are isomorphic. Furthermore, the relative dualising sheaf of this family is  $\Gamma$ -equivariantly trivial, by construction, and since  $d_0 > 0$ , this trivialisation is unique up to scaling.

The map  $R_u \rightarrow R_u/(z) \simeq \bar{R}_0$  induces a pushforward functor

$$\mathrm{mf}(\mathbb{A}^2, \Gamma, \mathbf{w}) \rightarrow \mathrm{mf}(\mathbb{A}^3, \Gamma, \mathbf{W}_u) \quad (4.17)$$

obtained by considering the 2-periodic free resolution of an  $\bar{R}_0$ -module, and replacing each free  $\bar{R}_0$  module with the  $R_u$ -free resolution

$$0 \rightarrow R_u(-\vec{z}) \xrightarrow{z} R_u \rightarrow \bar{R}_0 \rightarrow 0.$$

This is explained in detail, and in far greater generality, in [Ued14, Section 3].

For the quotient stack  $Z_u$ , since the dualising sheaf of  $Z_u$  is trivial for each

$u \in U_+$ , we have the Orlov equivalence

$$\text{mf}(\mathbb{A}^3, \Gamma, \mathbf{W}_u) \simeq D^b \text{Coh}(Z_u). \quad (4.18)$$

The composition of (4.17) and Orlov equivalence gives the functor (4.11).

Unless explicitly stated, we will only consider maximally graded case on the B-side for the rest of this section.

### 4.2.1 Unfoldings of loop polynomials

In the case of a two variable loop polynomial  $\mathbf{w} = x^p y + y^q x$ , we have  $\mu = pq$ , and

$$(d_1, d_2; h) = \left( \frac{q-1}{d}, \frac{p-1}{d}, \frac{pq-1}{d} \right), \quad (4.19)$$

where  $d := \gcd(p-1, q-1)$ . Without loss of generality, we can assume that  $p \geq q$ .

One has that

$$\text{Jac}_{\mathbf{w}} = \text{span}\{1, x, \dots, x^{p-1}\} \otimes \text{span}\{1, y, \dots, y^{q-1}\}, \quad (4.20)$$

and

$$\begin{aligned} \Gamma_{\mathbf{w}} &= \{(t_1, t_2) \in (\mathbb{C}^*)^2 \mid t_1^p t_2 = t_2^q t_1\} \xrightarrow{\sim} \mathbb{C}^* \times \mu_d \\ &\quad (t_1, t_2) \mapsto (t_1^n t_2^m, t_1^{\frac{p-1}{d}} t_2^{-\frac{q-1}{d}}), \end{aligned} \quad (4.21)$$

where  $m, n$  is a fixed solution to

$$m(p-1) + n(q-1) = d. \quad (4.22)$$

The image of the injective homomorphism

$$\begin{aligned} \varphi : \mathbb{C}^* &\rightarrow \Gamma_{\mathbf{w}} \\ t &\mapsto (t^{\frac{q-1}{d}}, t^{\frac{p-1}{d}}) \end{aligned}$$



is an index  $d$  subgroup of  $\Gamma_{\mathbf{w}}$ ; however, we will only be interested in the maximal symmetry group, i.e.  $\Gamma = \Gamma_{\mathbf{w}}$ . A semi-universal unfolding is given by

$$\tilde{\mathbf{w}}(x, y) = x^p y + y^q x + \sum_{\substack{0 \leq i \leq p-1 \\ 0 \leq j \leq q-1}} u_{ij} x^i y^j. \quad (4.23)$$

By definition,  $U_+$  is the subspace of  $U$  containing elements such that there exists a positive integer  $w_{ij}$  such that

$$(t_1^p t_2)^{w_{ij}-1} = t_1^{w_{ij}-i} t_2^{w_{ij}-j}.$$

There are three possibilities for  $U_+$ , and in each case follows by direct computation:

Case I: For  $q > 2$  the only solution to this is  $i = j = w_{ij} = 1$ , and so  $U_+ = \text{Spec } \mathbb{C}[u_{1,1}] = \mathbb{A}^1$ .

Case II:  $p > q = 2$ , we have  $i = j = w_{ij} = 1$ , as well as  $j = 0, i = 1$ , and  $w_{ij} = 2$ , and so  $U_+ = \text{Spec } \mathbb{C}[u_{1,0}, u_{1,1}] = \mathbb{A}^2$ .

Case III: When  $p = q = 2$ , we have  $i = j = w_{ij} = 1$ ,  $j = 0, i = 1$ ,  $w_{ij} = 2$ ,  $j = 1, i = 0$ ,  $w_{ij} = 2$ , as well as  $i = j = 0$ ,  $w_{ij} = 3$ , and so  $U_+ = \text{Spec } \mathbb{C}[u_{0,0}, u_{1,0}, u_{0,1}, u_{1,1}] = \mathbb{A}^4$ .

## 4.2.2 Unfoldings of chain polynomials

In the case of a two variable chain polynomial  $\mathbf{w} = x^p y + y^q$ , we have  $\mu = pq - q + 1$ , and

$$(d_1, d_2; h) = \left( \frac{q-1}{d}, \frac{p}{d}; \frac{pq}{d} \right), \quad (4.24)$$

where  $d := \gcd(p, q-1)$ .

**Remark 4.2.1.** *It should be stressed that this is the Milnor number on the B-side. In the loop and Brieskorn–Pham cases the matrices defining the polynomials are*

symmetric, and the Milnor numbers of both sides will be the same, but this is not the case for chain polynomials.

One has that

$$\text{Jac}_{\mathbf{w}} = \text{span}\{1, x, \dots, x^{p-2}\} \otimes \text{span}\{1, y, \dots, y^{q-1}\} \oplus \text{span}\{x^{p-1}\}, \quad (4.25)$$

and

$$\begin{aligned} \Gamma_{\mathbf{w}} &= \{(t_1, t_2) \in (\mathbb{C}^*)^2 \mid t_1^p t_2 = t_2^q\} \xrightarrow{\sim} \mathbb{C}^* \times \mu_d \\ &\quad (t_1, t_2) \mapsto (t_1^n t_2^m, t_1^{\frac{p}{d}} t_2^{-\frac{q-1}{d}}), \end{aligned} \quad (4.26)$$

where  $m, n$  is a fixed solution to

$$mp + n(q - 1) = d. \quad (4.27)$$

The image of the injective homomorphism

$$\begin{aligned} \varphi : \mathbb{C}^* &\rightarrow \Gamma_{\mathbf{w}} \\ t &\mapsto (t^{\frac{q-1}{d}}, t^{\frac{p}{d}}) \end{aligned}$$

is an index  $d$  subgroup of  $\Gamma_{\mathbf{w}}$ , but again we will only be interested in the maximal symmetry group. A semi-universal unfolding is given by

$$\tilde{\mathbf{w}}(x, y) = x^p y + y^q + \sum_{\substack{0 \leq i \leq p-2 \\ 0 \leq j \leq q-1}} u_{ij} x^i y^j + u_{p-1,0} x^{p-1}. \quad (4.28)$$

By definition,  $U_+$  is the subspace of  $U$  containing elements such that there exists a positive integer  $w_{ij}$  such that

$$(t_1^p t_2)^{w_{ij}-1} = t_1^{w_{ij}-i} t_2^{w_{ij}-j}.$$

For chain polynomials, there are five different cases of  $U_+$  to consider:

Case I: When  $p, q > 2$ , the only solution is  $i = j = w_{ij} = 1$ , and so  $U_+ = \text{Spec } \mathbb{C}[u_{1,1}] = \mathbb{A}^1$ .

Case II: In the case where  $p = 2, q > 2$  the only solution is  $i = 0, j = 1, w_{ij} = 2$ , and so  $U_+ = \text{Spec } \mathbb{C}[u_{0,1}] = \mathbb{A}^1$ .

Case III: In the case where  $q = 2, p > 3$ , we have  $i = j = w_{ij} = 1$ , as well as  $j = 0, i = 2$ , and  $w_{ij} = 2$ , and so  $U_+ = \text{Spec } \mathbb{C}[u_{1,1}, u_{2,0}] = \mathbb{A}^2$ .

Case IV: When  $p = 3, q = 2$ , we have  $i = j = w_{ij} = 1, j = 0, i = 2, w_{ij} = 2$ , and  $i = j = 0, w_{ij} = 3$ , so  $U_+ = \text{Spec } \mathbb{C}[u_{0,0}, u_{1,1}, u_{2,0}] = \mathbb{A}^3$ .

Case V: In the case when  $p = q = 2$ , we have  $j = 0, i = 1, w_{ij} = 3$ , as well as  $i = j = 0, w_{ij} = 4$ , and  $i = 0, j = 1$ , and  $w_{ij} = 2$ , and so  $U_+ = \text{Spec } \mathbb{C}[u_{0,0}, u_{1,0}, u_{0,1}] = \mathbb{A}^3$ .

### 4.2.3 Unfoldings of Brieskorn–Pham polynomials

In the case of a two variable Brieskorn–Pham polynomial  $\mathbf{w} = x^p + y^q$ , we have  $\mu = (p-1)(q-1)$ , and

$$(d_1, d_2; h) = \left( \frac{q}{d}, \frac{p}{d}; \frac{pq}{d} \right), \quad (4.29)$$

where  $d := \gcd(p, q)$ . One has that

$$\text{Jac}_{\mathbf{w}} = \text{span}\{1, x, \dots, x^{p-2}\} \otimes \text{span}\{1, y, \dots, y^{q-2}\}, \quad (4.30)$$

and

$$\begin{aligned} \Gamma_{\mathbf{w}} &= \{(t_1, t_2) \in (\mathbb{C}^*)^2 \mid t_1^p = t_2^q\} \xrightarrow{\sim} \mathbb{C}^* \times \mu_d \\ &(t_1, t_2) \mapsto (t_1^n t_2^m, t_1^{\frac{p}{d}} t_2^{-\frac{q}{d}}), \end{aligned} \quad (4.31)$$

where  $m, n$  is a fixed solution to

$$mp + nq = d. \tag{4.32}$$

The image of the injective homomorphism

$$\begin{aligned} \varphi : \mathbb{C}^* &\rightarrow \Gamma_{\mathbf{w}} \\ t &\mapsto (t^{\frac{q}{d}}, t^{\frac{p}{d}}) \end{aligned}$$

is an index  $d$  subgroup of  $\Gamma_{\mathbf{w}}$ , but as in the loop and chain cases, we are only interested in the maximal symmetry group. A semi-universal unfolding is given by

$$\tilde{\mathbf{w}}(x, y) = x^p + y^q + \sum_{\substack{0 \leq i \leq p-2 \\ 0 \leq j \leq q-2}} u_{ij} x^i y^j. \tag{4.33}$$

By definition,  $U_+$  is the subspace of  $U$  containing elements such that there exists a positive integer  $w_{ij}$  such that

$$(t_1^p)^{w_{ij}-1} = t_1^{w_{ij}-i} t_2^{w_{ij}-j}.$$

For Brieskorn–Pham polynomials, we have the following five cases:

Case I: In the case  $p \geq q > 3$ , the only solution is  $i = j = w_{ij} = 1$ , and so  $U_+ = \text{Spec } \mathbb{C}[u_{1,1}] = \mathbb{A}^1$ .

Case II: In the case where  $p = 3$  and  $q = 2$ , we have  $i = 1, j = 0$  and  $w_{ij} = 4$ , as well as  $i = j = 0$  and  $w_{ij} = 6$ , so  $U_+ = \text{Spec } \mathbb{C}[u_{0,0}, u_{1,0}] = \mathbb{A}^2$ .

Case III: In the case when  $p = q = 3$ , we have  $i = j = w_{ij} = 1$ , as well as  $i = j = 0, w_{ij} = 3$ , and so  $U_+ = \text{Spec } \mathbb{C}[u_{0,0}, u_{1,1}] = \mathbb{A}^2$ .

Case IV: In the case where  $p = 4$ ,  $q = 2$ , we have  $j = 0$ ,  $i = 2$ ,  $w_{ij} = 2$ , and  $i = j = 0$ ,  $w_{ij} = 4$ . Therefore  $U_+ = \text{Spec } \mathbb{C}[u_{0,0}, u_{2,0}] = \mathbb{A}^2$ .

Case V: In the case where  $p > 4$  and  $q = 2$ , we have  $i = w_{ij} = 2$  and  $j = 0$ , so  $U_+ = \text{Spec } \mathbb{C}[u_{2,0}] = \mathbb{A}^1$ .

## 4.3 Symplectic topology of the Milnor fibre

Let  $\Sigma$  be a smooth, compact, orientated surface of genus  $g > 0$  with  $b > 0$  connected boundary components  $\partial\Sigma = \sqcup_{i=1}^b \partial_i\Sigma$ . The surface to have in mind is the Milnor fibre of an invertible polynomial,  $\check{V}$ . Note that by an abuse of notation, we will not distinguish between the Milnor fibre and its completion, since what we mean will be clear from context.

### 4.3.1 Graded symplectomorphisms

In this subsection, we expand on the discussion of graded symplectic surfaces in Section 3.3.7 with the goal of providing a self-contained summary of Lemma 4.3.3. This provides criteria to ascertain when two graded symplectic surfaces are graded symplectomorphic, in particular allowing us to identify when two Milnor fibres are graded symplectomorphic. We will use this analysis to identify how the relevant Milnor fibres can be glued from cylinders, and, later, also to establish Corollary 1.

As discussed in Section 3.3.7, for a  $2n$ -dimensional symplectic manifold,  $(X, \omega)$ , there is a natural Lagrangian Grassmannian bundle  $\text{LGr}(TX) \rightarrow X$ , whose fibre at  $x \in X$  is the Grassmannian of Lagrangian  $n$ -planes in  $T_xX$ . We say  $(X, \omega)$  is  $\mathbb{Z}$ -gradable if it admits a lift to  $\widetilde{\text{LGr}}(TX)$ , the fibrewise universal cover of the Lagrangian Grassmannian bundle. This is possible if and only if  $2c_1(X) = 0$  in  $H^2(X)$ , and this implies that  $K_X^{\otimes -2}$ , the square of the anticanonical bundle, is trivial. If  $X$  is gradable, then a grading is given by a choice of homotopy class of trivialisation of  $K_X^{\otimes -2}$ . For

a trivialising section  $\Theta \in \Gamma(X, K_X^{\otimes -2})$ , one has a map

$$\begin{aligned} \alpha_X : \text{LGr}(TX) &\rightarrow S^1 \\ L_x &\mapsto \arg(\Theta|_{L_x}). \end{aligned}$$

Given a compact, exact Lagrangian submanifold,  $L$ , this defines a section of  $\text{LGr}(TX)$  by considering the tangent space to  $L$  at each point. We say that  $L$  is gradable with respect to a grading on  $X$  if there exists a function  $\alpha_X^\# : L \rightarrow \mathbb{R}$  such that  $\exp(2\pi i \alpha_X^\#(x)) = \alpha_X(T_x L)$ . This is possible if and only if the Maslov class of  $L$  vanishes, where the Maslov class is defined by the homotopy class of the map  $L \rightarrow \text{LGr}(TX) \xrightarrow{\alpha_X} S^1$ .

As explained in [Sei08b, Section 13(c)], on a (real) 2-dimensional surface,  $\Sigma$ , gradings correspond to trivialisations of the real projectivised tangent bundle,  $\mathbb{P}_{\mathbb{R}}(T\Sigma) \simeq \text{LGr}(T\Sigma)$ . Recall that a line field is a section of  $\mathbb{P}_{\mathbb{R}}(T\Sigma)$ . Supposing that a grading of  $\Sigma$  is chosen such that  $\alpha_\Sigma$  is as above, then one can define a line field on the surface given by  $\eta = \alpha_\Sigma^{-1}(1)$ . Conversely, a nowhere vanishing line field gives rise to a map  $\alpha_\Sigma$  by recording the anticlockwise angle between the line field and any other line in the tangent plane. In this way, line fields correspond naturally to gradings on a surface,  $\Sigma$ .

Given a line field,  $\eta$ , which grades  $\Sigma$ , and a Lagrangian,  $L$ , represented by an embedded curve  $\gamma : S^1 \rightarrow \Sigma$ , the map which corresponds to the Maslov class is given by recording the anticlockwise angle from  $\eta_x$  to  $T_x L$  at each point  $x \in L$ . The Maslov class vanishes, and hence  $L$  is gradable with respect to  $\eta$ , if and only if the sections  $\gamma^* \eta$  and  $\gamma^* TL$  are homotopic in  $\gamma^* \mathbb{P}_{\mathbb{R}}(T\Sigma)$ . A grading of  $L$  is a choice of homotopy between them.

We denote the space of line fields by  $G(\Sigma) := \pi_0(\Gamma(\Sigma, \mathbb{P}_{\mathbb{R}}(T\Sigma)))$ , and this has the natural structure of a torsor over the group of homotopy classes of maps  $\Sigma \rightarrow S^1$ ,

which we identify with  $H^1(\Sigma)$ . With this in mind, consider the trivial circle fibration

$$S^1 \xrightarrow{\iota} \mathbb{P}_{\mathbb{R}}(T\Sigma) \xrightarrow{P} \Sigma, \quad (4.34)$$

which induces the exact sequence

$$0 \rightarrow H^1(\Sigma) \xrightarrow{P^*} H^1(\mathbb{P}_{\mathbb{R}}(T\Sigma)) \xrightarrow{\iota^*} H^1(S^1) \rightarrow 0. \quad (4.35)$$

Note that the orientation of  $\Sigma$  induces an orientation on each tangent fibre, and so the map  $\iota$  is unique up to homotopy. For each line field, we can associate an element  $[\eta] \in H^1(\mathbb{P}_{\mathbb{R}}(T\Sigma))$  by considering the Poincaré–Lefschetz dual of  $[\eta(\Sigma)] \in H_2(\mathbb{P}_{\mathbb{R}}(T\Sigma), \partial\mathbb{P}_{\mathbb{R}}(T\Sigma))$ . These are precisely the elements such that  $\iota^*([\eta])([S^1]) = 1$ , and this is the content of [LP20, Lemma 1.1.2].

As already mentioned, for an embedded curve  $\gamma: S^1 \rightarrow \Sigma$ , there is a corresponding section of the Lagrangian Grassmannian,  $\tilde{\gamma}: S^1 \rightarrow \mathbb{P}_{\mathbb{R}}(T\Sigma)$ . This is given by  $(\gamma, [T\gamma])$ , where  $[T\gamma]$  is the projectivisation of the tangent space to the curve  $\gamma$ .

**Definition 4.3.1.** *Given a line field,  $\eta$ , on  $\Sigma$ , and an immersed curve  $\gamma: S^1 \rightarrow \Sigma$ , we define the winding number of  $\gamma$  with respect to  $\eta$  as*

$$w_{\eta}(\gamma) := \langle [\eta], [\tilde{\gamma}] \rangle, \quad (4.36)$$

where  $\langle \cdot, \cdot \rangle: H^1(\mathbb{P}_{\mathbb{R}}(T\Sigma)) \times H_1(\mathbb{P}_{\mathbb{R}}(T\Sigma)) \rightarrow \mathbb{Z}$  is the natural pairing.

This pairing only depends on the homotopy class of  $\eta$ , as well as the regular homotopy class of  $\gamma$ . Recall that, for the case of surfaces, the Maslov number of a Lagrangian is precisely its winding number with respect to the line field used to grade the surface. Therefore, a Lagrangian is gradable with respect to a line field if and only if its winding number with respect to this line field vanishes. Since we will be considering the Milnor fibre of a Lefschetz fibration, we must again consider the grading on the Milnor fibre which is induced by the restriction of the unique grading of  $\mathbb{C}^2$  to  $\Sigma$ . This is crucial so that the functor (4.1) is graded, and therefore

that (4.3) holds. As in Section 3.3.7, we have that the grading on the Milnor fibre is given by a line field  $\ell$  such that  $w_\ell(V_i) = 0$  for each vanishing cycle  $V_i$ . Since the vanishing cycles form a basis of  $H_1(\Sigma)$ , the fact that the winding number around each Lagrangian is zero implies that the homotopy class of  $\ell$  is unique.

For any symplectomorphism  $\varphi : \Sigma_1 \rightarrow \Sigma_2$  and  $\eta_2 \in G(\Sigma_2)$ , one can consider the line field on  $\Sigma_1$  given by

$$\varphi^*(\eta_2)(x) := [(T_x\varphi)^{-1}(\eta_2 \circ \varphi(x))] \quad \text{for all } x \in \Sigma_1. \quad (4.37)$$

If one has  $(\Sigma_1; \eta_1)$  and  $(\Sigma_2; \eta_2)$ , where  $\eta_1$  and  $\eta_2$  are line fields used to grade the surfaces  $\Sigma_1$  and  $\Sigma_2$ , respectively, we say that a symplectomorphism  $\varphi : \Sigma_1 \rightarrow \Sigma_2$  is *graded* if  $\varphi^*\eta_2$  is homotopic to  $\eta_1$ . If one takes  $\Sigma_1 = \Sigma_2$ , then we define  $\text{Symp}(\Sigma; \partial\Sigma)$  to be the space of symplectomorphisms of  $\Sigma$  which fix  $\partial\Sigma$  pointwise. One can then define the *pure symplectic mapping class group* of  $\Sigma$  as

$$\mathcal{M}(\Sigma; \partial\Sigma) := \pi_0(\text{Symp}(\Sigma; \partial\Sigma)), \quad (4.38)$$

and observe that this group acts on  $G(\Sigma)$  as in (4.37). The decomposition of  $G(\Sigma)$  into  $\mathcal{M}(\Sigma; \partial\Sigma)$ -orbits is given in [LP20, Theorem 1.2.4], and this allows one to deduce [LP20, Corollary 1.2.6], which appears as Lemma 4.3.3, below. In what follows, we briefly recall the relevant invariants, as well as techniques for their computation, in order to be able to state, and later utilise, Lemma 4.3.3.

For a given line field  $\eta$ , consider

$$w_\eta(\partial_i\Sigma), \quad \text{for } i \in \{1, \dots, b\},$$

the winding numbers around the boundary components. For two line fields to be homotopic, it is necessary for the winding numbers around each boundary component to agree, although this is definitely not sufficient. In particular, one can have two line



fields which agree on the boundary, but which differ along interior non-separating curves.

Recall that for a closed, orientated Riemann surface,  $\bar{\Sigma}$ , a theorem of Atiyah in [Ati71] proves the existence of a quadratic form  $\varphi : \mathcal{S}(\bar{\Sigma}) \rightarrow \mathbb{Z}_2$ , where  $\mathcal{S}(\bar{\Sigma})$  is the space of spin structures on  $\bar{\Sigma}$ ,  $\varphi$  does not depend on the complex structure of  $\bar{\Sigma}$ , and the associated bilinear form on  $H^1(\bar{\Sigma}, \mathbb{Z}_2)$  is the cup product. Note that  $\mathcal{S}(\bar{\Sigma})$  is a torsor over  $H^1(\bar{\Sigma}, \mathbb{Z}_2)$ , and  $\varphi$  being a quadratic form on  $\mathcal{S}(\bar{\Sigma})$  means that it is a quadratic form on  $H^1(\bar{\Sigma}, \mathbb{Z}_2)$  for any choice of basepoint. Moreover, the associated bilinear form doesn't depend on the basepoint. He also proves that there are precisely two orbits of the mapping class group of  $\bar{\Sigma}$  on  $\mathcal{S}(\bar{\Sigma})$ , and these are distinguished by the invariant  $\varphi$ , which is known as the *Atiyah invariant*. In [Joh80], Johnson gives a topological interpretation of the Atiyah invariant by proving that it is the Arf invariant of the corresponding quadratic form on  $H_1(\bar{\Sigma}, \mathbb{Z}_2)$ .

The Arf invariant is well studied in topology, and we briefly recount some basic facts about it, as well as some computation techniques. Let  $(\bar{V}, (- \cdot -))$  be a vector space over  $\mathbb{Z}_2$  with a non-degenerate bilinear form, and  $\bar{q} : \bar{V} \rightarrow \mathbb{Z}_2$  a quadratic form satisfying

$$\bar{q}(a + b) = \bar{q}(a) + \bar{q}(b) + (a \cdot b). \quad (4.39)$$

It is well-known that the Gauß sum

$$\text{GS}(\bar{q}) = \sum_{x \in \bar{V}} (-1)^{\bar{q}(x)} = \pm 2^{\frac{\dim \bar{V}}{2}}, \quad (4.40)$$

and the sign is the *Arf invariant* of the quadratic form. I.e.

$$\text{GS}(\bar{q}) = (-1)^{\text{Arf}(\bar{q})} 2^{\frac{\dim \bar{V}}{2}}, \quad (4.41)$$

$\text{Arf}(\bar{q}) \in \mathbb{Z}_2$ .

To compute the Arf invariant, one can just compute the Gauß sum, although, except in particularly nice circumstances, this can become computationally intractable quite quickly. One can also find a base change to a symplectic basis where the formula simplifies, although we will not do this. Instead, consider the basis  $\{e_1, \dots, e_{2n}\}$  of  $\bar{V}$ , and the matrix defined by

$$f_{ii} = \begin{cases} 2 & \text{if } \bar{q}(e_i) = 1 \\ 0 & \text{if } \bar{q}(e_i) = 0 \end{cases}$$

$$f_{ij} = \begin{cases} 1 & \text{if } e_i \cdot e_j = 1 \\ 0 & \text{if } e_i \cdot e_j = 0 \end{cases}$$

where  $i \neq j$ . Such a matrix defines an even quadratic form on a  $\mathbb{Z}_{(2)}$  module,  $V$ , whose mod 2 reduction gives the bilinear pairing on  $\bar{V}$ . The precise module structure of  $V$  is not important, since  $\det f$  is well defined mod 8, and this value only depends on  $\bar{q}$ . One then has

$$\text{Arf}(\bar{q}) = \begin{cases} 0 & \text{if } \det f = \pm 1 \pmod{8} \\ 1 & \text{if } \det f = \pm 3 \pmod{8}. \end{cases}$$

The standard reference for proof and further discussion of these facts is [HM06, Chapter 9].

Returning to the case at hand, recall that a non-vanishing vector field induces a spin structure on any compact Riemann surface with boundary. If the winding number around each boundary component with respect to this vector field is 2 mod 4, then this spin structure extends to the closed Riemann surface obtained by capping off the boundary components with discs,  $\bar{\Sigma}$ . Any vector field also yields a line field by considering the projectivisation, and each embedded curve has an even winding number with respect to this line field. Conversely, it is shown in [LP20, Lemma

1.1.4] that if each embedded curve has even winding number with respect to a line field, then this line field arises as the projectivisation of a vector field. In light of this, in the case when two line fields have matching winding numbers around boundary components, arise from the projectivisation of vector fields, and where these vector fields define spin structures which extend to  $\bar{\Sigma}$ , one must check that the corresponding Atiyah invariants of these spin structures agree.

A useful fact is that, by the Poincaré–Hopf index theorem, (see, for example, [Hop83, Chapter 3]) for any compact  $S \subseteq \Sigma$ , we have

$$\sum_i^b w_\eta(\partial_i(S)) = 2\chi(S), \quad (4.42)$$

where  $\chi(S)$  is the Euler characteristic. It is therefore clear that the winding number does not descend to a homomorphism from  $H_1(\Sigma)$ . What is true, however, is that one can consider for each line field  $\eta$  the following homomorphism, given by the mod 2 reduction of the winding number:

$$[w_\eta]^{(2)} : H_1(\Sigma, \mathbb{Z}_2) \rightarrow \mathbb{Z}_2.$$

From this, we can define the following invariant.

**Definition 4.3.2.** *We define the  $\mathbb{Z}_2$ -valued invariant*

$$\sigma : G(\Sigma) \rightarrow \mathbb{Z}_2$$

$$\eta \mapsto \begin{cases} 0 & \text{if } [w_\eta]^{(2)} = 0 \\ 1 & \text{otherwise.} \end{cases}$$

In the case when  $\sigma(\eta) = 0$ , and so  $\eta$  is the projectivisation of a vector field,  $v$ , we need to check when the spin structure on  $\Sigma$  defined by  $v$  extends to a spin structure on  $\bar{\Sigma}$ , and if it does, calculate the corresponding Atiyah invariant.

For a line field (not necessarily coming from the projectivisation of a vector

field),  $\eta$ , the existence of a quadratic form

$$q_\eta : H_1(\Sigma, \mathbb{Z}_4) \rightarrow \mathbb{Z}_4$$

defined by

$$q_\eta \left( \sum_{i=1}^m \alpha_i \right) = \sum_{i=1}^m w_\eta(\alpha_i) + 2m \in \mathbb{Z}_4,$$

where  $\alpha_i$  are simple closed curves, and whose associated bilinear form is twice the intersection pairing on  $H_1(\Sigma, \mathbb{Z}_4)$  is established in [LP20, Proposition 1.2.2]. It is proven in [LP20, Lemma 1.2.3] that for  $g(\Sigma) \geq 2$ , two line fields,  $\eta$ ,  $\theta$ , lie in the same  $\mathcal{M}(\Sigma; \partial\Sigma)$ -orbit if the winding numbers agree on each boundary component, and  $q_\eta = q_\theta$ . In the case when  $\eta$  and  $\theta$  come from the projectivisation of vector fields, but the corresponding spin structures do not extend to  $\bar{\Sigma}$ , or when the two line fields do not arise as the projectivisation of vector fields, it is enough to show that  $\sigma(\eta) = \sigma(\theta)$ , and that the winding numbers on the boundary components agree. In the case where  $\eta$  and  $\theta$  are line fields such that  $\sigma(\eta) = \sigma(\theta) = 0$ , and

$$w_\eta(\partial_i(\Sigma)) = w_\theta(\partial_i(\Sigma)) \in 2 + 4\mathbb{Z} \quad \text{for each } i \in \{1, \dots, b\}, \quad (4.43)$$

we must compare the corresponding Atiyah invariants.

Recall that the inclusion  $\partial\Sigma \xrightarrow{l} \Sigma$  induces a map

$$l_* : \mathbb{Z}_2^b \simeq H_1(\partial\Sigma, \mathbb{Z}_2) \rightarrow H_1(\Sigma, \mathbb{Z}_2) \simeq \mathbb{Z}_2^{2g+b-1}. \quad (4.44)$$

The kernel of the intersection pairing on  $H_1(\Sigma, \mathbb{Z}_2)$  is spanned by the image of  $l_*$ , and the cokernel is naturally identified with  $H_1(\bar{\Sigma}, \mathbb{Z}_2)$ , where  $\bar{\Sigma}$  is as above. The intersection form on  $H_1(\Sigma, \mathbb{Z}_2)$  descends to a non-degenerate intersection form on  $H_1(\bar{\Sigma}, \mathbb{Z}_2)$ .

By the fact that  $\sigma(\eta) = \sigma(\theta) = 0$ , we have that the function

$$q/2 : H_1(\Sigma, \mathbb{Z}_2) \rightarrow \mathbb{Z}_2 \quad (4.45)$$

is well defined, where  $q$  is either  $q_\eta$  or  $q_\theta$ . By (4.43), we have that  $q/2(\partial_i \Sigma) \equiv 0 \pmod{2}$  for each  $i \in \{1, \dots, b\}$ . Since the kernel of the intersection pairing on  $H_1(\Sigma, \mathbb{Z}_2)$  is spanned by the boundary curves,  $q/2$  descends to a non-singular quadratic form

$$\bar{q} : H_1(\bar{\Sigma}, \mathbb{Z}_2) \rightarrow \mathbb{Z}_2$$

such that

$$\bar{q}(\alpha + \beta) = \bar{q}(\alpha) + \bar{q}(\beta) + (\alpha \cdot \beta), \quad (4.46)$$

and  $\text{Arf}(\bar{q})$  gives the last invariant required to ascertain whether two line fields are in the same  $\mathcal{M}(\Sigma; \partial \Sigma)$ -orbit in the case where  $g(\Sigma) \geq 2$ . In the case when  $g = 1$ , we define

$$\tilde{A}(\eta) := \gcd\{w_\eta(\alpha), w_\eta(\beta), w_\eta(\partial_1 \Sigma) + 2, \dots, w_\eta(\partial_b \Sigma) + 2\}, \quad (4.47)$$

where  $\alpha$  and  $\beta$  are non-separating curves which project to a basis of  $H_1(\Sigma, \mathbb{Z}_2)/\text{im}(i_*)$ .

Putting this all together, [LP20, Theorem 1.2.4] gives criteria for two line fields to be in the same mapping class group orbit. Using this, the authors give criteria for there to exist a graded symplectomorphism between two *different* surfaces.

**Lemma 4.3.3** ([LP20, Corollary 1.2.6]). *Let  $(\Sigma_1; \eta_1)$  and  $(\Sigma_2; \eta_2)$  be two graded surfaces, each of genus  $g$  with  $b$  boundary components. There exists a symplectomorphism  $\varphi : \Sigma_1 \rightarrow \Sigma_2$  such that  $\varphi^*(\eta_2)$  is homotopic to  $\eta_1$  if and only if*

$$w_{\eta_1}(\partial_i \Sigma_1) = w_{\eta_2}(\partial_i \Sigma_2),$$

for each  $i \in \{1, \dots, b\}$ , and

- If  $g = 1$ , then  $\tilde{A}(\eta_1) = \tilde{A}(\eta_2)$ ;
- If  $g \geq 2$ , then  $\sigma(\eta_1) = \sigma(\eta_2)$  and, if the Arf invariant is defined, then  $\text{Arf}(\bar{q}_{\eta_1}) = \text{Arf}(\bar{q}_{\eta_2})$ .

### 4.3.2 Gluing cylinders

In this subsection, we describe a general construction of graded surfaces by gluing cylinders. This allows us to reduce the computation of topological invariants of these surfaces to the combinatorics of how they are glued. We then provide explicit descriptions of the Milnor fibres of invertible polynomials in two variables, as well as the corresponding computations of the topological invariants.

Let  $A(\ell, r; d)$  denote  $d$  disjoint cylinders placed in a column, each with  $r$  marked points (stops) on the right boundary component, and  $\ell$  marked points on the left. Considering each cylinder as a rectangle with top and bottom identified, for each  $k \in \{0, \dots, d-1\}$ , counting top-to-bottom in the column, we label the marked points on the right (resp. left) boundary component of the  $k^{\text{th}}$  cylinder as  $p_{rk}^+, \dots, p_{r(k+1)-1}^+$  (resp.  $p_{\ell k}^-, \dots, p_{\ell(k+1)-1}^-$ ). The reasoning for the labelling is that we would like to keep track of where the marked points are on each individual cylinder, as well as where each marked point is on the right (resp. left) side of the column of cylinders with respect to the total ordering  $p_0^+, \dots, p_{d_1 r_1 - 1}^+$  (resp.  $p_0^-, \dots, p_{d_1 \ell_1 - 1}^-$ ).

In this thesis, we will consider both circular and linear gluing. In the case of circular gluing, a surface is determined by a collection of cylinders,

$$A(\ell_1, r_1; d_1), A(\ell_2, r_2; d_2), \dots, A(\ell_n, r_n; d_n),$$

such that  $r_i d_i = \ell_{i+1} d_{i+1}$ , where  $i$  is counted mod  $n$ , and corresponding permutations  $\sigma_i \in \mathfrak{S}_{d_i r_i}$ . For each  $i \in \{1, \dots, n\}$  and  $j \in \{0, \dots, d_i r_i - 1\}$ , we glue a small segment of the boundary component  $p_j^+$  in  $A(\ell_i, r_i; d_i)$  to  $p_{\sigma_i(j)}^-$  in  $A(\ell_{i+1}, r_{i+1}; d_{i+1})$  (counting

$i \bmod n$ ) by attaching a strip. See Figure 4.1 for an example. The case of linear gluing is completely analogous, although we no longer count  $i$  modulo  $n$ , and so do not glue  $A(\ell_n, r_n; d_n)$  to  $A(\ell_1, r_1; d_1)$ . We no longer require  $r_n d_n = \ell_1 d_1$  in this case, and refer to the left boundary components of  $A(\ell_1, r_1; d_1)$  and the right boundary components of  $A(\ell_n, r_n; d_n)$  as the *distinguished boundary components*.

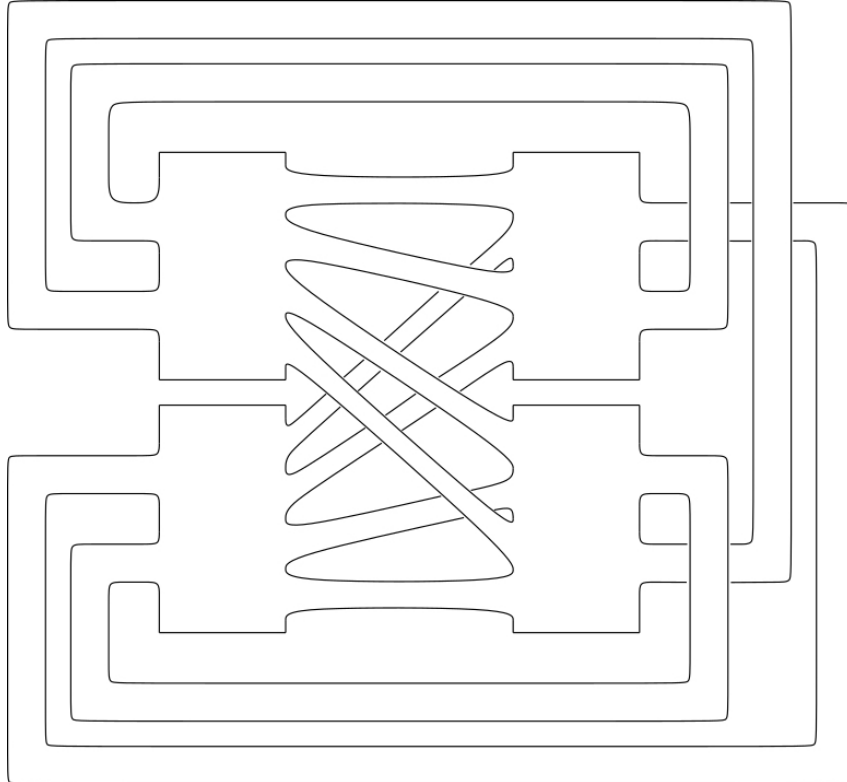

**Figure 4.1:** A genus 5 surface with 4 boundary components constructed by gluing  $A(2, 4; 2)$  to  $A(4, 2; 2)$  via the permutations  $\sigma_1 = \begin{pmatrix} 0 & 1 & 2 & 3 & 4 & 5 & 6 & 7 \\ 0 & 2 & 4 & 6 & 1 & 3 & 5 & 7 \end{pmatrix}$  and  $\sigma_2 = \begin{pmatrix} 0 & 1 & 2 & 3 \\ 2 & 0 & 3 & 1 \end{pmatrix}$ .

For each  $i \in \{1, \dots, n\}$ , the number of boundary components arising from gluing the  $i^{\text{th}}$  and  $(i+1)^{\text{st}}$  columns can be computed as follows. Consider the permutations

$$\tau_{r_i} = (0, r_i - 1, \dots, 1)(r_i, 2r_i - 1, \dots, r_i + 1) \dots \\ ((d_i - 1)r_i, d_i r_i - 1, \dots, (d_i - 1)r_i + 1)$$

and

$$\tau_{\ell_i} = (0, 1, \dots, \ell_{i+1} - 1) (\ell_{i+1}, \dots, 2\ell_{i+1} - 1) \dots ((d_{i+1} - 1)\ell_{i+1}, \dots, d_{i+1}\ell_{i+1} - 1).$$

The number of boundary components between the  $i^{\text{th}}$  and  $(i + 1)^{\text{st}}$  columns will then be given by the number of cycles in the decomposition of  $\sigma_i^{-1} \tau_{\ell_{i+1}} \sigma_i \tau_{\ell_i} \in \mathfrak{S}_{d_i r_i}$ . Note that if  $d_i = d_{i+1}$ , then we simply get the commutator.

To compute the homology groups of  $\Sigma$ , one can construct a ribbon graph

$$\Gamma(\ell_1, \dots, \ell_n; r_1, \dots, r_n; d_1, \dots, d_n; \sigma_1, \dots, \sigma_n) \subseteq \Sigma, \quad (4.48)$$

onto which the surface deformation retracts. To do this, let there be a topological disc  $\mathbb{D}^2$  for each of the cylinders. For each disc, attach a strip which has one end on the top, and the other end on the bottom. Then, attach a strip which connects two discs if there is a strip which connects the corresponding cylinders. These strips must be attached in such a way as to respect the cyclic ordering given by the gluing permutation. One can then deformation retract this onto a ribbon graph whose cyclic ordering at the nodes is induced from the ordering of the strips on each cylinder. If there is no ambiguity, we will refer to this graph as  $\Gamma(\Sigma)$ .

Since the embedding of  $\Gamma(\Sigma)$  into  $\Sigma$  induces an isomorphism on homology, the homology groups of  $\Sigma$  can be easily computed. Namely, since the graph is connected, we have  $H_0(\Sigma) = \mathbb{Z}$ . Since  $\chi(\Sigma) = V - E = \text{rk}H_0(\Sigma) - \text{rk}H_1(\Sigma)$ , which, in the case of circular gluing, yields  $\chi(\Sigma) = -\sum_{i=1}^n r_i d_i$ , we have  $H_1(\Sigma) = \mathbb{Z}^{(1-\chi)}$ . The case of linear gluing is analogous. A basis for the first homology of the graph is given by an integral cycle basis, and so the basis of the first homology for  $\Sigma$  is given by loops which retract onto these cycles.

Although there is no natural choice of grading on a surface glued in this way, in what follows we will only consider the case where the line field used to grade the



surface is horizontal on each cylinder and parallel to the boundary components on attaching strips.

### 4.3.2.1 Loop Polynomials

In the case of loop polynomials  $\check{\mathbf{w}} = \check{x}^p \check{y} + \check{y}^q \check{x}$ , we have that  $n = 3$  in the above construction, and we glue the cylinders

$$A(p-1, 1; q-1), A(q-1, p-1; 1), A(1, q-1; p-1),$$

where  $\sigma_1$  and  $\sigma_2$  are the identity elements in  $\mathfrak{S}_{q-1}$  and  $\mathfrak{S}_{p-1}$ , respectively, and  $\sigma_3 \in \mathfrak{S}_{(p-1)(q-1)}$  is given by

$$(q-1)k_3 + i \mapsto (p-1)((-i) \bmod q-1) + (p-2-k_3), \quad (4.49)$$

where in this case  $i \in \{0, \dots, q-2\}$  and  $k_3 \in \{0, \dots, p-2\}$ . Call the resulting surface  $\Sigma_{\text{loop}}(p, q)$ .

For the basis of homology, we begin by considering the compact curves in each cylinder,  $\gamma_i$ . Together with these curves, we construct the basis for the first homology of the surface as follows. On each of the cylinders in the left and right columns, we take the curves to be approximately horizontal. We must therefore only describe the behaviour of the curves in the middle cylinder. Consider the curve which goes from the  $((p-1)k_1 + j)^{\text{th}}$  position on the left hand boundary to the  $((q-1)k_3 + i)^{\text{th}}$  position on the right hand boundary. In accordance with the construction of Chapter 3.3, this curve must wind  $2\pi \left( \frac{k_3}{p-1} + \frac{-k_1 \bmod q-1}{q-1} \right)$  degrees in the cylinder. This winding goes in the downwards direction, since we are thinking of the argument of the  $\check{x}$  coordinate increasing in this direction. These curves form a basis of the first homology, since they retract onto a basis for the graph,  $\Gamma(\Sigma_{\text{loop}}(p, q))$ . The line field,  $\ell$ , used to grade the surface is approximately horizontal on each cylinder, and approximately parallel to the boundary on the connecting strips. By construction, we have  $\sigma(\ell) = 0$ . See Figure 4.2 for the case of  $\check{\mathbf{w}} = \check{x}^4 \check{y} + \check{x} \check{y}^3$ .

There is only one boundary component between the first and second columns,

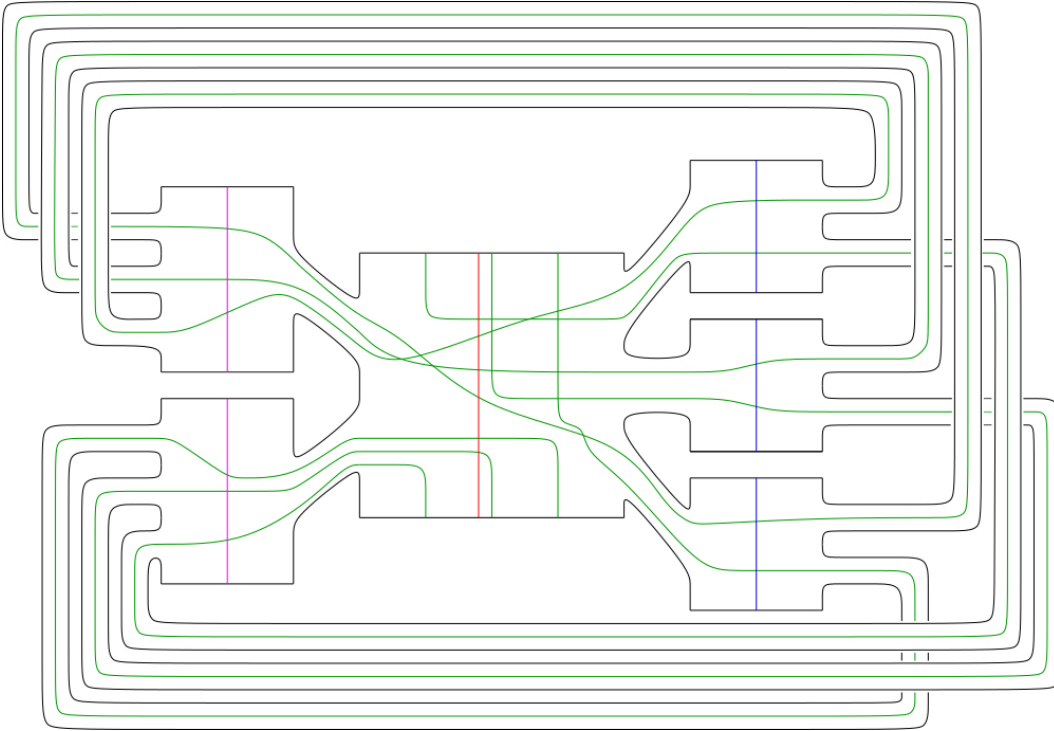

**Figure 4.2:** Milnor fibre for  $\check{w} = \check{x}^4 \check{y} + \check{x} \check{y}^3$ . Top and bottom of each cylinder are identified. Comparing with the basis of Lagrangians in Section 3.3, the red curve corresponds to  $V_{\check{x}\check{y}}$ , the purple ones to  ${}^i V_{\check{x}\check{w}}$ , the blue ones to  ${}^i V_{\check{y}\check{w}}$ , and the green ones to  ${}^i V_0$ .

as well as the second and third. With the line field  $\ell$  given above, these components have winding numbers  $-2(q-1)$  and  $-2(p-1)$ , respectively. To calculate the number of boundary components arising from gluing the third and first columns, note that in this case  $\tau_{r_3}$  can be written as

$$(q-1)k_3 + i \mapsto (q-1)k_3 + ((i-1) \bmod (q-1)), \quad (4.50)$$

and  $\tau_{\ell_1}$  can be written as

$$(p-1)k_1 + j \mapsto (p-1)k_1 + ((j+1) \bmod (p-1)). \quad (4.51)$$

With this description, one can see that  $\sigma_3^{-1} \tau_{\ell_1} \sigma_3 \tau_{r_3} \in \mathfrak{S}_{(p-1)(q-1)}$  is given by

$$(q-1)k_3 + i \mapsto (q-1)(k_3 - 1) \bmod p - 1 + ((i-1) \bmod q - 1). \quad (4.52)$$

As such, the length of a cycle is the least common multiple of  $(p-1)$  and  $(q-1)$ , which is  $\frac{(p-1)(q-1)}{\gcd(p-1, q-1)}$ . There are therefore  $\gcd(p-1, q-1)$  boundary components coming from gluing the third column to the first, each of winding number  $-2\frac{(p-1)(q-1)}{\gcd(p-1, q-1)}$ . We can then compute the genus from (4.42), which yields

$$-2(p-1) - 2(q-2) - 2(p-1)(q-1) = 2(2 - 2g_{\text{loop}} - \gcd(p-1, q-1) - 2),$$

and so the genus is

$$g_{\text{loop}} = \frac{1}{2}(pq - 1 - \gcd(p-1, q-1)),$$

which is in agreement with the calculation in Section 3.3.2.

By construction, the surface  $\Sigma_{\text{loop}}(p, q)$  is graded symplectomorphic to the Milnor fibre of the polynomial  $\check{\mathbf{w}} = \check{x}^p\check{y} + \check{x}\check{y}^q$ . To see this, consider the ribbon graph which corresponds to the orientable surface  $\check{V}$ . To construct this graph, first consider a disc  $\mathbb{D}^2$  for each of the neck regions of the construction of the Milnor fibre in Section 3.3.1. Then, attach a thin strip which connects two discs if there is at least one vanishing cycle which goes between them. The cyclic ordering of the strips at each disc is determined by the ordering of the vanishing cycles passing through a corresponding neck region. This graph can then be embedded into  $\check{V}$  in such a way that all intersections occur on the interior of the discs, and away from the discs, the vanishing cycles are on the interior of the attaching strips. One can deformation retract this onto a graph with the induced cyclic ordering at the vertices. Call this graph  $\Gamma(\check{V})$ , and observe that it is on-the-nose the same as  $\Gamma(\Sigma_{\text{loop}}(p, q))$ , and so the corresponding surfaces with boundary are symplectomorphic. See Figure 4.3 for an example of  $p = 4, q = 3$ .

To see that the two surfaces are graded symplectomorphic, consider the corresponding fat graphs in both cases. In this situation one can see that the description of the line field used to grade  $\Sigma_{\text{loop}}(p, q)$  agrees with the description of the line field used to grade  $\check{V}$ , as in Section 3.3.7, and this shows that the surfaces are graded

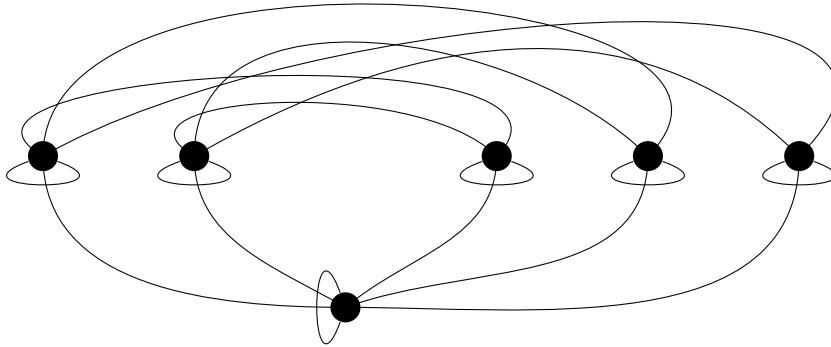

**Figure 4.3:** Ribbon graph for  $\Gamma(\check{V}) = \Gamma(\Sigma_{\text{loop}}(4, 3))$ , where the cyclic ordering of the half-edges at the nodes is in the anticlockwise direction.

symplectomorphic.

### 4.3.2.2 Chain polynomials

In the case of chain polynomials, we have  $\check{w} = \check{x}^p + \check{x}\check{y}^q$ , and we will show that the Milnor fibre can be constructed by gluing

$$A(p-1, 1; q-1), A(q-1, (p-1)(q-1); 1),$$

where  $\sigma_1$  is the identity element in  $\mathfrak{S}_{q-1}$ , and  $\sigma_2 \in \mathfrak{S}_{(p-1)(q-1)}$  is given by

$$i \mapsto (p-1)(-i \bmod q-1) + p-2 - \left\lfloor \frac{i}{q-1} \right\rfloor, \quad (4.53)$$

where in this case  $i \in \{0, \dots, (p-1)(q-1) - 1\}$ . Call the resulting surface  $\Sigma_{\text{chain}}(p, q)$ .

For the basis of homology, we begin by including the compact curves in each cylinder,  $\gamma_i$ . Together with these curves, we construct a basis for homology as follows. On the cylinders in the first column, we take the curves to be approximately horizontal. In the cylinder in the second column, the curve going from the  $((p-1)k_2 + j)^{\text{th}}$  position on the left hand side to the  $i^{\text{th}}$  position on the right hand

side winds  $2\pi\left(\frac{-k_1 \bmod p-1}{p-1} + \frac{i}{(p-1)(q-1)}\right)$  degrees, again in the downwards direction. This is in accordance with the description of the curves as in Section 3.5. Together, these curves form a basis for the first homology, since they retract onto a basis of the corresponding ribbon graph,  $\Gamma(\Sigma_{\text{chain}}(p, q))$ . As in the loop case, the line field,  $\ell$ , used to grade the surface is approximately horizontal on each cylinder, and approximately parallel to the boundary on the connecting strips. By construction, we have  $\sigma(\ell) = 0$ .

There is only one boundary component which arises from gluing the first and second columns, and the winding number around this boundary component is  $-2(q-1)$ . To compute the number of boundary components, and their winding numbers, arising from gluing the second column to the first, observe that in this case,  $\tau_{r_2}$  is just the permutation  $j \mapsto j-1$ , and  $\tau_{\ell_1}$  is of the same form as (4.51). The permutation  $\sigma_2^{-1}\tau_{\ell_1}\sigma_2\tau_{r_2} \in \mathfrak{S}_{(p-1)(q-1)}$  is given by

$$i \mapsto i - q. \quad (4.54)$$

Therefore the length of a cycle in the above permutation is  $\kappa = \frac{(p-1)(q-1)}{\gcd(p-1, q)}$ . From this, we see that there are  $\gcd(p-1, q)$  boundary components arising from this gluing, and each boundary component has winding number  $-2\frac{(p-1)(q-1)}{\gcd(p-1, q)}$ . Therefore there are  $1 + \gcd(p-1, q)$  boundary components in total, and we conclude from (4.42) that

$$g_{\text{chain}} = \frac{1}{2}(pq - p + 1 - \gcd(p-1, q)),$$

which is in agreement with the calculation in Section 3.5.2.

As in the loop case, we claim that the surface constructed above is graded symplectomorphic to  $\check{V}$ . To see this, we can construct a ribbon graph corresponding to  $\check{V}$  as in the case of loop polynomials. This graph also matches  $\Gamma(\Sigma_{\text{chain}}(p, q))$  on-the-nose, and this establishes that  $\Sigma_{\text{chain}}(p, q)$  and  $\check{V}$  are symplectomorphic. To

see that they are graded symplectomorphic, observe that in the corresponding fat graphs, the description of the line field above agrees with the description as in Section 3.5.3, and this shows that the surfaces are graded symplectomorphic.

### 4.3.2.3 Brieskorn–Pham polynomials

In the case of Brieskorn–Pham polynomials, we have  $\check{w} = \check{x}^p + \check{y}^q$ , where  $(p, q) \neq (2, 2)$ . Consider the surface obtained by gluing one cylinder to itself with the permutation  $\sigma \in \mathfrak{S}_{(p-1)(q-1)-1}$ , which is given by

$$i \mapsto -i(q-1), \tag{4.55}$$

where in this case  $i$  is a point on the right boundary, and is considered as an element of  $\{0, \dots, (p-1)(q-1)-2\}$ . Call this surface  $\Sigma_{BP}(p, q)$ .

For the basis of homology, we take a compact curve in the cylinder,  $\gamma_1$ , as well as one curve which is approximately parallel to the boundary along each of the connecting strips. On the interior of the cylinder, we have that the curve beginning in the  $j^{\text{th}}$  position on the left hand side and ending at the  $i^{\text{th}}$  position on the right hand side must wind  $2\pi \left( \frac{i+(-j) \bmod [(p-1)(q-1)-1]}{(p-1)(q-1)-1} \right)$  degrees in the downwards direction, in accordance with the description of the curves in Section 3.6.2. Together, these curves form a basis for the first homology of  $\Sigma_{BP}(p, q)$ , since they retract onto a basis of the corresponding ribbon graph,  $\Gamma(\Sigma_{BP}(p, q))$ . As in the previous two cases, the line field,  $\ell$ , used to grade the surface is approximately horizontal on the cylinder, and approximately parallel to the boundary on the connecting strips. Again, by construction, we have  $\sigma(\ell) = 0$ .

Let  $\tau$  be the permutation  $i \mapsto i-1$ , so the number of boundary components is given by the number of cycles in the decomposition  $[\sigma, \tau] \in \mathfrak{S}_{(p-1)(q-1)-1}$ . The commutator is given by

$$i \mapsto i-p,$$

and so the length of a cycle is given by  $\frac{(p-1)(q-1)-1}{\gcd(p,q)}$ . There are therefore  $\gcd(p,q)$  boundary components arising from this gluing, and each has winding number  $-2\frac{(p-1)(q-1)-1}{\gcd(p,q)}$ . Therefore, we have

$$g_{BP} = \frac{1}{2}((p-1)(q-1) + 1 - \gcd(p,q)),$$

in agreement with the genus calculated in Section 3.6.2.

As in the previous cases, we deduce that that  $\Sigma_{BP}(p,q)$  is graded symplectomorphic to the Milnor fibre.

### 4.3.3 Symplectic cohomology of the Milnor fibre

In this subsection, we utilise the explicit descriptions of the Milnor fibres of invertible polynomials given above to calculate the module structure of symplectic cohomology of these surfaces. By combining this with Theorem 4.3.4 below, we will be able to deduce the correct mirror curves in the proof of Theorem 4.1.1.

The symplectic cohomology of surfaces admits a particularly simple description – namely, for any Riemann surface,  $\Sigma_{g,b}$ , of genus  $g > 0$  with  $b > 0$  boundary components, we have

$$\mathrm{SH}^\bullet(\Sigma_{g,b}) \simeq \mathrm{H}^\bullet(\Sigma_{g,b}) \oplus \bigoplus_{i=1}^b \left( \bigoplus_{k \geq 1} \mathrm{H}^\bullet(S^1)[k \cdot w_\eta(\partial_i \Sigma_{g,b})] \right), \quad (4.56)$$

where  $w_\eta(\partial_i \Sigma_{g,b})$  is the winding number of the line field  $\eta$  about the boundary component  $\partial_i \Sigma_{g,b}$ . This was first described in the case of one puncture in [Sei08a, Example 3.3], and the generalisation to more than one puncture follows by the same argument. Note that the grading convention in [Sei08a] is shifted by one from ours.

In the case of loop polynomials,  $\check{\mathbf{w}} = \check{x}^p \check{y} + \check{y}^q \check{x}$ , we saw in Section 4.3.2.1 that the Milnor fibre is a  $2 + \gcd(p-1, q-1)$ -times punctured surface of genus  $g_{\text{loop}} = \frac{1}{2}(pq - 1 - \gcd(p-1, q-1))$ . Consider  $\Sigma_{g,b} = \check{V}$ , and let  $\ell$  be the line field

used to grade the surface as in Section 4.3.2.1. We then have by (4.56) and the analysis in Section 4.3.2.1, that

$$\begin{aligned} \mathrm{SH}^0(\check{V}) &\simeq \mathbb{C} \\ \mathrm{SH}^1(\check{V}) &\simeq \mathbb{C}^{\oplus pq} \\ \mathrm{SH}^{2n(p-1)}(\check{V}) &\simeq \mathrm{SH}^{2n(p-1)+1}(\check{V}) \simeq \mathbb{C} \text{ for } n \in \mathbb{Z}_{>0} \text{ such that } \frac{q-1}{\gcd(p-1, q-1)} \nmid n \\ \mathrm{SH}^{2n(q-1)}(\check{V}) &\simeq \mathrm{SH}^{2n(q-1)+1}(\check{V}) \simeq \mathbb{C} \text{ for } n \in \mathbb{Z}_{>0} \text{ such that } \frac{p-1}{\gcd(p-1, q-1)} \nmid n \\ \mathrm{SH}^{2n \frac{(p-1)(q-1)}{\gcd(p-1, q-1)}}(\check{V}) &\simeq \mathrm{SH}^{2n \frac{(p-1)(q-1)}{\gcd(p-1, q-1)} + 1}(\check{V}) \simeq \mathbb{C}^{\oplus (2 + \gcd(p-1, q-1))} \text{ for } n \in \mathbb{Z}_{>0}. \end{aligned}$$

In the case of chain polynomials,  $\check{w} = \check{x}^p + \check{y}^q$ , we have that the Milnor fibre is a  $(1 + \gcd(p-1, q))$ -times punctured surface of genus  $g_{\text{chain}} = \frac{1}{2}(pq - p + 1 - \gcd(p-1, q))$ . Let  $\ell$  be the line field used to grade the surface, as in Section 4.3.2.2. We then have by (4.56) and the analysis in Section 4.3.2.2 that

$$\begin{aligned} \mathrm{SH}^0(\check{V}) &\simeq \mathbb{C} \\ \mathrm{SH}^1(\check{V}) &\simeq \mathbb{C}^{\oplus pq - p + 1} \\ \mathrm{SH}^{2n(q-1)}(\check{V}) &\simeq \mathrm{SH}^{2n(q-1)+1}(\check{V}) \simeq \mathbb{C} \text{ for } n \in \mathbb{Z}_{>0} \text{ such that } \frac{p-1}{\gcd(p-1, q)} \nmid n \\ \mathrm{SH}^{2n \frac{(p-1)(q-1)}{\gcd(p-1, q)}}(\check{V}) &\simeq \mathrm{SH}^{2n \frac{(p-1)(q-1)}{\gcd(p-1, q)} + 1}(\check{V}) \simeq \mathbb{C}^{\oplus (1 + \gcd(p-1, q))} \text{ for } n \in \mathbb{Z}_{>0}. \end{aligned}$$

In the case of Brieskorn–Pham polynomials, we have that the Milnor fibre is a  $\gcd(p, q)$ -times punctured surface of genus  $g_{BP} = \frac{1}{2}((p-1)(q-1) + 1 - \gcd(p, q))$ . Let  $\ell$  be the line field used to grade the surface, as in Section 4.3.2.3. Then, by (4.56) and the analysis in Section 4.3.2.3, we have

$$\begin{aligned} \mathrm{SH}^0(\check{V}) &\simeq \mathbb{C} \\ \mathrm{SH}^1(\check{V}) &\simeq \mathbb{C}^{\oplus (p-1)(q-1)} \\ \mathrm{SH}^{2n \frac{(p-1)(q-1)-1}{\gcd(p, q)}}(\check{V}) &\simeq \mathrm{SH}^{2n \frac{(p-1)(q-1)-1}{\gcd(p, q)} + 1}(\check{V}) \simeq \mathbb{C}^{\oplus \gcd(p, q)} \text{ for } n \in \mathbb{Z}_{>0}. \end{aligned}$$

As previously mentioned, the comparison of the symplectic cohomology of the



Milnor fibre and the Hochschild cohomology of the Fukaya category of the Milnor fibre will be crucial in our mirror symmetry argument. To this end, we have the following theorem of Lekili and Ueda:

**Theorem 4.3.4** ([LU18, Corollary 6.6]). *Let  $\check{w}$  be the transpose of an invertible polynomial in two variables such that  $\check{d}_0 > 0$ . Then*

$$\mathrm{SH}^\bullet(\check{V}) \simeq \mathrm{HH}^\bullet(\mathcal{F}(\check{V})).$$

Note that assuming  $\check{d}_0 > 0$  is crucial, as can be seen if one considers  $\check{w} = \check{x}^2 + \check{y}^2$ .

#### 4.3.4 Graded symplectomorphisms between Milnor fibres

It is a natural question to ask which Milnor fibres are graded symplectomorphic, and in this subsection we utilise Lemma 4.3.3 to determine this. Since the genera, number of boundary components, and winding numbers around boundary components of the Milnor fibres were calculated above, it is easy to check when these match. This gives the potential graded symplectomorphisms, although one must also check that the corresponding Arf invariants agree whenever they are defined. We use the method described in Section 4.3.1 to compute the Arf invariant when necessary.

Observe that for each  $q \geq 2$  and  $n \geq 1$ , we have that  $\check{w}_{\mathrm{loop}} = \check{x}^{(q-1)n+1}\check{y} + \check{y}^q\check{x}$ , and  $\check{w}_{\mathrm{chain}} = \check{x}^{qn+1} + \check{y}^q\check{x}$  have the same genus, number of boundary components, and winding numbers along each boundary component. In the case of  $q$  odd, this is enough to give a graded symplectomorphism by Lemma 4.3.3, since  $\sigma = 0$  in both cases, and  $-2(q-1) \equiv 0 \pmod{4}$ . In the case where  $q$  and  $n$  are both even, we again have that the Milnor fibres are graded symplectomorphic. In the case where  $q$  is even and  $n$  is odd, it remains to check that the relevant Arf invariants agree.

For a graded symplectomorphism between the Milnor fibres of a chain and Brieskorn–Pham polynomial, we have that  $\check{w}'_{\mathrm{chain}} = \check{x}^p + \check{y}^{n(p-1)}\check{x}$  and  $\check{w}_{\mathrm{BP}} = \check{x}^p + \check{y}^{np}$  for each  $p \geq 2$  and  $n \geq 1$  or  $n \geq p = 2$  have the same genus, number of boundary components, and winding numbers along each boundary component. In the case

where  $n$  is even and  $p$  is odd, we have that  $-2(n(p-1)-1) \equiv 0 \pmod{4}$ , and so Lemma 4.3.3 gives us a graded symplectomorphism between the Milnor fibres. Similarly, for  $p=2$  and  $n$  odd, Lemma 4.3.3 yields a graded symplectomorphism between Milnor fibres. In all other cases, we must check the relevant Arf invariants.

The only possibility for a graded symplectomorphism between the Milnor fibres of a loop and Brieskorn–Pham polynomial is that both are symplectomorphic to a Milnor fibre of a chain polynomial. For such a graded symplectomorphism to exist, we require  $\check{w}_{\text{loop}} = \check{x}^q \check{y} + \check{y}^q \check{x}$ ,  $\check{w}_{\text{chain}} = \check{x}^{q+1} + \check{y}^q \check{x}$ , and  $\check{w}_{\text{BP}} = \check{x}^{q+1} + \check{y}^{q+1}$ . It should be noted that the potential graded symplectomorphisms discussed above are the only such possibilities.

#### 4.3.4.1 Graded symplectomorphisms between the Milnor fibres of loop and chain polynomials

In the case of loop polynomials of the form  $\check{w}_{\text{loop}} = \check{x}^{(q-1)n+1} \check{y} + \check{y}^q \check{x}$ , we have that there are  $q+1$  boundary components. Recall the basis of vanishing cycles for the first homology of the Milnor fibre given in Section 3.3. An elementary calculation shows that if we remove the Lagrangian  $V_{\check{x}\check{y}}^{\text{loop}}$ , as well as the Lagrangians  $\{V_{\check{x}\check{y}}^{\text{loop}}\}_{i \in \{0, \dots, q-2\}}$ , then the restriction of the intersection form is non-degenerate.

In the case of chain polynomials of the form  $\check{w}_{\text{chain}} = \check{x}^{qn+1} + \check{y}^q \check{x}$ , we consider the basis of Lagrangians for the first homology group of the Milnor fibre as given in Section 3.5. By removing the Lagrangian  $V_{\check{x}\check{y}}^{\text{chain}}$ , as well as the Lagrangians  $\{V_{\check{x}\check{y}}^{\text{chain}}\}_{i \in \{0, \dots, q-2\}}$ , the restriction of the intersection form to the remaining Lagrangians is non-degenerate.

Let  $U_n$  be the  $n \times n$  matrix given by  $(U_n)_{i,j} = \begin{cases} 1 & \text{if } i \geq j \\ 0 & \text{otherwise} \end{cases}$ . Then we

have that  $f_{\text{chain}} = U_{q-1} \otimes U_{qn} + (U_{q-1} \otimes U_{qn})^T$ . On the other hand,  $f_{\text{loop}}$  is the block

matrix given by

$$\begin{pmatrix} 2\mathrm{Id}_{n(q-1)} & \mathrm{Id}_{n(q-1)} & & \cdots & & \mathrm{Id}_{n(q-1)} \\ & \mathrm{Id}_{n(q-1)} & & & & \\ & \vdots & & & & \\ & & U_{q-1} \otimes U_{n(q-1)} + (U_{q-1} \otimes U_{n(q-1)})^T & & & \\ & & & & & \\ & & & & & \mathrm{Id}_{n(q-1)} \end{pmatrix}$$

In both cases, one can explicitly compute that the determinant is  $nq + 1$ , and so, in particular, we have  $\mathrm{Arf}(\bar{q}_{\mathrm{chain}}) = \mathrm{Arf}(\bar{q}_{\mathrm{loop}})$ . Therefore, by Lemma 4.3.3, the surfaces are graded symplectomorphic, and their respective Fukaya categories are quasi-equivalent.

#### 4.3.4.2 Graded symplectomorphisms between the Milnor fibres of chain and Brieskorn–Pham polynomials

In the case of chain polynomials of the form  $\check{w}'_{\mathrm{chain}} = \check{x}^p + \check{y}^{n(p-1)}\check{x}$ , and Brieskorn–Pham polynomials of the form  $\check{w}_{\mathrm{BP}} = \check{x}^p + \check{y}^{np}$ , we have that there are  $p$  boundary components. In the chain case, we remove  $V_{\check{x}\check{y}}^{\mathrm{chain}}$ , as well as the Lagrangians  $\{^i V_{\check{x}\check{y}}^{\mathrm{chain}}\}_{i \in \{0, \dots, p-3\}}$  from the collection of Lagrangians which form a basis of the first homology of the Milnor fibre, and the restriction of the intersection form to the remaining Lagrangians is non-degenerate. In the Brieskorn–Pham case, if we remove the Lagrangians  $\{^{l, np-2} V_0^{\mathrm{BP}}\}_{l \in \{0, \dots, p-2\}}$  from the collection of Lagrangians which form a basis of the first homology group of the Milnor fibre, as described in Section 3.6.2, then the restriction of the intersection form to the remaining Lagrangians is likewise non-degenerate.

In the case of chain polynomials, we have that  $f_{\mathrm{chain}'}$  is given by removing the

top and left  $p - 2$  rows and columns from

$$\begin{pmatrix} 2\text{Id}_{n(p-1)-1} & \text{Id}_{n(p-1)-1} & & \dots & & \text{Id}_{n(p-1)-1} \\ \text{Id}_{n(p-1)-1} & & & & & \\ \vdots & & & & & \\ \text{Id}_{n(p-1)-1} & & U_{p-1} \otimes U_{n(p-1)-1} + (U_{p-1} \otimes U_{n(p-1)-1})^T & & & \end{pmatrix}$$

In the case of Brieskorn–Pham polynomials, we have that  $f_{\text{BP}} = U_{p-1} \otimes U_{np-2} + (U_{p-1} \otimes U_{np-2})^T$ .

In both cases, we have that

$$\det f_{\text{chain}'} = \det f_{\text{BP}} = \begin{cases} p & \text{if } p \text{ is odd} \\ np - 1 & \text{if } p \text{ is even.} \end{cases}$$

We therefore have by Lemma 4.3.3 that the Milnor fibres are graded symplectomorphic.

## 4.4 Hochschild cohomology via matrix factorisations

In this section, we make the necessary Hochschild cohomology computations which will later enable us to deduce the existence of an affine scheme of finite type which represents the moduli functor of  $A_\infty$ -structures on the graded algebras we are interested in. Moreover, we will combine these computations with Theorem 4.3.4 to exclude candidate mirrors. This is the main computational component of the chapter, and we include the entire calculation for completeness, although a computation of  $\text{HH}^n(Z)$  for  $n \leq 2$  would have sufficed.

Suppose once more that we are in the setting of Section 4.2, and we have that  $w$  is an invertible polynomial in two variables such that  $d_0 > 0$ ,  $\Gamma$  is an admissible subgroup of  $\Gamma_w$ , and  $\mathbf{W}_u$  the quasi-homogenisation of a semi-universal unfolding corresponding to  $u \in U_+$ . Denote  $V = \{x, y, z\}$ ,  $S := \text{Sym } V = \mathbb{C}[x, y, z]$ , and so

$R_u = S/(\mathbf{W}_u)$ , and  $\mathbf{W}_u \in (S \otimes \chi)^\Gamma$  (recall  $\chi = \chi_{\mathbf{w}}|_\Gamma$ ). Equation (4.18), combined with the above observation, implies that

$$\mathrm{HH}^\bullet(Z_u) \simeq \mathrm{HH}^\bullet(\mathbb{A}^3, \Gamma, \mathbf{W}_u). \quad (4.57)$$

This vastly simplifies the calculation at hand, since a theorem of Ballard, Favero, and Katzarkov ([BFK11, Theorem 1.2]) reduces the computation of the Hochschild cohomology of the category of  $\Gamma$ -equivariant matrix factorisations of  $\mathbf{W}_u$  to studying the cohomology of certain Koszul complexes, which in nice cases reduces to studying the Jacobi algebra of  $\mathbf{W}_u$ . To this end, consider an element  $\gamma \in \ker \chi$ , and  $V_\gamma$  the subspace of  $V$  of  $\gamma$ -invariant elements. Let  $S_\gamma := \mathrm{Sym} V_\gamma$ , and  $N_\gamma$  the complement of  $V_\gamma$  in  $V$ , so that  $V \simeq V_\gamma \oplus N_\gamma$  as a  $\Gamma$ -module. Denote by  $\mathbf{W}_\gamma$  the restriction of  $\mathbf{W}_u$  to  $\mathrm{Spec} S_\gamma$ , and consider the Koszul complex

$$C^\bullet(d\mathbf{W}_\gamma) := \{\cdots \rightarrow \wedge^2 V_\gamma^\vee \otimes \chi^{\otimes(-2)} \otimes S_\gamma \rightarrow V_\gamma^\vee \otimes \chi^\vee \otimes S_\gamma \rightarrow S_\gamma\}, \quad (4.58)$$

where  $S_\gamma$  sits in cohomological degree 0, and the differential is the contraction with

$$d\mathbf{W}_\gamma \in (V_\gamma \otimes \chi \otimes S_\gamma)^\Gamma. \quad (4.59)$$

Denote by  $H^i(d\mathbf{W}_\gamma)$  the  $i^{\mathrm{th}}$  cohomology group of the Koszul complex. The zeroth cohomology of (4.58) is isomorphic to the Jacobi algebra of  $\mathbf{W}_\gamma$ , and if  $\mathbf{W}_\gamma$  has an isolated critical point at the origin, then  $C^\bullet(d\mathbf{W}_\gamma)$  is a resolution. Our main tool for computing Hochschild cohomology is the following theorem:

**Theorem 4.4.1** ([BFK11]). *Let  $\mathbf{w}$  be an invertible polynomial in two variables,  $\Gamma$  an admissible subgroup of  $\Gamma_{\mathbf{w}}$  which acts on  $\mathbb{A}^3 = \mathrm{Spec} S$ , and  $\mathbf{W}_u \in S$  be a non-zero element of degree  $\chi$ . Assume that the singular locus of the zero set  $Z_{(-\mathbf{w}_u) \boxplus \mathbf{W}_u}$  of the Thom–Sebastiani sum  $-\mathbf{W}_u \boxplus \mathbf{W}_u$  is contained in the product of the zero sets*

$Z_{\mathbf{w}_u} \times Z_{\mathbf{w}_u}$ . Then  $\mathrm{HH}^t(\mathbb{A}^3, \Gamma, \mathbf{W}_u)$  is isomorphic to

$$\left( \bigoplus_{\substack{\gamma \in \ker \chi, l \geq 0 \\ t - \dim N_\gamma = 2u}} \mathrm{H}^{-2l}(\mathrm{d}\mathbf{W}_\gamma) \otimes \chi^{\otimes(u+l)} \otimes \wedge^{\dim N_\gamma} N_\gamma^\vee \oplus \bigoplus_{\substack{\gamma \in \ker \chi, l \geq 0 \\ t - \dim N_\gamma = 2u+1}} \mathrm{H}^{-2l-1}(\mathrm{d}\mathbf{W}_\gamma) \otimes \chi^{\otimes(u+l+1)} \otimes \wedge^{\dim N_\gamma} N_\gamma^\vee \right)^\Gamma. \quad (4.60)$$

In the case where the  $\Gamma$ -action on  $V$  satisfies  $\dim(S \otimes \rho)^\Gamma < \infty$  for any  $\rho \in \hat{\Gamma}$ , one then has

$$\dim \mathrm{HH}^t(\mathbb{A}^3, \Gamma, \mathbf{W}) < \infty \quad (4.61)$$

for every  $t \in \mathbb{Z}$ . To see this, note that the complex  $C^\bullet(\mathrm{d}\mathbf{W}_\gamma)$  is always bounded, and the group  $\ker \chi$  is finite. Therefore, each direct summand of (4.60) is finite dimensional, and there are only finitely many  $u$  contributing to a fixed  $t$ .

Theorem 4.4.1 is a minor modification of [BFK11, Theorem 1.2], where the difference is in the convention for the Koszul complex. In our case, when there is an additional  $\mathbb{C}^*$ -action on  $V$ , then (4.60) is equivariant with respect to it. In particular, in the case of  $u = 0 \in U_+$ , we have that there is an additional  $\mathbb{C}^*$ -action on  $V$  given by  $t \cdot (x, y, z) = (x, y, tz)$ , and this induces an additional  $\mathbb{C}^*$ -action on  $\mathrm{HH}^\bullet(Z_0)$ . Denote by  $\mathrm{HH}^\bullet(Z_0)_{<0}$  the negative weight part of this action. We refer the reader to [BFK11] for a proof of Theorem 4.4.1.

**Definition 4.4.2.** We will say that the pair  $(\mathbf{w}, \Gamma)$  is *untwisted* if  $\mathrm{HH}^2(Z_0)_{<0}$  comes only from the summand  $(\mathrm{Jac}_{\mathbf{w}} \otimes \mathbb{C}[z] \otimes \chi)^\Gamma$  corresponding to  $u = 1$  and  $\gamma = 1 \in \ker \chi$  in (4.60).

It should be emphasised that being (un)twisted is a property of a pair  $(\mathbf{w}, \Gamma)$ , rather than its category of matrix factorisations. Indeed, we will see below that the polynomial  $\mathbf{w} = x^3y + y^2$  is twisted and  $\mathbf{w} = x^2y + y^2x$  is not, although by combining

Corollary 1 and the discussion above, we see that the Hochschild cohomology of their respective categories of matrix factorisations are isomorphic. A pair  $(\mathbf{w}, \Gamma)$  being untwisted ensures that all of the deformations corresponding to  $\mathrm{HH}^2(Z_0)_{<0}$  come from semi-universal unfoldings of the polynomial  $\mathbf{w}$ . This is a key step in the proof of [LU18, Theorem 1.6], a special case of which appears as Theorem 4.6.1. By an abuse of notation, we will refer to a polynomial  $\mathbf{w}$  as being (un)twisted to mean that the pair  $(\mathbf{w}, \Gamma_{\mathbf{w}})$  is (un)twisted.

#### 4.4.1 Loop polynomials

Consider  $\mathbf{W}_0 = x^p y + y^q x$  with the only restriction that  $p, q \geq 2$ . Without loss of generality, we can consider  $p \geq q$ . This has weights as in (4.19), where we again set  $d := \gcd(p-1, q-1)$ . As explained in Section 4.2, we extend the action of  $\Gamma_{\mathbf{w}} \simeq \mathbb{C}^* \times \mu_d$  to  $\mathbb{A}^3$  as in (4.14) so that we now have

$$\Gamma_{\mathbf{w}} = \{(t_0, t_1, t_2) \in (\mathbb{C}^*)^3 \mid t_1^p t_2 = t_2^q t_1 = t_0 t_1 t_2\}. \quad (4.62)$$

The group of characters is given by

$$\hat{\Gamma}_{\mathbf{w}} := \mathrm{Hom}(\Gamma_{\mathbf{w}}, \mathbb{C}^*) \simeq \mathbb{Z} \oplus \mathbb{Z}_d, \quad (4.63)$$

and we take  $m, n$  to be the same fixed solution to (4.22) as in Section 4.2.1. We write each character  $(t_0, t_1, t_2) \mapsto t_2^{mi - \frac{(q-1)j}{d}} t_1^{ni + \frac{(p-1)j}{d}}$ , where  $(i, j) \in \mathbb{Z} \oplus \mathbb{Z}_d$ , as  $\rho_{i,j}$ . One has that  $\mathrm{span}\{z^{\vee}\} \simeq \rho_{\frac{(p-1)(q-1)}{d}, 0}$ ,  $\mathrm{span}\{x^{\vee}\} \simeq \rho_{\frac{(q-1)}{d}, m}$ ,  $\mathrm{span}\{y^{\vee}\} \simeq \rho_{\frac{(p-1)}{d}, -n}$ ,  $\chi \simeq \rho_{\frac{pq-1}{d}, m-n}$ , and  $\ker \chi \simeq \mu_{pq-1}$ .

We have that  $\mathrm{Jac}_{\mathbf{w}}$  is given as in (4.20). Since we are in the situation of an affine cone over an isolated hypersurface singularity, [LU18, Section 3.1] shows that we must have  $l = 0$  in (4.60). Furthermore, there are no contributions when  $u < -1$ , and the only possible contribution for  $u = -1$  comes from when  $N_{\gamma} = \mathrm{span}\{x, y\}$ , or  $z \notin V_{\gamma}$ . When  $\gamma \in \ker \chi$  is the identity element, we have  $V_{\gamma} = V$ ,  $N_{\gamma} = 0$ , and

$\mathbf{W}_\gamma = \mathbf{w}$ . For every  $u \in \mathbb{Z}_{\geq 0}$ , the elements

$$\begin{aligned} x^i y^j z^k &\in \left( \mathbf{Jac}_{\mathbf{w}} \otimes \mathbb{C}[z] \otimes \mathcal{X}^{\otimes u} \right)^\Gamma, \\ z^\vee \otimes x^i y^j z^{k+1} &\in \left( z^\vee \otimes \mathbf{Jac}_{\mathbf{w}} \otimes \mathbb{C}[z] \otimes \mathcal{X}^{\otimes u} \right)^\Gamma, \end{aligned}$$

where  $i = u \bmod (p-1)$ ,  $j = u \bmod (q-1)$ , and  $k = u + \lfloor \frac{u}{q-1} \rfloor + \lfloor \frac{u}{p-1} \rfloor$ , contribute  $\mathbb{C}(k)$  to  $\mathrm{HH}^{2u}(Z_0)$  and  $\mathrm{HH}^{2u+1}(Z_0)$ , respectively. In addition, in the case where  $u \equiv 0 \bmod (p-1)$ , the elements

$$\begin{aligned} x^{p-1} y^j z^{k-1} &\in \left( \mathbf{Jac}_{\mathbf{w}} \otimes \mathbb{C}[z] \otimes \mathcal{X}^{\otimes u} \right)^\Gamma, \\ z^\vee \otimes x^{p-1} y^j z^k &\in \left( z^\vee \otimes \mathbf{Jac}_{\mathbf{w}} \otimes \mathbb{C}[z] \otimes \mathcal{X}^{\otimes u} \right)^\Gamma, \end{aligned}$$

where  $i, j$ , and  $k$  are as above, contribute  $\mathbb{C}(k-1)$  to  $\mathrm{HH}^{2u}(Z_0)$  and  $\mathrm{HH}^{2u+1}(Z_0)$ , respectively. In the case where  $u \equiv 0 \bmod (q-1)$ , we also have the elements

$$\begin{aligned} x^i y^{q-1} z^{k-1} &\in \left( \mathbf{Jac}_{\mathbf{w}} \otimes \mathbb{C}[z] \otimes \mathcal{X}^{\otimes u} \right)^\Gamma, \\ z^\vee \otimes x^i y^{q-1} z^k &\in \left( z^\vee \otimes \mathbf{Jac}_{\mathbf{w}} \otimes \mathbb{C}[z] \otimes \mathcal{X}^{\otimes u} \right)^\Gamma, \end{aligned}$$

where  $i, j$ , and  $k$  are again as above, contribute  $\mathbb{C}(k-1)$  to  $\mathrm{HH}^{2u}(Z_0)$  and  $\mathrm{HH}^{2u+1}(Z_0)$ , respectively. In the case when  $u \equiv 0 \bmod \frac{(p-1)(q-1)}{d}$ , we also have the elements

$$\begin{aligned} x^{p-1} y^{q-1} z^{k-2} &\in \left( \mathbf{Jac}_{\mathbf{w}} \otimes \mathbb{C}[z] \otimes \mathcal{X}^{\otimes u} \right)^\Gamma, \\ z^\vee \otimes x^{p-1} y^{q-1} z^{k-1} &\in \left( z^\vee \otimes \mathbf{Jac}_{\mathbf{w}} \otimes \mathbb{C}[z] \otimes \mathcal{X}^{\otimes u} \right)^\Gamma, \end{aligned}$$

where  $i, j$ , and  $k$  are again as above, and these contribute  $\mathbb{C}(k-2)$  to  $\mathrm{HH}^{2u}(Z_0)$  and  $\mathrm{HH}^{2u+1}(Z_0)$ , respectively.



When  $V_\gamma = 0$ ,  $N_\gamma = V$ ,  $W_\gamma = 0$ , we have the summand

$$(\mathcal{X}^\vee \otimes \wedge^3 N_\gamma^\vee)^\Gamma \simeq \mathbb{C} \cdot x^\vee \wedge y^\vee \wedge z^\vee$$

contributes  $\mathbb{C}(-1)$  to  $\mathrm{HH}^{2u+\dim N_\gamma}(Z_0) = \mathrm{HH}^1(Z_0)$ , and there are  $pq - d - 1$  such  $\gamma$ .

In the case when  $V_\gamma = \mathrm{span}\{z\}$ ,  $N_\gamma = \mathrm{span}\{x, y\}$ ,  $W_\gamma = 0$ , we that for each  $n \in \mathbb{Z}_{\geq 0}$ , the summands

$$\begin{aligned} \mathbb{C} \cdot z^{\frac{(n+1)(pq-1)}{d}-1} \otimes x^\vee \wedge y^\vee &\simeq \left( \mathrm{Jac}_{\mathbf{w}_\gamma} \otimes \mathcal{X}^{\otimes \frac{(n+1)(p-1)(q-1)}{d}-1} \otimes \wedge^2 N_\gamma^\vee \right)^\Gamma, \\ \mathbb{C} \cdot z^\vee \otimes z^{\frac{n(pq-1)}{d}} \otimes x^\vee \wedge y^\vee &\simeq \left( \mathrm{Jac}_{\mathbf{w}_\gamma} \otimes \mathcal{X}^{\otimes \frac{n(p-1)(q-1)}{d}-1} \otimes \wedge^2 N_\gamma^\vee \right)^\Gamma, \end{aligned}$$

contribute  $\mathbb{C}(\frac{(n+1)(pq-1)}{d} - 1)$  to  $\mathrm{HH}^{\frac{2(n+1)(p-1)(q-1)}{d}}(Z_0)$  and  $\mathbb{C}(\frac{n(pq-1)}{d} - 1)$  to  $\mathrm{HH}^{\frac{2n(p-1)(q-1)}{d}+1}(Z_0)$ . There are  $d - 1$  such contributions.

There are no elements which fix only  $x$  or  $y$  in the loop case. Putting this all together, we have that the Hochschild cohomology of  $Z_0$  satisfies

$$\mathrm{HH}^{s+t}(Z_0)_t \simeq \mathrm{HH}^{s+t+2\frac{(p-1)(q-1)}{d}}(Z_0)_{s-\frac{pq-1}{d}} \quad (4.64)$$

for  $s > 0$ , and that for  $0 \leq n \leq 2\frac{(p-1)(q-1)}{d} + 1$ ,  $\mathrm{HH}^n(Z_0)$  is given by

$$\mathrm{HH}^0(Z_0) \simeq \mathbb{C}(0),$$

$$\mathrm{HH}^1(Z_0) \simeq \mathbb{C}(0) \oplus \mathbb{C}(-1)^{\oplus pq}$$

$$\mathrm{HH}^{2u}(Z_0) \simeq \mathbb{C}(u + \lfloor \frac{u}{q-1} \rfloor + \lfloor \frac{u}{p-1} \rfloor) \quad \text{for } (p-1), (q-1) \nmid u$$

$$\mathrm{HH}^{2u+1}(Z_0) \simeq \mathrm{HH}^{2u}(Z_0) \quad \text{for } (p-1), (q-1) \nmid u$$

$$\begin{aligned} \mathrm{HH}^{2r(q-1)}(Z_0) &\simeq \mathbb{C}(r(q-1) + \lfloor \frac{r(q-1)}{p-1} \rfloor + r) \\ &\oplus \mathbb{C}(r(q-1) + \lfloor \frac{r(q-1)}{p-1} \rfloor + r - 1) \quad \text{for } 1 \leq r < \frac{p-1}{d} \end{aligned}$$

$$\mathrm{HH}^{2r(q-1)+1}(Z_0) \simeq \mathrm{HH}^{2r(q-1)}(Z_0) \quad \text{for } 1 \leq r < \frac{p-1}{d}$$

$$\begin{aligned} \mathrm{HH}^{2r(p-1)}(Z_0) &\simeq \mathbb{C}(r(p-1) + \lfloor \frac{r(p-1)}{q-1} \rfloor + r) \\ &\oplus \mathbb{C}(r(p-1) + \lfloor \frac{r(p-1)}{q-1} \rfloor + r - 1) \quad \text{for } 1 \leq r < \frac{q-1}{d} \end{aligned}$$

$$\mathrm{HH}^{2r(p-1)+1}(Z_0) \simeq \mathrm{HH}^{2r(p-1)}(Z_0)$$

$$\mathrm{HH}^{2\frac{(p-1)(q-1)}{d}}(Z_0) \simeq \mathbb{C}(\frac{pq-1}{d}) \oplus \mathbb{C}(\frac{pq-1}{d} - 1)^{\oplus 1+d} \oplus \mathbb{C}(\frac{pq-1}{d} - 2)$$

$$\mathrm{HH}^{2\frac{(p-1)(q-1)}{d}}(Z_0) \simeq \mathrm{HH}^{2\frac{(p-1)(q-1)}{d}+1}(Z_0).$$

Note that this is untwisted in every case.

#### 4.4.2 Chain Polynomials

Consider the case  $\mathbf{W}_0 = x^p y + y^q$ , where  $p, q \geq 2$ . This has weights as in (4.24), and we again take  $d := \gcd(p, q-1)$ . We have  $\Gamma_{\mathbf{w}} \simeq \mathbb{C}^* \times \mu_d$  as in (4.26), and extend the action to  $\mathbb{A}^3$  as in (4.14) so that we now have

$$\Gamma_{\mathbf{w}} = \{(t_0, t_1, t_2) \in (\mathbb{C}^*)^3 \mid t_1^p t_2 = t_2^q = t_0 t_1 t_2\}. \quad (4.65)$$

The group of characters is given by

$$\hat{\Gamma}_{\mathbf{w}} = \mathrm{Hom}(\Gamma_{\mathbf{w}}, \mathbb{C}^*) \simeq \mathbb{Z} \oplus \mathbb{Z}_d, \quad (4.66)$$

and we take  $m, n$  to be the same fixed solution to (4.27) as in Section 4.2.2. We write each character  $(t_0, t_1, t_2) \mapsto t_1^{ni + \frac{pj}{d}} t_2^{mi - \frac{(q-1)j}{d}}$  as  $\rho_{i,j}$ , where  $(i, j) \in \mathbb{Z} \oplus \mathbb{Z}_d$ . One then has  $\text{span}\{z^\vee\} \simeq \rho_{\frac{(p-1)(q-1)}{d}, 0}$ ,  $\text{span}\{x^\vee\} \simeq \rho_{\frac{q-1}{d}, m}$ ,  $\text{span}\{y^\vee\} \simeq \rho_{\frac{p}{d}, -n}$ ,  $\chi \simeq \rho_{\frac{pq}{d}, m-n}$ ,  $\ker \chi \simeq \mu_{pq}$ .

We have that  $\text{Jac}_{\mathbf{w}}$  is given as in (4.25). As in the loop case, we have  $l = 0$  and  $u \geq -1$  in (4.60), where  $u = -1$  only if  $N_\gamma = \text{span}\{x, y\}$ , or  $z \notin V_\gamma$ . In the case where  $\gamma \in \ker \chi$  is the identity, we have  $V_\gamma = V$ ,  $N_\gamma = 0$ , and  $\mathbf{W}_\gamma = \mathbf{w}$ . For each  $u \in \mathbb{Z}_{\geq 0}$ , we have that the elements

$$\begin{aligned} x^i y^j z^k &\in \left( \text{Jac}_{\mathbf{w}} \otimes \mathbb{C}[z] \otimes \chi^{\otimes u} \right)^\Gamma, \\ z^\vee \otimes x^i y^j z^{k+1} &\in \left( z^\vee \otimes \text{Jac}_{\mathbf{w}} \otimes \mathbb{C}[z] \otimes \chi^{\otimes u} \right)^\Gamma, \end{aligned}$$

where  $j = u \bmod (q-1)$ ,  $i = \frac{upq-jp}{q-1} \bmod (p-1)$ , and  $k = \frac{upq-i(q-1)-jp}{(p-1)(q-1)}$ , contribute  $\mathbb{C}(k)$  to  $\text{HH}^{2u}(Z_0)$  and  $\text{HH}^{2u+1}(Z_0)$ , respectively. In addition, when  $u \equiv 0 \bmod (q-1)$ , we have contributions from the elements

$$\begin{aligned} x^{i'} y^{q-1} z^{k'} &\in \left( \text{Jac}_{\mathbf{w}} \otimes \mathbb{C}[z] \otimes \chi^{\otimes u} \right)^\Gamma, \\ z^\vee \otimes x^{i'} y^{q-1} z^{k'+1} &\in \left( z^\vee \otimes \text{Jac}_{\mathbf{w}} \otimes \mathbb{C}[z] \otimes \chi^{\otimes u} \right)^\Gamma, \end{aligned}$$

where  $i' = \frac{upq-(q-1)p}{q-1} \bmod (p-1)$  and  $k' = \frac{upq-i'(q-1)-(q-1)p}{(p-1)(q-1)}$ , and these contribute  $\mathbb{C}(k')$  to  $\text{HH}^{2u}(Z_0)$  and  $\text{HH}^{2u+1}(Z_0)$ , respectively.

In the case where  $u \equiv 0 \bmod \frac{(p-1)(q-1)}{\gcd(p-1, q)}$ , we also have

$$\begin{aligned} x^{p-1} z^k &\in \left( \text{Jac}_{\mathbf{w}} \otimes \mathbb{C}[z] \otimes \chi^{\otimes u} \right)^\Gamma, \\ z^\vee \otimes x^{p-1} z^{k+1} &\in \left( z^\vee \otimes \text{Jac}_{\mathbf{w}} \otimes \mathbb{C}[z] \otimes \chi^{\otimes u} \right)^\Gamma, \end{aligned}$$

where  $k = \frac{upq}{(p-1)(q-1)} - 1$ . These contribute to  $\mathbb{C}(k)$  to  $\text{HH}^{2u}(Z_0)$  and  $\text{HH}^{2u+1}(Z_0)$ , respectively.

For the elements  $\gamma \in \ker \chi$  such that  $V_\gamma = 0$ ,  $N_\gamma = V$ , and  $\mathbf{W}_\gamma = 0$ , we have that the only contribution is from the summand

$$(\mathcal{X}^\vee \otimes \wedge^3 N_\gamma^\vee)^\Gamma \simeq \mathbb{C} \cdot x^\vee \wedge y^\vee \wedge z^\vee,$$

which contributes  $\mathbb{C}(-1)$  to  $\mathrm{HH}^{2u+\dim N_\gamma}(Z_0) = \mathrm{HH}^1(Z_0)$ , and there are  $pq - p - \mathrm{gcd}(p-1, q) + 1$  such  $\gamma$ .

In the case where  $V_\gamma = \mathrm{span}\{y\}$ , there cannot be a contribution. There are  $p-1$  such elements of  $\ker \chi$  which fix  $y$  and nothing else.

In the case where  $V_\gamma = \mathrm{span}\{z\}$ ,  $N_\gamma = \mathrm{span}\{x, y\}$ , we have for each  $n \in \mathbb{Z}_{\geq 0}$ , there are contributions from the summands

$$\begin{aligned} \mathbb{C} \cdot z^{\frac{(n+1)pq}{\mathrm{gcd}(p-1, q)} - 1} \otimes x^\vee \wedge y^\vee &\simeq \left( \mathrm{Jac} \mathbf{w}_\gamma \otimes \mathcal{X}^{\frac{(n+1)(p-1)(q-1)}{\mathrm{gcd}(p-1, q)} - 1} \otimes \wedge^2 N_\gamma^\vee \right)^\Gamma, \\ \mathbb{C} \cdot z^\vee \otimes z^{\frac{npq}{\mathrm{gcd}(p-1, q)}} \otimes x^\vee \wedge y^\vee &\simeq \left( z^\vee \otimes \mathrm{Jac} \mathbf{w}_\gamma \otimes \mathcal{X}^{\frac{n(p-1)(q-1)}{\mathrm{gcd}(p-1, q)} - 1} \otimes \wedge^2 N_\gamma^\vee \right)^\Gamma, \end{aligned}$$

and these contribute  $\mathbb{C}(\frac{(n+1)pq}{\mathrm{gcd}(p-1, q)} - 1)$  to  $\mathrm{HH}^{\frac{2(n+1)(p-1)(q-1)}{\mathrm{gcd}(p-1, q)}}(Z_0)$  and  $\mathbb{C}(\frac{npq}{\mathrm{gcd}(p-1, q)} - 1)$  to  $\mathrm{HH}^{2\frac{n(p-1)(q-1)}{\mathrm{gcd}(p-1, q)} + 1}(Z_0)$ . There are  $\mathrm{gcd}(p-1, q) - 1$  such terms. In total, we have that

$$\mathrm{HH}^{s+t}(Z_0)_t \simeq \mathrm{HH}^{s+t+2\frac{(p-1)(q-1)}{\mathrm{gcd}(p-1, q)}}(Z_0)_{t-\frac{pq}{\mathrm{gcd}(p-1, q)}} \quad (4.67)$$

for  $s > 0$ , and for  $0 \leq n \leq 2 \frac{(p-1)(q-1)}{\gcd(p-1,q)} + 1$ ,  $\mathrm{HH}^n(Z_0)$  is given by

$$\mathrm{HH}^0(Z_0) \simeq \mathbb{C}(0)$$

$$\mathrm{HH}^1(Z_0) \simeq \mathbb{C}(0) \oplus \mathbb{C}(-1)^{\oplus(p(q-1)+1)}$$

$$\mathrm{HH}^{2u}(Z_0) \simeq \mathbb{C}(\lfloor \frac{up}{p-1} \rfloor) \quad \text{for } (q-1) \nmid u$$

$$\mathrm{HH}^{2u+1}(Z_0) \simeq \mathrm{HH}^{2u}(Z_0) \quad \text{for } (q-1) \nmid u$$

$$\mathrm{HH}^{2r(q-1)}(Z_0) \simeq \mathbb{C}(\lfloor \frac{rp(q-1)}{p-1} \rfloor) \oplus \mathbb{C}(\lfloor \frac{p(rq-1)}{p-1} \rfloor) \quad \text{for } 1 \leq r < \frac{p-1}{\gcd(p-1,q)}$$

$$\mathrm{HH}^{2r(q-1)+1}(Z_0) \simeq \mathrm{HH}^{2r(q-1)}(Z_0) \quad \text{for } 1 \leq r < \frac{p-1}{\gcd(p-1,q)}$$

$$\begin{aligned} \mathrm{HH}^{2 \frac{(p-1)(q-1)}{\gcd(p-1,q)}}(Z_0) &\simeq \mathbb{C}(\frac{pq}{\gcd(p-1,q)}) \\ &\oplus \mathbb{C}(\frac{pq}{\gcd(p-1,q)} - 1)^{\oplus \gcd(p-1,q)} \oplus \mathbb{C}(\frac{pq}{\gcd(p-1,q)} - 2) \end{aligned}$$

$$\mathrm{HH}^{2 \frac{(p-1)(q-1)}{\gcd(p-1,q)} + 1}(Z_0) \simeq \mathrm{HH}^{2 \frac{(p-1)(q-1)}{\gcd(p-1,q)}}(Z_0).$$

This is twisted for the  $(p, q) = (3, 2)$ , but is otherwise untwisted.

### 4.4.3 Brieskorn–Pham Polynomials

Consider  $\mathbf{W}_0 = x^p + y^q$ , and without loss of generality, that  $p \geq q \geq 2$ . We are excluding the case of  $p = q = 2$ , since  $d_0 = 0$  in this case. This has weights as in (4.29), where we again set  $d := \gcd(p, q)$ . We have  $\Gamma_{\mathbf{w}} \simeq \mathbb{C}^* \times \mu_d$ , as in (4.31), and extend the action to  $\mathbb{A}^3$  as in (4.14), so that we now have

$$\Gamma_{\mathbf{w}} = \{(t_0, t_1, t_2) \in (\mathbb{C}^*)^3 \mid t_1^p = t_2^q = t_0 t_1 t_2\}. \quad (4.68)$$

The group of characters is given by

$$\hat{\Gamma}_{\mathbf{w}} := \mathrm{Hom}(\Gamma_{\mathbf{w}}, \mathbb{C}^*) \simeq \mathbb{Z} \oplus \mathbb{Z}_d, \quad (4.69)$$

and we again take  $m, n$  to be the same fixed solution to (4.32) as in Section 4.2.3. We write each character  $(t_0, t_1, t_2) \mapsto t_2^{mi - \frac{qj}{d}} t_1^{ni + \frac{pj}{d}}$ , where  $(i, j) \in \mathbb{Z} \oplus \mathbb{Z}_d$ , as  $\rho_{i,j}$ . One has that  $\mathrm{span}\{z^\vee\} \simeq \rho_{\frac{(p-1)(q-1)-1}{d}, d-m+n}$ ,  $\mathrm{span}\{x^\vee\} \simeq \rho_{q,m}$ ,  $\mathrm{span}\{y^\vee\} \simeq \rho_{d,-n}$ ,

$\chi \simeq \rho_{\frac{pq}{d},0}$ , and  $\ker \chi \simeq \mu_{\frac{pq}{d}} \times \mu_d$ .

We have that  $\text{Jac}_{\mathbf{w}}$  is given as in (4.30). As in the loop and chain cases, we have  $l = 0$  and  $u \geq -1$  in (4.60), where  $u = -1$  only if  $N_\gamma = \text{span}\{x, y\}$ , or  $z \notin V_\gamma$ . When  $\gamma \in \ker \chi$  is the identity, we have that for  $0 \leq u \leq \frac{(p-1)(q-1)-1}{d}$ , the elements

$$\begin{aligned} x^i y^j z^k &\in \left( \text{Jac}_{\mathbf{w}} \otimes \mathbb{C}[z] \otimes \chi^{\otimes u} \right)^\Gamma, \\ z^\vee \otimes x^i y^j z^{k+1} &\in \left( z^\vee \otimes \text{Jac}_{\mathbf{w}} \otimes \mathbb{C}[z] \otimes \chi^{\otimes u} \right)^\Gamma, \end{aligned}$$

where  $i, j, k$  are solutions to

$$\begin{aligned} i - k &= -mp \\ j - k &= -nq \\ k &= u + m + n \\ 0 &\leq i \leq p - 2 \\ 0 &\leq j \leq q - 2, \end{aligned} \tag{4.70}$$

contribute  $\mathbb{C}(k)$  to  $\text{HH}^{2u}(Z_0)$ , and  $\text{HH}^{2u+1}(Z_0)$ . In the case where  $u = \frac{(p-1)(q-1)-1}{d}$ , we have that there are precisely two solutions to (4.70), otherwise the solution is unique.

For the elements  $\gamma \in \ker \chi$  such that  $V_\gamma = 0$ ,  $N_\gamma = V$ , and  $\mathbf{W}_\gamma = 0$ , we have that the only contribution is from the summand

$$\left( \chi^\vee \otimes \wedge^3 N_\gamma^\vee \right)^\Gamma \simeq \mathbb{C} \cdot x^\vee \wedge y^\vee \wedge z^\vee,$$

and this contributes  $\mathbb{C}(-1)$  to  $\text{HH}^{2u+\dim N_\gamma}(Z_0) = \text{HH}^1(Z_0)$ . There are  $(p-1)(q-1) - \gcd(p, q) + 1$  such  $\gamma$ .

When  $V_\gamma = \text{span}\{x\}$  or  $V_\gamma = \text{span}\{y\}$ , there is no contribution. There are  $q-1$  and  $p-1$  such elements in  $\ker \chi$ , respectively.

When  $V_\gamma = \text{span}\{z\}$ ,  $N_\gamma = \text{span}\{x, y\}$ ,  $\mathbf{W}_\gamma = 0$  for  $n \geq 0$  we have that the summands

$$\begin{aligned} \mathbb{C} \cdot z^{\frac{(n+1)pq}{d}-1} \otimes x^\vee \wedge y^\vee &\simeq \left( \text{Jac}_{\mathbf{W}_\gamma} \otimes \chi^{\frac{(n+1)(p-1)(q-1)}{d}-1} \otimes \wedge^2 N_\gamma^\vee \right)^\Gamma, \\ \mathbb{C} \cdot z^\vee \otimes z^{\frac{npq}{d}} \otimes x^\vee \wedge y^\vee &\simeq \left( z^\vee \otimes \text{Jac}_{\mathbf{W}_\gamma} \otimes \chi^{\frac{n(p-1)(q-1)}{d}-1} \otimes \wedge^2 N_\gamma^\vee \right)^\Gamma, \end{aligned}$$

contribute  $\mathbb{C}(\frac{(n+1)pq}{d} - 1)$  and  $\mathbb{C}(\frac{npq}{d} - 1)$  to  $\text{HH}^{\frac{2(n+1)((p-1)(q-1)-1)}{d}}(Z_0)$  and  $\text{HH}^{\frac{2n((p-1)(q-1)-1)}{d}+1}(Z_0)$ , respectively. There are  $\text{gcd}(p, q) - 1$  such terms. Putting this all together, we get that

$$\text{HH}^{s+t}(Z_0)_t \simeq \text{HH}^{s+t+2\frac{(p-1)(q-1)-1}{d}}(Z_0)_{t-\frac{pq}{d}} \quad (4.71)$$

for  $s > 0$ , and that for  $0 \leq n \leq \frac{2(p-1)(q-1)-1}{d} + 1$ , we have that  $\text{HH}^n(Z_0)$  is given by

$$\begin{aligned} \text{HH}^0(Z_0) &\simeq \mathbb{C}(0) \\ \text{HH}^1(Z_0) &\simeq \mathbb{C}(0) \oplus \mathbb{C}(-1)^{\oplus(p-1)(q-1)} \\ \text{HH}^{2u}(Z_0) &\simeq \text{HH}^{2u+1}(Z_0) \simeq \mathbb{C}(k) \\ &\text{for } u < \frac{(p-1)(q-1)-1}{\text{gcd}(p, q)} \text{ and } k \text{ the unique solution to (4.70)} \\ \text{HH}^{2\frac{(p-1)(q-1)-1}{\text{gcd}(p, q)}}(Z_0) &\simeq \mathbb{C}\left(\frac{pq}{\text{gcd}(p, q)} - 2\right) \oplus \mathbb{C}\left(\frac{pq}{\text{gcd}(p, q)} - 1\right)^{\oplus \text{gcd}(p, q)-1} \\ &\quad \oplus \mathbb{C}\left(\frac{pq}{\text{gcd}(p, q)}\right) \\ \text{HH}^{2\frac{(p-1)(q-1)-1}{\text{gcd}(p, q)}}(Z_0) &\simeq \text{HH}^{2\frac{(p-1)(q-1)-1}{\text{gcd}(p, q)}+1}(Z_0). \end{aligned}$$

Note that this is twisted in the case  $p = q = 3$ , and  $p = 4, q = 2$ , but is otherwise untwisted.

#### 4.4.4 Unfoldings of invertible polynomials

Of course, Theorem 4.4.1 can also be used to compute the Hochschild cohomology of the category of matrix factorisations of an unfolded polynomial. For the polynomials where  $\dim U_+ > 1$ , we will need some of these calculations in order to be able to

isolate the correct mirror. Towards this end, we (partially) calculate  $\mathrm{HH}^2(Z_u)$  in the relevant cases.

**Lemma 4.4.3.** *Let  $\mathbf{w}$  an untwisted invertible polynomial in two variables such that  $\dim U_+ > 1$ . Then:*

- For  $\mathbf{w} = x^p y + y^2 x$  and  $p > 2$ , we have  $\mathrm{HH}^2(Z_u) = 0$  unless  $u_{1,0} = 0$ ,  $u_{1,1} \neq 0$  in (4.23).
- For  $\mathbf{w} = x^2 y + x y^2$ , we have  $\dim \mathrm{HH}^2(Z_u) < 3$  unless  $u_{1,1} \neq 0$  and  $u_{0,0} = u_{1,0} = u_{0,1} = 0$  in (4.23).
- For  $\mathbf{w} = x^p y + y^2$  and  $p > 3$ , we have  $\mathrm{HH}^2(Z_u) = 0$  unless  $u_{1,1} \neq 0$  and  $u_{2,0} = 0$  in (4.28)
- For  $\mathbf{w} = x^2 y + y^2$ , we have  $\dim \mathrm{HH}^2(Z_u) < 2$  unless  $u_{0,1} \neq 0$  and  $u_{0,0} = u_{1,0} = 0$  in (4.28).

*Proof.* In each of the cases we consider, the sequence  $(\partial_x \mathbf{W}_u, \partial_y \mathbf{W}_u)$  is a regular sequence in  $S$ . Therefore, the cohomology of the Koszul complex, (4.58), will be concentrated in degrees 0 and  $-1$ , and the only contributions to  $\mathrm{HH}^2(Z_u)$  can come from  $(\mathrm{Jac}_{\mathbf{W}_u} \otimes \chi)^\Gamma$  and  $(\mathrm{Jac}_{\mathbf{W}_u} \otimes x^\vee \wedge y^\vee)^\Gamma$ . Note that if the latter term contributes to  $\mathrm{HH}^2(Z_u)$ , then the polynomial is twisted, and we will not consider it.

The two loop polynomials we must consider are  $\mathbf{w} = x^p y + y^2 x$  for  $p > 2$  and  $\mathbf{w} = x^2 y + y^2 x$ . In the former case, the unfolding is given by  $\mathbf{W}_u = x^p y + y^2 x + u_{1,1} x y z + u_{1,0} x z^2$ . For a contribution to  $\mathrm{HH}^2(Z_u)$ , there must be an element of  $\mathrm{Jac}_{\mathbf{W}_u}$  which is proportional to  $\chi$ . Note that if  $u_{1,1} = 0$  then  $\dim(\mathrm{Jac}_{\mathbf{W}_u} \otimes \chi)^\Gamma = 0$ . On the other hand, we have that  $\dim(\mathrm{Jac}_{\mathbf{W}_u} \otimes \chi)^\Gamma = 0$  if  $u_{1,0} \neq 0$ . In the case  $\mathbf{w} = x^2 y + y^2 x$ , we have that  $\dim(\mathrm{Jac}_{\mathbf{W}_u} \otimes \chi)^\Gamma < 3$  unless  $u_{1,1} \neq 0$ , and the other coefficients are zero.

The only chain polynomials which need to be considered are  $\mathbf{w} = x^p y + y^2$  for  $p > 3$  and  $\mathbf{w} = x^2 y + y^2$ . In the former case, note that if  $u_{1,1} = 0$ , or  $u_{1,1}, u_{2,0} \neq 0$ ,



then  $\mathrm{HH}^2(Z_u) = 0$ . In the latter case, note that  $\dim \mathrm{HH}^2(Z_u) < 2$  unless  $u_{0,1} \neq 0$  and the other coefficients are zero.  $\square$

## 4.5 Generators and formality

In this section, we recall and implement the results of various authors to establish the required generation statements for the compact Fukaya category of the Milnor fibre, and also the category of perfect complexes on  $Z_u$  for any  $u \in U_+$ , as outlined in Section 4.1.1.

As in the previous sections, let  $\check{V}$  be the Milnor fibre of the transpose of an invertible polynomial in two variables such that  $d_0 > 0$ . Let  $\{S_i\}_{i=1}^{\check{\mu}}$  be a distinguished basis of vanishing cycles, and let  $\mathcal{S}$  be the full subcategory of  $D^\pi \mathcal{F}(\check{V})$  whose objects are  $\{S_i\}_{i=1}^{\check{\mu}}$ . As in Section 4.1.1, denote by  $\mathcal{A}$  the total  $A_\infty$ -endomorphism algebra  $\mathcal{S}$ ,

$$\mathcal{A} := \bigoplus_{i,j}^{\check{\mu}} \mathrm{hom}_{\mathcal{S}}(S_i, S_j). \quad (4.72)$$

Let  $T_L \in \mathrm{Symp}(\Sigma; \partial\Sigma)$  be the Dehn twist around a Lagrangian  $L$  in a surface with boundary  $(\Sigma; \partial\Sigma)$ , as in [Sei08b, Section 16c]. By [Sei00, Theorem 4.17, Comment 4.18(c)], we have that

$$(T_{S_1} \circ \cdots \circ T_{S_{\check{\mu}}})^{\check{h}} = [2\check{d}_0]. \quad (4.73)$$

Since  $\check{d}_0 > 0$ , the argument of [Sei03, Lemma 5.4] then shows that  $\mathcal{S}$  split-generates  $D^\pi \mathcal{F}(\check{V})$ , and so

$$D^\pi \mathcal{F}(\check{V}) \simeq \mathrm{perf} \mathcal{S}. \quad (4.74)$$

On the B–side, let  $\mathbf{w} : \mathbb{A}^2 \rightarrow \mathbb{A}$  be an invertible polynomial in two variables such that  $d_0 > 0$ . In each case, we aim to associate  $U_+$  to the moduli space of  $A_\infty$ -structures on a fixed quiver algebra. In order to do this, for each  $u \in U_+$  we must find generators  $\mathcal{S}_u$  of  $\mathrm{perf} Z_u$  such that

- (i) the isomorphism class of the cohomology level endomorphism algebra  $\text{End}^\bullet(\mathcal{S}_u)$  does not depend on  $u \in U_+$ , and
- (ii) the generator  $\mathcal{S}_0$  at  $0 \in U_+$  admits a  $\mathbb{C}^*$ -equivariant structure such that the cohomological grading on  $\text{End}^\bullet(\mathcal{S}_u)$  is proportional to the weight of the  $\mathbb{C}^*$ -action.

If we find generators which satisfy condition (i), then we can think of deformations of  $Z$  in terms of deformations of the  $A_\infty$ -structures on the cohomology level endomorphism algebra. Condition (ii) will be necessary to deduce that  $\text{end}^\bullet(\mathcal{S}_0)$  is formal.

Recall from Theorem 3.1.2 that  $\text{mf}(\mathbb{A}^2, \Gamma_{\mathbf{w}}, \mathbf{w})$  has a tilting object,  $\mathcal{E}$ , for any two variable invertible polynomial  $\mathbf{w}$ . For each  $u \in U_+$ , let  $\mathcal{S}_u$  be the image of  $\mathcal{E}$  under the pushforward functor

$$\text{mf}(\mathbb{A}^2, \Gamma_{\mathbf{w}}, \mathbf{w}) \rightarrow \text{mf}(\mathbb{A}^3, \Gamma_{\mathbf{w}}, \mathbf{W}_u) \simeq D^b \text{Coh}(Z_u).$$

It is then a consequence of [LU18, Theorem 4.1] that  $\mathcal{S}_u$  split-generates  $\text{perf} Z_u$ .

Let  $\mathcal{A}_u$  be the minimal model of the dg-endomorphism algebra of  $\mathcal{S}_u$ ,  $\text{end}^\bullet(\mathcal{S}_u)$ . As discussed in Section 4.4, one has a quasi-equivalence

$$D\text{QCoh}(Z_u) \simeq D(\mathcal{A}_u), \tag{4.75}$$

and therefore, by the Morita invariance of Hochschild cohomology, an isomorphism

$$\text{HH}^\bullet(Z_u) \simeq \text{HH}^\bullet(\mathcal{A}_u). \tag{4.76}$$

The cohomology algebra  $A_u := \text{H}^\bullet(\mathcal{A}_u)$  is independent of  $u$ , and by [Ued14, Theorem 1.1], is isomorphic as a vector space to (4.3). On both the A–, and B–sides, the algebra structure is given as in (4.4), since  $A^\rightarrow$  is the path algebra of a quiver with no cycles, and so  $\text{HH}^2(A^\rightarrow, (A^\rightarrow)^\vee[-1]) = (\text{HH}_1(A^\rightarrow))^\vee = 0$ .

By exploiting the additional  $\mathbb{C}^*$ -action, one can prove a general statement for the formality of  $\mathcal{A}_0$ . This is done by first showing that the cohomological grading on  $\text{End}^\bullet(\mathcal{S}_0)$  is proportional (equal in the case of curves) to the weight of the  $\mathbb{C}^*$ -action. This follows from the fact that the dualising sheaf of  $Z_0$  is trivial as an  $\mathcal{O}_{Z_0}$ -module, but has weight one with respect to the additional  $\mathbb{C}^*$ -action. Since  $\mathbb{C}^*$  is reductive, the chain homotopy to take  $\text{end}^\bullet(\mathcal{S}_0)$  to a minimal  $A_\infty$ -structure can be made  $\mathbb{C}^*$ -equivariant. Since  $\mu_d$  lowers the cohomological degree by 2, the only map which can be non-zero is  $\mu_2$ .

**Theorem 4.5.1** ([LU18, Theorem 4.2]).  *$\mathcal{A}_0$  is formal.*

In particular, this means that

$$\text{HH}^\bullet(Z_0) \simeq \text{HH}^\bullet(A), \quad (4.77)$$

and so the computations in Section 4.4 imply that the moduli space of  $A_\infty$ -structures on  $A$  is represented by an affine scheme of finite type. Furthermore, combining equation (4.77) with Theorem 4.3.4, and the calculations in Sections 4.3.3 and 4.4 gives us that the  $A_\infty$ -structure on  $\mathcal{A}$ , the  $A_\infty$ -endomorphism algebra of the generators of  $D^\pi \mathcal{F}(\check{V})$ , is *not* formal (since  $\text{SH}^\bullet(\check{V}) \neq \text{HH}^\bullet(Z_0)$ ).

## 4.6 Homological mirror symmetry for invertible curve singularities

In this section, we bring together the previous sections of the chapter to establish Theorem 4.1.1. As noted above, the computations of Section 4.4 together with (4.77) mean that the moduli space of  $A_\infty$ -structures on  $A$  is represented by an affine scheme of finite type,  $\mathcal{U}_\infty(A)$ , for any untwisted invertible polynomial  $\mathbf{w}$ . As explained in Section 4.1.1, we would like to identify  $\mathcal{U}_\infty(A)$  with the space  $U_+$  corresponding to  $\mathbf{w}$  by showing that the map (4.12) is an isomorphism. To this end, we utilise the following special case of [LU18, Theorem 1.6]:

**Theorem 4.6.1.** *Let  $\mathbf{w}$  be an untwisted invertible polynomial in two variables such that  $d_0 > 0$ , and  $\Gamma$  be an admissible subgroup of  $\Gamma_{\mathbf{w}}$ . Let  $A^{\rightarrow}$  be the endomorphism*

algebra of a tilting object in  $\text{mf}(\mathbb{A}^2, \Gamma, \mathbf{w})$ , and let  $A$  be the degree 1 trivial extension algebra of  $A^\rightarrow$ . Then there is a  $\mathbb{C}^*$ -equivariant isomorphism  $U_+ \xrightarrow{\sim} \mathcal{U}_\infty(A)$  which sends  $0 \in U_+$  to the formal  $A_\infty$ -structure on  $A$ .

This isomorphism descends to the quotient by the  $\mathbb{C}^*$ -action, and so we get an isomorphism  $(U_+ \setminus \{\mathbf{0}\})/\mathbb{C}^* \xrightarrow{\sim} \mathcal{M}_\infty(A)$ . It should be reiterated that the polynomial being untwisted is a crucial assumption, as can be seen by considering, for example,  $\mathbf{w} = x^3y + y^2$ . In this case, we have that  $\text{HH}^2(Z_0)_{<0} = \mathbb{C}(3) \oplus \mathbb{C}(2)^{\oplus 2} \oplus \mathbb{C}(1)$ , but  $U_+ = \mathbb{A}^3$ .

*Proof of Theorem 4.1.1.* In each case, we know that the  $A_\infty$ -structure on  $\mathcal{A}$  is not formal, and so is represented by a point in  $\mathcal{M}_\infty(A)$ . By Theorem 4.6.1, this, in turn, represents the  $A_\infty$ -structure corresponding to the dg-enhancement of the derived category of perfect sheaves on a semi-universal unfolding of  $\mathbf{w}$ . In the cases where  $\dim U_+ = 1$ , we have that  $\mathcal{M}_\infty(A)$  is a single point, and so the semi-universal unfolding (up to scaling) corresponding to this point must be the mirror. Note that in the cases  $\mathbf{w} = x^2y + y^q$  for  $q > 2$  and  $\mathbf{w} = x^p + y^2$  for  $p > 4$ , we have

$$\begin{aligned} \mathbb{C}[x, y, z]/(x^2y + y^q + yz^2) &\simeq \mathbb{C}[x, y, z]/(x^2y + y^q + xyz), \\ \mathbb{C}[x, y, z]/(x^p + y^2 + x^2z^2) &\simeq \mathbb{C}[x, y, z]/(x^p + y^2 + xzy) \end{aligned}$$

by completing the square.

In the case where  $\dim U_+ > 1$ , we must exclude the points in  $\mathcal{M}_\infty(A)$  other than the claimed mirror. In the case  $\mathbf{w} = x^p y + y^2$  for  $p > 3$ , we have by Lemma 4.4.3 that  $\dim \text{HH}^2(Z_u) = 0 < \dim \text{SH}^2(\check{V})$  unless  $u = (0, 1)$ . By Theorem 4.3.4, we must therefore have that the mirror is identified with  $Z_u$  for  $u = (0, 1) \in U_+$ . A similar argument in the cases  $\mathbf{w} = x^2y + y^2x$  and  $\mathbf{w} = x^p y + xy^2$  for  $p > 2$  leads to identifying the mirrors as  $Z_u$  for  $u = (0, 0, 0, 1)$  and  $u = (0, 1)$ , respectively.

In the case of  $x^2y + y^2$ , we have that if  $u \neq (0, 0, 1)$ , then  $\dim \text{HH}^2(Z_u) < 2 = \dim \text{SH}^2(\check{V})$  by Lemma 4.4.3, and so the mirror is identified with  $Z_u$  for  $u = (0, 0, 1)$ .

Again, by completing the square, we have

$$\mathbb{C}[x, y, z]/(x^2y + y^2 + yz^2) \simeq \mathbb{C}[x, y, z]/(x^2y + y^2 + xyz).$$

In the case of  $\mathbf{w} = x^3 + y^2$ , we follow the same argument as in [LP11b]. Namely, we have that if  $Z_u$  is an elliptic curve, then  $\mathrm{HH}^\bullet(Z_u)$  exists in only finitely many degrees by the Hochschild–Kostant–Rosenberg theorem. Since the symplectic cohomology of the Milnor fibre is non-trivial in arbitrarily large degree, by Theorem 4.3.4, we have that the mirror cannot be smooth. We therefore have that the mirror must be the nodal cubic  $\mathbf{W}_u = x^3 + y^2 + xz^4 + \frac{\sqrt[3]{2}z^6}{\sqrt{3}}$ , and we have

$$\mathbb{C}[x, y, z]/(\mathbf{W}_u) \simeq \mathbb{C}[x, y, z]/(x^3 + y^2 + xyz)$$

by a change of variables.

In the cases where the polynomial is twisted, the  $B$ -model does not have generic stabilisers. In the language of [LP17b], this forms a ring of orbifold curves, and homological mirror symmetry was established in this case in loc. cit.

The only invertible polynomial where  $d_0 \not\equiv 0$  is  $\mathbf{w} = x^2 + y^2$ , for which  $d_0 = 0$ . This, however, corresponds to the mirror symmetry statement for  $\mathbb{C}^*$ , which is already well established. Therefore, Theorem 4.1.1 is true in this case, too.

□



## Chapter 5

# Homological mirror symmetry for nodal stacky curves

### 5.1 Introduction

Whilst the topology of Riemann surfaces is very tractable and well-understood, the various flavours of Fukaya categories of such surfaces have rich and intricate structure. Correspondingly, homological mirror symmetry in this dimension has been an active and fruitful area of research in recent years. This has not only led to new instances of homological mirror symmetry, but also interesting links to the representation theory of finite dimensional algebras.

Let  $\Sigma$  be a surface with non-empty boundary and choose  $\Lambda$  a collection of points on its boundary, called stops. Then, there exists the derived *partially wrapped Fukaya category* introduced in Chapter 2, which we denote by  $D^\pi\mathcal{W}(\Sigma; \Lambda)$  ([Aur10], [Syl16]). In good circumstances, this gives a categorical resolution (smooth and proper) of the Fukaya category of  $\Sigma$ ,  $D^\pi\mathcal{F}(\Sigma)$ , and yields functors

$$D^\pi\mathcal{F}(\Sigma) \rightarrow D^\pi\mathcal{W}(\Sigma; \Lambda) \rightarrow D^\pi\mathcal{W}(\Sigma). \quad (5.1)$$

The last category in this sequence is the (fully) wrapped Fukaya category of the surface, and can be considered as the partially wrapped Fukaya category when  $\Lambda = \emptyset$ . The first functor above is full and faithful, and the second is given by localisation at

the collection of Lagrangians supported near the stops.

Of particular interest to us is the seminal work of Haiden, Kontsevich, and Katzarkov, [HKK14], who, amongst other things, give a combinatorial construction for the partially wrapped Fukaya category of a surface with a particular collection of stops. As part of the construction, the authors show that there exists a generating collection of Lagrangians of the partially wrapped Fukaya category whose endomorphism algebra is *formal* and *gentle*. This class of algebras has long been of interest to representation theorists ([AS87]), and this link with the symplectic geometry of surfaces provided a new tool in their study ([OPS18], [APS19]). Converse to the construction in [HKK14], it was shown in [LP20] how to construct a  $\mathbb{Z}$ -graded smooth surface with boundary, with a prescribed configuration of stops on this boundary, from a homologically smooth,  $\mathbb{Z}$ -graded gentle algebra.

On the algebro-geometric side of the correspondence, these algebras arose independently (and chronologically prior) in the work of Burban and Drozd, [BD09], who construct a categorical resolution of the derived category of perfect complexes on certain curves. This category is given as the derived category of coherent modules of a non-commutative sheaf of algebras, which they call the *Auslander sheaf*, and denote by  $\mathcal{A}_{\mathcal{C}}$ . Their main result is that this category has a tilting object whose endomorphism algebra is gentle. Moreover, there is a sequence of categories

$$\mathrm{perf}\mathcal{C} \rightarrow D^b(\mathcal{A}_{\mathcal{C}} - \mathrm{mod}) \rightarrow D^b\mathrm{Coh}(\mathcal{C}), \quad (5.2)$$

where the first functor is again full and faithful, and the second is given by localisation. It is still an open problem to find a B-side analogue to the work of [LP20]. Namely, to start with a given homologically smooth,  $\mathbb{Z}$ -graded gentle algebra and construct a B-model whose corresponding category has a tilting object whose endomorphism algebra is precisely the algebra we started with. The present work provides new examples of such geometric realisations of gentle algebras, although does not include any examples whose corresponding graded marked surface on the



A–side can have odd winding numbers. In particular, every line field considered in this chapter comes from the projectivisation of a vector field, and so must have even winding number (cf. Section 4.3.2). For example, the gentle algebra considered in [BD18, Example 7.4] cannot arise as the endomorphism algebra of a tilting object for a curve considered here.

The fact that gentle algebras arise as the endomorphism algebras of generating objects on the A– and B–sides of homological mirror symmetry was first utilised in [LP17b]. Here, the authors establish the conjecture in the case where  $\mathcal{C}$  is a ring or chain of projective lines with  $n$  irreducible components, but where the nodes, and endpoints in the chain case, are allowed to be orbifold points. The irreducible components of this curve are examples of weighted projective lines in the sense of [GL87], and are referred to as balloons in [LP17b]. The mirror surface is constructed by first considering the mirrors to the irreducible components, a cylinder with stops on its boundary, and then gluing these cylinders together in a way which is mirror to the stacky structure of the node where two irreducible components meet. The strategy of proof is to establish a derived equivalence between the categorical resolutions on the A– and B–sides by matching the corresponding gentle algebras. One can then establish HMS by matching localising subcategories under this equivalence, and then localising.

With the same notation as introduced in Chapter 1, we have the following theorem:

**Theorem 5.1.1.** *Let  $\mathcal{C}$  be a Deligne–Mumford stack such that:*

- *The coarse moduli space of  $\mathcal{C}$  is a ring or chain of  $n$   $\mathbb{P}^1$ ’s.*
- *Each irreducible component,  $\mathcal{C}_i$ , has underlying orbifold  $\mathbb{P}_{r_{i,-}, r_{i,+}}$  and generic stabiliser  $\mu_{d_i}$  such that  $r_{i,+}d_i = r_{i+1,-}d_{i+1}$  (we allow  $r_{1,-}$  and/ or  $r_{n,+} = 0$  in the case of a chain of curves).*
- *The node  $q_i := |\mathcal{C}_i| \cap |\mathcal{C}_{i+1}|$  has isotropy group  $H_i$  and is presented as the*

quotient of  $\text{Spec } \mathbb{C}[x, y]/(xy)$  by  $H_i$ , where the action is given by

$$h \cdot (x, y) = (\psi_{i,+}(h)x, \psi_{i+1,-}(h)y)$$

for some surjective  $\psi_{i,+} : H_i \rightarrow \mu_{r_{i,+}}$  and  $\psi_{i+1,-} : H_i \rightarrow \mu_{r_{i+1,-}}$ .

Then

$$D^b(\mathcal{A}_C - \text{mod}) \simeq D^b\mathcal{W}(\Sigma; \Lambda)$$

is a quasi-equivalence of  $\mathbb{Z}$ -graded pre-triangulated  $A_\infty$ -categories over  $\mathbb{C}$ , where  $\Sigma$  is a  $\mathbb{Z}$ -graded,  $b$ -punctured surface of genus  $g$  such that the genus, boundary components, and collection of stops are determined by the  $r_{i,\pm}$ ,  $d_i$ , and the local presentation of the nodes as the quotient by  $H_i$ .

Unlike in the orbifold case considered in [LP17b], there is no canonical identification of the isotropy groups at the nodes. Even if one fixes  $\psi_{i+1,-}$ , it is possible to change the identification of  $H_i$  by an automorphism which pushes down to the identity by  $\psi_{i+1,-}$ , and this is an equivalent presentation of the node. The source of this non-uniqueness is that the generic stabilisers of the irreducible components are, strictly speaking, *torsors* for  $\mu_{d_i}$ . The fact that there is no canonical identification of  $H_i$  can then be explained by the fact that there is no canonical identification of the generic stabiliser groups with  $\mu_{d_i}$ . In order to work concretely with groups, a key ingredient in our argument is to choose a *gerbe structure* on the irreducible components, which one can heuristically think of as a ‘principal  $B\mu_{d_i}$ -bundle’ over  $\mathbb{P}_{r_{i,-}, r_{i,+}}$ . This is extra structure which allows us to work concretely with groups, rather than torsors. We obtain the desired result by observing that the computations are independent of the choice of gerbe structures.

For us, choosing a gerbe structure will be necessary in order to make an identification  $\ker \psi_{i,+} \simeq \mu_{d_i}$  (resp.  $\ker \psi_{i+1,-} \simeq \mu_{d_{i+1}}$ ), yielding a short exact sequence of

groups

$$1 \rightarrow \mu_{d_i} \rightarrow H_i \xrightarrow{\psi_{i,+}} \mu_{r_{i,+}} \rightarrow 1,$$

and similarly for  $\psi_{i+1,-}$ . This short exact sequence will be of crucial importance; however, computations only depend on the *isomorphism class as a complex*, rather than the class as an extension. In particular, choosing different gerbe structures may yield non-equivalent Ext-classes, although they will always be isomorphic as complexes. The fact that the computations only depend on the isomorphism class of the complex will mean that our results are independent of the gerbe structure chosen.

Gerbes have a long history in algebraic geometry, and were originally introduced by Giraud in the study of non-abelian cohomology [Gir71]. Of particular interest to us is the *root stack* construction of Cadman and Abramovich, Graber, Vistoli ([Cad07], [AGV08]), as well as the toric Deligne–Mumford stack perspective provided in [BCS03] and [FMN10].

**Remark 5.1.2.** *Note that our presentation agrees with the orbifold case when each  $d_i = 1$  by observing that one can always arrange the action of  $H_i \simeq \mu_{r_i}$  to be such that  $\psi_{i+1,-} = id$ , and  $\psi_{i,+} : \mu_{r_i} \xrightarrow{\wedge^{\kappa_i}} \mu_{r_i}$  for some  $\kappa_i \in (\mathbb{Z}_{r_i})^\times$ .*

Following [LP17b], when referring to a specific configuration of points on the  $b$  boundary components of  $\Sigma$ , we will denote the partially wrapped Fukaya category by  $\mathcal{W}(\Sigma; m_1, m_2, \dots, m_b)$ , where  $m_i$  is the number of stops on the  $i^{\text{th}}$  boundary component. When there are  $d$  boundary components with  $m$  stops, we shall notate this as  $(m)^d$ .

As part of the equivalence of Theorem 5.1.1, the respective localising subcategories are identified with each other. Moreover, one can match the characterisation of the category of perfect complexes under the inclusion (5.2) with the characterisation of the Fukaya category under the inclusion (5.1). This yields:

**Theorem 5.1.3.** *Let  $\mathcal{C}$  and  $\Sigma$  be as in Theorem 5.1.1. Then*

$$\begin{aligned} \text{perf } \mathcal{C} &\simeq D^\pi \mathcal{F}(\Sigma) \\ D^b \text{Coh } \mathcal{C} &\simeq D^\pi \mathcal{W}(\Sigma), \end{aligned}$$

*are quasi-equivalences of  $\mathbb{Z}$ -graded pre-triangulated  $A_\infty$ -categories over  $\mathbb{C}$  in the case of a ring of curves. In the case of a chain of curves, there are quasi-equivalences of  $\mathbb{Z}$ -graded pre-triangulated  $A_\infty$ -categories over  $\mathbb{C}$*

$$\begin{aligned} \text{perf}_c \mathcal{C} &\simeq D^\pi \mathcal{F}(\Sigma; (r_{1,-})^{d_1}, (0)^{b-d_1-d_n}, (r_{n,+})^{d_n}) \\ D^b \text{Coh}(\mathcal{C}) &\simeq D^\pi \mathcal{W}(\Sigma; (r_{1,-})^{d_1}, (0)^{b-d_1-d_n}, (r_{n,+})^{d_n}), \end{aligned}$$

*where  $\text{perf}_c \mathcal{C}$  is the full subcategory of  $\text{perf } \mathcal{C}$  consisting of objects with proper support.*

It should be emphasised that the choice of grading on the surface in the above theorems is a crucial piece of data. Changing it would change the grading of the endomorphism algebra of the generating Lagrangians, and, in general, would not yield a derived equivalent algebra. Moreover, taking  $\text{perf}_c \mathcal{C}$ , as opposed to  $\text{perf } \mathcal{C}$ , in the case of a ring of curves is only necessary when  $r_{1,-}$  and/ or  $r_{n,+} = 0$ .

As already mentioned, the primary motivation for generalising the approach of [LP17b] to allow for the irreducible components to have non-trivial generic stabiliser comes from invertible polynomials in two variables. By applying Theorem 5.1.1 to the B–model of the invertible polynomials in Lekili–Ueda conjecture, and then showing that the resulting surface on the A–side is graded symplectomorphic to the quotient of the corresponding Milnor fibre, we prove:

**Theorem 5.1.4.** *Let  $\mathbf{w}$  be an invertible polynomial in two variables with admissible symmetry group  $\Gamma \subseteq \Gamma_{\mathbf{w}}$  and corresponding dual group  $\check{\Gamma}$ . Then, the action of  $\check{\Gamma}$  on*

$\check{V}$  is free, and there are quasi-equivalences

$$\begin{aligned} D^\pi \mathcal{F}(\check{V}/\check{\Gamma}) &\simeq \text{perf } Z_{\mathbf{w}, \Gamma} \\ D^\pi \mathcal{W}(\check{V}/\check{\Gamma}) &\simeq D^b \text{Coh}(Z_{\mathbf{w}, \Gamma}) \end{aligned}$$

of  $\mathbb{Z}$ -graded pre-triangulated  $A_\infty$ -categories over  $\mathbb{C}$ .

By combining the graded symplectomorphisms of Section 4.3.4 with Theorem 5.1.4, we deduce the following corollary:

**Corollary 5.1.5.** *For each  $n \geq 1$  and  $q \geq 2$ , let  $\mathbf{w}_{\text{loop}} = x^{n(q-1)+1}y + y^q x$  and  $\mathbf{w}_{\text{chain}} = x^{nq+1}y + y^q$ , each with the maximal symmetry group. We then have quasi-equivalences*

$$D^b \text{Coh}(Z_{\mathbf{w}_{\text{loop}}}) \simeq D^b \text{Coh}(Z_{\mathbf{w}_{\text{chain}}})$$

of  $\mathbb{Z}$ -graded pre-triangulated  $A_\infty$ -categories over  $\mathbb{C}$ .

Similarly, for each  $n \geq 1$  and  $p \geq 2$ , or  $n \geq p = 2$ , let  $\mathbf{w}'_{\text{chain}} = x^p y + y^{n(p-1)}$ ,  $\mathbf{w}_{\text{BP}} = x^p + y^{np}$ , each with the maximal symmetry group. We then have quasi-equivalences

$$D^b \text{Coh}(Z_{\mathbf{w}'_{\text{chain}}}) \simeq D^b \text{Coh}(Z_{\mathbf{w}_{\text{BP}}})$$

of  $\mathbb{Z}$ -graded pre-triangulated  $A_\infty$ -categories over  $\mathbb{C}$ .

It should be emphasised that the Milnor numbers of the polynomials in Corollary 5.1.5 will not in general agree, since part of the proof is to show that the Milnor numbers of the *transpose* polynomials agree. As already noted, this result was previously obtained by purely algebro-geometric methods in [FK19].

**Example 5.1.6.** *For example, consider the case of  $n = 1$  and  $q = 4$ . Then,  $\mathbf{w}_{\text{loop}} =$*

$x^4y + y^4x$  and  $\mathbf{w}_{\text{chain}} = x^5y + y^4$ . We have

$$\begin{aligned}\mu(\check{\mathbf{w}}_{\text{loop}}) &= 16 = \mu(\check{\mathbf{w}}_{\text{chain}}) \\ \chi(\check{V}_{\text{loop}}) &= 15 = \chi(\check{V}_{\text{chain}}) \\ g(\check{V}_{\text{loop}}) &= 6 = g(\check{V}_{\text{chain}}) \\ \text{Arf}(\bar{q}_{\text{loop}}) &= 1 = \text{Arf}(\bar{q}_{\text{chain}}).\end{aligned}$$

Therefore, the corresponding Milnor fibres are graded symplectomorphic by Lemma 4.3.3. Since graded symplectomorphisms induce quasi-equivalences on the corresponding derived (wrapped) Fukaya categories, we deduce by Theorem 5.1.4 that the B–models mirror to  $\check{V}_{\text{loop}}$  and  $\check{V}_{\text{chain}}$  are likewise derived equivalent.

### 5.1.1 Structure of the chapter

In Section 5.2, we recall the basic constructions of root stacks, both with and without section. In Section 5.3, we review the theory of Auslander orders over nodal (stacky) curves. In Section 5.4, we recall the construction of [HKK14] of the partially wrapped Fukaya category. Section 5.5 exposit the localisation argument on the A– and B–sides with the necessary alterations to our setting before proving Theorem 5.1.1. Section 5.6 characterises the category of perfect complexes on the B–side and the Fukaya category on the A–side before establishing Theorem 5.1.3. We provide applications in Section 5.7 and give first an example which does not arise as the Milnor fibre of an invertible polynomial before establishing Theorem 5.1.4.

## 5.2 Root stacks

In this section, we aim to give a brief and self-contained account of the constructions of stacks and gerbes as we will later need them. For a detailed account, we refer to the original sources of [Cad07], [AGV08], [FMN10], and [BCS03]. An excellent reference on the subject is [Ols16], and a very readable introduction to the theory of stacks is [Beh14]. The reader already proficient in the language of stacks, or willing to take these constructions as a black box, is invited to skip to Section 5.3.

The notion of a root stack was introduced independently in [Cad07] and [AGV08]. There are two related notions of a root stack – the first is a way to ‘insert stackiness’ along an effective Cartier divisor, and the second defines a gerbe structure, which ‘inserts stackiness’ everywhere, and also keeps track of the generic stabiliser.

Recall that the stack  $[\mathbb{A}^1/\mathbb{C}^*]$  is the classifying stack of line bundles with section – this can be seen by considering a morphism to this stack as a principal  $\mathbb{C}^*$ -bundle with a global section of the corresponding associated line bundle. To define the root stack of a line bundle with section, consider  $X$  a scheme,  $\mathcal{L}$  an invertible sheaf on  $X$ ,  $s \in \Gamma(X, \mathcal{L})$  a global section, and  $r > 0$  an integer. Moreover, let  $\theta_r : [\mathbb{A}^1/\mathbb{C}^*] \rightarrow [\mathbb{A}^1/\mathbb{C}^*]$  be the  $r^{\text{th}}$  power map on both  $\mathbb{A}^1$  and  $\mathbb{C}^*$ .

**Definition 5.2.1** ([Cad07, Definition 2.2.1], [AGV08, Appendix B.2]). *Define the stack  $X_{(\mathcal{L},s,r)}$  to be the fibre product*

$$\begin{array}{ccc} X_{(\mathcal{L},s,r)} & \xrightarrow{pr_2} & [\mathbb{A}^1/\mathbb{C}^*] \\ \downarrow pr_1 & & \downarrow \theta_r \\ X & \xrightarrow{(\mathcal{L},s)} & [\mathbb{A}^1/\mathbb{C}^*] \end{array}$$

This is a Deligne–Mumford stack ([Cad07, Theorem 2.3.3]), and is isomorphic to  $X$  away from the divisor  $s^{-1}(0)$ . By construction,  $X_{(\mathcal{L},s,r)}$  comes with a line bundle  $N$  and a section  $t \in \Gamma(X_{(\mathcal{L},s,r)}, N)$  such that  $\varphi : N^{\otimes r} \xrightarrow{\sim} \text{pr}_1^* \mathcal{L}$ , and  $\varphi(t^r) = \text{pr}_1^* s$ .

Concretely, we have that for  $X$  a scheme, an object of  $X_{(\mathcal{L},s,r)}$  over a scheme  $S$  consists of a quadruple

$$(f, N, t, \varphi),$$

where  $f : S \rightarrow X$  is a morphism,  $N$  is an invertible sheaf on  $S$ ,  $t \in \Gamma(S, N)$ , and  $\varphi : N^{\otimes r} \xrightarrow{\sim} f^* \mathcal{L}$  is an isomorphism such that  $\varphi(t^r) = f^* s$ . A morphism from  $(f_1, N_1, t_1, \varphi_1)$  over  $S_1$  to  $(f_2, N_2, t_2, \varphi_2)$  over  $S_2$  is a pair  $(h, \rho)$ , where  $h : S_1 \rightarrow S_2$  is

a morphism of schemes such that  $f_2 \circ f = f_1$ , and  $\rho : N_1 \xrightarrow{\sim} h^*N_2$  is an isomorphism such that

$$\begin{array}{ccc} N_1^{\otimes r} & \xrightarrow{\rho^r} & h^*N_2^{\otimes r} \\ \downarrow \varphi_1 & & \downarrow h^*\varphi_2 \\ f_1^*L & \xrightarrow{\sim} & h^*f_2^*L \end{array}$$

commutes, and the bottom isomorphism is canonical. The construction can be generalised to when  $X$  is a Deligne–Mumford stack.

For an effective Cartier divisor, we will also use the notation  $X_{(D,r)}$  to mean  $X_{(\mathcal{O}_X(D), 1_{D,r})}$ , where  $1_D$  is the tautological section vanishing along  $D$ . One can iterate this root construction, and for  $\mathbb{D} = (D_1, \dots, D_n)$  and  $\vec{r} = (r_1, \dots, r_n)$ , we define  $X_{\mathbb{D}, \vec{r}}$  to be the root stack defined by iteratively applying the above construction. This is equivalent to the fibre product

$$\begin{array}{ccc} X_{\mathbb{D}, \vec{r}} & \longrightarrow & [\mathbb{A}^n / (\mathbb{C}^*)^n] \\ \downarrow & & \downarrow \theta_{\vec{r}} \\ X & \longrightarrow & [\mathbb{A}^n / (\mathbb{C}^*)^n], \end{array}$$

where  $\theta_{\vec{r}} = \theta_{r_1} \times \theta_{r_2} \times \dots \times \theta_{r_n}$ , and  $X \rightarrow [\mathbb{A}^n / (\mathbb{C}^*)^n]$  is given by the product of  $(\mathcal{O}_X(D_i), 1_{D_i})_{i=1}^n$ .

An important example for us will be the following:

**Example 5.2.2** ([Cad07, Lemma 2.3.1]). *For  $X = \mathbb{A}^1$ , and  $D = [0]$ , there is an equivalence  $X_{(D,r)} \simeq [\mathbb{A}^1 / \mu_r]$ , where  $\mu_r$  acts via its natural character.*

In fact, Example 5.2.2 can be generalised ([Cad07, Example 2.4.1], cf. [Ols16, Theorem 10.3.10]) to any  $X = \text{Spec}A$  and  $\mathcal{L} = \mathcal{O}_X$ , with  $s \in \Gamma(X, \mathcal{O}_X)$  such that  $D = s^{-1}(0)$ , yielding

$$X_{(D,r)} \simeq [(\text{Spec}A[x]/(x^r - s)) / \mu_r],$$

where  $\mu_r$  acts on  $b$  by  $t \cdot x = t^{-1}x$ , and  $t \cdot a = ta$ . In general, any root stack can be



covered by such affine root stacks. For further exposition on root stacks of line bundles with section we refer to the original references [AGV08], [Cad07], as well as [Ols16, Section 10.3].

The second flavour of root stack defines a gerbe over the original scheme (or stack), and we refer to [Ols16, Chapter 12] for a definition and further discussion about generalities of gerbes. As already mentioned, one can think of a gerbe as a ‘ $BG$ -bundle’ over  $X$  for some group  $G$ , meaning that not only does the isotropy group of each point contain a copy of  $G$ , but the identification of this copy of  $G$  in the automorphism group of each point is a crucial part of the definition. In particular, an equivalence of gerbes is an equivalence of categories which is compatible with these identifications. Note that this means that two gerbes can be equivalent as stacks, but inequivalent as gerbes, in analogy with how two principal  $G$ -bundles can have diffeomorphic total spaces, but are not isomorphic  $G$ -bundles. As a simple example, there are three principal  $\mu_3$ -bundles over  $S^1$ , but two of them have total space  $S^1$ . More non-trivially, principal  $S^3$  bundles over  $S^4$  are classified by  $\mathbb{Z} \oplus \mathbb{Z}$ , and [CE03] establishes an explicit diffeomorphism between the total spaces of the bundles classified by  $(1, 1)$  and  $(2, 0)$ . In what follows, we will restrict ourselves to the case at hand and only consider trivially banded gerbes, which are classified by  $H^2(X, G)$ .

**Example 5.2.3.** *If one considers the topological setting, then a good example to have in mind is given by the observation that any principal  $S^1$ -bundle is in fact a  $\mathbb{Z}$ -gerbe, since  $B\mathbb{Z} \simeq K(\mathbb{Z}, 1) \simeq S^1$ . From this, we recover the usual classification of principal  $S^1$ -bundles as the cohomology class in  $H^2(X)$  corresponding to the Euler class.*

To define a root stack of a line bundle (without section), consider  $\mathcal{L} \in \text{Pic } X$ . Recall that such a line bundle is equivalent to a map  $X \xrightarrow{\mathcal{L}} BC^*$ , and let  $BC^* \xrightarrow{\wedge^d} BC^*$  be the  $d^{\text{th}}$  power map. Then, we have:

**Definition 5.2.4** ([Cad07, Definition 2.2.6], [AGV08, Appendix B.1]). *The stack*

$X_{(\mathcal{L},d)}$  is defined to be the fibre product

$$\begin{array}{ccc} X_{(\mathcal{L},d)} & \xrightarrow{pr_2} & B\mathbb{C}^* \\ \downarrow pr_1 & & \downarrow \wedge^d \\ X & \xrightarrow{\mathcal{L}} & B\mathbb{C}^* \end{array}$$

The stack  $X_{(\mathcal{L},d)}$  is a  $\mu_d$ -gerbe over  $X$ , and, by construction, there is a line bundle  $\mathcal{N} \in \text{Pic}X_{(\mathcal{L},d)}$  such that

$$\mathcal{N}^{\otimes d} \simeq \text{pr}_1^* \mathcal{L}.$$

Of course, there is also a corresponding iterated statement (see, for example [FMN10, Proposition 6.9]), although we will not make use of it. We will mainly use the notation  $X_{(\mathcal{L},d)} = \sqrt[d]{\mathcal{L}/X}$ .

Perhaps a more geometric way to think of a root stack of a line bundle is given in [AGV08, Appendix B.1]. Let  $\mathcal{L}$  be a line bundle on a scheme  $X$ , and  $\mathcal{L}^*$  be the total space minus the zero section (i.e. the principal  $\mathbb{C}^*$ -bundle associated to  $\mathcal{L}$ ). Then,

$$\sqrt[d]{\mathcal{L}/X} = [\mathcal{L}^*/\mathbb{C}^*],$$

where  $\mathbb{C}^*$  acts fibrewise with weight  $d$ . In particular, the usual description of the weighted projective stack  $\mathbb{P}(d,d)$  is recovered as  $\sqrt[d]{\mathcal{O}(-1)/\mathbb{P}^1}$ , since  $\mathcal{O}(-1)^* = \mathbb{A}^2 \setminus ((0,0))$ .

**Remark 5.2.5.** *It should be noted that  $X_{(\mathcal{L},d)}$  and  $X_{(\mathcal{L},0,d)}$  are not equivalent. Indeed, as is demonstrated in [Cad07, Example 2.4.3], the latter category is an infinitesimal thickening of the former.*

The Kummer sequence

$$1 \rightarrow \mu_d \xrightarrow{l} \mathbb{G}_m \xrightarrow{\wedge^d} \mathbb{G}_m \rightarrow 1 \tag{5.3}$$

induces a long exact sequence on cohomology

$$\cdots \rightarrow H^1(X, \mathbb{G}_m) \xrightarrow{\partial} H^2(X, \mu_d) \xrightarrow{l_*} H^2(X, \mathbb{G}_m) \rightarrow \cdots \quad (5.4)$$

For a root stack  $\sqrt[d]{\mathcal{L}/X}$ , the corresponding class in  $H^2(X, \mu_d)$  is the image of  $\mathcal{L} \in H^1(X, \mathbb{G}_m) \simeq \text{Pic } X$  under the connecting homomorphism. Conversely, a  $\mu_d$ -gerbe is called *essentially trivial* if its corresponding class in  $H^2(X, \mu_d)$  is in the image of the connecting homomorphism. In particular, in the case where  $H^2(X, \mathbb{G}_m) = 0$ , we make the identification

$$H^2(X, \mu_d) \simeq \text{Pic } X / d \text{Pic } X,$$

and so the cohomology class classifying the  $d^{\text{th}}$  root of  $\mathcal{L}$  is given by the quotient of its corresponding class in the Picard group, namely its first Chern class. Moreover, in this case [FMN10, Lemma 6.5] identifies  $H^2(X, \mu_d) \simeq \text{Ext}_{\mathbb{Z}}^1(\mathbb{Z}_d, \text{Pic } X)$ , where a class  $[\mathcal{L}] \in \text{Pic } X / d \text{Pic } X$  corresponds to the short exact sequence

$$0 \rightarrow \text{Pic } X \rightarrow \text{Pic } X \times_{\text{Pic } X / d \text{Pic } X} \mathbb{Z}_d \rightarrow \mathbb{Z}_d \rightarrow 0, \quad (5.5)$$

where the map  $\text{Pic } X \rightarrow \text{Pic } X / d \text{Pic } X$  is the projection, the map  $\mathbb{Z}_d \rightarrow \text{Pic } X / d \text{Pic } X$  is given by  $1 \mapsto [\mathcal{L}]$ , and the first morphism of the extension is  $\mathcal{L} \rightarrow (\mathcal{L}^{\otimes d}, 0)$ .

For each  $\mu_d$ -gerbe  $\mathcal{X}$ , there is an *underlying orbifold*. This is the stack which results from the stackification of the prestack whose objects are the same as the original stack, but whose isotropy groups are quotiented by  $\mu_d$ . This process is known as *rigidification*, although we refer to Appendix C of [AGV08] for the precise details. It suffices for us to observe that, in the case where the gerbe is the stack of roots of a line bundle on a scheme or orbifold, the map  $\text{pr}_1 : \sqrt[d]{\mathcal{L}/X} \rightarrow X$  is the rigidification map. In particular, for  $\mathcal{X} = \sqrt[d]{\mathcal{L}/X}$  and  $D$  a Cartier divisor on  $X$ , by  $\mathcal{O}_{\mathcal{X}}(D)$  we mean  $\text{pr}_1^* \mathcal{O}_X(D)$ .

**Example 5.2.6.** *The most basic example of a gerbe is given by considering  $B\mu_d$  to*

be a  $\mu_d$ -gerbe over a point.

**Example 5.2.7.** Consider an orbifold  $X$  and the trivial action of  $\mu_d$  on  $X$ . Then the resulting quotient stack is given by  $X \times B\mu_d$ , and corresponds to the stack of  $d^{\text{th}}$  roots of  $\mathcal{O}_X$ , or indeed any line bundle on  $X$  whose  $d^{\text{th}}$  root exists in  $\text{Pic} X$ .

**Example 5.2.8.** Consider the compactified moduli space of elliptic curves  $\overline{\mathcal{M}}_{1,1} \simeq \mathbb{P}(4,6)$ . This is a  $\mathbb{Z}_2$ -gerbe over  $\mathbb{P}(2,3)$ , where the  $\mathbb{Z}_2$ -torsor corresponds to the symmetry present in any lattice defining an elliptic curve. It can be constructed as the stack of square roots of any line bundle  $\mathcal{L} \in \text{Pic} \mathbb{P}(2,3) \simeq \mathbb{Z}$  such that  $[\mathcal{L}] \in \text{Pic} \mathbb{P}(2,3)/2\text{Pic} \mathbb{P}(2,3) \simeq \mathbb{Z}_2$  is non-trivial. In this case,  $\mathbb{P}(2,3)$  is the rigidification of the moduli space of elliptic curves.

**Example 5.2.9.** Consider the short exact sequence

$$1 \rightarrow K \rightarrow H \rightarrow G \rightarrow 1,$$

where  $K$ ,  $H$ , and  $G$  are all finite abelian groups. Then  $BH \rightarrow BG$  is a  $K$ -gerbe, so is classified by  $H^2(BG, K) \simeq H^2(G, K)$ , which recovers the usual classification of short exact sequences in terms of group cohomology.

**Remark 5.2.10.** Note that above, and in what follows, we are implicitly taking  $K$  to have the structure of a trivial  $G$ -module since we are only considering the case of trivially banded gerbes. Furthermore, we will only consider the cases where  $G$  and  $K$  are cyclic groups, and so we have  $H^2(G, K) \simeq \text{Ext}_{\mathbb{Z}}^1(G, K)$  by the universal coefficient theorem.

**Example 5.2.11.** In general, if  $\mathcal{Y}$  is a  $K$ -gerbe over  $\mathcal{X}$ , and  $x \in |\mathcal{X}|$  has isotropy group  $G_x$ ,  $x \in |\mathcal{Y}|$  has isotropy group  $H_x$ , then there is a short exact sequence

$$1 \rightarrow K \rightarrow H_x \rightarrow G_x \rightarrow 1.$$

We will exclusively deal with root stacks, both with and without section, over  $\mathbb{P}^1$ . To this end, consider  $D_1 = [0] = q_-$ ,  $D_2 = [\infty] = q_+$ , and  $\vec{r} = (a, b)$ . Then we

define

$$\mathbb{P}_{a,b} := \mathbb{P}_{\mathbb{D}, \vec{r}}^1$$

to be the weighted projective line with a stacky point of order  $a$  at  $q_-$  and of order  $b$  at  $q_+$ . Unless  $\gcd(a,b) = 1$ , this is not a weighted projective space; however, if this is the case then we have

$$\mathbb{P}_{a,b} \simeq \mathbb{P}(a,b) := [\mathbb{A}^2 \setminus ((0,0)) / \mathbb{C}^*],$$

where  $\mathbb{C}^*$  acts on  $\mathbb{A}^2 \setminus ((0,0))$  with weights  $a$  and  $b$ . In general, the space  $\mathbb{P}_{a,b}$  can be realised as the quotient of  $\mathbb{A}^2 \setminus ((0,0))$  by  $\mathbb{C}^* \times \mu_{\gcd(a,b)}$  ([FMN10, Example 7.31]). Note that  $H^2(\mathbb{P}_{a,b}, \mathbb{G}_m) = 0$ , and so all gerbes whose underlying orbifold is  $\mathbb{P}_{a,b}$  are essentially trivial.

Given a  $\mu_d$ -gerbe over  $\mathbb{P}_{a,b}$ ,  $\mathcal{C}$ , the structure of the gerbe at the points  $q_{\pm}$  will be of central importance to us. Observe that there is a natural (surjective) map

$$H^2(\mathbb{P}_{a,b}, \mu_d) \rightarrow H^2([\mathbb{A}^1 / \mu_a], \mu_d) \oplus H^2([\mathbb{A}^1 / \mu_b], \mu_d) \quad (5.6)$$

which comes from the Mayer–Vietoris sequence, and this determines the Ext-class at  $q_{\pm}$  which locally describes the gerbe. Explicitly, let  $\mathcal{U}_- = [\mathbb{A}^1 / \mu_a]$ , suppose that  $\mathcal{C} = \sqrt[d]{\mathcal{L} / \mathbb{P}_{a,b}}$ , and that  $\mathcal{L}|_{\mathcal{U}_-} \simeq \mathcal{O}_{\mathcal{U}_-}(nq_-)$  has class  $\beta \in \text{Pic} \mathcal{U}_- \simeq \mathbb{Z}_a$ . Observe that  $H^2([\mathbb{A}^1 / \mu_a], \mu_d) \simeq \mathbb{Z}_{\gcd(a,d)}$ , and that the reduction  $\beta \bmod d$  yields an element  $[\beta] \in \mathbb{Z}_{\gcd(a,d)}$  determining a short exact sequence

$$1 \rightarrow \mu_d \rightarrow H_- \rightarrow \mu_a \rightarrow 1, \quad (5.7)$$

classifying the gerbe on the patch  $\mathcal{U}_-$ , and corresponding to the  $d^{\text{th}}$  root of  $\mathcal{O}_{\mathcal{U}_-}(nq_-)$ . By construction, there exists a (not unique!) character  $\chi_{d_-}$  of  $H_-$  such that  $H_-$  acts via  $d\chi_{d_-}$  on the fibre of  $\text{pr}_1^* \mathcal{O}_{\mathcal{U}_-}(nq)$  at the origin, and which pulls back via the inclusion of  $\mu_d$  to  $H_-$  to a unit in  $\mathbb{Z}_d$ . Therefore, as  $\mathcal{N}|_{\mathcal{U}_-}$  we take the equivariant

sheaf on  $\mathbb{A}^1$  where  $H_-$  acts via  $\chi_{d_-}$  on the fibre at the origin. By construction, for any  $\chi \in \widehat{H}_-$ , there is a unique  $k \in \{0, \dots, d-1\}$  and  $j \in \{m, \dots, m+a-1\}$  such that  $H_-$  acts on the fibre of the sheaf

$$\mathrm{pr}_1^* \mathcal{O}_{\mathcal{U}_-}(jq) \otimes \mathcal{N}^{\otimes k} \tag{5.8}$$

at the origin with character  $\chi$ . The local description of the gerbe on the patch  $\mathcal{U}_+ = [\mathbb{A}^1/\mu_b]$  is analogous, giving the local description of the gerbe on the two patches of  $\mathbb{P}_{a,b}$ . Conversely, the description of a gerbe on  $\mathbb{P}_{a,b}$  is given by the local description on  $\mathcal{U}_\pm$ , together with the information of how the two local descriptions get identified on the overlapping  $\mathbb{C}^* = \mathcal{U}_+ \cap \mathcal{U}_-$ .

There is a strong link between the derived categories of root stacks and the representation theory of finite dimensional algebras. If one takes  $a = b = 1$ , then this relationship is classical, and is Beilinson’s result ([Beĩ78]) that

$$D^b(\mathbb{P}^1) \simeq D^b(\Lambda^{\mathrm{op}} - \mathrm{mod}),$$

where  $\Lambda$  is the path algebra of the Kronecker quiver. This was generalised in [GL87] to the situation  $\mathbb{P}_{\mathbb{D}, \vec{r}}^1$ , where  $\mathbb{D}$  is a finite collection of disjoint points with multiplicity one, and  $\vec{r}$  is a tuple of positive integers. In particular, for  $\mathbb{D} = (q_-, q_+)$  and  $\vec{r} = (a, b)$  as above, it was shown that

$$D^b(\mathbb{P}_{a,b}) \simeq D^b(\Lambda_{a,b}^{\mathrm{op}} - \mathrm{mod}),$$

where  $\Lambda_{a,b}$  is the path algebra of the quiver

$$\begin{array}{ccccccccccc} \mathcal{O}(-aq_-) & \xrightarrow{x} & \mathcal{O}(-(a-1)q_-) & \xrightarrow{x} & \dots & \xrightarrow{x} & \mathcal{O}(-q_-) & \xrightarrow{x} & \mathcal{O} & & \\ \parallel & & & & & & & & & & \parallel \\ \mathcal{O}(-bq_+) & \xrightarrow{y} & \mathcal{O}(-(b-1)q_+) & \xrightarrow{y} & \dots & \xrightarrow{y} & \mathcal{O}(-q_+) & \xrightarrow{y} & \mathcal{O} & & \end{array} \tag{5.9}$$

As for sheaves on the gerbes constructed as the root stacks over orbifold curves,

consider  $\mathcal{C} = \sqrt[d]{\mathcal{L}/\mathbb{P}_{a,b}}$  for some  $\mathcal{L} \in \text{Pic } \mathbb{P}_{a,b}$ . There are natural full and faithful functors

$$\begin{aligned} \Phi_i : \text{Coh } \mathbb{P}_{a,b}^1 &\rightarrow \text{Coh } \mathcal{C} \\ \mathcal{F} &\mapsto \text{pr}_1^* \mathcal{F} \otimes \mathcal{N}^{\otimes i}, \end{aligned}$$

where  $\text{pr}_1 : \mathcal{C} \rightarrow \mathbb{P}_{a,b}$  is again the rigidification map. Taking the direct sum yields a special case of [IU15, Theorem 1.5], giving an equivalence

$$\text{Coh } \mathcal{C} \simeq (\text{Coh } \mathbb{P}_{a,b})^{\oplus d}. \tag{5.10}$$

Note that is not just semi-orthogonal, but also orthogonal, and that the equivalence is at the level of abelian categories. Therefore, the derived category of coherent sheaves on a gerbe over  $\mathbb{P}_{a,b}$  only depends on the generic stabiliser group and the underlying orbifold.

It is essentially because of (5.10) that our results are independent of the precise choice of gerbe structure on irreducible components. To elaborate, consider  $\mathcal{C}$  to be a chain of curves with two irreducible components which has isotropy group  $H$  at their intersection; the general proceeds inductively. One can construct  $\mathcal{C}$  as the pushout

$$\begin{array}{ccc} & \mathcal{C}_1 & \\ & \uparrow & \\ \mathcal{C}_2 & \xleftarrow{\varphi} & BH, \end{array} \tag{5.11}$$

where  $\varphi : BH \rightarrow \mathcal{C}_2$  is the composition of the autoequivalence of  $BH$  induced from the action of  $H$  on the node, followed by its inclusion into  $\mathcal{C}_2$ . Since the abelian (and hence derived) categories of  $\mathcal{C}_1$  and  $\mathcal{C}_2$  are independent of gerbe structures by (5.10), the only information required to understand the category of coherent sheaves of  $\mathcal{C}$  is the autoequivalence of  $BH$ , and this is independent of the gerbe structure chosen, as well as the characters  $\chi_{d_{1,+}}$  and  $\chi_{d_{2,-}}$ .

### 5.2.1 Root stacks and stacky fans

The theory of toric Deligne–Mumford stacks was initiated in [BCS03], and the relationship with gerbes and root stacks was explored in [FMN10]. For a more in-depth account, we refer to these original sources.

Analogously to a toric variety, which contains an open, dense, torus,  $T$ , a toric Deligne–Mumford stack is defined to be a smooth, separated Deligne–Mumford stack with an open immersion of a Deligne–Mumford torus,  $T \times BG$  for  $G$  a finite abelian group, such that the action of  $T \times BG$  on itself extends to the whole stack ([FMN10, Section 3]). In the case of invertible polynomials, we work with root stacks over  $\mathbb{P}^1$  on the B–side, although these curves are naturally presented as a hypersurface in a quotient stack. Therefore, in order to be able to apply our theory, we must demonstrate an equivalence between the irreducible components of the curves arising in invertible polynomials, and root stacks over  $\mathbb{P}^1$ . To this end, recall that the data of a stacky fan is given by a triple  $\Sigma = (\Sigma, N, \beta)$ , where:

- $N$  is a finitely generated abelian group (not necessarily torsion-free),
- $\Sigma$  is a fan in  $N_{\mathbb{Q}} = N \otimes_{\mathbb{Z}} \mathbb{Q}$  with  $n$  rays such that the rays span  $N_{\mathbb{Q}}$ , and
- $\beta : \mathbb{Z}^n \rightarrow N$  is a morphism of groups such that the image of the  $i^{\text{th}}$  basis vector of  $\mathbb{Z}^n$  in  $N_{\mathbb{Q}}$  is on the  $i^{\text{th}}$  ray.

For simplicity, we will always assume that  $\Sigma$  is complete. From this data, one can construct a toric DM stack in analogy with the Cox construction for toric varieties ([Cox95]) as follows. Let  $d$  be the rank of  $N$ , and choose a projective resolution

$$0 \rightarrow \mathbb{Z}^{\ell} \xrightarrow{Q} \mathbb{Z}^{d+\ell} \rightarrow N \rightarrow 0.$$

Then, choose a map  $B : \mathbb{Z}^n \rightarrow \mathbb{Z}^{d+\ell}$  which lifts  $\beta$ . The cone of  $\beta$ , considered as a morphism of complexes  $[0 \rightarrow \mathbb{Z}^n] \rightarrow [0 \rightarrow \mathbb{Z}^{\ell} \xrightarrow{Q} \mathbb{Z}^{d+\ell} \rightarrow 0]$ , is given by the complex

$$0 \rightarrow \mathbb{Z}^{n+\ell} \xrightarrow{[BQ]} \mathbb{Z}^{d+\ell} \rightarrow 0.$$



We define  $\mathrm{DG}(\beta) := \mathrm{coker}([BQ]^\vee)$ , and define the map

$$\beta^\vee : (\mathbb{Z}^n)^\vee \rightarrow \mathrm{DG}(\beta)$$

by the composition  $(\mathbb{Z}^n)^\vee \hookrightarrow (\mathbb{Z}^{n+\ell})^\vee \rightarrow \mathrm{DG}(\beta)$ . We then have  $Z_\Sigma = \mathbb{A}^n \setminus \{0\}$  (since  $\Sigma$  is complete) is the quasi-affine variety associated to the fan. By defining  $G_\Sigma = \mathrm{Hom}_{\mathbb{Z}}(\mathrm{DG}(\beta), \mathbb{C}^*)$ , we get a morphism  $G_\Sigma \rightarrow (\mathbb{C}^*)^n$ , and this induces an action of  $G_\Sigma$  on  $Z_\Sigma$  via the natural action of  $(\mathbb{C}^*)^n$  on  $\mathbb{C}^n$ . The resulting stack  $\mathcal{X}(\Sigma) := [Z_\Sigma/G_\Sigma]$  is called the toric Deligne–Mumford stack associated to  $\Sigma$ .

**Example 5.2.12** ([BCS03, Example 3.5]). *Let  $\Sigma$  be the complete fan in  $\mathbb{Q}$ , and*

$$\beta : \mathbb{Z}^2 \xrightarrow{\begin{pmatrix} 2 & -3 \\ 1 & 0 \end{pmatrix}} \mathbb{Z} \oplus \mathbb{Z}_2 =: N.$$

*Then one can check that*

$$\beta^\vee : (\mathbb{Z}^2)^\vee \xrightarrow{\begin{pmatrix} 4 & 6 \end{pmatrix}} \mathrm{DG}(\beta) \simeq \mathbb{Z},$$

*and so the  $\mathbb{C}^*$  action on  $Z_\Sigma = \mathbb{A}^2 \setminus \{(0,0)\}$  is  $t \cdot (x,y) = (t^4x, t^6y)$ , yielding  $\mathcal{X}(\Sigma) \simeq \mathbb{P}(4,6) \simeq \overline{\mathcal{M}}_{1,1}$ .*

Given a stacky fan  $\Sigma = (\Sigma, \beta, N)$ , one can associate its rigidification  $\Sigma^{\mathrm{rig}} = (\Sigma, \beta^{\mathrm{rig}}, N/N_{\mathrm{tor}})$  by defining  $\beta^{\mathrm{rig}} : \mathbb{Z}^n \rightarrow N/N_{\mathrm{tor}}$  to be the composition of  $\beta$  and the quotient morphism  $N \rightarrow N/N_{\mathrm{tor}}$ . The stack  $\mathcal{X}(\Sigma^{\mathrm{rig}})$  is the DM stack associated to this stacky fan, and, by construction, comes with the rigidification map  $\mathcal{X}(\Sigma) \rightarrow \mathcal{X}(\Sigma^{\mathrm{rig}})$  induced from the injective morphism  $\mathrm{DG}(\beta^{\mathrm{rig}}) \rightarrow \mathrm{DG}(\beta)$ .

Closed substacks corresponding to cones of the fan are defined in [BCS03, Section 4]. We will restrict ourselves to the case of rays (one-dimensional cones), and recall the basic construction here. Let  $\rho_i$  be a ray of  $\Sigma$ ,  $e_i$  the positive generator of the  $i^{\mathrm{th}}$  summand of  $\mathbb{Z}^n$ ,  $N_{\rho_i}$  the subgroup of  $N$  generated by  $\beta(e_i)$ , and  $N(\rho_i) = N/N_{\rho_i}$

the quotient. This defines a surjection  $N_{\mathbb{Q}} \rightarrow N(\rho_i)_{\mathbb{Q}}$ , and the quotient fan  $\Sigma/\rho_i$  in  $N(\rho_i)_{\mathbb{Q}}$  is defined as the image of the cones in  $\Sigma$  containing  $\rho_i$  under this surjection. The link of  $\rho_i$  is defined as  $\text{link}(\rho_i) = \{\tau \mid \tau + \rho_i \in \Sigma, \text{ and } \rho_i \cap \tau = 0\}$ . Let  $\ell$  be the number of rays in  $\text{link}(\rho_i)$ . We define the closed substack associated to  $\rho_i$  as the triple  $\mathbf{\Sigma}/\rho_i = (\Sigma/\rho_i, N(\rho_i), \beta(\rho_i))$ , where

$$\beta(\rho_i) : \mathbb{Z}^{\ell} \rightarrow N(\rho_i)$$

is defined as the composition  $\mathbb{Z}^{\ell} \hookrightarrow \mathbb{Z}^n \xrightarrow{\beta} N \rightarrow N/N_{\rho_i} = N(\rho_i)$ . In particular, the divisor  $\mathcal{D}_{\rho_i}$  corresponding to the ray  $\rho_i$  is  $\mathcal{X}(\mathbf{\Sigma}/\rho_i)$ .

Of most importance to us is the fact that if  $\mathcal{X}$  is a toric DM stack whose coarse moduli space is  $\mathbb{P}^1$  or  $\mathbb{P}^2$ , then (amongst other things) [FMN10, Theorem II] shows that there exists a stacky fan whose corresponding quotient stack is  $\mathcal{X}$ . Moreover, in the case that  $\mathcal{X}$  is an orbifold, this fan is unique. This is far from true in the case where  $N$  has torsion, as is demonstrated in [FMN10, Example 7.29]. There are several sources of non-uniqueness, although in our situation it is essentially equivalent to the fact that it is possible to choose multiple lifts of an element in  $\mathbb{Z}_n$  to  $\mathbb{Z}$ .

From now on, we will restrict ourselves to the case of toric Deligne–Mumford stacks whose coarse moduli space is given by  $\mathbb{P}^1$  or  $\mathbb{P}^2$ . Let  $\mathcal{C} = \mathcal{X}(\mathbf{\Sigma})$  be a toric Deligne–Mumford stack whose rigidification is  $\mathbb{P}_{a,b}$ . Then, [FMN10, Proposition 7.20] shows that there is a unique class in  $\text{Ext}_{\mathbb{Z}}^1(N_{\text{tor}}, \text{Pic } \mathbb{P}_{a,b})$  such that the  $\text{Hom}(N_{\text{tor}}, \mathbb{C}^*)$ -banded gerbe over  $\mathbb{P}_{a,b}$  associated to this class is equivalent to  $\mathcal{C}$ . The proof of this proposition is constructive, and it is straightforward to determine the short exact sequence (5.5) from the data of a stacky fan. The main ingredient, however, which we will use in our application to invertible polynomials is [FMN10,

Theorem 7.24], which shows (as a special case) that if  $\Sigma$  is the complete fan in  $\mathbb{Q}$  and

$$\beta : \mathbb{Z}^2 \xrightarrow{\begin{pmatrix} a & -b \\ n_- & n_+ \end{pmatrix}} \mathbb{Z} \oplus \mathbb{Z}_d =: N,$$

then

$$X(\Sigma) \simeq \sqrt[d]{\mathcal{L}/\mathbb{P}_{a,b}}$$

as toric DM stacks, where  $\mathcal{L} = \mathcal{O}(q_-)^{n_-} \otimes \mathcal{O}(q_+)^{n_+}$ .

**Remark 5.2.13.** *It is important to emphasise that two inequivalent gerbes can be equivalent as toric DM stacks. This happens when the corresponding Ext-classes are isomorphic as sequences, but inequivalent as extensions – see [FMN10, Remark 7.23] and [BN05, Proposition 6.2]. In particular, the above application of [FMN10, Theorem 7.24] only makes a claim about toric DM stacks. By [FMN10, Proposition 7.20], one can check when this equivalence is also an equivalence of gerbes, although this will not be necessary for our purposes.*

**Example 5.2.14.** (cf. [BCS03, Example 3.6]) *Let  $\Sigma$  be the complete fan in  $\mathbb{Q}$ ,  $N = \mathbb{Z} \oplus \mathbb{Z}_3$ , and*

$$\beta_n : \mathbb{Z}^2 \xrightarrow{\begin{pmatrix} 1 & -1 \\ n & 0 \end{pmatrix}} \mathbb{Z} \oplus \mathbb{Z}_3.$$

*Since  $\Sigma$  is complete, we have  $Z_{\Sigma_n} = \mathbb{A}^2 \setminus ((0,0))$  for any  $n$ . In the case of  $n \bmod 3 = 0$ , we have*

$$\beta_0^\vee : (\mathbb{Z}^2)^\vee \xrightarrow{\begin{pmatrix} 1 & 1 \\ 0 & 0 \end{pmatrix}} \text{DG}(\beta) \simeq \mathbb{Z} \oplus \mathbb{Z}_3,$$

*and so  $G_{\Sigma_0} \simeq \mathbb{C}^* \times \mu_3$ , and  $\mathcal{X}(\Sigma_0) \simeq \mathbb{P}^1 \times B\mu_3$ . In the case where  $n \bmod 3 \neq 0$ , we*

have

$$\beta_n^\vee : (\mathbb{Z}^2)^\vee \xrightarrow{\begin{pmatrix} 3 & 3 \end{pmatrix}} \mathrm{DG}(\beta) \simeq \mathbb{Z},$$

and so  $G_{\Sigma_n} \simeq \mathbb{C}^*$ , and  $\mathcal{X}(\Sigma_n) \simeq \mathbb{P}(3, 3)$  as toric DM stacks for any such  $n$ . However, the class in  $\mathrm{Ext}_{\mathbb{Z}}^1(\mathbb{Z}_3, \mathbb{Z})$  corresponding to  $n$  is given by the sequence

$$0 \rightarrow \mathbb{Z} \xrightarrow{\times 3} \mathbb{Z} \xrightarrow{\times n} \mathbb{Z}_3 \rightarrow 0,$$

and so  $n_1$  and  $n_2$  do not define equivalent gerbes unless  $n_1 \equiv n_2 \pmod{3}$ . Moreover, this shows

$$\begin{aligned} \mathcal{X}(\Sigma_n) &\simeq \sqrt[3]{\mathcal{O}(1)/\mathbb{P}^1} \quad \text{for } n \pmod{3} = 1, \text{ and} \\ \mathcal{X}(\Sigma_n) &\simeq \sqrt[3]{\mathcal{O}(2)/\mathbb{P}^1} \quad \text{for } n \pmod{3} = 2. \end{aligned}$$

This also demonstrates the non-uniqueness of the fan in the case where the DM stack is not an orbifold – taking  $\beta_n$  for any  $n \in \mathbb{Z}$  yields a gerbe which is equivalent to the 3<sup>rd</sup> root of  $\mathcal{O}(n \pmod{3})$ .

### 5.3 Auslander orders

In this section, we give a brief account of the theory of Auslander orders, as introduced in [BD09] and expanded upon in [LP17b], before constructing the relevant generalisation.

Roughly speaking, an order is a non-commutative algebra which is finite over its centre. In [BD09], the notion of an *Auslander order* was introduced in studying non-commutative resolutions of the subcategory consisting of perfect complexes of the derived category of coherent sheaves on certain curves. Such an order is a sheaf of algebras, and a categorical resolution of the category of perfect complexes of the underlying curve is given by the derived category of finitely generated left modules of this sheaf, as discussed in the introduction to this chapter.

Before moving on to the situation we are focusing on, it is instructive to review the non-stacky case, as in [BD09]. Let  $C$  be a chain or ring of  $\mathbb{P}^1$ 's joined nodally, and  $\pi : \tilde{C} \rightarrow C$  its normalisation (i.e.  $\tilde{C}$  is a disjoint union of  $\mathbb{P}^1$ 's). Let  $\mathcal{I}$  be the ideal sheaf of the singular locus, and define the sheaf of  $\mathcal{O}_C$ -algebras

$$\mathcal{F} := \begin{pmatrix} \mathcal{I} \\ \mathcal{O}_C \end{pmatrix}. \quad (5.12)$$

One can then define the *Auslander sheaf* as

$$\mathcal{A}_C = \text{End}_{\mathcal{O}_C}(\mathcal{F}) = \begin{pmatrix} \tilde{\mathcal{O}}_C & \mathcal{I} \\ \tilde{\mathcal{O}}_C & \mathcal{O}_C \end{pmatrix}, \quad (5.13)$$

where  $\tilde{\mathcal{O}}_C = \pi_* \mathcal{O}_{\tilde{C}}$ . In [BD09], the authors study the category of finitely generated left  $\mathcal{A}_C$  modules on the ringed space  $(C, \mathcal{A}_C)$ . Their main result is that  $D^b(\mathcal{A}_C\text{-mod})$  has a tilting object, and is also a categorical resolution of  $\text{perf } C$ . They also show that  $D^b \text{Coh}(C)$  is equivalent to the localisation of  $D^b(\mathcal{A}_C\text{-mod})$  by a certain subcategory of torsion modules, yielding the sequence (5.2).

**Remark 5.3.1.** *In [BD09], the authors work with triangulated categories, however, these categories have unique dg-enhancements by the work of [LO10], and we work with these enhancements.*

In [LP17b], the authors build on the construction of [BD09] to allow for the nodes to have stacky structure, meaning that the irreducible components are orbifold curves of the form  $\mathbb{P}_{a,b}$ . We further extend this approach to allow for the irreducible components to have non-trivial generic stabiliser, although the major arguments in [LP17b] carry over to our situation with only minor alterations.

Let  $\mathcal{C}$  be as in Theorem 5.1.1 and choose a compatible gerbe structure on each irreducible component, meaning that the local model about  $q_{i,\pm}$  is compatible with the maps  $\psi_{i,\pm}$ . This can always be done by taking the root of a line bundle on

$\mathbb{P}_{r_{i,-}, r_{i,+}}$  whose restriction under (5.6) yields short exact sequences compatible with the action of the isotropy group at the nodes. Two compatible gerbe structures on an irreducible component will differ by how the two patches are identified on overlaps, but by (5.10), this does not affect our theory. To ease notation, we let  $\mathbb{P}_i = \mathbb{P}_{r_{i,-}, r_{i,+}}$  be the rigidified  $i^{\text{th}}$  irreducible component of  $\mathcal{C}$ . Let

$$\pi : \tilde{\mathcal{C}} = \bigsqcup_{i=1}^n \tilde{\mathcal{C}}_i \rightarrow \mathcal{C}$$

be the normalisation map, and  $H_i$  the isotropy group at the node  $q_i = |\mathcal{C}_i| \cap |\mathcal{C}_{i+1}|$ , and  $H_0$  and  $H_n$  the isotropy groups of the points  $q_{1,-}$  and  $q_{n,+}$ , respectively, in the chain case. At the points  $q_{i,+}$  and  $q_{i+1,-}$ , there are, by construction, short exact sequences

$$1 \rightarrow \mu_{d_i} \rightarrow H_{i,+} \xrightarrow{\psi_{i,+}} \mu_{r_{i,+}} \rightarrow 1, \quad \text{and} \quad (5.14)$$

$$1 \rightarrow \mu_{d_{i+1}} \rightarrow H_{i+1,-} \xrightarrow{\psi_{i+1,-}} \mu_{r_{i+1,-}} \rightarrow 1. \quad (5.15)$$

There are (non-canonical) isomorphisms  $H_i \simeq H_{i,+} \simeq H_{i+1,-}$ , although by choosing the representatives of (5.14) and (5.15) such that the  $\psi_{i,+}$  (resp.  $\psi_{i+1,-}$ ) are as in Theorem 5.1.1, one can take these identifications to be the identity. This yields the local model of  $q_i$ .

**Remark 5.3.2.** *It should be emphasised that, even when it would make sense, we do not require that the short exact sequences (5.14), (5.15) are equivalent such that  $H_{i,+} \simeq H_{i+1,-}$  via the identity map, only that the groups  $H_{i,+}$  and  $H_{i+1,-}$  can be identified with  $H_i$ .*

Recall that the ideal sheaf of a closed substack is the sheaf which pulls back to the ideal sheaf of the preimage in any atlas. As such, we define

$$\mathcal{I} = \bigoplus_i \pi_{i*} \mathcal{O}_{\tilde{\mathcal{C}}_i}(-q_{i,-} - q_{i,+})$$

for a ring of curves, and analogously for a chain. Here  $\pi_i : \tilde{\mathcal{C}}_i \rightarrow \mathcal{C}$  is again the natural

projection. We let  $\mathcal{F}$  be as in (5.12) and  $\mathcal{A}_{\mathcal{C}}$  be as in (5.13). For any integers  $j, m$ , and  $k \in \{0, \dots, d_i - 1\}$ , we define distinguished  $\mathcal{A}_{\mathcal{C}}$ -modules

$$\mathcal{P}_i(j, m, k) = \begin{pmatrix} \pi_{i*}(\mathcal{O}_{\tilde{\mathcal{C}}_i}(jq_{i,-} + mq_{i,+}) \otimes \mathcal{N}_i^{\otimes k}) \\ \pi_{i*}(\mathcal{O}_{\tilde{\mathcal{C}}_i}(jq_{i,-} + mq_{i,+}) \otimes \mathcal{N}_i^{\otimes k}) \end{pmatrix}.$$

For fixed integers  $j, m$ , and  $0 \leq k \leq d_i - 1$ , let  $\mathbf{Exc}_i(j, m, k)$  be the collection

$$\begin{array}{ccccccc} \mathcal{P}_i(j, m, k) & \xrightarrow{x_i} & \mathcal{P}_i(j+1, m, k) & \xrightarrow{x_i} & \dots & \xrightarrow{x_i} & \mathcal{P}_i(j+r_{i,-}, m, k) \\ \parallel & & & & & & \parallel \\ \mathcal{P}_i(j, m, k) & \xrightarrow{y_i} & \mathcal{P}_i(j, m+1, k) & \xrightarrow{y_i} & \dots & \xrightarrow{y_i} & \mathcal{P}_i(j, m+r_{i,+}, k) \end{array} \quad (5.16)$$

Note that by the decomposition (5.10), we have that  $\mathcal{P}_i(j, m, k)$  is orthogonal to  $\mathcal{P}_{i'}(j', m', k')$  unless  $k = k'$ . With this, it follows directly from the proof of [LP17b, Lemma 1.2.1] that the modules  $\mathcal{P}_i(j, m, k)$  are exceptional, and  $\mathbf{Exc}_i(j, m, k)$  is an exceptional collection for any fixed  $j, m$ , and  $k \in \{0, \dots, d_i - 1\}$ . In the case of  $d_i = 1$  we omit  $k$  from the notation.

As in the non-stacky and orbifold cases we also define simple modules at each node, given by

$$\mathcal{S}_q = \begin{pmatrix} 0 \\ \mathcal{O}_q \end{pmatrix}.$$

Fixing an identification of the isotropy group of the node  $q_i = |\mathcal{C}_i| \cap |\mathcal{C}_{i+1}|$  with  $H_i$  (for  $i$  counted modulo  $n$  in the ring case), let  $\psi_{i,+}$  and  $\psi_{i+1,-}$  be as in (5.14) and (5.15), respectively. We have that locally, around  $q_i$ , we can view  $\mathcal{A}_{\mathcal{C}}$ -modules as equivariant  $H_i$  modules on  $\text{Spec } \mathbb{C}[x, y]/(xy) = \text{Spec } S$ , where the  $H_i$  action is given by  $h \cdot (x, y) = (\psi_{i,+}(h)x, \psi_{i+1,-}(h)y)$ . We fix the  $\mu_{r_{i+1,-}}$  action on the fibre of the sheaf  $\mathcal{O}_{\mathbb{P}_{i+1}}(-q_{i+1,-})$  at  $q_{i+1,-}$  to be via its natural character, and similarly for the action of  $\mu_{r_{i,+}}$  on the fibre of the sheaf  $\mathcal{O}_{\mathbb{P}_i}(-q_{i,+})$  at  $q_{i,+}$ . Moreover, we define the character corresponding to the weight of the action of  $H_i$  on

the fibre of  $\mathcal{O}_{\tilde{C}_{i+1}}(-q_{i+1,-})$  to be the character induced from the natural character of  $\mu_{r_{i+1,-}}$  under the dual of  $\psi_{i+1,-}$ , and we call this  $\chi_{r_{i+1,-}}$ . We define  $\chi_{r_{i,+}}$  similarly as the character of  $H_i$  induced by the natural character under the dual of  $\psi_{i,+}$ . For the chosen gerbe structure, choose  $\chi_{d_{i,\pm}}$  such that  $d_{i,\pm}\chi_{d_{i,\pm}} = \chi_{r_{i,\pm}}$  as in Section 5.2.

Since  $H_i$  is diagonalisable (is isomorphic to a closed subgroup of an algebraic torus), we have an eigenspace decomposition of an  $H_i$ -equivariant  $S$ -module  $M$  as

$$M = \bigoplus_{\chi \in \widehat{H}_i} M_\chi,$$

where  $\widehat{H}_i$  is the group of characters of  $H_i$ . Furthermore, for any  $\chi \in \widehat{H}_i$  there is a twisting operation  $M \mapsto M\{\chi\}$  which identifies the  $\gamma$ -eigenspace of  $M\{\chi\}$  with the  $(\chi + \gamma)$ -eigenspace of  $M$ .

For a chain (resp. ring) of nodal stacky curves, consider a tuple of characters  $\boldsymbol{\chi} = (\chi_0, \dots, \chi_{n+1}) \in \widehat{H}_0 \oplus \dots \oplus \widehat{H}_{n+1}$  (resp.  $\boldsymbol{\chi} = (\chi_1, \dots, \chi_n) \in \widehat{H}_1 \oplus \dots \oplus \widehat{H}_n$ ). We call such a tuple *admissible* if there exists a line bundle  $\mathcal{O}_{\tilde{C}_i}(jq_{i,-} + mq_{i,+}) \otimes \mathcal{N}_i^{\otimes k}$  on each  $\tilde{C}_i$  such that  $H_{i-1}$  acts on the fibre at  $q_{i,-}$  with character  $\chi_{i-1}$  and  $H_i$  on the fibre at  $q_{i,+}$  with character  $\chi_i$ . Denote by  $\widehat{H}_{\text{ad}}$  the set of admissible characters. It is not true that  $\widehat{H}_{\text{ad}}$  contains any tuple of characters; however, for any character  $\chi \in \widehat{H}_i$  there is a tuple in  $\widehat{H}_{\text{ad}}$  such that  $\chi_i = \chi$ . For each admissible  $\boldsymbol{\chi}$ , we define the sheaf  $\mathcal{M}\{\boldsymbol{\chi}\}$  by gluing the line bundles of the above form together at the nodes.

Consider the map  $p : \mathcal{C} \rightarrow C$ , where  $C$  is the coarse moduli space of the stacky curve, i.e. is a chain or ring of  $\mathbb{P}^1$  joined nodally. Following [OS02], we call a sheaf  $\mathcal{E}$  on  $\mathcal{C}$  a *generator* of  $\text{QCoh}(\mathcal{C})$  with respect to  $p$  if the natural map

$$p^*(p_*\text{Hom}_{\mathcal{O}_{\mathcal{C}}}(\mathcal{E}, \mathcal{G})) \otimes \mathcal{E} \rightarrow \mathcal{G}$$

is a surjection for any  $\mathcal{G}$ .



**Lemma 5.3.3.** *The sheaf*

$$\bigoplus_{\chi \in \widehat{H}_{ad}} \mathcal{M}\{\chi\}$$

is a generator of  $\text{QCoh}(\mathcal{C})$  with respect to  $p$ .

*Proof.* Let  $x$  be a point of  $\mathcal{C}$ , considered as a map  $x : \text{Spec } \mathbb{C} \rightarrow \mathcal{C}$ . Let  $G_x$  be its isotropy group, and denote by  $\tilde{x} : BG_x \rightarrow \mathcal{C}$  the corresponding natural map. Then, [OS02, Theorem 5.2] stipulates that if  $\mathcal{E}$  is a locally free sheaf such that  $\tilde{x}^* \mathcal{E}$  contains every irreducible representation of  $G_x$  for every geometric point  $x$ , then  $\mathcal{E}$  is a generator of  $\text{QCoh}(\mathcal{C})$  with respect to  $p$ .

From the fact that for each  $\chi \in \widehat{H}_i$  there is a  $\chi \in \widehat{H}_{ad}$  such that  $\chi_i = \chi$ , it is clear that the fibre of  $\bigoplus_{\chi} \mathcal{M}\{\chi\}$  at any nodal point (as well as at  $q_{1,-}$  and  $q_{n,+}$  in the chain case) contains every irreducible representation of  $H_i$ . Since  $\chi_{d_i}$  pushes down to a generator of  $\mathbb{Z}_{d_i}$ , the fibre of  $\bigoplus_{\chi} \mathcal{M}\{\chi\}$  at a point whose isotropy group is  $\mu_{d_i}$  contains every irreducible representation of  $\mu_{d_i}$ , and this establishes the claim.  $\square$

To calculate the morphisms between the modules  $\mathcal{S}_{q_i}$ , and their twists  $\mathcal{S}_{q_i}\{\chi\}$  for  $\chi \in \widehat{H}_i$ , with the  $\mathcal{P}_i(j, m, k)$ , we can work locally in the patch  $U = \text{Spec } \mathcal{S}$ , as above, and consider  $H_i$  equivariant  $\mathcal{A}_U$ -modules. We begin by observing that, as in the non-stacky and orbifold cases, the only relevant Ext-class is given by the short exact sequence of  $\mathcal{A}_U$ -modules

$$0 \rightarrow \begin{pmatrix} I \\ I \end{pmatrix} \rightarrow \begin{pmatrix} I \\ \mathcal{O}_U \end{pmatrix} \rightarrow \mathcal{S}_{q_i} \rightarrow 0, \tag{5.17}$$

and that this class is  $H_i$ -equivariant. Therefore, we have morphisms

$$\begin{aligned} \text{Ext}^1(\mathcal{S}_{q_i}, \mathcal{P}_i(j, m, 0)) &= a_i(m, 0) \\ \text{Ext}^1(\mathcal{S}_{q_i}, \mathcal{P}_{i+1}(j, m, 0)) &= b_i(j, 0) \end{aligned}$$

for any  $m \equiv -1 \pmod{r_{i,+}}$ , and  $j \equiv -1 \pmod{r_{i+1,-}}$ , respectively. Consider  $\mathcal{M}\{\chi\}$

such that the character at  $q_i$  is  $\chi_i$ . It is clear that we have

$$\mathcal{S}_{q_i} \otimes \mathcal{M}\{\chi\} \simeq \mathcal{S}_{q_i}\{\chi_i\}.$$

In particular, as in (5.8), we have that for each  $\chi \in \widehat{H}_i$ , and any  $m_i, j_i, m_{i+1}, j_{i+1} \in \mathbb{Z}$ , there exists  $m \in \{m_i, \dots, m_i + r_{i,+} - 1\}$ ,  $k_+ \in \{0, \dots, d_i - 1\}$  and  $j \in \{j_{i+1}, \dots, j_{i+1} + r_{i+1,-} - 1\}$ ,  $k_- \in \{0, \dots, d_{i+1} - 1\}$  such that  $H_i$  acts on the fibres of the sheaves

$$\begin{aligned} & \mathcal{O}_{\tilde{c}_i}(mq_{i,+}) \otimes \mathcal{N}_i^{\otimes k_+}, \\ & \mathcal{O}_{\tilde{c}_{i+1}}(jq_{i+1,-}) \otimes \mathcal{N}_{i+1}^{\otimes k_-} \end{aligned}$$

at  $q_{i,+}$  and  $q_{i+1,-}$ , respectively, with character  $\chi$ .

By twisting the sequence (5.17) by  $\mathcal{M}\{\chi\}$ , we obtain morphisms

$$\begin{aligned} \text{Ext}^1(\mathcal{S}_{q_i}\{\chi\}, \mathcal{P}_i(j_i, m_0 + m, k_+)) &= \mathbb{C} \cdot a_i(m, k_+), \quad \text{and} \\ \text{Ext}^1(\mathcal{S}_{q_i}\{\chi\}, \mathcal{P}_{i+1}(j_0 + j, m_{i+1}, k_-)) &= \mathbb{C} \cdot b_i(j, k_-), \end{aligned} \tag{5.18}$$

for each  $\chi \in \widehat{H}_i$ , where  $m_0 \in \{m_i, \dots, m_i + r_{i,+} - 1\}$  is a distinguished element such that

$m_0 \equiv -1 \pmod{r_{i,+}}$ , and  $(m, k_+)$  as above solves

$$-m\chi_{r_{i,+}} + k_+\chi_{d_{i,+}} = \chi, \tag{5.19}$$

$j_0 \in \{j_{i+1}, \dots, j_{i+1} + r_{i+1,-} - 1\}$  is a distinguished element such that  $j_0 \equiv -1 \pmod{r_{i+1,-}}$ , and  $(j, k_-)$  as above solves

$$-j\chi_{r_{i+1,-}} + k_-\chi_{d_{i+1,-}} = \chi. \tag{5.20}$$

Now, we have constructed a full, strong exceptional collection consisting of the objects:

- For any fixed  $j_i, m_i \in \mathbb{Z}$ , and each irreducible component, being a  $\mu_{d_i}$ -gerbe

over  $\mathbb{P}_i$ , the collections

$$\bigoplus_{k=0}^{d_i-1} \mathbf{Exc}_i(j_i, m_i, k),$$

- For each node  $q_i = |\mathcal{C}_i| \cap |\mathcal{C}_{i+1}|$ , the objects

$$\mathcal{S}_{q_i}\{\chi_k\} \quad \text{for each } \chi_k \in \widehat{H}_i.$$

The endomorphism algebra of this collection is generated by the morphisms  $x_i, y_i$  in (5.16), as well as the morphisms given by (5.18). The relations are  $ya = 0$  and  $xb = 0$  whenever the composition is possible. The proof of this, as well as the claim that the collection is full and strong, can be seen from following through the proof of [LP17b, Theorem 1.2.3] *mutatis mutandis* (cf. [BD09, Theorem 9]). Of course, the resulting category  $D^b(\mathcal{A}_{\mathcal{C}} - \text{mod})$  only depends on the parameters stated in Theorem 5.1.1, ultimately for the same reason as  $D^b \text{Coh}(\mathcal{C})$  does.

## 5.4 The partially wrapped Fukaya category

In this section, we recount the strategy of [HKK14] for constructing the partially wrapped Fukaya category of a graded symplectic surface before describing the collections of generating objects for surfaces glued from columns of cylinders, as described in Section 4.3.2.

### 5.4.1 Computation of the partially wrapped Fukaya category

Given a surface with non-empty boundary,  $\Sigma$ , and a collection of stops on its boundary  $\Lambda$ , [HKK14, Section 3] shows that if  $\{L_i\}$  is a collection of pairwise disjoint and non-isotopic Lagrangians such that  $\Sigma \setminus (\sqcup_i L_i)$  is topologically a union of discs, each of which with exactly one marked point on its boundary, then the  $L_i$  generate  $D^b \mathcal{W}(\Sigma; \Lambda)$ . Moreover, it is also shown that the total endomorphism algebra of the generators is formal, and can be described as the algebra of a quiver with monomial relations. A connection to the representation theory of finite dimensional algebras is given by the observation that the endomorphism algebra of such a generating

collection of objects is *gentle*.

To construct the partially wrapped Fukaya category, it was shown that there exists a ribbon graph dual to the collection of Lagrangians. This graph has an  $n$ -valent vertex at the centre of each  $2n$ -gon cut out by the Lagrangians, and the half edges connect two vertices if that edge is dual to a Lagrangian on the boundary of both of the corresponding discs. The cyclic ordering is induced from the orientation of the surface. From this, it was shown in [HKK14, Theorem 3.1] that the partially wrapped Fukaya category is given as the global sections of a constructible cosheaf of  $A_\infty$ -categories on the ribbon graph. In particular, for each  $n$ -valent vertex at the centre of a  $2n$ -gon, there is a fully faithful inclusion functor

$$D^b\mathcal{W}(\mathbb{D}^2; n+1) \rightarrow D^\pi\mathcal{W}(\Sigma; \Lambda), \quad (5.21)$$

where  $D^b\mathcal{W}(\mathbb{D}^2; n+1)$  is the derived partially wrapped Fukaya category of the disc with  $n+1$  stops on its boundary.

The two prototypical examples from which our strategy is built are the disc with  $m$  points on its boundary, as well as the cylinder with  $a$  stops on one boundary, and  $b$  stops on the other. Consider the disc with  $m$  stops on its boundary, and  $m-1$  Lagrangians,  $L_1, \dots, L_{m-1}$  supported near these stops, as in Figure 5.1. The morphisms between Lagrangians is given by the Reeb flow along the boundary of the disc in the anticlockwise direction. Let  $a_i : L_i \rightarrow L_{i+1}$  be such a morphism, and observe that  $a_{i+1}a_i = 0$  for  $i = 1, \dots, m-2$ . It is clear that the endomorphism algebra of the direct sum  $\bigoplus_{i=1}^{m-1} L_i$  is the  $A_{m-1}$  quiver with relations given by disallowing any composition.

There are two key facts about the collection of Lagrangians  $L_1, \dots, L_{m-1}$ . The first is that the Lagrangian  $L_m$  is quasi-isomorphic to the twisted complex

$$L_1[m-2] \longrightarrow L_2[m-3] \longrightarrow \dots \longrightarrow L_{m-2}[-1] \longrightarrow L_{m-1}. \quad (5.22)$$

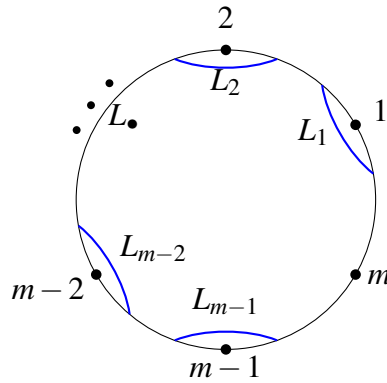

**Figure 5.1:** A collection of generating Lagrangians for  $\mathbb{D}^2$  with  $m$  stops. The Reeb flow is in the counter-clockwise direction.

This is first observed in [HKK14, Section 3.3], and will be important later in our localisation argument. The second key observation is that the complement  $\mathbb{D}^2 \setminus (\sqcup_{i=1}^{m-1} L_i)$  is a collection of topological discs, each with exactly one marked point on the boundary. Therefore, the collection  $\{L_1, \dots, L_{m-1}\}$  generates the partially wrapped Fukaya category  $D^b\mathcal{W}(\mathbb{D}^2; m)$ .

The second fundamental example which forms the cornerstone of our strategy is the cylinder,  $A$ , with  $a$  stops on one boundary component, and  $b$  on the other. A generating collection of Lagrangians on such an annulus is given in Figure 5.2, and its corresponding quiver in Figure 5.3. Observe that the quiver algebra of the generators for the single annulus with  $a$  stops on one boundary component and  $b$  on the other matches precisely the quiver algebra of the exceptional collection of  $\mathbb{P}_{a,b}$  given in (5.9). This establishes that

$$D^b\mathcal{W}(A; a, b) \simeq D^b\text{Coh}(\mathbb{P}_{a,b}),$$

and this observation is at the heart of our strategy.

### 5.4.1.1 Circular Gluing

Here, we compute the partially wrapped Fukaya category for columns of cylinders glued circularly, as in Section 4.3.2. To begin with, we add two stops on each attaching strip – one on the top, and one on the bottom. We will refer to this collection

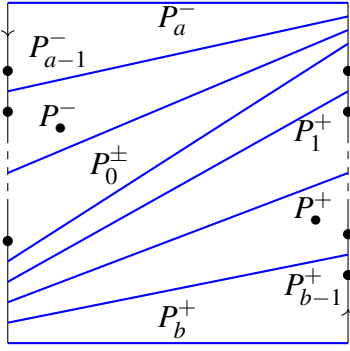

**Figure 5.2:** A collection of generating Lagrangians for  $A(a,b;0)$ . Top and bottom identified.

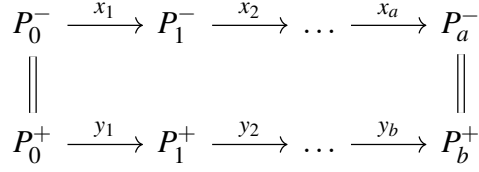

**Figure 5.3:** Quiver for  $A(a,b;0)$ .

as  $\Lambda$ . On the  $k^{\text{th}}$  annulus in the  $i^{\text{th}}$  column we have a collection of Lagrangians  $P_{i,k}$  of the same form as in Figure 5.2. This collection consists of the objects

$$\{P_{i,0,k}^+, P_{i,1,k}^+, \dots, P_{i,r_i,k}^+, P_{i,0,k}^-, \dots, P_{i,\ell_i,k}^-\}.$$

The morphisms within this collection are of the same form as in Figure 5.3. For each attaching strip, we consider a Lagrangian which spans it in such a way that the two stops are in the clockwise direction of its endpoints. We label the Lagrangian which spans the attaching strip beginning at the neighbourhood around the  $j^{\text{th}}$  stop between the  $i^{\text{th}}$  and  $(i+1)^{\text{st}}$  columns by  $S_{i,j}$ . Here  $j \in \{0, \dots, r_i m_i - 1\}$  and  $i \in \mathbb{Z}_n$ .

As well as the morphisms within each collection  $P_{i,k}$ , if we write  $j = k_+ r_i + c_+$  and  $\sigma(j) = k_- \ell_{i+1} + c_-$  for  $k_+ \in \{0, \dots, d_i - 1\}$ ,  $c_+ \in \{0, \dots, r_i - 1\}$ ,  $k_- \in \{0, \dots, d_{i+1} - 1\}$ , and  $c_- \in \{0, \dots, \ell_{i+1} - 1\}$ , we also have morphisms

$$a_{i,j} : S_{i,j} \rightarrow P_{i,c_+,k_+}^+$$

$$b_{i,j} : S_{i,j} \rightarrow P_{i+1,\ell_{i+1}-1-c_-,k_-}^-.$$

By construction, the complement of this collection of Lagrangians is the disjoint union of hexagons, each with exactly one stop on its boundary. Therefore, we have that the collection of Lagrangians consisting of all of the  $P_{i,k}$ , as well as the  $S_{i,j}$  is a

generating collections of Lagrangians for  $D^b\mathcal{W}(\Sigma; \Lambda)$ .

### 5.4.1.2 Linear Gluing

The case of linear gluing is almost identical to that of circular gluing; however, the first and last columns are now no longer glued to each other. Due to this, we include the stops on the distinguished boundary components in  $\Lambda$ , although we allow the number of stops on the distinguished boundary components to be zero. In dividing the surface into topological discs for the computation of the partially wrapped Fukaya category, observe that a topological disc with a Lagrangian  $S_{i,j}$  on its boundary is a hexagon, as in the circular gluing case, and a quadrilateral otherwise. The generating collection is again given by all of the  $P_{i,k}$ , as well as the  $S_{i,j}$ . See Figure 5.4 for an example, where its corresponding quiver is given in Figure 5.5.

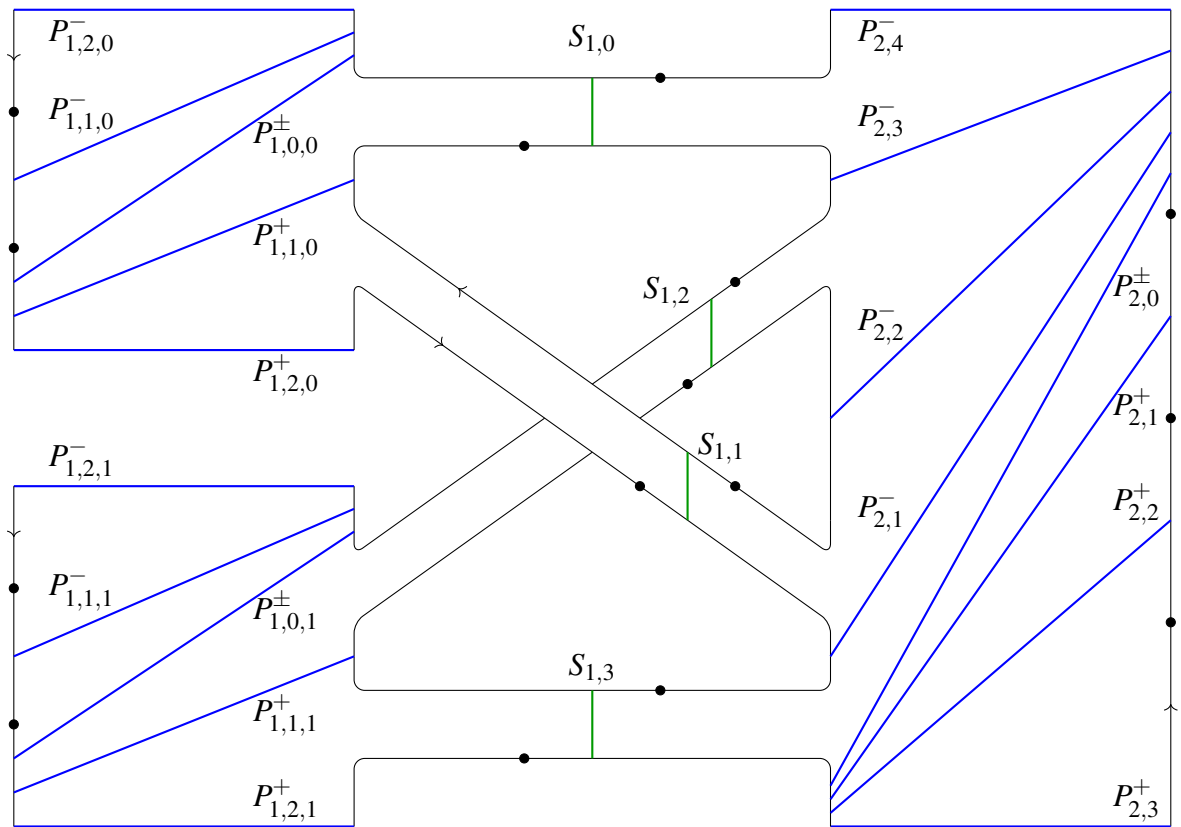

**Figure 5.4:** Generating collections of Lagrangians for linear gluing of  $A(2, 2; 2)$  to  $A(4, 3; 1)$  via  $\sigma_1 : (0, 1, 2, 3) \mapsto (0, 2, 1, 3)$ . Top and bottom of each annulus is identified.

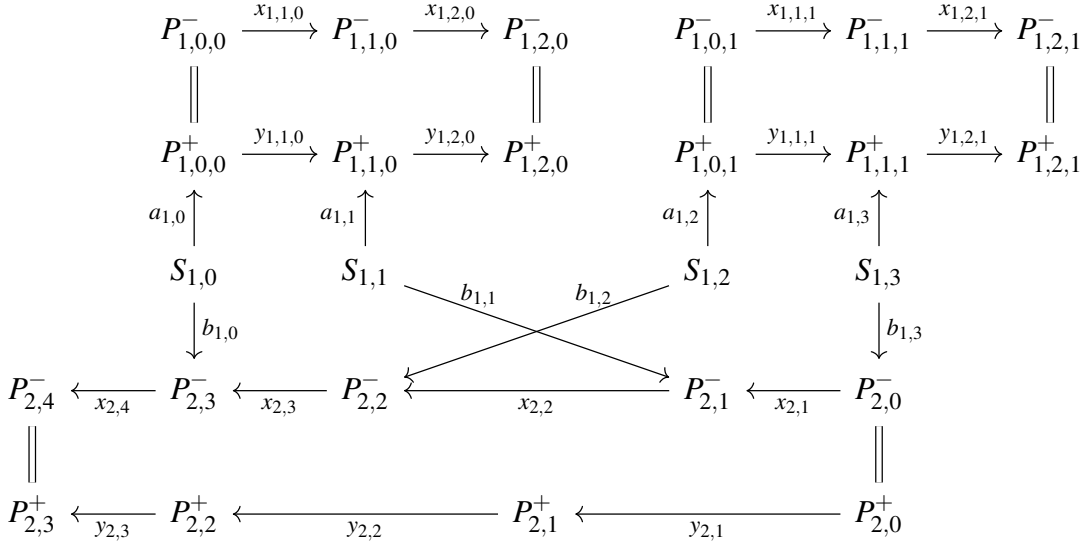

**Figure 5.5:** Quiver describing the endomorphism algebra of the generating collection of Figure 5.4. Relations given by  $xb = 0$  and  $ya = 0$ .

## 5.5 Localisation

As described in the introduction, there are natural localisation functors on the A– and B–sides, given by the second functors in (5.1) and (5.2), respectively. The strategy to establish Theorem 5.1.3 is to show that the quasi-equivalence in Theorem 5.1.1 intertwines localisation on both sides, although this argument is also required to prove Theorem 5.1.1 in the case of a chain of curves with  $r_{1,-}$  and/ or  $r_{n,+}$  zero. In this section, we describe the localisation functors on the A– and B–sides before establishing Theorem 5.1.1.

### 5.5.1 Localisation on the B–side

As in the non-stacky case ([BD09, Section 4]), we consider the functor

$$\text{Hom}_{\mathcal{A}}(\mathcal{F}, -) : \mathcal{A}_{\mathcal{C}} - \text{mod} \rightarrow \text{Coh } \mathcal{C}, \tag{5.23}$$

and construct a subcategory  $\mathcal{T}$  on which this functor vanishes. We again work locally, and so the analysis follows from the non-stacky case by working equivariantly, as is demonstrated in the orbifold case [LP17b, Section 3.2]. Note that this functor is exact since  $\mathcal{F}$  is a summand of  $\mathcal{A}_{\mathcal{C}}$ , so is locally projective.



In order to construct  $\mathcal{T}$ , we define the modules

$$\tilde{\mathcal{S}}_i(j, k)^\pm = \left( \begin{array}{c} \pi_{i*}(\mathcal{O}_{\tilde{C}_i}(jq_{i,\pm}) \otimes \mathcal{N}_i^{\otimes k})|_q \\ \pi_{i*}(\mathcal{O}_{\tilde{C}_i}(jq_{i,\pm}) \otimes \mathcal{N}_i^{\otimes k})|_q \end{array} \right),$$

where  $q = \pi_i(q_{i,\pm})$ . These modules fit into the short exact sequences

$$\begin{aligned} 0 \longrightarrow \mathcal{P}_i(j-1, m, k) \longrightarrow \mathcal{P}_i(j, m, k) \longrightarrow \tilde{\mathcal{S}}_i(j, k)^- \longrightarrow 0 \\ 0 \longrightarrow \mathcal{P}_i(j, m-1, k) \longrightarrow \mathcal{P}_i(j, m, k) \longrightarrow \tilde{\mathcal{S}}_i(m, k)^+ \longrightarrow 0, \end{aligned} \quad (5.24)$$

and have support at  $\pi_i(q_\pm)$ . When the point  $q_{i,\pm}$  is not a node (i.e. the  $q_{1,-}$  and  $q_{n,+}$  in the chain case) we set  $\mathcal{E}_i^\pm(j, k) = \tilde{\mathcal{S}}_i(j, k)^\pm$ . If  $q_{i,\pm}$  is a node, then we have natural inclusions

$$\begin{aligned} \mathcal{S}_{q_i}\{\chi_+\} &\hookrightarrow \tilde{\mathcal{S}}_i(m, k)^+ \\ \mathcal{S}_{q_{i-1}}\{\chi_-\} &\hookrightarrow \tilde{\mathcal{S}}_i(j, k)^-, \end{aligned}$$

where  $\chi_+$  (resp.  $\chi_-$ ) is the character through which  $H_i$  (resp.  $H_{i-1}$ ) acts on the fibre of the sheaf  $\mathcal{O}_{\tilde{C}_i}(mq_{i,+}) \otimes \mathcal{N}_i^{\otimes k}$  (resp.  $\mathcal{O}_{\tilde{C}_i}(jq_{i,-}) \otimes \mathcal{N}_i^{\otimes k}$ ) at  $q_{i,+}$  (resp.  $q_{i,-}$ ). We then define  $\mathcal{E}_i(j, k)^\pm$  to fit into the short exact sequences

$$\begin{aligned} 0 \longrightarrow \mathcal{S}_{q_i}\{\chi_+\} \longrightarrow \tilde{\mathcal{S}}_i(m, k)^+ \longrightarrow \mathcal{E}_i(m, k)^+ \longrightarrow 0, \\ 0 \longrightarrow \mathcal{S}_{q_{i-1}}\{\chi_-\} \longrightarrow \tilde{\mathcal{S}}_i(j, k)^- \longrightarrow \mathcal{E}_i(j, k)^- \longrightarrow 0. \end{aligned}$$

As in the orbifold case, we find that the objects  $\mathcal{E}_i(j, k)^\pm$  are exceptional unless  $\pi_i(q_{i,\pm})$  is a smooth point with no stacky structure. At nodes, this follows from the presentation as a quotient of  $xy = 0$  by  $H_i$ . In this presentation, the relevant Ext-groups are the  $H_i$ -invariant classes of the Ext-groups computed on  $xy = 0$ , and it is shown in [LP17b, Lemma 3.2.1] that these groups vanish. In the case where the point is a smooth point with non-trivial stacky structure, we find that the objects  $\mathcal{E}_i(j, k)^\pm$  are exceptional from the locally projective resolution (5.24). We define  $\mathcal{T}$  to be the subcategory formed by direct sums of all the objects  $\mathcal{E}_i(j, k)^\pm$  supported at

the nodes.

With this, we have that  $\mathcal{T} \subseteq D^b(\mathcal{A}_{\mathcal{C}} - \text{mod})$  is a Serre subcategory, and identifies

$$\begin{aligned} \text{Coh}\mathcal{C} &\simeq \mathcal{A}_{\mathcal{C}} - \text{mod}/\mathcal{T} \\ D^b\text{Coh}(\mathcal{C}) &\simeq D^b(\mathcal{A}_{\mathcal{C}} - \text{mod})/\langle\mathcal{T}\rangle. \end{aligned}$$

To see this, note that the derived equivalence follows from the equivalence of abelian categories by [Miy91]. The equivalence of abelian categories is given for non-stacky curves in [BD09, Theorem 4.8], and the present situation follows from this. As explained in the orbifold case, [LP17b, Proposition 3.2.3], one must check that the unit of a certain adjunction is an equivalence, and this boils down to checking the statement locally at nodes. One can then use the presentation at a node as the quotient of  $xy = 0$  by  $H_i$ , and the argument follows from the non-stacky case.

### 5.5.2 Localisation on the A-side

Part of the utility of the construction in [HKK14] is that it not only provides a categorical resolution of the compact Fukaya category of a surface, but also gives an explicit description of a map

$$D^\pi\mathcal{W}(\Sigma; \Lambda) \rightarrow D^\pi\mathcal{W}(\Sigma; \Lambda'),$$

where  $\Lambda'$  is obtained from  $\Lambda$  by removing stops. This map is given by taking the quotient of the partially wrapped Fukaya category by the category generated by Lagrangians which are supported near the stops being removed. In particular, by removing all of the stops in the case of circular gluing, one recovers a map to the wrapped Fukaya category of the surface. In the case of linear gluing, the situation is analogous, however, the stops on the distinguished boundary components are not removed. It is in this context that the quasi-isomorphism (5.22) and the functor (5.21) show their utility by giving the Lagrangian supported near a stop to be removed in terms of the generating Lagrangians of a disc.

For circular gluing, we will define the object  $E_{i,j}^+$  (resp.  $E_{i+1,j}^-$ ) to be Lagrangian supported near the stop on the bottom (resp. top) of the attaching strip beginning at the neighbourhood of the  $j^{\text{th}}$  stop on a boundary component between the  $i^{\text{th}}$  and  $(i+1)^{\text{st}}$  columns. By again writing  $j = k_+ r_i + c_+$  and  $\sigma_i(j) = k_- \ell_{i+1} + c_-$  for  $k_+ \in \{0, \dots, d_i - 1\}$ ,  $c_+ \in \{0, \dots, r_i - 1\}$ ,  $k_- \in \{0, \dots, d_{i+1} - 1\}$ , and  $c_- \in \{0, \dots, \ell_{i+1} - 1\}$ , we have by (5.22) and (5.21)

$$\begin{aligned} E_{i,j}^+ &\simeq \{S_{i,j}[3] \rightarrow P_{i,c_+,k_+}^+[2] \rightarrow P_{i,c_++1,k_+}^+[1]\} \\ E_{i+1,j}^- &\simeq \{S_{i,j}[3] \rightarrow P_{i+1,\ell_{i+1}-1-c_-,k_-}^-[2] \rightarrow P_{i+1,\ell_{i+1}-c_-,k_-}^-[1]\}. \end{aligned}$$

In the case of linear gluing we have the same iterated cones in for the hexagonal regions, as well as the cones

$$\begin{aligned} E_{1,j}^- &\simeq \{P_{i,j}^-[2] \rightarrow P_{i,j+1}^-[1]\} \\ E_{n,j}^+ &\simeq \{P_{i,j}^+[2] \rightarrow P_{i,j+1}^+[1]\}. \end{aligned}$$

*Proof of Theorem 5.1.1.* In order to prove the statement, it suffices to match the generators of the categories in question. We begin with the case of a ring of curves, or a chain where both  $r_{1,-}, r_{n,+} > 0$ . On the B-side, we fix an exceptional collection such that  $j_i = 0$  and  $m_i = -1$ . We again label the characters in  $\widehat{H}_i$  such that  $\chi_{k_+ r_{i,+} + m}$  is the character of  $\mathcal{O}_{\widetilde{\mathcal{C}}_i}(mq_{i,+}) \otimes \mathcal{N}_i^{\otimes k_+}$ . On the A-side we construct the candidate mirror as follows. For each irreducible component  $\mathcal{C}_i$  of  $\mathcal{C}$ , being a  $\mu_{d_i}$ -gerbe over  $\mathbb{P}_{r_{i,-}, r_{i,+}}$ , we consider a column of annuli  $A(r_{i,-}, r_{i,+}; d_i)$ . Let  $j, k_-$  solve

$$-j\chi_{r_{i+1,-}} + k_-\chi_{d_{i+1,-}} = \chi_{k_+ r_{i,+} + m},$$

as in (5.20). We then define the permutation  $\sigma_i$  to be given by

$$k_+ r_{i,+} + m \mapsto k_- r_{i+1,-} + (-j) \bmod r_{i+1,-}.$$

Let  $\Sigma$  be the surface constructed in this way, and let  $D^b\mathcal{W}(\Sigma;\Lambda)$  be its partially wrapped Fukaya category, as described in Section 5.4.1. The identification of the generation objects on both sides is given by:

$$\begin{aligned} P_{i,j,k}^- &\longleftrightarrow \mathcal{P}_i(j, -1, k) \\ P_{i,m,k}^+ &\longleftrightarrow \mathcal{P}_i(0, m-1, k) \\ S_{i,j} &\longleftrightarrow \mathcal{S}_i\{\chi_j\}[-1]. \end{aligned}$$

From this, we can see that the endomorphism algebras of the two exceptional collections which generate their respective categories are equivalent, which establishes the claim in this case.

To complete the proof in the case of a ring of curves, where either or both of  $r_{1,-}, r_{n,+} = 0$ , we must utilise [LP17b, Proposition 3.2.2], which, suitably reworded to our context, states that under the above equivalence, we have a correspondence

$$\{\mathcal{A}_{\mathcal{C}}\text{-modules } \mathcal{E}_i^-(j, k)\} \longleftrightarrow \{E_{i,r_{i,-}k+j}^-[-1]\} \quad (5.25)$$

$$\{\mathcal{A}_{\mathcal{C}}\text{-modules } \mathcal{E}_i^+(m, k)\} \longleftrightarrow \{E_{i,r_{i,+}k+m-1}^+[-1]\}. \quad (5.26)$$

The proof of the alteration of the statement to our situation follows directly from the proof of the original statement. Namely, we let  $\mathbf{Exc}$  be the direct sum of the objects in the exceptional collection in  $D^b(\mathcal{A}_{\mathcal{C}}\text{-mod})$  described in Section 5.3 and  $A$  its endomorphism algebra. One can describe the right  $A$ -modules of the form  $\mathrm{RHom}(\mathbf{Exc}, -)$  corresponding to the objects  $\mathcal{E}_i^-(j, k)$  and  $\mathcal{E}_i^+(m, k)$  in the equivalence

$$\mathrm{RHom}(\mathbf{Exc}, -) : D^b(\mathcal{A}_{\mathcal{C}}\text{-mod}) \xrightarrow{\sim} D^b(\mathrm{mod} - A),$$

and see that they match with the objects in  $D^b(\mathrm{mod} - A)$  calculated using the presentations of  $E_{i,j}^-$  (resp.  $E_{i,j-1}^+$ ) given in Section 5.5.2.

Now, consider the case of  $r_{n,+} > r_{1,-} = 0$ , and define the stack  $\bar{\mathcal{C}}$  to be the same curve as  $\mathcal{C}$ , but where  $\mathcal{C}_1 = \mathbb{P}_{1,r_{1,+}}$ . Namely, we have  $\mathcal{C} = \bar{\mathcal{C}} \setminus \{q_{1,-}\}$ . Since  $\mathcal{A}_{\bar{\mathcal{C}}}$  is isomorphic near  $q_{1,-}$  to the matrix algebra over  $\mathcal{O}$ , we have that the restriction functor

$$\mathcal{A}_{\bar{\mathcal{C}}} - \text{mod} \rightarrow \mathcal{A}_{\mathcal{C}} - \text{mod}$$

identifies  $\mathcal{A}_{\mathcal{C}} - \text{mod}$  with the quotient of  $\mathcal{A}_{\bar{\mathcal{C}}} - \text{mod}$  by the Serre subcategory generated by  $\bigoplus_{k=0}^{d_1-1} \mathcal{E}_1(0,k)^-$  (i.e.  $\bigoplus_{k=0}^{d_1-1} \begin{pmatrix} \mathcal{O}_{q_{1,-}} \\ \mathcal{O}_{q_{1,-}} \end{pmatrix} \otimes \mathcal{N}_1^{\otimes k}$ ). By the main result of [Miy91], this yields a derived equivalence

$$D^b(\mathcal{A}_{\bar{\mathcal{C}}} - \text{mod}) / \langle \bigoplus_{k=0}^{d_1-1} \mathcal{E}_1(0,k)^- \rangle \simeq D^b(\mathcal{A}_{\mathcal{C}} - \text{mod}).$$

From the first part of the proof, there is a graded surface  $(\Sigma, \bar{\Lambda})$  such that

$$D^b\mathcal{W}(\Sigma; \bar{\Lambda}) \simeq D^b(\mathcal{A}_{\bar{\mathcal{C}}} - \text{mod}).$$

Now, since  $\mathcal{E}_1^-(0,k)$  is identified with  $E_{1,k}^-[-1]$  in (5.25), removing the stops on the left distinguished boundary corresponds to localising  $D^b(\mathcal{A}_{\bar{\mathcal{C}}} - \text{mod})$  by the category generated by  $\bigoplus_{k=0}^{d_1-1} \mathcal{E}_1(0,k)^-$ , which yields the result. The cases of  $r_{1,-} > r_{n,+} = 0$  or  $r_{0,-} = r_{n-1,+} = 0$  are analogous.  $\square$

**Remark 5.5.1.** *Choosing different values for  $m_i$  and  $j_i$  in the above theorem corresponds to changing the identification of the cylinders on the A-side by a cyclic reordering. This yields homeomorphic mirrors, since cyclically changing the identification of an individual annulus, and/ or reordering the annuli in a column, does not change the number of cycles, or their length, in the cycle decomposition determining the topology of the surface.*

## 5.6 Characterisation of perfect derived categories

In order to establish the statement about perfect objects in Theorem 5.1.3, one must show that the compact Fukaya category and derived category of perfect complexes, considered as full subcategories of  $D^b\mathcal{W}(\Sigma; \Lambda)$  and  $D^b(\mathcal{A}_{\mathcal{C}} - \text{mod})$ , respectively, are identified with each other under the quasi-equivalence of Theorem 5.1.1. The aim of this section is to characterise perfect complexes on the A– and B–sides of the correspondence before establishing Theorem 5.1.3.

### 5.6.1 The derived category of perfect complexes

As in the localisation argument, our strategy closely follows that of [BD09, Theorem 2] for the non-stacky case. Let  $\mathcal{C}$  be a ring or chain of curves with  $r_{1,-}, r_{n,+} > 0$ ,  $\mathcal{F}$  as in Section 5.3, and consider the functor

$$\begin{aligned} \text{perf } \mathcal{C} &\rightarrow D^b(\mathcal{A}_{\mathcal{C}} - \text{mod}) \\ G &\mapsto \mathcal{F}_{\mathcal{C}} \otimes_{\mathcal{O}_{\mathcal{C}}} G. \end{aligned}$$

In the non-stacky case, it is shown that this functor is full and faithful in [BD09, Theorem 2 (5)], and this result is generalised to the orbifold case in [LP17b, Proposition 4.1.3]. As in these cases, one can again identify the essential image of  $\text{perf } \mathcal{C}$  in  $D^b(\mathcal{A}_{\mathcal{C}} - \text{mod})$  as the subcategory which is both left and right orthogonal to the category  $\mathcal{T}$  defined in Section 5.5.1. The proof of this follows verbatim from the proof of [LP17b, Proposition 4.1.3 (i)] after replacing  $\mu_r$  by  $H$ , an extension of  $\mu_r$  by  $\mu_d$ . In the case of a ring of curves with  $r_{n,+} > r_{1,-} = 0$ , the category of compactly supported perfect complexes on  $\mathcal{C}$  is identified with the category which is both left and right orthogonal to  $\overline{\mathcal{T}}$ , where this category is formed by the objects of  $\mathcal{T}$ , together with  $\mathcal{E}_1(k)^-$  for  $0 \leq k \leq d_1 - 1$ . To prove this, observe that  $\mathcal{E}_1^-(0, k) \simeq \begin{pmatrix} \mathcal{O}_{q_{1,-}}(k\chi_{d_{1,-}}) \\ \mathcal{O}_{q_{1,-}}(k\chi_{d_{1,-}}) \end{pmatrix}$  near  $q_{1,-}$ , and so a module in  $\text{perf } \overline{\mathcal{C}}$  is left or right orthogonal to  $\bigoplus_{k=0}^{d_1-1} \mathcal{E}_1^-(0, k)$  if and only if its support does not contain  $q_{1,-}$ . Then, the rest of the proof in this case follows as in [LP17b, Proposition 4.1.3 (ii)]. The cases when  $r_{1,-} > r_{n,+} = 0$  and  $r_{1,-} = r_{n,+} = 0$  are considered similarly.

### 5.6.2 Characterisation of the Fukaya category

On the A–side of the correspondence, the characterisation of the Fukaya category as a subcategory of the partially wrapped Fukaya category remains unchanged from [LP17b, Section 4.2]. We briefly recall the argument here, and refer to loc. cit. for the proof.

Let  $\mathcal{T}_i$  be the collection of Lagrangians supported near the stops on the  $i^{\text{th}}$  boundary component. It is shown ([LP17b, Proposition 4.2.1]) that  $\mathcal{T}_i^\perp = {}^\perp \mathcal{T}_i$  corresponds to those Lagrangians in  $D^b\mathcal{W}(\Sigma; \Lambda)$  *not* ending on the  $i^{\text{th}}$  boundary component. One direction of this argument is clear: if there is a Lagrangian which is either compact, or does not end on the  $i^{\text{th}}$  boundary component, then the intersection with the geometric representatives of Lagrangians supported near the stops can be taken to be empty. In the other direction, one shows that if a Lagrangian *does* end on a boundary component, then there is necessarily a non-trivial morphism at the level of cohomology between this Lagrangian and a Lagrangian in  $\mathcal{T}_i$ . In the case where just one endpoint of the Lagrangian lies on the  $i^{\text{th}}$  boundary component there is a chain level morphism between the Lagrangian and a Lagrangian in  $\mathcal{T}_i$  which is of rank one, so the differential vanishes. In the case where both endpoints lie on the  $i^{\text{th}}$  boundary component, the chain level morphism complex between the Lagrangian and a Lagrangian in  $\mathcal{T}_i$  is either rank one or two. In the rank one case we again have that the differential must vanish, and in the rank two case one shows that the differential vanishes by a covering argument. This shows that any Lagrangian with at least one endpoint on the  $i^{\text{th}}$  boundary component cannot belong to  $\mathcal{T}_i^\perp$ . Checking that a Lagrangian with at least one endpoint on the  $i^{\text{th}}$  boundary component cannot belong to  ${}^\perp \mathcal{T}_i$  is done in the same way.

By summing over the boundary components of  $\Sigma$  we define  $\mathcal{T} = \bigoplus_i \mathcal{T}_i$ . Then, [LP17b, Corollary 4.2.2] shows:

- In the case of a ring of curves, the subcategory  $D^\pi\mathcal{F}(\Sigma) \subseteq D^b\mathcal{W}(\Sigma; \Lambda)$  coincides with  $\mathcal{T}^\perp = {}^\perp \mathcal{T}$ , where  $\mathcal{T}$  is the category generated by the objects

$$E_{i,j}^{\pm}.$$

- In the case of a chain of curves with  $r_{1,-}, r_{n,+} > 0$ , the subcategory  $D^{\pi}\mathcal{F}(\Sigma; (r_{1,-})^{d_1}, (0)^{b-d_1-d_n}, (r_{n,+})^{d_n}) \subseteq D^b\mathcal{W}(\Sigma; \Lambda)$  coincides with  $\mathcal{T}^{\perp} = {}^{\perp}\mathcal{T}$ , where  $\mathcal{T}$  is the category generated by  $E_{i,j}^+$  for  $i \in \{1, \dots, n-1\}$  and  $E_{i,j}^-$  for  $i \in \{2, \dots, n\}$ .

*Proof of Theorem 5.1.3.* In the case of a ring of curves, or a chain where  $r_{1,-}, r_{n,+} > 0$ , the theorem follows from the observation that the generating objects of the category  $\mathcal{T}$  on both sides of the correspondence are identified under the equivalence given in Theorem 5.1.1. In the case where  $r_{n,+} > r_{1,-} = 0$  we again consider  $\bar{\mathcal{C}}$  such that  $\mathcal{C} = \bar{\mathcal{C}} \setminus \{q_{1,-}\}$ . Then, the statement follows from using the characterisation of  $\text{perf}\mathcal{C} \subseteq D^b(\mathcal{A}_{\bar{\mathcal{C}}} - \text{mod}) \simeq D^b\mathcal{W}(\Sigma; \bar{\Lambda})$  as the category which is both left and right perpendicular to  $\bar{\mathcal{T}}$ .  $\square$

## 5.7 Applications

Before demonstrating our main application of invertible polynomials, we first consider an example which does not arise in this context.

**Example 5.7.1.** *For an example outside of the framework of invertible polynomials, consider a ring of curves with two irreducible components given by*

$$\begin{aligned} \mathcal{C}_1 &= \sqrt[4]{\mathcal{O}(q_{1,-} + 2q_{1,+})/\mathbb{P}_{2,4}} \\ \mathcal{C}_2 &= \sqrt[2]{\mathcal{O}(q_{2,+})/\mathbb{P}_{8,4}}, \end{aligned}$$

where the presentation at  $q_i \in |\mathcal{C}_1| \cap |\mathcal{C}_2|$  for  $i = 1, 2$  is given by the action of  $H_1 = \mu_2 \times \mu_8$

$$(\zeta^i, \eta^j) \cdot (x, y) = (\zeta^i \eta^{2j} x, \eta^j y)$$

at  $q_1$ , and the action of  $H_2 = \mu_8$  on the node  $q_2$  is given by

$$t \cdot (x, y) = (t^2 x, t^4 y),$$



where the  $x$  coordinate is on  $\mathcal{C}_2$  here. Letting  $\mathcal{U}_{1,\pm} = \mathbb{P}_{2,4} \setminus \{q_{1,\mp}\}$ , we have that the isotropy group of the node  $q_{1,+}$  is determined by the class in  $\mathbf{H}^2(\mathcal{U}_{1,+}, \mu_4)$  given by the restriction  $\mathcal{O}(q_{1,-} + 2q_{1,+})|_{\mathcal{U}_{1,+}}$ . This yields the short exact sequence

$$1 \mapsto \mu_4 \xrightarrow{\varphi_{1,+}} \mu_2 \times \mu_8 \xrightarrow{\psi_{1,+}} \mu_4 \rightarrow 1,$$

where  $\varphi_{1,+}$  is the map  $\lambda \mapsto (\zeta^{-1}, \eta^2)$ , and  $\psi_{1,+}$  is given by the map  $(\zeta^i, \eta^j) \mapsto \zeta^i \eta^{2j}$ . The short exact sequence characterising the isotropy group of the gerbe at  $q_{2,-}$  is split, and so we have  $\chi_{r_{2,-}} = (0, 1) \in \mathbb{Z}_2 \oplus \mathbb{Z}_8 = \widehat{H}_1$ , and take  $\chi_{d_{2,-}} = (1, 0) \in \widehat{H}_1$ . Since  $\chi_{r_{1,+}} = (1, 2)$ , we that the weight of  $H_1$  on the fibre of  $\mathcal{O}_{\widetilde{\mathcal{C}}_1}(q_{1,-} + 2q_{1,+})$  at  $q_{1,+}$  is  $(0, -4) \in \widehat{H}_1$ , and we take  $\chi_{d_{1,+}} = (0, -1) \in \widehat{H}_1$ .

At the node  $q_2$ , the isotropy group at  $q_{1,-}$  is determined by the class of  $\mathcal{O}(q_{1,-} + 2q_{1,+})|_{\mathcal{U}_{1,-}}$  in  $\mathbf{H}^2(\mathcal{U}_{1,-}, \mu_4)$ , yielding the non-split exact sequence

$$1 \rightarrow \mu_4 \rightarrow \mu_8 \xrightarrow{\wedge^4} \mu_2 \rightarrow 1,$$

where the first map is the inclusion. The short exact sequence corresponding to the gerbe structure at  $q_{2,+}$  is given by

$$1 \mapsto \mu_2 \rightarrow \mu_8 \xrightarrow{\wedge^2} \mu_4 \rightarrow 1.$$

At the node  $q_2$  we have  $\chi_{r_{2,+}} = 2 \in \mathbb{Z}_8 = \widehat{H}_2$ ,  $\chi_{r_{1,-}} = 4$ , and take  $\chi_{d_{1,-}} = \chi_{d_{2,+}} = -1$ . In order to compute the endomorphism algebra of the exceptional collection given in Section 5.3, we order the characters of  $H_1$  such that  $\chi_{4k_{1,+} + c_{1,+}}$  is the character  $k_{1,+} \chi_{d_{1,+}} - c_{1,+} \chi_{r_{1,+}}$ . Similarly, we order the characters of  $H_2$  such that  $\chi_{4k_{2,+} + c_{2,+}}$  is the character  $k_{2,+} \chi_{d_{2,+}} - c_{2,+} \chi_{r_{2,+}}$ .

To calculate the endomorphism algebra of the exceptional collection given in

Section 5.3, fix  $j_i = 0$  and  $m_i = -1$  for  $i = 0, 1$ . Then, there are morphisms

$$\begin{aligned} \text{Ext}^1(\mathcal{S}_{q_1}\{\chi_{4k_{1,+}+c_{1,+}}\}, \mathcal{P}_1(0, c_{1,+} - 1, k_{1,+})) &= \mathbb{C} \cdot a_1(c_{1,+}, k_{1,+}), \\ \text{Ext}^1(\mathcal{S}_{q_1}\{\chi_{4k_{1,+}+c_{1,+}}\}, \mathcal{P}_2((7 + k_{1,+} + 2c_{1,+}), -1, c_{1,+})) &= \mathbb{C} \cdot b_1(c_{2,-}, k_{2,-}). \end{aligned}$$

At the node  $q_2$ , we have morphisms

$$\begin{aligned} \text{Ext}^1(\mathcal{S}_{q_2}\{\chi_{4k_{2,+}+c_{2,+}}\}, \mathcal{P}_2(0, c_{2,+} - 1, k_{2,-})) &= \mathbb{C} \cdot a_2(c_{2,+}, k_{2,+}), \\ \text{Ext}^1(\mathcal{S}_{q_2}\{\chi_k\}, \mathcal{P}_1((2 + \lfloor \frac{2c_{2,+} + k_{2,+}}{4} \rfloor), -1, (2c_{2,+} + k_{2,+}))) &= \mathbb{C} \cdot b_2(c_{1,-}, k_{1,-}). \end{aligned}$$

Based on this, we can construct the mirror by gluing together  $A(2, 4; 4)$  to  $A(8, 4; 2)$  via the permutations

$$\begin{aligned} \sigma_1(4k_{1,+} + c_{1,+}) &= 8(c_{1,+} \bmod 2) + (-k_{1,+} - 2c_{1,+}) \bmod 8 \\ \sigma_2(4k_{2,+} + c_{2,+}) &= 2(2c_{2,+} + k_{2,+} \bmod 4) + (-\lfloor \frac{2c_{2,+} + k_{2,+}}{4} \rfloor) \bmod 2. \end{aligned}$$

The cycle decompositions of determining the boundary components and their winding numbers are

$$\begin{aligned} \sigma_1^{-1} \tau_{\ell_2} \sigma_1 \tau_{r_1} &= (0 \ 13 \ 8 \ 7 \ 2 \ 15 \ 10 \ 5)(1 \ 14 \ 9 \ 4 \ 3 \ 12 \ 11 \ 6) \\ \sigma_2^{-1} \tau_{\ell_1} \sigma_2 \tau_{r_2} &= (0 \ 1 \ 2 \ 3)(4 \ 5 \ 6 \ 7), \end{aligned}$$

yielding two boundary components with winding number  $-16$ , and two with winding number  $-8$ . The Euler characteristic is  $-24$ , and so the genus of the surface is 9.

Putting this all together, Theorem 5.1.1 yields

$$D^b(\mathcal{A}_{\mathcal{C}} - \text{mod}) \simeq D^b\mathcal{W}(\Sigma_{9,4}; (8)^2, (16)^2).$$

Theorem 5.1.3 yields

$$\begin{aligned} \text{perf } \mathcal{C} &\simeq D^\pi \mathcal{F}(\Sigma_{9,4}) \\ D^b \text{Coh}(\mathcal{C}) &\simeq D^\pi \mathcal{W}(\Sigma_{9,4}). \end{aligned}$$

This surface does not arise as the Milnor fibre of an invertible polynomial; however, it is interesting to observe that it is graded symplectomorphic to a surface considered in [LP20]. Specifically, it is shown that the surface obtained by gluing  $A(8, 16; 1)$  to  $A(16, 8; 1)$  by the permutations  $\sigma_0(x) = -x \bmod 16$  and  $\sigma_1(x) = -x \bmod 8$  is mirror to the ring of orbifolds whose irreducible components are given by  $\mathbb{P}_{8,16}$  and  $\mathbb{P}_{16,8}$ , where the structure of the node is given by the action of  $G$  on  $xy = 0$  by  $t \cdot (x, y) = (tx, ty)$  for  $G = \mu_8$  or  $\mu_{16}$ . This curve is denoted by  $C(8, 16; 1, 1) = \mathcal{C}_{orb}$ , and [LP17b, Theorem A] establishes the existence of a surface  $\Sigma$  such that

$$D^b(\mathcal{A}_{\mathcal{C}_{orb}} - \text{mod}) \simeq D^b \mathcal{W}(\Sigma; (8)^2, (16)^2),$$

and [LP17b, Theorem B] yields

$$\begin{aligned} \text{perf } \mathcal{C}_{orb} &\simeq D^\pi \mathcal{F}(\Sigma), \\ D^b \text{Coh}(\mathcal{C}_{orb}) &\simeq D^\pi \mathcal{W}(\Sigma). \end{aligned}$$

In this case, we can deduce that the surfaces  $\Sigma_{9,4}$  and  $\Sigma$  are graded symplectomorphic by Lemma 4.3.3 (the Arf invariant doesn't need to be checked in this case). Therefore, there are derived equivalences

$$\begin{aligned} D^b(\mathcal{A}_{\mathcal{C}_{orb}} - \text{mod}) &\simeq D^b(\mathcal{A}_{\mathcal{C}} - \text{mod}), \\ D^b \text{Coh}(\mathcal{C}_{orb}) &\simeq D^b \text{Coh}(\mathcal{C}). \end{aligned}$$

### 5.7.1 Invertible polynomials

In this section, we establish Theorem 5.1.4 by firstly applying Theorems 5.1.1 and 5.1.3 to the curves appearing as the B-model of invertible polynomials in two

variables. We then show that the surfaces constructed are graded symplectomorphic to  $\check{V}/\check{\Gamma}$ .

As in Chapter 2, consider an admissible subgroup  $\Gamma \subseteq \Gamma_{\mathbf{w}}$ . The group  $\check{\Gamma}$  acts naturally on  $\mathbb{A}^2$  through its inclusion in  $\ker \chi_{\check{\mathbf{w}}}$ , and in each case,  $\check{\Gamma} = \mu_\ell$  acts on  $\mathbb{A}^2$  by

$$\xi \cdot (x, y) = (\xi x, \xi^{-1} y). \tag{5.27}$$

This can be checked directly, or deduced from the fact that  $\check{\Gamma}$  is a diagonal matrix in  $\mathrm{SL}_2(\mathbb{C})$ , and so its two entries must be inverses of each other. Clearly, the only fixed point of this action is the origin, which is not a point in the Milnor fibre, and so the quotient of the Milnor fibre by  $\check{\Gamma}$  is again a manifold.

### 5.7.1.1 Loop polynomials

For a loop polynomial  $\mathbf{w} = x^p y + y^q x$ , where we take  $p \geq q$ , we consider  $\mathbf{W} = x^p y + y^q x + xyz$  with admissible grading group  $\Gamma \subseteq \Gamma_{\mathbf{w}}$  of index  $\ell = [\Gamma_{\mathbf{w}} : \Gamma]$ , and the corresponding stack

$$Z_{\mathbf{w}_{\mathrm{loop}}, \Gamma} := [(\mathbf{W}^{-1}(0) \setminus (\mathbf{0})) / \Gamma],$$

where we take the action of  $\Gamma$  to be given by its inclusion to  $\Gamma_{\mathbf{w}}$ . We identify  $\Gamma \simeq \mathbb{C}^* \times \mu_{\frac{d}{\ell}}$ , where  $d = \mathrm{gcd}(p-1, q-1)$ . The stack  $Z_{\mathbf{w}_{\mathrm{loop}}, \Gamma}$  has a natural interpretation as a codimension one closed substack in the toric DM orbifold  $[(\mathbb{A}^3 \setminus (\mathbf{0})) / \Gamma]$ . The unique stacky fan describing this DM orbifold is readily checked to be given by the data of

$$\beta : \mathbb{Z}^3 \xrightarrow{\begin{pmatrix} \frac{p-1}{\ell} & \frac{1-q}{\ell} & 0 \\ 0 & q-1 & -1 \end{pmatrix}} \mathbb{Z}^2 =: N,$$

and each column corresponds to a ray of the fan  $\Sigma$ . The maximal cones of the fan are given by the span of any two rays. In general, this is a quotient of weighted

projective space by  $\mu_{\frac{d}{\ell}}$ .

**Remark 5.7.2.** *It is worth noting that we have made a choice in the identification  $\Gamma \simeq \mathbb{C}^* \times \mu_{\frac{d}{\ell}}$ , and thus how  $\Gamma$  acts on  $\mathbb{A}^3 \setminus (\mathbf{0})$ ; however, the above fan is independent of this choice. Choosing a different identification of  $\Gamma$  corresponds to choosing different change-of-basis matrices in the Smith normal form decomposition of  $[BQ]^\vee$  used to calculate its cokernel.*

With this description, one can see that  $\mathcal{C}_1 = \{y = 0\} \subseteq Z_{\mathbf{w}_{\text{loop}}, \Gamma}$  is the closed substack of  $[(\mathbb{A}^3 \setminus (\mathbf{0})) / \Gamma]$  corresponding to the ray  $\rho_2 = \frac{1-q}{\ell}e_1 + (q-1)e_2$ , and similarly that  $\mathcal{C}_3 = \{x = 0\}$  is the closed substack corresponding to the ray  $\rho_1 = \frac{p-1}{\ell}e_1$ . The quotient fan  $\Sigma / \rho_2$  is given by the complete fan in  $\mathbb{Q}$ , and

$$\beta(\rho_2) : \mathbb{Z}^2 \xrightarrow{\begin{pmatrix} p-1 & -1 \\ \frac{1-p}{\ell} & 0 \end{pmatrix}} \mathbb{Z} \oplus \mathbb{Z}_{\frac{q-1}{\ell}} =: N(\rho_2)$$

This is a  $\mu_{\frac{q-1}{\ell}}$ -gerbe over  $\mathbb{P}_{p-1,1}$ , and [FMN10, Theorem 7.24] establishes that there is an isomorphism of toric DM stacks

$$\mathcal{C}_1 \simeq \sqrt[\frac{q-1}{\ell}]{\mathcal{O}(-\frac{p-1}{\ell}q_{1,-}) / \mathbb{P}_{p-1,1}}.$$

Similarly, we have an isomorphism of toric DM stacks

$$\mathcal{C}_3 \simeq \sqrt[\frac{p-1}{\ell}]{\mathcal{O}(\frac{q-1}{\ell}q_{3,+}) / \mathbb{P}_{1,q-1}}.$$

The curve  $\mathcal{C}_2$  is always an orbifold, and can be identified with  $\mathcal{C}_2 \simeq \mathbb{P}_{\frac{q-1}{\ell}, \frac{p-1}{\ell}}$ .

**Remark 5.7.3.** *It is worth reiterating that we are not claiming that the gerbe structure of  $\mathcal{C}_1$  and  $\mathcal{C}_3$  are given as above, only that there is an isomorphism of DM stacks. Due to this, there is some freedom in the identifications, and we have chosen these for later convenience.*

The majority of the analysis in studying the modules over the Auslander sheaf is at  $q_3 = |\mathcal{C}_3| \cap |\mathcal{C}_1|$ , which corresponds to the point  $[0 : 0 : 1] \in |\mathcal{X}|$ . This node is

presented as the quotient of  $xy = 0$  by the action of  $\mu_{\frac{(p-1)(q-1)}{d}} \times \mu_{\frac{d}{\ell}}$  given by

$$(t, \xi) \cdot (x, y) = (t^{\frac{p-1}{d}} \xi^{-n} x, t^{\frac{q-1}{d}} \xi^m y),$$

where  $m, n$  are Bézout coefficients solving

$$m(p-1) + n(q-1) = d. \tag{5.28}$$

Therefore the gerbe structure of the point  $q_{3,+}$  is determined by the cohomology class in  $\mathbb{Z}_{\gcd(q-1, \frac{p-1}{\ell})} \simeq \mathbb{H}^2([\mathbb{A}^1/\mu_{q-1}], \mu_{\frac{p-1}{\ell}})$  corresponding to the mod  $\frac{p-1}{\ell}$  reduction of  $\frac{(\ell-1)(q-1)}{\ell} \in \mathbb{Z}$ . Similarly, we have that the gerbe at  $q_{1,-} \in |\mathcal{C}_1|$  is classified by the cohomology class in  $\mathbb{Z}_{\gcd(p-1, \frac{q-1}{\ell})} \simeq \mathbb{H}^2([\mathbb{A}^1/\mu_{p-1}], \mu_{\frac{q-1}{\ell}})$  corresponding to the mod  $\frac{q-1}{\ell}$  reduction of  $\frac{p-1}{\ell} \in \mathbb{Z}$ . The corresponding short exact sequences at  $q_{3,+}$  and  $q_{1,-}$  are

$$1 \rightarrow \mu_{\frac{p-1}{\ell}} \xrightarrow{\varphi_{3,+}} \mu_{\frac{(p-1)(q-1)}{d}} \times \mu_{\frac{d}{\ell}} \xrightarrow{\psi_{3,+}} \mu_{q-1} \rightarrow 1, \text{ and} \tag{5.29}$$

$$1 \rightarrow \mu_{\frac{q-1}{\ell}} \xrightarrow{\varphi_{1,-}} \mu_{\frac{(p-1)(q-1)}{d}} \times \mu_{\frac{d}{\ell}} \xrightarrow{\psi_{1,-}} \mu_{p-1} \rightarrow 1, \tag{5.30}$$

respectively. Here  $\lambda_{\pm}$ ,  $\eta$ , and  $\xi$  are

$$\begin{aligned} \lambda_+ &= e^{2\pi\sqrt{-1}\frac{\ell}{p-1}}, & \lambda_- &= e^{2\pi\sqrt{-1}\frac{\ell}{q-1}}, \\ \eta &= e^{2\pi\sqrt{-1}\frac{d}{(p-1)(q-1)}}, & \xi &= e^{2\pi\sqrt{-1}\frac{\ell}{d}}, \end{aligned}$$

and  $\varphi_{3,+}$  is the map  $\lambda_+ \mapsto (\eta^{-n\frac{(q-1)\ell}{d}}, \xi^{-1})$ ,  $\psi_{3,+}$  is  $(\eta^a, \xi^b) \mapsto \eta^{\frac{p-1}{d}a} \xi^{-nb}$ ,  $\varphi_{1,-}$  is  $\lambda_- \mapsto (\eta^{m\frac{(p-1)\ell}{d}}, \xi^{-1})$ ,  $\psi_{1,-}$  is  $(\eta^a, \xi^b) \mapsto \eta^{\frac{q-1}{d}a} \xi^{mb}$ , where  $m, n$  are again the Bézout coefficients of (5.28).

From this description, we have that the group  $H_3$  acts on the fibre of  $\mathcal{O}_{\tilde{\mathcal{C}}_3}(-q_{3,+})$  at  $q_{3,+}$  with weight  $\chi_{r_{3,+}} = (\frac{p-1}{d}, -n) \in \mathbb{Z}_{\frac{(p-1)(q-1)}{d}} \oplus \mathbb{Z}_{\frac{d}{\ell}} \simeq \widehat{H}_3$  for  $m, n$  solving (5.28), and similarly  $\mathcal{O}_{\tilde{\mathcal{C}}_1}(-q_{1,-})$  at  $q_{1,-}$  is acted on with weight  $\chi_{r_{1,-}} = (\frac{q-1}{d}, m)$ . The character with which  $H_3$  acts on the fibre of  $\mathcal{N}_3$  is (non-uniquely) determined by

the condition that  $\frac{p-1}{\ell}\chi_{d_{3,+}} = \frac{1-q}{\ell}\chi_{r_{3,+}}$ , and maps to a unit in  $\mathbb{Z}_{\frac{p-1}{\ell}}$  under the dual of  $\varphi_{3,+}$ . The natural choice for this is  $\chi_{d_{3,+}} = -\chi_{r_{1,-}}$ , and similarly we choose  $\chi_{d_{1,-}} = \chi_{r_{3,+}}$ .

In  $\widehat{H}_3$ , we label the characters such that  $\chi_{k_+(q-1)+i} = -i\chi_{r_{3,+}} + k_+\chi_{d_{3,+}}$  for  $k_+ \in \{0, \dots, \frac{p-1}{\ell} - 1\}$  and  $i \in \{0, \dots, q-2\}$ . This is the B-side version of labelling the stops on the right side of the left column of cylinders top-to-bottom. With this ordering, the sheaf on  $\widetilde{\mathcal{C}}_1$  whose fibre at  $q_{1,-}$  is acted on by  $H_3$  with character  $\chi_{k_+(q-1)+i}$  is given by

$$\mathcal{O}_{\widetilde{\mathcal{C}}_1}(jq_{1,-}) \otimes \mathcal{N}_1^{\otimes k_-},$$

where  $j \in \{0, \dots, p-2\}$  and  $k_- \in \{0, \dots, \frac{q-1}{\ell} - 1\}$  solves

$$-j\chi_{r_{1,-}} + k_-\chi_{d_{1,-}} = -i\chi_{r_{3,+}} + k_+\chi_{d_{3,+}}. \tag{5.31}$$

A solution to this is readily checked to be given by

$$\begin{aligned} k_- &= -i \bmod \frac{q-1}{\ell} \\ j &= k_+ - \frac{p-1}{\ell} \left\lfloor \frac{-i\ell}{q-1} \right\rfloor \bmod p-1. \end{aligned} \tag{5.32}$$

Fixing  $m_i = -1$  and  $j_i = 0$  as in the proof of Theorem 5.1.1, one computes

$$\begin{aligned} \text{Ext}^1(\mathcal{S}_{q_3}\{-i\chi_{r_{3,+}} + k_+\chi_{d_{3,+}}\}, \mathcal{P}_3(0, (i-1) \bmod q-1, k_+)) &= \mathbb{C} \cdot a(i, k_+), \quad \text{and} \\ \text{Ext}^1(\mathcal{S}_{q_3}\{-i\chi_{r_{3,+}} + k_+\chi_{d_{3,+}}\}, \mathcal{P}_1((j-1) \bmod p-1, -1, k_-)) &= \mathbb{C} \cdot b(j, k_-) \end{aligned}$$

for  $j, k_-$  as in (5.32).

Consider now the nodes  $q_1 = |\mathcal{C}_1| \cap |\mathcal{C}_2|$  and  $q_2 = |\mathcal{C}_2| \cap |\mathcal{C}_3|$ . The structure of these nodes is far more simple, and at  $q_1$  we have the node is presented as the

quotient of  $xy = 0$  by the action of  $\mu_{\frac{q-1}{\ell}}$  given by

$$t \cdot (x, y) = (x, ty),$$

and analogously for  $q_2$ . Therefore, one has  $\widehat{H}_1 \simeq \mathbb{Z}_{\frac{q-1}{\ell}}$  and  $\widehat{H}_2 \simeq \mathbb{Z}_{\frac{p-1}{\ell}}$ , and  $\chi_{r_{2,-}}$  and  $\chi_{r_{2,+}}$  are the identity in  $\mathbb{Z}_{\frac{q-1}{\ell}}$  and  $\mathbb{Z}_{\frac{p-1}{\ell}}$ , respectively. The character with which  $H_1$  acts on the fibre of  $\mathcal{N}_1$  at  $q_{1,+}$  (resp. on  $\mathcal{N}_3$  at  $q_{3,-}$ ) is any unit of  $\widehat{H}_1$  (resp.  $\widehat{H}_2$ ), and so we choose  $\chi_{d_{1,+}}$  to be the identity and  $\chi_{d_{3,-}}$  to be minus the identity in their respective character groups. With this, the morphisms between objects in the exceptional collection supported at  $q_1$  are readily checked to be

$$\begin{aligned} \text{Ext}^1(\mathcal{S}_{q_1}\{c\}, \mathcal{P}_1(0, -1, c)) &= \mathbb{C} \cdot a(0, c) \\ \text{Ext}^1(\mathcal{S}_{q_1}\{c\}, \mathcal{P}_2((-1 - c) \bmod \frac{q-1}{\ell}, -1)) &= \mathbb{C} \cdot b(-c), \end{aligned}$$

and similarly for the morphisms between objects supported at  $q_2$ .

As the mirror to  $\mathcal{C}$ , we take the surface given by gluing  $A(p-1, 1; \frac{q-1}{\ell})$ ,  $A(\frac{q-1}{\ell}, \frac{p-1}{\ell}; 1)$  and  $A(1, q-1; \frac{p-1}{\ell})$  via the permutations  $\sigma_1 = \text{id} \in \mathfrak{S}_{\frac{q-1}{\ell}}$ ,  $\sigma_2 = \text{id} \in \mathfrak{S}_{\frac{p-1}{\ell}}$ , and  $\sigma_3 \in \mathfrak{S}_{\frac{(p-1)(q-1)}{\ell}}$  is given by

$$k_+(q-1) + i \mapsto k_-(p-1) + (-j) \bmod p-1$$

for  $i, j$  solving (5.32). From this, it is clear that one boundary component with winding number  $-2\frac{q-1}{\ell}$  arises from  $\sigma_1$ , and similarly that one boundary component with winding number  $-2\frac{p-1}{\ell}$  arises from  $\sigma_2$ . The number of boundary components, and their winding numbers, arising from  $\sigma_3$  is given by the number of cycles, and their respective lengths, of  $\sigma_3^{-1}\tau_{\ell_1}\sigma_3\tau_{r_3}$ . This permutation is given by

$$\begin{aligned} k_+(q-1) + i \mapsto \\ (q-1) \left( (k_+ - 1) \bmod \frac{p-1}{\ell} \right) + \left( i - 1 + \frac{q-1}{\ell} \left\lfloor \frac{(k_+ - 1)\ell}{p-1} \right\rfloor \right) \bmod q-1 \end{aligned}$$



and so there are  $\gcd(q-1, \frac{p+q-2}{\ell}) = \gcd(p-1, \frac{p+q-2}{\ell})$  cycles, each of length  $\frac{(p-1)(q-1)}{\gcd(\ell(q-1), p+q-2)}$ . Therefore,  $\gcd(q-1, \frac{p+q-2}{\ell})$  boundary components arise from this gluing, and each has winding number  $-2\frac{(p-1)(q-1)}{\gcd(\ell(q-1), p+q-2)}$ .

Putting this all together, we have that the surface constructed, call it  $\Sigma_{\mathbf{w}_{\text{loop}}, \Gamma}$ , has  $2 + \gcd(q-1, \frac{p+q-2}{\ell})$  punctures, and Euler characteristic given by

$$\begin{aligned} -\chi(\Sigma_{\mathbf{w}_{\text{loop}}, \Gamma}) &= \frac{q-1}{\ell} + \frac{p-1}{\ell} + \gcd(q-1, \frac{p+q-2}{\ell}) \frac{(p-1)(q-1)}{\ell \gcd(q-1, \frac{p+q-2}{\ell})} \\ &= \frac{pq-1}{\ell}. \end{aligned}$$

Therefore, the genus is

$$g(\Sigma_{\mathbf{w}_{\text{loop}}, \Gamma}) = \frac{1}{2\ell} (pq - 1 - \gcd(\ell(q-1), p+q-2)).$$

Applying Theorem 5.1.1 yields a quasi-equivalence

$$D^b(\mathcal{A}_{\mathcal{C}} - \text{mod}) \simeq D^b \mathcal{W} \left( \Sigma_{\mathbf{w}_{\text{loop}}, \Gamma}; 2\frac{p-1}{\ell}, \left( 2\frac{(p-1)(q-1)}{\gcd(\ell(q-1), p+q-2)} \right)^b, 2\frac{q-1}{\ell} \right),$$

where  $b = \gcd(q-1, \frac{p+q-2}{\ell})$ , and then Theorem 5.1.3 establishes quasi-equivalences

$$\begin{aligned} D^b \text{Coh}(Z_{\mathbf{w}_{\text{loop}}, \Gamma}) &\simeq D^\pi \mathcal{W}(\Sigma_{\mathbf{w}_{\text{loop}}, \Gamma}) \\ \text{perf} Z_{\mathbf{w}_{\text{loop}}, \Gamma} &\simeq D^\pi \mathcal{F}(\Sigma_{\mathbf{w}_{\text{loop}}, \Gamma}). \end{aligned}$$

In the case of  $\Gamma = \Gamma_{\mathbf{w}}$ , we observe that the graded surface constructed on the A-side is graded symplectomorphic to the Milnor fibre of the transpose invertible polynomial. To see this, we note that the above gluing is the same as the gluing permutation of Section 4.3.2.1, although where the identification of the cylinders in  $A(p-1, 1; \frac{q-1}{\ell})$  here have been rotated  $-\frac{2\pi}{p-1}$  degrees. It was established in loc. cit. that the surface glued in this way is graded symplectomorphic to the Milnor fibre of  $\check{\mathbf{w}}$  by comparing the corresponding ribbon graphs. Building on this strategy, we establish a graded symplectomorphism  $\check{V}/\check{\Gamma} \simeq \Sigma_{\mathbf{w}_{\text{loop}}, \Gamma}$  by first making a topological

identification via the quotient ribbon graphs, and then deducing that the grading structures match by elimination.

Recall the description of  $\check{V}$  as  $\check{\mathbf{w}}_\varepsilon^{-1}(-\delta)$  for  $0 < \delta \ll \varepsilon$  given in Section 3.3, where

$$\check{\mathbf{w}}_\varepsilon = \check{\mathbf{w}} - \varepsilon \check{x}\check{y} = \check{x}\check{y}(\check{x}^{p-1} + \check{y}^{p-1} - \varepsilon) = \check{x}\check{y}\check{w}.$$

Firstly, observe that the Morsification chosen is  $\check{\Gamma}$ -equivariant, and so taking the quotient commutes with Morsifying. Moreover, since the quotient map is an unramified cover and the deformation retract preserves equivalence classes of the quotient map, the deformation retract which takes  $\check{V}$  to its ribbon graph induces a deformation retract of  $\check{V}/\check{\Gamma}$  onto the quotient ribbon graph. With respect to the classification of critical points in Section 3.3.1, we refer to neck regions which form by smoothing critical points of type (i) as neck regions of type (i), and the corresponding node in the ribbon graph as a node of type (i). We refer similarly to neck regions and nodes of type (ii) and (iii). We label the nodes of type (i) and (ii) according to the  $\check{x}$  and  $\check{y}$  argument of the corresponding critical points, respectively. Then, the  $l^{\text{th}}$  node of type (i) is identified with the  $(l + \frac{p-1}{\ell})^{\text{th}}$  node of type (i). Similarly, the  $m^{\text{th}}$  node of type (ii) is identified with the  $(m - \frac{q-1}{\ell})^{\text{th}}$  node of type (ii). This partitions the nodes of the ribbon graph.

To understand how  $\check{\Gamma}$  partitions the edges, recall that part of the basis for the first homology group of  $\check{V}$  is given by the Lagrangians  ${}^l V_{\check{y}\check{w}}$  (resp.  ${}^m V_{\check{x}\check{w}}$  and  $V_{\check{x}\check{y}}$ ), which were defined as the waist curves which form in the  $l^{\text{th}}$  neck region of type (i) (resp. the  $m^{\text{th}}$  neck region of type (ii), and the neck region of type (iii)) upon smoothing. Since Morsification commutes with the action of  $\check{\Gamma}$ , the Lagrangians  ${}^l V_{\check{y}\check{w}}$  and  ${}^{l+\frac{p-1}{\ell}} V_{\check{y}\check{w}}$  become identified in the quotient, and therefore so do the edges of the ribbon graph onto which these Lagrangians deformation retract. The analogous statement for the Lagrangians  ${}^m V_{\check{x}\check{w}}$  is also true, and so we see that two loops of the graph are identified with each other when the corresponding nodes are.

To understand the action of  $\check{\Gamma}$  on the remaining edges, recall that two nodes are connected by an edge if there is a vanishing cycle which passes through both corresponding neck regions. The cyclic ordering of the nodes is determined by the argument of the Lagrangian away from the neck regions which it connects – see, for example, Figure 3.8. From this, it is clear that edges between the node of type (iii) and nodes of type (i) (resp. type (ii)) are identified in the quotient when the corresponding nodes of type (i) (resp. type (ii)) are. All that remains is to understand the action of  $\check{\Gamma}$  on edges which connect the nodes of type (i) and (ii). For this, recall (Section 3.3.5) that the remaining vanishing cycles which form a basis of the first homology of  $\check{V}$  are given by  ${}^{l,m}V_0$  for  $l \in \{0, \dots, p-2\}$ ,  $m \in \{0, \dots, q-2\}$ , and these are the Lagrangians which pass through the  $l^{\text{th}}$  neck region of type (i) and the  $m^{\text{th}}$  neck region of type (ii). By analysing the action of  $\check{\Gamma}$  on the  $\check{x}$  and  $\check{y}$  projections of the Milnor fibre, as given in Section 3.3.3, we see that  ${}^{l,m}V_0$  gets identified with  ${}^{l+\frac{p-1}{\ell}, m-\frac{q-1}{\ell}}V_0$  as it enters the  $\{\check{w} = \varepsilon\}$  component the Milnor fibre. Away from the neck regions which connect it to the  $\{\check{x} = 0\}$  and  $\{\check{y} = 0\}$  components,  $\{\check{w} = \varepsilon\}$  is an unramified cover of  $\{\{u+v = \varepsilon\} \setminus (B_\delta(\varepsilon, 0) \cup B_\delta(0, \varepsilon))\} \subseteq \mathbb{C}^2$ , and so the Lagrangians  ${}^{l,m}V_0$  and  ${}^{l+\frac{p-1}{\ell}, m-\frac{q-1}{\ell}}V_0$  get identified in the component  $\{\check{w} = \varepsilon\}$ . Therefore, the edge of the ribbon graph connecting the  $l^{\text{th}}$  node of type (i) with the  $m^{\text{th}}$  node of type (ii) gets identified with the edge connecting the  $(l + \frac{p-1}{\ell})^{\text{th}}$  node of type (i) with the  $(m - \frac{q-1}{\ell})^{\text{th}}$  node of type (ii) – see Figure 5.6 for an example. Note that this identifies the cyclic ordering of the two nodes in a non-trivial way. Moreover, the pushforward of the basis of the first homology for the ribbon graph of  $\check{V}$  given by the deformation retract of vanishing cycles spans the first homology of the quotient ribbon graph. Therefore, the pushforward of vanishing cycles spans the first homology of  $\check{V}/\check{\Gamma}$ . It should be emphasised, however, that we are making no attempt to precisely describe a basis of Lagrangians on  $\check{V}/\check{\Gamma}$ ; we only claim that the vanishing cycles span the first homology of  $\check{V}/\check{\Gamma}$ . In general, two Lagrangians  ${}^{l,m}V_0$  and  ${}^{l+\frac{p-1}{\ell}, m-\frac{q-1}{\ell}}V_0$  are not isotopic in the quotient, but are related by Dehn twists around the waist curves of the cylinders through which they both pass.

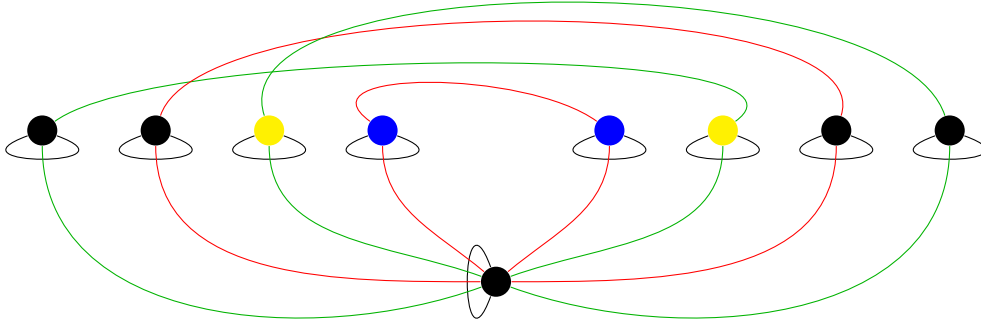

**Figure 5.6:** Part of the ribbon graph corresponding to  $\check{V}$  for  $\check{\mathbf{w}} = \check{x}^5\check{y} + \check{y}^5\check{x}$ . For clarity, we have only drawn the edges which form the cycles onto which the vanishing cycles  $i^{-i}V_0$  for  $i \in \{0, 1, 2, 3\}$  deformation retract. In the quotient of  $\check{V}$  by  $\check{\Gamma} = \mu_2$ , the two red cycles and two green cycles are identified, and the representatives of the nodes are given by the blue and yellow nodes (recall  $\arg \check{x} = -\arg \check{y}$ ), together with the node of type (iii). In the case of  $\check{\Gamma} = \mu_4$ , all coloured cycles are identified, and the blue nodes, as well as the node of type (iii), are taken as the representative in the quotient.

Since the cyclic ordering at nodes is identified in a non-trivial way, one must choose a representative of each equivalence class of nodes to work with a specific ordering. By convention, we will choose the nodes of type (i) corresponding to the neck regions which arise from smoothing the critical points with argument  $\arg \check{x} \in \{0, \frac{2\pi}{p-1}, \dots, \frac{2\pi(p-1-\ell)}{\ell(p-1)}\}$ , and similarly we choose the nodes of type (ii) to correspond to the smoothing of the critical points of type (ii) with  $\arg \check{y} \in \{0, -\frac{2\pi}{q-1}, \dots, -\frac{2\pi(q-1-\ell)}{\ell(q-1)}\}$ . Figures 5.7 and 5.8 show the cases of  $\check{V}/\check{\Gamma}$  for  $\check{V}$  the Milnor fibre of  $\check{x}^5\check{y} + \check{y}^5\check{x}$  and  $\check{\Gamma} = \mu_2, \mu_4$ , respectively. From this, we see that the surface corresponding to this quotient ribbon graph is given by gluing  $A(p-1, 1; \frac{q-1}{\ell})$ ,  $A(\frac{q-1}{\ell}, \frac{p-1}{\ell}; 1)$  and  $A(1, q-1; \frac{p-1}{\ell})$  via the permutations  $\sigma_1 = \text{id} \in \mathfrak{S}_{\frac{q-1}{\ell}}$ ,  $\sigma_2 = \text{id} \in \mathfrak{S}_{\frac{p-1}{\ell}}$ , and  $\sigma_3 \in \mathfrak{S}_{\frac{(p-1)(q-1)}{\ell}}$ , where  $\sigma_3$  is given by

$$k_+(q-1) + i \mapsto ((-i) \bmod \frac{q-1}{\ell})(p-1) + (p-2-k_+ + \frac{p-1}{\ell} \lfloor \frac{-i\ell}{q-1} \rfloor).$$

As in the maximally graded case, this only differs from the gluing given for  $\Sigma_{\mathbf{w}_{\text{loop}}, \Gamma}$  by changing the identification of the cylinders in the column  $A(p-1, 1; \frac{q-1}{\ell})$ .

To identify the line field used to grade  $\check{V}/\check{\Gamma}$ , observe that the pushforward

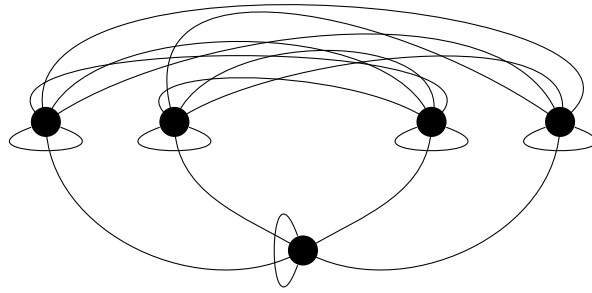

**Figure 5.7:** Ribbon graph corresponding to  $\check{V}/\mu_2$  for  $\check{w} = \check{x}^5\check{y} + \check{y}^5\check{x}$ .

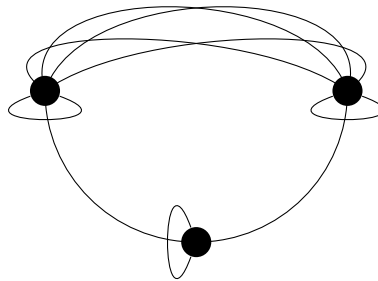

**Figure 5.8:** Ribbon graph corresponding to  $\check{V}/\mu_4$  for  $\check{w} = \check{x}^5\check{y} + \check{y}^5\check{x}$ .

of any vanishing cycle in  $\check{V}$  is gradeable with respect to the line field which is horizontal on cylinders and parallel to the edges of the attaching strips. Indeed, for the waist curves to be gradeable, the only possible line field is the one which is horizontal on cylinders. To see that the pushforward of the Lagrangians  ${}^{l,m}V_0$  are gradeable with respect to the claimed line field, observe that the pushforward of such a Lagrangian deformation retracts onto a cycle of the quotient ribbon graph which passes through three nodes, one each of type (i), (ii), and (iii). Therefore, the pushforward Lagrangian is characterised by which attaching strips it passes through, as well as some number of Dehn twists about the waist curves in the cylinders which the attaching strips connect. For this curve to be gradable, the line field must be (homotopic to) the claimed line field. By the uniqueness (up to homotopy) of the line field with respect to which the pushforward of the vanishing cycles of  $\check{V}$  are all gradeable, the line field on  $\check{V}/\check{\Gamma}$  is homotopic to the line field which is horizontal on

cylinders and parallel to the edges of the attaching strips. This completes the proof of Theorem 5.1.4 in the case of loop polynomials.

### 5.7.1.2 Chain polynomials

For a chain polynomial  $\mathbf{w} = x^p y + y^q$  we consider  $\mathbf{W} = x^p y + y^q + xyz$ , and  $\Gamma \subseteq \Gamma_{\mathbf{w}}$  of index  $\ell$  with identification  $\Gamma \simeq \mathbb{C}^* \times \mu_{\frac{d}{\ell}}$ , where  $d := \gcd(p, q - 1)$ . We define the corresponding stack

$$Z_{\mathbf{w}_{\text{chain}}, \Gamma} := [(\mathbf{W}^{-1}(0) \setminus (\mathbf{0})) / \Gamma],$$

where  $\Gamma$  acts by its inclusion into  $\Gamma_{\mathbf{w}}$ . This stack has two irreducible components – the first is  $\mathcal{C}_2 = \{x^p + y^{q-1} + xz = 0\} \simeq \mathbb{P}_{\frac{(p-1)(q-1)}{\ell}, \frac{q-1}{\ell}}$ , and the second we identify with a  $\mu_{\frac{q-1}{\ell}}$ -gerbe over  $\mathbb{P}_{1, p-1}$  as follows. We identify  $\mathcal{C}_1$  as the closed substack of  $Z_{\mathbf{w}_{\text{chain}}, \Gamma}$  corresponding to the divisor  $\{y = 0\}$ . Analogously to the loop case, we see that the quotient stack  $[(\mathbb{A}^3 \setminus (\mathbf{0})) / \Gamma]$  corresponds to the stacky fan given by the data of a morphism

$$\beta : \mathbb{Z}^3 \xrightarrow{\begin{pmatrix} 1 & 1-q & 1 \\ 0 & \frac{(p-1)(q-1)}{\ell} & -\frac{p}{\ell} \end{pmatrix}} \mathbb{Z}^2 =: N,$$

and the rays of the fan  $\Sigma$  correspond to the column vectors. The maximal cones of the fan are given by the span of any two rays. In general, this is a quotient of weighted projective space by  $\mu_{\frac{d}{\ell}}$ .

With this description, we see that  $\mathcal{C}_1$  is the closed substack corresponding to the ray  $\rho_2 = (1 - q)e_1 + \frac{(p-1)(q-1)}{\ell}e_2$ , and so  $\mathcal{C}_1$  is given by the quotient fan consisting of the complete fan in  $\mathbb{Q}$ ,  $N = \mathbb{Z} \oplus \mathbb{Z}_{\frac{q-1}{\ell}}$ , and

$$\beta : \mathbb{Z}^2 \xrightarrow{\begin{pmatrix} p-1 & -1 \\ -\frac{p}{\ell} & 0 \end{pmatrix}} \mathbb{Z} \oplus \mathbb{Z}_{\frac{q-1}{\ell}}.$$

Again, by [FMN10, Theorem 7.24], we see that there is an equivalence of toric DM stacks

$$\mathcal{C}_1 \simeq \sqrt[q-1]{\mathcal{O}(-\frac{p}{\ell}q_{1,-})/\mathbb{P}_{p-1,1}}.$$

As in the loop case, the computation of the morphisms in the exceptional collection is done locally. To this end, consider a local presentation of the node  $q_2 = |\mathcal{C}_2| \cap |\mathcal{C}_1| = [0 : 0 : 1]$ . This is given by the quotient of  $xy = 0$  by the action of  $\mu_{\frac{(p-1)(q-1)}{\ell}}$  given by

$$t \cdot (x, y) = (tx, t^{q-1}y).$$

This yields  $\chi_{r_{1,-}} = q - 1$  and  $\chi_{r_{2,+}} = 1$ . Therefore, the presentation of the gerbe  $\mathcal{C}_1$  at  $q_{1,-}$  is determined by the class of  $\frac{p}{\ell} \bmod \frac{q-1}{\ell} \in \mathbb{Z}_{\gcd(p-1, \frac{q-1}{\ell})} \simeq H^2([\mathbb{A}^1/\mu_{p-1}], \mu_{\frac{q-1}{\ell}})$ . This gives the short exact sequence

$$1 \rightarrow \mu_{\frac{q-1}{\ell}} \hookrightarrow \mu_{\frac{(p-1)(q-1)}{\ell}} \xrightarrow{\wedge^{q-1}} \mu_{p-1} \rightarrow 1.$$

The action of  $H_2$  on  $\mathcal{N}_1$  at  $q_{1,-}$  is such that  $\frac{q-1}{\ell} \chi_{d_{1,-}} = \frac{p}{\ell} \chi_{r_{1,-}}$  in  $\mathbb{Z}_{\frac{(p-1)(q-1)}{\ell}} = \widehat{H}_2$ , and a natural choice for this character is  $\chi_{d_{1,-}} = 1$ . We order the characters in  $\widehat{H}_2$  such that  $\chi_c = -c$ . With this ordering, the sheaf on  $\widetilde{\mathcal{C}}_1$  whose fibre at  $q_{1,-}$  is acted on by  $H_2$  with character  $\chi_c$  is given by

$$\mathcal{O}_{\widetilde{\mathcal{C}}_1}(jq_{1,-}) \otimes \mathcal{N}_1^{\otimes k_-},$$

where

$$\begin{aligned} k_- &= -c \bmod \frac{q-1}{\ell} \\ j &= -\frac{p}{\ell} \lfloor \frac{-c\ell}{q-1} \rfloor \bmod p-1. \end{aligned} \tag{5.33}$$

From this, one can see that we have the following morphisms in the exceptional

collection:

$$\text{Ext}^1(\mathcal{S}_{q_2}\{\chi_c\}, \mathcal{P}_2(0, c-1)) = \mathbb{C} \cdot a_2(c)$$

$$\text{Ext}^1(\mathcal{S}_{q_2}\{\chi_c\}, \mathcal{P}_1((-1-j) \bmod p-1, -1, k_-)) = \mathbb{C} \cdot b_2(-j, k_-)$$

for  $j, k_-$  as in (5.33).

As in the loop case, the analysis of the node  $q_1 = |\mathcal{C}_1| \cap |\mathcal{C}_2|$  is determined by the choice of  $\chi_{d_{1,-}}$ . In particular, we have  $\widehat{H}_1 = \mathbb{Z}_{\frac{q-1}{\ell}}$ ,  $\chi_{r_{2,-}} = 1$ , and take  $\chi_{d_{1,+}} = -1$ . We again order the elements of  $\widehat{H}_2$  such that  $\chi_c = -c$ , and with this we have the following morphisms in the exceptional collection:

$$\text{Ext}^1(\mathcal{S}_{q_1}\{\chi_c\}, \mathcal{P}_1(0, -1, c)) = \mathbb{C} \cdot a_1(0, c)$$

$$\text{Ext}^1(\mathcal{S}_{q_1}\{\chi_c\}, \mathcal{P}_2((c-1) \bmod \frac{(p-1)(q-1)}{\ell}, -1)) = \mathbb{C} \cdot b_1(c).$$

To construct the mirror to this curve, we glue together two columns,  $A(p-1, 1; \frac{q-1}{\ell})$  and  $A(\frac{q-1}{\ell}, \frac{(p-1)(q-1)}{\ell}; 1)$  via the permutation  $\sigma_1 = \text{id} \in \mathfrak{S}_{\frac{q-1}{\ell}}$  gluing the first column to the second, and the permutation  $\sigma_2 \in \mathfrak{S}_{\frac{(p-1)(q-1)}{\ell}}$  given by

$$c \mapsto k_-(p-1) + (-j) \bmod p-1$$

for  $k_-, j$  as in (5.33) gluing the second column back to the first. From this, it is clear that there is one boundary components arising from the first gluing, and it has winding number  $-2\frac{q-1}{\ell}$ . From the second gluing, we have that  $\sigma_2^{-1}\tau_{\ell_1}\sigma_2\tau_{r_2}$  is given by

$$c \mapsto c - q,$$

and so there are  $\text{gcd}(q, \frac{p+q-1}{\ell})$  boundary components, each with winding number  $-2\frac{(p-1)(q-1)}{\text{gcd}(\ell q, p+q-1)}$ .



Putting this all together, we have constructed a surface, call it  $\Sigma_{\mathbf{w}_{\text{chain}}, \Gamma}$ , which has  $1 + \gcd(q, \frac{p+q-1}{\ell})$  punctures, Euler characteristic

$$-\chi(\Sigma_{\mathbf{w}_{\text{chain}}, \Gamma}) = \frac{p(q-1)}{\ell},$$

and genus

$$g(\Sigma_{\mathbf{w}_{\text{chain}}, \Gamma}) = \frac{1}{2\ell}(pq - p + \ell - \gcd(\ell q, p + q - 1)).$$

Applying Theorem 5.1.1 yields a quasi equivalence

$$D^b(\mathcal{A}_{Z_{\mathbf{w}_{\text{chain}}, \Gamma}} - \text{mod}) \simeq D^b\mathcal{W}\left(\Sigma_{\mathbf{w}_{\text{chain}}, \Gamma}; 2\frac{q-1}{\ell}, \left(2\frac{(p-1)(q-1)}{\gcd(\ell q, p+q-1)}\right)^{\gcd(q, \frac{p+q-1}{\ell})}\right).$$

Applying Theorem 5.1.3 yields

$$\begin{aligned} D^b \text{Coh}(Z_{\mathbf{w}_{\text{chain}}, \Gamma}) &\simeq D^\pi \mathcal{W}(\Sigma_{\mathbf{w}_{\text{chain}}, \Gamma}), \\ \text{perf} Z_{\mathbf{w}_{\text{chain}}, \Gamma} &\simeq D^\pi \mathcal{F}(\Sigma_{\mathbf{w}_{\text{chain}}, \Gamma}). \end{aligned}$$

In the case of maximally graded chain polynomials, observe that the above description differs from that of Section 4.3.2.2 only by a rotation of the identification of the left boundary of the first annulus in the first column. Therefore, the surface constructed in the maximally graded case is graded symplectomorphic to the Milnor fibre of  $\check{\mathbf{w}}$  in the maximally graded case. In the case of  $\ell > 1$ , we follow the same strategy as in Section 5.7.1.1 to deduce that  $\check{V}/\check{\Gamma}$  is graded symplectomorphic to  $\Sigma_{\text{chain}, \Gamma}$ , and this establishes Theorem 5.1.4 in the case of chain polynomials.

### 5.7.1.3 Brieskorn–Pham polynomials

The case of Brieskorn–Pham polynomials is covered in [LP17b], although we include it here for completeness. For each Brieskorn–Pham polynomial  $\mathbf{w} = x^p + y^q$ , we consider  $\mathbf{W} = x^p + y^q + xyz$ , and  $\Gamma \subseteq \Gamma_{\mathbf{w}}$  a subgroup of index  $\ell$  containing the group generated by the grading element with identification  $\Gamma \simeq \mathbb{C}^* \times \mu_{\frac{d}{\ell}}$ . As in the previous

cases, we define

$$Z_{\mathbf{wBP}, \Gamma} = [(\mathbf{W}^{-1}(0) \setminus \mathbf{(0)}) / \Gamma],$$

where  $\Gamma$  acts by its inclusion into  $\Gamma_{\mathbf{w}}$ . This stack has one irreducible component, whose coarse moduli space is a nodal rational curve, and the normalisation is given by  $\tilde{\mathcal{C}} \simeq \mathbb{P}_{\frac{(p-1)(q-1)-1}{\ell}, \frac{(p-1)(q-1)-1}{\ell}}$ . We identify the coordinates in the patch of  $\tilde{\mathcal{C}}$  containing  $q_+ = \infty$  as  $x$ , and in the patch containing  $q_- = 0$  as  $y$ . Therefore, the presentation of  $\mathcal{C}$  around the node  $q$  is given by the quotient of  $xy = 0$  by  $H = \mu_{\frac{(p-1)(q-1)-1}{\ell}}$ , where the action is given by

$$t \cdot (x, y) = (t^{q-1}x, ty).$$

Correspondingly,  $H$  acts on the fibre of  $\mathcal{O}(-q_-)$  at  $q_-$  with weight 1, and with weight  $q - 1$  on the fibre  $\mathcal{O}(-q_+)$  at  $q_+$ .

In  $\widehat{H} = \mathbb{Z}_{\frac{(p-1)(q-1)-1}{\ell}}$ , we label the characters such that  $\chi_c = -c(q - 1)$ . Then, for each  $c \in \mathbb{Z}_{\frac{(p-1)(q-1)-1}{\ell}}$ , we have the following morphisms in the exceptional collection:

$$\text{Ext}^1(\mathcal{S}_q\{\chi_c\}, \mathcal{P}(0, c - 1)) = \mathbb{C} \cdot a(c)$$

$$\text{Ext}^1(\mathcal{S}_q\{\chi_c\}, \mathcal{P}((c(q - 1) - 1) \bmod \frac{(p-1)(q-1)-1}{\ell}, -1)) = \mathbb{C} \cdot b(c(q - 1))$$

Correspondingly, the mirror surface is given by gluing the cylinder

$A(\frac{(p-1)(q-1)-1}{\ell}, \frac{(p-1)(q-1)-1}{\ell}; 1)$  to itself via the permutation  $\sigma \in \mathfrak{S}_{\frac{(p-1)(q-1)-1}{\ell}}$  given by

$$c \mapsto -c(q - 1).$$

The commutator  $[\sigma, \tau] \in \mathfrak{S}_{\frac{(p-1)(q-1)-1}{\ell}}$ , where  $\tau$  is the permutation  $c \mapsto c - 1$ , is given

by

$$c \mapsto c - p.$$

Correspondingly, there are  $\gcd(q, \frac{p+q}{\ell}) = \gcd(p, \frac{p+q}{\ell})$  boundary components, each of winding number  $-2 \frac{(p-1)(q-1)-1}{\gcd(\ell q, p+q)}$ . Therefore, the Euler characteristic is

$$-\chi(\Sigma_{\mathbf{w}_{\text{BP}}, \Gamma}) = \frac{(p-1)(q-1)-1}{\ell},$$

and the genus is

$$g(\Sigma_{\mathbf{w}_{\text{BP}}, \Gamma}) = \frac{1}{2\ell}(2\ell - 1 + (p-1)(q-1) - \gcd(\ell q, p+q)).$$

Applying Theorem 5.1.1 yields

$$D^b(\mathcal{A}_{Z_{\mathbf{w}_{\text{BP}}, \Gamma}} - \text{mod}) \simeq D^b \mathcal{W}(\Sigma_{\mathbf{w}_{\text{BP}}, \Gamma}; \left(2 \frac{(p-1)(q-1)-1}{\gcd(\ell q, p+q)}\right)^{\gcd(q, \frac{p+q}{\ell})}),$$

and applying Theorem 5.1.3 yields

$$\begin{aligned} D^b \text{Coh}(Z_{\mathbf{w}_{\text{BP}}, \Gamma}) &\simeq D^\pi \mathcal{W}(\Sigma_{\mathbf{w}_{\text{BP}}, \Gamma}), \\ \text{perf } Z_{\mathbf{w}_{\text{BP}}, \Gamma} &\simeq D^\pi \mathcal{F}(\Sigma_{\mathbf{w}_{\text{BP}}, \Gamma}). \end{aligned}$$

In the maximally graded case, the description of the mirror surface matches that of Section 4.3.2.3 on-the-nose, and so is graded symplectomorphic to the Milnor fibre of  $\check{\mathfrak{w}}$ . The proof that  $\check{V}/\check{\Gamma}$  is graded symplectomorphic to  $\Sigma_{\text{BP}, \Gamma}$  follows as in the loop and chain cases, and this completes the proof of Theorem 5.1.4.

#### 5.7.1.4 Proof of Corollary 5.1.5

Finally, in this subsection, we provide a proof of Corollary 5.1.5. Such a result was previously obtained by purely algebro-geometric methods in [FK19], although here we deduce it as a consequence of homological mirror symmetry.

*Proof of Corollary 5.1.5.* By observing that the results of Section 4.3.4 show that

the wrapped Fukaya categories of the Milnor fibres of the transpose polynomials are quasi-equivalent, Theorem 5.1.4 establishes that the derived categories of coherent sheaves on their mirrors are, too.  $\square$

# Bibliography

- [AAE<sup>+</sup>13] Mohammed Abouzaid, Denis Auroux, Alexander Efimov, Ludmil Katzarkov, and Dmitri Orlov. Homological mirror symmetry for punctured spheres. *Journal of the American Mathematical Society*, 26:pp. 1051–1083, 10 2013.
- [Abo10] Mohammed Abouzaid. Nearby Lagrangians with vanishing Maslov class are homotopy equivalent. *Inventiones mathematicae*, 189:pp. 251–313, 2010.
- [AGV08] Dan Abramovich, Tom Graber, and Angelo Vistoli. Gromov-Witten theory of Deligne-Mumford stacks. *American Journal of Mathematics*, 130(5):pp. 1337–1398, 10 2008.
- [AIG<sup>+</sup>98] V.I. Arnold, A. Iacob, V.V. Goryunov, O.V. Lyashko, and V.A. Vasil’ev. *Singularity Theory I*. Number v. 1 in Encyclopaedia of mathematical sciences / editor-in-chief, R.V. Gamkrelidze. Springer Berlin Heidelberg, 1998.
- [AKO08] Denis Auroux, Ludmil Katzarkov, and Dmitri Orlov. Mirror symmetry for weighted projective planes and their noncommutative deformations. *Annals of Mathematics*, 167(3):pp. 867–943, May 2008.
- [APS19] Claire Amiot, Pierre-Guy Plamondon, and Sibylle Schroll. A complete derived invariant for gentle algebras via winding numbers and Arf invariants. *Preprint arXiv:1904.02555*, 2019.

- [AS87] Ibrahim Assem and Andrzej Skówronski. Iterated tilted algebras of type  $\tilde{A}_n$ . *Mathematische Zeitschrift*, 195:pp. 269–290, 1987.
- [AS07] Mohammed Abouzaid and Paul Seidel. An open string analogue of Viterbo functoriality. *Geometry & Topology*, 14:pp. 627–718, 2007.
- [Ati71] Michael F. Atiyah. Riemann surfaces and spin structures. *Annales scientifiques de l'École Normale Supérieure*, Ser. 4, 4(1):pp. 47–62, 1971.
- [Aur10] Denis Auroux. Fukaya categories of symmetric products and bordered Heegaard-Floer homology. *Journal of Gökova Geometry Topology GGT*, 4:pp. 1–54, 2010.
- [Aur14] Denis Auroux. A beginners introduction to Fukaya categories. *Bolyai Society Mathematical Studies*, 26:pp. 85–136, 01 2014.
- [BCS03] Lev Borisov, Linda Chen, and Gregory Smith. The orbifold Chow ring of toric Deligne-Mumford stacks. *Journal of the American Mathematical Society*, 18:pp. 193–215, 09 2003.
- [BD09] Igor Burban and Yuri Drozd. Tilting on non-commutative rational projective curves. *Mathematische Annalen*, 351:pp. 665–709, 2009.
- [BD18] Igor Burban and Yuri Drozd. Non-commutative nodal curves and derived tame algebras. *Preprint arXiv: 1805.05174*, 2018.
- [Beh14] Kai Behrend. Introduction to algebraic stacks. Cambridge University Press, 2014.
- [Beĭ78] Alexander Beĭlinson. Coherent sheaves on  $\mathbb{P}^n$  and problems of linear algebra. *Functional Analysis and Its Applications*, 12:pp. 214–216, 1978.
- [BFK11] Matthew Ballard, David Favero, and Ludmil Katzarkov. A category of kernels for equivariant factorizations and its implications for Hodge

- theory. *Publications mathématiques de l'IHÉS*, 120:pp. 1–111, 05 2011.
- [BH93] Per Berglund and Tristan Hübsch. A generalized construction of mirror manifolds. *Nuclear Physics B*, 393(1):pp. 377–391, 1993.
- [BN05] Kai Behrend and Behrang Noohi. Uniformization of Deligne-Mumford curves. *Journal für die reine und angewandte Mathematik (Crelle's Journal)*, 2006:pp. 111–153, 05 2005.
- [Bro88] Allen Broughton. Milnor numbers and the topology of polynomial hypersurfaces. *Inventiones Mathematicae*, 92:pp. 217–241, 1988.
- [Buc86] Ragnar-Olaf Buchweitz. Maximal Cohen–Macaulay modules and Tate-cohomology over Gorenstein rings. Preprint, 1986.
- [Cad07] Charles Cadman. Using stacks to impose tangency conditions on curves. *American Journal of Mathematics*, 129:pp. 405–427, 2007.
- [CCJ20] Cheol-Hyun Cho, Dongwook Choa, and Wonbo Jeong. Fukaya category for Landau-Ginzburg orbifolds and Berglund-Hübsch conjecture for invertible curve singularities. Preprint *arXiv:2010.09198*, 2020.
- [CdIOGP91] Philip Candelas, Xenia de la Ossa, Paul Green, and Linda Parkes. A pair of Calabi-Yau manifolds as an exactly soluble superconformal theory. *Nuclear Physics B*, 359:pp. 21–74, 07 1991.
- [CE03] Diarmuid Crowley and Christine Escher. A classification of  $S^3$ -bundles over  $S^4$ . *Differential Geometry and its Applications*, 18:pp. 363–380, 05 2003.
- [CE12] Kai Cieliebak and Yakov Eliashberg. *From Stein to Weinstein and back: symplectic geometry of affine complex manifolds*. American Mathematical Society colloquium publications. American Mathematical Society, 2012.

- [Cox95] David Cox. The homogeneous coordinate ring of a toric variety. *Journal of Algebraic Geometry*, 4:pp. 17–50, 1995.
- [CT13] Andrei Căldăraru and Junwu Tu. Curved  $A_\infty$ -algebras and Landau-Ginzburg models. *New York Journal of Mathematics*, 19:pp. 305–342, 07 2013.
- [Dyc11] Tobias Dyckerhoff. Compact generators in categories of matrix factorizations. *Duke Mathematical Journal*, 159(2):pp. 223–274, 2011.
- [Ebe16] Wolfgang Ebeling. Homological mirror symmetry for singularities. *Preprint arXiv: 1601.06027*, 2016.
- [EL21] Jonathan David Evans and Yankı Lekili. Symplectic cohomology of compound Du Val singularities. *Preprint arXiv: 2104.11713*, 2021.
- [ET12] Wolfgang Ebeling and Atsushi Takahashi. Mirror symmetry between orbifold curves and cusp singularities with group action. *International Mathematics Research Notices*, 2013(10):pp. 2240–2270, 04 2012.
- [FJR13] Huijun Fan, Tyler Jarvis, and Yongbin Ruan. The Witten equation, mirror symmetry, and quantum singularity theory. *Annals of Mathematics*, 178(1):pp. 1–106, 2013.
- [FK19] David Favero and Tyler L. Kelly. Derived categories of BHK mirrors. *Advances in Mathematics*, 352:pp. 943–980, 2019.
- [FKK20] David Favero, Daniel Kaplan, and Tyler L. Kelly. Exceptional collections for mirrors of invertible polynomials. *Preprint arXiv: 2001.06500*, 2020.
- [FMN10] Barbara Fantechi, Etienne Mann, and Fabio Nironi. Smooth toric Deligne-Mumford stacks. *Journal für die reine und angewandte Mathematik (Crelle's Journal)*, 2010:pp. 201–244, 11 2010.



- [FU09] Masahiro Futaki and Kazushi Ueda. Homological mirror symmetry for Brieskorn–Pham singularities. In *Proceeding of the 56th Japan Geometry Symposium*, pages 98–107. Saga University, 2009.
- [FU11] Masahiro Futaki and Kazushi Ueda. Homological mirror symmetry for Brieskorn-Pham singularities. *Selecta Math. (N.S.)*, 17(2):pp. 435–452, 2011.
- [FU13] Masahiro Futaki and Kazushi Ueda. Homological mirror symmetry for singularities of type D. *Mathematische Zeitschrift*, 273(3-4):pp. 633–652, 2013.
- [Fuk93] Kenji Fukaya. *Morse homotopy,  $A_\infty$ -category, and Floer homologies*. MSRI preprint series: Mathematical Sciences Research Institute. Mathematical Sciences Research Institute, 1993.
- [Gam20] Benjamin Gammage. Mirror symmetry for Berglund-Hübsch Milnor fibers. *Preprint arXiv:2010.15570*, 2020.
- [Gan12] Sheel Ganatra. *Symplectic cohomology and duality for the wrapped Fukaya Category*. 2012. Thesis (Ph.D.)– Massachusetts Institute of Technology.
- [Gan21] Sheel Ganatra. Categorical non-properness in wrapped Floer theory. *Preprint arXiv: 2104.06516*, 2021.
- [Gir71] Jean Giraud. *Cohomologie non-abélienne*. Grundlehren der mathematischen Wissenschaften in Einzeldarstellungen mit besonderer Berücksichtigung der Anwendungsgebiete. Springer-Verlag, 1971.
- [GL87] Werner Geigle and Helmut Lenzing. A class of weighted projective curves arising in representation theory of finite dimensional algebras. *Lecture Notes in Mathematics -Springer-verlag-*, 1273:pp. 265–297, 01 1987.

- [GPS18] Sheel Ganatra, John Pardon, and Vivek Shende. Microlocal Morse theory of wrapped Fukaya categories. *Preprint arXiv: 1809.08807*, 2018.
- [Hab] Matthew Habermann. Homological mirror symmetry for invertible polynomials in two variables. *To appear in Quantum Topology. ArXiv: 2003.01106*.
- [Hab21] Matthew Habermann. Homological mirror symmetry for nodal stacky curves. *Preprint arXiv: 2101.12178*, 2021.
- [HKK14] Fabian Haiden, Ludmil Katzarkov, and Maxim Kontsevich. Flat surfaces and stability structures. *Publications mathématiques de l’IHÉS*, 126:pp. 247–318, 2014.
- [HM06] Friedrich Hirzebruch and Karl Mayer.  *$O(n)$  - Mannigfaltigkeiten, exotische Sphären und Singularitäten*. Lecture Notes in Mathematics. Springer Berlin Heidelberg, 2006.
- [HO18] Yuki Hirano and Genki Ouchi. Derived factorization categories of non-Thom–Sebastiani-type sum of potentials. *Preprint arXiv: 1809.09940*, 2018.
- [Hop83] Heinz Hopf. *Differential geometry in the large*. Lecture notes in Mathematics 1000. Springer Verlag, Berlin, 1983.
- [HR17] Jack Hall and David Rydh. Perfect complexes on algebraic stacks. *Compositio Mathematica*, 153(11):pp. 2318–2367, 2017.
- [HS20] Matthew Habermann and Jack Smith. Homological Berglund-Hübsch mirror symmetry for curve singularities. *Journal of Symplectic Geometry*, 18:pp. 1515–1574, 2020.
- [HV00] Kentaro Hori and Cumrun Vafa. Mirror Symmetry. *Unpublished manuscript arXiv: hep-th/0002222*, 2000.

- [Isi10] Mehmet Isik. Equivalence of the derived category of a variety with a singularity category. *International Mathematics Research Notices*, 2013:pp. 2787–2808, 11 2010.
- [IU15] Akira Ishii and Kazushi Ueda. The special McKay correspondence and exceptional collection. *Tohoku Mathematical Journal*, 67:pp. 585–609, 04 2015.
- [Joh80] Dennis Johnson. Spin structures and quadratic forms on surfaces. *Journal of the London Mathematical Society*, s2-22(2):pp. 365–373, 1980.
- [Kea15] Ailsa Keating. Lagrangian tori in four-dimensional Milnor fibres. *Geometric and Functional Analysis*, 25:pp. 1822–1901, 12 2015.
- [KKOY09] Anton Kapustin, Ludmil Katzarkov, Dmitri Orlov, and Mirroslav Yotov. Homological mirror symmetry for manifolds of general type. *Open Mathematics*, 7(4):pp. 571–605, 2009.
- [KL03] Anton Kapustin and Yi Li. D-branes in Landau-Ginzburg models and algebraic geometry. *Journal of High Energy Physics*, 312(12), 10 2003.
- [KMVdB11] Bernhard Keller, Daniel Murfet, and Michel Van den Bergh. On two examples by Iyama and Yoshino. *Compositio Mathematica*, 147(2):pp. 591–612, 2011.
- [Kon95] Maxim Kontsevich. Homological algebra of mirror symmetry. In S. D. Chatterji, editor, *Proceedings of the International Congress of Mathematicians*, pages pp. 120–139, Basel, 1995. Birkhäuser Basel.
- [Kra10] Marc Krawitz. *FJRW rings and Landau-Ginzburg mirror symmetry*. ProQuest LLC, Ann Arbor, MI, 2010. Thesis (Ph.D.)—University of Michigan.

- [Kra19] Oleksandr Kravets. Categories of singularities of invertible polynomials. *Preprint arXiv: 1911.09859*, 2019.
- [KS92] Maximilian Kreuzer and Harald Skarke. On the classification of quasi-homogeneous functions. *Communications in Mathematical Physics*, 150(1):pp. 137–147, 1992.
- [Li21] Yin Li. Nonexistence of exact Lagrangian tori in affine conic bundles over  $\mathbb{C}^n$ . *Preprint arXiv: 2104.10050*, 2021.
- [LO10] Valery Lunts and Dmitri Orlov. Uniqueness of enhancement for triangulated categories. *Journal of the American Mathematical Society*, 23:pp. 853–908, 07 2010.
- [LP11a] Yankı Lekili and Timothy Perutz. Arithmetic mirror symmetry for the 2-torus. *Preprint arXiv: 1211.4632*, 2011.
- [LP11b] Yankı Lekili and Timothy Perutz. Fukaya categories of the torus and Dehn surgery. *Proceedings of the National Academy of Sciences of the United States of America*, 108:pp. 8106–8113, 05 2011.
- [LP17a] Yankı Lekili and Alexander Polishchuk. Arithmetic mirror symmetry for genus 1 curves with  $n$  marked points. *Selecta Mathematica*, pages pp. 1851–1907, 2017.
- [LP17b] Yankı Lekili and Alexander Polishchuk. Auslander orders over nodal stacky curves and partially wrapped Fukaya categories. *Journal of Topology*, 11:pp. 615–644, 05 2017.
- [LP17c] Yankı Lekili and Alexander Polishchuk. A modular compactification of  $\mathcal{M}_{1,n}$  from  $A_\infty$ -structures. *Journal für die reine und angewandte Mathematik (Crelle's Journal)*, 2019:pp. 151–189, 2017.
- [LP20] Yankı Lekili and Alexander Polishchuk. Derived equivalences of gentle algebras via Fukaya categories. *Mathematische Annalen*, pages pp. 187–255, 01 2020.

- [LU18] Yankı Lekili and Kazushi Ueda. Homological mirror symmetry for Milnor fibers via moduli of  $A_\infty$ -structures. *Preprint arXiv: 1806.04345*, 2018.
- [LU21] Yankı Lekili and Kazushi Ueda. Homological mirror symmetry for milnor fibers of simple singularities. *To appear in Algebraic Geometry. ArXiv: 2004.07374*, 2021.
- [Mil68] John Milnor. *Singular Points of Complex Hypersurfaces. (AM-61)*. Princeton University Press, 1968.
- [Miy91] Junichi Miyachi. Localization of triangulated categories and derived categories. *Journal of Algebra*, 141(2):pp. 463–483, 1991.
- [MS98] Dusa McDuff and Dietmar Salamon. *Introduction to symplectic topology*. Oxford mathematical monographs. Clarendon Press, 1998.
- [NZ06] David Nadler and Eric Zaslow. Constructible sheaves and the Fukaya category. *Journal of the American Mathematical Society*, 22:pp. 233–286, 05 2006.
- [Ols16] Martin Olsson. *Algebraic spaces and stacks*. Colloquium Publications. American Mathematical Society, 2016.
- [OPS18] Sebastian Opper, Pierre-Guy Plamondon, and Sibylle Schroll. A geometric model for the derived category of gentle algebras. *Preprint arXiv:1801.09659*, 2018.
- [Orl09] Dmitri Orlov. Derived categories of coherent sheaves and triangulated categories of singularities. In *Algebra, arithmetic, and geometry: in honor of Yu. I. Manin. Vol. II*, volume 270 of *Progr. Math.*, pages pp. 503–531. Birkhäuser Boston Inc. Boston MA, 2009.
- [Orl11] Dmitri Orlov. Formal completions and idempotent completions of triangulated categories of singularities. *Advances in Mathematics*, 226(1):pp. 206–217, 2011.

- [OS02] Martin Olsson and Jason Starr. Quot functors for Deligne-Mumford stacks. *Communications in Algebra*, 31:pp. 4069–4096, 2002.
- [Pin74] Henry Pinkham. *Deformations of algebraic varieties with  $\mathbb{G}_m$ -action*. Number 20 in Astérisque. Société mathématique de France, 1974.
- [Pol17] Alexander Polishchuk. Moduli of curves as moduli of  $A_\infty$ -structures. *Duke Mathematical Journal*, 166(15):pp. 2871–2924, 10 2017.
- [PV11] Alexander Polishchuk and Arkady Vaintrob. Matrix factorizations and singularity categories for stacks. *Annales de l’Institut Fourier (Grenoble)*, 61(7):pp. 2609–2642, 2011.
- [PV16] Alexander Polishchuk and Arkady Vaintrob. Matrix factorizations and cohomological field theories. *Journal für die reine und angewandte Mathematik (Crelle’s Journal)*, 714:pp. 1–122, 2016.
- [PZ98] Alexander Polishchuk and Eric Zaslow. Categorical mirror symmetry: the elliptic curve. *Advances in Theoretical and Mathematical Physics*, 2:pp. 443–470, 1998.
- [Sch03] Hans Schoutens. Projective dimension and the singular locus. *Communications in Algebra*, 31(1):pp. 217–239, 2003.
- [Sei97] Paul Seidel. *Floer homology and the symplectic isotopy problem*. PhD thesis, St. Hugh’s College, University of Oxford, 1997.
- [Sei00] Paul Seidel. Graded Lagrangian submanifolds. *Bulletin de la Société Mathématique de France*, 128(1):pp. 103–149, 2000.
- [Sei01] Paul Seidel. Vanishing cycles and mutation. In Carles Casacuberta, Rosa Maria Miró-Roig, Joan Verdera, and Sebastià Xambó-Descamps, editors, *European Congress of Mathematics*, volume 202, pages pp. 65–85, Basel, 2001. Birkhäuser Basel.

- [Sei03] Paul Seidel. Homological mirror symmetry for the quartic surface. *Memoirs of the American Mathematical Society*, 236, 10 2003.
- [Sei08a] Paul Seidel. A biased view of symplectic cohomology. *Current Developments in Mathematics*, 2006:pp. 211–253, 2008.
- [Sei08b] Paul Seidel. *Fukaya categories and Picard-Lefschetz theory*. Zurich Lectures in Advanced Mathematics. European Mathematical Society (EMS), Zürich, 2008.
- [Sei11] Paul Seidel. Homological mirror symmetry for the genus two curve. *Journal of Algebraic Geometry*, 20(4):pp. 727–769, 2011.
- [She15] Nicholas Sheridan. Homological mirror symmetry for Calabi-Yau hypersurfaces in projective space. *Inventiones Mathematicae*, 199:pp. 1–186, 2015.
- [Shi12] Ian Shipman. A geometric approach to Orlov’s theorem. *Compositio Mathematica*, 148:pp. 1365–1389, 2012.
- [Smy11] David Smyth. Modular compactifications of the space of pointed elliptic curves I. *Compositio Mathematica*, 147:pp. 877–913, 2011.
- [Syl16] Zachary Sylvan. On partially wrapped Fukaya categories. *Journal of Topology*, 12:pp. 372–441, 2016.
- [T<sup>+</sup>10] Atsushi Takahashi et al. Weighted projective lines associated to regular systems of weights of dual type. In *New Developments in Algebraic Geometry, Integrable Systems and Mirror Symmetry (RIMS, Kyoto, 2008)*. Mathematical Society of Japan, 2010.
- [Ued06] Kazushi Ueda. Homological mirror symmetry and simple elliptic singularities. *Preprint arXiv: math/0604361*, 2006.
- [Ued14] Kazushi Ueda. Hyperplane sections and stable derived categories. *Proceedings of the American Mathematical Society*, 142:pp. 3019–3028, 07 2014.