

CZECH TECHNICAL UNIVERSITY IN PRAGUE
FACULTY OF MECHANICAL ENGINEERING



DIPLOMA THESIS

ACTIVE SPACE DEBRIS REMOVAL SYSTEM

2021

JOSEF POUZAR



ZADÁNÍ DIPLOMOVÉ PRÁCE

I. OSOBNÍ A STUDIJNÍ ÚDAJE

Příjmení: **Pouzar** Jméno: **Josef** Osobní číslo: **465505**
Fakulta/ústav: **Fakulta strojní**
Zadávací katedra/ústav: **Ústav letadlové techniky**
Studijní program: **Letectví a kosmonautika**
Studijní obor: **Letadlová a kosmická technika**

II. ÚDAJE K DIPLOMOVÉ PRÁCI

Název diplomové práce:

Systém aktivního řešení kosmické tříště

Název diplomové práce anglicky:

Active space debris removal system

Pokyny pro vypracování:

Pro vypracování proveďte:

- Popis teoretických základů nebeské mechaniky
- Popis problematiky kosmické tříště
- Rešerši pasivních a aktivních systémů pro redukci kosmického odpadu
- Konstrukční návrh zařízení pro aktivní redukování kosmické tříště
- Vyhodnocení výsledků a možnosti využití zařízení

Seznam doporučené literatury:

Jméno a pracoviště vedoucí(ho) diplomové práce:

Ing. Jaromír Kučera, ústav letadlové techniky FS

Jméno a pracoviště druhé(ho) vedoucí(ho) nebo konzultanta(ky) diplomové práce:

Datum zadání diplomové práce: **30.04.2021**

Termín odevzdání diplomové práce: **08.06.2021**

Platnost zadání diplomové práce: _____

Ing. Jaromír Kučera
podpis vedoucí(ho) práce

Ing. Robert Theiner, Ph.D.
podpis vedoucí(ho) ústavu/katedry

prof. Ing. Michael Valášek, DrSc.
podpis děkana(ky)

III. PŘEVZETÍ ZADÁNÍ

Diplomant bere na vědomí, že je povinen vypracovat diplomovou práci samostatně, bez cizí pomoci, s výjimkou poskytnutých konzultací. Seznam použité literatury, jiných pramenů a jmen konzultantů je třeba uvést v diplomové práci.

Datum převzetí zadání

Podpis studenta

Declaration

I declare that I have prepared this diploma thesis entitled: "Active space debris removal system" completely independently under the professional guidance of Ing. Jaromír Kučera, using literary sources listed at the end of this diploma thesis in the list of used sources.

Date

.....

Bc. Josef Pouzar

Acknowledgment

I would like to express my profound gratitude to Ing. Jaromír Kučera for his professional guidance and valuable advice in space engineering during the elaboration of this diploma thesis. Finally, my deepest gratitude belongs to my girlfriend, family, and friends who have supported me throughout my studies.

Abstract

This diploma thesis focuses on the design of an active space debris removal system. Space debris is a term used in cosmonautics to describe all anthropogenic inactive space objects, fragments, and remnants of everything created by the decay of space technology, which has been launched into orbit by humans. Space debris is characterized by the uncontrolled movement of whole bodies or fragments with high velocities and high kinetic energy. With the development of cosmonautics and its gradual integration into ordinary human life, the increasing amount of space debris poses a serious problem threatening the future of space missions. Thus, humanity is currently facing a potential threat in the form of the prevention of space flights and the use of space technology for many generations.

Keywords

Space debris, Active space debris removal, Kessler syndrome, Satellite technology, Space technology, NX Siemens, ESA DRAMA

Content

List of Nomenclature and Abbreviations.....	8
1 Introduction.....	1
1.1 History of Cosmonautics.....	1
1.2 Space Technology in Human Life.....	1
1.3 Space Technologies.....	2
1.4 Man and The Universe	2
1.5 Aims and Objectives	3
2 Celestial mechanics.....	4
2.1 History.....	4
2.2 Basic Laws of Physics.....	4
2.2.1 Kepler’s Laws of Planetary Motion.....	4
2.2.2 Newton’s Laws of Motion	5
2.2.3 Conservation Law	7
2.2.4 Two-Body Problem.....	7
2.2.5 Restricted Three-Body Problem	9
2.3 Orbit	10
2.3.1 Circular Orbit.....	12
2.3.2 Elliptical Orbit	13
2.3.3 Parabolic and Hyperbolic Orbit	15
2.3.4 Types of Orbits	16
2.4 Aerothermodynamics	18
3 Space Debris	19
3.1 Introduction	19
3.2 The History of Space Debris	19
3.3 Space Debris Classification.....	22

3.4	Detection and Monitoring Systems	25
3.5	Space Debris Dynamics	27
3.5.1	Non-fragmented Source of Space Debris	31
3.6	Space Debris Mitigation.....	33
3.7	Space Debris Creation Avoidance	35
3.7.1	Active Protection	35
3.7.2	Passive protection	36
3.7.2.1	Monolithic shields	36
3.7.2.2	Multilayer Shields	37
3.7.3	Operative protection	37
3.8	Space Debris Elimination.....	38
3.8.1	Space Objects Deorbitation	38
3.8.2	Graveyard Orbit and Systems Passivation.....	39
3.8.3	Active Removal of Space Debris.....	39
3.8.3.1	Orbital Express	40
3.8.3.2	Deutsche Orbitale Servicing Mission.....	41
3.8.3.3	Robotic Refueling Mission.....	41
3.8.3.4	Phoenix Program	42
3.8.3.5	CleanSpace-1	42
3.8.3.6	Electro Dynamic Debris Eliminator	42
3.8.3.7	LEOSWEEP Project.....	43
3.8.3.8	RemoveDEBRIS.....	44
4	Active Space Debris Removal System	45
4.1	Introduction	45
4.2	Principal of Function.....	46
4.2.1	Deceleration and Capture of Space Debris	46
4.2.2	Elimination.....	47

4.2.3	Level of Risk.....	48
4.3	Construction of the Interception Satellite	48
4.4	Shields	50
4.4.1	Geometry	50
4.4.2	Folding Principle.....	52
4.4.3	Front Shield.....	53
4.4.4	Rear Shield.....	55
4.4.5	Shields and Beams Mounting	55
4.4.6	Unfolding Mechanism	56
4.5	Propulsion and Stabilization Subsystems.....	57
4.6	Outer Cover	58
4.7	Energy Subsystem.....	59
4.8	Possible Objectives of the Mission	60
4.8.1	Space Debris Capturing After an Orbital Collision or Explosion Event ..	60
4.8.2	Active Protection of Principal Space Technology	61
4.9	ESA DRAMA Software	61
4.10	Project Evaluation and its Feasibility	62
5	Conclusion	65
	List of Figures	66
	List of Tables	68
	Sources.....	69

List of Nomenclature and Abbreviations

F	[N]	Force
E	[J]	Energy
m, M	[kg]	Mass
v	[m/s]	Velocity
a	[m/s ²]	Acceleration
F_g	[N]	Gravitational force
r, l	[m]	Distance, length
G	[m ³ /kg · s ²]	Gravitational constant
W	[kg]	Weight
g	[m/s ²]	Gravity acceleration
R	[m]	Position vector
h	[kg · m ² /s]	Angular momentum
μ	[m ³ /s ²]	Standard gravitational parameter
θ	[°]	True anomaly
e	[–]	Eccentricity
ε	[J/kg]	Specific energy
a	[m]	Semi-major axis size
c_s	[–]	Calibration parameter
N_f	[–]	Cumulative number of objects
NASA		National Aeronautics and Space Administration
ESA		European Space Agency
LEO		Low Earth Orbit
MEO		Medium Earth Orbit
HEO		Highly Elliptical Orbit

GEO	Geostationary Orbit
SSO	Polar and Sun-Synchronous Orbit
GTO	Geostationary Transfer Orbit
EGO	Extended Geostationary Orbit
NSO	Navigation Satellites Orbit
LMO	LEO-MEO Crossing Orbits
MGO	MEO-GEO Crossing Orbits
ISS	International Space Station
LDEF	Long Duration Exposure Facility
PL	Payload
PF	Payload Fragmentation Debris
PD	Payload Debris
PM	Payload Mission Related Object
RB	Rocket Body
RF	Rocket Fragmentation Debris
RD	Rocket Debris
RM	Rocket Mission Related Object
UI	Unidentified
EUV	Extreme Ultraviolet Radiation
UN COPUOS	United Nations Committee on a Peaceful Uses of Outer Space
IADC	Inter-Agency Space Debris Coordination Committee
ISO	International Organization for Standardization
ECSS	European Cooperation for Space Standardization
DARPA	Defense Advanced Research Projects Agency
MSFC	NASA Marshall Space Flight Center
DEOS	Deutsche Orbitale Servicing Mission
RRM	Robotic Refueling Mission
EDDE	Electro Dynamic Debris Eliminator
IBS	Ion Beam Shepherd

1 Introduction

Space technology is an integral part of modern human life. The field of astronautics is so dynamic that it has only grown in half a century to its current form when we cannot imagine life without it. Space technology, which was developed on Earth and subsequently launched into orbit or beyond, is used by most of the world's population without knowing it.

1.1 History of Cosmonautics

People in the past have accomplished incredible things that have shaped the entire civilization in the form we know it today. Among the historical milestones in human history is the beginning of the space era of mankind. The first artificial satellite in history Sputnik 1, was launched in 1957 from the former Union of Soviet Socialist Republics (USSR) as part of a space race between the USA and the USSR. It was followed by other satellites and probes heading to orbit, to the Moon, and even to other planets, which inevitably led to the sending of the first man into space. In the present day, the process of sending a man into orbit is already a common act, taking place several times a year, and sending a satellite is only a financial question, not a question of possibility. During one man's lifetime, we have managed to turn the mere idea of space flight into a reality in which our orbit is permanently inhabited by humans and satellites used for daily activities. A reality in which several astronauts managed to land on the surface of the Moon and a reality in which we can observe other planets of our solar system in real-time, either from the Earth's surface, satellites orbiting the Earth, or probes placed in their orbits. [1]

1.2 Space Technology in Human Life

Access to space technology, used by ordinary people, companies, or government organizations, changed people's everyday lives. The most common example of space technology used in everyday life is the mobile or internet connection, which is delivered through the network of telecommunication satellites placed on the Earth's orbit. Another example could be weather forecasting, which is used worldwide and is based on the data

collected by meteorological satellites. Even the Automated teller machines (ATM) are controlled by satellites because of the fast communication. One of the most widely used space systems is the Global Positioning System (GPS), which allows accurate location positioning on Earth and is therefore used, for example, by ordinary people or public transport such as airplanes, trains, or ships. In many cases, even the agricultural use the satellites and their data, which consists of information about soil quality, soil composition, or the need for irrigation. The satellites also take care of space exploration and early warnings of impending dangers, such as the dangerous activities of our Sun or asteroids on a collision course with Earth. [1]

1.3 Space Technologies

Space technologies and their development have contributed to most technologies, which are also used on Earth, whether in the form of a fire alarm or a classic zipper. Thus, space technology makes people's lives easier in many ways and protects them from dangers without even knowing it. Only a few other technical fields are as fully dependent on natural laws as the field of the space industry. An object that is launched into space faces extreme conditions in the form of very low pressure called a vacuum, extreme temperatures, radiation, solar wind, and especially of the laws of physics themselves, both Newton's laws of motion and Einstein's theory of relativity.

1.4 Man and The Universe

A universe is an inhospitable place for a man that is incompatible with life. However, people managed to use it to their advantage. During the entire space era of mankind, many objects were launched into orbit around the Earth. Among them were scientific, navigation, meteorological, or telecommunication satellites, but also satellites used for military purposes. Although humanity can do wonderful and noble things, it does not always look at their consequences.

The evolution of human civilization was always connected with the use of the planet Earth resources, where the effort is to replace something wild with something tamed. A parallel with the development of cosmonautics can be seen in the history of man

when mankind was the first to invent agriculture, during which we learned to use the seasons for growing crops. Each subsequent generation was able to achieve some progress only on the basis that it could rely on nature. In other animals, there has always been a need for evolutionary change in physical nature for organisms to be able to do something new. In humans, this need for evolutionary change has been replaced by a mere idea, which they have also been able to pass on to future generations. Currently, half of all fertile land on Earth is agricultural land. Although it was not a direct intention, human influence on Earth has caused unprecedented climate changes, to today's global warming, which results in rising average temperatures, melting permafrost, and releasing large amounts of methane into the atmosphere, further accelerating the planet's warming process. A noble idea now results in a potential threat to life on Earth. This human characteristic has manifested into many scientific, political, and technical fields and unfortunately, also into the field of cosmonautics.

Many satellites, which have been sent into space by humans, are still there and pose a danger in the form of a collision with active satellites and other space technologies. If an orbiting satellite is destroyed due to an explosion or a collision with another body, it will shatter into many pieces with different trajectories and velocities. In such a case, a huge problem arises, as individual fragments can damage other devices and fragment them again into new projectiles. Eventually, everything can result in a chain reaction called Kessler syndrome, which would lead to the impossibility of spaceflight, satellites, or probes usage for many generations.

1.5 Aims and Objectives

This thesis focuses on the space debris problem, its classification, and techniques for its mapping and cataloguing. The output of this thesis is an active technological solution to the problem of space debris elimination. The technological design is based on existing and unrealized projects, while the effort is to create a new concept for solving this problem.

2 Celestial mechanics

2.1 History

In the history of man, the idea of the Earth and the space around it has changed many times. The first attempts to understand the motions of the Sun, Moon, and even the stars began in ancient Egypt. Over time, theories about the motion of the Earth have emerged, with the first emerging ideas about the immobile Sun and the stars around which the Earth rotates and orbits, or the more popular theories of the fixed Earth as the centre of the universe around which everything revolves. Although humans were trying to understand the principles of celestial motion, they did not have the mathematical and physical basis for their exact determination. At the beginning of the 16th century, astronomer Nicolaus Copernicus came up with an interesting theory about the motion of planets, which was based on the principle of a fixed Sun, as the centre of the universe. However, his theory was considered unacceptable by ecclesiastical authorities for another century, as the Sun would take on the role of the Earth as the most important place in the universe. Although Copernicus's theory was considered nonsensical, it brought significant expansion to the understanding of the universe.

2.2 Basic Laws of Physics

In addition to theories, the expansion of physical and mathematical knowledge was necessary to progress in understanding the functioning of the universe. It was the establishment of the laws of physics that deepened human understanding, through which other theories and hypotheses emerged. In this chapter, will be determined the basic laws of physics concerning motions and celestial mechanics.

2.2.1 Kepler's Laws of Planetary Motion

At the beginning of the 17th century, Johannes Kepler, who was an imperial mathematician and astrologer in Prague, discovered after long calculations three laws concerning the motions of the planets, now known as Kepler's laws:

- 1) Planetary orbits are elliptical with the sun at a focus.
- 2) The radius vector from the sun to a planet sweeps equal areas in equal times.
- 3) The ratio of the squares of the periods of any two planets is equal to the ratio of the cubes of their average distances from the sun.

Depending on the results of observations by astronomer Galileo Galilei, who described the motions of Jupiter's moons, Kepler's heliocentric hypothesis was accepted, but there was still a lack of physical interpretation that would bring some order to the system of understanding planetary motions. Sir Isaac Newton subsequently went down in history for this merit. [2]

2.2.2 Newton's Laws of Motion

In 1687, Sir Isaac Newton published one of the most important publications in the history of science, entitled *Philosophiae Naturalis Principia Mathematica*. This book laid the foundations of classical mechanics, introducing three laws of motion and the law of universal gravitation. The laws of motion given in this publication are considered axioms of classical mechanics, often referred to as Newton's laws of motion [2]:

- 1) **Newton's first law of inertia:** Every object remains at rest or in uniform rectilinear motion unless it is compelled to change that state by forces impressed on it. [2]
- 2) **Newton's second law:** If an external force acts on a body, then the body moves with an acceleration that is directly proportional to the applied force. The mathematical expression of this law is

$$F = \frac{dp}{dt} = \frac{d(mv)}{dt} = m \frac{dv}{dt} = ma \quad (2.2.2.1)$$

, where F is the external force, m is the mass of the body, v is the velocity, t represents time, p is the momentum of the body and a is its acceleration. The applied force is therefore equal to the body's momentum time change. The applied force produces a proportional acceleration. [2]

3) Newton's third law: All forces between two objects exist in equal magnitude and opposite direction. If one body acts on another one with a certain force, then the other acts on the first one with the same magnitude. [2]

Newton's laws of motion are based on the existence of force and mass. The physical quantity of force can be interpreted as a measure of the action of one body on another by close contact. However, it can also be defined as the result of the field interaction at greater distances (e.g., electric, electromagnetic, or gravitational fields). Mass is a physical quantity whose state is associated only with the amount of mass of a given body and is very closely related to the inertia of the body, which can be interpreted as a state in which the body resists any change. The more matter the body has the more it resists changing its state, and the greater its inertia force. According to those findings and the introduction of Newton's second law, a fundamental physical equation describing the universal gravitational force was introduced. This equation is often called Newton's law of universal gravitation [3]:

$$F_g = G \frac{m_1 m_2}{r^2} \quad (2.2.2.2)$$

, where F_g is the gravitational force acting between two objects, which masses are m_1 and m_2 and r is a distance between its centers. Finally, a sign G represents the gravitational constant. Two fascinating facts follow from this equation: Firstly, the gravitational force decreases with the square of the distance between two centres of masses. Secondly, if one body is several times more massive than the other one, the force that will act on it will be equal to the body's weight. Thus, a new concept of gravity is introduced, which is dependent on the body's weight and the intensity of the gravitational field [3]:

$$W = G \frac{Mm}{r^2} = m \left(\frac{GM}{r^2} \right) = mg \quad (2.2.2.3)$$

, where W represents the weight of a small object with mass of m . M is the mass of the large central object (e.g., Earth) and g is the gravity acceleration, determined by the universal gravitational constant multiplied by the body's mass and divided by the square distance. In the ideal state, when there are no external disturbing influences and the only force acting on the body is the gravitational force, the body moves in a free fall towards the direction of the source of the gravitational field. This free fall is specified by

an acceleration equal to the gravitational acceleration. The existence of weight is due to the gravitational field. The weight can be interpreted as the body mass if the body is prevented from falling freely by an obstacle. [3]

2.2.3 Conservation Law

In addition to Kepler's and Newton's laws, which are specific applications of reality, it is necessary to introduce more general laws, namely conservation laws. The basis of conservation laws is that in an isolated system, the specific property retains its state and does not change at any time. For the needs of this work and a basic understanding of astrodynamics, the following conservation laws will be settled:

- 1) **Conservation of energy:** The Conservation law of energy is the basic physic law stating that the energy cannot arise or disappear but only transform from one state to another. A special case of this statement is the conservation law of mechanical energy, which states that the absolute mechanical energy of an isolated system is conserved and only converted from potential to kinetic energy and vice versa. [3]
- 2) **Conservation of linear momentum:** In an isolated system of bodies, momentum changes occur only due to their interaction while the absolute momentum of the system does not change and is given by the sum of all momentums of individual bodies. [3]
- 3) **Conservation of angular momentum:** In an isolated system in which the sum of all external forces is zero, the total angular momentum does not change over time. [3]

2.2.4 Two-Body Problem

The laws outlined in the preceding chapters can be applied to a system of two interacting bodies. It is an interpretation task of these laws, called the Kepler problem, or the Two-body problem. The goal of this task is to predict the motion of two massive bodies, their velocities, and trajectories changes. So let us have two massive objects, the first with a much larger mass m_1 and the second with a small mass m_2 . It follows from

Newton's law of gravitation that these two points interact with gravitational forces of magnitude F_{12} and F_{21} , while they are distanced apart by the magnitude of r . A new point G is created on the connection between the bodies, which is called the center of mass of the system and around which the bodies orbit. Now it is necessary to introduce a coordinate system in which these two bodies are and against which the following calculations relate. The inertial reference system is used, which is shown in Figure 1. The links between the coordinate system origin and the mass points are represented by position or radius vectors. The position vector of the first body is R_1 of the second body is R_2 and the position vector of the mass centre of the system is R_G . [2] [3] [5]

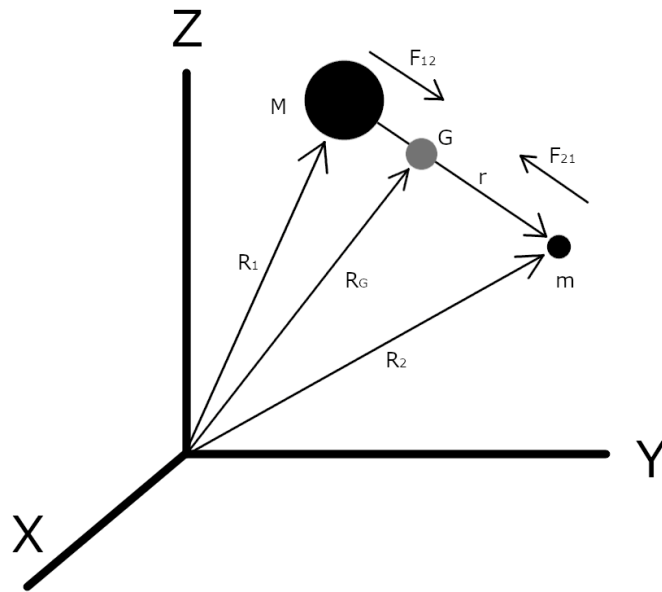

Figure 1: Two-body problem in an inertial frame of reference [3]

To describe the motion of the system centre of mass, we use the relations to calculate the position vector and determine the velocity v_G and acceleration a_G using its second derivative:

$$R_G = \frac{R_1 M + R_2 m}{m_1 + m_2} \quad (2.2.4.1)$$

$$a_G = \dot{v}_G = \ddot{R}_G = \frac{\ddot{R}_1 M + \ddot{R}_2 m}{m_1 + m_2} \quad (2.2.4.2)$$

The absolute acceleration of the centre of mass can be calculated using the equation (2.2.4.2). The individual quantities are measured to the beginning of the inertial system.

The following equations could be used to determine the gravitational forces of bodies reacting to each other:

$$F_{12} = -F_{21} \quad (2.2.4.3)$$

$$F_{12} = G \frac{m_1 m_2 (R_2 - R_1)}{r^2} = m_1 \ddot{R}_1 \quad (2.2.4.4)$$

$$F_{21} = G \frac{m_1 m_2 (R_1 - R_2)}{r^2} = m_2 \ddot{R}_2 \quad (2.2.4.5)$$

From the results of this Two-body problem, it is possible to calculate trajectories, velocities, and accelerations of mass points in time. The absolute scale solution is used for solving the motion of the whole system. The relative scale is used for solving the mutual motion of two bodies relative to the system centre of mass. It can also be deduced that if one of the bodies is many times heavier than the other one (e.g., Earth and satellites), then the system centre of mass is identical with the heavier body centre of mass. From this statement follows that the lighter body will orbit the heavier one and will thus be in a state of constant free fall. [3]

2.2.5 Restricted Three-Body Problem

The two-body problem is only an idealized state, which never occurs. The real problem is much more complex. It is because of the existence of external influences of other celestial bodies and other external perturbations. This part, therefore, deals with the restricted three-body problem, which is an attempt to describe the dependences of several interacting mass points.

The restricted three-body problem assumes the presence of three bodies, with one of them having a negligible mass compared to the other ones. This problem can be applied to the description of the interaction between the Earth, the Moon, and the satellite. The aim is to solve the motion of the least massive body (in this case a satellite), depending on the gravitational fields of the other bodies. Unfortunately, there is currently no precise mathematical description of this problem, which in all cases, regardless of the number of bodies, could accurately predict the motion of a given body. Although there is no analytical solution, to approximate the motion of the body the numerical solution could

be used to solve the whole problem by dividing it into very small intervals. The evolution of computer technology greatly contributed to this numerical solution of the restricted three-body problem. [3]

By solving the problem of mutual interaction of three bodies, it is possible to determine the position of the so-called libration points, or also Lagrange points. These points represent places in a system of two massive bodies in which gravitational and centrifugal forces are balanced. If a body with a negligible mass, compared to other bodies located in the system, is placed in these points, it does not change its speed or position relative to the system. [3]

2.3 Orbit

In the many-body systems, where the central body is many times heavier than the other ones, the trajectories of smaller bodies are called their orbits. The orbit is thus a curve created by the motion of a body through space in time, moving in the gravitational field of a more massive body. These curves are ideally closed loops, but those orbits tend to be unenclosed due to the perturbations' existence. When considering the ideal state, all orbits are conic sections, which is the basis of I. Kepler's law. From Figure 2, it can be concluded that the shape of the orbit depends mainly on its eccentricity or the deviation magnitude from the perfect circle. [1]

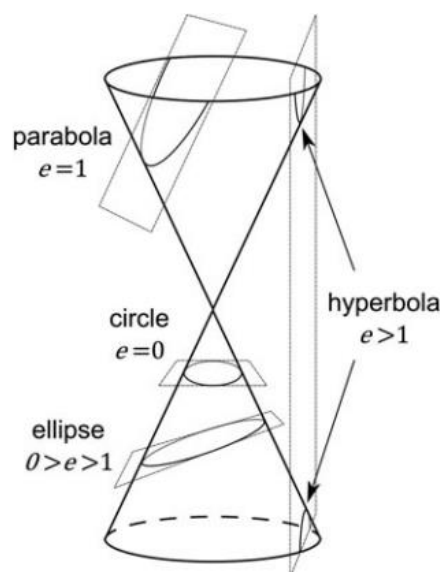

Figure 2: Conic sections depending on their eccentricities [1]

To describe the motion of a body of mass m_2 around a much more massive central body of mass m_1 , i.e., $m_1 \gg m_2$, the following orbit equation was derived:

$$r = \frac{h^2}{\mu} \cdot \frac{1}{1 + e \cdot \cos \theta} \quad (2.3.1)$$

, where r is the distance between two bodies depending on the current position of the body m_2 in orbit, otherwise defined as the radius vector. The current position can be defined by the true anomaly θ i.e., the angle that the radius vector intersects with the vector of eccentricity e . The vector of eccentricity lies on a line passing through both foci and the system centre of gravity. The parameter h represents the angular momentum of the orbiting body and μ is the gravitational parameter related to the central body. [3]

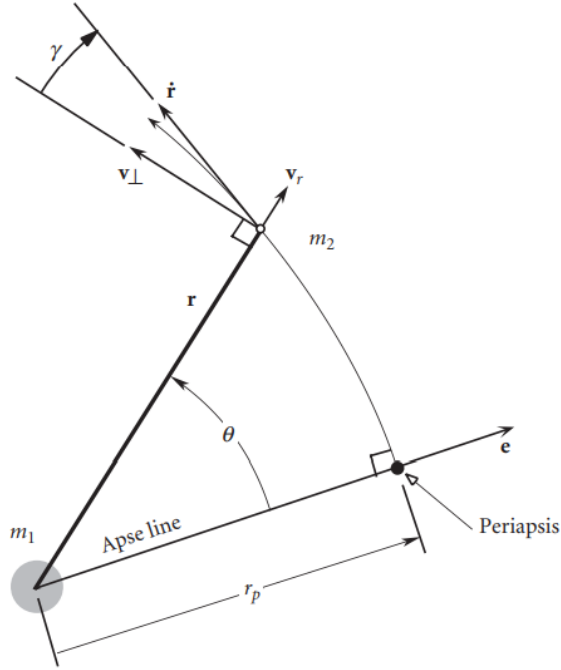

Figure 3: Parameters of the orbit equation [3]

The total specific energy ε of a body in orbit is the result of a combination of kinetic and potential energy. This dependence could be described by the so-called vis-viva equation formulated as

$$\varepsilon = \frac{v^2}{2} - \frac{\mu}{r} \quad (2.3.2)$$

After modifying this equation, the specific energy of the orbit could be expressed by the following relation:

$$\varepsilon = -\frac{1}{2} \cdot \frac{\mu^2}{h^2} \cdot (1 - e^2) \quad (2.3.3)$$

These results, therefore, show that the specific energy of the orbit is directly dependent on its shape, specifically on its eccentricity. The specific energy can be negative, which applies to a circular and elliptical orbit. A zero specific energy refers to a parabolic orbit. Positive specific energy represents a hyperbolic orbit. [3]

2.3.1 Circular Orbit

In the case of a circular orbit, both the focal points and the centre of gravity of the system are one point. In such a case, therefore, there are infinitely many lines intersecting this point, and the eccentricity is therefore zero. When using equation (2.3.1) to describe a circular path, only the relation remains after substitution:

$$r = \frac{h^2}{\mu} \quad (2.3.1.1)$$

, which points to the conclusion that the distance of an object, for example, a satellite orbiting a central body in a circular orbit, depends only on the magnitude of the momentum and the main body's gravitational parameter. In other words, to achieve a greater distance from the central body, the satellite must increase its momentum magnitude since the gravitational parameter is constant. This momentum magnitude of a satellite on a circular orbit can be expressed as

$$h = r \cdot v \quad (2.3.1.2)$$

By substituting the momentum magnitude in the equation (2.3.2), it is possible to express the circular velocity of the satellite or the 1st cosmic velocity as

$$v = \sqrt{\frac{\mu}{r}} \quad (2.3.1.3)$$

Using the above equations, we can also determine the period of the orbit or the time for which the satellite orbits the central body, as the ratio of the circumference of the circle and the circular velocity

$$T = \frac{l}{v} = \frac{2\pi r}{\sqrt{\frac{\mu}{r}}} \quad (2.3.1.4)$$

The energy of the satellite moving around its circular orbit can be extracted from equation (2.3.3) and adjusted to the final equation:

$$\varepsilon = -\frac{1}{2} \cdot \frac{\mu^2}{h^2} = -\frac{\mu}{2r} \quad (2.3.1.5)$$

The total specific energy of the circular orbit is thus constant at all points. It relies on the gravitational parameter of the central body and the distance of the orbiting body. Therefore, the objects orbiting at greater distances around the main body have higher total energy than objects in lower orbits. The results may also be a worrying fact that the resulting total energy is negative. However, it is necessary to emphasize the Conservation law of energy existence, discussed in chapter 2.2.3. The specific energy of the orbit is negative because it is required to accelerate the object to the escape velocity. Once the object achieves escape velocity, it will never come back again. [3] [1]

Getting a satellite into orbit is a challenge that involves specific steps that need to be done. The gravity and the resistance of the atmosphere need to be overcome by creating a large amount of mechanical energy. This energy comes from rocket engines, specifically from rocket propellants. After reaching the orbit, the gravitational acceleration of the central body must be compensated by the centrifugal force which arises during the circular motion. The satellite or the upper stage of the rocket must therefore have some acceleration system in the form of a physical, chemical, or other alternative propulsion, to change its momentum magnitude, and thus its height.

2.3.2 Elliptical Orbit

The probability of the perfectly circular orbit existence is very low. It is due to the presence of disturbing influences acting both on the satellite or the whole system of objects. Interfering effects include gravitational forces of other bodies outside the system, inhomogeneity of the central body, frictional forces due to contact of the orbiting body with the remnants of the atmosphere, solar pressure, magnetic field, and many others. These disturbances can be partially suppressed, such as directional corrections in orbit using propulsion and orientation systems. All objects, therefore, move along elliptical

paths around the central body, while the main parameter of these paths is their eccentricity, which can take values $0 < e < 1$. [1]

The elliptical orbit radius vector is thus variable and directly dependent on the orbit eccentricity and the current position of the body, expressed by the angle of the true anomaly θ . Another significant factor of an elliptical orbit is the variable speed of the moving body, depending on the position relative to the central body. Essential parameters of the elliptical orbit are also its semi-major and semi-minor axes. The orbit apses are points where the orbiting body is either closest (perigee) or furthest (apogee) from the central body. The ratio of the geometric centre distance taken from the orbit foci and the length of the semi-major axis is called the eccentricity. The main body is in one of these foci. [1]

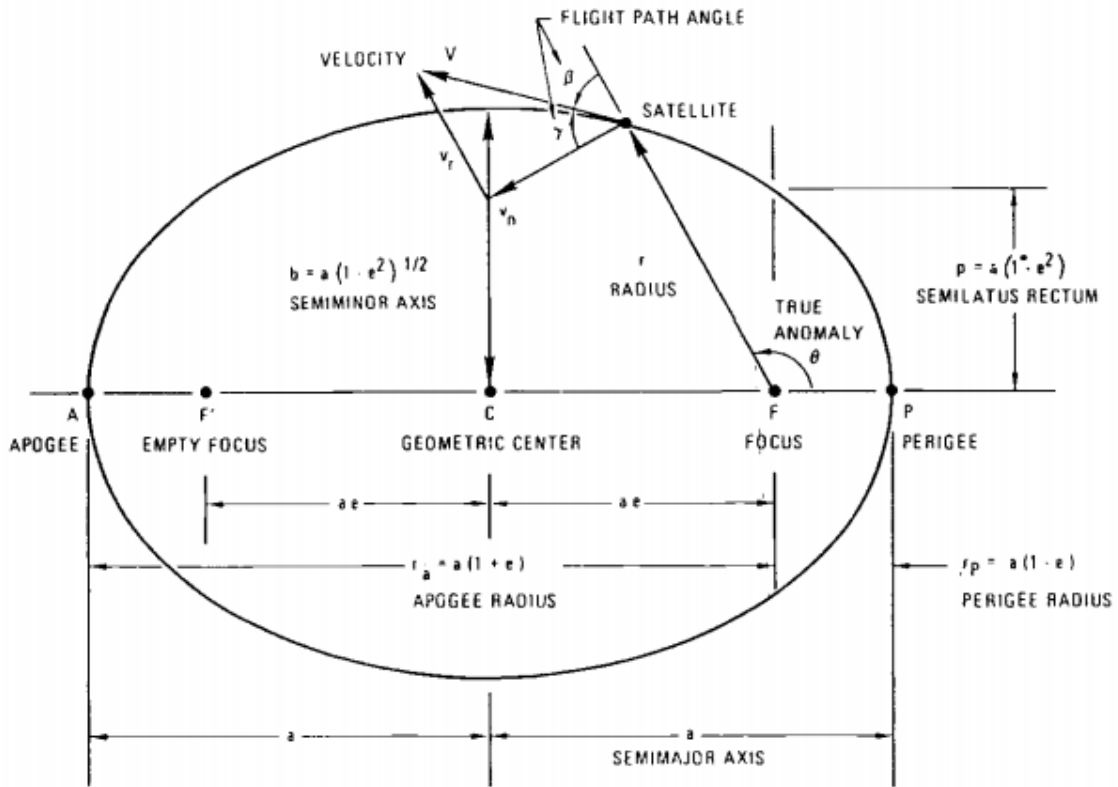

Figure 4: Elliptical orbit geometry [1]

The specific energy of the orbit is also variable and depends on the distance from the central body. It follows from equation (2.3.3) that this energy of an elliptical orbit will always be negative, and its magnitude depends mainly on the eccentricity. With

increasing eccentricity, the specific energy approaches zero. For the elliptical orbit, the equation (2.3.2) can be used and modified as

$$-\frac{\mu}{2a} = \frac{v^2}{2} - \frac{\mu}{r} \quad (2.3.2.1)$$

, where a is the semi-major axis size. When determining the period of an elliptical orbit, it is possible to use calculations valid for a circular orbit. However, the periods of both orbits are equal merely if they have an identical size of the semi-major axis. In the case of an elliptical orbit, the period will therefore be

$$T = \frac{2\pi a}{\sqrt{\frac{\mu}{a}}} \quad (2.3.2.2)$$

The object's speed moving along an elliptical orbit is variable and depends on the distance from the central body. Kinetic and potential energy mutually converse, depending on the current object location. If the object's location is closest to the central body, the kinetic energy reaches its maximum, so it moves faster. Conversely, in the farthest distance of the orbit, the object moves slowest, so the potential energy reaches its maximum. [3] [1]

Elliptical orbits are used specifically by communication, observation, or espionage satellites. They are also used as transfer orbits when there is a need to change a circular orbit radius (e.g., from Low Earth Orbit to Geostationary Orbit). This type of transfer orbit is also called the Hohmann transfer orbit.

2.3.3 Parabolic and Hyperbolic Orbit

If the orbit eccentricity reaches the value $e = 1$, its specific energy will be zero. The orbiting object has enough energy to escape from the central body's gravitational sphere of influence. It then moves along the parabolic orbit, which is no longer closed. From the equation vis-viva (2.3.2), it is possible to determine the object's velocity moving along a parabolic orbit after substituting zero specific energy as

$$v_{esc} = \sqrt{\frac{2\mu}{r}} \quad (2.3.3.1)$$

This escape velocity is also known as the 2nd cosmic velocity. [3]

If the orbit's eccentricity increases further $e > 1$, the orbit changes from parabolic to hyperbolic. The specific energy of the hyperbolic orbit is always positive because of the amount of kinetic energy that keeps the object after escaping from the central body's gravitational sphere of influence. The object's speed is determined by:

$$v_{\infty} = \sqrt{\frac{\mu}{a}} = \frac{\mu}{h} \sqrt{e^2 - 1} \quad (2.3.3.2)$$

2.3.4 Types of Orbits

The choice of the type of orbit depends on satellite design and its mission. The type of orbit depends mainly on the height above the earth's surface and the inclination. The basic types of orbits are:

- **Low Earth Orbit (LEO):** As the name implies, it is an orbit at a close distance from the Earth's surface. Its location is at 160 to 1 000 km above the Earth. It is the most used orbit mainly because it is located near the Earth's surface and has no limit to inclination. The LEO is thus a spherical zone surrounding the Earth. This orbit is home to most observation satellites, telecommunications satellites constellation (Iridium, Starlink, etc.), or the International Space Station (ISS). The speed required to remain in LEO is approximately 7.8 km / s. Although it is the most widely used orbit, the satellites face far greater friction due to the atmosphere residues. The consequence of this phenomenon is a reduced service life of all objects that lose their mechanical energy over time and need to perform a corrective maneuver not to descend to the lower atmosphere. [2] [6]
- **Medium Earth Orbit (MEO):** All the orbits located between the Low Earth Orbit and the Geostationary Orbit region are called Medium Earth Orbits. Its location is at 2 000 to 30 000 km above the Earth's surface. The period of those orbits ranges from 2 to 18 hours. These orbits are most often used by navigation satellites such as GPS, GLONASS, or the European Galileo system. [2] [6]
- **Highly Elliptical Orbit (HEO):** It is an elliptical orbit with great eccentricity. This type of orbit is used mainly due to the long period spent by the satellite in the apogee.

Therefore, it is used to focus on a specific location on Earth. The orbit inclination is 63.435° , which makes it a stable orbit. Highly Elliptical Orbits include the Molniya orbits, named after a Soviet communication satellite with an orbit period of 12 h, or the Tundra orbits with a period of approximately 24 h. These orbits are mostly used by communications satellites. [2]

- **Geostationary Orbit (GEO):** It is a circular orbit located above the Earth's equator, at an altitude of approximately 35 786 km with an orbital period identical to the Earth's rotation, i.e., 23 h 56 min 4 s. The satellites at GEO need to follow the Earth's rotation. Therefore, they need to reach an orbital speed of approximately 3 km/s. The satellites in this orbit have fixed positions in the sky and are often used for communications satellites. The angle of view from the Geostationary orbit covers a third of the entire globe. For worldwide coverage, a constellation of only three satellites would suffice. Geostationary orbit and Low Earth Orbit are both protected regions because of the generation of space debris. [2] [6]
- **Polar and Sun-Synchronous Orbit (SSO):** Polar orbits connect the North and South Poles with inclination deviations of up to 30° from the Earth's rotation axis. Polar orbits are a subcategory of Low Earth Orbits because their altitudes vary from 200 to 1000 km. A subcategory of polar orbits is the Sun-Synchronous or Heliosynchronous orbits. They also connect both polar regions, but they are in a fixed position from the Sun's point of view. As a result, the satellite placed in Sun-Synchronous orbit flies over one location at the same time every day. Those orbits are mainly used for observation of certain regions on Earth and evaluate their evolution over time. Specifically, these are meteorological satellites. [6]
- **Geostationary Transfer Orbit (GTO):** Transfer orbits are an intermediate step for changing between two individual orbiting regions. The first step for transferring a satellite to the geostationary orbit is the acceleration by the launch vehicle. The satellite is placed on an elliptical transfer orbit with an apogee located on the geostationary orbit. After reaching its apogee the satellite performs a comparative maneuver to adjust its orbit from elliptical to circular. This principle is used mainly due to its energy efficiency. [6]

2.4 Aerothermodynamics

The atmosphere is a layer of gases surrounding the Earth or any other planet maintained by its gravitational force. It protects all life on Earth from the cosmic environment and has thermoregulatory properties. The composition of the atmosphere and its physical properties depend on the altitude. The atmosphere consists of layers defined by its temperature, pressure, and composition. The lowest layer of the atmosphere is the Troposphere reaching a height of up to 20 km above the Earth's surface. The next layer is the Stratosphere with an altitude ranging from 20 km to 60 km. Then continues the Mesosphere with a height of about 80 km, followed by the Stratosphere which ranges from 80 km to 640 km. The outer layer is the Exosphere which altitude varies from 640 km to 1 000 km. However, the so-called Kármán line, located at an altitude of 100 km above the Earth's surface, is generally recognized as the boundary between Earth's atmosphere and outer space. [1] [4]

If any object moves through the Earth's atmosphere, a force acting in the opposite direction of the relative motion occurs. This force is called drag or air resistance, and it depends on the object's velocity. If the object moves faster, the drag friction rises, and the object's surface in the direction of movement is thus heated. Aerodynamic heating can be destructive to an object moving at very high speeds, many times higher than the local speed of sound. When any space objects return to the Earth's atmosphere, it moves at hypersonic speed until it is slowed down by the atmosphere's drag. During this process, there is intense friction between the body and the atmosphere, which results in releasing a large amount of thermal energy. The thermal energy heats the surrounding air, which then transfers its heat to the contact surface of the body. If an object moves faster than the local speed of sound a shock wave is created. It is characterized by a nearly discontinuous change in temperature, density, or pressure. As the speed increases, the shock wave expands, and the aerodynamic heating rises. For returning objects, it is advisable to distance the shock wave as much as possible from the contact surfaces, using the blunt shape of the body. Although most of the thermal energy is extended to the surroundings, a considerable part of it goes to the object's surface. Therefore, it must be equipped with a heat shield, for example in the form of an ablative layer. If the returning body is not prepared for this massive heat transfer, it may disintegrate and subsequently evaporate in the atmosphere. [1] [4]

3 Space Debris

3.1 Introduction

Space debris is a term used to describe all anthropogenic inactive space objects, fragments, and remnants of objects created by the decay of space technology, which has been launched into orbit by humans. Space debris is characterized by an uncontrolled movement of whole bodies or fragments with high velocities and kinetic energy. With the evolution of space technology and its gradual integration into everyday life, the increasing amount of space debris poses a serious problem threatening the future of space missions. Humanity is currently facing a potential threat, in the form of the interruption of spaceflight and the use of space technology for many generations.

3.2 The History of Space Debris

Space technology is facing an extremely demanding environment. The object is facing many external degradative influences that determine its lifespan. Directly threatening external influence is, for example, the presence of cosmic radiation, which harms both material and electrical parts of space technology and living organisms. The meteoroids or micrometeoroids of natural origin, which move with high kinetic energy, also represent a threat to every object in space. However, with the use of space technology, a new threat began to emerge in the form of space debris. [4]

Space debris is essentially like meteoroids and micrometeoroids, as they are also solid particles moving with high kinetic energies. However, compared to meteoroids, space debris has an anthropogenic origin. Space debris moves in its orbit throughout its life, increasing the risk of collisions with other objects, and especially with active satellites. In addition to space debris, which remains permanently in orbit, this category also includes non-functional bodies and fragments that enter back into the Earth's atmosphere. [2]

At the beginning of space missions, no emphasis was made on what would happen to the satellite at the end of its life, nor what impact its eventual destruction would have on other space satellites. The insight to this topic brought Donald Kessler and Burton

Cour-Palais, who dealt with the space debris problem in the late 1980s, and they predicted its future development. They pointed out that space debris could become the main cause of orbital collisions in the following years. In that case, it would inexorably lead to the subsequent creation of more space debris. Donald Kessler subsequently deepened the idea of a potential space debris threat in 1990 in his publication "*Collisional Cascading: The Limits of Population Growth in Low Earth Orbit*". In this publication, he analysed certain regions of Low Earth Orbit and predicted an increase in space debris population. With this steady increase due to collisions or explosions in orbit, a chain reaction could occur, in which one incident starts a series of several others, and the whole process is repeating. It would be an unsustainable situation where all the orbiting objects could be destroyed and the whole orbit region could not be used for many decades or even centuries. This phenomenon was subsequently called Kessler's syndrome and is currently one of the biggest problems in modern cosmonautics. About six years later, there was the first unintentional collision between the French satellite Cerise and a fragment of the upper stage of the Ariane-1 H10 launch vehicle. This incident confirmed the concerns that Donald Kessler had previously warned against, and the issue of space debris has spread to the public. [7] [8]

Space debris has become another threat to space technology that must be protected to not contribute to its population growth. Throughout history, active and passive protection systems have been developed for reducing the space debris population, and the standards and recommendations relating to the design of space technology have been created. However, there is currently no approach to eliminate all the space debris that has been created in more than half a century. The historical evolution of the space debris population can be seen in Figure 5, published by the European Space Agency (ESA) based on observation and measurement data. [9]

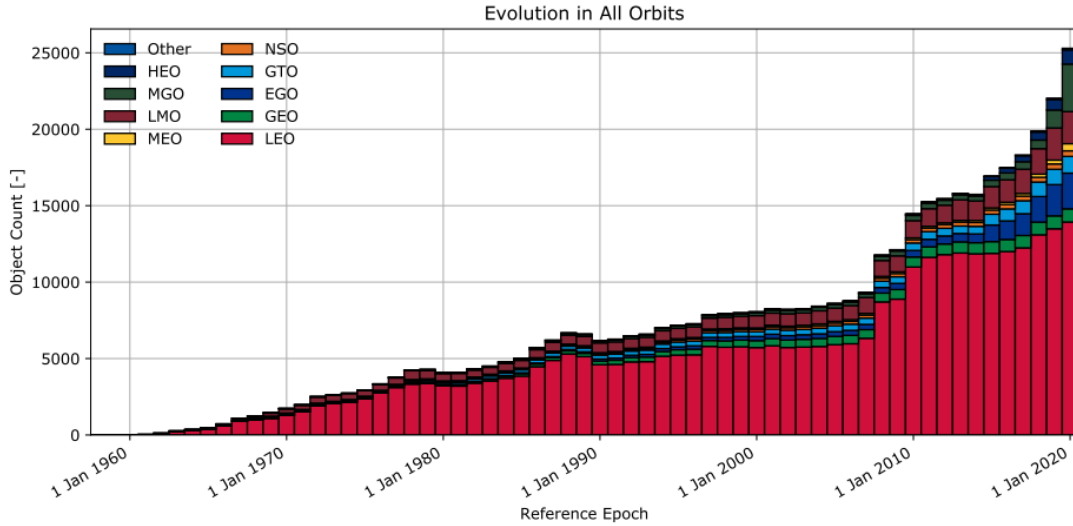

(a) Evolution of number of objects.

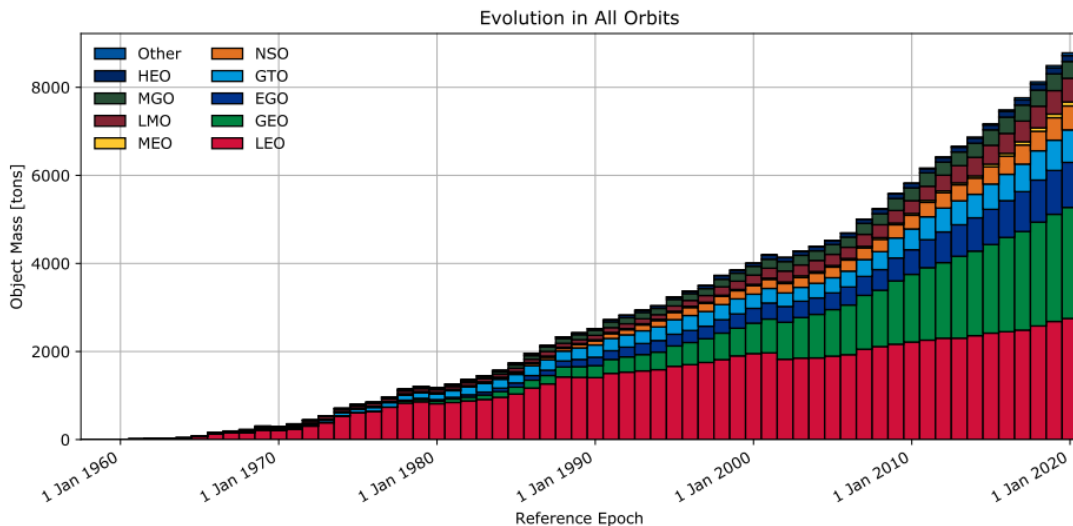

(b) Evolution of mass.

Figure 5: Evolution of the total number (a) and total mass (b) of space debris on different types of orbits [9]
LEO = Low Earth Orbit	GEO = Geostationary Orbit	EGO = Extended Geostationary Orbit
GTO = GEO Transfer Orbit	NSO = Navigation Satellites Orbit	MEO = Medium Earth Orbit
LMO = LEO-MEO Crossing Orbits	MGO = MEO-GEO Crossing Orbits	HEO = Highly Eccentric Earth Orbit
Other = IGO, GHO, HAO, UFO, ESO		

The results show a steady increase in the total amount of space debris since the beginning of the human space age. The most affected areas are the LEO and GEO orbits because of their intensive use. For this reason, these orbits are currently protected and subject to stricter space debris recommendations. In terms of the space debris total amount is LEO the dominating area, due to the intensive launching of very small objects such as CubeSat satellites. [9]

3.3 Space Debris Classification

Space debris is a term encompassing all man-made objects released outside the Earth's atmosphere, whether they are non-functional units or fragmented parts of space technology orbiting the Earth or re-entering its atmosphere. In general, space debris can be classified as fragments of space technology or whole unfragmented objects. However, it can also be specified according to its origin. Those objects whose origin can be determined and assigned to a specific space mission are much easier to categorize and predict their mass, material composition, or potential threat in the form of stored energy in batteries. However, there are also objects with unknown origins, which are referred to as so-called unidentified objects. The detailed categorization of space debris shows the Table 1 below. [9]

Category	Shortcut	Description
Payload	PL	Space objects performing their function in orbit, which is carried out and launched with the help of a launch vehicle
Payload Fragmentation Debris	PF	Fragmented and unintentionally released space objects from the payload for which their genesis can be assigned
Payload Debris	PD	Fragmented and unintentionally released space objects from the payload for which their genesis is assigned by correlations with the source
Payload Mission Related Object	PM	Released space objects ensuring the functionality of the payload (covers for optical devices, astronaut tools, etc.)
Rocket Body	RB	Space object designed to perform launch-related functionality
Rocket Fragmentation Debris	RF	Fragmented and unintentionally released space objects from the rocket body for which their genesis can be assigned to specific events.
Rocket Debris	RD	Fragmented and unintentionally released space objects from the rocket body for which their genesis is assigned by correlations with the source
Rocket Mission Related Object	RM	Released space objects ensuring the functionality of the rocket body (engines, screws, etc.)
Unidentified	UI	Space objects for which their genesis cannot be assigned

Table 1: Space debris classification [9]

The individual categories of space debris are shown in Figure 6. It compares the total number and total mass of space debris and its evolution from the beginning to the present. [9]

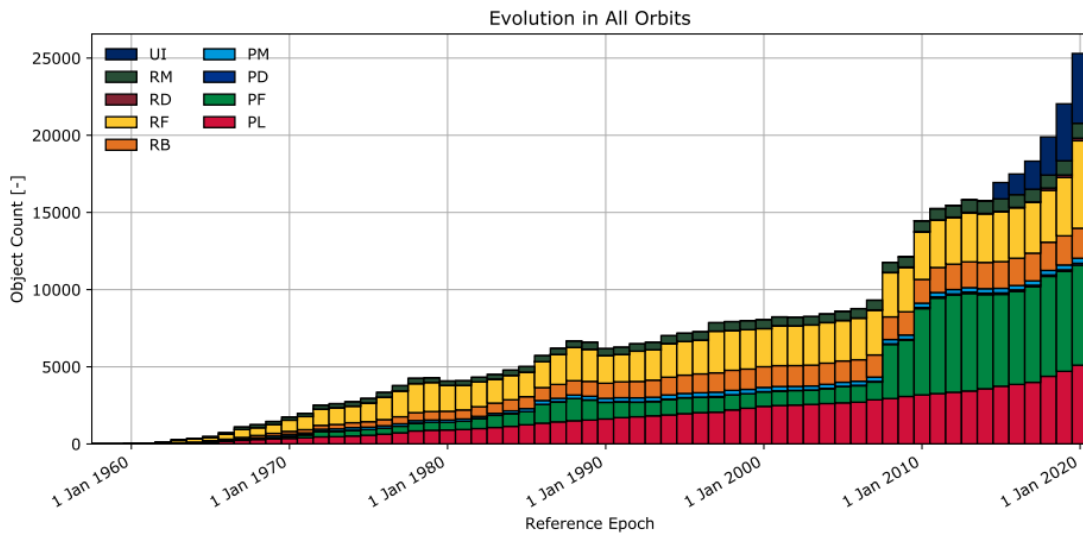

(a) Evolution of number of objects.

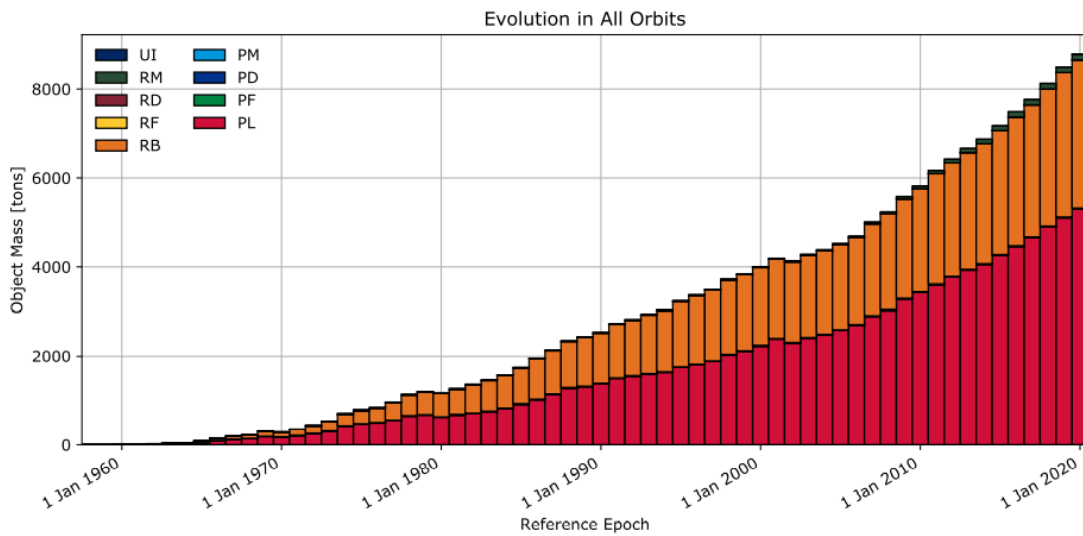

(b) Evolution of mass.

Figure 6: Evolution of the total number (a) and total mass (b) of space debris objects depending on their category [9]

Most of the total mass of space debris is Payload and Rocket Body category. There are several increases in Figure 6 (a) *Evolution of number of objects* which refers to historical events. It was for example the Chinese anti-satellite missile test when the Chinese meteorological satellite was intentionally destroyed in 2007, and it was unintentionally released a huge number of fragments in the Low Earth Orbit region.

Another incident was in 2009 when there was an orbital collision between the active American communications satellite Iridium 33 and the Russian inactive military satellite Cosmos 2251. However, in addition to events directly related to the creation of space debris, it is necessary to keep in mind the continual evolution of tracking technology, which also contributed to the total amount of observable objects. [10]

Larger space debris objects, such as inactive satellites or the upper stages of launch vehicles, poses a much more threat than smaller fragments. It is due to the higher kinetic energy and a potential source of large amounts of fragments. There are also numerous objects, which are so small that they cannot be detected and tracked. The process of fragmentation is also categorized according to its creation. The way the space object is destroyed directly determines the orbit and kinetic energy of the individual fragments. The causes of space objects fragmentation are listed in Table 2. [9]

Break-up cause	Description
Accidental	Errors in the design of subsystems lead, in some cases, to destruction
Aerodynamics	Destruction of an object due to friction against the upper atmosphere
Collision	Collision of multiple objects, where the level of damage depends on the energy of the impacting object
Deliberate	All intentional break-up events (e.g., missile test, employed detonation at the end of mission)
Electrical	Break-up due to the overcharging and subsequent explosion of batteries
Propulsion	For non-passivated propulsion systems might lead to an explosion
Anomalous	Unplanned separation of one or more intact objects, usually at low velocities
Assumed	Temporary status is used before the real cause is determined
Unknown	Fragments without determined break-up event

Table 2: Classes of the break-up cause [9]

The most common break-up events of space debris fragments are destructions from the propulsion system, various anomalies, and unknown causes. The number of in-orbit fragmentation events represents Figure 7, which compares the number of break-up events during history. [9]

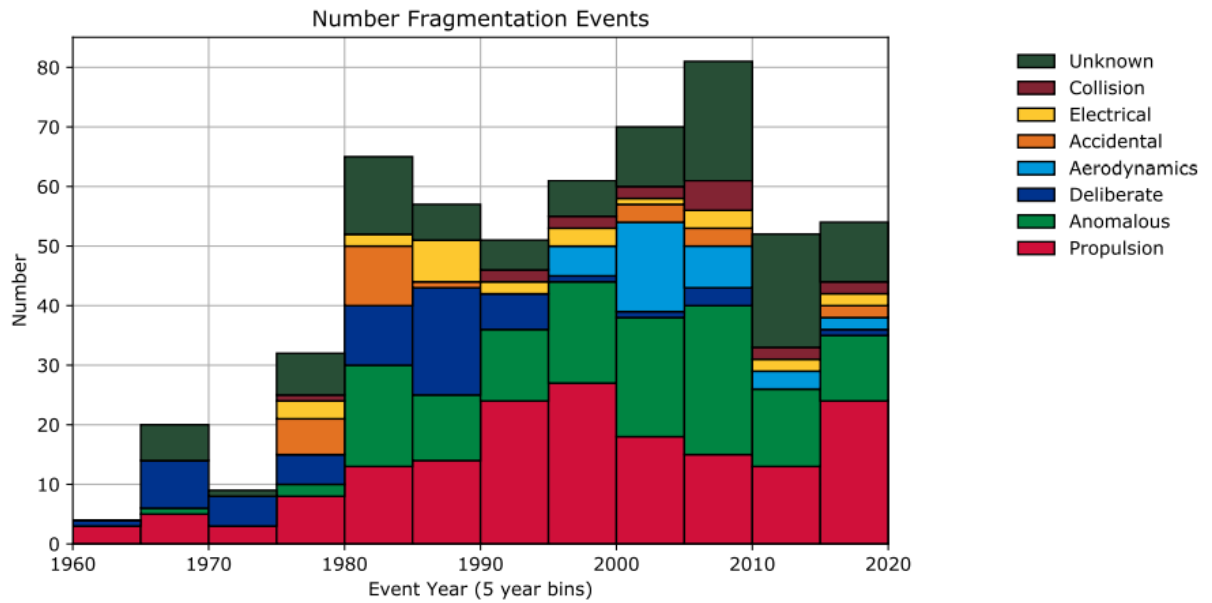

Figure 7: The number of in-orbit fragmentation events divided by their causes [9]

3.4 Detection and Monitoring Systems

For cosmonautics, the observation segment supervising the current state of the orbit is essential. It is a detection and monitoring system of all artificially created objects. However, its limitation consists in its minimum detection of space debris size. Based on these observations, a catalogue of detected objects was created and is continually supplemented. It contains data about the orbital and physical properties of individual objects. It also serves as an input parameter for predicting the development of fragmented and unfragmented orbital objects.

The observation segment includes all radar and laser systems, ground telescopes, or even space telescopes. This observation network monitors and tracks cosmic objects of natural and anthropogenic origin, such as active and inactive satellites, their fragments, or other objects located in Low Earth Orbit (LEO), Medium Earth Orbit (MEO), and Geostationary Orbit (GEO). This tracing and cataloguing are mainly used to predict impending collisions. Therefore, it is necessary to update these catalogues to prevent catastrophic events. There are several observation networks, the largest of which are the US Space Surveillance Network, the European Space Situational Awareness, and the Russian Space Surveillance System. [12]

The main goal of these observation networks is the localization of in-orbit objects, their subsequent monitoring, prediction of future development, and their characterization. However, optimal observation depends on devices or sensors and their suitable selection. Devices used for space debris tracking are optical telescopes, laser sensors, or radar systems. The appropriate sensor choice depends on the distance and velocity of moving objects, their resolution, and the price of those sensors. Radar systems are suitable for Low Earth Orbit observation up to approximately 2 000 km. For objects further away, the advantages of the optical sensors prevail. Although the high accuracy of those sensors, the dependency on the weather makes them not suitable for continual observation. Optical telescopes, working on the principle of refraction or reflection of light, are also used as additional sensors that provide more detailed information about the observed objects and spatial data. The laser measuring sensors principle consists of measuring the duration in which the laser beam travels the distance between the transmitter and the focused object. Laser sensors are currently on the rise as they increase the accuracy of observation. The overall accuracy of observable objects increases by using multiple sensors. [12]

Ground-based observations will always face issues due to the presence of the atmosphere. A solution to this problem is to use these monitoring elements directly in orbits, eliminating the negative effects of environmental density. One of these in-orbit observation devices is, for instance, one of the most well-known orbiting satellites, the Hubble Space Telescope, which has been in orbit since 1990. In 1984, the LDEF (Long Duration Exposure Facility) cylindrical satellite with various systems, materials, or even spores on its surface, was launched into orbit. The goal of this mission was long-term exposure to the space environment for various systems and subsequent investigation of their degradation after returning to Earth. The experimentally obtained data from this satellite served to increased awareness of the space environment and its impact on technology and organisms. Among other environmental influences, the LDEF satellite also faced space debris, the magnitude of which could not be observed by other tracking devices. [14]

The object's observable size directly determines the tracking accuracy. Object sizes that can be easily observable without any difficulty are greater than 10 cm, in the case of Low Earth Orbit. Those objects are catalogued and predicted. However, with the increasing distance from the observation device, this object's observable sizes decrease. In Low Earth Orbit, the resolution of individual devices, such as the Goldstone radar

system used to monitor the solar system or the Haystack radio telescope used to communicate and monitor space objects, is shown in Figure 8. [14]

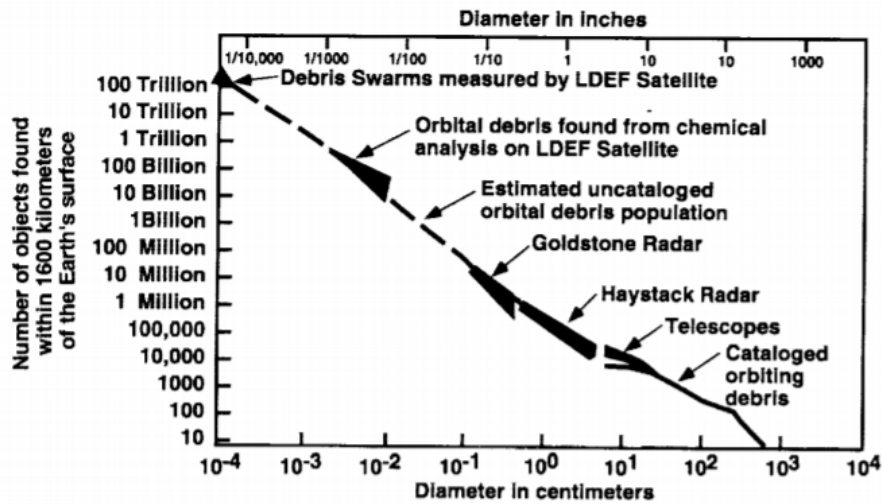

Figure 8: Total number of objects in LEO depending on their size and devices used for their observation [14]

3.5 Space Debris Dynamics

Non-fragmented space technology represents a reservoir for many space debris fragments, which releases during an orbital explosion or collision. The single fragment orbit is determined by the initial kinetic energy and direction from the destruction or release event. The fragment's lifespan is determined by the orbital mechanical energy, altitude, and inclination. The lifespan of all space objects also differs due to the concentration of atmospheric drag. Therefore, if an identical break-up event occurs in a Geostationary Orbit, where the drag coefficient is negligible, the objects are exposed only to environmental influences such as solar pressure. The estimated lifespan of an object moving in a circular orbit at an altitude of 300 km is one month. At 400 km one year, at 500 km ten years, at 700 km, it is a decade, at 900 km centuries, and at 1200 km, it is assumed that objects can have a lifespan of up to thousands of years. Therefore, the lifespan of space objects located in Low Earth Orbit is very high. However, the lifespan of geostationary satellites, which are located at an altitude of approximately 36 000 km, is incomparable. All space objects subject to many external disturbances that active satellites try to compensate for through in-orbit maneuvers and corrections. However, fragmented objects of space technology do not have the possibility of these corrections and thus succumb to the action of the external forces. [7] [10]

In-orbit collision and explosion simulations based on ground tests and break-up event observations during the fragmentation of space objects use the NASA Break-up model shown in Figure 9.

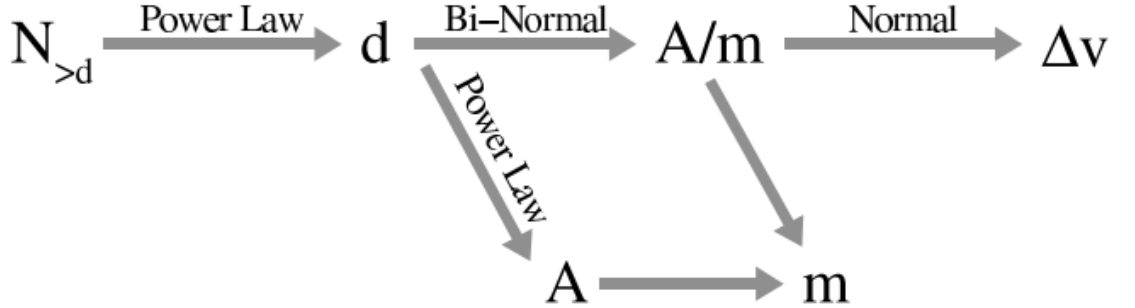

Figure 9: NASA Break-up model [7]

This model is based on the Power Law distribution of the cumulative number of fragments resulting from explosions or collisions referred to as N_f . This distribution is a function of the equivalent fragment diameter or characteristic length d for which the following applies:

$$d \geq l_c = \frac{l_x + l_y + l_z}{3} \quad (3.5.1)$$

, where l_x, l_y, l_z They are the dimensions of the fragment in its geometric axes. The resulting cumulative number of objects with characteristic length $d \geq l_c$ can be determined using experimental relationships of newly created particles from explosion or collision events:

$$N_f(d \geq l_c) = \begin{cases} 6 \cdot c_s \cdot \hat{l}_c^{-1,6} & \text{For explosions} \\ 0,1 \cdot \hat{m}^{0,75} \cdot \hat{l}_c^{-1,71} & \text{For collisions} \end{cases} \quad (3.5.2)$$

, where \hat{l}_c is a dimensionless normalized value per unit length, the coefficient c_s is an experimentally determined calibration parameter specific to the events in which the fragmentations occurred. Limits of space debris tracking, and cataloguing depend on the fragment's minimum observable size and the distance from the observation device. The further away the objects are, the lower is the possibility of their observations. The calibration parameter c_s is based on the knowledge of the catalogue number of observed objects categorized by their distance. However, this number is always lower, therefore,

the experimentally determined Henize compensation factor is used, which corrects the catalogue values depending on the distance and object's dimensions. The dimensionless magnitude of the fragment's mass \widehat{m} and its calculations differ depending on the consequence of the collision, whether it is a catastrophic event or not. The catastrophic event occurs when the specific impact energy of an impact body exceeds the critical value $\widetilde{E}_p^* = 40 \text{ kJ/kg}$, when the total energy is determined by:

$$\widetilde{E}_p = \frac{1}{2} \frac{m_p}{m_t} v_i^2 \quad (3.5.3)$$

, where m_p represents the mass of the impact body, m_t is the hit body's mass, and v_i is the impact velocity. The dimensionless mass is calculated from the impact energy according to equation (3.5.4). [7] [11]

$$\widehat{m} = \begin{cases} \widehat{m}_t + \widehat{m}_p & \text{Pro } \widetilde{E}_p \geq \widetilde{E}_p^* \\ \frac{\widehat{m}_p \cdot \widehat{v}_i}{1000} & \text{Pro } \widetilde{E}_p < \widetilde{E}_p^* \end{cases} \quad (3.5.4)$$

The Break-up model continues by assigning the area size to the object mass, which is performed using a bimodal probability density function based on catalogue values. The results of this model provide an idea of what happens to objects after an in-orbit collision or explosion. [7]

Historical data observations show that most of the space technology break-up events occurred in circular orbits, with 80% of objects orbiting in Low Earth Orbit. These observed events contributed to understanding the distribution of the newly created space debris fragments and their physical properties. One of these break-up events was the upper stage explosion of the Ariane-1 launch vehicle in 1986, which occurred nine months after the payload release. The time dependence distribution of those newly created space debris fragments is in Figure 10. The initially directed and concentrated stream of those fragments, following the same orbit connecting the new apogee and the perigee (pinch line), extends in all directions due to perturbations. [7]

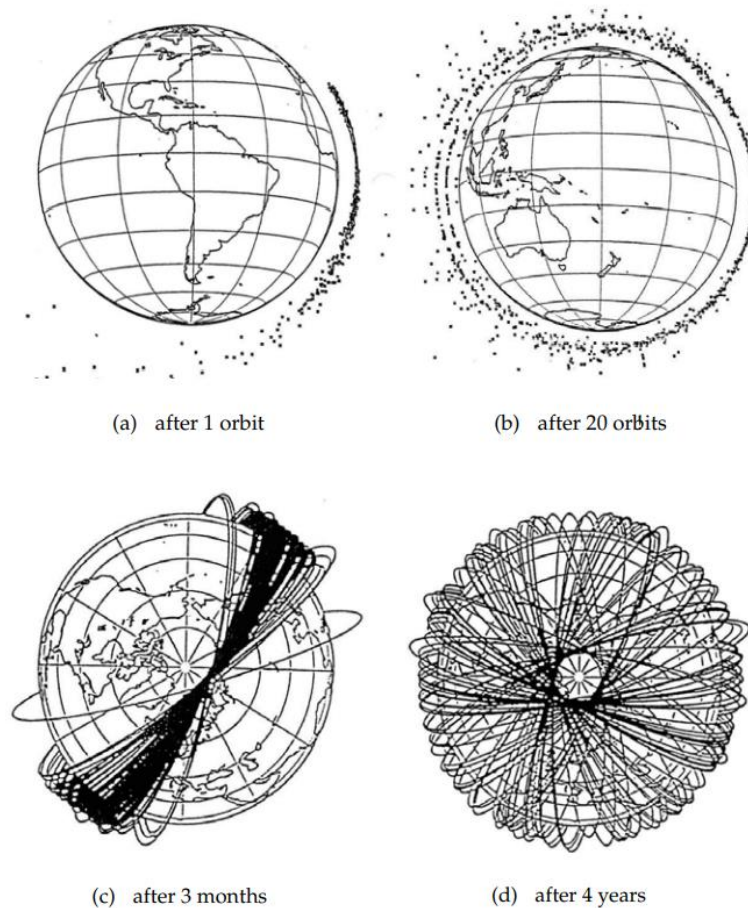

Figure 10: Time dependence of the orbiting fragments created during the explosion of the upper stage of the Ariane-1 H-10 launch vehicle [7]

All fragments created during a collision or explosion events that do not slow down due to the atmospheric drag pass through their point of origin called the pinch point. There is a high concentration of space debris in the pinch point, and thus an increased risk of collisions with other objects. This risk decreases over time, precisely because of the perturbations that cause the fragments to spread into different directions and change their velocities. The Gabbard diagram, shown in Figure 11, is used to visualize the development of the apogee and perigee altitudes over the period. The characteristic shape of this diagram is the letter X, where the upper part represents the individual apogees and the lower part the perigees. The decisive factor is the centre where the lines cross each other. Fragments located in this centre have retained their orbital velocity, the period of circulation, the altitude, and, therefore, they did not slow down or accelerate. The left side of the diagram represents fragments that were slowed down due to the perturbations (i.e., atmospheric drag). Therefore, their altitude decreased, and their period as well. Objects

located at the left end of the diagram are the first to re-enter the Earth's atmosphere. The right side represents accelerated fragments, whose altitude and period have been increased. [7]

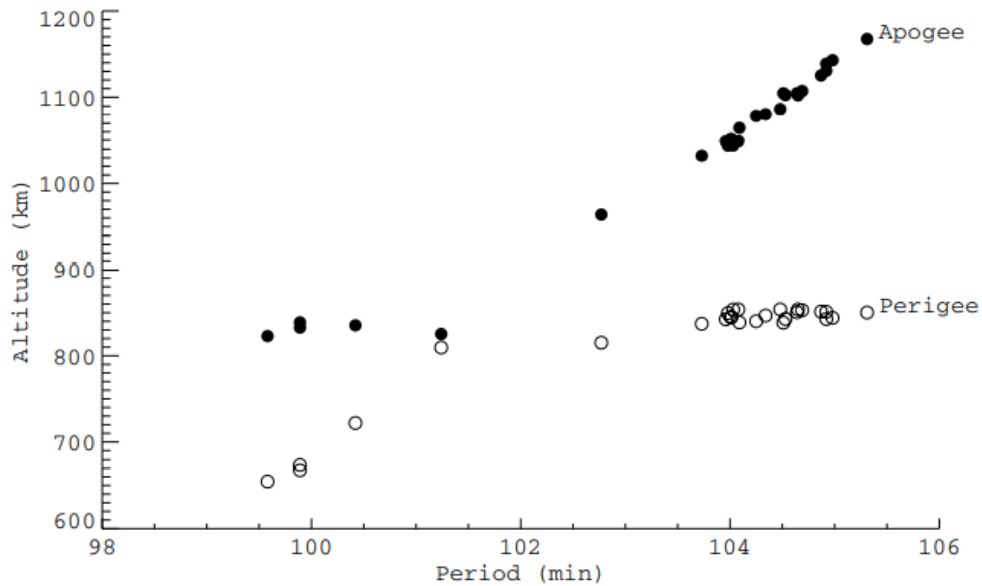

Figure 11: Gabbard diagram of space debris fragments, created from the upper stage explosion of the Zenit launch vehicle in 1993 [7]

3.5.1 Non-fragmented Source of Space Debris

However, space debris does not have to be created only by collisions and explosions. One of the dominant sources belonging to this category of space debris fragments is solid particles released during the combustion of solid propellant rocket motors in the form of alumina (Al_2O_3). Solid propellants contain aluminium powder as a stabilizer of the combustion process. At this time, more than 1 100 orbital maneuvers of these rocket motors have been performed, which is more than 1 000 000 kg of burned propellant. If solid propellant burns, the slag, and dust are released into outer space. The combination of alumina and rocket engine material called the slag releases only in small amounts around 1 % of the total fuel volume. However, its particles can take on dimensions up to $0,1 \text{ mm} \leq d \leq 30 \text{ mm}$ in diameter. The alumina dust or fumes released during the combustion process are present in approximately 30% of the total fuel volume. Those particles can take on dimensions up to $0,01 \mu\text{m} \leq d \leq 50 \mu\text{m}$. Currently, there is no chance to observe or even track those particles because of their sizes. Therefore, the history of space missions using these solid propellants is necessary.

Thanks to the records of ignition data, initial and final orbital trajectories, ignition positions, and rocket engine characteristics, the maneuver can be reconstructed and subsequently determined direction and the number of released particles. The dust particles generated during the combustion process have a high initial velocity, which is approximately constant for all particles and is directly related to the rocket engine characteristics. Thus, while the dust particles reach speeds of 3 000 m/s, the slag is released with small initial velocities that reach up to 75 m/s because, in 95% of cases, it releases in the final combustion stage. The number of firings of solid propellant rocket engines in history depending on the orbits shows the Figure 12. [7]

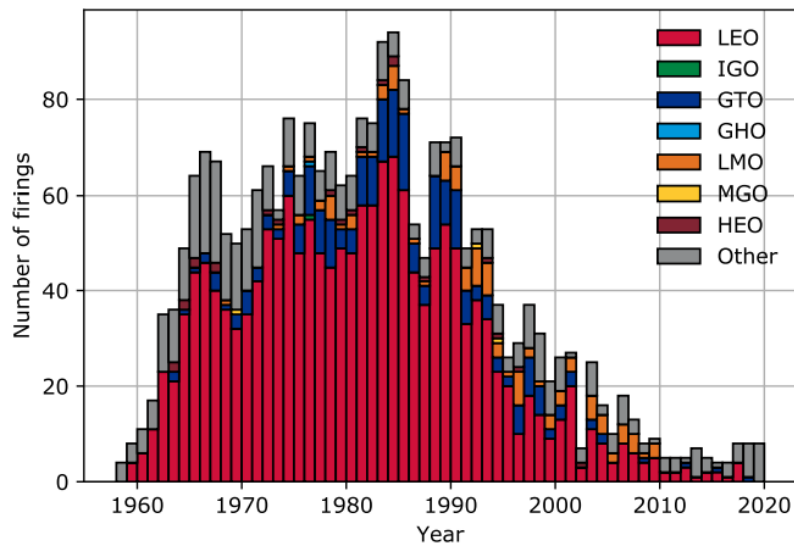

Figure 12: The number of firings of solid propellant rocket engines in history depending on the orbits [9]

Another representative of space debris, with no initial cause in a collision or explosion, is an alloy of sodium and potassium. This chemical compound served as a coolant for Soviet RORSAT reconnaissance satellites, which operated in Low Earth Orbit at an altitude of 250 km between 1980 and 1988. These satellites were equipped with nuclear reactors, and the eutectic alloys of sodium and potassium (NaK) in the liquid state served as their coolants. At the end of their mission, the passivation process began. The reactors were separated and transferred to an altitude of 900 km. At this altitude, the reactor core split and released all the coolant in the circulation system into outer space. This negligent passivation occurred in a total of 16 cases from 31 missions. Approximately 13 kg of circulating coolant releases into a cloud of particles with a diameter ranging from millimetres to centimetres. The Goldstone and Haystack radar

systems first detected these particles, and their origin was subsequently clarified in 1996 by Russian scientists. The evolution of these particles divided by their diameters shows the Figure 13. [7]

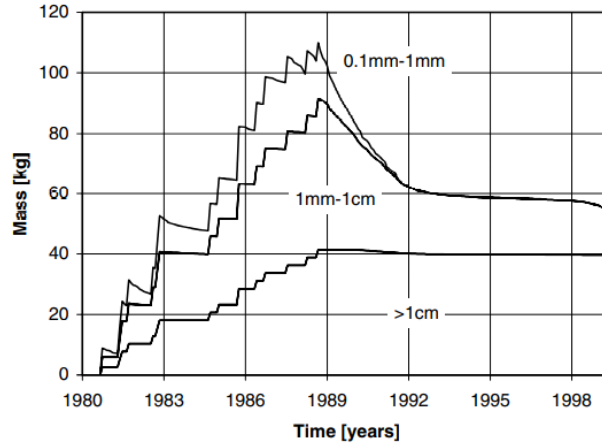

Figure 13: The total mass of released NaK alloy particles depending on their size compared to their time dependence [7]

In addition to break-up events that directly create fragments of space debris, such as collisions, explosions, or products of combustion or passivation, some events produce space debris indirectly. These are, for example, the degradation of materials due to cosmic radiation, extreme ultraviolet radiation (EUV), the surface contact with free oxygen atoms, or ejection of matter from the surface due to the impact of small bodies such as micrometeoroids or space debris fragments. During these events, a small number of unobservable particles releases. [7]

3.6 Space Debris Mitigation

To protect the space environment from catastrophic events, such as the Kessler syndrome, a global recommendation metrics system for space debris mitigation has been introduced. Organizations responsible for creating these metrics are the United Nations Committee on a Peaceful Uses of Outer Space (UN COPUOS), which publishes space exploration-related recommendations, the Inter-Agency Space Debris Coordination Committee (IADC), responsible for publishing space debris mitigation technological guidelines, the International Organization for Standardization (ISO), developing the technical standards and requirements and the European Cooperation for Space

Standardization (ECSS), issuing technical standards for all space activities. [9] [13] [15] [16]

All these recommendations aim to mitigate the total amount of space debris in protected regions. These regions define the IADC, and they include the Low Earth Orbit (LEO_{IADC}) and Geostationary Orbit (GEO_{IADC}) regions. The protected region of Low Earth Orbit is a spherical shell, starting from the Earth's surface, and reaches an altitude of 2 000 km. In the case of a Geostationary Orbit region, the protected area is the part of the spherical shell characterized by a width of ± 200 km from the geostationary orbit and an angle, defined by a line joining the orbit, and the Earth's centre, with a deviation of $\pm 15^\circ$. [9]

The space debris mitigation recommendations cover the following categories:

- **Reducing emerging space debris:** This category applies to space debris created during every space mission. The design of every object launched into orbit (i.e., rocket launchers, payloads) should not produce space debris during their mission. If the space object cannot meet this requirement, the number of debris produced should be decreased to the necessary minimum. [9] [16]
- **Minimization of potential orbital decays:** The probability of undesirable disintegration should be minimum throughout the entire space technology lifespan. Active space objects should also perform an evasive maneuver, with early warning of an impending collision. At the end of the mission, the decay's probability should also be at the minimum due to the releasement of residual energy stored in the propellant, batteries, etc. If one of the above-mentioned recommendations cannot be met, the space object should disintegrate at the lowest possible altitude of the orbit. [9] [16]
- **Disposal of inactive space objects:** In the Low Earth Orbit (LEO) and Geostationary Orbit (GEO) protected regions, a level of inactive anthropogenic object accumulation increase should be none. Objects in the Low Earth Orbit region should be moved away, ideally extinct in the Earth's atmosphere during re-entry. In a geostationary orbit, inactive satellites should be transferred into a higher orbit, known as the Graveyard Orbit. [9] [16]

- **Orbital collision avoidance:** During the space mission planning phase, the collision probability of all artificial objects launched into orbit needs to be evaluated. If a collision is imminent, the spacecraft should perform an evasive maneuver to avoid it. [9] [16]

3.7 Space Debris Creation Avoidance

A large amount of damage has been done in the past. The Earth's orbit is now overflowing with non-functional anthropogenic objects, their fragments, and other particles related to them. One solution is reducing the further emergence of space debris through preventive measures. These are active, passive, and operational protections, which allow space technology to avoid collisions with other bodies or mitigate their consequences. This subchapter is devoted to these protection principles and their detailed analysis. [14] [17]

3.7.1 Active Protection

The active protection system relies on early warning of impending collisions with other space objects. It aims to prevent these collisions by performing evasive maneuvers or mitigate their consequences by protecting sensitive components. The incoming warning of imminent collision comes from observation segment sensors and the motion data of catalogued cosmic objects. This principle of active protection has several weaknesses, such as the fact that the warning of an imminent collision must come with sufficient time ahead. Another issue is the accuracy of the location and movement of catalogued objects, for which we cannot say with certainty whether a collision will occur. One of the greatest threats is the resolution capability of observation devices because increasing orbit altitude decreases the observation ability. In other words, if space objects are not catalogued, and the system does not detect them in time, the satellite cannot be warned against the imminent collision. Another solution for in-time satellite warning of an impending collision with another object is a system of tracking sensors directly onboard. This system can register the space object in time, evaluate its trajectory, collision risk, and in case of imminent danger, be able to perform an evasive maneuver. However,

this option would require expensive equipment and would therefore only be usable during space missions with valuable payload, i.e., a human crew. [14]

3.7.2 Passive protection

The principle of spacecraft passive protection consists of collision protection while mitigating their consequences. The probability of collisions increases with decreasing sizes of impactors. Therefore, it is more likely that the satellite will encounter smaller object impacts. Those objects have lower kinetic energy and can be slowed down or even stopped during the collision events. The kinetic energy of impacting space objects with sizes of centimetres is in many cases not absorbed by passive protection, and either complete or partial destruction of the device will occur. Therefore, the more massive the impactor is, the more robust the passive protection itself must be. However, the mass of the outer shield is limited by the capabilities of the space mission and is therefore effective only for objects up to defined sizes and kinetic energies. Additional passive protection can apply to the individual subsystems of the satellite, which are essential for its function, for example, by strengthening the surrounding walls. [14] [17]

During the passive protection design phase, it is always necessary to balance minimizing weight, dimensions, price, and maximizing protection. The basic types of protection are monolithic and multilayer shields, from which various modifications have subsequently developed.

3.7.2.1 Monolithic shields

The advantage of monolithic shields consists in their structural simplicity and relatively small dimensions. The more massive impacting object is, the thicker must the monolithic shields be. Considering this dependency, the shield's mass increases with the kinetic energy of impactors. It is the main disadvantage of space-based monolithic shields due to the minimalizing effort of all space object's mass and dimensions. The use of monolithic shields results either in an undesirable weight reduction of the payload launched into orbit or an increase in the risk of penetration of lower-weight shields. [14]

3.7.2.2 Multilayer Shields

The Whipple Shield, on the other hand, has a much better protective ability, but at the cost of larger sizes and expensive manufacturing. In contrast to monolithic shields, which is advantageous during collisions with small objects with low velocities of 2 to 3 km/s. Above this velocity limit, it is better to use multilayer shields. The basic principle of the function of those shields is the evaporation process of the impacting projectile on the front layer (Bumper), which dissipates part of its kinetic energy. Newly created fragments then proceed to the next wall and scatter over a larger surface. The principle of passive protection of the Whipple shield shows the Figure 14. [14] [17]

The modifications of the Whipple shield are the classic Whipple shield differing by distances of individual walls, the Stuffed Whipple shield, using intermediate layers of fabrics for effective kinetic energy dissipation, and the Multi-Shock Whipple, consisting of several layers of ceramic fabric with a solid back wall. [17]

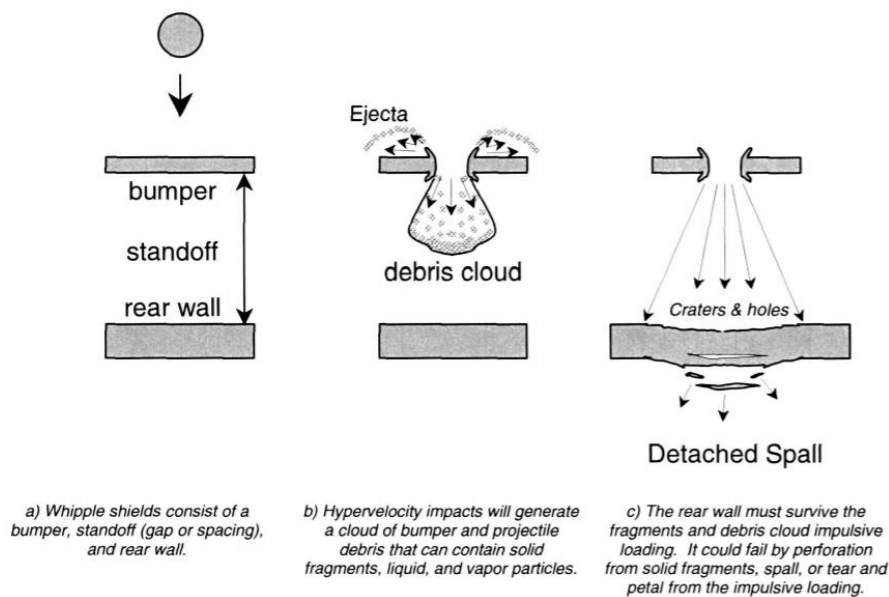

Figure 14: The principle of Whipple shield [17]

3.7.3 Operative protection

The principle of operational protection consists of ensuring the functionality of space technology, after a collision with other space objects, for example using redundancy, or a suitable construction design. It minimizes the collision consequences and prevents the occurrence of system failures. Operational protection can be an appropriate design of the individual components against material degradation because

this process should not damage or even fail the entire mission. Another example can be redundancy, which occurs in electrical engineering. The redundancy principle consists of duplication and different structure distribution of individual elements. The main goal is to maintain the system's functionality during some disorders. Operational protection can also be in the form of an appropriate structure design, where the effort is not to expose sensitive subsystems to direct contact with impacting objects. [14]

3.8 Space Debris Elimination

Preventive measures can significantly reduce the further increase in space debris population. However, the problem also consists in the elimination of cosmic anthropogenic objects that are inactive or at the end of their life and already created space debris fragments. Those objects pose a risk to active space technology that may collide with them. Space technology at the end of their life should be destroyed and leave no trace behind. The space object should also be able to move away from protected regions to orbits with a lower probability of collisions. There is also a need to clarify the differences between "End of life" states, in which the spacecraft either shuts down permanently, re-enter the atmosphere, or loses its control, and "End of mission" states, in which to fulfil a mission objective, to perform a function, or to complete a controlled termination. [15] [18]

3.8.1 Space Objects Deorbitation

The only way to eliminate space debris is its evaporation in the atmosphere during the re-entry. In the lower layers of the Low Earth Orbit, space debris slows down due to the aerodynamic friction of the atmosphere remnants. This deceleration results in the space object's atmospheric re-entry, during which it evaporates because of aerodynamic heating. This re-entry evaporation process can be controlled descending, or it may occur spontaneously. Spontaneous descent can be a problem, especially for larger objects, which can withstand the aerodynamic forces occurring during the re-entry. Those objects may eventually get to the earth's surface and cause critical damage. The decelerating speed depends on the ballistic coefficient, which defines the behaviour of an object moving, subjected to atmospheric resistance. It derives from the shape, mass, and the

body's cross-section area. During the controlled descent, the ballistic coefficient increases by total area increase (i.e., telescopic parts, sails), which results in increased aerodynamic friction force. [13] [14]

3.8.2 Graveyard Orbit and Systems Passivation

If space object elimination is not possible, it is necessary to ensure that a malfunctioning space object poses the least risk to other active technology, especially in protected regions. In addition to the previously mentioned types of orbits, there are also so-called graveyard orbits, which contain no orbiting functioning space objects and are thus ideal regions for inactive space technology. This methodology uses, for example, geostationary satellites. At the end of their mission, the satellite is transferred to a slightly higher super-synchronous orbit, called the Graveyard orbit. The final and principal step before the permanent cessation of the satellite's activity is its passivation. The space object must drain all accumulated energy from its systems or ensure its safety. This process is necessary to reduce the likelihood of an explosion accident, creating many space debris fragments. The accumulated energy can be stored, for example, in the propellant system, as a residual fuel, in batteries in the form of electricity, in high-pressure tanks, or it can be in the form of kinetic energy from rotating torque or reaction parts. [13] [15] [18]

3.8.3 Active Removal of Space Debris

The last method of space debris elimination is its active in-orbit removal. The active removal is a controlled adjustment of the space object's orbit, guiding it to the earth's atmosphere re-entry or transferring them to the graveyard orbit. For this purpose, exceptional space technologies operating in orbit, which are in direct contact with inactive bodies, are currently evolving. Another option for the active elimination of space debris is the use of high-power lasers. Those ground segment lasers can target smaller space objects, evaporate their surface, and change their trajectory. There are many ways to eliminate space debris actively, but it always depends on the feasibility and efficiency of the approach. Current approaches involve the robotic arms, which grip the target object and allow its further manipulation. Another possibility is the trapping nets, which release against moving objects, capture them, and subsequently manipulate them. Other methods

can be various sprays that increase the drag coefficient and thus reduce the lifetime of the target object. [13] [14]

Space debris suitable for active elimination is selected according to the risk they pose to other space objects in the region. Therefore, if there is any space debris on a collision course with other functioning satellites, which cannot perform an evasive maneuver, come into consideration at first. Furthermore, they are large and very massive bodies, posing a potential threat due to the large number of space debris fragments created during an explosion or collision event. All the potentially hazardous space debris occurring in the protected regions of Low Earth Orbit and Geostationary Orbit are also considered. Although many projects related to active space debris removal have emerged throughout history, they have always faced the issue of the captured objects ratio to the potential for additional space debris fragments creation due to the destruction of the intercepting device. The design of these space missions also includes the price at which a non-functional body can be actively removed from orbit. The consequence of these aspects is that there is currently no way to remove smaller space debris actively, and the effort focuses only on larger objects that pose the greatest danger. The following subchapters discuss the implemented and unrealized projects of active space debris elimination. [13] [14]

3.8.3.1 Orbital Express

The Orbital Express mission was a collaboration between the United States Defense Advanced Research Projects Agency (DARPA) and the NASA Marshall Space Flight Center (MSFC) team. The Orbital Express program focused on safe and cost-effective access and service of autonomous satellites in orbit. Orbital Express consisted of two parts, where the larger one, called ASTRO, was the major service satellite. The second part, named NEXTSat, was the target satellite made for servicing and refuelling. The experimental test took place in 2007 when both satellites were launched into orbit by the Atlas V launch vehicle. The mission concept of in-orbit active satellite servicing was a contribution. Instead of eliminating those inactive satellites, the resupply of fuel, batteries, or other spare parts can extend their lifespan. [13]

3.8.3.2 Deutsche Orbitale Servicing Mission

The Deutsche Orbitale Servicing Mission (DEOS) program focuses as well as the Orbital Express program on satellite servicing. This program intended to extend their service life by refuelling, replacement of components, and in case of irreparable satellites, to control their atmospheric re-entry. The whole system consisted of the main service satellite and the target satellite made for servicing or deorbiting (Client Satellite). The DEOS mission was also the first attempt to actively eliminate space debris in the form of non-functional satellites directly in orbit. Both parts should have been launched into orbit in 2018, but the entire project was cancelled at the definition stage. [13] [19]

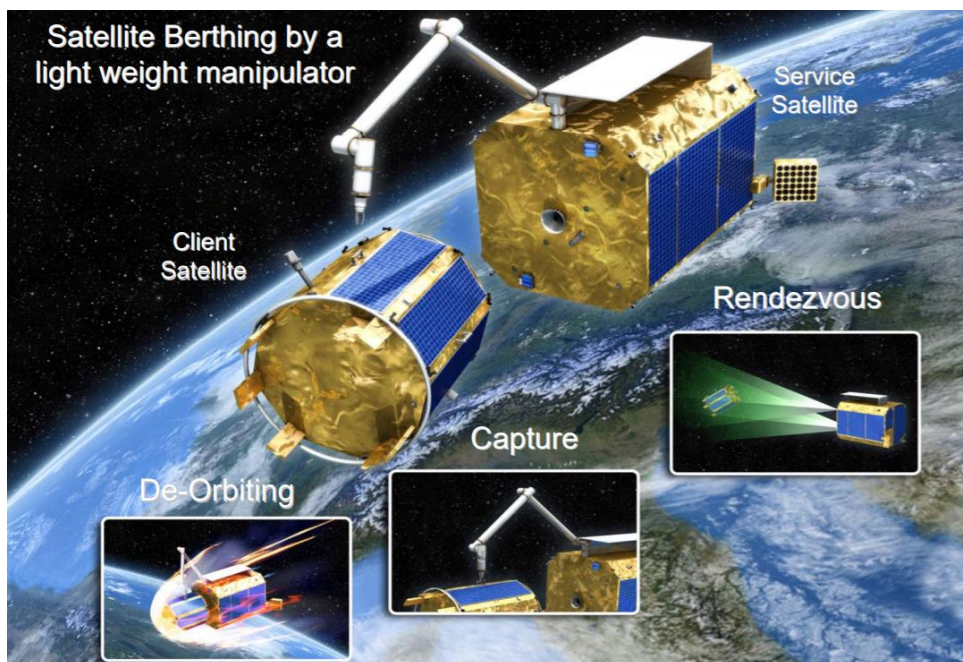

Figure 15: Deutsche Orbitale Servicing Mission [19]

3.8.3.3 Robotic Refueling Mission

Robotic Refueling Mission (RRM) was a technology used on the International Space Station (ISS) to test satellite refuelling technologies, repairment, and in-orbit servicing. NASA started its development in 2009, and in 2011 it was delivered to the ISS. The satellite had a cubic shape with a side length of approximately one meter. It carried onboard five unique devices for conducting experiments, such as refuelling, repair, and servicing. The Robotic Refueling Mission focused primarily on satellites not designed for refuelling or repair. It worked with the ISS DEXTRE robotic arm, operating through the ground segment. [13]

3.8.3.4 Phoenix Program

The Phoenix Program of the United States Defense Advanced Research Projects Agency (DARPA) is based on the previous Orbital Express mission. However, the Phoenix Program focuses on servicing, repairing, and relocating satellites on Geosynchronous Orbit. The mission focuses on servicing, repairing, and transferring satellites to a Graveyard Orbit but also comes up with a completely new concept of harvesting usable components from no longer functioning satellites and their subsequent reuse on active satellites in the form of spare parts. This concept of reusing parts of non-functional satellites, instead of shutting them down and eliminating them, contributes to the solution of the active space debris problem. The concept of servicing and repairing satellites on a Geostationary Orbit also uses the ConeXpress or Vivisat projects. [13]

3.8.3.5 CleanSpace-1

The CleanSpace-1 space mission will be the first commercial project of active space debris removal from the Low Earth Orbit region. The mission start has been postponed several times and is currently expected in 2025. The CleanSpace-1 mission will focus on removing non-functional space objects comparable in size to smaller satellites. The elimination process consists of performing a rendezvous maneuver of the CleanSpace-1 satellite and the target object. After this, four robotic arms will capture the target object, and then the whole system performs a sequence of controlled atmospheric re-entry. The mission objective of CleanSpace-1 is to remove dangerous space debris, which must be properly selected. [13]

3.8.3.6 Electro Dynamic Debris Eliminator

A fascinating concept came from Star Technology and Research, Inc., which designed the Electro Dynamic Debris Eliminator (EDDE) space mission to eliminate space debris in the Low Earth Orbit region. This device can eliminate space debris weighing more than 2 kg at an altitude of 500 to 2000 km. As a propulsion system, EDDE would use the generation of an electromagnetic field that would interact with the Earth's electromagnetic field. It is a purely electrical device that would use solar energy transformed via solar panels into electrical energy. To capture space debris, EDDE would use capture nets. The captured objects will be subsequently transferred into the lower

layers of the Low Earth Orbit, where they would be separated from the system together with the capture net and re-entry the atmosphere. Dozens of these devices would be able to clear most space debris objects from the Low Earth Orbit within seven years. The system consists of two small satellites containing electron emitters. Those emitters connect several segments of one-kilometre aluminium conductors serving as electron collectors. Solar panels are arranged in groups along the entire length. At each end, there is a mechanism that contains the capture nets, and which releases them. [13] [20]

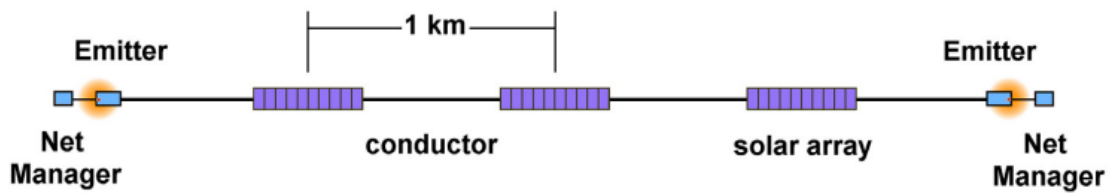

Figure 16: Electro Dynamic Debris Eliminator [20]

3.8.3.7 LEOSWEEP Project

The LEOSWEEP Project concept focuses on the massive space debris elimination, which could be, for example, the upper stages of a launch vehicle. To do this, it would use Ion Beam Shepherd (IBS) technology to direct the movement of target objects and their deorbiting. It is a small satellite. Therefore, it is a non-contact method of trajectory adjustment by suitable momentum transmission. [21]

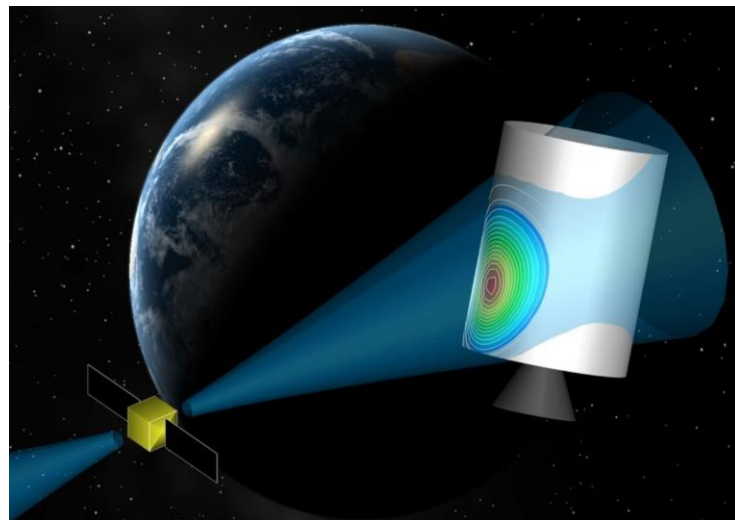

Figure 17: LEOSWEEP Project [21]

3.8.3.8 RemoveDEBRIS

The RemoveDEBRIS project, led by the Surrey Space Center, aims to demonstrate the technological possibilities for space debris mitigation. RemoveDEBRIS contains four experiments, both for the active elimination of space debris and passive systems. The first experiment consists of launching a small object representing the target body to be captured by a capture net technology. Other experiments are the navigation CubeSat or a harpoon device system that fires a penetrating projectile into the target object and attracts it. The last experiment is a deployment sail used for aerodynamic drag increase and subsequently deorbiting the satellite. [22]

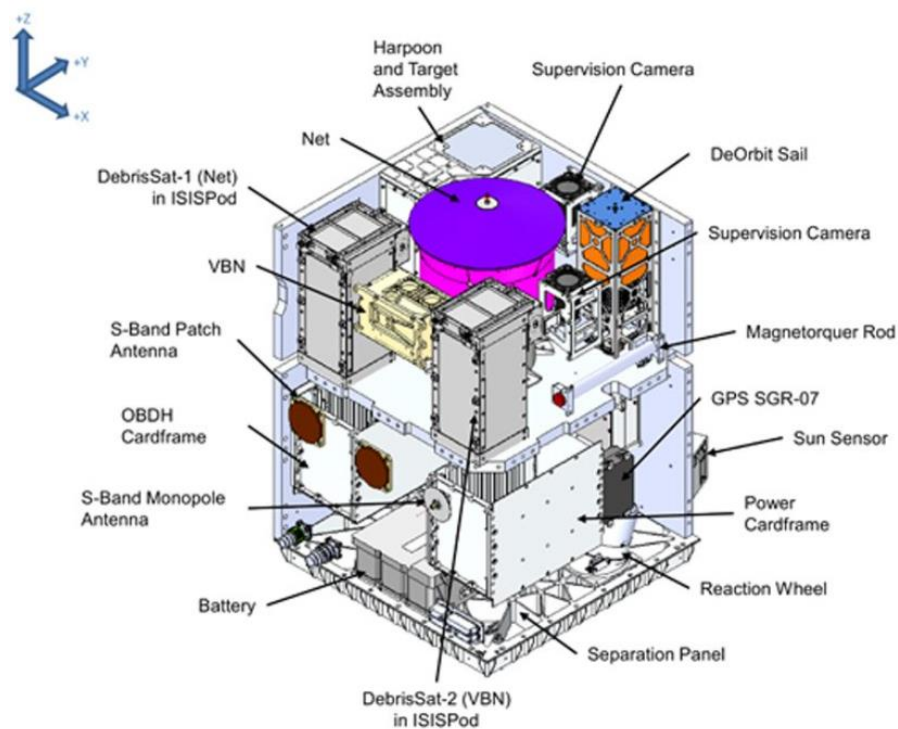

Figure 18: RemoveDEBRIS [22]

4 Active Space Debris Removal System

4.1 Introduction

This chapter is devoted to the design of an active space debris removal system. The objective is to design a device capable of actively eliminating already created space debris of various sizes, masses, and velocities. The design consists of the structural part, description of the individual subsystems, and the possibilities of the uses, according to the mission objective. The active space debris removal system conceptual design, together with the description of its parts, shows Figure 19.

Most of the existing active space debris removal systems focus mainly on non-fragmented object elimination. The main reason for this is better observation, prediction of the future orbit evolution, and the high level of risk that these objects represent. As mentioned in the theoretical part of this thesis, the destruction of larger space objects creates many fragments. It increases the risk of collision with another object and reduces the possibility of these newly created fragments detection. But what to do with already fragmented space debris, which cannot be detected, and which poses a major risk to all active space missions? This question aims to answer the active space debris removal system proposed in this diploma thesis. All models and drawings are designed via Siemens NX software.

There are many problems associated with space debris fragments, from limited detection capabilities related to the fragment's dimensions, geometry, and material, to the prediction of future orbital developments and velocities. In the case of active or inactive space object fragmentation events, the initially directed stream of those fragments begins to destabilize very quickly. If such an incident occurs, it is necessary to eliminate the newly created fragments as quickly and efficiently as possible due to their easier localization and higher concentration around the original orbit. Unfortunately, there is currently no technological solution that can achieve this goal. For this reason, this diploma thesis deals with the conceptual design of a device that would be able to eliminate these newly created space debris fragments effectively.

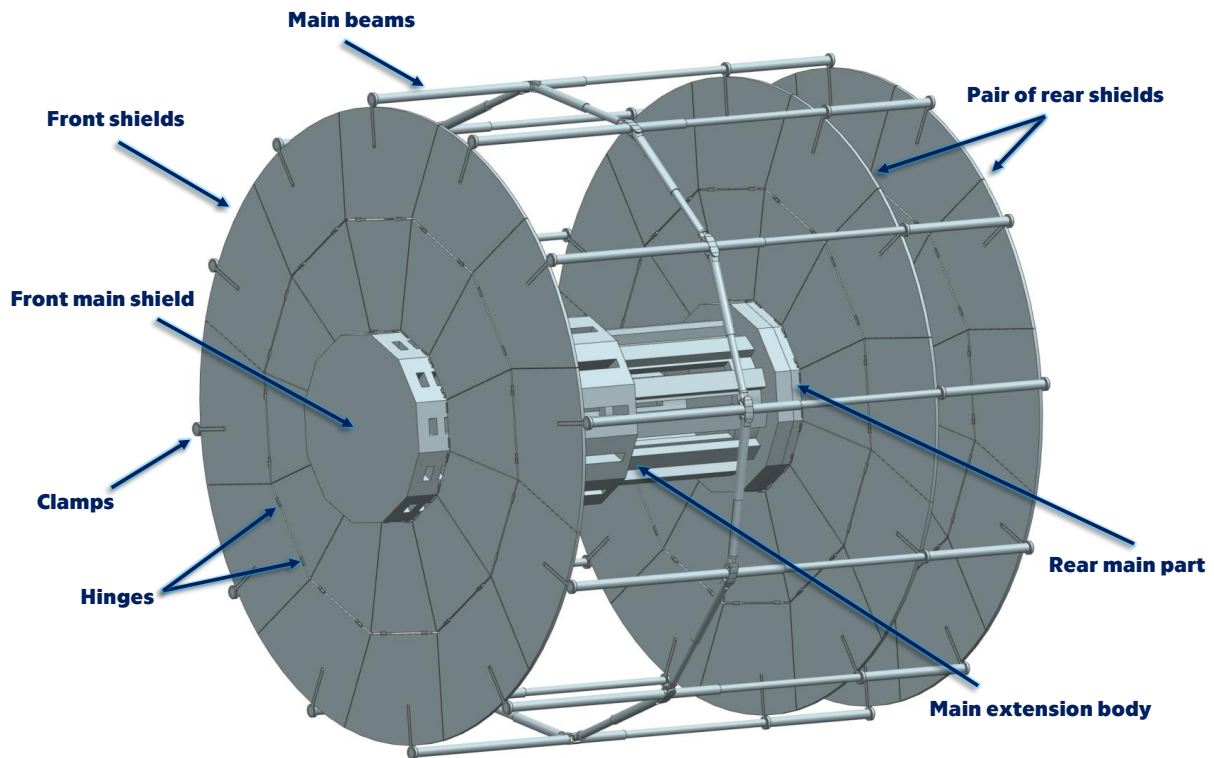

Figure 19: The active space debris removal system conceptual design

4.2 Principal of Function

For eliminating the newly created space debris, it is necessary to capture it and then either use it and transform it into something else or disintegrate it without producing any new space debris. However, it is also very principal to keep in mind the potential danger which represents the fact that this device will face the stream of high-velocity space debris that may further disintegrate it.

4.2.1 Deceleration and Capture of Space Debris

The velocities of the orbiting fragments differ from the initial kinetic energy given to the individual parts during the decay process of the original body, then from the orbital parameters, or the distance from the earth's surface. In the Low Earth Orbit region, most space objects orbiting at velocities of 7 to 8 km/s. However, in the event of a collision with another object, the average speed of this impact is approximately 10 km/s or 36 000 km/h. Therefore, even low masses objects have an enormous amount of kinetic energy, which needs to be dissipated. In the case of larger space objects, their kinetic energy can

be mitigated, for example, by a motoric maneuver after a successful capture or by adjusting their orbit. However, these solutions are difficult to implement for small fragments. The only known way to slow down small space debris is passive protection, discussed in subchapter 3.7.2.

The capturing device will function as one large folding passive shield absorbing the kinetic energy of impacted fragments. Due to the diversity of space debris, it will be necessary to design the device for capturing both slow and fast-moving objects. For this purpose, the device will be using two types of passive protection. The first, which will be in direct contact with the environment and the impacting fragments, will be designed to capture minor particles, using a combination of multilayer passive shields with various stuffed materials. Those particles that will have enough kinetic energy and the front protection will not be able to stop them will disintegrate into smaller particles, which will then travel to the interior of the capture device. An essential characteristic of this device is the distance between the front and rear shields, which allows the appropriate scattering of newly formed particles. The rear protection shield is in the form of a Whipple shield, used to absorb the kinetic energy of impacting objects that had sufficient kinetic energy and passed through the front shield without greater disintegration. The fragments slowed down and captured in this way are stored inside the device, and the subsequent transfer is allowed.

4.2.2 Elimination

After a successful capture of the space debris, the capture device adjusts its orbit and guides itself to an atmospheric re-entry trajectory. It will then evaporate together with the captured material in the Earth's atmosphere. However, the impacted particles can damage crucial subsystems, such as the power source, propulsion, stabilization, communication, or navigation systems. If something similar happens, the device could not deorbit, and it would thus become additional space debris. For this reason, the device must be designed to minimize its service life in orbit. In the event of the capturing satellite dysfunction, it would be possible to use an additional satellite to guide it to the re-entry.

4.2.3 Level of Risk

However, it is necessary to keep in mind the possibility of massive damage to the capturing satellite due to the impacting space debris. In such a case, the effect would be just the opposite, and instead of reducing the amount of space debris, further fragmentation would occur. It is, therefore, necessary to determine the degree of risk and compare it with the probability of successful capture and subsequent elimination of the space debris. To define the degree of risk, it is necessary to know the total device's mass, dimensions, the ability to absorb the kinetic energy of the impacting objects and compare these parameters with the classification of the newly created space debris fragments.

4.3 Construction of the Interception Satellite

The fundamental requirement for the active space debris removal satellite's construction is to balance its transportability into orbit and the active surface used to capture space debris. In terms of transport, the satellite needs to be as compact as possible and have a tolerable mass. However, in orbit, the satellite must have the largest active surface area possible and simultaneously have a solid structure. These requirements directly determine the main feature of the satellite, which is its unfolding ability after transport into orbit.

For design reasons, the entire satellite will be in the shape of a cylinder, both in its folded and unfolded state. The satellite must necessarily consist of a central body, which will contain all the essential subsystems such as the communication systems, the energy subsystem, the navigation and stabilization system, or the propulsion system. This central body, which is the most crucial part of the whole object, needs to be protected from any impacting space objects. In the direction of movement, the central body will be protected by the front main shield, with the structure of a multi-shock Whipple shield. On the other end of the body, it will not be necessary to protect the internal systems in such a way. Therefore, the rear part can be used for a propulsion system or as cargo space for other equipment related to a specific mission. The capture satellite also includes folding front and rear shields, which in the folded state surround the entire central body. The front shields are attached to the front main shield and the rear set of shields to the body's end.

For the entire satellite's structure reinforcement, it will be necessary to connect the front and rear shields using supporting beam elements. At the same time, the outer satellite's cover will be attached to these support elements. This cover will serve as insulation from the surrounding environment and protection against the penetration of smaller objects into the inner space. It will also prevent the scattering of trapped fragments into the surroundings. The conceptual design of the satellite shows the Figure 20.

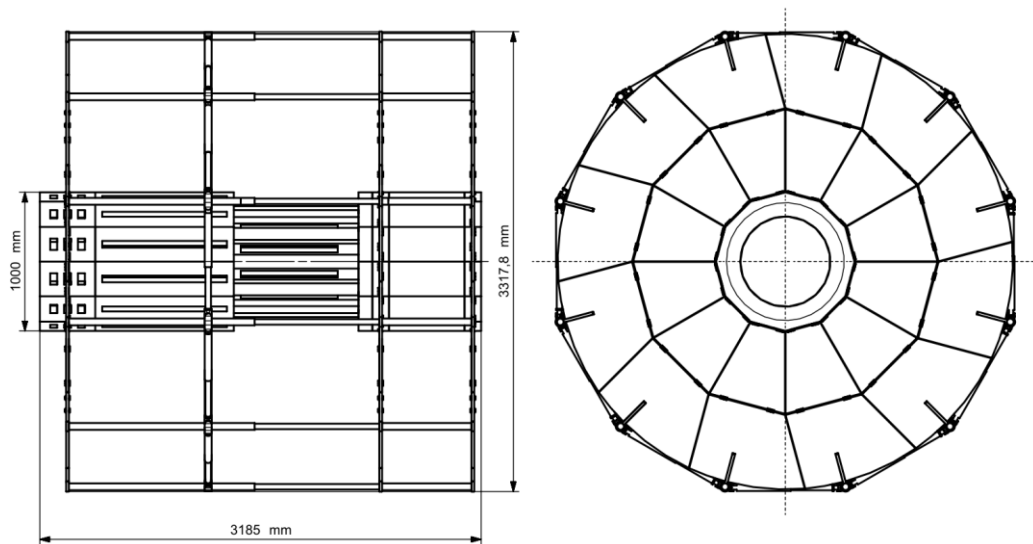

Figure 20: The satellite's conceptual design

The satellite's main body will need to be extendable in some way. The reason is the need for the compactness of the satellite in its transport to orbit. After the satellite reaches its desired orbit, its main body extends. The distance between the front and rear parts of the satellite increases together with the fragment's scattering rate, which improves the capture ability. The conceptual design of the satellite's main body shows Figure 21.

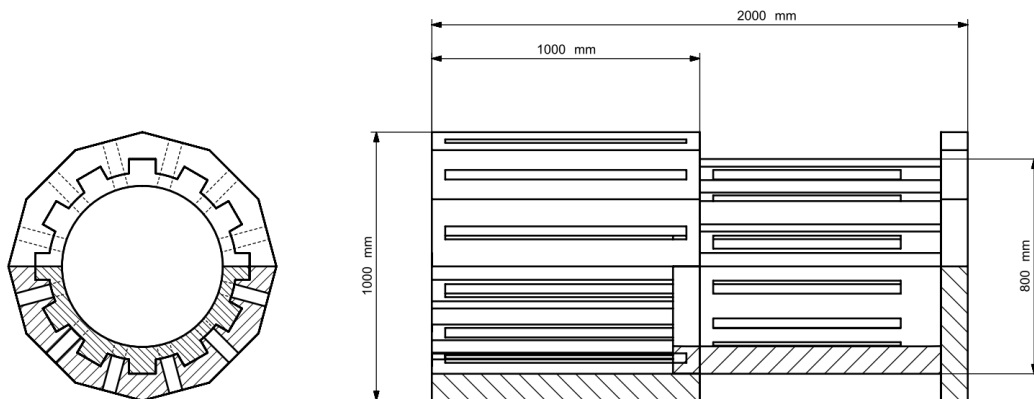

Figure 21: Front and side view of the satellite's main extension body with basic dimensions

4.4 Shields

The essential part of the satellite will be the folding front and rear shields. Their structure varies depending on their location, whether they are at the front or the rear side. All parameters of this passive protection, including its attaching and the principle of unfolding, describes the following subchapters.

4.4.1 Geometry

Whether it is front or rear shields, the appropriate geometry must be selected first. The main objective is the unfolding ability and the largest active area. A crucial part is the front main shield, on which other shields attach and which protects essential satellite subsystems.

Due to structural reasons and the need for unfolding, the cylindrical shape on which the other shields attach is problematic. For this reason, the geometry choose was the dodecagon shape of the front main shield. The dodecagon shape provides twelve surfaces on which the other shields can be attached. The design of the front main shield will be a massive multilayer Whipple shield due to its greatest possible effect of absorbing the impact kinetic energy. The conceptual design of the front main shield shows Figure 22.

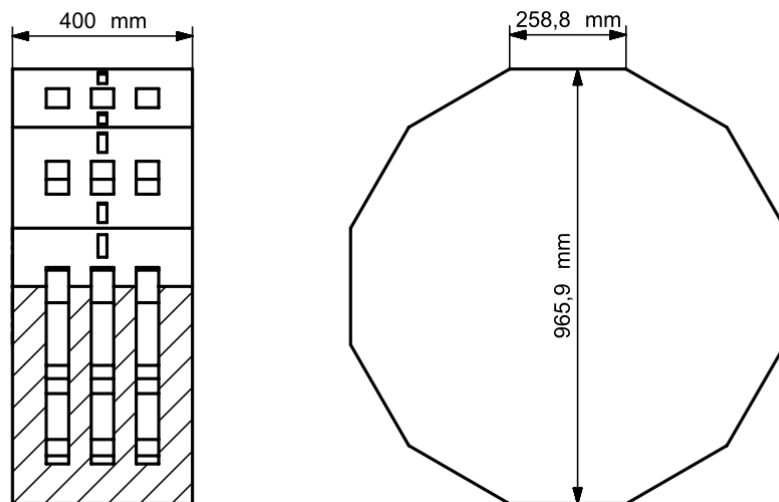

Figure 22: Front main shield's conceptual design

The front and rear shields will have to consist of at least two sub-segments due to the possibility of unfolding while maintaining the largest possible area in the unfolded state. The inner shields will be directly attached to the front main shield (in the case of front shields) and the rear main part of the satellite (in the case of both rear shields). The rear main part will also have a dodecagon shape. For the geometry of the inner shields, the choice of an isosceles trapezoid shape has been made. The reason is simply the large active area in a fully unfolded state. The outer row of shields will also have a trapezoidal shape but no longer equilateral. Those shields will also be rounded at their outer line. The reason for the change is the need for the successful folding of those shields so that the individual parts do not touch each other. This combination of geometry ensures no accidents during unfolding and suffice the need to maintain the largest possible active area. The outer row of shields will also have a gap in its upper part for the beam holders connecting the front and rear shields. The geometry of the inner and outer row of shields shows the Figure 23.

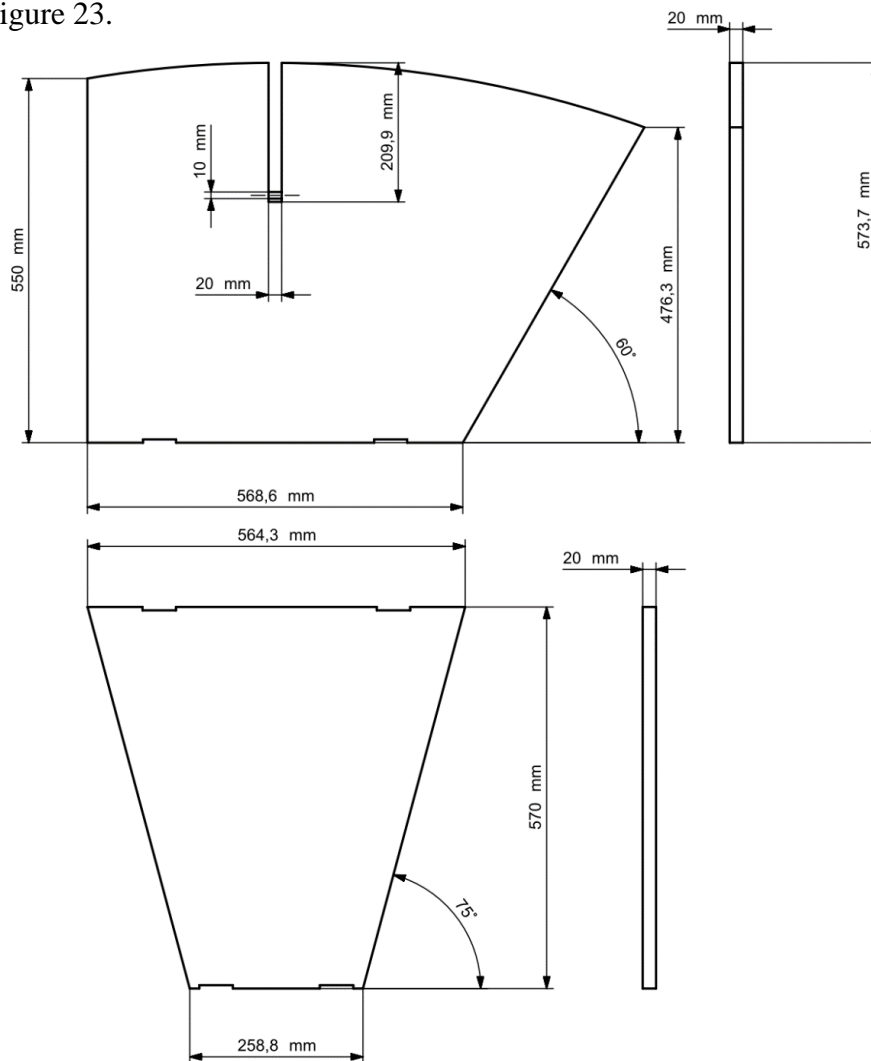

Figure 23: The inner (lower) and outer (upper) shield's conceptual design

4.4.2 Folding Principle

For the unfolding of the entire system, it is first necessary to fold the individual shields properly. Increasing the overall diameter in the unfolded state also increases the dimensions of individual shield parts. Therefore, the difficulty of a suitable design solution for the shield's composition also increases. After the shield dimensions suitable selection while maintaining the requirement for the largest possible active area after unfolding, these shields can perform the unfolding sequence in the form of two-way directions. Of the total number of 12 shield assemblies, half will be folded in the satellite's movement direction and the other half in the opposite direction. The angle of rotation depends on the shield type, and the overall diameter in the folded state is as small as possible.

Depending on the direction of the inner row of shields folding, the outer shields rotate by 180° , and in the folded state, they are always facing the outer side. Due to the necessary connection of the front and rear shields using the main beams, the individual assemblies of the inner and outer rows of front and rear shields will have to fold in the same direction.

The rear main part, to which the pair of rear shields attaches, will be necessarily telescopic due to the possible shield's unfolding and fulfilling the principal function after the unfolding sequence. The construction of the satellite's rear part shows Figure 24, and the visualization of the shield composition shows Figure 25.

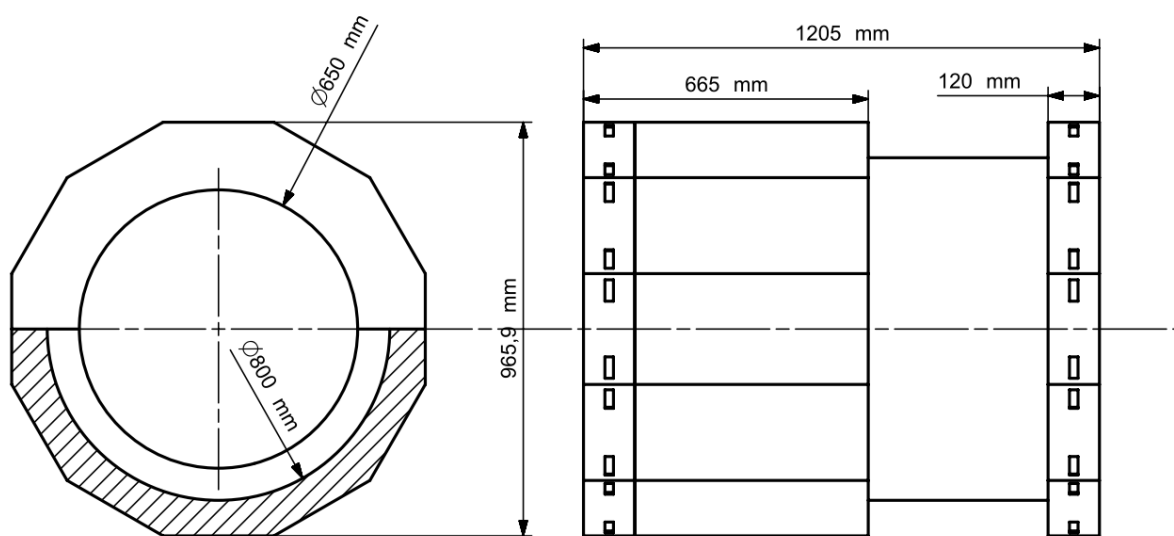

Figure 24: Conceptual design of the satellite's rear part

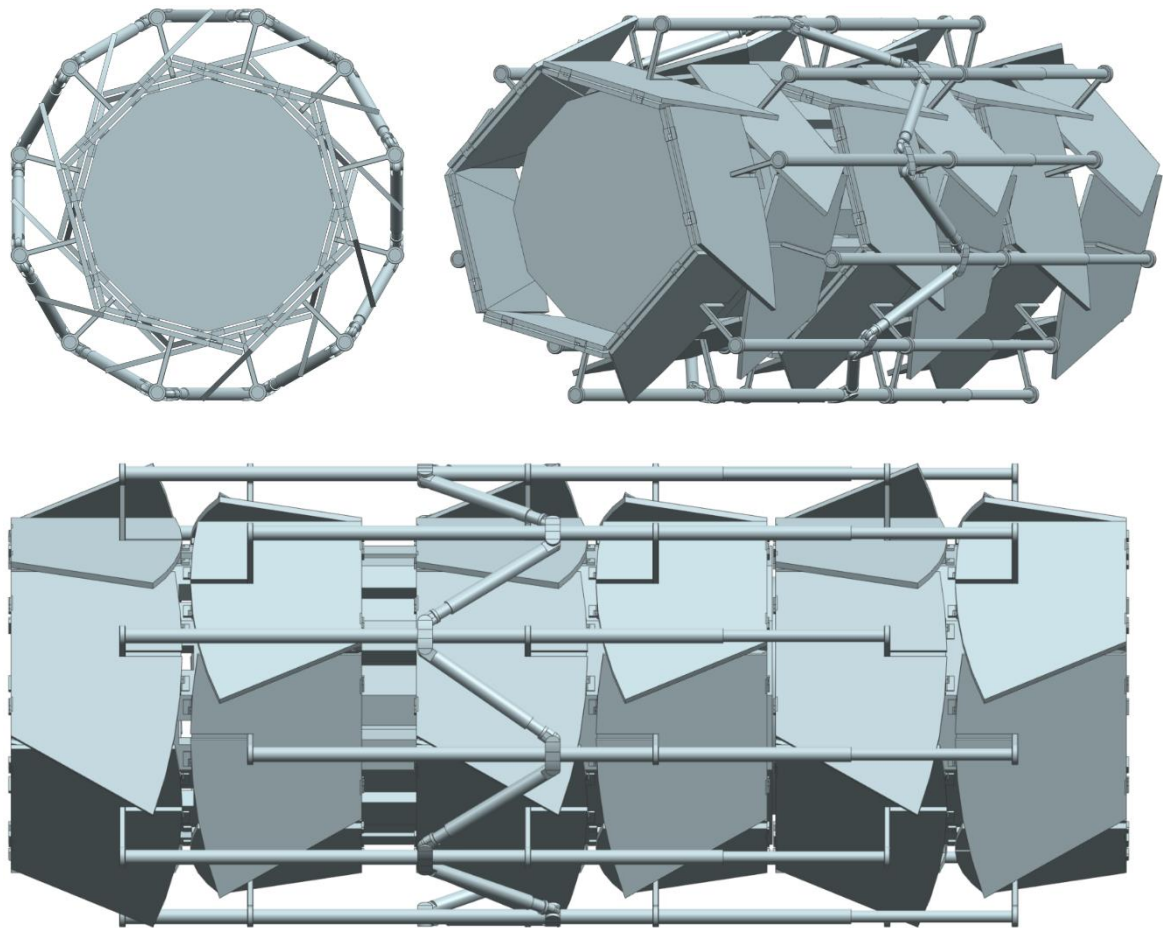

Figure 25: Conceptual design of a satellite in its folded state

4.4.3 Front Shield

Whether it is an inner or outer row of shields, the individual segments will always have the same structure. The design of the front shields will focus on capturing tiny fragments of space debris. The larger objects will evaporate or shatter and subsequently pass through the front shield and enter the satellite's interior. This structure will be in the form of a Stuffed Whipple shield, as it is a very effective structure for dissipating the kinetic energy of impacting objects. For front shields, the following combination of materials has been chosen, and the overall assembly shows the Figure 26:

1. **Aerogel** – The aerogel has a very low density and high porosity. For this reason, it has outstanding potential in capturing miniature objects moving with very high velocities. The aerogel also serves as an insulating material due to its properties.

If the aerogel layer is exposed to the direct impact of space debris, it can capture microscopic particles. [24]

2. **Aluminium alloy (Bumper)** – As another layer, a thin plate made of aluminium alloy, otherwise called Bumper, will be used. The primary purpose of this plate is to evaporate the impacting projectile and subsequently scatter it into other areas of the shield. [17] [23]
3. **Nextel** – At a certain distance from the Bumper is a pair of textile layers. One of these layers is the Nextel, specifically the Nextel AF-10. It is a continuous filament ceramic oxide fibre folded in individual layers, having excellent anti-penetration properties and acceptable material density. [23]
4. **Kevlar** – The second textile layer will be Kevlar, specifically Kevlar KM2-705. It is a substance used mainly for its stopping effects of various types of projectiles and its low material density. [17] [23]
5. **Aluminium alloy (Rear wall)** – The last layer of the front shield will again be an aluminium alloy plate, having the same purpose as the previous one. Behind this backplate, there is no other layer, and the projectiles, that pass through this plate, are scattered over, and proceed to the rear pair of shields. [17] [23]

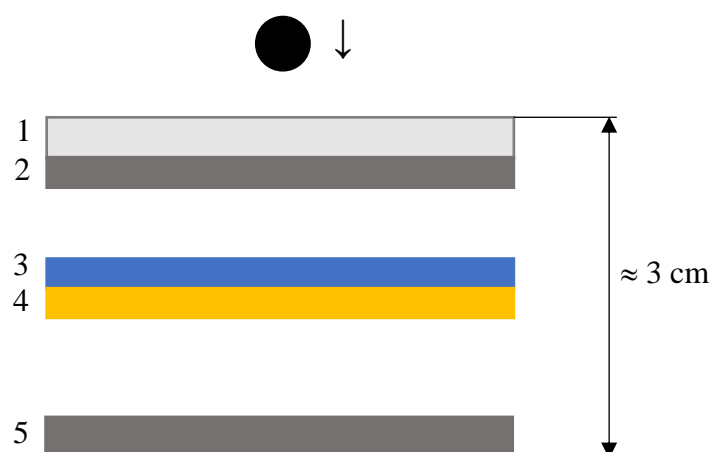

Figure 26: Possible structure of the front shield in the form of a Stuffed Whipple shield [17] [23]

4.4.4 Rear Shield

The essential function of the rear shield is to capture those projectiles that had enough energy to pass through the front shield. Therefore, the rear pair of shields must be suitably designed to capture objects moving with very high velocities and having enormous kinetic energy. For this reason, the pair of shields, which are at a close distance from each other, will serve as a macroscopic Whipple shield.

This pair of shields designed as a classic Whipple shield will have different first and second-part structures. The front part is again the Stuffed Whipple shield structure. The second part structure is a classical Whipple shield, used for its maximum stopping effect. The material composition of the first part will be the same as in the case of the front shields. However, the aerogel layer will no longer be required. As for the second part, it will be composed of two aluminium alloy plates sufficiently distanced apart. [17]

If a projectile pass through the first part of the rear pair of shields, it will continue into space between them. That allows its scattering onto a larger surface area and dissipates its kinetic energy. The last way to prevent the projectile from leaving the satellite will be the second part of the rear pair of shields. It is necessary to sufficiently stop both scattered particles from the first part and larger pieces of those projectiles. For this reason, the structure of the classic Whipple shield is chosen for its maximum stopping effect.

4.4.5 Shields and Beams Mounting

To perform the unfolding sequence, the shields need to be attached first. Because of the individual shields tilting ability, it will be necessary to have at least two rotational links on each shield. With this connection, they can perform a 90° rotational movement in the case of the inner row and a 180° rotational movement in the case of the outer row of shields. This rotational movement will thus ensure the hinges. It connects the inner row of shields to the satellite's body and the outer shields to the inner ones.

After the satellite's transportation into orbit, it unfolds and remains in this condition throughout its entire mission. Therefore, there is no need for exceptional lubrication of the rotational components, but it needs to be sufficiently reliable. The operation principle of these hinges will be purely mechanical, without the need for long-

lasting lubrication. The hinges can be passive, without any driving force, or have a folding function. Those hinges with driving forces would be the main driving members of the whole mechanism unfolding sequence.

The main beams connecting the front and rear shields will have to be necessarily telescopic. It is due to the retractable properties of the satellite's main body and its rear part. These beams will be anchored to each group of shields and thus reinforce the entire structure. Anchoring of the beams to the outer row of shields will ensure clamps, rotationally connected to those shields. This clamp can move freely so the beams can be in the same position with both the unfolded and folded state of the satellite.

For ensuring the satellite's folded state, the principle of printed magnetic locks can be used. These magnets work on the principle of polarized material printing into a suitable shape. In the case of printed magnetic locks, it is possible to create components capable of both attractive and repulsive forces based only on their axis rotation. Visualization of magnetic field lines of this type of printed magnetic lock shows Figure 27.

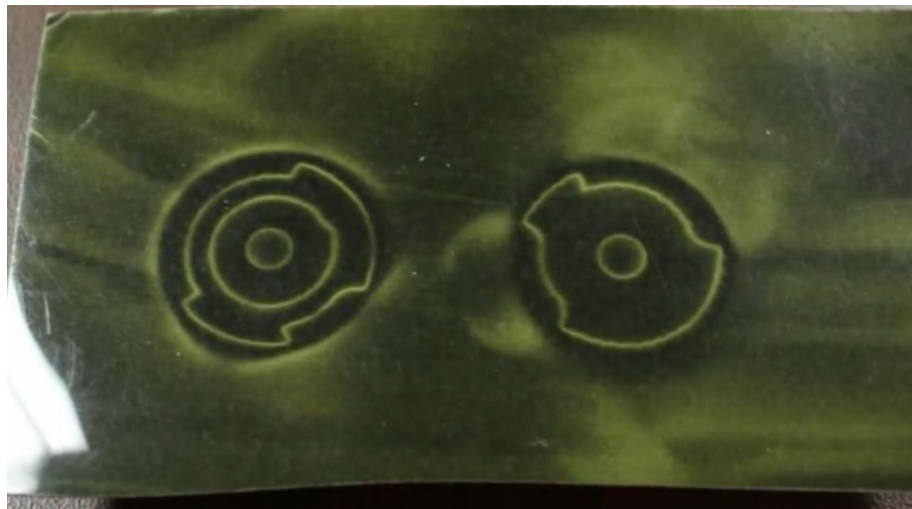

Figure 27: Magnetic field lines of two halves of printed magnetic locks from CMR Polymagnet [25]

4.4.6 Unfolding Mechanism

For shield's unfolding sequence can be used several different unfolding principles. The first solution is a telescopic beam, which would be anchored directly to the satellite's body, and it would elevate the main beams connecting the front and rear shields. Another solution is a scissor mechanism, which would also elevate the main beams and thus unfold the front and rear shields.

Another possibility is a drive mechanism of the individual shield's hinges, which would start its sequence on all hinges at once. However, the unfolding's speed would depend on the hinge's actual position, whether they are anchoring the inner or outer row of shields. This principle requires very high accuracy of the unfolding mechanism and its interaction. For example, if one panel unfolds at a different speed than the other panel at its side, they could come into contact and cause the device to malfunction.

The last option is to unfold the whole system using centrifugal forces. This force erases during the rotational movement of the satellite's main body. In such a case, the stabilization systems on the satellite's circumference would be required. The satellite would first spin in its folded state around its main axis, and after reaching a certain angular velocity, it releases the panels. Due to the centrifugal force acting mainly on the main beams, all shields would be symmetrically unfolded. After the entire system unfolds, the rotational movement would be slowed down using the stabilization systems. However, this movement can also be used for its automatic stabilization characteristic.

The ideal unfolding mechanism principle could be a combination of some of the above solutions so that the act is as efficient and sufficiently reliable as possible. This problem would need deeper analysis and is therefore outlined here only as principled possibilities.

4.5 Propulsion and Stabilization Subsystems

One of the essential satellite elements is its propulsion and stabilization subsystem. For the orientation and stabilization system will be used the principle of reaction wheels due to the precise stabilization ability and low energy consumption. The reaction wheels consist of at least three wheels for three-axis stabilization. However, a combination of four reaction wheels is used due to the reasons for redundancy. The reaction wheels operate on transmitting torque force by changing their rotational speed about one axis. This force makes the entire satellite move in the opposite direction of the reaction wheel's action. The energy source of the reaction wheels is an electric current, which is used in an electric motor creating a rotary motion. A possible design solution for the reaction wheels composition shows Figure 28. [27]

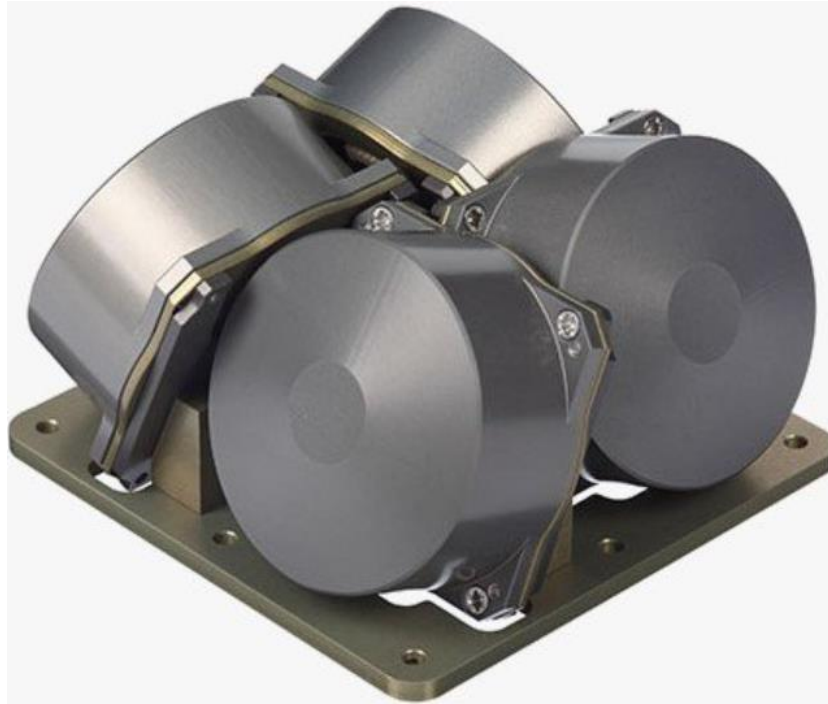

Figure 28: Example of four reaction wheels in tetrahedral configuration [28]

In addition to the reaction wheels, it will also be necessary to use propulsion stabilization on the satellite's outer side. These propulsion systems will be used to orient the entire satellite or to rotate it in the case of automatic stabilization or unfolding. The propellant type of the propulsion systems depends on the space mission objective. However, the stabilization system will be mainly based on cold gas thrusters due to their high reliability and versatility.

The satellite's central propulsion system could be in the form of solid rocket engines or an ion thruster. However, the use of a central propulsion system will again depend on the space mission objective and the need for transferring and keeping the satellite in orbit.

4.6 Outer Cover

For the satellite interior isolation from the surrounding space environment, it will be necessary to create a protective cover of the entire satellite's construction. This cover will have an insulating function, which will prevent overheating of the satellite's interior. Moreover, it will also serve as protection for trapped fragments. This function is essential

because all particles and fragments captured or scattered over the satellite's interior need to remain inside to be subsequently transferred out of their orbit.

The outer cover will face direct contact with the surrounding environment, and especially with space debris. An essential cover feature is its ability to partially absorb the kinetic energy of impacting projectiles, whether from the external or internal direction. The cover's material must be necessarily flexible due to the satellite's mechanism unfolding sequence. The material could be, for example, the previously mentioned Kevlar fabric. It is due to its extraordinary anti-penetrable effect with acceptable density. It also meets the flexibility required for the satellite's unfolding sequence.

The outer cover surface can be used for purposes of power generation to supply the entire satellite. This objective could be achieved by applying flexible photovoltaic panels or photovoltaic foils situated on the outer cover surface. It would ensure a sufficient supply of electricity and reinforcement.

4.7 Energy Subsystem

The essential satellite subsystem is the energy subsystem, which must be designed to operate throughout the entire mission and supply energy to the other subsystems. Flexible photovoltaic panels or photovoltaic foils on the outer cover surface and the rear shield's surface would be used as the energy source. The photovoltaic panels on front shields can be equipped as well, but due to the high concentration of impacting space debris, their efficiency would be rapidly decreased. Electricity from solar cells would be used for all necessary subsystems, especially for stabilization, communication, and propulsion systems.

However, the satellite will not be in the constant presence of sunlight. When orbiting on the dark side, photovoltaic cells would not be able to generate enough power for the required subsystems. For this reason, the satellite must be necessarily equipped with accumulators, which are used as a secondary source of electricity during the dark side orbiting. Therefore, part of the electrical energy generated from the solar cells is continually stored in the accumulators.

4.8 Possible Objectives of the Mission

As previously mentioned, the configuration of a satellite depends directly on the objectives of its mission. The satellite is primarily designed to capture a large amount of smaller space debris, but it can also serve in the form of a "watchdog" of some principal space objects. The following subchapters outline the possibilities of the satellite's missions.

4.8.1 Space Debris Capturing After an Orbital Collision or Explosion Event

There have been several critical and unplanned collisions of two objects in orbit in history. Other events were, for example, uncontrolled explosions of non-functional space objects or the intentional satellite's destruction using ballistic missiles. Regardless of the space debris origin, there is always an enormous increase in the total number of fragments, which increases the likelihood of the Kessler's syndrome effect. From the beginning of the space debris creation, the initially directed stream of fragments begins to disperse quickly into various orbits due to perturbations. However, if this dispersion could be stopped at the very beginning and most of the newly created space debris would be captured, the disaster would be avoided.

The satellite designed in this thesis serves the purpose of the newly created space debris rapid mitigation after a severe orbital collision or explosion. Therefore, if a similar incident occurs, this satellite would be sent into the desired orbit of the space debris mainstream. The satellite would subsequently capture as much space debris as possible and then re-enter the atmosphere.

An extension of this method would be the use of CubeSat-type observation satellites, which would be evenly distributed on the orbit and serve to inform the central satellite in time about the development of the space debris stream. Based on this observation data, the satellite could subsequently adjust its trajectory to make the most probable contact with the fragments stream.

4.8.2 Active Protection of Principal Space Technology

If there is a risk of collision between any active space satellite with another non-functional object or fragment, the satellite must perform an evasive maneuver to avoid the collision. However, some satellites are incapable of these maneuvers and are thus vulnerable to any incoming object. In such a case, the satellite design in this thesis could act as an active shield for a predefined orbital collision. Therefore, all the kinetic energy of an impacting object would be absorbed by this protective satellite. Of course, this principle can also be used as a preventive measure for other space objects that are capable of evasive maneuvers.

4.9 ESA DRAMA Software

The ESA DRAMA (Debris Risk Assessment and Mitigation Analysis) software was used to evaluate the controlled re-entry of the satellite at the end of its mission. It is a comprehensive tool used to determine the fundamental characteristics of the space mission course. The DRAMA software includes the following evaluation tools:

1. ARES – A tool that calculates statistics related to collision events of an active space object with catalogued space debris. [27]
2. MIDAS – Evaluates the impacts and damage consequences of active space objects impacted by catalogued space debris. [27]
3. OSCAR – It is a tool used to determine the appropriate strategy for disposing of an active space object at the end of its life. [27]
4. CROC – It is used to calculate the cross-sectional area characteristics of predetermined models based on the body's orientation in space. [27]
5. SARA – This software consists of a total of three computational tools. The first calculates the trajectory and aerothermodynamic characteristics during the controlled and uncontrolled re-entry. The second tool is software used to determine the risk degree of an Earth's surface impact accident. The last

computational tool is the Monte Carlo system, which allows variations of parameters or definitions of the impact zone. [27]

For this diploma thesis, the SARA tool will be used to determine the re-entry dynamics of the satellite in its unfolded state. The input calculation data are the parameters of the satellite's orbit, the geometry of the returning object, and the material composition. However, the material composition has been simplified due to the device's complexity. The result of the re-entry dynamics calculation is the time dependence on the descending body's altitude shown in Figure 29. From this dependency, it is evident that the satellite's extinction will occur at approximately 80 km above the Earth's surface. However, this result is only indicative, and a much more detailed analysis is needed due to the variety of materials and the presence of trapped space debris inside the satellite.

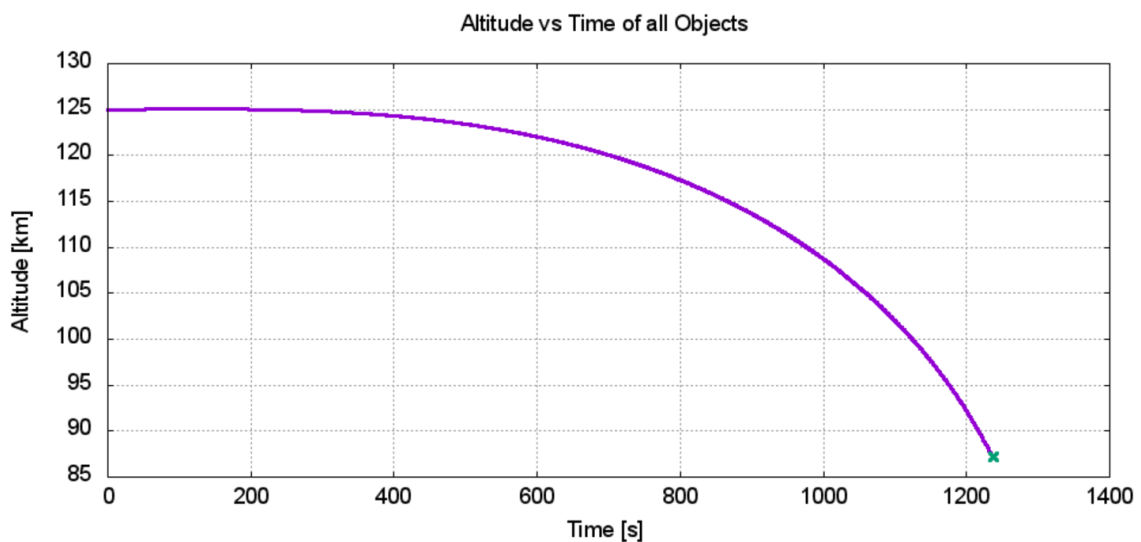

Figure 29: Time dependence of the descending re-entry object on its altitude

4.10 Project Evaluation and its Feasibility

The conceptual design of the active space debris removal system proposed in this diploma thesis needs a much deeper analysis of its subsystems but provides the potential for a successful active solution to the space debris problem. In the case of its implementation, it would be necessary to follow the established standards, preferably the ECSS standards, concerning both engineering specifications such as structural,

mechanical, or material requirements, as well as specifications of active sustainability and management.

The main goal of this project is to design a suitable device that would fulfil as effectively as possible the purpose of space debris elimination, but at the same time should not produce any other itself, or in the worst case, become it. An important aspect is the minimization of the proposed device dimensions due to the necessary transport to orbit and maximize its dimensions after reaching its desired location.

At the end of its mission, the satellite must be able to guide itself into the descent re-entry orbit so that it can completely disappear. At the same time, it should not pose any risk in the form of falling fragments on the earth's surface. If the satellite is unable to perform this final maneuver, its lifespan needs to be reduced as much as possible. The satellite should be therefore equipped with at least one of the deorbiting devices, increasing the overall aerodynamic friction coefficient.

The conceptual design result is the construction model of the whole satellite and its essential subsystems. The structure model visualization shows Figure 30. The satellite's unfolding sequence without its outer cover shows Figure 31.

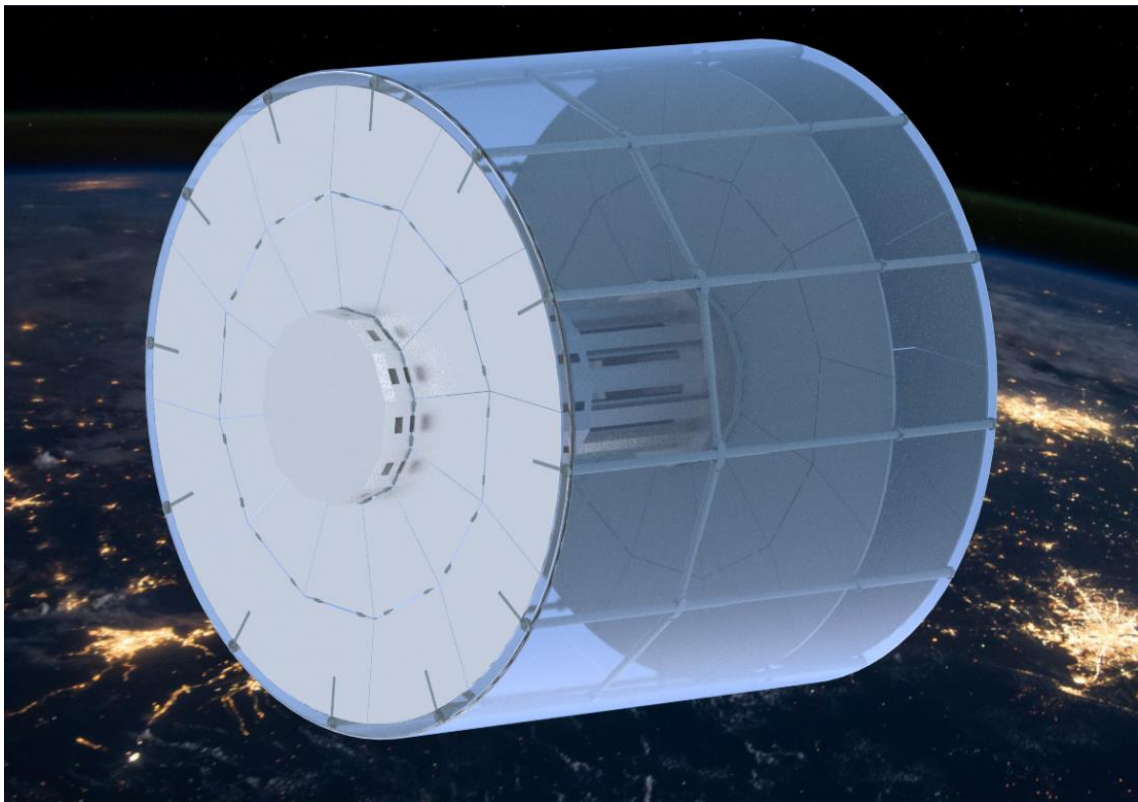

Figure 30: Model of the satellite with its outer cover in its unfolded state

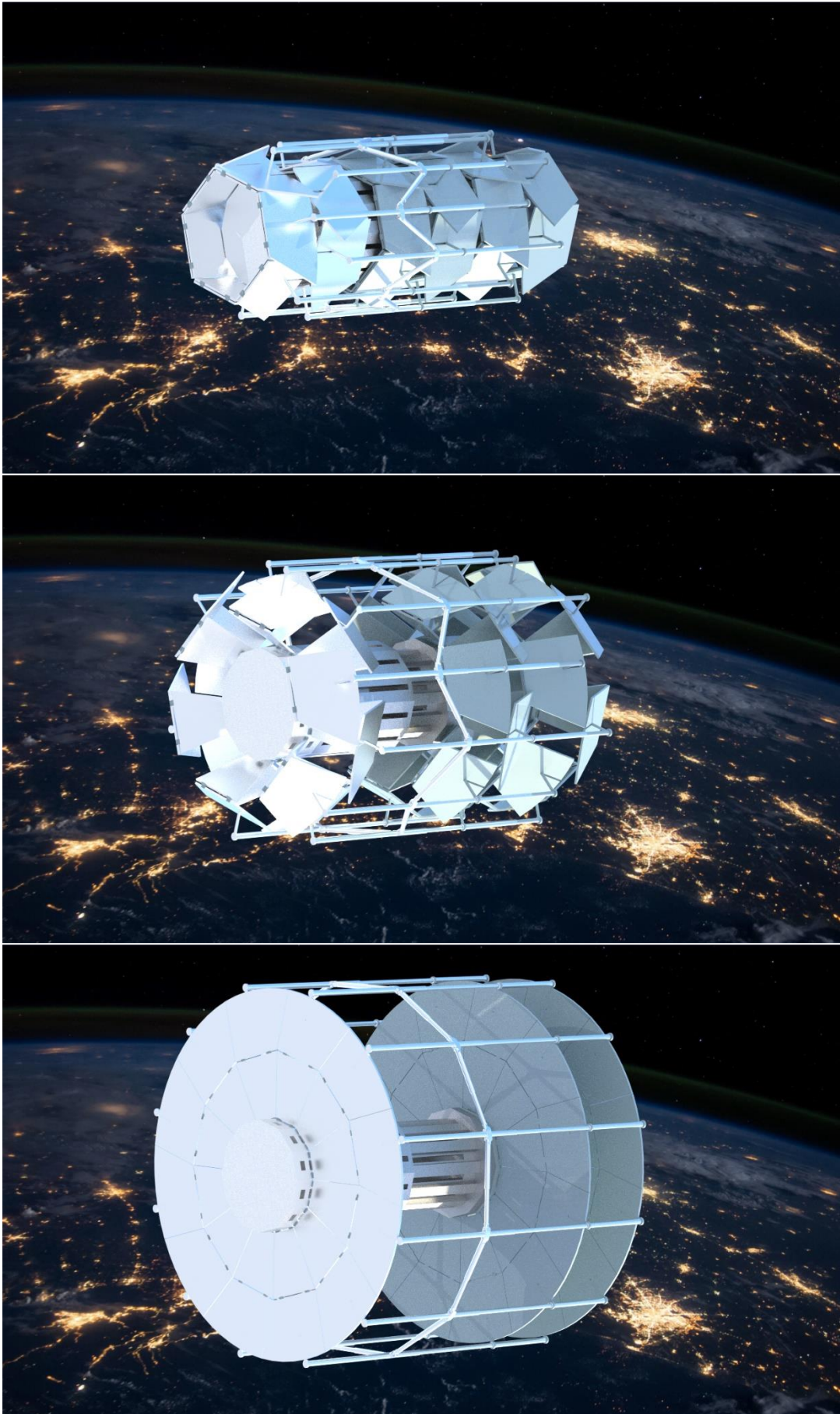

Figure 31: Satellite structure unfolding sequence

5 Conclusion

This diploma thesis focuses on the design of an active space debris removal system. The thesis aimed to find a solution for the active removal of space debris created after an orbital collision or explosion event. After studying the problematics of outer space, the laws of celestial mechanics, the motion of space debris, and existing projects dealing with this topic, the appropriate device in the form of a satellite was designed. The proposed design can effectively reduce the newly created space debris at relatively low production and operating costs. The individual device subsystems are gradually analysed, and the possibilities for ongoing research are outlined.

Z Furthermore, the satellite can be used in the form of an active shield, protecting crucial space technology. This approach is unique and has immense potential for further research activities. The very conceptual basis of the satellite is based on the use of several sets of unfolding shields. Their structure and distances are themselves the subject of further research. As part of the satellite's design, the principle of folding the individual shield segments was also invented, which is needed mainly due to the necessary compactness during transport. All models were created in the NX Siemens software and are in the attachment of this diploma thesis. The ESA DRAMA software was used to validate the results, containing computational software used for basic characterizations of the space mission.

With the development of cosmonautics and its gradual integration into ordinary human life, the increasing amount of space debris poses a serious problem threatening the future of space missions. Thus, humanity is currently facing a potential threat, in the form of the prevention of space flights and the use of space technology for many generations. For preventing this so-called Kessler's syndrome phenomena, the cooperation of all organs involved in space exploration is needed. People can achieve huge things, but they seldom look at their consequences. The way we treat our planet and the space around it will be our legacy for future generations. Let us make it better.

List of Figures

Figure 1: Two-body problem in an inertial frame of reference [3]	8
Figure 2: Conic sections depending on their eccentricities [1].....	10
Figure 3: Parameters of the orbit equation [3].....	11
Figure 4: Elliptical orbit geometry [1].....	14
Figure 5: Evolution of the total number (a) and total mass (b) of space debris on different types of orbits [9].....	21
Figure 6: Evolution of the total number (a) and total mass (b) of space debris objects depending on their category [9]	23
Figure 7: The number of in-orbit fragmentation events divided by their causes [9].....	25
Figure 8: Total number of objects in LEO depending on their size and devices used for their observation [14].....	27
Figure 9: NASA Break-up model [7]	28
Figure 10: Time dependence of the orbiting fragments created during the explosion of the upper stage of the Ariane-1 H-10 launch vehicle [7].....	30
Figure 11: Gabbard diagram of space debris fragments, created from the upper stage explosion of the Zenit launch vehicle in 1993 [7]	31
Figure 12: The number of firings of solid propellant rocket engines in history depending on the orbits [9].....	32
Figure 13: The total mass of released NaK alloy particles depending on their size compared to their time dependence [7].....	33
Figure 14: The principle of Whipple shield [17]	37
Figure 15: Deutsche Orbitale Servicing Mission [19].....	41
Figure 16: Electro Dynamic Debris Eliminator [20]	43
Figure 17: LEOSWEEP Project [21]	43

Figure 18: RemoveDEBRIS [22].....	44
Figure 19: The active space debris removal system conceptual design	446
Figure 20: The satellite's conceptual design	49
Figure 21: Front and side view of the satellite's main extension body with basic dimensions	49
Figure 22: Front main shield's conceptual design.....	50
Figure 23: The inner (lower) and outer (upper) shield's conceptual design	51
Figure 24: Conceptual design of the satellite's rear part.....	52
Figure 25: Conceptual design of a satellite in its folded state	53
Figure 26: Possible structure of the front shield in the form of a Stuffed Whipple shield [17] [23]	54
Figure 27: Magnetic field lines of two halves of printed magnetic locks from CMR Polymagnet [25].....	56
Figure 28: Example of four reaction wheels in tetrahedral configuration [28]	58
Figure 29: Time dependence of the descending re-entry object on its altitude	62
Figure 30: Model of the satellite with its outer cover in its unfolded state	63
Figure 31: Satellite structure unfolding sequence	64

List of Tables

Table 1: Space debris classification [9].....	22
Table 2: Classes of the break-up cause [9]	24

Sources

- [1] Macdonald, M., & Badescu, V. (2014). *The International Handbook of Space Technology (Springer Praxis Books)*. Springer. <https://doi.org/10.1007/978-3-642-41101-4>
- [2] Chobotov, V. A. (2002). *Orbital Mechanics*. American Institute of Aeronautics and Astronautics. <https://doi.org/10.2514/4.862250>
- [3] Curtis Ph.D. Purdue University, Howard D. (2005). *Orbital Mechanics: For Engineering Students (Aerospace Engineering) (1st ed.)*. Butterworth-Heinemann.
- [4] Pisacane, V. L. (2008). *The Space Environment and Its Effects on Space Systems (Aiaa Education Series)*. American Institute of Aeronautics & Astronautics. <https://doi.org/10.2514/4.862533>
- [5] Pisacane, V. L. (2005). *Fundamentals of Space Systems (2nd ed.)*. Oxford University Press.
- [6] *Types of orbits*. (2020, March 30). The European Space Agency. https://www.esa.int/Enabling_Support/Space_Transportation/Types_of_orbits
- [7] Klinkrad, H. (2006). *Space Debris*. Springer Publishing. <https://doi.org/10.1007/3-540-37674-7>
- [8] Kessler, D. J. (2002). *Collisional cascading: The limits of population growth in low earth orbit*. NASA/Johnson Space Center. [https://doi.org/10.1016/0273-1177\(91\)90543-S](https://doi.org/10.1016/0273-1177(91)90543-S)
- [9] *ESA's Annual Space Environment Report (4.0)*. (2020, September). ESA Space Debris Office.
- [10] Celletti, A., Locatelli, U., Ruggeri, T., & Strickland, E. (2014). *Mathematical Models and Methods for Planet Earth (Springer INdAM Series Book 6)*. Springer. <https://doi.org/10.1007/978-3-319-02657-2>
- [11] Flegel, S. K., Stabroth, S., Wiedemann, C., Klinkrad, H., Krag, H., & Vörsmann, P. (2008, January). *Analysis of the fragmentation debris environment between 2005 and 2008*.

https://www.researchgate.net/publication/252821938_Analysis_of_the_fragmentation_debris_environment_between_2005_and_2008

[12] Oteng-Amoako, Kingsley. (2016). Space Surveillance Networks. <https://doi.org/10.13140/RG.2.1.1429.8481>.

[13] Pelton, J. N. (2015). *New Solutions for the Space Debris Problem (SpringerBriefs in Space Development)*. Springer. <https://doi.org/10.1007/978-3-319-17151-7>

[14] National Research Council, Sciences, D. E. P., Commission on Engineering and Technical Systems, Debris, C. S., Council, N. R., & Systems, C. E. T. (1995). *Orbital Debris*. Amsterdam University Press. <https://doi.org/10.17226/4765>

[15] Space systems and operations 2019, *Space debris mitigation requirements ISO 24113:2019* (3rd ed.)

[16] *ESA Space Debris Mitigation Compliance Verification Guidelines*. (2015, February). ESA Space Debris Mitigation WG.

[17] NASA. (2003, August). *Meteoroid & Orbital Debris Shielding*. <https://ntrs.nasa.gov/citations/20030068423>

[18] European Cooperation for Space Standardization. (2019, December). *ECSS-U-AS-10C Rev.1 – Adoption Notice of ISO 24113: Space systems – Space debris mitigation requirements*. <https://ecss.nl/standard/ecss-u-as-10c-adoption-notice-of-iso-24113-space-systems-space-debris-mitigation-requirements-2/>

[19] Roa, Maximo A. (2019). *From Ground to Space-Based Robotic Assembly*.

[20] Pearson, J., Levin, E., Oldson, J., & Carroll, J. (2010, September). *ElectroDynamic Debris Eliminator (EDDE): Design, Operation, and Ground Support*. <https://www.amostech.com/TechnicalPapers/2010/Posters/Levin.pdf>

[21] LEOSWEEP - LEOSWEEP Home page. (2013). LEOSWEEP. <https://leosweep.upm.es/en/>

[22] RemoveDEBRIS mission | University of Surrey. (2017). University of Surrey. <https://www.surrey.ac.uk/surrey-space-centre/missions/removedebris>

- [23] Hofmann, D. C., Hamill, L., Christiansen, E., & Nutt, S. (2015, February). *Hypervelocity Impact Testing of a Metallic Glass-Stuffed Whipple Shield*. <https://doi.org/10.1002/adem.201400518>
- [24] Jones, S.M. Aerogel: Space exploration applications. *J Sol-Gel Sci Technol* 40, 351–357 (2006). <https://doi.org/10.1007/s10971-006-7762-7>
- [25] *3D Printing Magnetic Fields Is Now Possible With Polymagnet's Maxels*. (2016, March 24). 3D Printing Media Network. <https://www.3dprintingmedia.network/3d-printing-magnetic-fields-is-now-possible-with-polymagnets-maxels/>
- [26] Ismail, Z., & Varatharajoo, R. (2010). *A study of reaction wheel configurations for a 3-axis satellite attitude control*. *Advances in Space Research: The Official Journal of the Committee on Space Research (COSPAR)*, 45(6), 750–759.
- [27] ESA/ESOC Space Debris Office (OPS-SD). (2020, April). *Debris Risk Assessment and Mitigation Analysis (DRAMA) Software User Manual (Revision 2.3)*. European Space Operations Centre.
- [28] Lavezzi, Giovanni & Grøtte, Mariusz & Ciarcià, Marco. (2019). *Attitude Control Strategies for an Imaging CubeSat*. 10.1109/EIT.2019.8833806.