



City Research Online

City, University of London Institutional Repository

Citation: Alam, N., Nadjai, A., Maraveas, C., Tsavdaridis, K. D. ORCID: 0000-0001-8349-3979 and Kahanji, C. (2019). Effect of air-gap on response of fabricated slim floor beams in fire. *Journal of Structural Fire Engineering*, 10(2), pp. 155-174. doi: 10.1108/JSFE-04-2018-0011

This is the accepted version of the paper.

This version of the publication may differ from the final published version.

Permanent repository link: <https://openaccess.city.ac.uk/id/eprint/27003/>

Link to published version: <http://dx.doi.org/10.1108/JSFE-04-2018-0011>

Copyright: City Research Online aims to make research outputs of City, University of London available to a wider audience. Copyright and Moral Rights remain with the author(s) and/or copyright holders. URLs from City Research Online may be freely distributed and linked to.

Reuse: Copies of full items can be used for personal research or study, educational, or not-for-profit purposes without prior permission or charge. Provided that the authors, title and full bibliographic details are credited, a hyperlink and/or URL is given for the original metadata page and the content is not changed in any way.

City Research Online:

<http://openaccess.city.ac.uk/>

publications@city.ac.uk

Effect of Air-gap on Response of Fabricated Slim Floor Beams in Fire

ABSTRACT

Fabricated slim floor beams are produced by welding a steel plate to the bottom flange of an I-shaped steel section. During their fabrication, an air-gap is induced between the welded steel plate and the bottom flange. Previous studies have shown that the presence of this air-gap has an influence on their thermal behaviour in fire. Though the presence of this air-gap has an influence on their thermal performance, no investigations have yet been conducted to analyse its effects on their structural response. This study investigates the influence of the air-gap on structural response of fabricated slim floor beams in fire. Finite element modelling is performed to predict their response at elevated temperatures which is validated by replicating the experimental data from the literature. A sensitivity study is then conducted using the validated analytical method to study the effects of the air-gap presence and its size on their response in fire. Results obtained show that the presence of the air-gap has a significant influence on their structural response and enhances their fire resistance (in this case by approximately 15%). The size of the air-gap, however, has no significant influence on their structural response in fire. As the presence of the air-gap is found to be helpful and beneficial, findings from this research can be used to develop similar designs for structural members as an efficient and inexpensive way to improve their response in fire.

Keywords; Fabricated slim floor beams, air-gap effect, finite element modelling, fire resistance

1 Introduction

Shallow floor systems gained popularity in Scandinavian countries during the last quarter of the 20th century as they offered numerous advantages over traditional composite beams with down-stand steel sections [1]. Though the art of shallow floor construction has only gained popularity very recently, these floors however, have been in use since the 1790s [2] [3]. During the 19th century, filler joist type of shallow floor construction was frequently used where the cast iron or wrought iron sections were encased in early concrete or masonry [2]. Shallow floor construction was then forgotten and not much attention was paid until the 1970s when Hat beams and Thor beams were introduced in Sweden and its neighbouring countries. These beams were followed by the introduction of the delta beams and the fabricated asymmetric slim floor beams [1]. Impressed by these developments, shallow floor construction was introduced in the United Kingdom (UK) in the 1990s [4]. Since their

introduction, these flooring systems are frequently used by the UK construction industry and distinct designs are introduced over the course of time. Amongst other types of shallow flooring systems, fabricated slim floor beams (FSFBs) are very common in the UK as they are easy to fabricate using existing steel plates and sections [4]. Like other types of shallow floor systems, FSFBs offer various advantages including a flat soffit and a reduced floor and structure height. The flat soffit offers ease of installation for the hydraulic and electric services, while the reduction in floor and structure height, reduces the cost of cladding making the structure more economical [4]. For a specific structure height, FSFBs can accommodate more storeys in comparison with the traditional composite floor beams. FSFB construction uses either the pre-cast concrete units or the composite slab with deep steel decking, hence, it offers a faster method of construction [4]. Concrete surrounding the steel section contributes towards the second moment of area of these beams and helps in reducing the deflections in-service conditions. The most appealing feature of the FSFBs is their partial encasement which keeps the steel sections insulated in fire conditions by protecting them from direct exposure to heat. This insulation helps in maintaining low temperatures on the steel sections, hence, FSFBs like other shallow floor systems, hold an inherent fire resistance of around 60 mins [5] [6] [7]. The concrete encasement imparts a higher temperature gradient across the section keeping the unexposed upper parts at lower temperatures even in longer durations of fire exposure. The encased part of the steel, being at lower temperatures, provides the required strength and stiffness to resist the external loads, hence, these beams offer a higher fire resistance [8] [9].

As the FSFBs are manufactured by welding steel plates and I-shaped steel sections, during their fabrication process, an air-gap is inherently created between the bottom flange and the welded steel plate. Experimental investigations on FSFBs demonstrate that this air-gap, no matter how small it is, has a considerable influence on their thermal behaviour in fire. The test data shows that a temperature difference, as high as 350°C, arises between the bottom flange and the welded steel plate due to the presence of this air-gap [9]. These temperature differences may influence the thermal behaviour and structural response of FSFBs at elevated temperatures. Experimental investigations conducted by Both et al. [10] found that the size of air-gap has negligible influence on the thermal response of these beams. The heat transfer mechanism from the welded steel plate to the bottom flange is mostly through radiation across the air-gap while some heat is also transferred through the welds which bridge these parts together. As the bottom flange remains at a lower temperature in fire conditions, FSFBs

1
2
3 can support external loads for longer durations of fire exposure. In other words, the air-gap
4 between the bottom flange and the welded steel plate protects the steel section from attaining
5 higher temperatures, thus enabling the FSFBs to retain their strength and stiffness by offering
6 a higher fire resistance. This phenomenon, if investigated and analysed extensively, could
7 potentially be useful in enhancing the fire resistance of structural members without the use of
8 conventional fire protection methods and materials.
9
10
11

12 13 14 **2 Aims and objectives**

15 The aim of this study is to investigate the effect of the air-gap on thermal behaviour and
16 structural response of FSFBs in fire. To achieve this, a detailed analytical model is
17 established and validated by replicating the response of FSFBs exhibited during fire tests
18 from literature. The validated finite element modelling (FEM) method is then used to perform
19 sensitivity analysis. First, the influence of the air-gap presence is analysed and later, the
20 effect of the air-gap size on thermal behaviour and structural response of FSFBs at elevated
21 temperatures is investigated.
22
23
24
25
26

27 28 **3 Fire tests on fabricated slim floor beam assemblies**

29 During this study, fire tests conducted on two different FSFB assemblies are selected for the
30 FEM purposes. The first fire test was conducted on a FSFB assembly consisting of a
31 composite slab formed using normal weight concrete and deep steel decking. The second test
32 assembly consisted of a FSFB with precast slab units used as flooring. The purpose of
33 selecting FSFB assemblies with different floor types is to cover both construction practices
34 which are currently used in the UK. In addition, the first experimental investigation addresses
35 mainly the thermal behaviour of FSFBs and analyses any effects of the air-gap presence and
36 its size on their thermal behaviour at elevated temperatures, while the second test investigates
37 both their thermal behaviour and structural response in fire.
38
39
40
41
42
43

44 The first fire test was conducted on March 24, 1995, by the Netherlands Organisation for
45 Applied Scientific Research (TNO) [10] [11] on an assembly consisting of a FSFB with a
46 composite floor as shown in Fig 1 (only modelled part shown here). The composite floor used
47 for the test was 7900 mm long and 4600 mm wide and had two spans. The 280 mm deep
48 composite slab was supported on three FSFBs in such a way that the Comflor-210 deep metal
49 steel decking rested on the welded steel plates of these beams. C35 normal weight concrete
50 was used for the construction of the composite slab. Minimum depth of concrete over the
51 decking was 70 mm including a 38 mm layer of concrete over the top flange of the FSFB.
52
53
54
55
56
57

1
2
3 Edge beams were fabricated using HEB-200 steel section with a 15 mm thick and 330 mm
4 wide steel plate [10] [11]. The FSFB in the middle was fabricated by welding a steel plate, 15
5 mm thick and 440 mm wide, to an HEB-240 steel section along its bottom flange as shown in
6 Fig 2. S235 grade steel was used for both the steel section and the welded plate [10] [11].
7 Any reinforcements used during the test were of grade FeB-500-HWL [10] [11]. During the
8 fabrication process, no air-gap was introduced for the end beams while for the FSFB in the
9 middle, an air-gap of 2 mm was intentionally introduced using iron chords placed parallel to
10 the welds. The minimum size of the fillet weld used during fabrication was 5 mm. The test
11 specimen was exposed to standard fire for about 90 minutes and was then allowed to cool
12 down [10] [11]. For the external beams, temperatures were recorded at two distinct locations
13 while for the central FSFB, temperatures were recorded at seven distinct locations along its
14 span. In addition to thermal recordings on the steel section, thermocouples were also placed
15 in concrete, on steel decking and in the rebars to acquire the thermal data. The procedure also
16 involved placement of instrumentations to measure parameters such as displacements,
17 curvatures and the applied loads to the test assembly [11].
18
19
20
21
22
23
24
25
26

27
28 The second test was conducted on the 14th of February 1991 at Warrington Fire Research
29 Centre (WFRC) on a FSFB assembly with pre-cast concrete slab units [12]. The FSFB used
30 during the test consisted of a 254x254x73 universal column (UC) section and a steel plate
31 455 mm wide and 15 mm thick. Both the UC section and the steel plate were manufactured
32 using S275 steel. Part of the concrete slab surrounding the web and between the flanges was
33 cast-in-place while the outer parts of the slab consisted of precast concrete blocks 440 mm
34 long, 140 mm wide and 215 mm deep [12] resting on the welded steel plate as shown in Fig 3
35 and Fig 4. Cube strength for the cast-in-place concrete was reported to be 30 MPa. Detailed
36 instrumentation was conducted to measure the temperatures and displacements during the
37 test. Temperatures were measured using thermocouples which were fixed on the steel section
38 at seven distinct locations along the length of the FSFB assembly [12]. In addition,
39 arrangements were also made to measure the vertical displacements using Linear Variable
40 Differential Transformer (LVDTs). Unlike the previous case, the top flange was kept
41 uncovered as no concrete was laid over it. Depth of the precast units was 39 mm lesser than
42 that of the cast-in-place concrete [12] as shown in Fig 4. The test assembly was exposed to a
43 standard fire for 90 minutes and the data was recorded in terms of temperature and
44 displacements. Unlike in the previous case, data was only recorded for the heating phase, the
45 cooling phase of the fire test was not considered [12].
46
47
48
49
50
51
52
53
54
55
56

4 Finite element modelling for fabricated slim floor beams

Finite element (FE) analyses for FSFB assemblies were performed using ABAQUS [13]. Although various investigations on the behaviour of shallow floor systems in fire are available in literature, including the ones in the references [14] [15] [16], these previous studies mainly focus on the response of asymmetric slim floor beams. The response of the FSFBs differs from that of asymmetric slim floor beams due to the presence of the air-gap between the welded steel plate and the bottom flange. Hence, in this study, FE analyses are performed to study the response of FSFBs in fire and emphasis is made to highlight the influence of the air-gap presence and its size on their thermal and structural response.

4.1 Fabricated slim floor beam with composite floor

As the test on the FSFB assembly with composite slab consisted of a large floor having two spans, the central part of the test assembly was modelled to make the analytical investigation more economical in terms of time. The modelled part comprised a 1000 mm wide composite slab and the central FSFB was manufactured using HEB-240 steel section and a 440 mm wide and 15 mm thick steel plate as shown in Fig 2. Keeping within the scope of this study, the heating phase of the test is considered while the cooling phase is not considered in the FEM. Due to the shape of the steel decking, the depth of the composite slab varies along the span having a minimum of 70 mm and a maximum of 280 mm as shown in Fig 2(b) and Fig 2(c) respectively. As was the case with the experimental fire test, a 2 mm air-gap was deliberately introduced between the welded steel plate and the bottom flange during FEM. During the FEM, the heating regime and the boundary conditions were kept similar to those reported in the test while the non-linear thermal properties of the materials including the thermal conductivity, specific heat, and the density were taken as given in the Eurocodes [17]. For thermal analysis, 8-node hexahedral solid linear heat transfer elements (DC3D8) were used to model the concrete and steel. Heat transfer through the surfaces was modelled via the surface film condition using convection coefficients for exposed and unexposed surfaces as 25 W/m²K and 9 W/m²K, respectively, following the recommendations of the Eurocodes [18]. Any heat transfer via radiation from the unexposed surfaces was ignored. For exposed surfaces and the cavity between the welded plate and bottom flange of the steel section, radiation was modelled using an emissivity of 0.7 as recommended by the Eurocodes [19] [20]. The thermal analysis for the FSFB assembly was performed for a period of 90 minutes against the actual furnace temperatures recorded and reported for the test [10] [11]. The recorded furnace temperatures were similar to the standard fire curve with only minor

1
2
3 variations. During the thermal analysis, a perfect contact was modelled between the steel and
4 concrete allowing for efficient and full heat transfer following the methods presented in
5 similar studies conducted previously on other shallow floor systems [14] [16] [21] [22].
6
7

8 **4.2 Fabricated slim floor beam with pre-cast floor**

9
10 The FSFBs beam assembly with pre-cast slab units was also modelled using ABAQUS [13].
11 The modelled specimen was the same as the test assembly with an overall depth of 269 mm
12 and an exposed span length of 4500 mm as shown in Fig 4. The width of the assembly was
13 584 mm including 140 mm wide pre-cast concrete units on both sides of the FSFB. The width
14 of the cast-in-place concrete, including the web of the steel section was 304 mm as shown in
15 Fig 4(b). Similar to the test assembly, the depth of the pre-cast units was kept at 215 mm
16 while the depth of the cast-in-place concrete was kept at 254 mm in the FE model. As no
17 concrete cover was provided on the top flange during the test, no concrete was modelled
18 above the top flange. An air-gap of 1 mm was modelled between the welded steel plate and
19 the bottom flange of the FSFB. FE analysis was performed using the same approach as
20 discussed in section 4.1 while the fire exposure conditions and the material properties were
21 kept the same as those reported during the test [12]. Thermal analysis was performed for a
22 period of 90 minutes and a perfect thermal contact was modelled between the steel and
23 concrete similar to the aforementioned case. The structural response of the FSFB assembly in
24 fire was evaluated in two steps. **During the first step, static loads representing the test loads**
25 **were applied while in the second step,** the FSFB assembly was heated using the thermal
26 predictions obtained from the thermal analysis. The applied thermal predictions were the ones
27 already verified against the test data during the thermal analysis part. These thermal
28 predictions were applied using the “temperature” option in ABAQUS [13]. The external
29 loads were same as those applied during the test with a degree of utilization of 0.46 of the
30 FSFB [12]. During the test, external loads were applied in form of point loads, however
31 during FEM, a uniformly distributed load representing the external load was applied. The
32 structural response of the FSFB assembly was measured in terms of vertical deflection at
33 mid-span following the limits of **maximum deflection and maximum rate of deflection**
34 **recommended by the British Standards, BS 476-20** [26]. During the structural analysis, a
35 distinct set of modelling elements were used for steel and concrete. The concrete part was
36 modelled using 8-node linear brick elements (C3D8) while the steel part was modelled using
37 8-node linear brick elements with reduced integration (C3D8R). Both these elements were
38 found to yield better results in comparison with other available element types. Non-linear
39
40
41
42
43
44
45
46
47
48
49
50
51
52
53
54
55
56
57
58
59
60

material models were employed for both steel and concrete. Steel was modelled using the 'Von Mises plastic model' while concrete was modelled using 'the concrete damage plasticity model' having a dilation angle of 55° for reasons mentioned previously in the references [14] [16].

5 Finite element analysis results

5.1 Fabricated slim floor beam with composite floor

The test data for the FSFB assembly with composite slab is reported in terms of temperatures over the heating period at seven distinct locations along its span. For comparison purposes, the thermal predictions from the FEM are presented and compared with the reported test data at the two selected locations shown in Fig 2. Section AA' in Fig 2(b) represents the location of thermocouples where the depth and width of concrete slab is minimum while section BB' in Fig 2(c) represents their location at maximum depth and width of the concrete slab. These variations in the geometry of the FSFB assembly are due to the shape of the steel decking which changes along its span. At both locations, four thermocouple positions are selected to establish the comparison. Thermocouple position 1 represents the central point on the welded plate while thermocouple position 2 represents the bottom flange. Thermocouple 3 represents the position on the web at 30 mm from the inner face of the bottom flange while thermocouple 4 represents the top flange as shown in Fig 2(b) and Fig 2(c). The selected thermocouple positions were same as the ones used for data acquisition during the test [10]. The obtained test data is available online and can be accessed from the UK's steel construction database [23]. From the FEM, it was found that a high temperature gradient exists across the section of the FSFB as seen in Fig 5(a) and Fig 5(b). This thermal gradient was similar to the findings of previous studies given in the references [24] [25]. In addition to the thermal gradient, temperatures on the bottom flange are significantly lower than those on the welded steel plate. Thermal predictions from FEM are plotted against the reported test data for the four thermocouple positions at sections AA' and BB' in Figs 5(c) and 5(d), respectively. The results from the FEM are in very good agreement with the test data for both locations irrespective of geometric variations resulting from the shape of the steel decking. This shows that the proposed FEM method is efficient and can replicate the thermal behaviour of FSFBs with considerable accuracy. It is evident that the temperature differences between the thermocouple position 1 on the welded plate and that for position 2 on the bottom flange of the steel section is substantial throughout the heating regime. This difference predicted during the FEM is presented against the data recorded during the test for

1
2
3 section AA' and section BB' in Figs 5(e) and 5(f) respectively. It can be seen that the
4 predicted temperature differences for these thermocouple positions, 1 and 2, are in good
5 agreement with the test data. The temperature difference at both locations is more than
6 350°C, hence, the air-gap between the bottom flange and the welded plate acts as an
7 insulation layer and hinders temperature development on the steel section, especially on the
8 bottom flange. The temperature gradient across the section complemented by the insulation
9 provided by the air-gap may be beneficial to enhancing the fire resistance of FSFBs.
10
11
12
13
14

15 5.2 Fabricated slim floor beam with pre-cast floor

16 5.2.1 Thermal analysis results

17
18 In case of the FSFB assembly with pre-cast slab units, the thermal data was recorded at seven
19 distinct locations during the test. Since the cross-section of the test assembly is uniform along
20 its span, a single location is selected for the data comparison purposes to avoid any
21 unnecessary repetitions. The selected position, section AA', is located in the middle of the
22 test assembly as shown in Fig 4(a). During the test, temperatures were recorded at seventeen
23 distinct positions located on the welded plate, flanges and web. However, in order to avoid
24 data congestion and to keep the data presentation consistent with the previous test, four
25 thermocouple positions were selected for data comparison purposes. Thermocouple positions
26 1, 2 and 3 represent the middle parts on the welded steel plate, bottom flange and web,
27 respectively, while thermocouple position 4 represents the middle part on the right half of the
28 top flange as shown in Fig 4(c). The FEM was conducted for a period of 90 minutes and the
29 temperature profiles obtained at the end of the analysis are presented in Fig 6(a) and Fig 6(b)
30 for section AA' and for the whole FSFB assembly respectively. Similar to the case before, a
31 higher temperature gradient is observed across the section while the temperatures along the
32 length are uniform due to similar geometry. Resulting temperature differences arising from
33 the presence of the air-gap between the welded plate and bottom flange can also be seen in
34 Fig 6(a). The thermal predictions from the FEM are presented against the reported test data
35 [12] [23] for the selected position of thermocouples in Fig 6(c) which shows a good
36 agreement with the test data. Just like in the previous case, a significant temperature
37 difference was observed between the thermocouple positions on the welded steel plate and
38 the bottom flange, Fig 6(d). This temperature difference was approximately 400°C after a fire
39 exposure of 31 minutes both for the recorded test data and for the FEM predictions.
40
41
42
43
44
45
46
47
48
49
50
51
52
53
54
55
56
57
58
59
60

5.2.2 Structural analysis results

The structural analysis for the FSFB assembly with pre-cast slab units was performed using the two-step FEM method detailed in section 4. FEM results were analysed in terms of the predicted mid-span deflection against the reported test data for the beam assembly [26]. The deflected shape of the FSFB at failure is shown in Fig 7(a). It can be seen that the FSFB, being simply supported and having a single span, has maximum vertical deflection in the middle while the magnitude of this deflection decreases with the increase in distance from the middle towards the supports. The predicted mid-span deflection from FEM is plotted against the test data and is presented in Fig 7(b). It can be seen that the deflection results from the FEM and the test are in very good agreement. The deflection-based failure criteria for beams is defined by the British Standards 476 Part 20 (BS 476-20) in terms of the maximum deflection and the maximum rate of deflection, given in Eq. (1) and Eq. (2) respectively [26]. During the test, the FSFB assembly exceeded the failure criteria after a fire exposure of 83 minutes, while during the FEM, the specimen offered 81 minutes of fire resistance. In both cases, failure was initiated due to a higher rate of deflection.

$$\frac{L}{20} \quad (1)$$

$$\frac{L^2}{9000d} \quad (2)$$

Where, L is the clear span of the specimen:

d is the depth of the beam, the distance from top to the bottom.

Failure criteria in eq. (2) is only applicable when the deflection has exceeded $L/30$.

The predictions from FEM and their agreement with the test data shows that the proposed analytical method predicts the response of FSFBs at elevated temperatures with considerable accuracy. Hence the proposed method can be used to conduct parametric studies to investigate the thermal and structural response of FSFBs in fire.

In the following sections, a parametric study is conducted to investigate the effect of the air-gap on thermal behaviour and structural response of FSFBs in fire. In the first part of the study, FEM is conducted to investigate the effects of the presence and absence of the air-gap. In the later part of the sensitivity analysis, FEM is performed to investigate the effect of the air-gap size on thermal and structural response of FSFBs in fire.

6 Sensitivity analysis

To analyse the influence of air-gap on the response of FSFBs in fire, a sensitivity analysis is performed using the verified FEM method presented in sections 4 and 5. The sensitivity analysis is conducted in two parts; the first part investigates the influence of the air-gap presence while the second part deals with the effect of the air-gap size on the thermal and structural response of the FSFBs. During the sensitivity analysis, a 4500 mm long FSFB assembly, having a width of 1000 mm was modelled. The FSFB consists of an HEB-240 steel section with a 15 mm thick and 440 mm wide steel plate welded to its bottom flange as shown in Fig 8(a). A layer of normal weight concrete, 40 mm thick, was also modelled above the top flange while no geometric variations along the length of the slab were considered (see Fig 8(b) and Fig 8(c)). The total depth of the FSFB assembly is 295 mm which is same as that of the FSFB assembly used during the previous experimental investigation [11].

The thermal behaviour is presented in the form of temperatures predicted at five thermocouple positions across the section of the FSFB. Position 1 and 2 in Fig 8(b) represent the thermocouples on the welded steel plate and bottom flange while position 3 represents the thermocouple on the lower web. Similarly, position 4 and 5 in Fig 8(b) represent the thermocouples at the centre of the web and top flange respectively. The thermal analysis for the FSFB assembly was performed for 120 minutes against the standard fire exposure conditions, ISO-834 [27]. Just as in the experimental programme [11], only the lower surfaces of the assembly, including the concrete and outer faces of the welded plate were exposed to heat during the FEM. This sensitivity analysis covers the structural response of FSFBs in addition to their thermal behaviour, hence, the structural response is measured in terms of their mid-span deflection [26]. The thermal and structural response of FSFBs without the air-gap and for the ones with different air-gap sizes is presented and analysed in comparison with the predicted data obtained for the FSFB assembly with an air-gap of 0.5 mm. For all FSFBs, the structural response at elevated temperatures was analysed for a degree of utilization of 0.46, similar to the approach used during the experimental programme in the references [10] [11]. During the sensitivity analysis, the yield strength for the structural steel was taken as 355 MPa while the compressive strength of concrete was considered to be 30 MPa. It should be noted that same analytical models for the FSFBs are used during the thermal and structural analysis. The use of similar analytical models helps in making the analyses economical as the temperature predictions obtained during the thermal analyses are later used as thermal input during investigations on the structural response of FSFBs in fire.

6.1 Effect of the air-gap presence

6.1.1 The thermal behaviour

The effect of the air-gap presence on thermal behaviour of FSFBs was investigated by modelling two beam assemblies with similar geometric properties as described in the above section. The first FSFB assembly was modelled without an air-gap ensuring the material continuity, while the second assembly was modelled with an air-gap of 0.5 mm between the welded steel plate and the bottom flange as shown in Fig 9. Both FSFB assemblies were exposed to a standard fire for a period of 120 minutes. In both cases, higher thermal gradient across the section was observed as shown in Fig 10(a) and Fig 10(b). The thermal predictions for thermocouple positions 1 and 2 for FSFBs with and without the air-gap are presented in Fig 10(c). In the case of the FSFB assembly without the air-gap, the temperature difference for position 1 and 2, representing the welded steel plate and the bottom flange, is very low. The maximum temperature difference was predicted to be 33°C after 56 minutes of heating. Such temperature difference for the case without the air-gap remains low throughout the heating period. On the other hand, for the FSFB with 0.5 mm air-gap thickness, the predicted temperature difference between the bottom flange and the welded steel plate was significant and predicted to be 375°C after 29 minutes of heating. The difference in temperature for this specimen was significant throughout the heating period even though the difference gradually reduces towards the end of the analysis. After 120 minutes of fire exposure, the temperature difference for the case with 0.5 mm air-gap was 180°C which is still significantly higher compared to the case without the air-gap where the predicted temperature difference was 29°C for the same duration of fire exposure. Results from the analysis show that the presence of the air-gap has a significant influence on the thermal behaviour of FSFBs. This air-gap acts as a layer of insulation and affects the temperature development on the steel section especially on the welded steel plate and the bottom flange. From Fig 10(c) it can be observed that despite having the same exposure conditions, material properties and dimensions, temperature on the welded steel plate for the case with air-gap are significantly higher. Similarly, temperatures on the bottom flange for the case with the air-gap are much lower than for the case without the air-gap. This discrepancy could be due to the discontinuity of the steel, as the presence of the air-gap restricts the efficient transfer of heat between these parts. On the contrary, for the case without the air-gap, the continuity of material and absence of air-gap ensures efficient heat transfer and the resulting temperature difference is very low. Hence, it can be concluded that the presence of the air-gap between the welded plate and the

bottom flange acts as an insulation and restricts the efficient heat transfer resulting in higher temperature differences between these parts. This phenomenon, if studied comprehensively, can be of great benefit to enhancing the fire resistance of the FSFBs as they may support applied loads for longer durations of fire exposure.

For both cases, a higher temperature gradient is observed across the section and the predicted temperatures reduce with the increase in distance from the exposed bottom parts to the unexposed upper parts, Fig 10(a) and Fig 10(b). Though the pattern of thermal gradient is similar, lower temperatures are predicted for thermocouple locations on the web for the FSFB with air-gap in comparison to that without the air-gap. The difference in temperature is higher for thermocouple position 3 on the lower parts of the steel web and reduces for the upper parts on the web and top flange as given by thermocouple positions 4 and 5, respectively in Fig 10 (d). Hence, the presence of the air-gap has a greater influence on the bottom parts of the FSFB including the welded plate, the bottom flange, and the lower parts of the web. This influence of the air-gap presence decreases with the increase in distance from the bottom flange and eventually becomes negligible at the top flange, Fig 10(d).

6.1.2 The structural response

The structural analysis for the FSFBs with and without the air-gap was performed using the two-step FEM method proposed and validated in the previous sections. Before conducting the structural analysis at elevated temperatures, a static analysis for the FSFB with 0.5 mm air-gap is performed to calculate its ambient load-carrying capacity. The load carrying capacity of the FSFB at ambient temperatures is evaluated by applying a quasi-static load, uniformly distributed on its top flange till failure. The external load resisted by the beam before failure is considered as its load carrying capacity at ambient temperatures. A portion of this load, the utilization ratio, is then applied during the structural analysis at elevated temperatures. Later, the structural response of the FSFBs at elevated temperatures is analysed using the two-step method detailed before. In the first step, a load representing the degree of utilization of 0.46 is applied while in the second step, the specimen is heated using the thermal predictions obtained during the thermal analysis. The predicted structural response of the FSFBs in terms of the mid-span deflection is presented in Fig 7(c) for both beams. The FSFB without the air-gap had a fire resistance of 66 minutes after that the rate of deflection exceeded the limits recommended by the British Standards [26] given in Eq. 2. On the other hand, the FSFB with a 0.5 mm air-gap recorded a fire resistance of 78 minutes before reaching the same failure limits. These results show that the presence of an air-gap has a considerable influence on the

1
2
3 structural response of FSFBs at elevated temperatures. Furthermore, the presence of air-gap
4 enhances their fire resistance by a reasonable amount; in this case by 12 minutes.
5

6
7 These results show that the presence of air-gap not only has an influence on their thermal
8 behaviour but also affects the structural response of FSFBs. As the presence of air-gap is
9 helpful and beneficial, similar design methods can be proposed for other structural members
10 as an efficient and inexpensive way to improve their thermal behaviour and structural
11 response at elevated temperatures.
12
13

14 15 **6.2 Effect of the air-gap size**

16
17 From the first part of the sensitivity analysis, it was found that the presence of the air-gap, no
18 matter how small it is (as small as 0.5 mm in this particular case), has a considerable
19 influence on the thermal behaviour and structural responses of FSFBs in fire. In this part of
20 the sensitivity analysis, the influence of air-gap size (in terms of its thickness) on their
21 thermal and structural response is investigated. For this purpose, FSFB assemblies with
22 different air-gap thickness between the welded steel plate and the bottom flange are
23 modelled. The modelled FSFB specimens are similar to the beam assembly used in the first
24 part of the sensitivity study. Initially, two air-gap thickness of 2.2 mm and 4.1 mm, Fig 11(a)
25 and Fig 11(b), are modelled and investigated while a larger air-gap size of 10 mm thickness is
26 analysed at a later stage. Standard fire exposure conditions are adopted, and the specimens
27 are exposed to heat for a period of 120 minutes.
28
29
30
31
32
33
34
35

36 **6.2.1 The thermal behaviour**

37 To analyse the effect of the air-gap size, thermal predictions obtained from FEM for FSFBs
38 with 2.2 mm and 4.1 mm air-gap thickness are presented in comparison with those for the
39 FSFB with 0.5 mm air-gap thickness in Fig 12(c) and Fig 12(d), respectively. It can be seen
40 that the thermal predictions for all five thermocouples are similar irrespective of their
41 position and no effect of air-gap size is observed. These findings are similar to the results
42 obtained during an experimental investigation conducted earlier to analyse the effect of the
43 air-gap thickness on thermal behaviour of FSFBs in fire [10][11]. It was found that the size of
44 the air-gap has negligible or no effect on the thermal behaviour of FSFBs [10]. From the
45 tests, it was also observed that the welded steel plate being at a relatively higher temperature,
46 undergoes thermal bowing, as a result, the distance between the bottom flange and the welded
47 steel plate increases during heating [11]. To analyse the effect of a higher air-gap size and to
48 accommodate this increase in the air-gap thickness due to thermal bowing, FEM was
49
50
51
52
53
54
55
56
57
58
59
60

1
2
3 conducted for a similar FSFB with an air-gap thickness of 10 mm between the welded plate
4 and bottom flange as shown in Fig 11(c). Results for the specimen with 10 mm air-gap
5 thickness are presented in Fig 12(e) in comparison with the ones obtained for the specimen
6 with 0.5 mm thickness. It is observed that the effect of the air-gap size is negligible **even for a**
7 **higher thickness of 10 mm.**
8
9

10
11 Temperature differences between thermocouple positions on the welded plate and the bottom
12 flange are presented in Fig 12(f) for all assemblies with different air-gap sizes. For all FSFBs,
13 the temperatures differences are similar and are more than 350°C after 30 minutes of fire
14 exposure. This similarity of results shows that the thickness of the air-gap has no or
15 negligible influence on the thermal behaviour of FSFBs in fire. These thermal predictions are
16 similar to the results obtained through the experimental investigation reported before [10][11]
17 where the **air-gap size had negligible or no influence on their** thermal behaviour.
18
19
20
21
22

23 **6.2.2 The structural response**

24
25 To analyse the effect of the air-gap size on structural response of FSFBs at elevated
26 temperatures, FEM is performed for FSFB assemblies with 0.5 mm, 2.2 mm, 4.1 mm, and 10
27 mm air-gap thickness. The failure criteria for the FSFBs is set corresponding to the limits
28 defined by the BS 476-20 [26]. The structural response for FSFBs is evaluated for a degree of
29 utilization of 0.46. The value of applied load in terms of the degree of utilization is calculated
30 based on the load carrying capacity of the FSFB with 0.5 mm air-gap thickness at ambient
31 temperatures. **The mid-span deflections obtained from the FEM over the heating period are**
32 **presented in Fig 13(a). It can be seen that the response** of all FSFBs is similar and the effect
33 of air-gap size on their structural response is insignificant. The FSFBs with 0.5 mm, 2.2 mm
34 and 4.1 mm air-gap thickness exhibited a fire resistance of 78, 80, and 81 minutes,
35 respectively. On the other hand, the FSFBs with 10 mm air-gap size exhibited a fire
36 resistance of 83 minutes. For all FSFBs, failure **was initiated after the rate of deflection was**
37 **exceeded as provided in Eq. (2) using the failure criteria defined by the BS 476-20 [26].** The
38 fire resistance offered by the FSFBs with different air-gap sizes differs only by 5.5 minutes,
39 hence, it can be concluded that the size of air-gap has a negligible effect on their structural
40 response in fire. These results also show that for a larger air-gap size, the predicted fire
41 resistance slightly increases. For instance, the fire resistance increases by 2, 2.5, and 5.5
42 minutes for 1.7 mm, 3.6 mm, and 9.5 mm increase in the air-gap thickness, respectively. This
43 gradual increase in fire resistance of the **FSFBs is due to an increase in their load carrying**
44
45
46
47
48
49
50
51
52
53
54
55
56

capacity from the variations in the air-gap thickness. The increase in air-gap size from 0.5 mm to 2.2 mm, 4.1 mm and 10 mm results in an increase of depth of the assembly by 1.7 mm, 3.6 mm, and 9.5 mm, respectively. This marginally larger depth results in an increase in the load carrying capacity by 1.2%, 2.5%, and 5.8% respectively, in comparison to the FSFB with 0.5 mm air-gap thickness.

To analyse the structural response of FSFBs and to accommodate the variations in their individual load carrying capacities, structural analyses for the FSFBs are performed under respective degree of utilizations of 0.46. The results from the FEM are presented in Fig 13(b). It is observed that the response of FSFBs under such loading conditions corresponds to the difference of only 1 minute. This shows that the effect of air-gap size has no influence on the structural response of FSFBs when the applied load in fire conditions is calculated based on their individual capacities at ambient temperatures. The FSFBs with 0.5 mm air-gap thickness exhibited a fire resistance of 78 minutes while the ones with 2.2 mm, 4.1 mm, and 10 mm air-gap thickness exhibited fire resistance of 79, 79.2, and 79.5 minutes, respectively. In all cases, failure occurred after the rate of deflection limits were exceeded as recommended by the BS 476-20 [26]. Consequently, it can be concluded that the air-gap size has negligible or no effect on structural response of FSFBs in fire.

7 Concluding remarks

This paper investigated the effects of air-gap on behaviour of fabricated slim floor beams in fire. An air-gap is formed between the welded steel plate and the bottom flange during their fabrication process and is believed to influence their performance at elevated temperatures. In this study, finite element analysis models have been proposed and validated against available experimental data found in the literature. The verified finite element analysis models were employed to conduct a sensitivity analysis to investigate the influence of the air-gap presence and its size on the thermal behaviour and structural response of fabricated slim floor beams in fire. Some concluding remarks drawn from this research are as follows:

- The proposed finite element modelling method can successfully simulate the thermal behaviour and the structural response of fabricated slim floor beams at elevated temperatures.
- The presence of the air-gap has a considerable influence on the thermal behaviour of fabricated slim floor beams in fire and results in higher temperature difference between the welded steel plate and the bottom flange of the steel section. This air-gap

restricts the temperature development on the bottom flange, hence, temperatures on the bottom flange remain significantly lower as compared to those on the welded steel plate.

- The presence of air-gap has a lesser influence on the temperature development of upper parts of the fabricated slim floor beams. These parts include the upper web and the top flange.
- Although the presence of air-gap has a major influence on the thermal behaviour of fabricated slim floor beams, the size of the air-gap has negligible effect on their thermal performance. It was observed that the variation of air-gap thickness from 0.5 mm to 10 mm had negligible influence on their thermal behaviour during this study.
- Similar to the thermal behaviour case, the presence of air-gap has a considerable influence on the structural response of fabricated slim floor beams in fire. The presence of this air-gap enhances their fire resistance and improves their response at elevated temperatures. For the fabricated slim floor beam assembly used in this study, the fire resistance improved by 12 minutes due to the presence of the air-gap.
- Though the presence of the air-gap between the welded steel plate and the bottom flange enhances their fire resistance, however, the size of this air-gap has negligible influence on the structural response of fabricated slim floor beams in fire.

Presence of the air-gap is found to be beneficial; hence, findings from this research can be used by researchers, fabricators and manufactures to propose similar designs for other structural members as an efficient and inexpensive way to improve their fire resistance without the use of fire protection materials.

REFERENCES

1. Lu, X. and Mäkeläinen, P. (1996). Slim Floor Developments in Sweden and Finland. *Structural Engineering International*, 6(2), pp. 127-129.
2. Maraveas, C., Wang, Y.C. and Swailes, T. (2013). Thermal and mechanical properties of 19th century fireproof flooring systems at elevated temperatures. *Construction and Building Materials*, 48, pp. 248-264, DOI: 10.1016/j.conbuildmat.2013.06.084
3. Maraveas, C., Wang, Y.C. and Swailes, T. (2014). Fire Resistance of 19th Century fireproof flooring systems: A sensitivity analysis. *Construction and Building Materials*, 51, pp. 69-81, DOI: 10.1016/j.conbuildmat.2014.01.022

- 1
 - 2
 - 3
 - 4
 - 5
 - 6
 - 7
 - 8
 - 9
 - 10
 - 11
 - 12
 - 13
 - 14
 - 15
 - 16
 - 17
 - 18
 - 19
 - 20
 - 21
 - 22
 - 23
 - 24
 - 25
 - 26
 - 27
 - 28
 - 29
 - 30
 - 31
 - 32
 - 33
 - 34
 - 35
 - 36
 - 37
 - 38
 - 39
 - 40
 - 41
 - 42
 - 43
 - 44
 - 45
 - 46
 - 47
 - 48
 - 49
 - 50
 - 51
 - 52
 - 53
 - 54
 - 55
 - 56
 - 57
 - 58
 - 59
 - 60
4. Mullet, D.L., (1998). *Composite Floor Systems*. 1st edition. London. The Steel Construction Institute.
 5. Newman, G. M. (1995). Fire resistance of slim floor beams. *Journal of Construction Steel Research*, 33(1), pp. 87–100.
 6. Bailey, C. J. (1999). The Behaviour of Asymmetric Slim Floor Steel Beams in Fire. *Journal of Construction Steel Research*, 50, pp. 235–257.
 7. Makelainen, P. and Ma, Z. (2000). Fire Resistance of Composite Slim Floor Beams. *Journal of Construction Steel Research*, 54, pp. 345–363.
 8. Latham, D. J., Thomson, G., Kay, T. R. and Preston, R.R. (1986). *Fire Tests on Two Slim Floor Assemblies*, Rotherham, England: British Steel, pp. 1-2
 9. Rackham, J.W., Couchman, G.H. and Hicks, S.J. (2009). *Composite Slabs and Beams using Steel Decking: Best Practice for Design and Construction*. 2nd edition. London. The Metal Cladding and Roofing Manufacturers Association and The Steel Construction Institute.
 10. Fellingner, J. H. H. and Twilt, L. (1997). *Fire Behaviour of Long Span Composite Floor*. Fifth International Symposium on Fire Safety Science, Melbourne Australia, March 3-7, pp. 1093-1104.
 11. Both, C., Fellingner, J. H. H., and Twilt, L. (1997). Shallow Floor Construction with Deep Composite Deck: from Fire Tests to Simple Calculation Rules. *Heron*, 42(3), pp. 145-158.
 12. The Steel Construction Institute. (2008). *Report to Corus CSD, Slimflor Compendium, Document RT1147*, Version 01, London, The Steel Construction Institute.
 13. ABAQUS, (2017). *Finite Element Modelling Programme and Standard User's Manual*. Version 6.14. SIMULIA.
 14. Maraveas, C., Swailes, T. and Wang, Y. (2012). A detailed Methodology for the Finite Element Analysis of Asymmetric Slim Floor Beams in Fire. *Steel Construction*, 5(3), pp. 191-198
 15. Alam, N., Nadjai, A., Ali, F. and de Silva, D. (2017). *Finite Element Modelling for Structural Response of Slim Floor Systems in Fire and Effects of Protection*. 2nd International Conference on Structural Safety under Fire and Blast Loading, CONFAB 2017, London, England, September 10-12, pp. 428-437.
 16. Alam, N., Nadjai, A., Ali, F. and Nadjai, W., (2018). Structural Response of Unprotected and Protected Slim Floors in Fire., *Journal of Construction Steel Research*, 142, pp. 44–54, <https://doi.org/10.1016/j.jcsr.2017.12.009>

17. European Committee for Standardization. (2014). *BS EN 1994-1-2:2014. Eurocode 4: Design of composite steel and concrete structures - General rules — Structural fire design*. European Committee for Standardization, Vol. 3.
18. European Committee for Standardization. (2013). *BS EN 1991-1-2:2002 Eurocode 1: Actions on Structures, part 1-2 General actions – Actions on structures exposed to fire*. European Committee for Standardization.
19. European Committee for Standardization. (2008). *BS EN 1992-1-2:2008 Eurocode 2: Design of concrete structures part 1-2 General rules – Structural fire design*. European Committee for Standardization, Vol. 3.
20. European Committee for Standardization. (2009). *BS EN 1993-1-2 Eurocode 3: Design of steel structures, Part 1-2, General rules – Structural fire design*. European Committee for Standardization.
21. Alam, N., de Silva, D, Nadjai, A. and Nigro, E. (2017). *FE Modelling for Response of Slim Floor Systems in Fire and Effects of Intumescent Coating*. 2nd International Fire Safety Symposium, IFireSS 2017, Naples, Italy, June 7-9, pp. 735-742.
22. Maraveas, C., Tsavdaridis, K. D., Nadjai, A. (2017). Fire Resistance of Unprotected Ultra Shallow Floor Beams (USFB): A Numerical Investigation., *Fire Technology*, 53 (2), pp 609-627, doi.org/10.1007/s10694-016-0583-5
23. The Free Encyclopedia for UK Steel Construction Information. (2017). *Fabricated Slim floor Beam Fire Tests*, [online]. Available at: http://www.steelconstruction.info/Steel_fire_test_data.
24. Walnman, D. E. (1996). *Preliminary Assessment of the Data Arising from a Standard Fire Resistance Test Performed on a Slimflor Beam at the Warrington Fire research Centre on 14th February 1996*. Rotherham, England: British Steel.
25. Newman, G. M. (1995). Fire resistance of slim floor beams. *Journal of Construction Steel Research*, 33(1), pp. 87–100.
26. British Standards Institution. (1987). BS 476-20, *Fire tests on building materials and structures. Method for determination of the fire resistance of elements of construction (general principles)*. British Standards Institution
27. International Standards Organization. (1999). *ISO 834-1, Fire Resistance Tests- Elements of Building Construction. Part 1: General Requirements*. International Standards Organization.

1
2
3
4
5
6
7
8
9
10
11
12
13
14
15
16
17
18
19
20
21
22
23
24
25
26
27
28
29
30
31
32
33
34
35
36
37
38
39
40
41
42
43
44
45
46
47

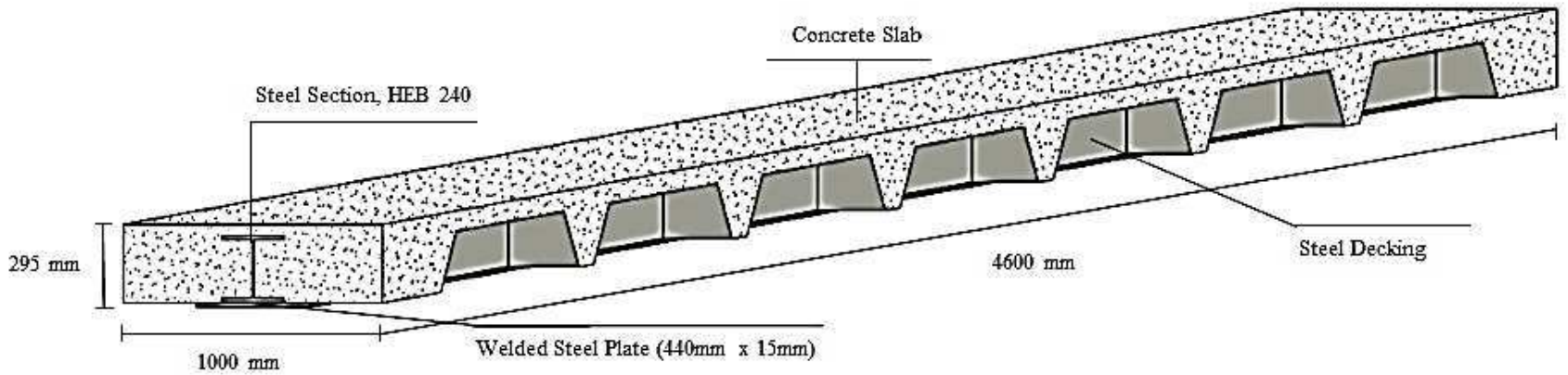

Figure 1: Fabricated slim floor beam assembly with composite slab

Journal of Structural Fire Engineering

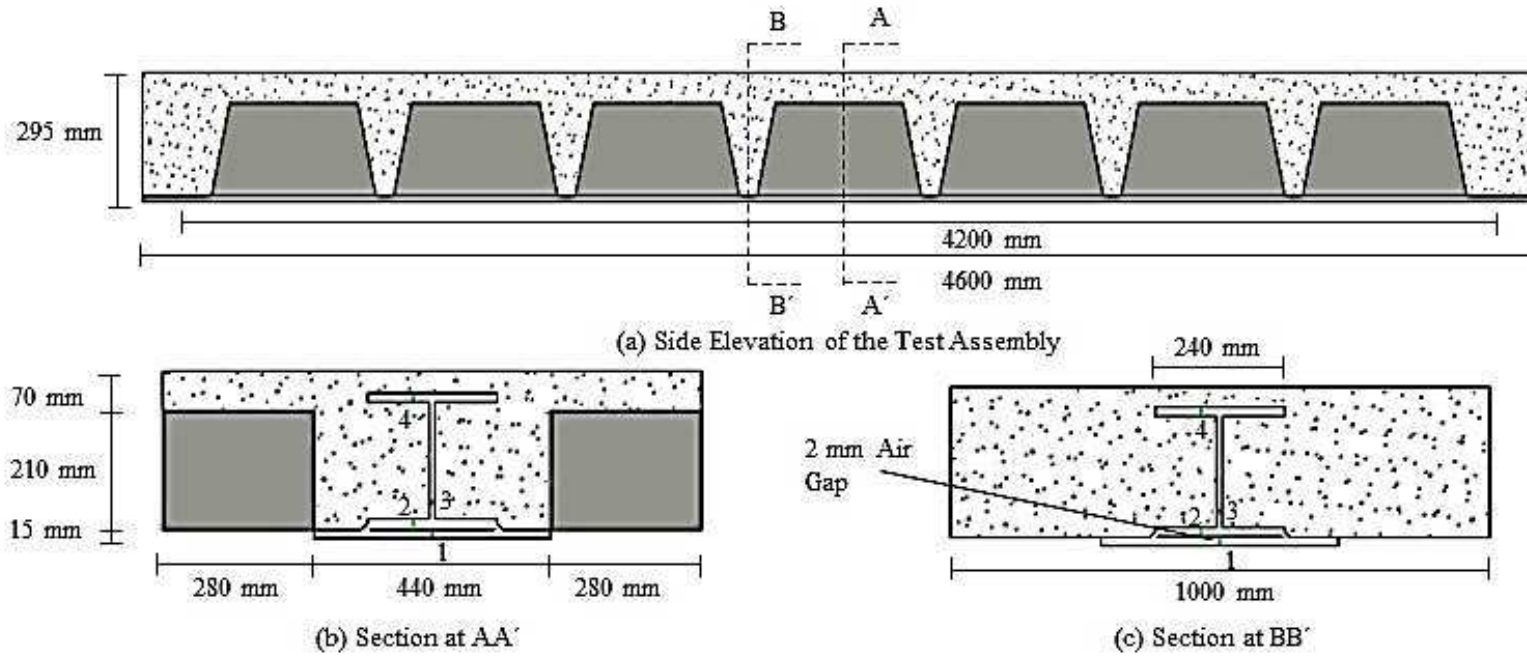

Figure 2: Side elevation and location of selected sections along the span of fabricated slim floor beam with composite floor slab

1
2
3
4
5
6
7
8
9
10
11
12
13
14
15
16
17
18
19
20
21
22
23
24
25
26
27
28
29
30
31
32
33
34
35
36
37
38
39
40
41
42
43
44
45
46
47

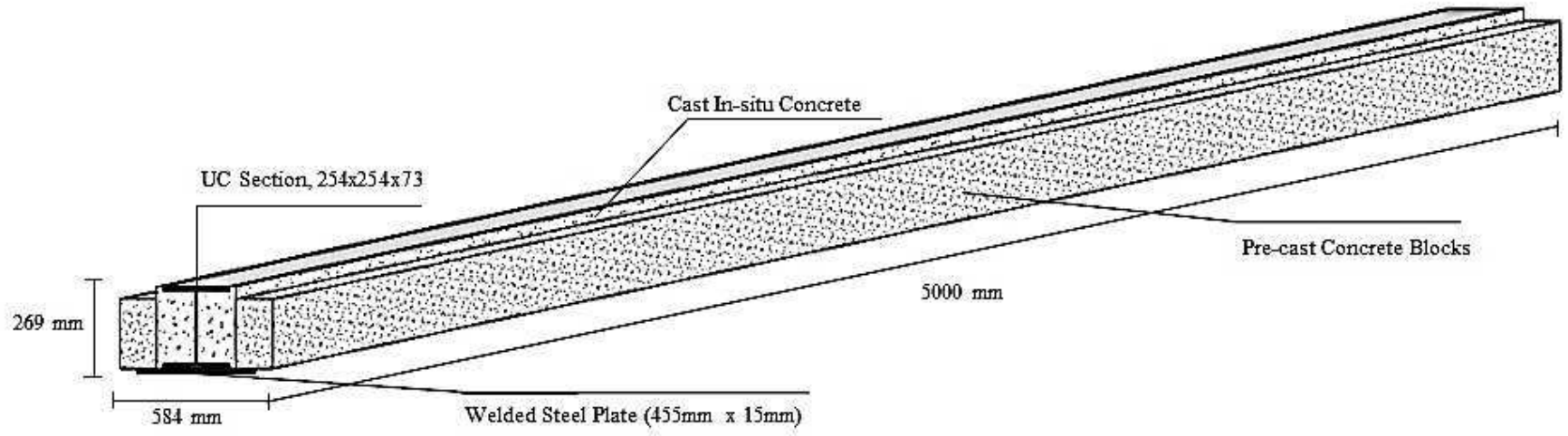

Figure 3: Fabricated slim floor beam assembly with pre-cast slab units

Journal of Structural Fire Engineering

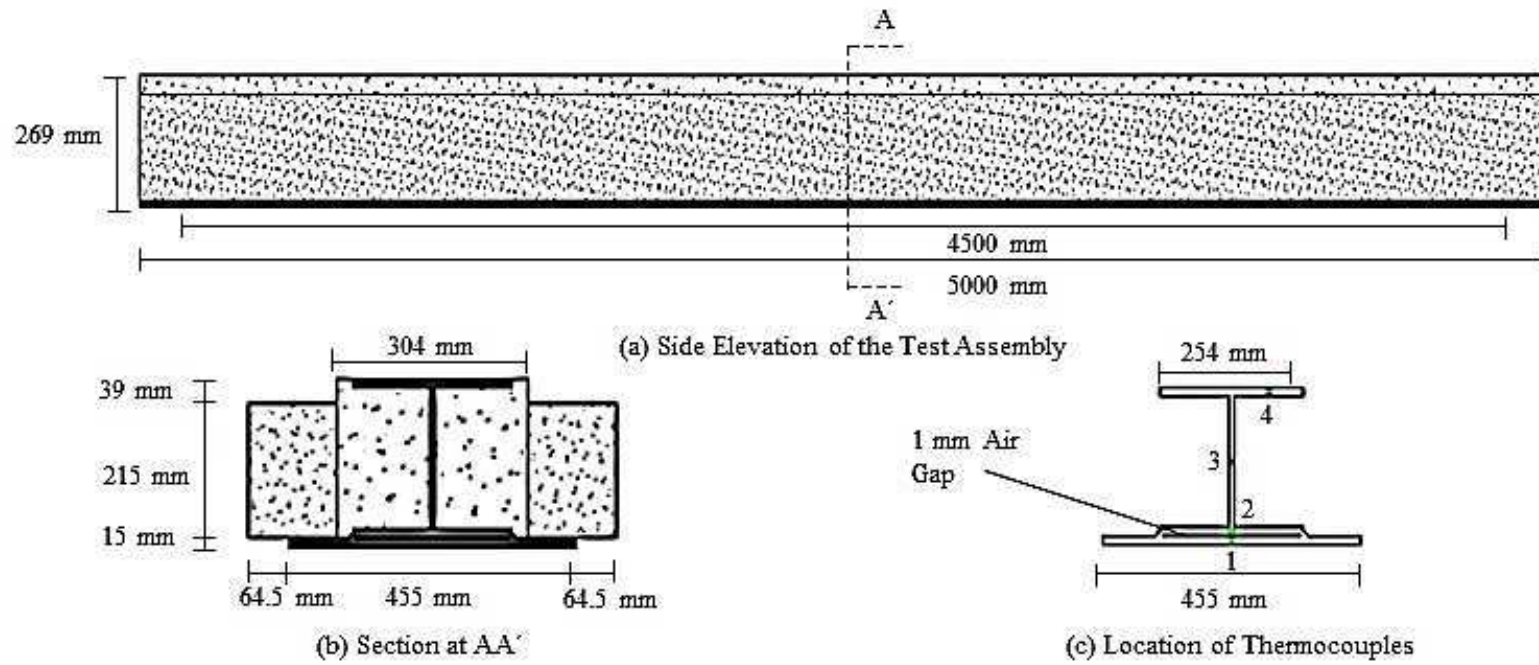
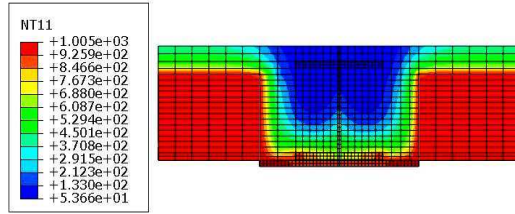
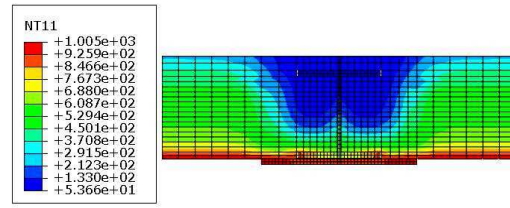

Figure 4: Side elevation, location of selected section and thermocouples for fabricated slim floor beam with pre-cast slab units



(a) Thermal results after 90 minutes heating, section AA'



(b) Thermal results after 90 minutes heating, section BB'

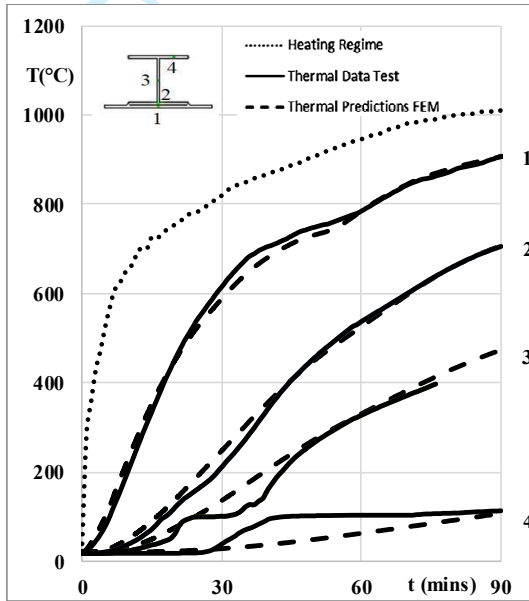

(c) Temperatures for thermocouple positions, section AA'

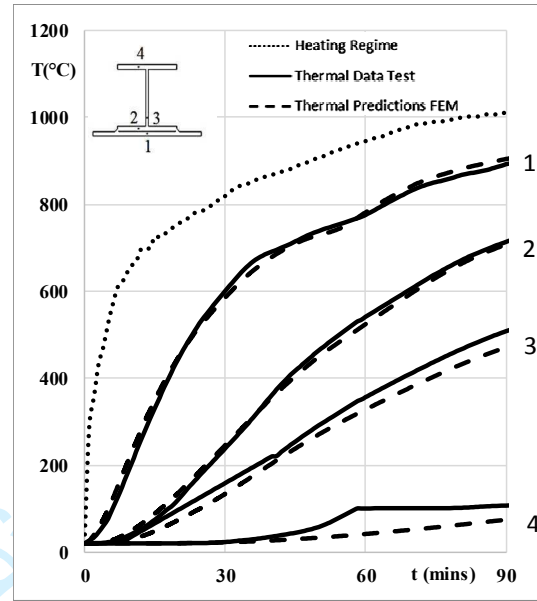

(d) Temperatures for thermocouple positions, section BB'

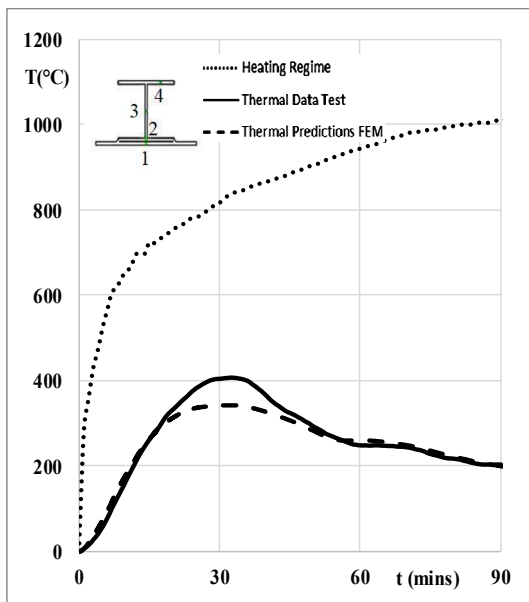

(e) Temperature difference between bottom flange and the welded steel plate at AA'

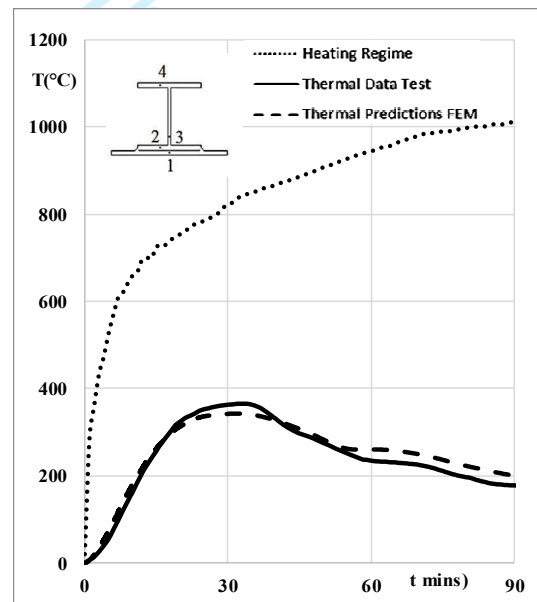

(f) Temperature difference between bottom flange and the welded steel plate at BB'

Figure 5: FE modelling predictions vs test data for fabricated slim floor test with composite slab

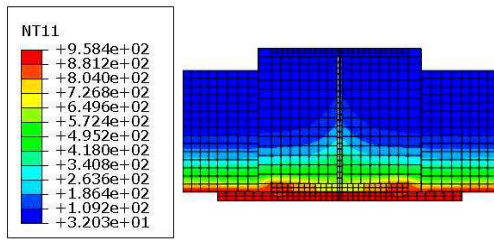

(a) Thermal results after 90 minutes heating, section AA'

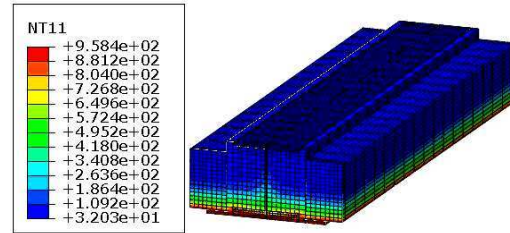

(b) Thermal results after 90 minutes heating, 3D view

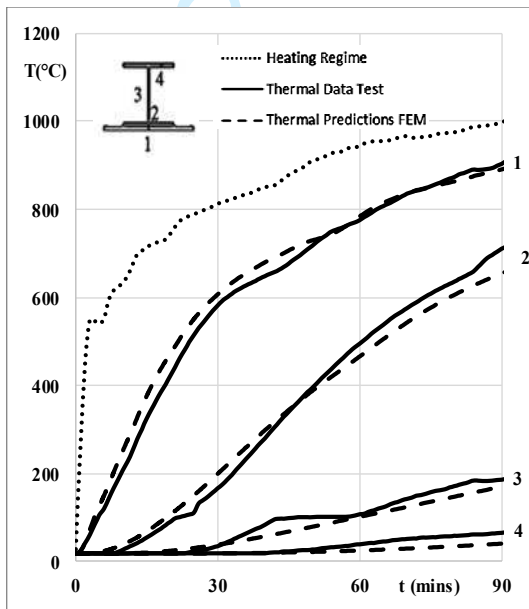

(c) Temperatures for thermocouple positions, section AA'

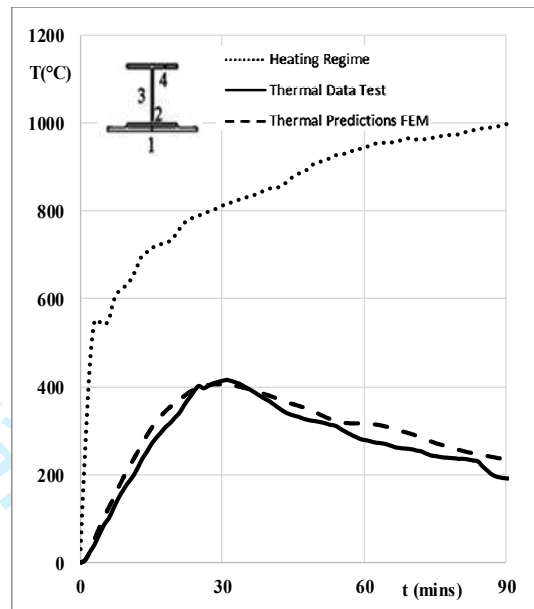

(d) Temperature difference between bottom flange and the welded steel plate at AA'

Figure 6: FE modelling predictions vs test data for fabricated slim floor test with precast slab

1
2
3
4
5
6
7
8
9
10
11
12
13
14
15
16
17
18
19
20
21
22
23
24
25
26
27
28
29
30
31
32
33
34
35
36
37
38
39
40
41
42
43
44
45
46
47
48
49
50
51
52
53
54
55
56
57
58
59
60

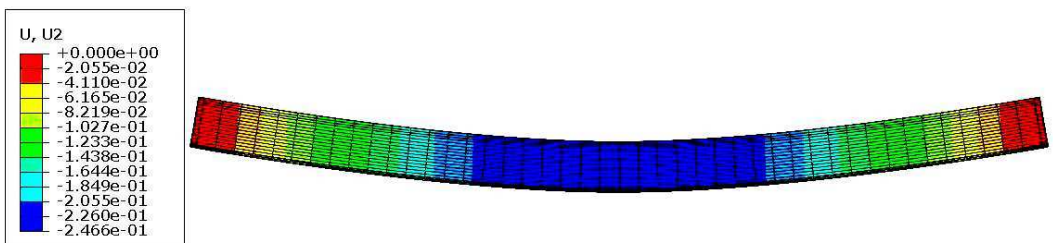

(a) Deflected shape of fabricated slim floor beam assembly at failure

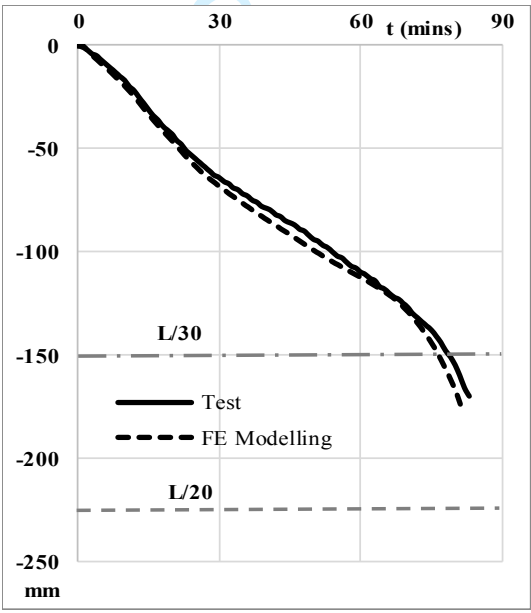

(b) Mid-span deflection, Test vs FEM

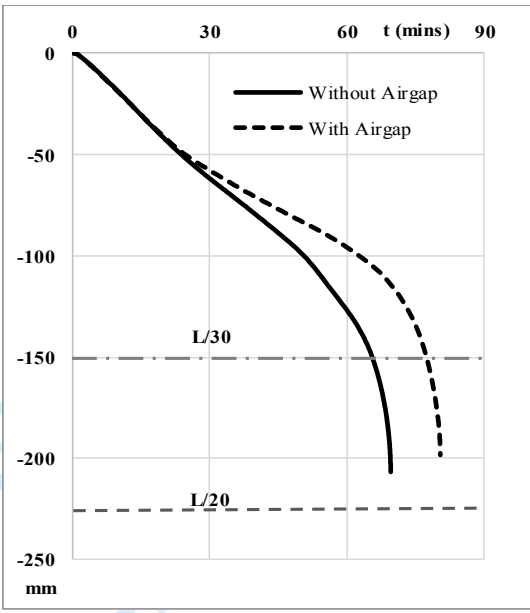

(c) Effect of air-gap on mid-span deflection

Figure 7: Mid-span deflection of the fabricated slim floor beam for test vs FE modelling and the effect of air-gap on mid-span deflection

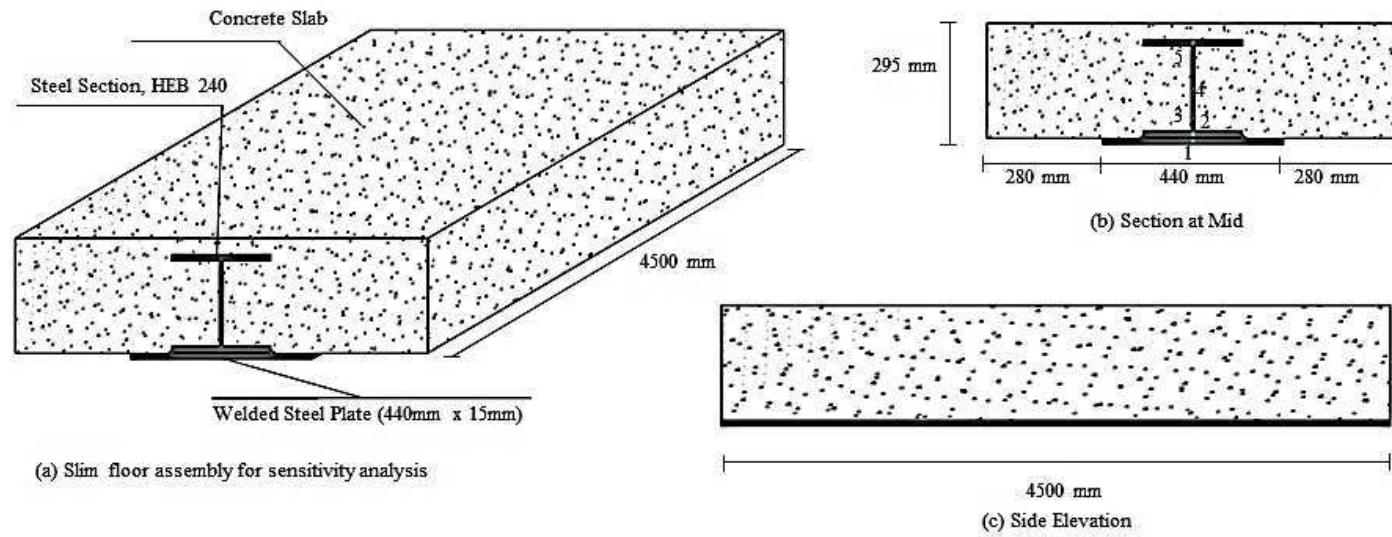

Figure 8: Details of fabricated slim floor assembly used for sensitivity analysis

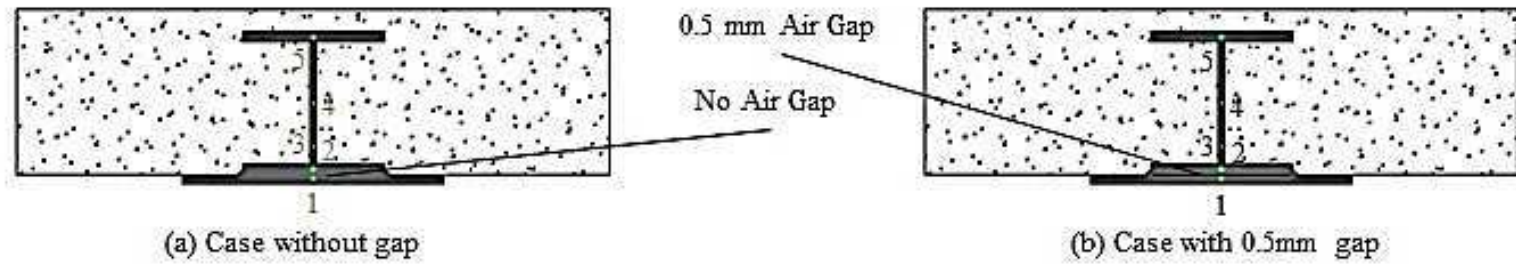
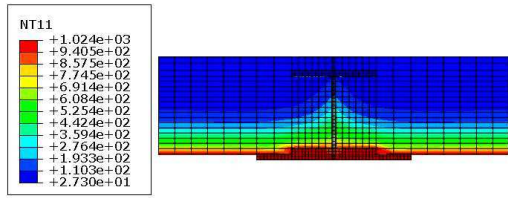
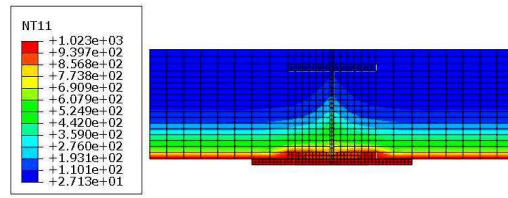

Figure 9: Sensitivity study cases for fabricated slim floor specimens with and without air gap



(a) Thermal gradient across the section of fabricated slim floor assembly without air-gap



(b) Thermal gradient across the section of fabricated slim floor assembly with air-gap

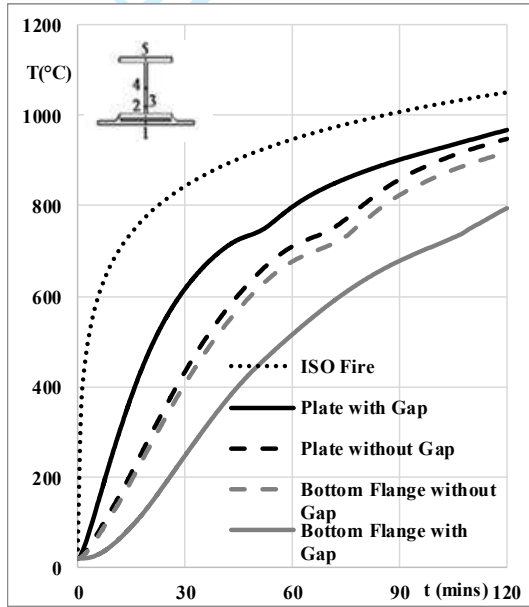

(c) Comparison for locations on welded plate and bottom flange

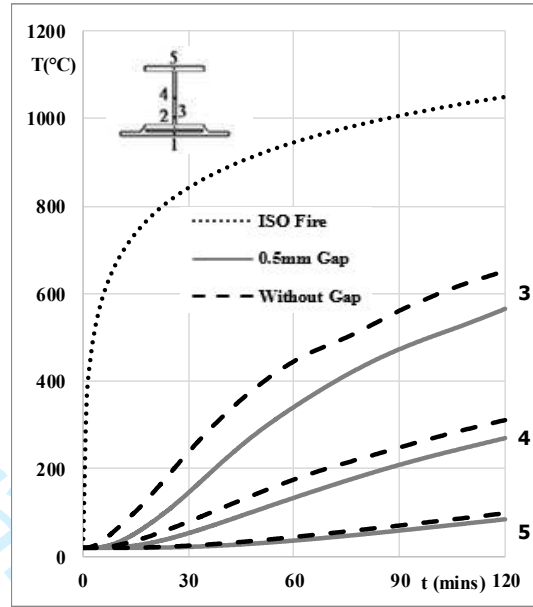

(d) Comparison for locations on web and top flange

Figure 10: Thermal comparison of cases with and without air-gap at different thermocouple positions on fabricated slim floor beam

1
2
3
4
5
6
7
8
9
10
11
12
13
14
15
16
17
18
19
20
21
22
23
24
25
26
27
28
29
30
31
32
33
34
35
36
37
38
39
40
41
42
43
44
45
46
47

Journal

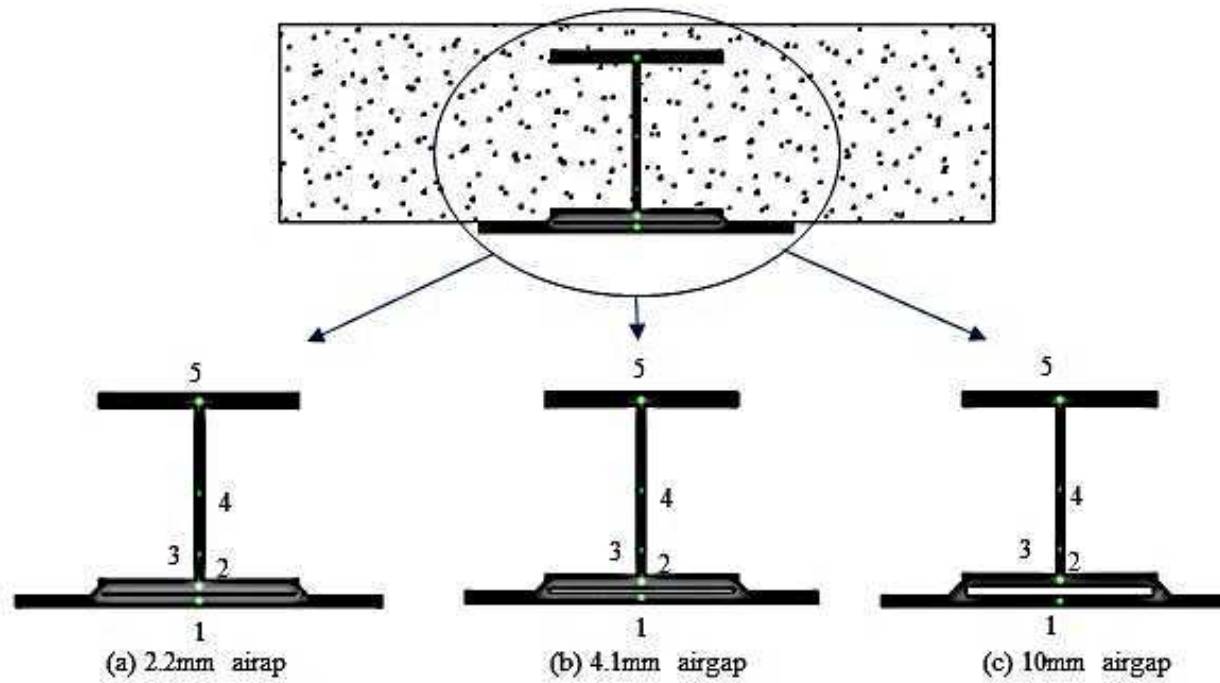
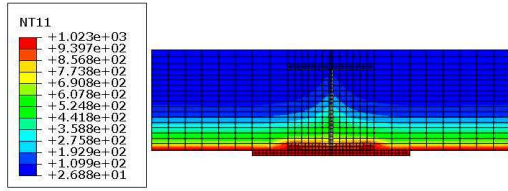
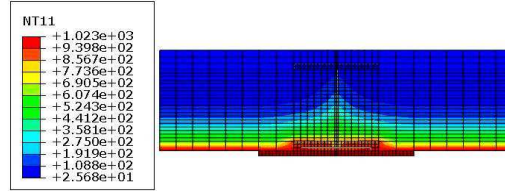

Figure 11: Sensitivity study cases for fabricated slim floor assemblies with different air-gap sizes

Engineering



(a) Thermal gradient for fabricated slim floor beam with air-gap thickness 0.5 mm



(b) Thermal gradient for fabricated slim floor beam with air-gap thickness 2.1 mm

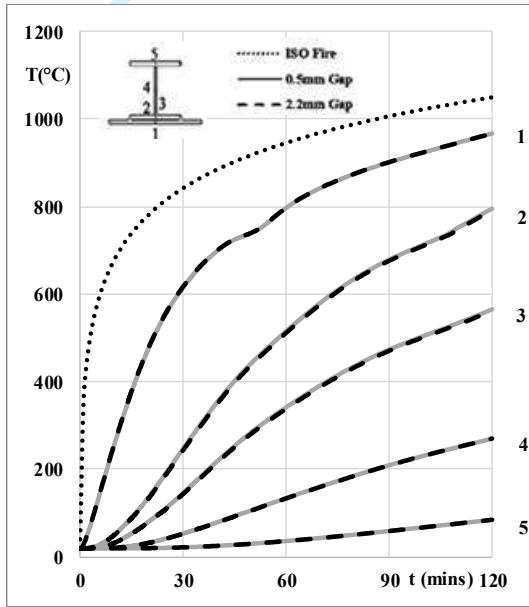

(c) Thermal predictions, 0.5 mm gap vs 2.2 mm gap

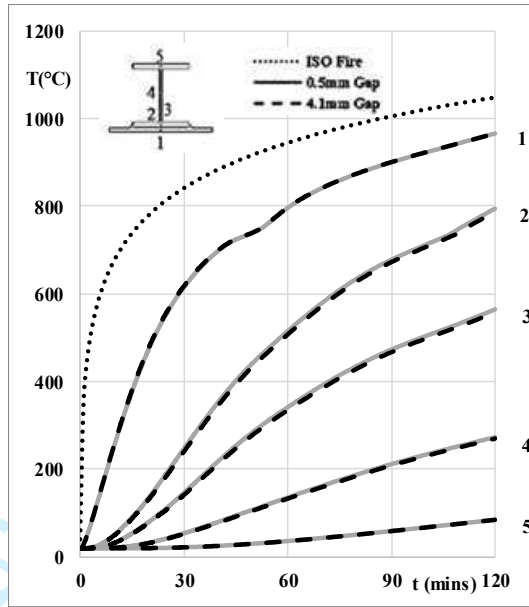

(d) Thermal predictions, 0.5 mm gap vs 4.1 mm gap

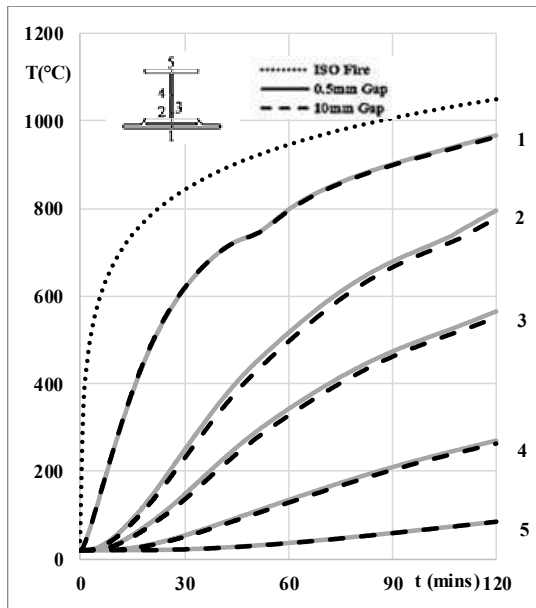

(e) Thermal predictions, 0.5 mm gap vs 10 mm gap

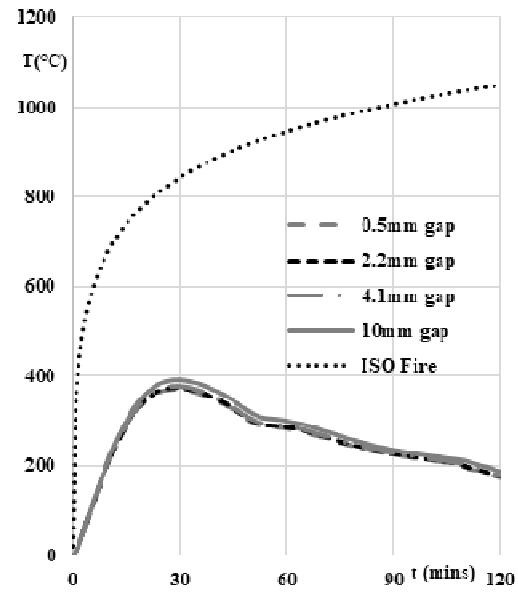

(f) Temperature difference between bottom flange and welded plate for various air gap thicknesses

Figure 12: Thermal comparisons for fabricated slim floor specimens with different air-gap sizes

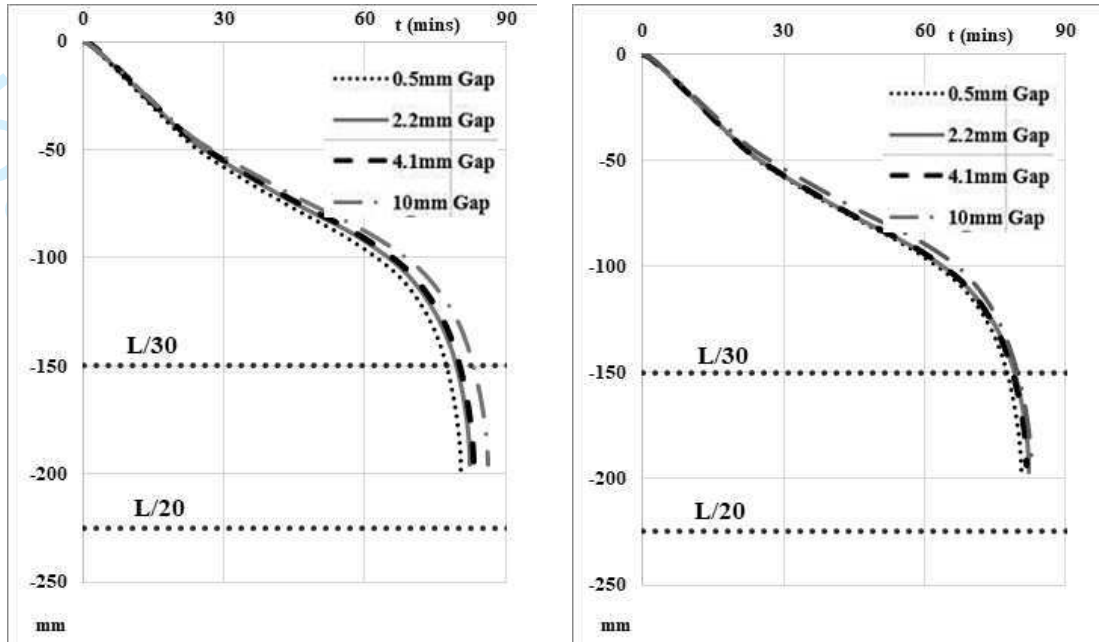

(a) Mid-span deflection for 0.46 degree of utilization of fabricated slim floor beam with 0.5 mm gap

(b) Mid-span deflection for 0.46 degree of utilization of individual fabricated slim floor beams

Figure 13: Effect of air-gap size on the structural response of fabricated slim floor beams