

**GOCE DELCEV UNIVERSITY, SHTIP, NORTH MACEDONIA
FACULTY OF ELECTRICAL ENGINEERING**

ETIMA 2021

FIRST INTERNATIONAL CONFERENCE

19-21 OCTOBER, 2021



**TECHNICAL SCIENCES APPLIED IN ECONOMY,
EDUCATION AND INDUSTRY**



УНИВЕРЗИТЕТ „ГОЦЕ ДЕЛЧЕВ” - ШТИП
ЕЛЕКТРОТЕХНИЧКИ ФАКУЛТЕТ

UNIVERSITY „GOCE DELCHEV” - SHTIP
FACULTY OF ELECTRICAL ENGINEERING

ПРВА МЕЃУНАРОДНА КОНФЕРЕНЦИЈА
FIRST INTERNATIONAL CONFERENCE

ЕТИМА / ETIMA 2021

ЗБОРНИК НА ТРУДОВИ
CONFERENCE PROCEEDINGS

19-21 Октомври 2021 | 19-21 October 2021

Главен и одговорен уредник / Editor in Chief

Проф.д-р Сашо Гелев
Prof.d-r Saso Gelev

Јазично уредување / Language Editor

Весна Ристова (Македонски) / Vesna Ristova (Macedonian)

Техничко уредување / Technical Editing

Доц.д-р Далибор Серафимовски / d-r Dalibor Serafimovski

Издавач / Publisher

Универзитет „Гоце Делчев“ - Штип / University Goce Delchev - Stip
Електротехнички факултет / Faculty of Electrical Engineering

Адреса на организационен комитет / Adress of the organizational committee

Универзитет „Гоце Делчев“ – Штип / University Goce Delchev - Stip
Електротехнички факултет / Faculty of Electrical Engineering
Адреса: ул. „Крсте Мисирков“ бр. 10-А / Adress: Krste Misirkov, 10 - A
Пош. фах 201, Штип - 2000, С.Македонија / PO BOX 201, Stip 2000, North Macedonia
E-mail: conference-etf@ugd.edu.mk

CIP - Каталогизација во публикација
Национална и универзитетска библиотека "Св. Климент Охридски", Скопје

62-049.8(062)
004-049.8(062)

МЕЃУНАРОДНА конференција ЕТИМА (1 ; 2021)
Зборник на трудови [Електронски извор] / Прва меѓународна
конференција ЕТИМА 2021, 19-21 Октомври 2021 = Conference proceedings /
First international conferece ЕТИМА 2021, 19-21 October 2021 ; [главен и
одговорен уредник Сашо Гелев]. - Штип: Универзитет "Гоце Делчев",
Електротехнички факултет = Shtip: University "Goce Delchev", Faculty of
Electrical Engineering, 2021

Начин на пристапување (URL): <https://js.ugd.edu.mk/index.php/etima>. -
Текст во PDF формат, содржи 358 стр.илустр. - Наслов преземен од
екранот. - Опис на изворот на ден 15.10.2021. - Трудови на мак. и англ.
јазик. - Библиографија кон трудовите

ISBN 978-608-244-823-7

1. Напор. ств. насл.

а) Електротехника -- Примена -- Собири б) Машинство -- Примена -- Собири
в) Автоматика -- Примена -- Собири г) Информатика -- Примена -- Собири

COBISS.MK-ID 55209989



Прва меѓународна конференција ETIMA
19-21 Октомври 2021
First International Conference ETIMA
19-21 October 2021

**ОРГАНИЗАЦИОНЕН ОДБОР
ORGANIZING COMMITTEE**

Василија Шарац / Vasilija Sarac

Електротехнички факултет,
Универзитет „Гоце Делчев“ - Штип, Северна Македонија
Faculty of Electrical Engineering,
Goce Delchev University - Stip, North Macedonia

Сашо Гелев / Saso Gelev

Електротехнички факултет,
Универзитет „Гоце Делчев“ - Штип, Северна Македонија
Faculty of Electrical Engineering,
Goce Delchev University - Stip, North Macedonia

Тодор Чекеровски / Todor Cekеровски

Електротехнички факултет,
Универзитет „Гоце Делчев“ - Штип, Северна Македонија
Faculty of Electrical Engineering,
Goce Delchev University - Stip, North Macedonia

Далибор Серафимовски / Dalibor Serafimovski

Електротехнички факултет,
Универзитет „Гоце Делчев“ - Штип, Северна Македонија
Faculty of Electrical Engineering,
Goce Delchev University - Stip, North Macedonia

Маја Кукушева Панева / Maja Kukuseva Paneva

Електротехнички факултет,
Универзитет „Гоце Делчев“ - Штип, Северна Македонија
Faculty of Electrical Engineering,
Goce Delchev University - Stip, North Macedonia

Билјана Читкушева Димитровска / Biljana Citkuseva Dimitrovska

Електротехнички факултет,
Универзитет „Гоце Делчев“ - Штип, Северна Македонија
Faculty of Electrical Engineering,
Goce Delchev University - Stip, North Macedonia

Весна Конзулова / Vesna Konzulova

Електротехнички факултет,
Универзитет „Гоце Делчев“ - Штип, Северна Македонија
Faculty of Electrical Engineering,
Goce Delchev University - Stip, North Macedonia



Прва меѓународна конференција ЕТИМА
19-21 Октомври 2021
First International Conference ETIMA
19-21 October 2021

**ПРОГРАМСКИ И НАУЧЕН ОДБОР
SCIENTIFIC COMMITTEE**

Со Ногучи / So Noguchi

Висока школа за информатички науки и технологии
Универзитет Хокаидо, Јапонија
Graduate School of Information Science and Technology
Hokkaido University, Japan

Диониз Гашпаровски / Dionýz Gašparovský

Факултет за електротехника и информатички технологии,
Словачки Технички Универзитет во Братислава, Словачка
Faculty of Electrical Engineering and Information Technology
Slovak Technical University in Bratislava, Slovakia

Антон Белан / Anton Belán

Факултет за електротехника и информатички технологии
Словачки Технички Универзитет во Братислава, Словачка
Faculty of Electrical Engineering and Information Technology
Slovak Technical University in Bratislava, Slovakia

Георги Иванов Георгиев / Georgi Ivanov Georgiev,

Технички Универзитет во Габрово, Бугарија
Technical University in Gabrovo, Bulgaria

Ивелина Стефанова Балабанова / Ivelina Stefanova Balabanova,

Технички Универзитет во Габрово, Бугарија
Technical University in Gabrovo, Bulgaria

Бојан Димитров Карапeneв / Boyan Dimitrov Karapenev

Технички Универзитет во Габрово, Бугарија
Technical University in Gabrovo, Bulgaria

Сашо Гелев / Saso Gelev

Електротехнички факултет,
Универзитет „Гоце Делчев“ - Штип, Северна Македонија
Faculty of Electrical Engineering,
Goce Delchev University - Stip, North Macedonia

Влатко Чингоски / Vlatko Cingoski
Електротехнички факултет,
Универзитет „Гоце Делчев“ - Штип, Северна Македонија
Faculty of Electrical Engineering,
Goce Delchev University - Stip, North Macedonia

Божо Крстајиќ / Bozo Krstajic
Електротехнички факултет
Универзитет во Црна Гора, Црна Гора
Faculty of Electrical Engineering,
University in Montenegro, Montenegro

Милован Радуловиќ / Milovan Radulovic
Електротехнички факултет
Универзитет во Црна Гора, Црна Гора
Faculty of Electrical Engineering,
University in Montenegro, Montenegro

Гоце Стефанов / Goce Stefanov
Електротехнички факултет,
Универзитет „Гоце Делчев“ - Штип, Северна Македонија
Faculty of Electrical Engineering,
Goce Delchev University - Stip, North Macedonia

Мирјана Перик / Mirjana Peric
Електронски факултет
Универзитет во Ниш, Србија
Faculty of Electronic Engineering,
University of Nis, Serbia

Ана Вучковиќ / Ana Vuckovic
Електронски факултет
Универзитет во Ниш, Србија
Faculty of Electronic Engineering,
University of Nis, Serbia

Тодор Чекеровски / Todor Cekеровски
Електротехнички факултет,
Универзитет „Гоце Делчев“ - Штип, Северна Македонија
Faculty of Electrical Engineering,
Goce Delchev University - Stip, North Macedonia

Далибор Серафимовски / Dalibor Serafimovski
Електротехнички факултет,
Универзитет „Гоце Делчев“ - Штип, Северна Македонија
Faculty of Electrical Engineering,
Goce Delchev University - Stip, North Macedonia

Мирослава Фаркаш Смиткова / Miroslava Farkas Smitková

Факултет за електротехника и информациони технологии
Словачки Технички Универзитет во Братислава, Словачка
Faculty of Electrical Engineering and Information Technology
Slovak Technical University in Bratislava, Slovakia

Петер Јанига / Peter Janiga

Факултет за електротехника и информациони технологии
Словачки Технички Универзитет во Братислава, Словачка
Faculty of Electrical Engineering and Information Technology
Slovak Technical University in Bratislava, Slovakia

Јана Радичова / Jana Raditschová,

Факултет за електротехника и информациони технологии
Словачки Технички Универзитет во Братислава, Словачка
Faculty of Electrical Engineering and Information Technology
Slovak Technical University in Bratislava, Slovakia

Драган Миновски / Dragan Minovski

Електротехнички факултет,
Универзитет „Гоце Делчев” - Штип, Северна Македонија
Faculty of Electrical Engineering,
Goce Delchev University - Stip, North Macedonia

Василија Шарац / Vasilija Sarac

Електротехнички факултет,
Универзитет „Гоце Делчев” - Штип, Северна Македонија
Faculty of Electrical Engineering,
Goce Delchev University - Stip, North Macedonia

Александар Туцаров / Aleksandar Tudzarov

Електротехнички факултет,
Универзитет „Гоце Делчев” - Штип, Северна Македонија
Faculty of Electrical Engineering,
Goce Delchev University - Stip, North Macedonia

Владимир Талевски / Vladimir Talevski

Електротехнички факултет,
Универзитет „Гоце Делчев” - Штип, Северна Македонија
Faculty of Electrical Engineering,
Goce Delchev University - Stip, North Macedonia



Прва меѓународна конференција ЕТИМА First International Conference ETIMA

PREFACE

The Faculty of Electrical Engineering at University Goce Delcev (UGD), has organized the International Conference *Electrical Engineering, Informatics, Machinery and Automation - Technical Sciences applied in Economy, Education and Industry-ETIMA*.

ETIMA has a goal to gather the scientists, professors, experts and professionals from the field of technical sciences in one place as a forum for exchange of ideas, to strengthen the multidisciplinary research and cooperation and to promote the achievements of technology and its impact on every aspect of living. We hope that this conference will continue to be a venue for presenting the latest research results and developments on the field of technology.

Conference ETIMA was held as online conference where contributed more than sixty colleagues, from six different countries with forty papers.

We would like to express our gratitude to all the colleagues, who contributed to the success of ETIMA'21 by presenting the results of their current research activities and by launching the new ideas through many fruitful discussions.

We invite you and your colleagues also to attend ETIMA Conference in the future. One should believe that next time we will have opportunity to meet each other and exchange ideas, scientific knowledge and useful information in direct contact, as well as to enjoy the social events together.

The Organizing Committee of the Conference

ПРЕДГОВОР

Меѓународната конференција *Електротехника, Технологија, Информатика, Машинство и Автоматика-технички науки во служба на економија, образование и индустрија-ЕТИМА* е организирана од страна на Електротехничкиот факултет при Универзитетот Гоце Делчев.

ЕТИМА има за цел да ги собере на едно место научниците, професорите, експертите и професионалците од полето на техничките науки и да представува форум за размена на идеи, да го зајканува мултидисциплинарното истражување и соработка и да ги промовира технолошките достигнувања и нивното влијание врз секој аспект од живеењето. Се надеваме дека оваа конференција ќе продолжи да биде настан на кој ќе се презентираат најновите резултати од истражувањата и развојот на полето на технологијата.

Конференцијата ЕТИМА се одржа online и на неа дадоа свој допринос повеќе од шеесет автори од шест различни земји со четириесет труда.

Сакаме да ја искажеме нашата благодарност до сите колеги кои допринесоа за успехот на ЕТИМА'21 со презентирање на резултати од нивните тековни истражувања и со лансирање на нови идеи преку многу плодни дискусии.

Ве покануваме Вие и Вашите колеги да земете учество на ЕТИМА и во иднина. Веруваме дека следниот пат ќе имаме можност да се сретнеме, да размениме идеи, знаење и корисни информации во директен контакт, но исто така да уживаме заедно и во друштвените настани.

Организационен одбор на конференцијата

Содржина / Table of Contents

| | |
|----------------------------------------------------------------------------------------------------------------------------------------------------|------------|
| ASSESSING DIGITAL SKILLS AND COMPETENCIES OF PUBLIC ADMINISTRATION AND DEFINING THEIR PROFICIENCY LEVEL..... | 12 |
| PWM OPERATION OF SYNCHRONOUS PERMANENT MAGNET MOTOR..... | 21 |
| SPEED REGULATION OF INDUCTION MOTOR WITH PWM INVERTER..... | 30 |
| WI-FI SMART POWER METER | 42 |
| RF SENSOR SMART NETWORK..... | 50 |
| FREQUENCY SINUS SOURCE..... | 62 |
| MEASUREMENT ON COMPENSATION CAPACITANCE IN INDUCTIVE NETWORK BY MICROCONTROLLER | 70 |
| ИЗРАБОТКА НА ВЕШТ НАОД И МИСЛЕЊЕ ОД ОБЛАСТА НА ЕЛЕКТРОТЕХНИЧКИТЕ НАУКИ..... | 79 |
| SIMULATION OF AN INDUSTRIAL ROBOT WITH THE HELP OF THE MATLAB SOFTWARE PACKAGE..... | 86 |
| BATTERY ENERGY STORAGE SYSTEMS AND TECHNOLOGIES:A REVIEW .. | 95 |
| POWER-TO-X TECHNOLOGIES..... | 105 |
| NEW INNOVATIVE TOURISM PRODUCT FOR REANIMATING RURAL AREAS | 115 |
| PROPOSED MODEL FOR BETTER ENGLISH LANGUAGE ACQUISITION, BASED ON WEARABLE DEVICES..... | 123 |
| OPEN SOURCE LEARNING PLATFORM – MOODLE | 132 |
| СПОРЕДБЕНА ТЕХНО-ЕКОНОМСКА АНАЛИЗА ПОМЕЃУ ТЕРМИЧКИ ИЗОЛИРАН И ТЕРМИЧКИ НЕИЗОЛИРАН СТАНБЕН ОБЈЕКТ | 139 |
| COMPARISON OF PERT AND MONTE CARLO SIMULATION | 149 |
| E-LEARNING – CYBER SECURITY CHALLENGES AND PROTECTION MECHANISMS | 156 |
| SECURITY AND PRIVACY WITH E-LEARNING SOFTWARE..... | 164 |
| ROOTKITS – CYBER SECURITY CHALLENGES AND MECHANISMS FOR PROTECTION | 174 |
| TOOLS AND TECHNIQUES FOR MITIGATION AND PROTECTION AGAINST SQL INJECTION ATTACKS | 182 |
| INFLUENCE OF ROTATION ANGLE OF LUMINAIRES WITH ASYMMETRICAL LUMINOUS INTENSITY DISTRIBUTION CURVE ON CALCULATED PHOTOMETRIC PARAMETERS..... | 189 |
| PHOTOMETRIC PARAMETERS OF LED LUMINAIRES WITH SWITCHABLE CORRELATED COLOUR TEMPERATURE | 197 |
| ENERGY-EFFICIENT STREET LIGHTING SYSTEM OF THE CITY OF SHIP USING SOLAR ENERGY AND LED TECHNOLOGY..... | 204 |
| NANOTECHNOLOGY–BASED BIOSENSORS IN DRUG DELIVERY SYSTEMS: A REVIEW..... | 212 |

| | |
|-----------------------------------------------------------------------------------------------------------|------------|
| IOT SYSTEM FOR SHORT-CIRCUIT DETECTION OF DC MOTOR AT EKG-15 EXCAVATOR | 222 |
| DESIGN OF A PHOTOVOLTAIC POWER PLANT | 231 |
| DEVELOPMENT OF COMPUTER SOFTWARE FOR CREATING CHOREOGRAPHY | 241 |
| AUTOMATED SYSTEM FOR SMART METER TESTING..... | 249 |
| INFLUENCE DIMING OF LED LAMPS TO ELECTRICAL PARAMETERS | 255 |
| INRUSH CURRENT OF LAMP..... | 261 |
| COMPLEX EVALUATION MODEL OF A SMALL-SCALE PHOTOVOLTAIC INSTALLATION PROFITABILITY | 269 |
| IMPACT OF FAULTS IN TRANSMISSION AND DISTRIBUTION NETWORK ON VOLTAGE SAGS | 278 |
| ON APPLICABILITY OF BLACK-SCHOLES MODEL TO MSE | 290 |
| ACOUSTIC SIGNAL DENOISING BASED ON ROBUST PRINCIPAL COMPONENT ANALYSIS | 300 |
| INVESTIGATION OF EFFICIENCY ASPECTS IN 3×3 PHOTOVOLTAIC PLANT USING MODEL OF SHADING | 309 |
| PROGRESS OF NO-INSULATION HTS MAGNET DEVELOPMENT TOWARDS ULTRA-HIGH MAGNETIC FIELD GENERATION..... | 319 |
| GRID-CONNECTED HYBRID PV SYSTEM WITH BATTERY STORAGE..... | 326 |
| INVESTIGATION ON STABILITY OF PANCAKE COILS WOUND WITH BUNDLED MULTIPLE REBCO CONDUCTORS | 336 |
| ON-LINE МУЛТИМЕДИСКИ ОБРАЗОВНИ КАРТИЧКИ | 343 |
| АЛГОРИТАМОТ „ВЕШТАЧКА КОЛОНИЈА НА ПЧЕЛИ“ | 352 |



SPEED REGULATION OF INDUCTION MOTOR WITH PWM INVERTER

Vasilija Sarac, Goce Stefanov, Dragan Minovski

¹Faculty of Electrical Engineering, University Goce Delcev, email: vasilija.sarac@ugd.edu.mk; goce.stefanov@ugd.edu.mk; dragan.minovski@ugd.edu.mk

Abstract

This paper presents the speed regulation of a 2.2 kW asynchronous squirrel-cage motor, a product of company Rade Koncar, with the aid of a voltage inverter controlled by the pulse-width modulation principle. The simulation circuit is developed in software Powersim. The exact motor data are input in the simulation model and the operation of the motor is simulated for various operating frequencies of the inverter. As an output, the transient characteristics of speed, current, and torque are obtained at various operating speeds i.e. below and above the rated speed of the motor. The effect of the field weakening is observed at higher operating speeds. Obtained results of speed, torque, and currents are compared with the motor data obtained from the analytical model of the motor and data of the manufacturers of variable speed drives, for operating regimes different than the rated. The simulation can serve as an example that proves the theoretical principles of pulse-wide modulation where the desired motor speed is easily obtained with the variation of frequency of modulating signal of the inverter.

Keywords

Asynchronous squirrel cage motor, PWM inverter, field –weakening, transient characteristics

Introduction

The development of power electronic and static converters has reshaped the drive technology and has opened a wide field of application for variable speed drives. This is especially important for the asynchronous squirrel cage motors as they have been considered the prime moving force of the industry mainly because they are robust, inexpensive, almost maintenance-free, but with limited capabilities for speed regulation. The voltage inverters and various techniques for speed regulation have made the asynchronous motors an attractive choice in many applications where variable speed of the drive is required.

There are two different inverter control types: scalar (open loop) and vector (open or closed-loop). The scalar control is based on the original concept of a frequency inverter: a signal of a certain voltage/frequency ratio is imposed onto the motor terminals and this ratio is kept constant throughout a frequency range, to keep the magnetizing flux of the motor unchanged. It is applied when there is no need for fast responses to torque and speed commands and is particularly interesting when there are multiple motors connected to a single drive [10]. The control is open-loop and the speed precision obtained is a function of the motor slip, which depends on the load, since the frequency is imposed on the stator windings. To improve the performance of the motor at low speeds, some drives make use of special functions such as slip compensation (attenuation of the speed variation as a function of the load) and torque boost (an increase of the V/f ratio to compensate for the voltage drop due to the stator resistance) so that

the torque capacity of the motor is maintained. This is the most used control type owing to its simplicity and to the fact that most applications do not require high precision or fast responses of the speed control. The vector control enables fast responses and a high level of precision on the motor speed and torque control. The motor current is decoupled into two vectors, one to produce the magnetizing flux and the other to produce torque, each of them regulated separately. It can be open-loop (sensorless) or closed-loop (feedback) [10].

Traditional inverters can be replaced by pulse width modulation (PWM) control Z-source inverter (ZSI) which offers buck-boost operation capability by utilizing shoot-through state and provides less EMI noise [8]. The operation of voltage source inverters can be analyzed for different conduction modes of the switches [1]. Other researchers focused on the simulation of minor deteriorations in the operating conditions of a standard motor controlled from a voltage source drive and whether the worsening condition can be detected at an early stage in the case of the V/f and sensorless vector operating mode of the inverter [3]. Interesting findings regarding transient characteristics of motor speed, current, and torque with various modulation indexes can be found in [5]. Transient characteristics of the induction motor fed by voltage inverter can be simulated in various software and one such example in Matlab/Simulink is analyzed in [4]. Comparison between transient characteristics of the induction motor, fed by the mains and by the voltage inverter, is presented in [2].

This paper presents the transient characteristics of a 2.2 kW three-phase induction squirrel cage motor simulated in V/f control mode in an open control system in Powersim software. The transient characteristics were obtained for various speeds, below, at, and above the rated speed. As the constant V/f ratio was kept, above the rated speed, the effect of the field-weakening can be observed. In addition, the harmonic content of the output voltage of the inverter was analyzed. Finally, the advantages and drawbacks of the operation of the asynchronous motor with a voltage inverter are outlined. The presented simulation circuit is useful for analyzing the operation of asynchronous motors at various operating speeds and estimation of the dynamic behavior of the motor.

2. Methodology and simulation circuit

The static converters have been proven to be the most successful and most economical way to control the speed of the asynchronous motors turning the asynchronous motor into the full controllable motor concerning the speed of rotation, i.e. the speed varies linearly with the supply frequency. The torque developed by the asynchronous motor follows the equation below [10]:

$$T = k_1 \phi_m I_2 \quad (1)$$

By neglecting the voltage drop caused by the stator impedance, the magnetizing flux can be found from:

$$\phi_m = k_2 \frac{V_1}{f_1} \quad (2)$$

Where:

T is the torque available on the motor shaft (Nm)

ϕ_m is the magnetizing flux (Wb)

I_2 is the rotor current (A) which depends on the load

V_1 is the stator voltage (V)

k_1 and k_2 are the constants and they depend on the material and machine design

f_1 - is the frequency of the power supply

Considering a constant torque load and by varying proportionally amplitude and frequency of the supplying voltage resulting in constant flux and consequently constant torque, the motor

current remains unchanged. Therefore, the motor provides continuous adjustments of speed and torque concerning the mechanical load. The ratio V_1/f_1 is kept constant up to the motor base (rated) frequency. From this frequency upwards the voltage is kept constant at its base (rated) value, while the frequency applied on the stator windings keeps growing, as shown in Fig. 1 (a).

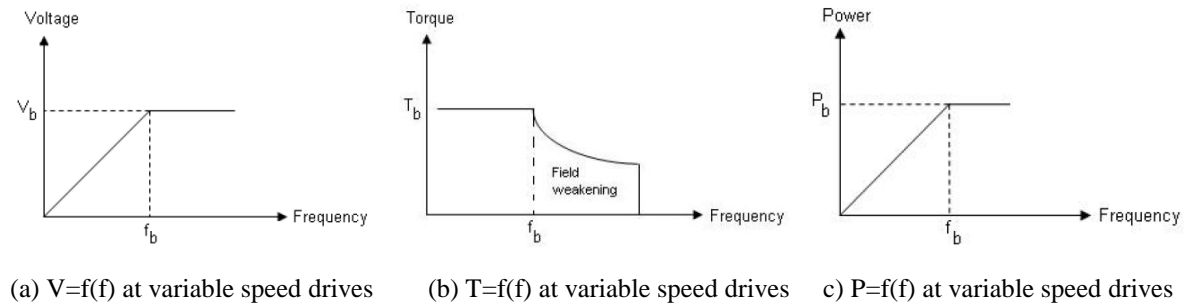

Fig. 1. Flux, torque, and output power at variable speed drives [10]

Thereby the region above the base frequency is referred to as field weakening, in which the flux decreases because of frequency increase, causing the motor torque to decrease gradually. The typical torque versus speed curve of an inverter fed motor is presented in Fig. 1 (b). It comes out that torque is kept constant up to the base frequency and beyond this point, it falls (weakening field). Since the power output is proportional to the torque times speed, it grows linearly up to the base frequency and from that point upwards it is kept constant. This is summarized in Fig. 1 (c).

The presented theoretical principles of speed regulation are applied in the simulation circuit of three-phase squirrel cage motor fed by the voltage inverter with rated data, presented in Table 1. The corresponding simulation circuit is presented in Fig. 2.

Table 1 Rated data of the analyzed motor

| Parameter | Value |
|--------------------------------|-------|
| rated power (W) | 2200 |
| rated current (A) | 5.2 |
| rated speed (rpm) | 1355 |
| efficiency (%) | 79.4 |
| power factor (/) | 0.8 |
| rated torque (Nm) | 15.5 |
| locked-rotor torque (Nm) | 35.2 |
| locked rotor phase current (A) | 21.4 |

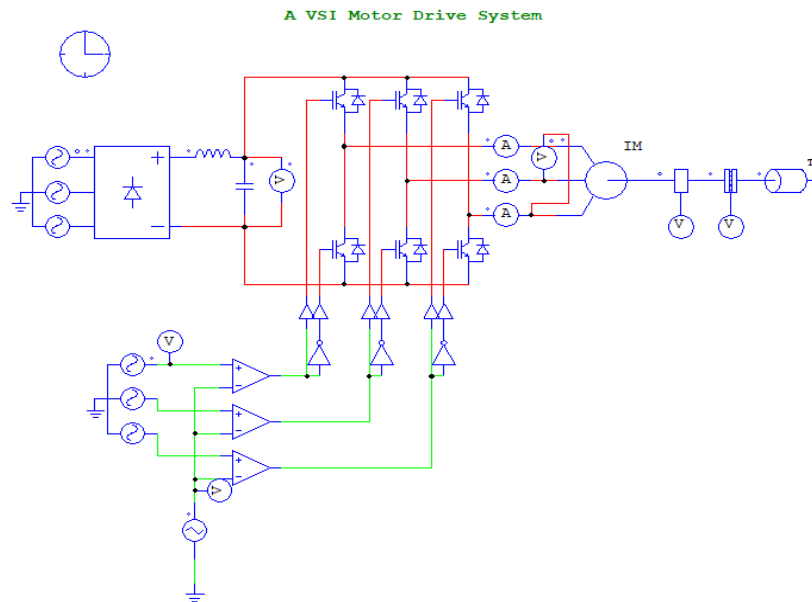
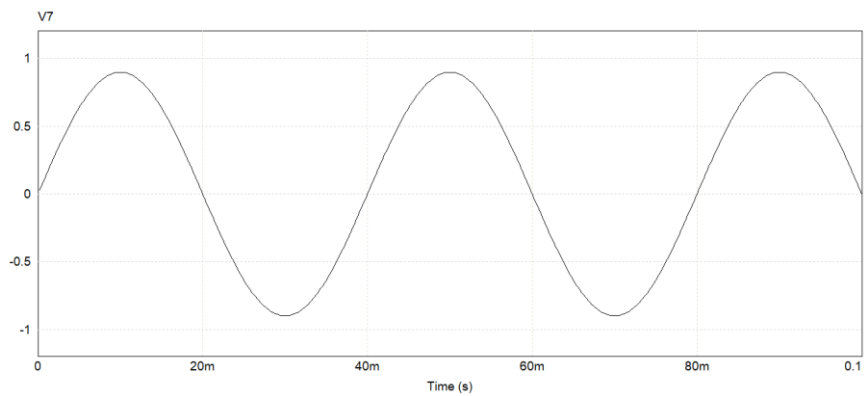
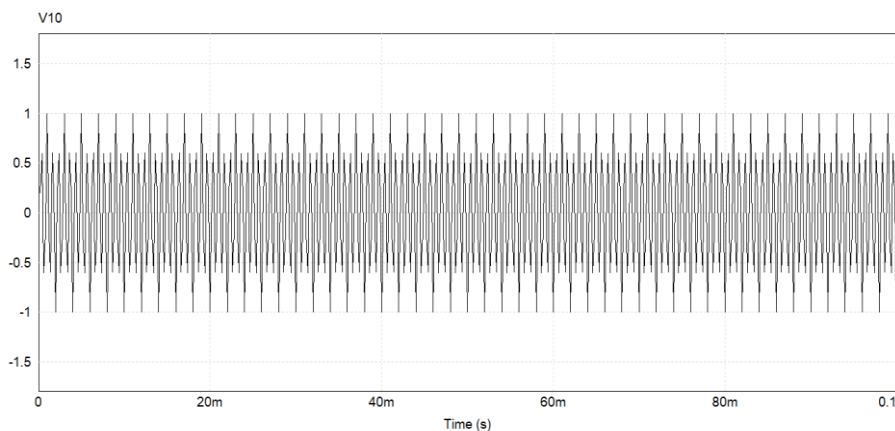

Fig. 2. Flux, torque, and output power at variable speed drives [6]

The speed regulation is achieved by the PWM principle of control of conduction period of transistors, determined by the cross-section point of the carrier signal (usually signal in form of a triangle) and modulating sinusoidal signal. By varying the frequency of the modulating signal the various operating speeds of the motor are obtained. Both signals are presented in Fig. 3.



a) modulating signal



b) carrier signal

Fig. 3. Signals from the control circuit

The supply voltage from the network is fed to the diode bridge and afterward, the DC link voltage is fed into the inverter. The voltage measured at the DC link is presented in Fig. 4. According to [10], the DC link voltage should be $1.41V_{in}$ or for an input voltage of 380 V the presented DC link voltage in Fig. 4 satisfies the expected value.

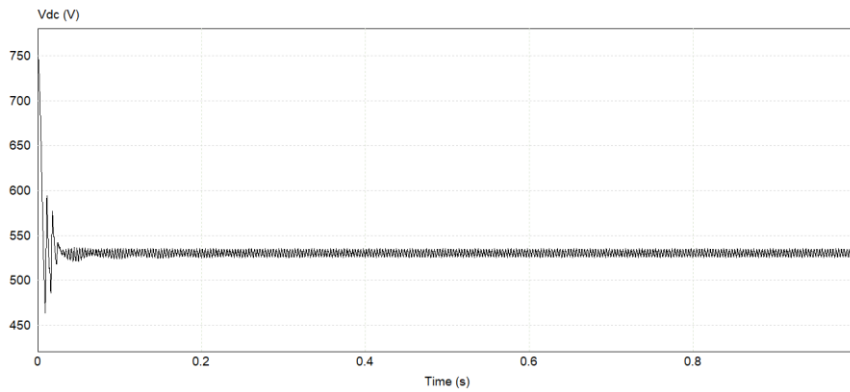
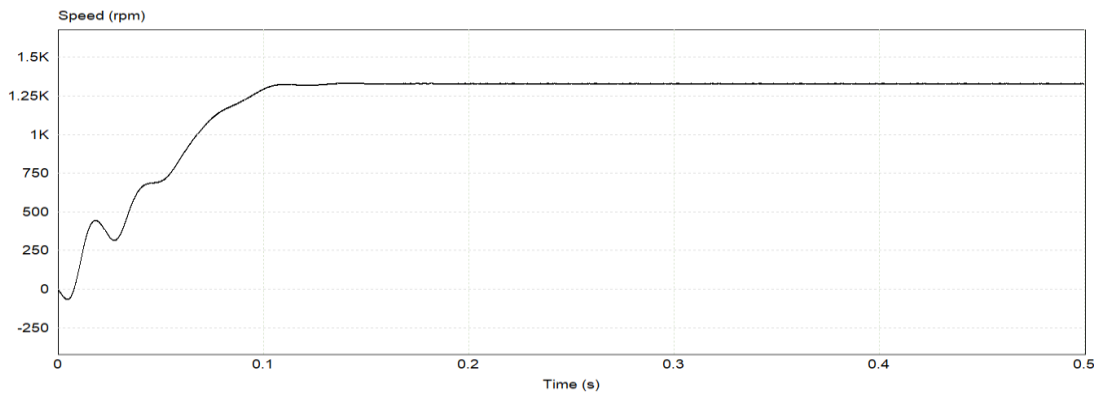

Fig. 4. DC link voltage

The output voltage from the inverter will be presented in the next section together with its harmonic analysis. Additionally, the speed, current, and motor torque, below, at and over the rated speed will be presented as well.

3. Results and discussion

The motor is constructed for operation with a rated load of 15.5 Nm and a rated speed of 1,355 rpm. Therefore the frequency of the modulating signal is set to the rated frequency of 50 Hz and the motor is loaded with 15 Nm. From the data, presented in Table 1, it can be observed that the motor starting torque is sufficiently large to allow acceleration of the motor with the rated load. The obtained results of the motor speed, torque, and current are presented in Fig. 5.



(a) speed

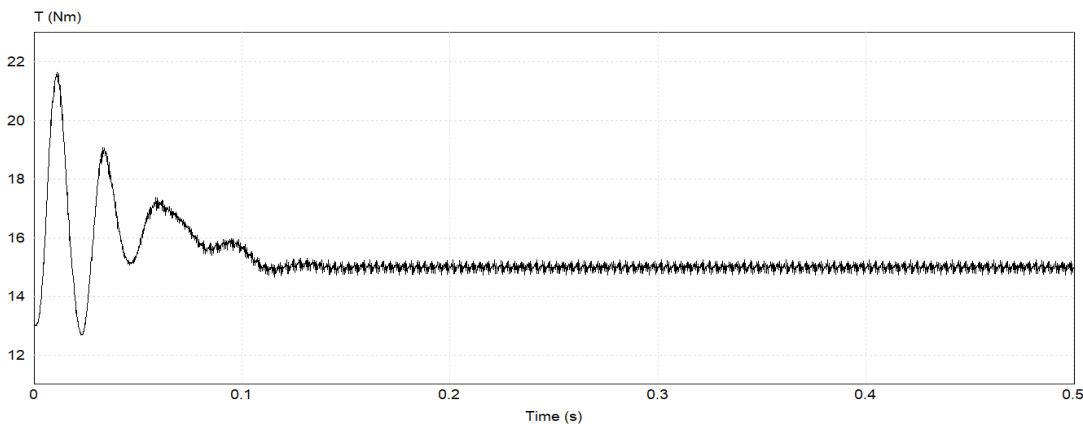

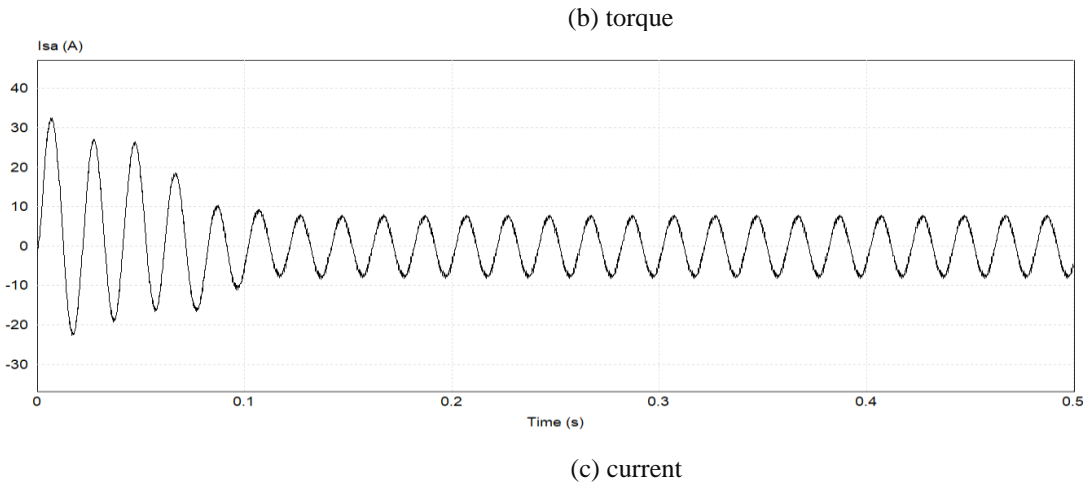
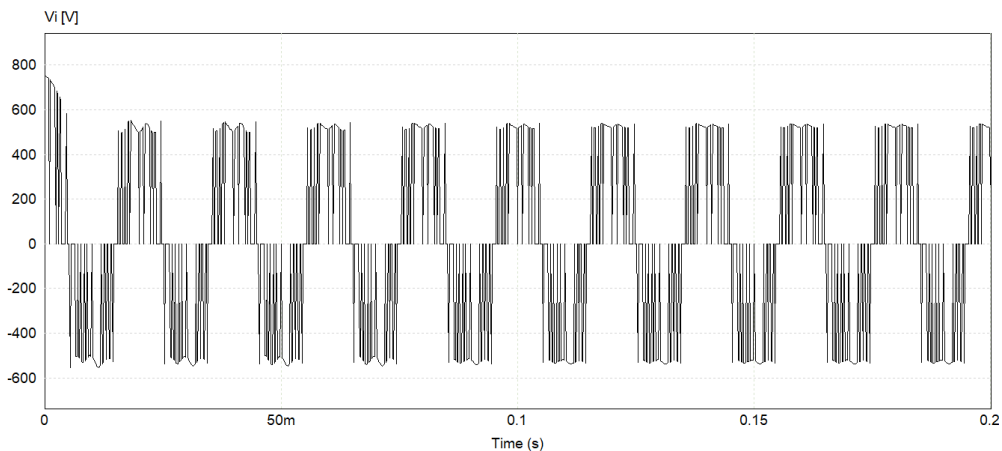
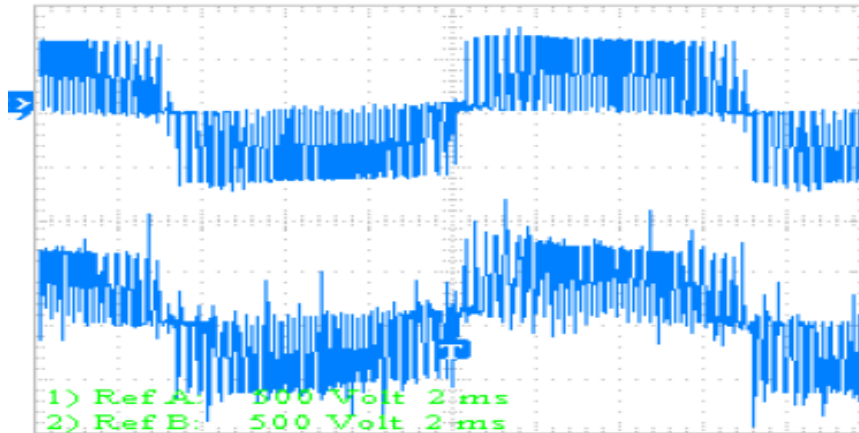

Fig. 5. Motor characteristics at rated speed (supply with 50 Hz)

From the results presented in Fig. 5 it can be observed that after the acceleration with a rated load of 15 Nm, the motor reaches the speed of 1,310 rpm which is in good agreement with the rated speed of the motor from analytical calculations of 1,355 rpm. After the transients have been suppressed and the motor has accelerated the output torque reaches 15 Nm, the result which can be expected considering that the motor is loaded with a 15 Nm load. As for the current, at motor starting it reaches the value of 25 A, still corresponding to the calculated starting current of 21 A. After the steady-state operation is achieved the motor current has a RMS value of 6 A and it corresponds to the calculated value in Table 1 of 5.2 A. The inverter output voltage is presented in Fig. 6 (a). Additionally, typical waveforms from measurements of the voltage at the output of the PWM inverter and on the input of the motor are presented in Fig. 6 (b) [10].



(a) voltage of the inverter output (simulation)



b) Voltage on the inverter output and motor input [10]

Fig. 6. Motor characteristics at rated speed

The harmonic content of the voltage on the output of the inverter is presented in Fig. 7.

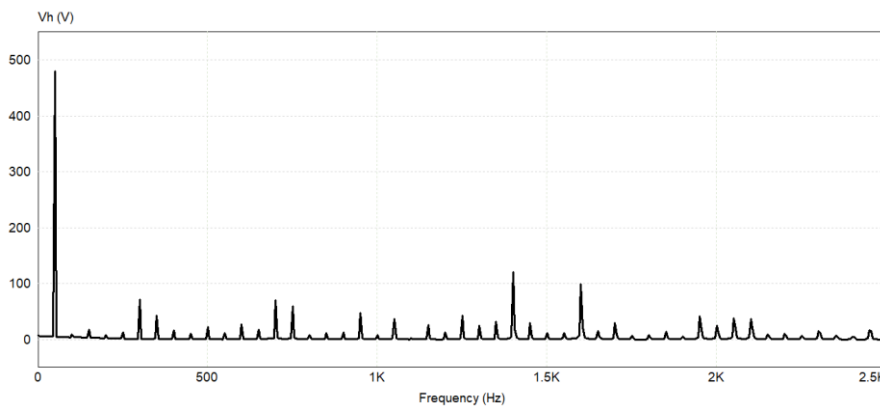

Fig. 7. Harmonics at the output voltage of PWM inverter

Increased harmonic content in the output voltage from the inverter increases the motor losses, heating, vibrations, and motor noise. Furthermore, other effects may appear when induction motors are fed by inverters. Insulation system dielectric stresses and shaft voltages allied with potentially damaging bearing currents are well-known side effects [10]. There are several measures that can be overtaken to improve the level of the high order harmonics. Some of them are installation of output passive filters, usage of multi-level inverters, pulse-width modulation quality improvement, and increase of the switching frequency.

A fundamental function of a variable speed drive is to adjust the speed of an electric motor. The basic command frequency for variable speed drives is normally from 0 Hz to 50 Hz, but mostly with the capability to be adjusted up to 400 Hz. If the base frequency of a motor is 50 Hz, then the final speed will be 8 times the base frequency of the motor with the command frequency set at 400 Hz. Due to their design, it is not normal for standard induction motors to operate at these high frequencies. In practice, a command frequency set point of between 25 Hz and 75 Hz is acceptable without compromising performance or introducing any mechanical damage to the motor. At low-frequency set points, care must be taken that there is enough cooling for the motor produced by the mechanical fan [7].

The next step in the analysis of motor operation with the voltage inverter is to decrease the speed below the rated speed. For that purpose, the frequency of the modulating signal was decreased to 25 Hz also the amplitude of the modulating signal to keep the flux constant and

to operate the motor at low speed with the rated load of 15 Nm. The obtained characteristics of speed, current, and torque below the rated speed are presented in Fig. 8.

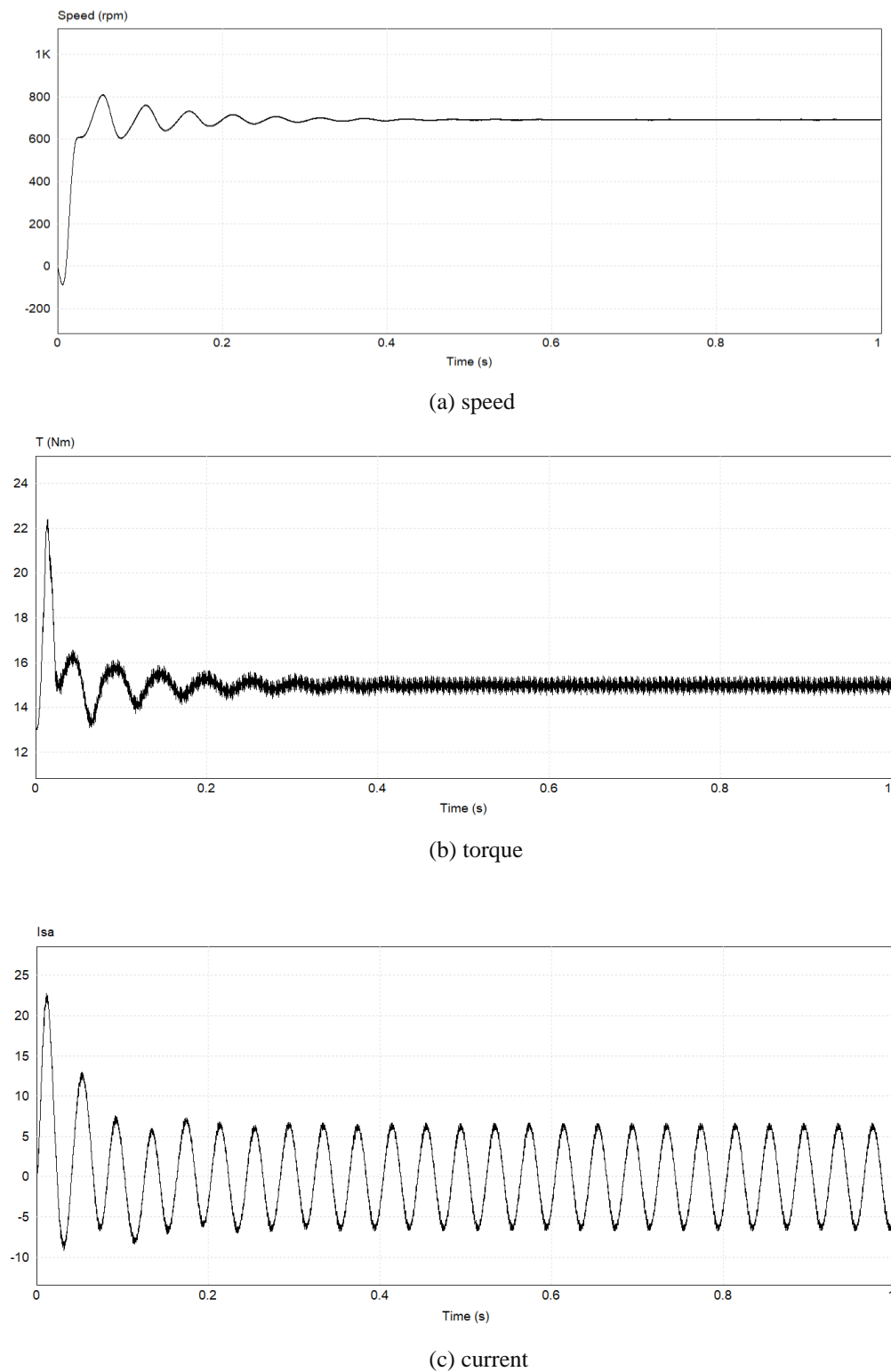

Fig. 8. Motor characteristics below rated speed (supply with 25 Hz)

Following the basic equation which determines the motor synchronous speed

$$n = \frac{60 \cdot f}{p} \tag{3}$$

with the supply of 25 Hz, a speed below 750 rpm is expected. The characteristic of speed presented in Fig. 8 (a) reaches the speed of below 750 rpm after the acceleration has finished. The motor is loaded with 15 Nm. As the ratio between voltage and flux is kept constant, there is no limitation for the motor not to be loaded with the rated load. The characteristic of motor output torque presented in Fig. 7 (b) reaches the steady-state value of 15 Nm after the acceleration of the motor has finished. At motor operation below the rated speed, the motor current is decreased. One example of how the current varies with speed and torque is presented in Fig. 9 and can be found in [9]. All quantities are normalized so that the rated or base value is 1.0. In this case, the analyzed motor current is decreased to 4 A or compared to the data presented in Fig. 9 expected current, in this case, is 3.5 A taking into consideration that for the full load and speed reduction of 50% a reduction of current of 58%, from the rated current of 6 A, can be expected (Fig. 9). Obtained result of the simulated current agrees well with the expected value of the current.

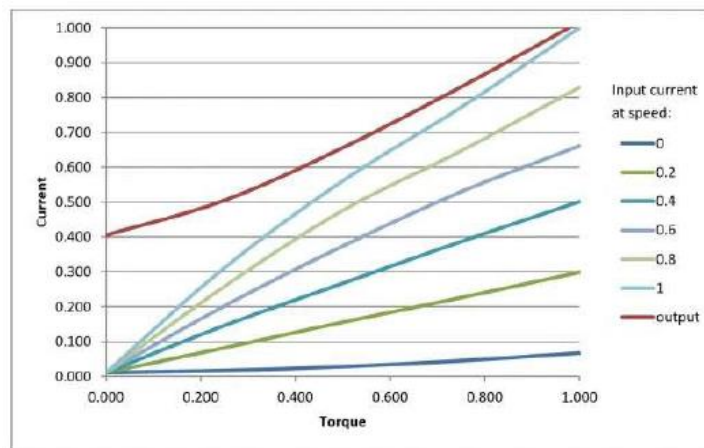

Fig. 9. Variation of the drive input current with torque and speed [9]

The operation of the motor above the rated frequency is analyzed as well. Therefore, the frequency of the modulating signal is set to 75 Hz. The amplitude of the voltage of the modulating signal remains unchanged. According to Eqs. (1) and (2), the motor enters the field-weakening region. i.e. the reduction of the load torque which can be sustained by the motor, when it operates with a constant V/f ratio or constant flux. One example what are the ranges of reduction of the motor torque can be found in [10]. They are presented in Fig. 10.

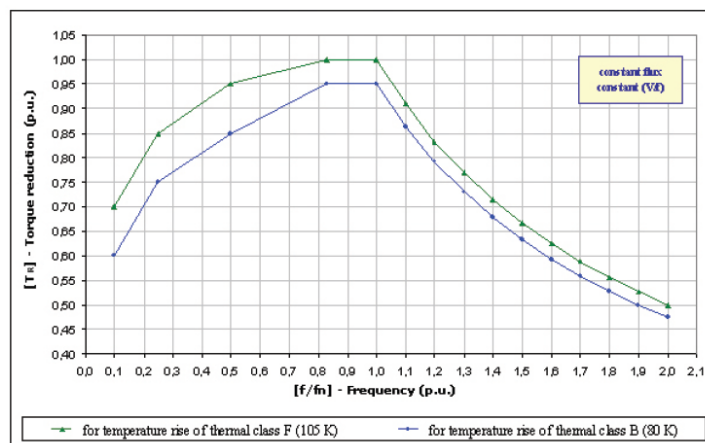
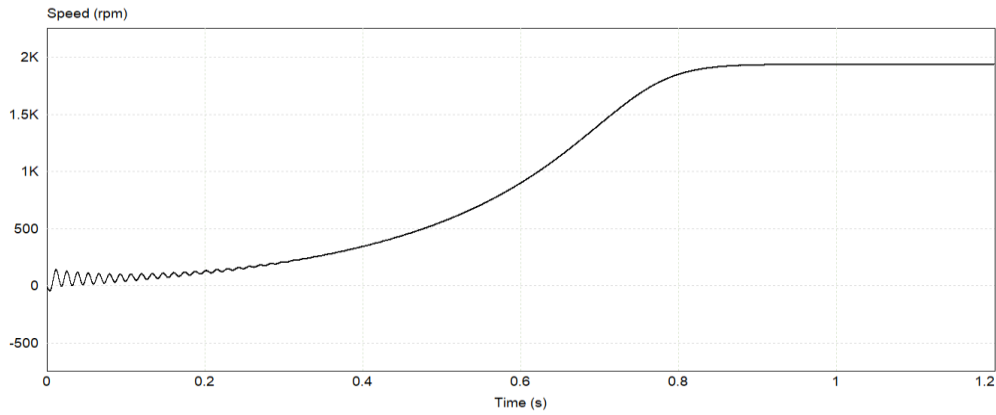
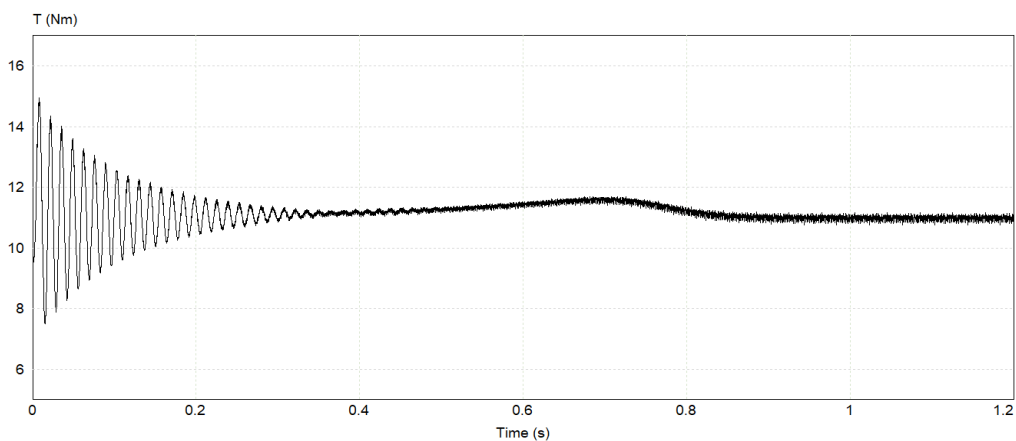

Fig. 10. Torque reduction for constant flux operation [10]

Fig. 11 presents the transient characteristics of speed, torque, and current for motor operation above the rated speed.



(a) speed



(b) torque

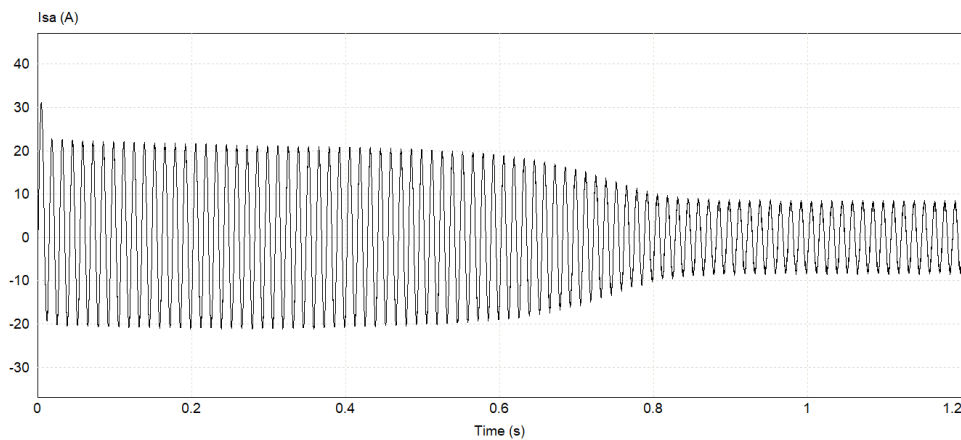

(b) current

Fig. 11. Motor characteristics above rated speed (supply with 75 Hz)

According to Eq. (3) expected motor speed is 2,000 rpm for a 75 Hz power supply. The obtained value of motor speed in Fig. 11 (a) is a little below the 2,000 rpm and corresponds to the expected theoretical value. According to Fig. 11 at 1.5 times the rated frequency, a torque reduction of 67% is expected, or for rated torque of 15 Nm, the torque reduction is 10 Nm. The obtained result of the simulation in Fig. 11 (b) presents the torque reduction from 15 Nm to 11 Nm, that agrees well with the expectations. As the motor operates at flux weakening region, the acceleration time of the motor is increased. By reducing the load, the acceleration time is decreased. The motor current after the acceleration time is finished, is reduced up to the rated

current, as the motor operates with constant power and constant voltage in flux weakening region.

The application of voltage source inverters in variable speed drives has many advantages and drawbacks. For the completeness of the analyses, we will name some of them. The main advantages are speed control, smooth controllable starting and stopping, energy saving through current limiting feature of the inverters, flexibility to set up and configure a variable speed drive for various applications, e.g. constant torque, variable torque, hoisting, and many others. One of the drawbacks is audible noise from the motor due to the various switching frequencies. To overcome this problem switching frequency can be increased but this also increases the harmonic content in the supply voltage, losses, and worsens the overall efficiency of the system. Another issue is Radio Frequency Interference (RF interference) generated by variable speed drives that can be very problematic, introducing faults on other equipment close to the installed unit. Apart from these, the harmonic content of the supply voltage from the inverter is responsible for poor power factor, excessive heating of neutral conductors (single-phase loads only), excessive heating of induction motors, and high acoustic noise from transformers, bus bars, switchgear, etc., abnormal heating of transformers and associated equipment, damage to power factor correction capacitors. Yet, the variable speed drives are an irreplaceable part of every industry, and their importance and development will continue in the years to come.

Conclusions

Variable speed drives are the prime moving force of many industries. The three-phase asynchronous squirrel-cage motor, despite all its drawbacks, still dominates in many industries, due to its robustness, simplicity, and low operational costs. The paper analyzes the operation of three-phase squirrel cage motor at various operating speeds, i.e. at, below, and above the rated speed.

The main goal of the paper is to illustrate the theoretical principles of operation of the asynchronous motor with the voltage inverter at a constant V/f ratio, supported by the corresponding analysis from the simulation. The simulation circuit from the software Powersim allows obtaining the transient characteristic of motor speed, torque, and current along with various operating voltages such as the voltage of the output of the inverter. The accuracy of obtained transient characteristics at rated speed is verified by comparing them with rated data of the motor obtained by analytical formulas. The accuracy of the obtained results at speeds below and above the rated speed is compared with available data from the motor producers who present the motor operating characteristics at frequencies different from the rated one. At lower speed, the motor can sustain the rated load as a constant V/f ratio is maintained. The motor operates within a constant torque region as described in section 2 of the paper. Above the rated speed, the motor enters the field-weakening region as the V/f ratio cannot be maintained constant i.e. the voltage is kept unchanged, but the frequency is increased. Motor enters the constant power region, where the capability of the motor to sustain the rated load is reduced. The presented simulation circuit is very useful in the analysis of variable speed drives with asynchronous motors, especially in cases where no experimental equipment is available. The theoretical principles of voltage-fed asynchronous motor can be analyzed and illustrated comprehensively. The simulation circuit allows analysis of various measuring quantities such as voltage or current at different points of the circuit. Furthermore, the Fast Fourier Transformation (FFT) can be performed on measured voltages allowing estimation of the power quality of the supplied voltage.

Further research should be focused on improving the harmonic content of the inverter voltage thus improving the overall operating characteristics of the drive system in terms of reduced losses and improved efficiency.

References

- [1] Annapurna, G: "Analysis of Induction Motor speed control fed from three phase inverter", International Journal of Engineering Development and Research, 8 (1), 2020, pp.1-6.
- [2] Kumar Dinesh: "Performance Analysis of Three-Phase Induction Motor with AC Direct and VFD", IOP Conference Series: Materials Science and Engineering, 331 012025, 2018, pp. 1-10.
- [3] Lane, M et al: "Investigation of reductions in motor efficiency and power factor caused by stator faults when operated from an inverter drive under open loop and sensorless vector modes", Systems Science & Control Engineering, 5 (1), 2017, pp. 361-379.
- [4] NaliniDevi, M/ Sudharan, S: "Open Loop Volts/Hertz Speed Control of Induction Motor with Voltage Fed Inverter", "International Research Journal of Engineering and Technology", 7(6), 2020, pp. 4497-4502.
- [5] Pande, Saurabh/ Singh, Saket: "Operation of Induction Motor with Different Modulation Index", International Research Journal of Engineering and Technology, 4(4), 2107, pp. 2002-2006.
- [6] Power System: Powesim, v.12.01.
- [7] R G van der Merwe / Hoogendoorn, C: "VSD advantages, disadvantages, selection criteria and installation tip", Energize, 2005, pp. 44-54.
- [8] Sharma, Mahima / Lalwani, Mahendra: "Performance Evaluation of Three-Phase Induction Motor Drive Fed from Z-Source Inverter", International Journal of Applied Engineering Research, 13 (8), 2018, pp. 6098-6109.
- [9] Technical: "Current, power and torque in variable speed drives", 2017, available at: <https://www.theautomationengineer.com/technical/current-power-torque-variable-speed-drives/>.
- [10] WEG "Induction motors fed by PWM frequency inverters", Technical guide, 2009.