

Med-Drop Final Report

Sponsor: Angel Avila

Members:

Cole Pike – capike@calpoly.edu

Taylor Morris – tmorri07@calpoly.edu

Jose Gomez – jgomez54@calpoly.edu

Christopher Bruni – cabruni@calpoly.edu

Statement of Disclaimer

Since this project is a result of a class assignment, it has been graded and accepted as fulfillment of the course requirements. Acceptance does not imply technical accuracy or reliability. Any use of information in this report is done at the risk of the user. These risks may include catastrophic failure of the device or infringement of patent or copyright laws. California Polytechnic State University at San Luis Obispo and its staff cannot be held liable for any use or misuse of the project.

Table of Contents

List of Tables	5
List of Figures	5
Executive Summary	7
Introduction	8
Project Management Plan	8
Background	8
Existing Products.....	9
Patents	10
Medication Types.....	12
Current Pill Boxes.....	14
Currently Available 3D Printers	15
PLA Adhesives	15
Objectives	15
Customer Requirements.....	16
Engineering Requirements	16
Design Development.....	18
Discussion of Conceptual Designs	18
Concept Selection	20
Proof of Concept Testing	22
Description of Final Design	27
Design Description	27
Detailed Design Description	29
Analysis	32
Concept Unit Cost.....	32
Material & Component Selection	33
Safety	33
Maintenance & Repair.....	33
Product Realization.....	33
Manufacturing Processes	33
Future Manufacturing & Cost Estimation.....	35
Design Verification.....	35
Testing Descriptions.....	35

Detailed Results	36
Specification Verification Checklist.....	37
Conclusions and Recommendations.....	38
Acknowledgements	38
References	39
Appendices	42
Appendix A. QFD Table and Decision Matrices	42
Appendix B. Final Drawings	45
Appendix C. Vendor Information.....	52
Appendix D. Component Data Sheets	53
Appendix E. Gantt Chart	59
Appendix F. Product Guide for User	60
<i>Step one: Acquire container and patient’s medications.</i>	60
<i>Step two: Flip the container to the sorting tray side.</i>	60
<i>Step three: Remove the Velcro loops from the side of the container.</i>	61
<i>Step four: Add medication to the sorting tray.</i>	61
<i>Step five: Sort medication so only one pill is in each slot.</i>	62
<i>Step six: Move excess pills to the exit funnel and push the excess pills back into the pill container...</i>	62
<i>Step seven: Pull the acrylic sheet to allow the medication to fall into each of the pill boxes.</i>	63
<i>Step eight: After sorting and dispensing all of the medications, replace the Velcro loops.</i>	63
<i>Step nine: All medications are now sorted into the patient’s pill boxes.</i>	64
<i>Step ten: Patients can now access their pills each day by opening that day’s lid.</i>	64
Appendix G. Safety Check List	65

List of Tables

Table 1. Engineering Requirements Table.....	18
Table 2. Unit cost for 100-unit production.....	32
Table 3. Testing for Engineering Specifications.....	37

List of Figures

Figure 1: Hero Pill Dispenser (Hero Medication Manager and Pill Dispenser, n.d.).....	9
Figure 2: MedaCube Pill Dispenser (MedaCube, n.d.).....	9
Figure 3: Figure from patent No. 9849069B1.	10
Figure 4: Figure from patent No. 9849069B1.	10
Figure 5: Figure from patent No. 20120103985A1.....	11
Figure 6: Bead counting tray (Beazu, n.d.).	12
Figure 7: Lisinopril tablet (U.S National Library of Medicine, 2020a).	12
Figure 8: Metformin Hydrochloride (Drugs.com, n.d.).	13
Figure 9: Omeprazole capsule (WellRx, n.d.).....	13
Figure 10: Capsule size chart (Capsuline, n.d.).	13
Figure 11: Standard 4-week pill box (ForgettingthePill.com, n.d).....	14
Figure 12: 1-month AM/PM pill box (ForgettingthePill.com, n.d).	14
Figure 13: Pill box with alarm reminder (e-pill, n.d.).....	15
Figure 14: Concept A.....	19
Figure 15: Concept B.....	19
Figure 16: Original Pill Tray Concept - Nurse Side.	21
Figure 17: Original Pill Tray Concept - Patient Side.	21
Figure 18: 3D printed, miniature pill container with 'L' shaped latch.....	22
Figure 19: 3D printed, PETG weekly pill container.	22
Figure 20: 3D printed, ramped pill container.	23
Figure 21: 3D printed, ramped pill container.	23
Figure 22: 3D printed, magnetic pill container lid.	24
Figure 23: 3D printed, detent pill container lid.	24
Figure 24: 3D printed toggle latch mechanism, standalone.....	25
Figure 25: 3D printed toggle latch, attached to pill containers.....	25
Figure 26: 3D printed locking, click-pen mechanism, assembled.	26
Figure 27: 3D printed locking, click-pen mechanism, disassembled.	26
Figure 28: 3D Printed mini sorting tray.	26
Figure 29: Compliant lid mechanism inspiration.	27
Figure 30: The back side of the design where the nurse will sort the pills.	28
Figure 31: The pill organizer side that the patient will interact with.	28
Figure 32: Exploded view of the final design.	29
Figure 33: Model of single pill box.....	30
Figure 34: Model of Sliding Rail System.	31
Figure 35: Model of sliding rails and acrylic sheet.	31
Figure 36: Sorting Tray.....	32
Figure 37: Sorting tray prototype being 3D printed.	34

Figure 38: Pill box lids being 3D printed.	34
Figure 39: Individual Time Comparisons	36
Figure 40: Time Comparison - Average	36
Figure 41: QFD Table of Customer and Engineering Requirements.....	42
Figure 42: Cole Pike’s Pugh matrix.	43
Figure 43: Taylor Morris’s Pugh matrix.	43
Figure 44: Jose Gomez’s Pugh matrix.	44
Figure 45: Chris Bruni’s Pugh matrix.....	44
Figure 46: Exploded Assembly Drawing and Bill of Materials.	45
Figure 47: Container Cap Part Drawing.	46
Figure 48: Single Pill Box Part Drawing.	47
Figure 49: Slider Rails Part Drawing.....	48
Figure 50: Sorting Sheet Part Drawing.	49
Figure 51: Sorting Tray Part Drawing.....	50
Figure 52: Assembly Layout Drawing.....	51
Figure 53: Page 1 of Hatchbox PLA Filament Safety Data Sheet (Hatchbox, 2016).	53
Figure 54: Page 2 of Hatchbox PLA Filament Safety Data Sheet (Hatchbox, 2016).	54
Figure 55: Page 3 of Hatchbox PLA Filament Safety Data Sheet (Hatchbox, 2016).	55
Figure 56: OnlineMetals Aluminum 6061-T6 Material Data (OnlineMetals, n.d.).	56
Figure 57: OPTIX Acrylic Sheet Material Data (Plaskolite, n.d.).	57
Figure 58: Starbond NO-05 Starbond Infiltrant Odorless Thin CA (Starbond, n.d.).	58
Figure 59: Starbond NO-05 Starbond Infiltrant Odorless Thin CA - Continued (Starbond, n.d.).	58
Figure 60: Gantt chart of the schedule to complete this project.....	59
Figure 61: Closed Patient Container Side	60
Figure 62: Closed Nurse Side	60
Figure 63: Remove Velcro Loops	61
Figure 64: Add Pills to Sorting Tray.....	61
Figure 65: Sort Pills on Sorting Tray.....	62
Figure 66: Remove Excess Pills if Necessary	62
Figure 67: Pull Sheet	63
Figure 68: Replace Velcro Loops.....	63
Figure 69: Pills in Patient Container.....	64
Figure 70: Patient Container Lid Open	64
Figure 71: Project safety checklist.....	65

Executive Summary

The Med-Drop team was tasked by Angel Avila on behalf of the Veterans Affairs (VA) to design a pill dispenser to make it easier and faster for VA nurses to dispense medications. The patients in this program have approximately 15 to 40 unique medications per day that need to be sorted into monthly pill containers by the VA nurses. This process takes nurses approximately 30 minutes to 2 hours to complete for each patient and limits the number of patients that the nurse can see in a day.

Initial solutions revolved around the idea of using a handheld mechanism that would dispense exactly one pill for every press or actuation. Multiple mechanisms that would dispense medication in this way were considered, but none seemed ideal for the problem at hand. The biggest concern was that any mechanism that was designed would need an actuation force that could form a repetitive motion injury in the nurse that is using it.

After considering these ideas, the concept of a combined sorting tray with the monthly pill containers built into the other side was proposed. This idea solved many of the potential issues with a handheld mechanism: repetitive motion injuries, compatibility with any sized/shaped pill, accuracy, and cost reduction. The concept also allowed for the customer requirements to be updated to improve the patients pill containers to better suit their needs. This included adding a slanted front to make reaching the pills easier and making the containers bigger to hold the larger quantities of medication.

For a time, there were two versions that were being developed side by side. The first version was the solid month version that would be printed in one print bed. The other version was one that would allow for the weeks to separate from each other. After talks with the project sponsor, Angel Avila, the focus was narrowed to only the solid month version as that would be the most widely used and best example of the concept.

Further refinement of the idea led to the final design that is shown on the cover page and throughout the report. This solution has met the design constraints that were given/devised and reduced the time to dispense the medication by more than 50% in testing completed during the project. This solution is the most effective way to solve the problem at hand and the delivered product looks like one that could be purchased in a store.

The concept will continue to be refined by the project sponsor, Angel Avila and her coworkers, and will be pitched to others within the VA. Angel will also be doing a scale test with about 20 units with real patients to get experience with the pill container in the near future. If the concept is picked up by the VA, it could be implemented in VA hospitals across the country and eventually may be something that any person could purchase.

Introduction

The Pill Dispenser project is a Veterans Affairs (VA) sponsored effort brought to Cal Poly to create a portable device that would be used by nurses during home visits to distribute medication to VA patients. This project was created by Angel Avila, an employee of the Santa Fe VA Healthcare system in New Mexico, in the hopes of reducing the time VA nurses spend filling out monthly prescription doses to veterans who are unable to leave their homes. As it stands, this process can take anywhere between thirty minutes to two hours, depending on the amount of medication the patient is prescribed. The final goal of the project is to create an easily used, portable device that can be left at a patient's home and be used by a visiting VA nurse to quickly and accurately dispense monthly amounts of medication in the patient's pill boxes with no need for the nurse to dispense individual medications by hand. This device would reduce the amount of time that nurses spend dispensing medications and allow the nurses to visit more patients throughout the day. Although this project begins in the Santa Fe VA Healthcare System, there are 1,243 VA health care facilities across the US and US territories (U.S. Department of Veterans Affairs, 2018), that could potentially benefit from the success of this project.

Project Management Plan

Cole Pike will be the point-of-contact with the project sponsor, Angel Avila. Cole is a Manufacturing Engineering Major, with relevant experience in design for manufacturing principles in additive and net shape processes and 3D CAD modeling. Other relevant experience is in design of experiment principles, statistical quality tools, and product/process design.

Taylor Morris is a Mechanical Engineering Major and has previous design experience from mechanical engineering classes taken at Cal Poly, as well as some manufacturing process knowledge from courses taken for her manufacturing concentration. She also has industry project management experience from two summer internships.

Christopher Bruni is a Mechanical Engineering Major, with experience in mechanical design utilizing 3D CAD software as well as performing detailed engineering analysis from classes taken at Cal Poly. In addition, he has experience with product design and development from a previous internship.

Jose Gomez is an Electrical Engineering Major, with a background in designing circuits and code that drive mechanical systems obtained through various Cal Poly labs. He also has a small background in science of materials from multiple classes on the topic and participating in a nano materials project for the Naval Post Graduate School.

A Gantt chart of when the deliverables were met is shown Appendix G. They are organized by Cal Poly student quarters. The majority of the project consisted of prototyping different ideas and presenting them to the project sponsor, then integrating her feedback before repeating the cycle.

Background

To dispense a patient's monthly medication, nurses drive to the patient's house and gather the month's supply of medication. Due to COVID-19 restrictions, the medication is currently being left outside of the patient's home, and the nurse must dose out the medication outdoors, either on a porch or standing. The nurse individually doses out the required medications into a monthly medication calendar. These medications are grabbed and placed one at a time to ensure that the dosage is exact. This process can take anywhere from thirty minutes to two hours. After all required medications have

been dosed out for the month, the nurse can check in with the current patient before moving on to the next patient.

Existing Products

In preliminary searches, there were multiple products that tackle the issue of providing medication to patients on time and in the correct quantities. One of these devices, HERO, provides an all-in-one automated solution to dispensing medication. This device not only touts that it can dispense a months' supply of 10 different medications regardless of their shape, but also its Wi-Fi connectivity and ease of use. This functionality comes at a high cost, with HERO requiring a \$99.99 startup fee along with a \$29.99 monthly subscription fee. An image of the dispenser is shown in Figure 1 (Hero Medication Manager and Pill Dispenser, n.d.).



Figure 1: Hero Pill Dispenser (Hero Medication Manager and Pill Dispenser, n.d.).

MedaCube, as pictured in Figure 2., functions in a very similar way to HERO, however it can store up to a 90-day supply of 16 different medications. Like HERO this product comes at a very high price of nearly \$1500 for a new machine (MedaCube, n.d.).



Figure 2: MedaCube Pill Dispenser (MedaCube, n.d.).

In addition to these pill dispensing products, PillPack was found. PillPack is a service offered by Amazon Pharmacy that delivers a patient's medication presorted into small packets based on when the pills should be taken (Pill Pack, n.d.).

While all these products seem like good options for individual consumers, none of them can be considered viable options for Angel Avila because of the cost and logistics of each solution.

Patents

After running a search on Google Patents, several mechanisms showed up that could be useful in the design phase of this product. One of these patents was for a container with a lid that would dispense a single pill after each button pressed. This design used a funnel to place the pills in the correct orientation then two overlapping slots to only allow one pill to be dispensed at a time. This is more clearly displayed in Figures 3 and 4 below.

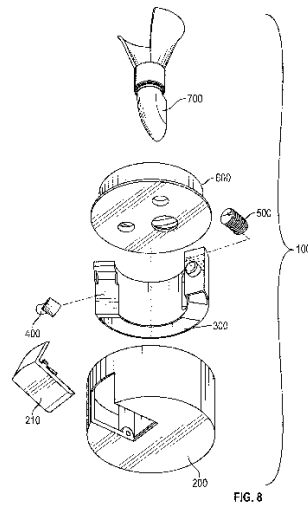


Figure 3: Figure from patent No. 9849069B1.

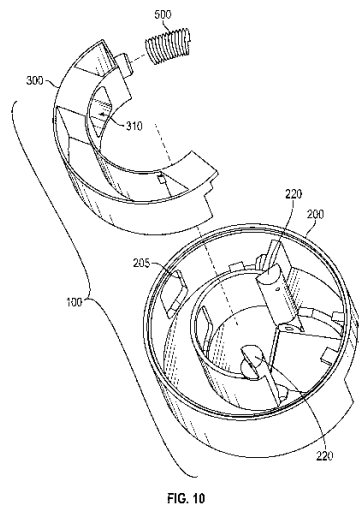


Figure 4: Figure from patent No. 9849069B1.

As seen in the figure, the pills are initially funneled into the inside slot, then when the button is pressed the slot rotates to line up with the exterior slot dispensing the pill (Jayesh K., 2016).

Another patent, which was a container like the previous patent, uses a spring-loaded arm actuated by a tab on the cover to only allow one pill to be dispensed at a time.

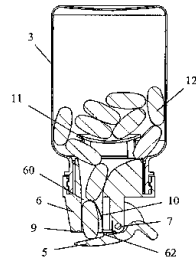


FIG. 14

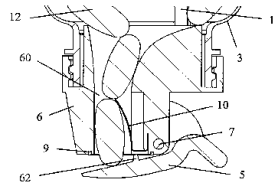


FIG. 15

Figure 5: Figure from patent No. 20120103985A1.

As seen in Figure 5 above, when the lid is opened the tab pressing on the spring-loaded lever is released allowing it to cover the dispenser opening before another pill can be dispensed (Joshua D., Hubert Y., Paul D. ,2011).

In addition to these two patents, a method of counting beads was discovered that could be adapted for use with pills.



Figure 6: Bead counting tray (Beazu, n.d.).

This method uses a dimpled board such as the one pictured above in Figure 6. The beads are then spread out across this board and fall into each one of the dimples. The excess beads are discarded, and the board is then filled with an exact number of beads. This concept could be translated easily for use with different pill shapes and sizes with larger, less precise dimples.

Medication Types

Angel Avila also recommended that, given the wide variety of shapes and sizes of pills currently on the market, the focus should initially be on the device functioning for the five most common pills given to VA patients. These five medications are Lisinopril, Metformin, Omeprazole, Sertraline, and multivitamins. Lisinopril is a circular tablet, like the pill shown in Figure 7 (U.S National Library of Medicine, 2020a). Metformin can be a circular tablet or an elongated oval shape, like the pill shown in Figure 8 (Drugs.com). Sertraline is also an elongated oval shape. Omeprazole is a typical capsule shape like the pill shown in Figure 9 (WellRx). Each of these medications can vary slightly in size based on the dosage and manufacturer.



Figure 7: Lisinopril tablet (U.S National Library of Medicine, 2020a).



Figure 8: Metformin Hydrochloride (Drugs.com, n.d.).



Figure 9: Omeprazole capsule (WellRx, n.d.).

Multivitamins can also vary in size and shape based on the specific vitamin and manufacturer. The largest capsule size commonly manufactured is size 000, but the most common are 00 and 0 (Capsule Sizes, n.d.). A size chart showing all the sizes and dimensions is shown in Figure 10.

capsuline[®] capsule sizes

Empty Capsule Volume Capacity (ml)										
Capacity	1.37	1.00	0.90	0.78	0.68	0.48	0.36	0.27	0.20	0.13

Empty Capsule Weight Capacity by Formulation Density (mg)										
0.6 g/ml	822	600	540	468	408	288	216	162	120	78
0.8 g/ml	1096	800	720	624	544	384	288	216	160	104
1.0 g/ml	1370	1000	900	780	680	480	360	270	200	130
1.2 g/ml	1644	1200	1080	936	816	576	432	324	240	156

Empty Capsule Overall Closed Length										
(mm)	26.1	25.3	23.4	23.5	21.6	19.4	17.6	15.7	14.3	11.1
Tolerance (mm)	±0.3	±0.3	±0.3	±0.3	±0.3	±0.3	±0.3	±0.3	±0.3	±0.4
Inches	1.029	0.996	0.921	0.909	0.85	0.764	0.693	0.618	0.563	0.437
Tolerance (in)	±0.012	±0.012	±0.012	±0.012	±0.012	±0.012	±0.012	±0.012	±0.012	±0.016

Empty Capsule External Diameter										
Cap (mm)	9.91	8.58	8.56	7.65	7.64	6.96	6.39	5.85	5.33	4.91
Cap (in)	0.390	0.338	0.337	0.301	0.301	0.274	0.252	0.230	0.210	0.193
Body (mm)	9.55	8.25	8.23	7.36	7.35	6.63	6.12	5.60	5.08	4.68
Body (in)	0.375	0.376	0.322	0.289	0.289	0.290	0.240	0.220	0.200	0.184

Figure 10: Capsule size chart (Capsuline, n.d.).

Current Pill Boxes

We were told that all the VA patients provide their own pill boxes and that there were many variations in the types of pill boxes in use. These include a standard 4-week pill box like the one shown in Figure 11, as well as variations of this that account for pills taken in the morning and at night, as shown in Figure 12, or even some that account for the afternoon. In addition to these, some pill boxes have additional features like alarms to remind the user to take their medication. An example of an alarmed pill box is shown in Figure 13.



Figure 11: Standard 4-week pill box (ForgettingthePill.com, n.d).

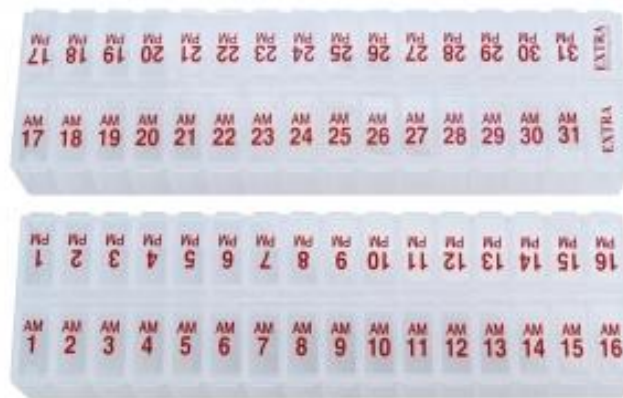


Figure 12: 1-month AM/PM pill box (ForgettingthePill.com, n.d).



Figure 13: Pill box with alarm reminder (e-pill, n.d.).

Currently Available 3D Printers

Angel Avila also said that many VA sites have 3D printers available for use and would like this design to be able to be 3D printed. While the VA sites have a wide variety of 3D printers in use, two of the more common models are Formlabs resin printers and Lulzbot TAZ filament printers. There are currently three models of Formlabs printers available to purchase, with a build volume ranging from 5.7 x 5.7 x 7.3 inches to 13.2 x 7.9 x 11.8 inches (Formlabs, n.d.). There are two models of Lulzbot TAZ filament printers, both with a build volume of 11 x 11 x 11.2 inches (Lulzbot, n.d.). The average price of standard stereolithography (SLA) resins is approximately \$50/L but can be as costly as \$500/L for high quality surface finishes and special material properties (All3DP, February 2019). In comparison, the average price of PLA filament can be approximately \$25/kg but can get as high as about \$95/kg (3DInsider, 2017).

PLA Adhesives

The current design requires gluing different PLA parts together into one solid piece. There are many different methods of adhering PLA parts together, such as hot glue, polyurethane and silicone glues, and plumber's cement. However, for the purposes of the project, ethyl cyanoacrylate superglue is the best option. It creates a very strong bond, dries and cures within a few minutes, and is also inexpensive and easily accessible (All3DP, March 2019).

Objectives

The overall goals of the project are to create a product that would be seamlessly integrated into a nurses' routine and allow them to distribute medication more efficiently to those in their care. This project will create a solution that is simple, cost-effective, and most importantly, safe.

Before engineering requirements were developed for the project, a meeting with the project sponsor, Angel Avila, was arranged to understand the requirements from the customer/user's point of view and create a list from those requirements. Once this list of customer requirements was created, corresponding engineering requirements were made to be quantifiable and testable. When developing the engineering requirements, a fair number are binary points that either pass or fail. A full list of the requirements is available in Table 1, the Engineering Requirements Table. Additionally, a full Quality Function Deployment (QFD) table is available as Figure 41 in Appendix A. The QFD table is a way to

match the customer requirements with the quantifiable and measurable engineering requirements, and to weigh each requirement's importance.

Customer Requirements

Having a line of sight to dispensed pills is necessary to ensure that the nurses only administer one pill at a time. The nurses currently pick up and dose one pill at a time by hand to ensure accuracy. Additionally, there needs to be a line of sight to verify that the mechanism is empty to ensure that a lingering pill from a previously dosed medication is not still in the mechanism when switching between medication types.

The device will be designed to dispense no pills in the case of an error rather than dispense multiple pills. This would be verifiable by the clear line of sight to the ejection area and would prevent risk of overdose. The dispenser would be first and foremost designed to be compatible with the five most common medications that are prescribed to VA patients, and then expanded to other medications. This requirement would allow for the device to be of service to the widest demographic of patients under VA care.

Unit cost is desired to be as low as possible and should utilize 3D printing for all nonstandard parts necessary to the mechanism. The two most common 3D printers VA hospitals have on hand are Lulzbot TAZ filament printers and Formlabs resin printers.

The customer required lifespan of the product is desired to be the same as the time that the patient spends in the care of the VA. As given by the customer, the average time a patient is in their care is two to five years and the average number of medications administered to each patient per day is ten to fifteen, with the highest being twenty-five medications per day.

The device's internal pill storage is to be enclosed as to reduce the risk of external contaminants and to be easily emptied of any excess pills after the dosage is completed. The enclosure will reduce, if not eliminate, the risk of pills being dropped on the ground. Pills dropped on the ground are considered lost.

The customer required that the device be cleanable in the case that it was accidentally dropped into any sort of dirt, mud, or other contaminant while being used by a nurse, or if the device were to become dirty through regular use or storage.

The main goal of the final product is to reduce the work time for the nurse that is dispensing the pills. The requirement as given by the customer is a 50%-time-reduction from the average time of thirty minutes to two hours per patient. The 50%-time-reduction should be treated as the minimum for the improvement on the current process.

The device should have a manageable grip, be steady in the hand, compact, and have an easy actuation for any mechanism(s).

Engineering Requirements

There are many requirements that have a binary pass/no pass form of verification that they have been met. These engineering requirements in Table 1 have requirements listed as n/a. The engineering requirements that fall in this category are line of sight to ejected pills, line of sight to verify the mechanism is empty, the device's internal storage is enclosed, material does not react with room

temperature water and mild soap, and that the mechanism can be used ambidextrously. For the requirements that could be quantified, the explanation of their values is below.

A unit cost target is set at less than \$20. This was reached using the average cost of a 1 kg spool of filament, approximately \$20. Less than one spool should be used on printed parts, and any other portion of the unit cost shall be used on standardized and readily available parts.

Of the 5 most common pills given to VA patients, the largest are multivitamins. Given that the largest pill capsules are approximately 1.03 inches long, a minimum hole size in the sorting tray of 0.85" x 0.85" will easily fit most pills, and still allow the largest pills to fall through at an angle. Angel Avila requested that each individual pill box be able to hold at least 15 large multivitamins. The most common capsule sizes are 00 and 0, with volumes of approximately 1.46 mL and 1.35 mL per capsule, respectively. To fit 15 of these capsules, each box would need a minimum of 21.9 mL of internal storage. To account for some larger pills and air gaps between pills while being stored, a requirement of at least 30 mL of internal storage in each box is necessary.

The part of the design expected to be most heavily used is the lid on each day's pill container that will be opened and closed when accessing the medication. Ideally each lid would only be opened and closed once every 28 days, but Angel Avila said that some patients may open the lid more than once a day. The estimated worst case would be that a patient would open and close a lid four times every 28 days, or 52 times per year. To account for a minimum lifespan of the design of 5 years, each lid will need to be able to last at least 260 cycles before failure.

The total volume of the Lulzbot TAZ filament 3D printer was used to create a volume engineering requirement of less than 11" x 11" x 11". All 3D printed parts for at least one mechanism for the product need to fit within this print volume.

Table 1. Engineering Requirements Table

Spec. #	Parameter Description	Requirement or Target (units)	Tolerance	Risk	Compliance
1	Line of sight to dispensed pills	Pass	n/a	L	A, I
2	Line of sight to verify the mechanism is empty	Pass	n/a	M	A, I
3	Unit cost	<\$20	Max.	M	A
4	Max # pills dispensed = 1	100%	0.001%	H	A, T, I
5	Dispenses most common pills	0.85" x 0.85"	±.05	H	A, T, I
6	Lifespan for mechanism	260	Min	H	T
7	Device's internal storage enclosed	Pass	n/a	L	A, S
8	Time reduction	50%	Min.	H	T, S
9	Can be 3D printed on VA printers	11x11x11 in	Max.	L	A, T
10	Material does not react with soap & water at room temperature	Pass	n/a	L	A, T, S, I
11	Device weight	5 lb.	Max.	M	A, T
12	Ambidextrous operation	Pass	n/a	L	A, T, S
13	Holds 15 multivitamins	≥30mL	Min.	M	A,T,I

Design Development

Discussion of Conceptual Designs

The project began with an initial mechanical concept provided by the project sponsor Angel Avila. The design was a mechanism that would hold the month's supply of pills in an enclosed environment and use mechanical actuation to dispense individual pills to a patient's pill box. From this initial idea the team performed several ideation sessions to develop concepts that could potentially be used in the final design. At first the team focused on developing concepts for components and methods that would be used to dispense the medication. From this point the focus moved from dispensing methods to pill alignment and accommodation for differing pill sizes, as this was seen to be one of the largest hurdles that the mechanical system would face. Shown below are several concepts that were products of the ideation sessions. Concept A, as seen in Figure 14, was a concept that would handle pill alignment by having the medication be either funneled into a "magazine" (represented in the image by the purple tube) in a desired orientation or being preloaded by the nurse into a detachable "magazine" and then dispensed using a piston to push the pill out. Although this concept did handle the issue of pill alignment and differing pill sizes by having the option of preloaded "magazines" being used, it lacked the clear visibility of the medication that was desired by the customer. The design also ran the potential for damage to the medication if the pill was not properly aligned and the piston mechanism was activated, applying a shear force to the pill, and causing chipping or cracking.



Figure 14: Concept A.

Concept B, as seen in Figure 15, was a concept geared towards being able to dispense multiple pill sizes by having a wheel separated into segments with different sized slots as seen in the figure. This would allow the dispensing process to accommodate multiple pill sizes and shapes with ease. However, this design did come with some large drawbacks; the first of which being that it lacked the clear view of the medication that was required by the customer. The design's second flaw was that, although it could accommodate multiple pill sizes and shapes, it lacked a way to ensure that only one pill would be able to enter the section at a time. This problem would be exacerbated in the presence of smaller pills that would potentially cause multiple pills to be dispensed at once. This problem could be worked around by implementing different wheel designs that would be specifically designed for different pill size "ranges". However, this solution causes unnecessary complexity in the design and requires the wheel to be interchanged every time pill sizes change to a different "range". This would make the design less effective in the main goal of cutting the time required to dispense medication by requiring the nurse to take time to change parts. Additionally, the design would require a much more complex mechanism that would take more purchased parts, and more time spent in complex assembly of the product.

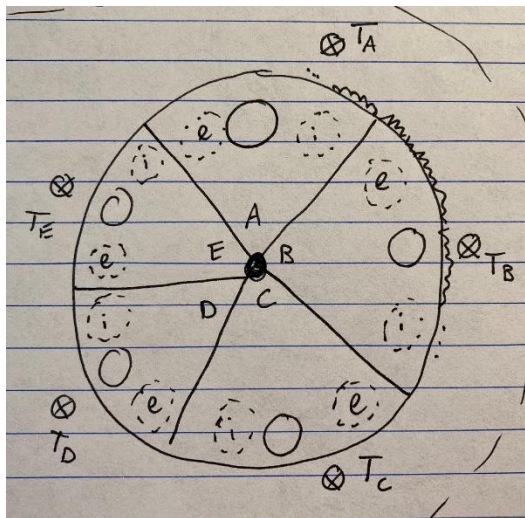


Figure 15: Concept B.

Throughout the ideation process, the main concern that continued to be unresolved was the balance between accommodating multiple pill sizes and being able to accurately dispense one pill at a time. The two most effective concepts that were developed, as seen above, came close to balancing the two but would fall short in one of the two aspects and would ultimately require a large amount of accommodation to fix the issues.

Concept Selection

As ideation continued, the concept of approaching the project from a different angle was pitched. Instead of approaching with the initial concept of a handheld mechanism to dispense the medication, the focus would be on the pill boxes themselves. A concept was developed to integrate the sorting process into the pill box, allowing a more simplistic design that has the potential to be much more efficient.

This design would integrate a medication sorting tray into the bottom of the monthly pill box to allow for a more simplistic process that puts less strain on the user. The pill box and sorting tray would be separated by an acrylic sheet that would act as a false bottom for the pill box. The sorting tray would provide the nurse with an open-faced textured surface that would allow for quick and easy dispensing of the medication, shown in Figure 16, below. Dispensing the medication would be performed by pouring multiple pills at once and using the textured surface to sort and isolate the allotted amount of medication for each day. Once the appropriate amount of medication was dispensed for each day, the acrylic sheet would be pulled, allowing for the isolated pills to drop down into their respective pill box cells. As the project has progressed the design has undergone some changes, such as changes to the texture pattern and splitting the sorting tray into its own separate piece. These changes will be discussed later in the paper.

Once all the sorting is completed and the pill box is full of medication, the patient will interact with the device on its other side. The patient side of the device, shown in Figure 17, below, has standard pill boxes with removable lids that hold the patient's medication for the month.

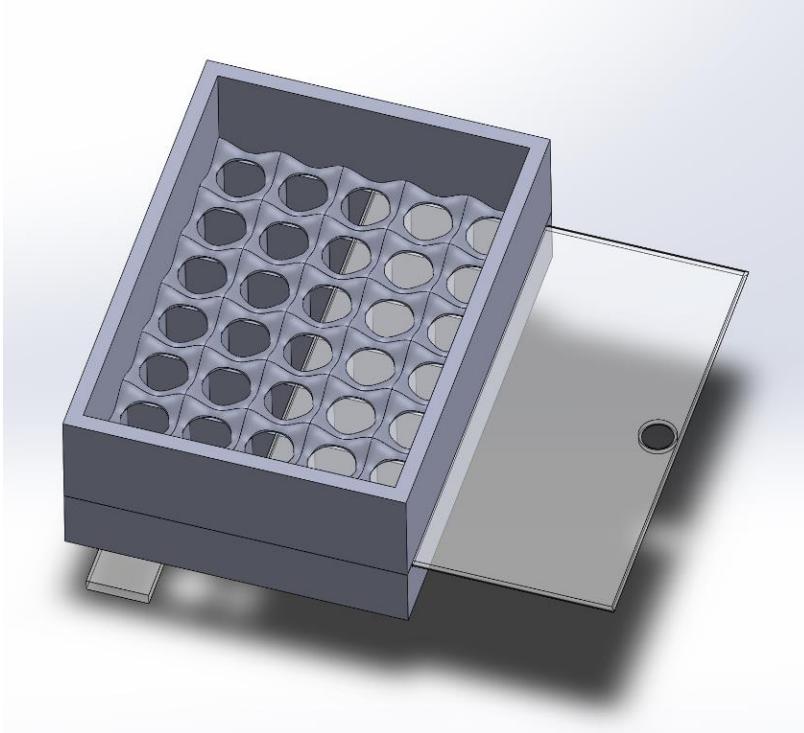


Figure 16: Original Pill Tray Concept - Nurse Side.

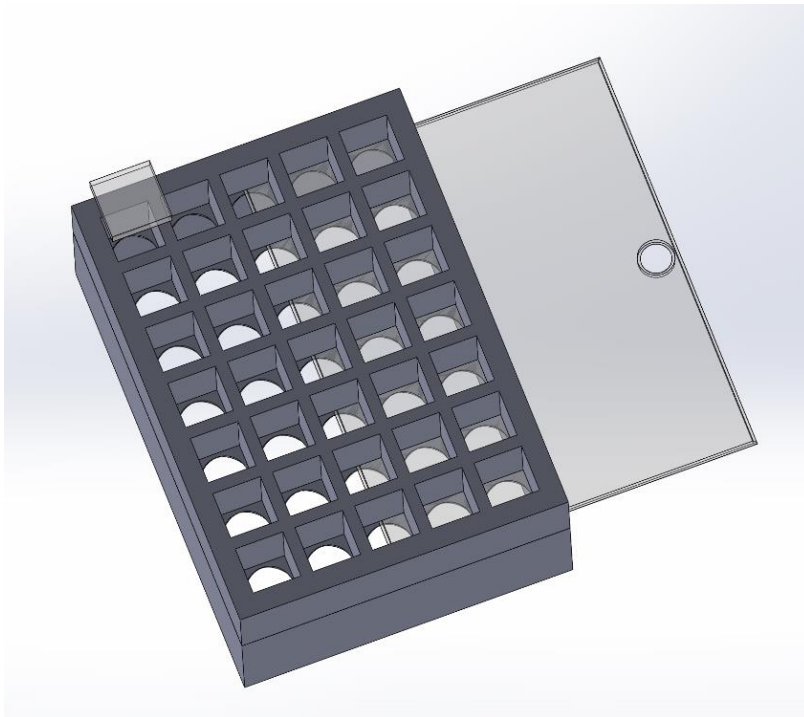


Figure 17: Original Pill Tray Concept - Patient Side.

Proof of Concept Testing

During concept development, specific aspects of the design were tested for their functionality and performance. These aspects include the pill box shape, lid closing mechanisms, methods to connect weeks together, sheet locking mechanism, and the sorting tray.

The very first test run was on a miniature 3D printed pill box with a hinge and 'L' shaped latch, shown in Figure 18. This box was a good initial test and revealed a few issues that had not been considered prior. The first issue was that the tolerancing of the 3D printer was apparent from this test. The hinge on the lid interfered on the top of the container, making it stick in position when opened/closed, and on the bolt used as a hinge. The other issue was that the 'L' shaped latch (not pictured) snapped off immediately during use, despite being printed in the 'strong' layer line orientation.



Figure 18: 3D printed, miniature pill container with 'L' shaped latch.

The next test that was performed was using a malleable material, PETG. The weekly pill container shown below in Figure 19, was mildly flexible. However, the lids would snap off if they were moved too quickly without being 'broken in.' This material allows for remelting, so with the use of a hair dryer the hinges were melted into the closed position shown on the right of Figure 19. When cooled, these lids held closed too well and would not stay open unless perched on the edge of the container. Additionally, the hinge required a large area to bend sufficiently to close the container.



Figure 19: 3D printed, PETG weekly pill container.

After deliberation with the project sponsor, the volume of the pill containers needed to meet a volume of 30ml and be easier to reach for the patients than current pill containers on the market. This design shown in Figure 20 implemented that volume constraint with a round cross-section to prevent pills from getting caught in corners and an inclined cavity to make it easier to 'scoop' pills out. The angled shape of this container proved to be awkward and made it as hard if not harder to reach pills from the very bottom of the container as there is an overhang.

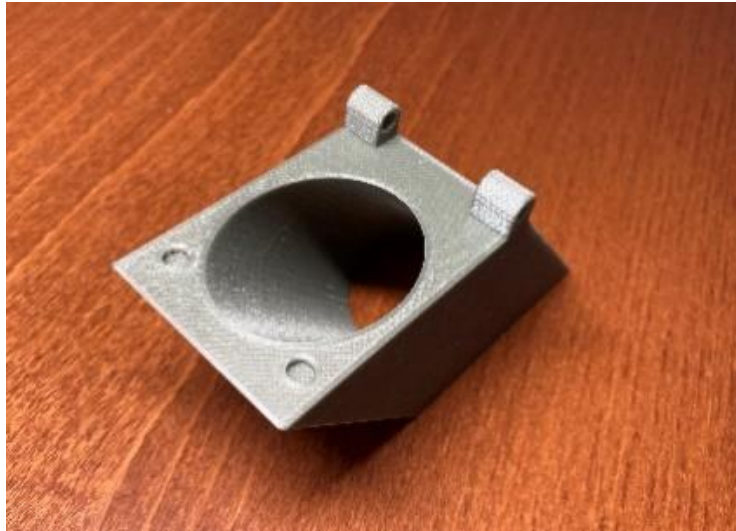


Figure 20: 3D printed, ramped pill container.

The next iteration of the pill container, shown in Figure 21, utilized a front ramp surface to make sure it is easier to reach without the overhang of the previous pill container. An intermediate iteration had a ramp on the back surface as well but was later deemed to be unnecessary. This shape was the most effective at reaching pills at the bottom of the container as well as 'scooping' pills out.



Figure 21: 3D printed, ramped pill container.

To keep the lids of the pill containers closed, a few methods have been tested. The first of which utilized magnets, as shown in Figure 22. This method was very satisfying to use but is not practical. The

lids do not stick well enough to truly be confident that they would stay on during normal use, let alone if the assembly was dropped. The lids under the current magnet configuration would be difficult to assemble or use in daily life as they are not interchangeable between day. Lastly, the magnets each must be superglued into place which is time consuming and tricky as the magnets tend to jump out and stick to each other.

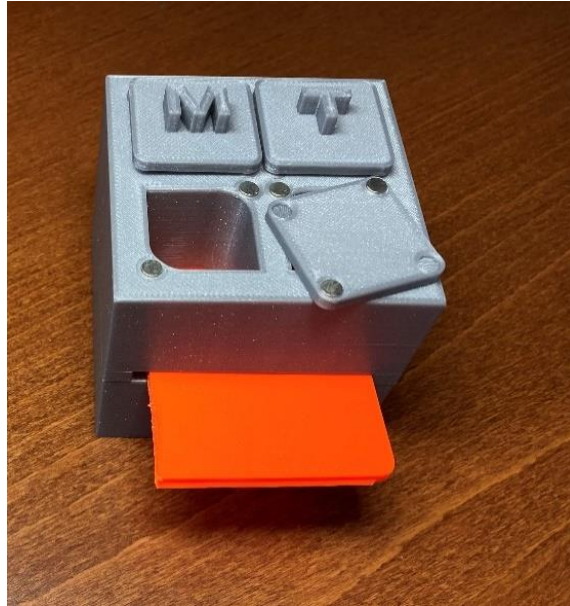


Figure 22: 3D printed, magnetic pill container lid.

The next test for a lid closing mechanism was a spherical detent added to the lid of a smaller test box, as shown in Figure 23. The first iteration of this did not hold very well, so the detent size was increased. This new version was successful at keeping the lid closed.



Figure 23: 3D printed, detent pill container lid.

One additional request Angel made was that the box be able to split up into separate weeks so that if a patient wanted to travel, they would be able to carry their medication without having to carry the entire months' worth of pills. To keep the weeks connected when the nurses are sorting, a toggle

latch was tested, shown in Figure 24. Initially the latch was tested as a standalone item, then glued to the sides of two test boxes, Figure 25. While this latch seemed like it would work in theory, the PLA was slightly too flexible and the tolerances of 3D printing not tight enough for a completely secure hold.



Figure 24: 3D printed toggle latch mechanism, standalone.



Figure 25: 3D printed toggle latch, attached to pill containers.

Another issue that could have come up with the sheet(s) that act as the base of the pill containers is that they could come loose during use and lead to the medication being spilled or dropped. To avoid this, various locking mechanisms have been designed. The locking mechanism shown below in Figure 26 is based off a click-pen mechanism. The use of this is to click and lock into place with a pin that locks into a hole on the sorting tray sheet to prevent it from sliding out. This testing involved reverse engineering the mechanism in a pen to be adapted to a 3D-Printable object that could be integrated into the product. Some components were taken directly from the pen, including the small white and black plastic pieces shown in Figure 27. Another piece used for testing was a drywall nail in place of the pen cartridge.

While this solution somewhat worked, it was not reasonable to use this many purchased pieces as it would drive up the cost and add complexity to the manufacturing assembly process.



Figure 26: 3D printed locking, click-pen mechanism, assembled.



Figure 27: 3D printed locking, click-pen mechanism, disassembled.

The tests run on the separable device were ultimately not as successful as desired, so after a discussion with Angel, optimizing the non-separable box became the priority.

To test the sorting tray texture concept, a small-scale version was 3D printed with a sinusoidal texture to make it easy to pass pills from one day to the next, shown in Figure 28. This test validated the concept as it was functional and effective at sorting medication. The full-scale version would eliminate any close calls with clearances for larger medications, like the one shown in Figure 28.



Figure 28: 3D Printed mini sorting tray.

As the project evolved and changed shape, the spherical detent shown previously was changed to a compliant mechanism, like those shown in Figure 29. This allowed for larger detent mechanisms which aided in manufacturability as well as repeatability of the prints regardless of print orientation. Additionally, it allowed for much better tactile and auditory feedback when opening and closing to give the user confidence that the lid is closed and will remain closed.

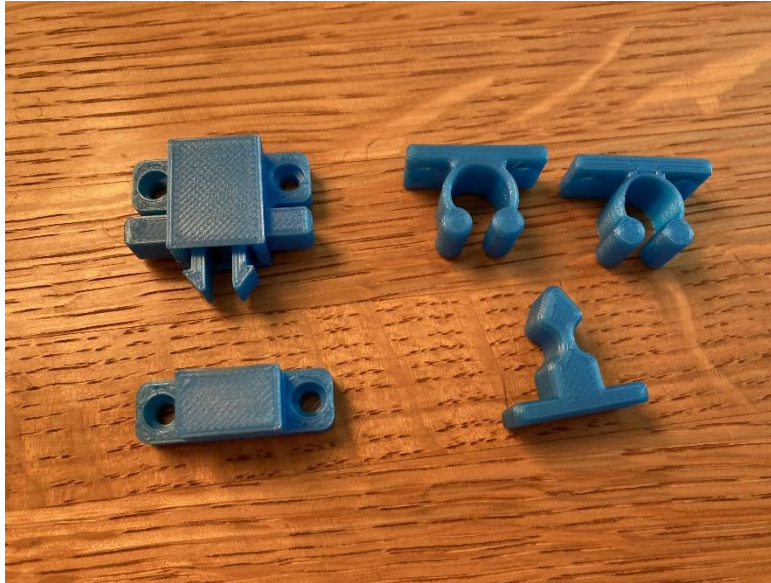


Figure 29: Compliant lid mechanism inspiration.

Description of Final Design

Design Description

The final design concept was selected using Pugh Matrices to determine which designs met the design requirements the best. The integrated tray/pill box design performed the best across all the Pugh Matrices, which are shown in Appendix B. Particularly, it excelled at allowing the nurse clear view of all the pills as they are being dispensed, working with several pill shapes and sizes, having easy dispensing actuation, long product life, and being cleanable.

The current design is very similar to the original concept but required some changes. The new design has two primary interlocking pieces, one for the nurse to interact with and one side for the patient to interact with, as opposed to one solid unit. The side that the nurse interacts with, shown in Figure 30, has a contained area with individual slots for each day of the month. There are sweeping ridges between those slots to act as barriers in the effort of keeping the pills to one slot per month. The ridges are sloped to allow for pills to easily be moved between adjacent pill slots. Underneath these slots is a removable sheet that serves as the base for each week while the pills are being sorted. The sides of the tray are also labeled with the corresponding day of the week, so the nurses are able to easily dispense pills that are only taken on specific days. Once the medication is sorted for the month with one pill in each slot, the sheet can be slid out, allowing the medication to fall into the pill container underneath. Any excess medication that would be present during the sorting process would be sorted into the bottom right corner and would be allowed to slide onto the funnel back into the pill bottle. This would allow the nurse to empty any excess medication back quickly and easily into the pill bottle

without the need to pick them out by hand. This cycle can be repeated until all necessary medications have been dispensed.

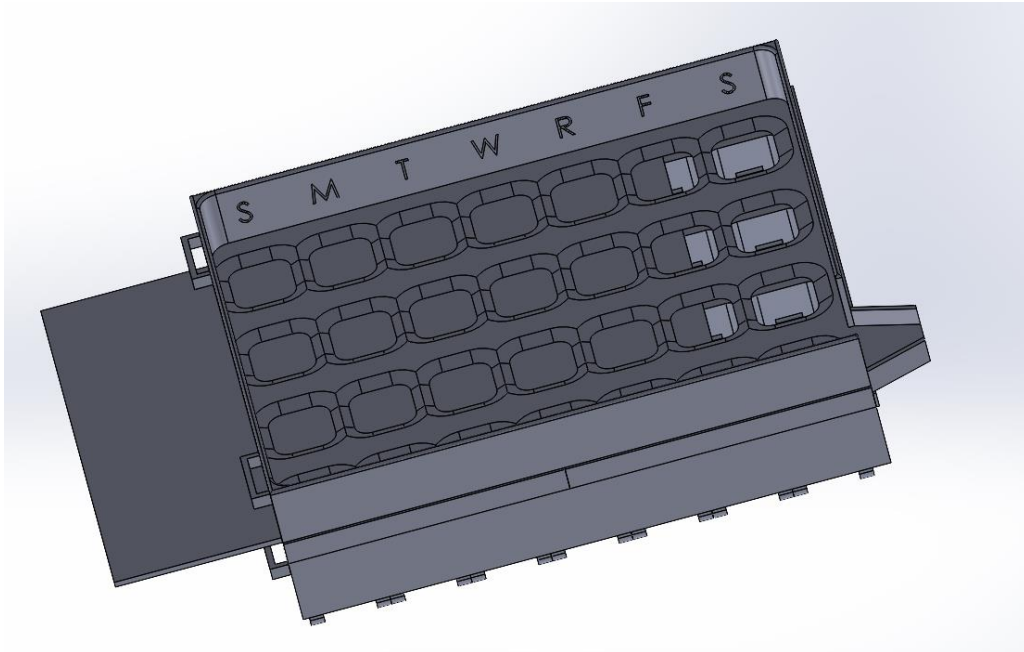


Figure 30: The back side of the design where the nurse will sort the pills.

The side that the patient interacts with, shown in Figure 31, has a container for each day of the month with the sheet as the base, and a closing cap to contain the medication. A patient would open the cap for the relevant day to get the medication for that day.

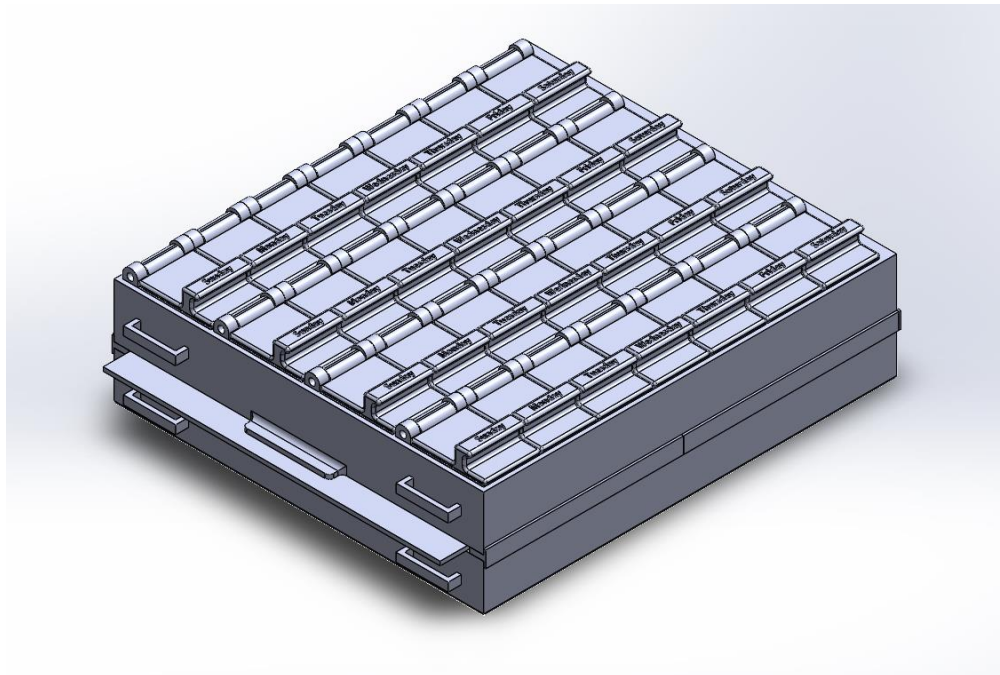


Figure 31: The pill organizer side that the patient will interact with.

This design concept meets the customer requirements as they are mentioned earlier in the document. Specifically, line of sight to all pills while in the mechanism and as they are dispensed is especially easy with this design as the pills in the containers prior to removing the sheet are all easily visible. The maximum number of pills dispensed being equal to or less than 1 is easily controlled as it is easy to view all the individual pills in their respective container prior to removing the sheet. This design is flexible in its ability to accommodate all expected potential pill sizes, as there are no tight tolerance sections. This design has fewer moving parts than other concepts so it will have a long product lifespan relative to a more complex dispensing mechanism. The internal storage is enclosed, with only the top of the mechanism able to open to the elements. This solution will significantly reduce the time required to dispense the medication, as the process is greatly simplified and allows for all 28 pills to be dispensed at once. All custom parts can be ordered at a low cost or be 3D printed, with all 3D printed parts able to be printed within the required workspace. Weight estimates of the product are under the limit of 5lb. Lastly, the device is completely ambidextrous.

Detailed Design Description

Below, in Figure 32, is an exploded view of the final design showing how the complete pill box, lids, and sorting tray fit together. The thin spacer that can be seen separating the pill box and sorting tray is a rail system that is used to guide the acrylic sheet and ensure that it cannot accidentally be taken out during use and potentially lost or damaged.

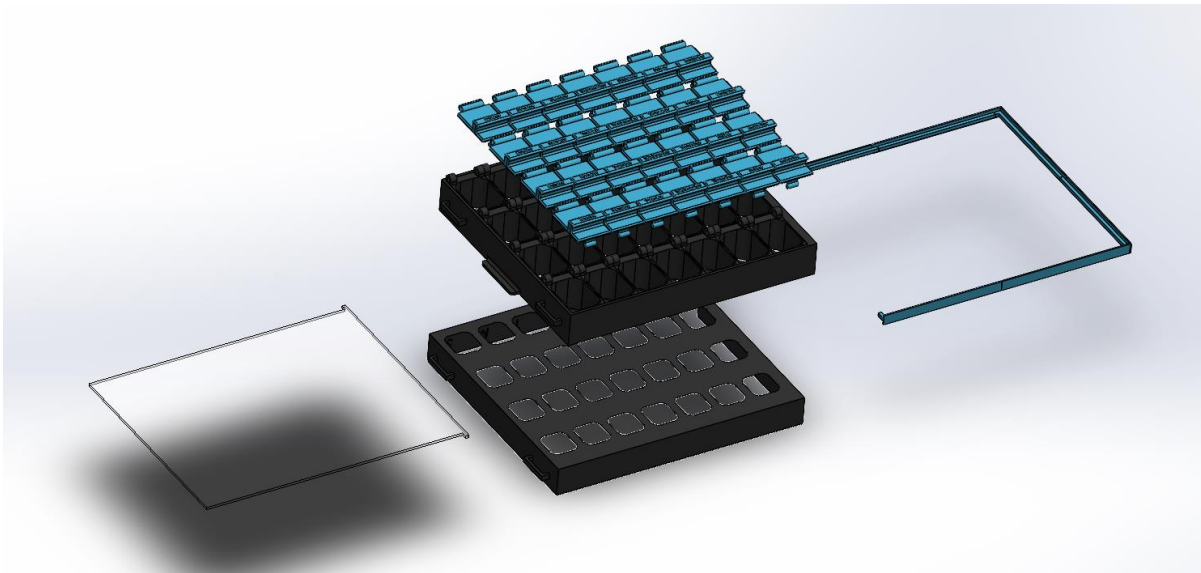


Figure 32: Exploded view of the final design.

A model of a single pill box cell is shown below in Figure 33. The front inside wall was given an angle to allow the patient to easily remove medication without needing to invert or tip the box. The inside geometry has been carefully designed to ensure that the interior volume of the box met the initial engineering specification of at least 30mL. The box is closed with a 3D printed lid that is secured in place using a pliable “arm” as shown in the Figure 33. The “arm” interfaces with a pocket on the inside of the pill container. The lids are designed with a raised lip on the top side to allow for easy opening.

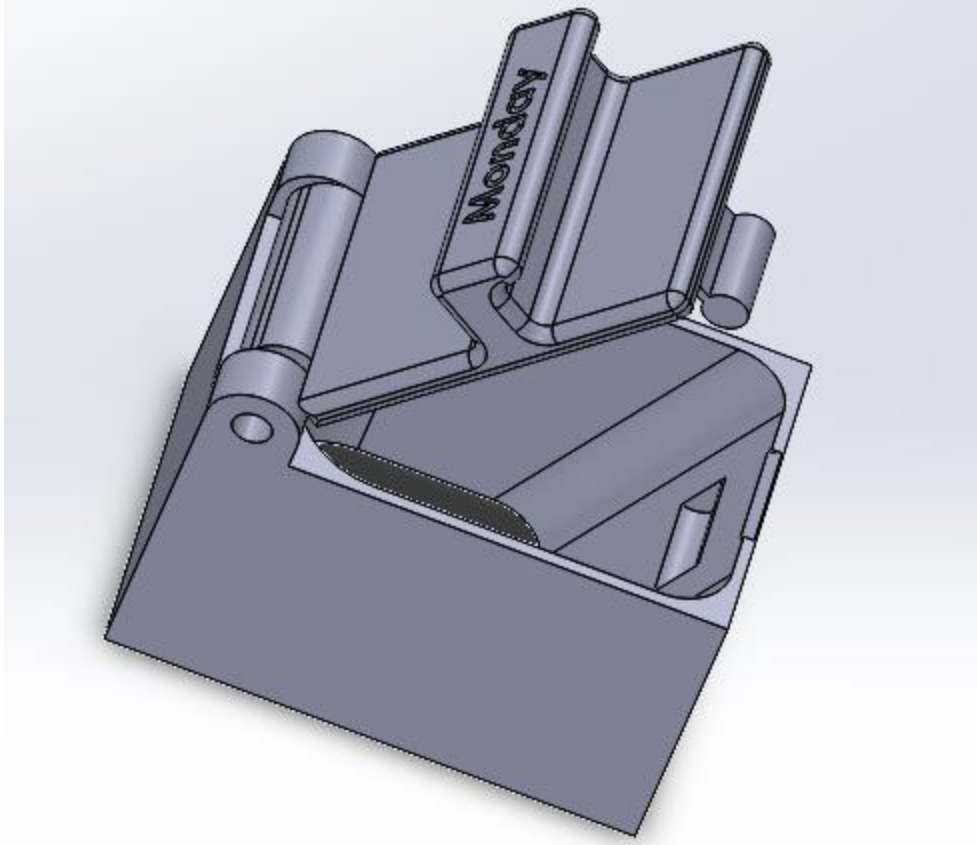


Figure 33: Model of single pill box.

A model of the sliding rail system used to accommodate the box's acrylic sheet is shown below in Figure 34. The rails guide the acrylic sheet when the box is in use by a nurse and ensures that the sheet cannot be removed, minimizing the chance of accidentally losing or damaging the sheet. This system also separates the two sides of the design and ensures that the box and sorting tray elements are aligned properly so that no medication is erroneously dispensed.

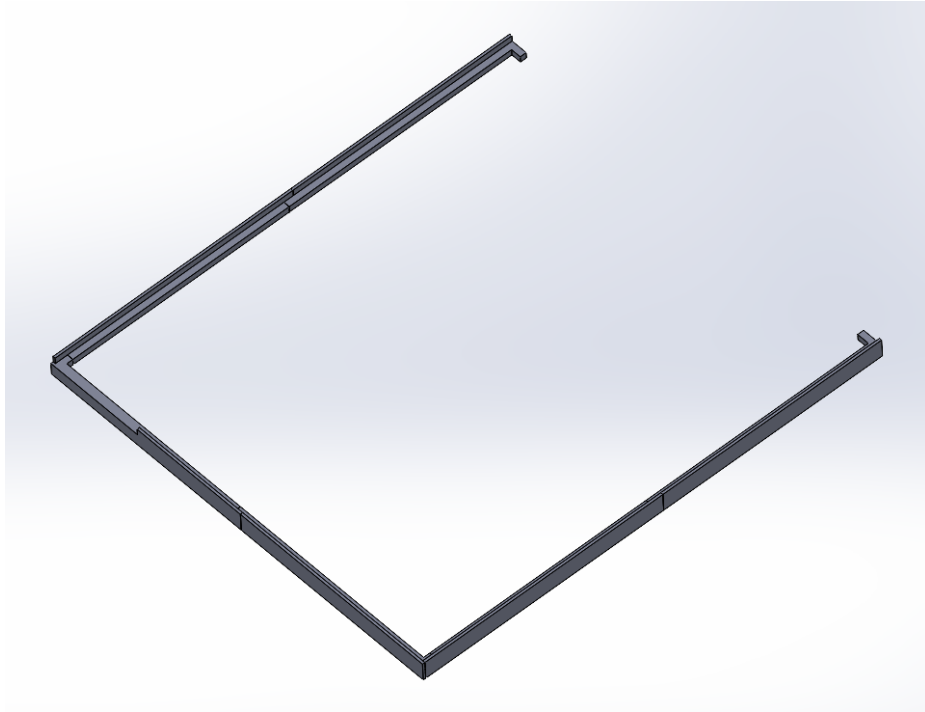


Figure 34: Model of Sliding Rail System.

Below, in Figure 35, a top-down view of the sliding rails and acrylic sheet models is shown to demonstrate how the rails prevent the sheet from being removed. As seen in the figure, the rails are designed to catch the “T” shape in the acrylic sheet and ensure that there is no possibility of it being removed.

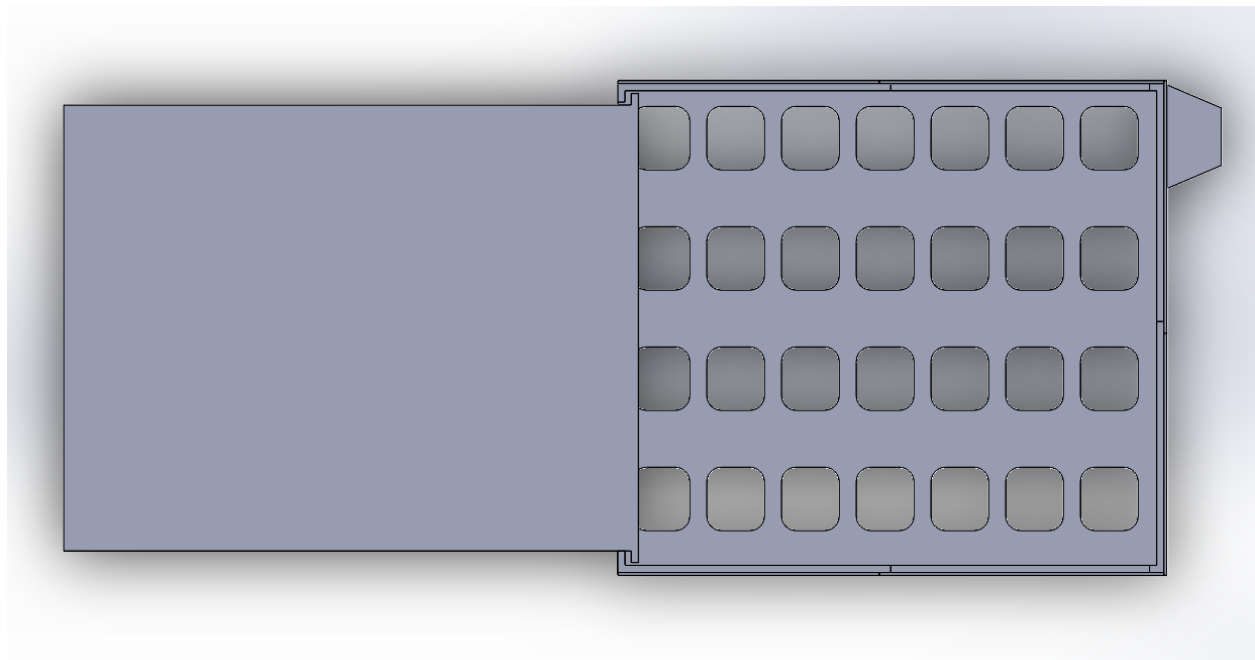


Figure 35: Model of sliding rails and acrylic sheet.

A model of the sorting tray is shown below in Figure 36 which has 28 slots to match up with the 28 pill containers in a 4-week grouping of the pill box. The chamfers around each slot allow the nurse to easily move pills from slot to slot to efficiently sort medication. A funnel was added to the bottom right corner of the tray to allow the nurses to quickly return excess medication to its prescription bottle. The tray also has the days of the week labeled on its side to ensure the nurses are placing medication in the correct pill boxes. All detail drawings and bill of materials can be found in Appendix C.

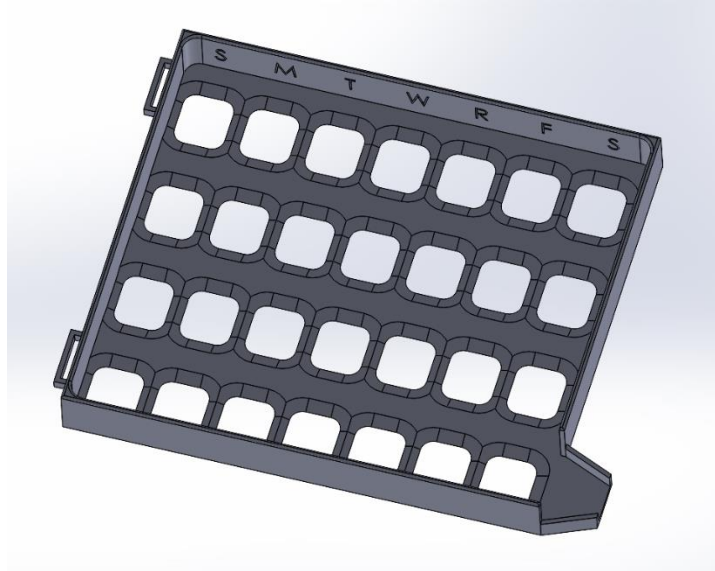


Figure 36: Sorting Tray.

Analysis

To ensure that the lid design would be able to perform the required 260 cycles during its lifespan, cycle tests were performed on 10 prototype lids. Each lid was put through 520 cycles of opening and closing. There was no visible damage at the end of the testing, and each lid was still secure when in the closed position.

Concept Unit Cost

Below in Table 2 are rough estimates of what it would cost to produce a small batch of this design using 3D printing for small scale production (100 units). This price could be brought down if the items were bought in larger bulk or if there are items the VA already has access to. The current unit cost is under the required budget and has the potential to continue decreasing.

Table 2. Unit cost for 100-unit production.

Item	Purchase Cost	Amount per Unit	Cost per Unit
PLA Filament	\$20/kg	0.939 kg	\$18.78
1/8" Diameter Aluminum Rod	\$0.48/ft	4 rods	\$1.92
.093" Acrylic Sheet	\$29.72/24"x48" sheet	1 10"x 8.15" sheet	\$2.97
Odorless Ethyl Cyanoacrylate Superglue	\$8/oz	.035 oz	\$0.28
Total			\$19.89

Material & Component Selection

PLA filament was selected as the primary material as it is the most common and affordable material for 3D printing and is compatible with the VA's Lulzbot TAZ printers. Hatchbox brand PLA will be ordered for this project, which is available on Amazon.

For the 1/8" diameter rod that acts as the axle for the lids on the boxes, aluminum rod is the most inexpensive option that suits the project. The rods will be ordered from OnlineMetals.com in 12" long sections and trimmed upon arrival using wire cutters.

Pieces of 0.093" thick acrylic will be utilized for the sorting tray. A 24"x48" sheet ordered from Amazon is enough to make 10 sliding sheets for the device and can be cut to the desired shape using a saw or laser cutter.

A 2oz bottle of odorless super glue made by Starbond will be used to adhere components in the assembly. Super glue is the most common adhesive for PLA 3D printing. While typical super glue releases vapors that leave a white 'ghosting' on the surface of the 3D prints, odorless superglue does not release that same vapor or residue.

The contact information for each of these vendors is in Appendix D. The component data sheet for each product is in Appendix E.

Safety

Our design will help to mitigate the chance of outside contaminants to the pills with its enclosed design and limited handling of the pills, as well as its ability to be easily sanitized. The clear line of sight to the pills will also help the nurses visually verify that each dosage is correct before the pills are placed into the box. However, even with these improvements the design still retains the inherent risk of human error in the dosing of the pills, but the device does not add any additional risk compared to the nurses' current system. An additional hazard identification checklist that accounts for common design hazards is shown in Appendix H.

Maintenance & Repair

Maintenance of the device can be done with routine cleaning with mild detergents and lukewarm water. Inspection and preventative maintenance of the components to identify future areas of potential repair will prevent failure during patient use. Ensuring proper storage of the assembly will prevent damage from falls, UV deterioration, or heat.

As most of the parts that are needed in the final design are 3D printed, most required replacement parts can be printed on their own and replaced. Assembly methods in some areas are intended to be permanent using super glue. The lids, hinge pins, and sliding sheets can all be replaced with minimal disassembly.

Product Realization

Manufacturing Processes

All parts of this design will be 3D printed using the 3D printers and PLA filament at the VA facilities, except for the metal rods that attach the lids and the superglue. Images of the sorting tray and

lids being printed are shown in Figures 37 and 38 below. The only external parts that will need to be purchased are the acrylic sheets and metal rod. Four 1/8" diameter, 12" long aluminum rods are used for the axles of the box lids and were cut to size using bolt cutters. The sorting tray, pill boxes, sliding rails, and lids are all printed separately. It is assembled by using superglue to adhere the sorting tray and pill box on either side of the sliding rails, and the lids are attached via the aluminum hinge pins. The total time to print the pill box, sorting tray, sliding rails, and 28 lids is approximately 57.5 hours. The estimate for gluing the necessary parts and attaching the lids and latches is approximately 20 minutes.

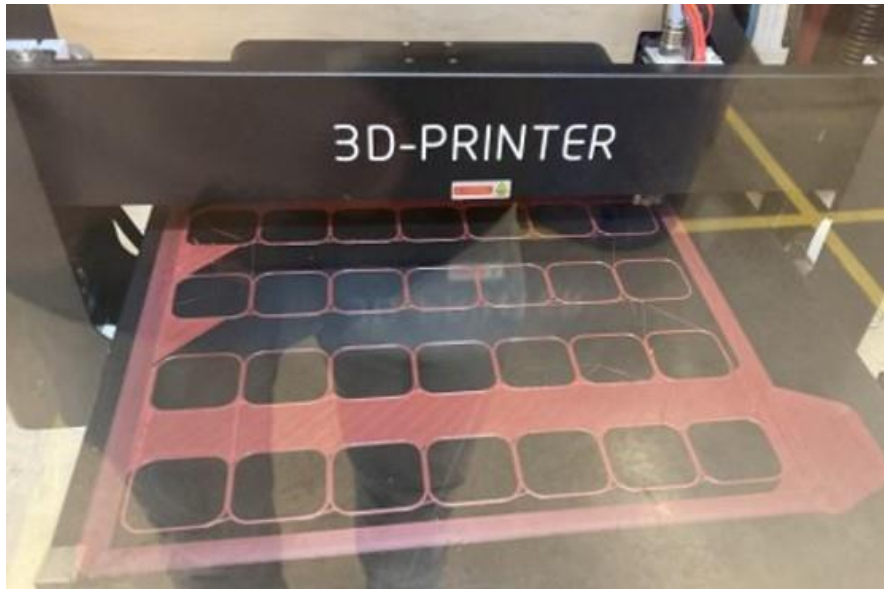


Figure 37: Sorting tray prototype being 3D printed.



Figure 38: Pill box lids being 3D printed.

Future Manufacturing & Cost Estimation

Using 3D printing as a manufacturing method for this design is useful for prototyping and low production volumes, but ultimately is not very efficient for high production volumes. If this device were to go into large scale production, it would be a great candidate for injection molding. A rough cost estimation for injection molding was found using ICOMold's cost estimator (ICOMold, n.d.). The part complexity level used in the estimation was "medium-high", with a production run of 100,000 parts in a common thermal plastic. The tooling cost was approximately \$10,000 and each of the parts cost approximately \$2.

Design Verification

Testing Descriptions

To test the design, there is a testing method specific to each of the engineering specifications, shown in Table 3.

Of the 13 specifications, 5 of them were tested by visual inspection on a pass/fail basis. These included having a clear line of sight to the dispensed pills, a clear line of sight to ensure the mechanism is empty, no more than 1 pill is dispensed at a time, the device's internal storage is enclosed, and the device can be used ambidextrously. Each of these requirements passed the inspection.

To determine the unit cost, a 3D printing slicer software was used to find the amount of PLA being used and its corresponding cost, and the costs of the rods was added. The final cost estimate for one device was \$19.89, which is within the required budget.

The dimensions of the sorting tray holes was verified to meet the specifications by utilizing SolidWorks' dimensioning function. SolidWorks dimensioning also ensured that each piece will fit within the VA's 3D printers and that the internal volume of each pill container meets the 30mL minimum volume. The final dimensions of the sorting tray holes were 1"x1.1", the overall dimensions were 10.8"x8.5", and the final internal volume of the pill container was 32.675mL, which pass the requirements.

To ensure that the lids will last for at least 260 cycles of being opened and closed, the lids were to be manually opened and closed either until failure or twice the required number of cycles (520 cycles). 10 of the lids were put through 520 cycles of opening and closing. There was no visible damage at the end of the testing, and each lid was still secure when in the closed position.

The final design's weight was confirmed by weighing the final print using a scale. The final weight of the device was 1.59lb, which is significantly less than the 5lb requirement.

To determine the approximate time reduction in filling a patient's pill box that the design has achieved, a time study was completed to compare the amount of time it takes to fill a box with a month's worth of pills using the current method versus using the sorting tray. The time study covered three different users, six different types of pill shapes/sizes, four trials for each pill, and the two different box types. The current method used a pill container purchased from Rite Aid to serve as the control. The scope of the time trial is from when the pill container holding the medication is opened until the pills are all sorted into the monthly pill boxes and the pill container is closed again.

Detailed Results

Box and whisker plots of the time comparison between the Rite Aid traditional pill container and the “Med Drop” container are shown below in Figures 39 & 40. The figures show the results found by Cole, Taylor, Jose, and an average, respectively. The figures also show the percentage improvement of the two devices. On average, time to fill a 28-day pill container with one pill in each container was reduced by 54.87%. Additionally, the “Med-Drop” pill container was much less dull to use and was easier on the user as they did not have to reach for individual medications.

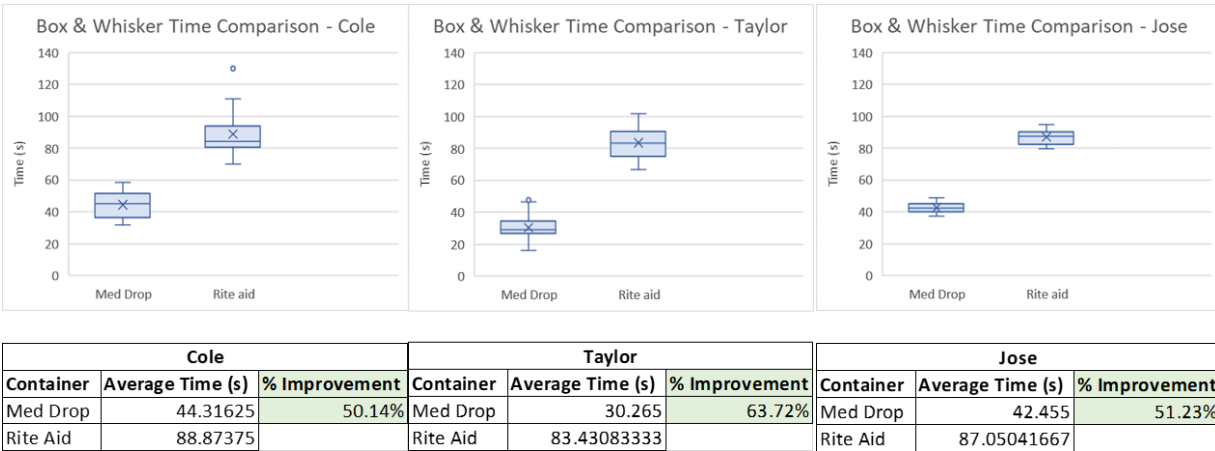


Figure 39: Individual Time Comparisons



Figure 40: Time Comparison - Average

Specification Verification Checklist

Table 3 below shows the relevant specifications that were required of the final product, as well as the criteria needed to pass, and the actual results found.

Table 3. Testing for Engineering Specifications.

Item No.	Specification or Clause Reference	Test Description	Acceptance Criteria	Test Results	Test Responsibility
1	LOS to Dispensed Pills	Visual Inspection - pass/fail	no fail	Pass	Cole
2	LOS to Verify Mechanism is empty	Visual Inspection - pass/fail	no fail	Pass	Cole
3	Unit Cost	Slicing software PLA cost estimate, unit cost analysis of purchased parts	Cost < \$20	Pass	Cole
4	Max pills dispensed = 1	Inspection - pass/fail	no fail	Pass	Chris
5	Dispenses most common pills	Verify dimensions of sorting tray holes in CAD software	no fail	Pass	Chris
6	Lifespan for mechanism	3D printed prototype cycle testing open/close	>260 cycles	>520 cycles	Chris
7	Device's internal storage enclosed	Visual inspection - pass/fail	no fail	Pass	Jose
8	Time Reduction	Prototype time study of filling a pill box	50% Time Reduction	54.87% Time Reduction on Average	Jose
9	3D printable on VA printers	Individual parts fit within VA printer dimension - pass/fail	no fail	Pass	Jose
10	Cleanable with soap and water	Test and inspection for degradation - pass/fail	no fail	Pass	Taylor
11	Weight	Mass properties of part simulation	Weight < 5lbs	Pass	Taylor
12	Ambidextrous Operation	Inspection - pass/fail	no fail	Pass	Taylor
13	Fits 15 Multivitamins	Part simulation volume calculation	Volume >30mL	32.675mL	Taylor

Conclusions and Recommendations

This project resulted in an easy-to-use device for VA home care nurses to quickly distribute their patients' monthly medication. The device satisfied all engineering requirements and received high praise from the project sponsor. The design is as simple as possible to avoid damage or additional repair. The design also mitigated other issues that were not in the original brief, such as the container size and shape of current pill containers. Lastly, the testing time trials of the final solution show a 54.87% improvement over the nurses' current medication distribution method. The next step for the project sponsor, Angel Avila, will be to produce a batch of twenty containers to extensively test them in the field. Once proven successful, the next steps will be to pitch the idea to others within the VA. If the product is to be made in high production volumes, the design should be altered to be ideal for injection molding that would be able to keep up with that production rate.

Acknowledgements

We would like to thank our sponsor, Angel Avila, and our advisor, Jim Widmann, for all their support throughout this experience. This has been a great learning experience for us all and would not have been possible without the two of them.

References

- 3DInsider. (2017, September 10). *How Much Does 3D Printing Filament Cost?* <https://3dinsider.com/3d-printing-filament-cost/#:~:text=Regular%20PLA%20and%20ABS%20filament,as%20four%20times%20this%20amount.>
- All3DP. (2019, March 13). *Gluing 3D Printed Parts: Best Ways to Bond Your 3D Prints.* <https://all3dp.com/2/gluing-3d-printed-best-ways-bond-3d-prints/>
- All3DP. (2019, February 11). *How Much Do 3D Printing Materials Cost?* <https://all3dp.com/2/how-much-do-3d-printer-materials-cost/#:~:text=The%20average%203D%20printer%20material,which%20costs%20%2458%20per%20liter.>
- Beazu. (n.d). *4 Piece EZ Bead Counter Set.* [https://www.beazu.com/36895-four-piece-ez-bead-counter-set.html.](https://www.beazu.com/36895-four-piece-ez-bead-counter-set.html)
- Canadian Centre for Occupational Health and Safety. (2015, October 1). *Hand Tool Ergonomics – Tool Design.* [https://www.ccohs.ca/oshanswers/ergonomics/handtools/tooldesign.html.](https://www.ccohs.ca/oshanswers/ergonomics/handtools/tooldesign.html)
- Capsule Sizes. (n.d.) *Capsule size chart fill weight and capacity comparison.* [https://www.capsulesizes.com/capsule-size-chart/.](https://www.capsulesizes.com/capsule-size-chart/)
- Capsuline. (n.d). *Clear Size 000 Empty Gelatine Capsules by Capsuline.* <https://capsuline.com/products/clear-gelatin-capsules-size-000-f00093-p.>
- Centers for Disease Control and Prevention, California Occupational Safety and Health Administration, National Institute for Occupational Safety and Health. (2004). *Easy Ergonomics: A Guide to Selecting Non-Powered Hand Tools.* California Department of Industrial Relations; National Institute for Occupational Health and Safety.
- Century Spring. (n.d.) *Part Number 70528.* [https://www.product-config.net/catalog3/output/11875553/specsheet.pdf?_ga=2.241185282.1670068223.1613928713-635156783.1611265985.](https://www.product-config.net/catalog3/output/11875553/specsheet.pdf?_ga=2.241185282.1670068223.1613928713-635156783.1611265985)
- Drugs.com. (n.d). *Metformin hydrochloride Images.* [https://www.drugs.com/metformin-images.html.](https://www.drugs.com/metformin-images.html)
- e-pill. (n.d). *Pill Boxes + Timers.* [https://www.epill.com/organizer.html.](https://www.epill.com/organizer.html)
- Extruded Acrylic Sheets. (n.d.). Retrieved November 22, 2020, from [https://www.tapplastics.com/product/plastics/cut to size plastic/acrylic sheets clear/508](https://www.tapplastics.com/product/plastics/cut%20to%20size%20plastic/acrylic%20sheets%20clear/508)
- ForgettingthePill.com. (n.d). *Pill Organizers.* [https://www.forgettingthepill.com/categories/pill-organizers.](https://www.forgettingthepill.com/categories/pill-organizers)
- Formlabs. (n.d.). *Formlabs Stereolithography 3D Printers Tech Specs.* <https://formlabs.com/3d-printers/form-3/tech-specs/>

Hatchbox. (2016, January 11). Hatchbox PLA 3D printer filament. https://cdn.shopify.com/s/files/1/0008/2457/4018/files/HATCHBOX_PLA_3D_Printer_Filament_SDS.pdf?1561.

Hero Medication Manager and Pill Dispenser. (n.d.). Retrieved October 11, 2020, from https://herohealth.com/our-product?utm_source=google

ICOMold. (n.d.) *Injection Mold Cost Estimator*. <http://www.icocity.com:8060/cost/CostCalculation.jsp>.

Injection Molding Tooling Cost Estimator. (n.d.). Retrieved November 22, 2020, from <https://www.custompartnet.com/estimate/injection-tooling/>

Jayesh K. (2016). Push operated single pill dispenser. US Patent No. 9849069B1. Washington, DC: U.S. Patent and Trademark Office.

Joshua D., Hubert Y., Paul D. (2011). Single unit dispensing cap. US Patent No. 20120103985A1. Washington, DC: U.S. Patent and Trademark Office.

LulzBot. (n.d.). *Lulzbot 3D Printers*. <https://www.lulzbot.com/lulzbot-3d-printers>

MedaCube. (n.d). Retrieved October 11, 2020 from <https://www.medacube.com/>

OnlineMetals. (n.d.). *Aluminum 6061-T6/651/6511/T4 Product Guide*. <https://www.onlinemetals.com/en/product-guide/alloy/6061>.

PillPack. (n.d.). Get Started. <https://www.pillpack.com/>.

Plaskolite. (n.d.). *OPTIX Acrylic*. <https://plaskolite.com/catalog/optix-acrylic>.

Rogers, T. (2015, July 13). Everything You Need to Know About ABS Plastic. Retrieved November 22, 2020, from [https://www.creativemechanisms.com/blog/everything-you-need-to-know-about-abs-plastic#:~:text=ABS is also relatively inexpensive, Polycarbonate \("PC"\)](https://www.creativemechanisms.com/blog/everything-you-need-to-know-about-abs-plastic#:~:text=ABS is also relatively inexpensive, Polycarbonate (\).

Starbond. (n.d.). NO-05 Starbond Infiltrant Odorless Thin CA Glue. <https://www.starbond.com/products/odorless-thin-ca-glue-3d-infiltrant-no-05>

U.S. Department of Veterans Affairs. (January 2018). *Where do I get the care I need?* <https://www.va.gov/health/findcare.asp>

U.S National Library of Medicine. (2020a). LISINOPRIL tablet. In *DailyMed*. <https://dailymed.nlm.nih.gov/dailymed/lookup.cfm?setid=7d6c31e2-b5a4-4279-8013-a8dad37ea73b##>

U.S National Library of Medicine. (2020b). OMEPRAZOLE capsule, delayed release. In *DailyMed*. <https://dailymed.nlm.nih.gov/dailymed/lookup.cfm?setid=5a09ce48-7139-4fc7-9b6e-439459c8e866>

U.S National Library of Medicine. (2019). PIOGLITAZONE HCL AND METFORMIN HCL tablet. In *DailyMed*. <https://dailymed.nlm.nih.gov/dailymed/lookup.cfm?setid=237d8fa2-633c-4c29-84d3-f1b413610dc3>

U.S National Library of Medicine. (2020c). SERTRALINE HYDROCHLORIDE tablet, film coated. In *DailyMed*. <https://dailymed.nlm.nih.gov/dailymed/lookup.cfm?setid=9bc362d4-489c-4e7f-915a-3076ff8d132a>

WellRx. (n.d.). *Omeprazole*. <https://www.wellrx.com/omeprazole/drug-images/>

Appendices

Appendix A. QFD Table and Decision Matrices

Customer Requirements		Engineering Requirements																		
		Weighting (1 to 5)	Line of sight to ejected pills	Line of sight to verify the mechanism is empty	Unit Cost	Max # pills dispensed = 1	Dispenses most common pills	Lifespan for Mechanism	Device's internal storage enclosed	Time reduction	Any custom parts are 3D printable on Luizbot TAZ filament printers or Formlabs resin printers	Material does not react with soap & water @ room temperature	Handle Diameter	Center of gravity within the grasp of the device	Device weight	Squeeze actuation travel	All printed parts fit in print volume	Ambidextrous Operation	Wrist angle	Actuation Force TBD
Customer Requirements	Clear View of Pills	5	9	9						3										
	One Pill at a Time	5	3	1		9	9	3												
	Works for Several Pill Shapes and Sizes	3				9	9	3		3										
	2-5yr Product Life	3				3	3	9		3	3									
	Reduces Nurses Time	5	1			9	3			9			1	1	1		1	1	1	
	Primarily 3D Printed	2			3			3	1		9					9				
	Low Cost	5			9					9				1		3				
	Enclosed space for pills	5						9												
	Cleanable	2		3				3			9									
	Managable Grip	4								1		9	9	9	3		9	9	9	
	Stable in Hand	4								1			9	9			3	9		
	Compact	3								3						9				
	Easy Actuation	5												3	9		3	3	9	
	Units					USD	Accur. #	Cycles	% Improvement		in	lb	in	in			Deg.	TBD		
	Targets					\$20	100%	>5	35k	50%	1.25-2.00"	< 5	2.0-3.0	< 11"			±10°	TBD		
Benchmark #1																				
Benchmark #2																				
Importance Scoring		65	56	51	126	96	57	53	45	113	27	63	77	88	62	60	68	92	86	0
Importance Rating (%)		52	44	40	100	76	45	42	36	90	21	50	61	70	49	48	54	73	68	0

● = 9	Strong Correlation
○ = 3	Medium Correlation
△ = 1	Small Correlation
Blank	No Correlation

Figure 41: QFD Table of Customer and Engineering Requirements.








Concept							
Concept Description	Double Sided Tray	5 portions of disk cycle in arc, at different heights	Sliding despensing mechanism	Plunger Dispenser with rubber resistive output	Handle Squeeze sliding mechanism	Funnel aligns pills to drop into slot on rotating wheel, which would then drop one pill out of the bottom	Revolving dispenser
Criteria	1	2	3	4	5	6	7
Clear View of Pills	+	-	B	S	S	-	-
One Pill at a Time	+	S	E	-	S	S	S
Works for Several Pill	+	+	N	+	S	-	S
2-5yr Product Life	+	-	C	-	S	+	S
Reduces Nurses Time	+	-	H	-	S	+	-
Primarily 3D Printed	-	S	M	-	S	S	S
Low Cost	-	-	A	+	-	-	-
Enclosed space for pi	-	S	R	+	S	+	S
Cleanable	+	-	K	+	-	-	-
Managable Grip	-	-	-	-	+	-	-
Stable in Hand	-	-	-	+	+	S	S
Compact	-	-	-	+	+	S	S
Easy Actuation	+	+	-	-	+	+	-
Sum +	7	2	0	6	4	4	0
Sum -	6	8	0	6	2	5	6
Sum S	0	3	0	1	7	4	7

Figure 42: Cole Pike's Pugh matrix.








Concept							
Concept Description	Double Sided Tray	5 portions of disk cycle in arc, at different heights	Sliding despensing mechanism	Plunger Dispenser with rubber resistive output	Handle Squeeze sliding mechanism	Funnel aligns pills to drop into slot on rotating wheel, which would then drop one pill out of the bottom	Revolving dispenser
Criteria	1	2	3	4	5	6	7
Clear View of Pills	+	S	B	+	S	-	S
One Pill at a Time	+	+	E	-	S	-	S
Works for Several Pill	+	+	N	+	S	-	S
2-5yr Product Life	+	S	C	-	S	-	-
Reduces Nurses Time	-	S	H	S	S	S	S
Primarily 3D Printed	+	S	M	+	S	S	S
Low Cost	+	S	A	+	S	S	S
Enclosed space for pi	-	S	R	S	S	S	S
Cleanable	+	S	K	+	S	-	S
Managable Grip	+	-	-	+	S	-	-
Stable in Hand	+	-	-	+	S	-	-
Compact	-	-	-	+	S	-	-
Easy Actuation	+	S	-	+	S	S	S
Sum +	10	2	0	9	0	0	0
Sum -	3	3	0	2	0	8	4
Sum S	0	8	0	2	13	5	9

Figure 43: Taylor Morris's Pugh matrix.








Concept							
Concept Description	Double Sided Tray	5 portions of disk cycle in arc, at different heights	Sliding dispensing mechanism	Plunger Dispenser with rubber resistive output	Handle Squeeze sliding mechanism	Funnel aligns pills to drop into slot on rotating wheel, which would then drop one pill out of the bottom	Revolving dispenser
Criteria	1	2	3	4	5	6	7
Clear View of Pills	+	+	B	+	S	+	-
One Pill at a Time	+	S	E	S	S	S	S
Works for Several Pills	+	+	N	S	S	+	S
2-5yr Product Life	+	+	C	-	-	-	S
Reduces Nurses Time	+	S	H	+	S	+	S
Primarily 3D Printed	-	S	M	-	-	-	S
Low Cost	-	-	A	S	-	-	-
Enclosed space for pills	-	+	R	+	+	S	S
Cleanable	+	+	K	-	-	-	S
Managable Grip	-	-		+	+	S	S
Stable in Hand	-	S		+	+	-	-
Compact	-	-		+	+	S	S
Easy Actuation	+	+		+	+	+	-
Sum +	7	6	0	7	5	4	0
Sum -	5	3	0	3	4	5	4
Sum S	0	4	0	3	4	4	9

Figure 44: Jose Gomez's Pugh matrix.




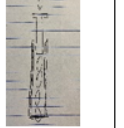
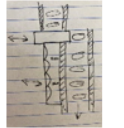

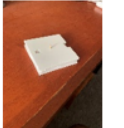
Concept							
Concept Description	Double Sided Tray	5 portions of disk cycle in arc, at different heights	Sliding dispensing mechanism	Plunger Dispenser with rubber resistive output	Handle Squeeze sliding mechanism	Funnel aligns pills to drop into slot on rotating wheel, which would then drop one pill out of the bottom	Revolving dispenser
Criteria	1	2	3	4	5	6	7
Clear View of Pills	+	+	B	+	S	-	S
One Pill at a Time	+	S	E	-	S	-	+
Works for Several Pills	+	+	N	+	-	+	S
2-5yr Product Life	+	-	C	-	S	S	-
Reduces Nurses Time	S	S	H	S	S	S	+
Primarily 3D Printed	+	S		-	S	-	S
Low Cost	-	S	M	+	S	S	-
Enclosed space for pills	-	S	A	S	S	S	S
Cleanable	+	-	R	-	S	-	-
Managable Grip	S	S	K	S	S	-	-
Stable in Hand	S	S		S	S	-	-
Compact	-	-		S	S	-	-
Easy Actuation	+	-		+	+	-	-
Sum +	7	2	0	4	1	1	2
Sum -	3	4	0	4	1	8	7
Sum S	3	7	0	5	11	4	4

Figure 45: Chris Bruni's Pugh matrix.

Appendix B. Final Drawings

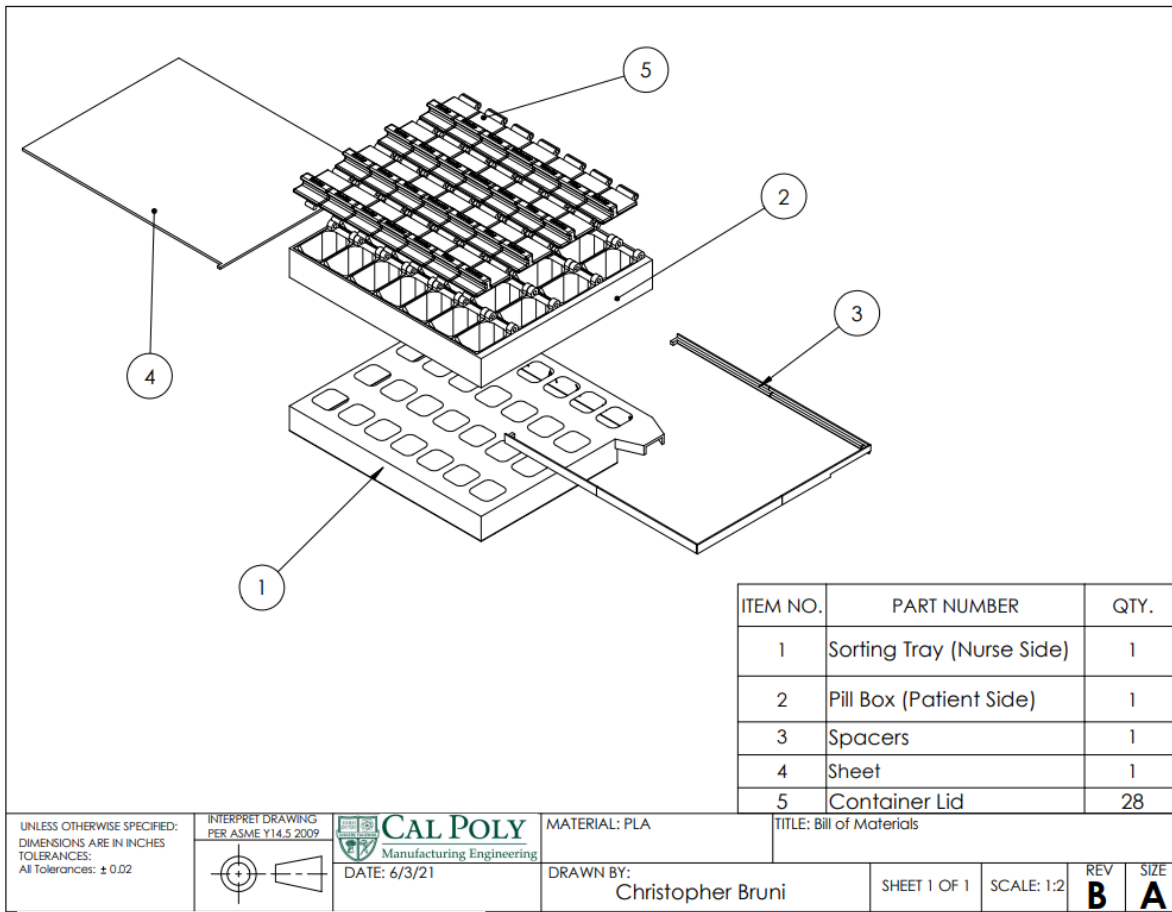


Figure 46: Exploded Assembly Drawing and Bill of Materials.

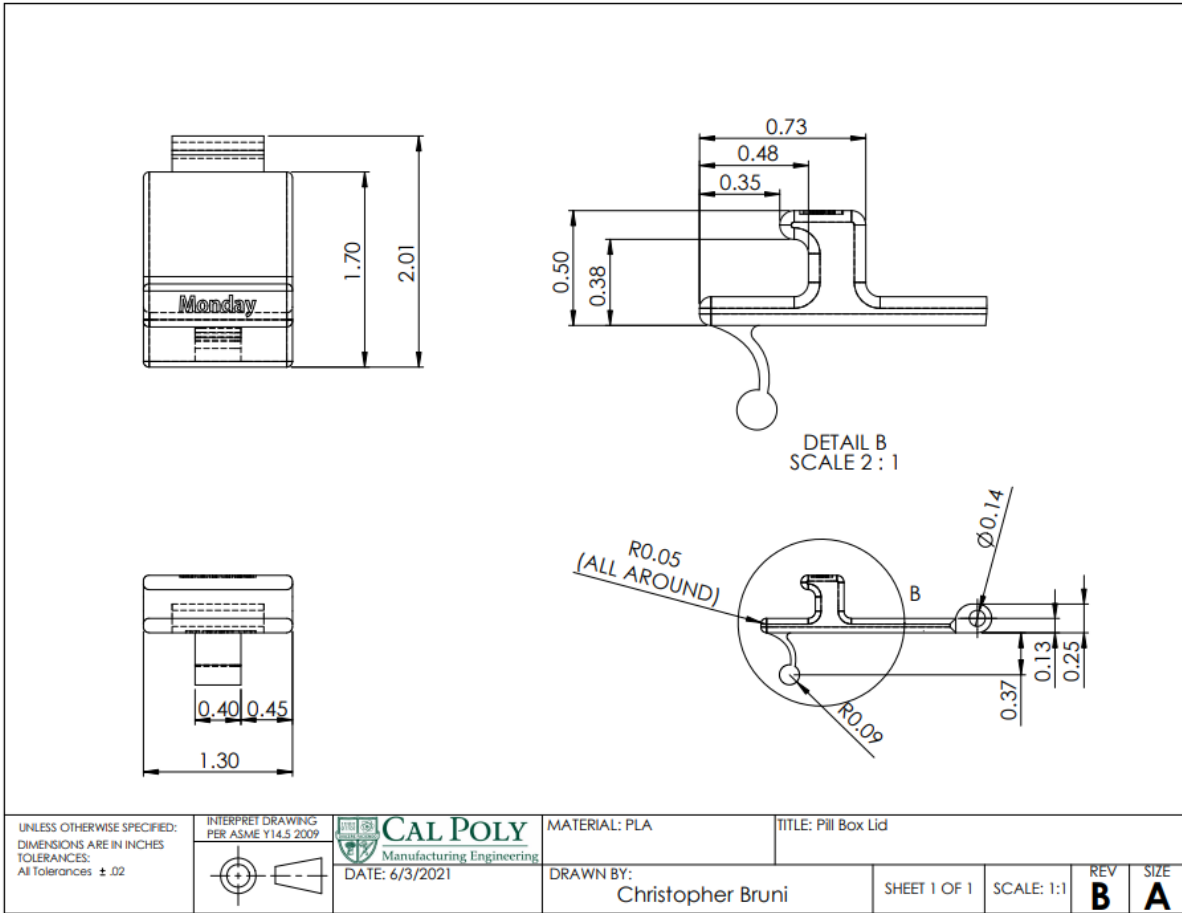


Figure 47: Container Cap Part Drawing.

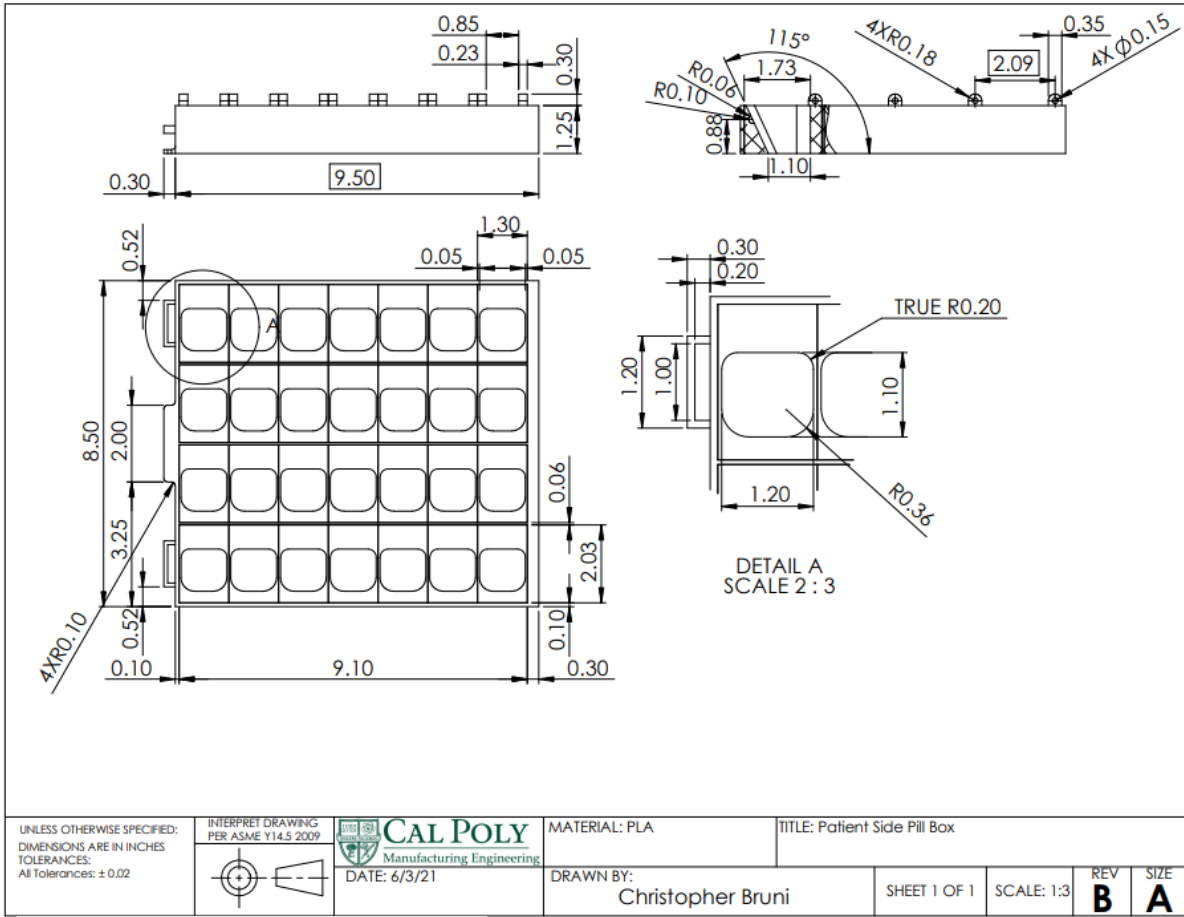


Figure 48: Single Pill Box Part Drawing.

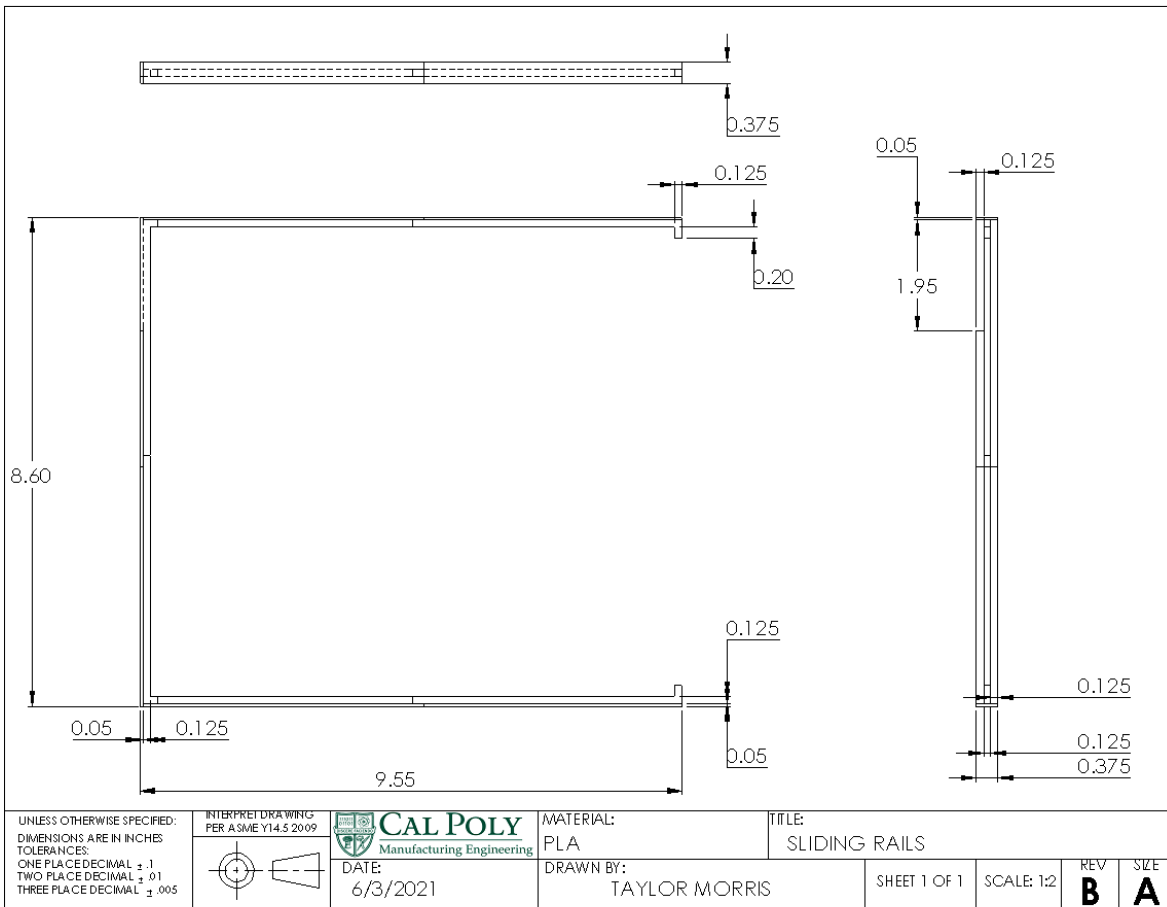


Figure 49: Slider Rails Part Drawing.

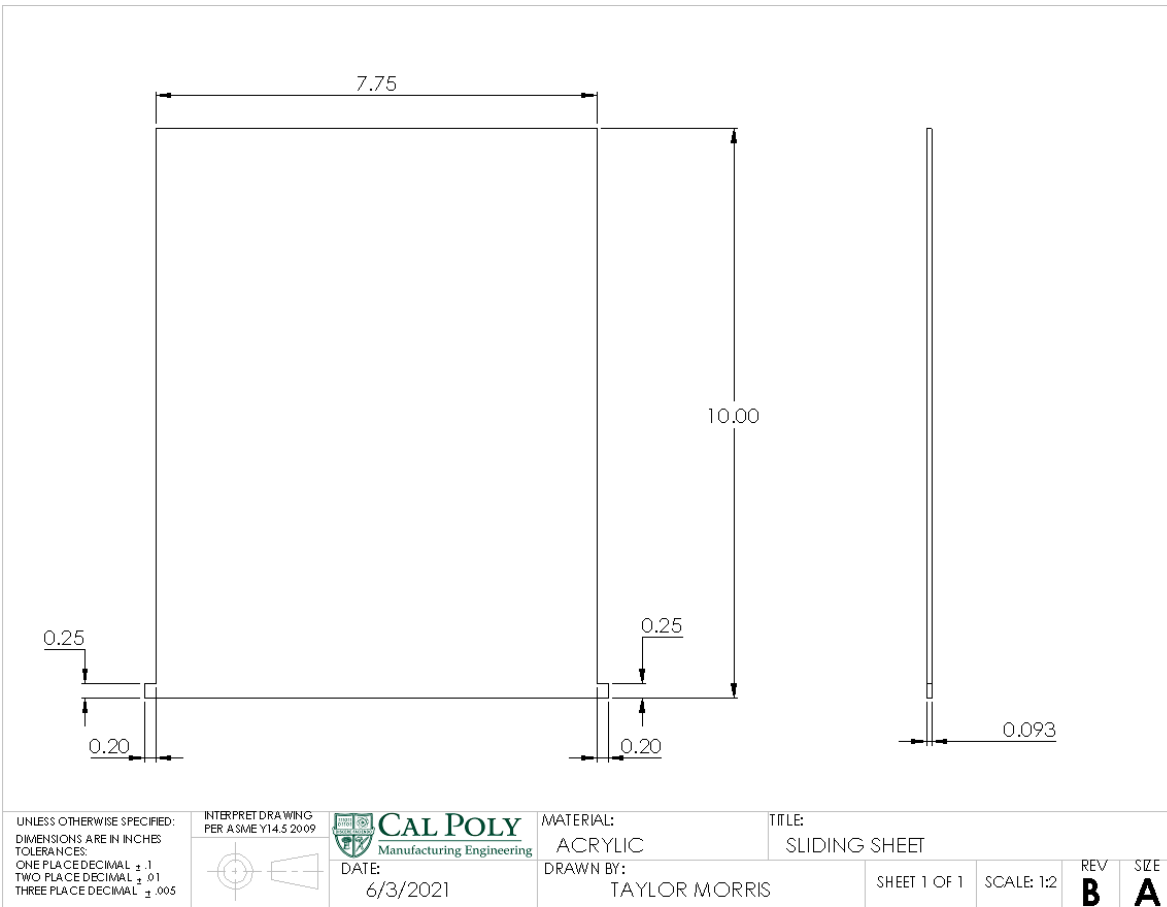


Figure 50: Sorting Sheet Part Drawing.

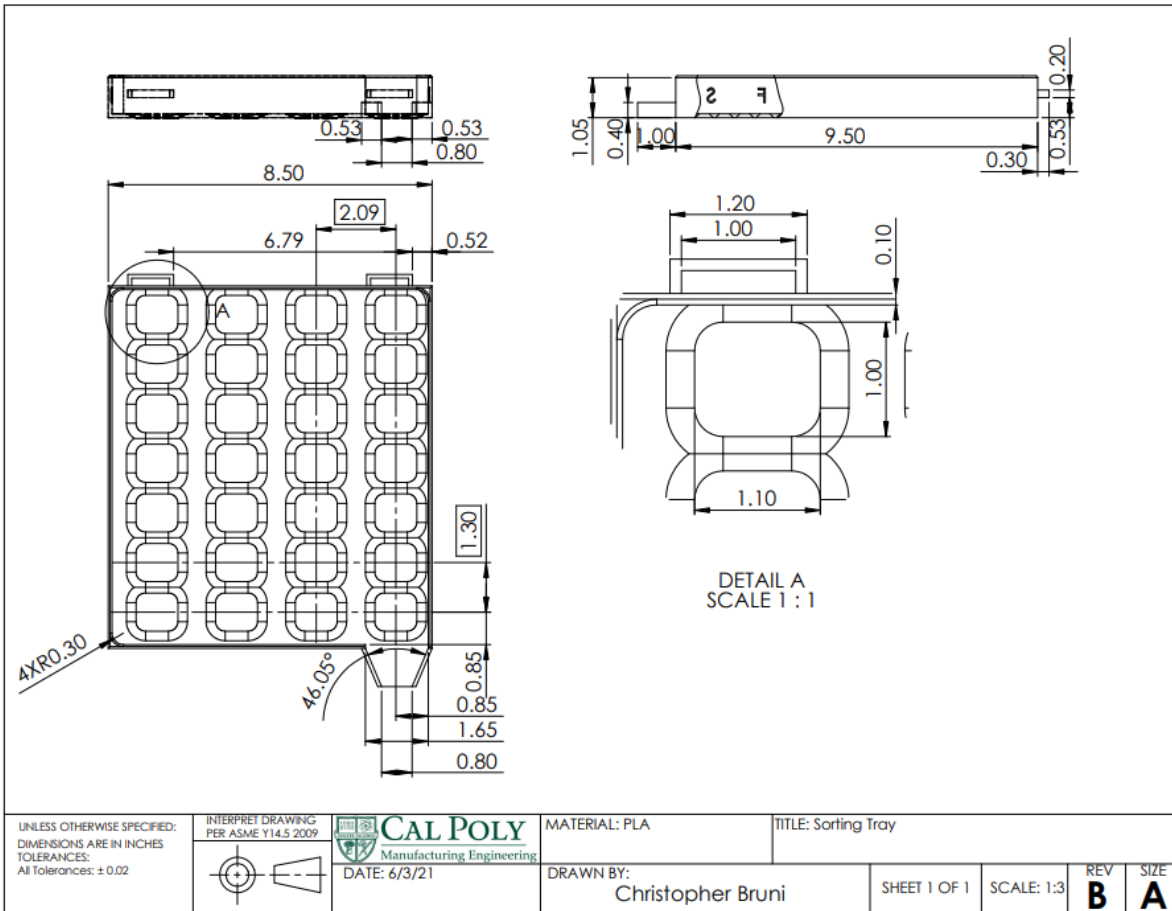
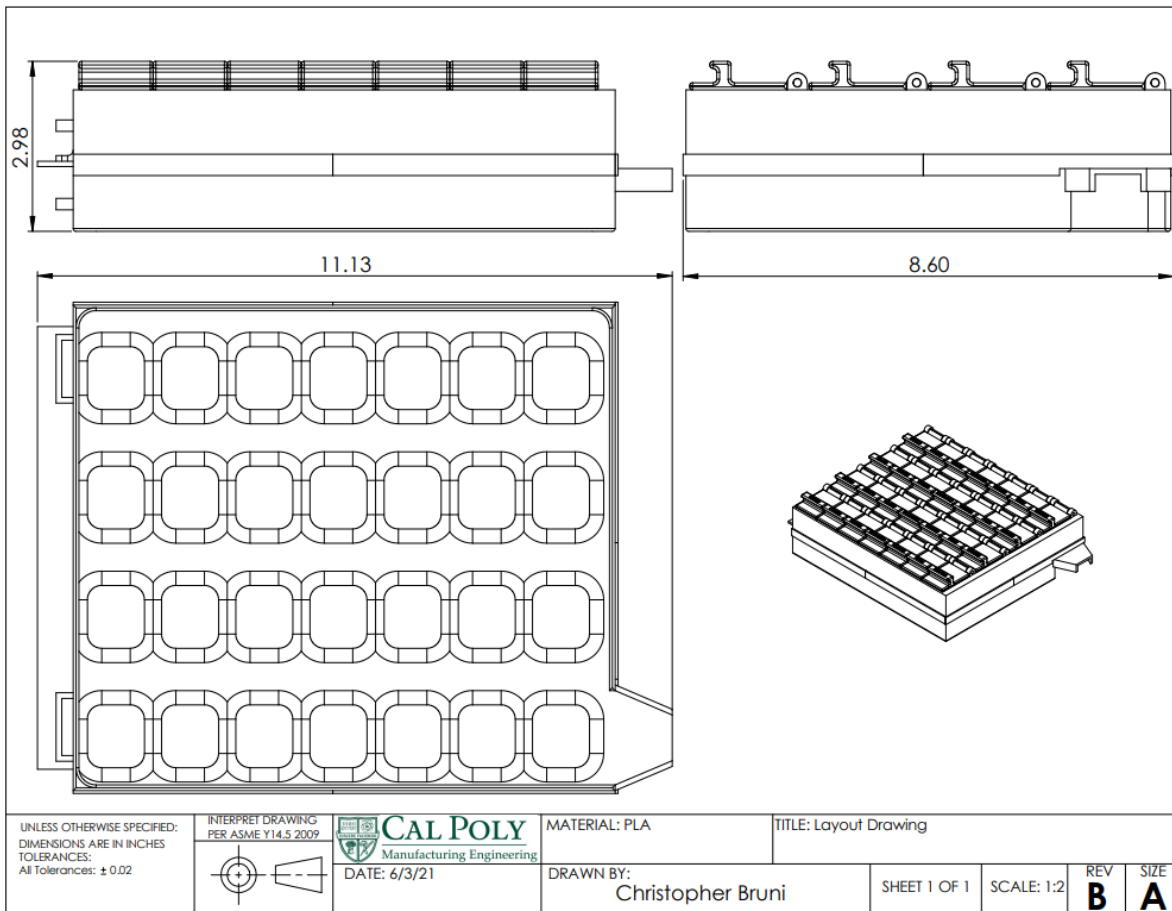


Figure 51: Sorting Tray Part Drawing.



SOLIDWORKS Educational Product. For Instructional Use Only.

Figure 52: Assembly Layout Drawing.

Appendix C. Vendor Information

Hatchbox products are available on Amazon.com, and they can be contacted through their website (hatchbox3d.com) or by email at support@hatchbox3d.com.

OnlineMetals products are available through their website (onlinemetals.com), and they can be contacted through their website, by phone at 1-800-704-2157, by fax at 1-800-533-6350, or by email at sales@onlinemetals.com.

OPTIX clear acrylic sheets are available on Amazon.com and can be contacted through Plaskolite.com, or by phone at 1-800-848-9124.

Starbond adhesives can be purchased on their website (starbond.com) or through other common online retailers. Starbond can be contacted by phone at 213-382-7788 or by email at cph@starbond.com.

Appendix D. Component Data Sheets

Product Name:	Hatchbox PLA 3D printer filament
Date of issue: 1/11/2016	Version: 1.0
1. Identification of the substance/preparation and of the company	
1.1 Trade name:	Hatchbox PLA 3D printer filament
1.2 Use of the product:	Biodegradable resin for 3D printing
1.3 Supplier:	Hatchbox 2665 Pomona Blvd. Pomona, CA 91768 Phone: (909) 632-7168 Emergency phone number: (909) 632-7168
2. Hazards identification	
2.1 Classification:	Not dangerous according to Directive 67/548/EEC
2.2 Special advice on hazards:	Danger of burns in contact with hot polymer. Hazardous vapors in case of burning.
3. Composition / information on ingredients	
3.1 Chemical characteristics:	Biodegradable polymer-blend based on polylactic acid.
3.2 CAS no:	PLA: 9051-89-2
3.3 Additional information:	No harmful ingredients
4. First-aid measures	
4.1 On skin contact:	In case of contact with molten polymer immediately cool the skin with cold water. Medical aid may be required to remove adhering material and for treatment of burns.
4.2 After inhalation:	After inhalation of decomposition gases or dust remove patient to fresh air. Contact a doctor in case of discomfort.
4.3 On ingestion:	No effects known. Rinse mouth with water and drink more water. Contact a doctor in case of discomfort.
4.4 On eyes contact:	Rinse open eyes thoroughly with water
5. Fire-fighting measures	
5.1 Suitable fire extinguishing media:	Water, dry chemical extinguisher, carbon dioxide
5.2 Special exposure hazards:	During incomplete combustion release of carbon monoxide, carbon dioxide and hydrocarbons.
5.3 Special protective equipment:	Self-contained breathing apparatus
5.4 Remark:	Accumulations of dust can be inflammable.

Page 1/3

Figure 53: Page 1 of Hatchbox PLA Filament Safety Data Sheet (Hatchbox, 2016).



Product Name:

Hatchbox PLA 3D printer filament

Date of issue:

Version: 1.0

1/11/2016

6. Accidental release measures

- 6.1 Personal precautions: Use suitable protective clothing. Avoid eye contact and inhalation of dusts. Keep ignition sources away.
- 6.2 Methods for cleaning up: Sweep up material and place in a container, risk of slipping. Avoid ingress of material into drainage systems.

7. Handling and storage

- 7.1 Handling: Avoid contact with molten polymer. Avoid generation of dust and electrostatic charge.
- 7.2 Storage: Protect against moisture. Store cool and keep packaging closed when not in use. Avoid sources of ignition.

8. Exposure controls/ personal protection

- 8.1 Technical safety measures: With suitable ventilation the threshold limits assumably will not be reached. Avoid electrostatic charge by use of grounding cables.
- 8.2 Personal safety equipment: Use adequate safety equipment, e.g. protective clothing, eye protection glasses, heat protection gloves. In case of dust formation wear mask with particle filter.
- 8.3 Work hygiene: No eating or drinking during working. Avoid contact of hot material with the skin. Avoid breathing dust and vapors.

9. Physical and chemical properties

- 9.1 Form: Spool
- 9.2 Color: Various
- 9.3 Odor: Almost Odorless
- 9.4 Melting Temperature: 155 °C
- 9.5 Oxidising properties: Not self-igniting / flammable
- 9.6 Explosions limits: Not Applicable
- 9.7 Density: 1.27 g/cm³
- 9.8 Solubility in water: Insoluble

10. Stability and reactivity

- 10.1 Stability: The product is stable at recommended storage conditions.
- 10.2 Conditions to be avoided: Avoid exposure to extreme heat and all sources of ignition. Thermal decomposition > 260°C.
- 10.3 Substances to be avoided: Strong oxidizing agents
- 10.4 Hazardous decomposition products: Carbon monoxide, carbon dioxide, hydrocarbons.

Page 2/3

Figure 54: Page 2 of Hatchbox PLA Filament Safety Data Sheet (Hatchbox, 2016).



Product Name: Hatchbox PLA 3D printer filament
Date of issue: 1/11/2016
Version: 1.0

11. Toxicological information

11.1 Local irritation: Dust can cause irritation of eyes, respiratory organs and skin. After ingestion stomach pain or nausea are possible.

11.2 Other remarks: Based on our state of knowledge and experience no injurious health effects are expected if product is properly handled for the designated use.

12. Ecological information

12.1 Ecotoxicological effects: No negative ecological effects known at the present state of knowledge, test results are not available. Due to insolubility in water most probably not hazardous to aquatic organisms.

12.2 Biological degradation: Product is biodegradable.

12.3 Bioaccumulation: Due to its consistency and insolubility in water biological accumulation is not expected.

13. Disposal considerations

13.1 Product: Generation of waste should be minimized, check possibility for recycling. Waste product can be incinerated or dumped together with domestic waste in compliance with local authority requirements.

13.2 Uncleaned packaging: Packaging material has to be emptied completely and disposed in accordance with the regulations. Packaging can be recycled if not contaminated.

14. Transport information

14.1 Transport regulations: Not classified as hazardous under transport regulations ADR, ADNR, RID, ICAO/IATA, IMDG/GGVSee, ICAO/IATA

15. Regulatory information

15.1 EU regulations: This product does not require a hazard warning label in accordance with EC Directives.

15.2 Water exposure class (Germany): 'nwg', no risk of water pollution (classification acc. Att. 1 of VwVwS)

16. Other information

This data is based on the current state of our information and experience. This safety data sheet describes our product in terms of safety requirements. Preceding data is not applicable as a warranty of product properties. It is the responsibility of the recipient to observe the existing legal regulations for the use of this product.

Mechanical Information T6/651/6511				
	Density	Ultimate Tensile Strength	Yield Tensile Strength	Fatigue Strength
Imperial	0.1 lb/in ³	45,000 psi	40,000 psi	14,000 psi
Metric	2.7 g/cc	310 MPa	276 MPa	96.5 MPa

Mechanical Information T6/651/6511				
	Modulus of Elasticity	Shear Modulus	Shear Strength	Melting Point
Imperial	10,000 ksi	3,800 ksi	30,000 psi	1,080-1,205 F
Metric	68.9 GPa	26 GPa	207 MPa	582-651.7 C

Mechanical Information T6/651/6511				
Electrical Conductivity	Hardness Rockwell/Brinell	Elongation at break percentage	Poissons Ratio	Machinability Percentage
43% IACS	B60/95	17	0.33	50

Mechanical Information T4				
	Density	Ultimate Tensile Strength	Yield Tensile Strength	Fatigue Strength
Imperial	0.1 lb/in ³	35,000 psi	21,000 psi	14,000 psi
Metric	2.7 g/cc	241 MPa	145 MPa	96.5 MPa

Mechanical Information T4				
	Modulus of Elasticity	Shear Modulus	Shear Strength	Melting Point
Imperial	10,000 ksi	3,800 ksi	24,000 psi	1,080-1,205 F
Metric	68.9 GPa	26 GPa	165 MPa	582-651.7 C

Mechanical Information T4				
Electrical Conductivity	Hardness Brinell	Elongation at break percentage	Poissons Ratio	Machinability Percentage
43% IACS	65	22	0.33	50

Figure 56: OnlineMetals Aluminum 6061-T6 Material Data (OnlineMetals, n.d.).

PLASKOLITE

OPTIX Acrylic Sheet

Typical Properties

Physical	TEST METHOD	UNITS	OPTIX
Specific Gravity/Relative Density	ASTM D792		1.19
Optical Refractive Index	ASTM D542		1.49
Light Transmission - Total	ASTM D1003	%	92
Light Transmission - Haze	ASTM D1003	%	2
Sound Transmission	ASTM E90 / E413	dB	27
Water Absorption	ASTM D570	%	0.4
Mold Shrinkage	ASTM D955	mls/in	2-6

Mechanical	TEST METHOD	UNITS	OPTIX
Tensile Strength	ASTM D638	psi	11,030
Tensile Elongation - Max	ASTM D638	%	5.8
Tensile Modulus of Elasticity	ASTM D638	psi	490,000
Flexural Strength	ASTM D790	psi	17,000
Flexural Modulus of Elasticity	ASTM D790	psi	490,000
Izod Impact Strength - Molded Notch	ASTM D256	ft-lb/in Notch	0.4
Izod Impact Strength - Milled Notch	ASTM D256	ft-lb/in Notch	0.28
Tensile Impact Strength	ASTM D1822	ft-lb/in ²	20
Abrasion Resistance - Change in Haze - 0 cycles	ASTM D1044	Haze, %	0
Abrasion Resistance - Change in Haze - 10 cycles	ASTM D1044	Haze, %	11.2
Abrasion Resistance - Change in Haze - 50 cycles	ASTM D1044	Haze, %	24
Abrasion Resistance - Change in Haze - 200 cycles	ASTM D1044	Haze, %	24.9
Rockwell Hardness	ASTM D785		M-95

Thermal	TEST METHOD	UNITS	OPTIX
Maximum Recommended Continuous Service Temperature		°F	170-190
Softening Temperature		°F	210-220
Melting Temperature		°F	300-315
Deflection Temperature @ 264 psi (1.8 MPa)	ASTM D648	°F	203
Deflection Temperature @ 66 psi (0.45 MPa)	ASTM D648	°F	207
Coefficient of Thermal Expansion	ASTM D696	in/in/°F	3.0x10 ⁻⁵
Thermal Conductivity	ASTM C177	BTU-in/ft ² -hr/°F	0.075
Flammability (Burning Rate)	ASTM D635	in/minute	1.019
Flammability	UL 94		HB
Smoke Density Rating	ASTM D2843	%	3.4
Self-Ignition Temperature	ASTM D1929	°F	833
Flame Spread Index	ASTM E84		115
Smoke Developed Index	ASTM E84		550

These suggestions and data are based on information we believe to be reliable. They are offered in good faith, but without guarantee, as conditions and methods of use are beyond our control. We recommend that the prospective user determine the suitability of our materials and suggestions before adopting them on a commercial scale.

Questions? Please contact Plaskolite Customer Support 800-848-9124

PLASKOLITE

400 W Nationwide Blvd, Suite 400
Columbus, Ohio 43215
800-848-9124 Fax 877-538-0754
www.plaskolite.com

Figure 57: OPTIX Acrylic Sheet Material Data (Plaskolite, n.d.).

N/O-05 Properties

5 mPa·s viscosity

Thin Odorless adhesive

0.002" gap filling capability

Instant cure

Figure 58: Starbond NO-05 Starbond Infiltrant Odorless Thin CA (Starbond, n.d.).

The N/O-05 is a 3D printer “infiltrant”. The N/O-05 is a thin CA that is odorless, fumeless, and hypoallergenic. This watery-thin adhesive infiltrates hairline fractures, pores, and narrow slots filling any empty voids. Well suited for porous and fragile material such as foam, soft wood (balsa), ceramics, unpolished minerals, and fossil bones. For inlay applications, the adhesive penetrates and stabilizes the material through capillary action. It is often used as a finish by applying several coats, sanding, and then polishing to a high gloss.

Used For:

Projects with limited ventilation

Individuals that experience allergic symptoms to regular CA

Infiltrating and stabilizing 3D printed parts.

Repairing and filling cracks, inclusions, voids, and knots in the wood

Woodturning and knife handle finishes for a hard, clear, and waterproof coat.

Wicking into and stabilizing guitar frets

Installing bindings and purflings on a guitar

Gluing and repairing guitar inlays on the headstock, body, and fretboard

Fossil preparation through infiltration and stabilization of the fossil before extraction.

Repairing small cracks in the stone

Metal and turquoise inlays.

Jewelry manufacturing and repair.

Furniture refinishing and antique repair

Ceramic repair

Bonding fiberglass to balsa wood

Taxidermy

Compatible With:

Wood

Metal

Rubber

Leather

Ceramics

Gemstones

Rocks & Minerals

Carbon Fiber

Fiberglass

PVC and Most Plastics

Available in 2 ounce, 16 ounce, and 44 lb. (20kg) sizes

Figure 59: Starbond NO-05 Starbond Infiltrant Odorless Thin CA - Continued (Starbond, n.d.).

Appendix E. Gantt Chart

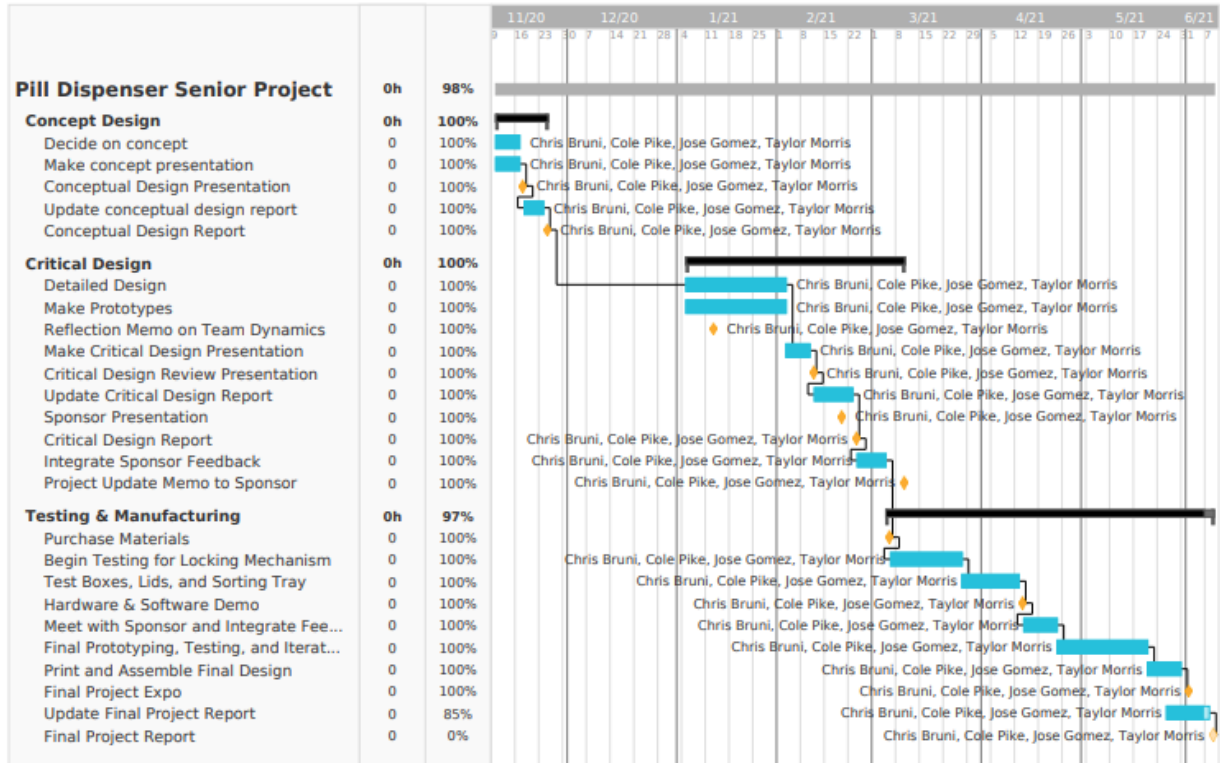


Figure 60: Gantt chart of the schedule to complete this project.

Appendix F. Product Guide for User

Step one: Acquire container and patient's medications.

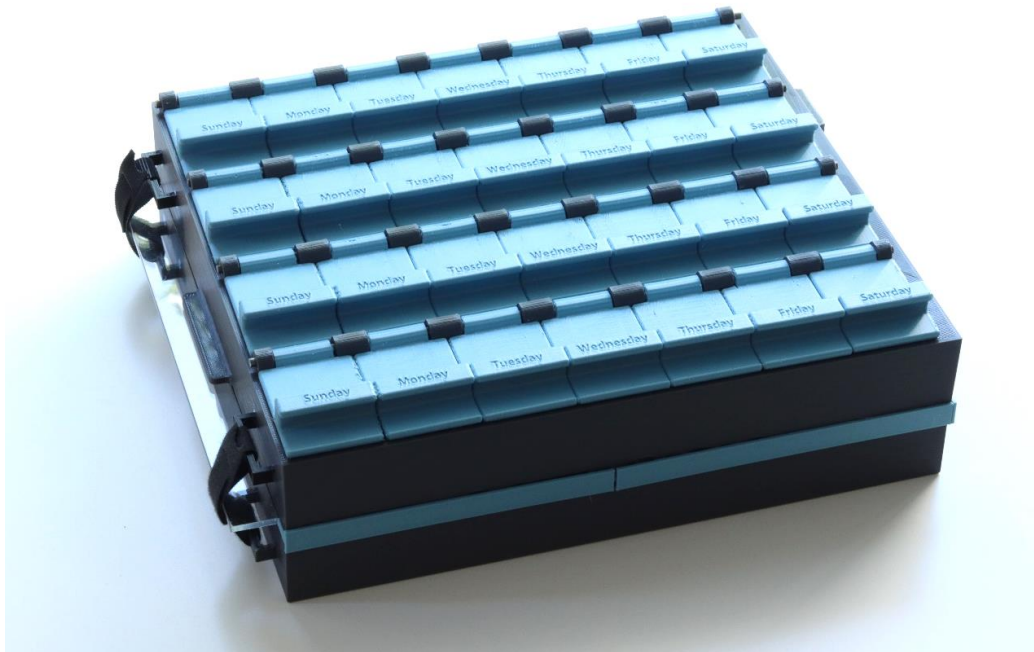


Figure 61: Closed Patient Container Side

Step two: Flip the container to the sorting tray side.

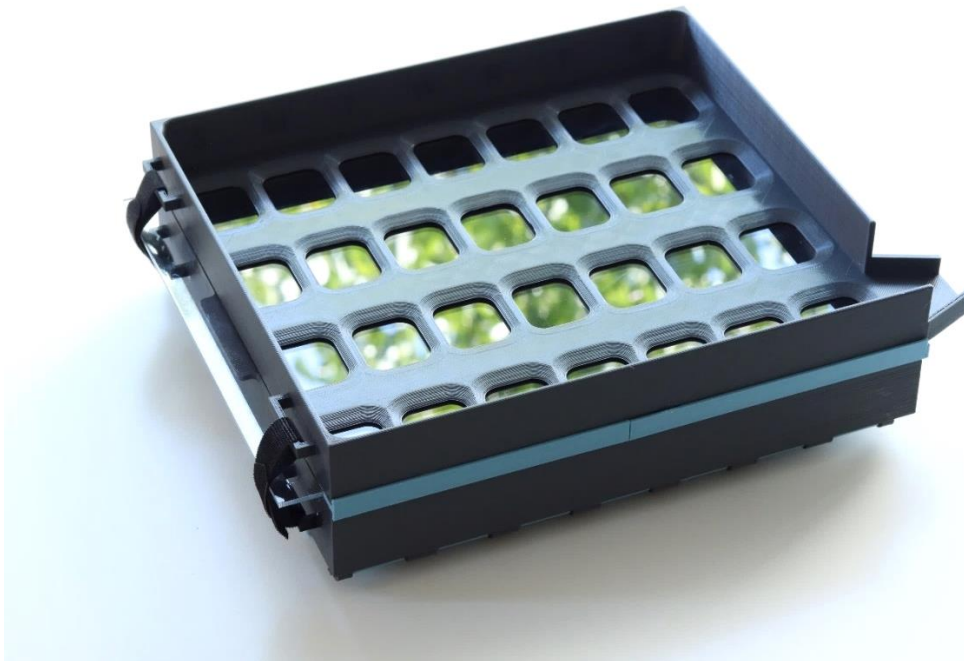


Figure 62: Closed Nurse Side

Step three: Remove the Velcro loops from the side of the container.

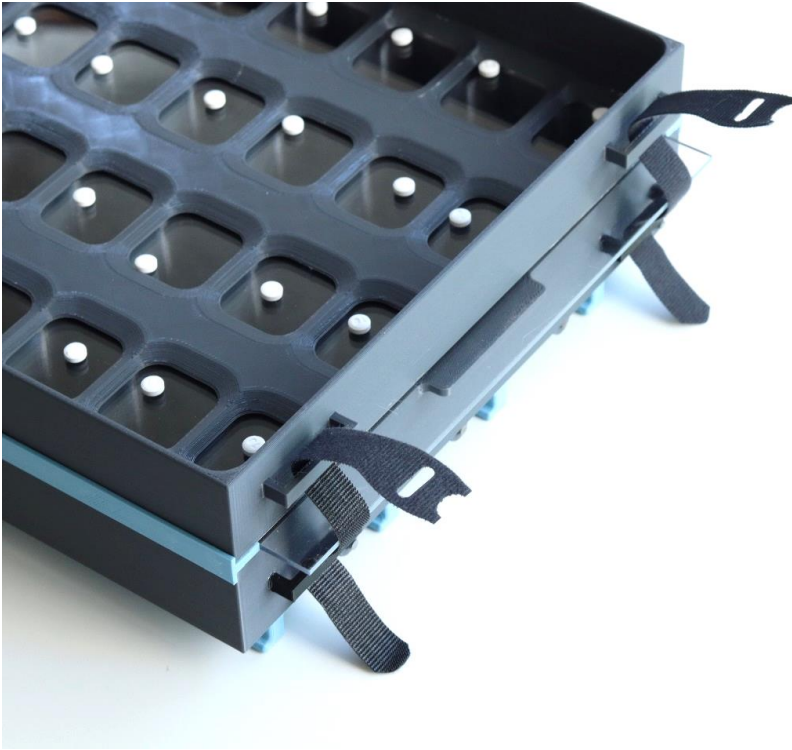


Figure 63: Remove Velcro Loops

Step four: Add medication to the sorting tray.

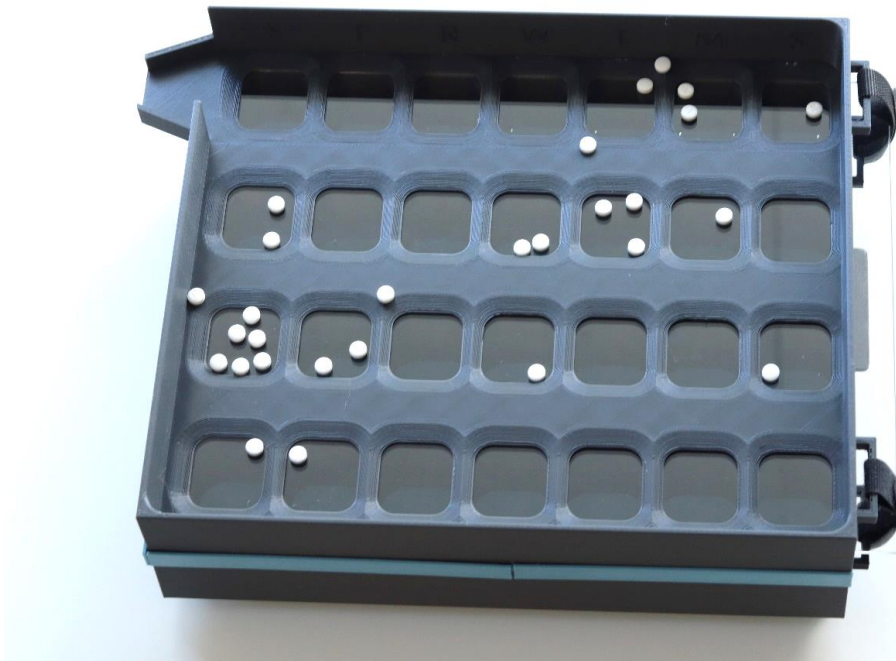


Figure 64: Add Pills to Sorting Tray

Step five: Sort medication so only one pill is in each slot.



Figure 65: Sort Pills on Sorting Tray

Step six: Move excess pills to the exit funnel and push the excess pills back into the pill container.

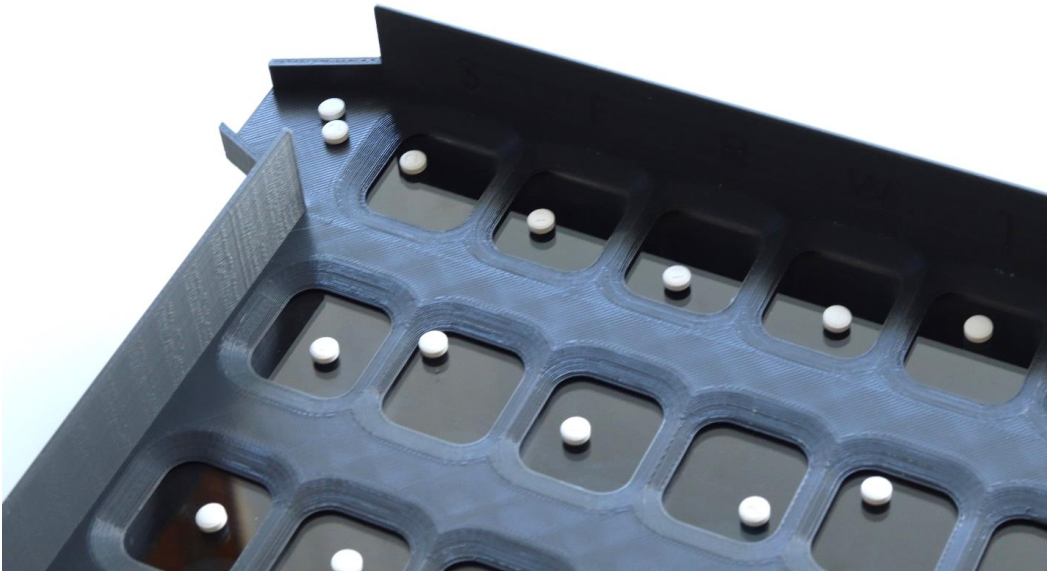


Figure 66: Remove Excess Pills if Necessary

Step seven: Pull the acrylic sheet to allow the medication to fall into each of the pill boxes.



Figure 67: Pull Sheet

Step eight: After sorting and dispensing all of the medications, replace the Velcro loops.

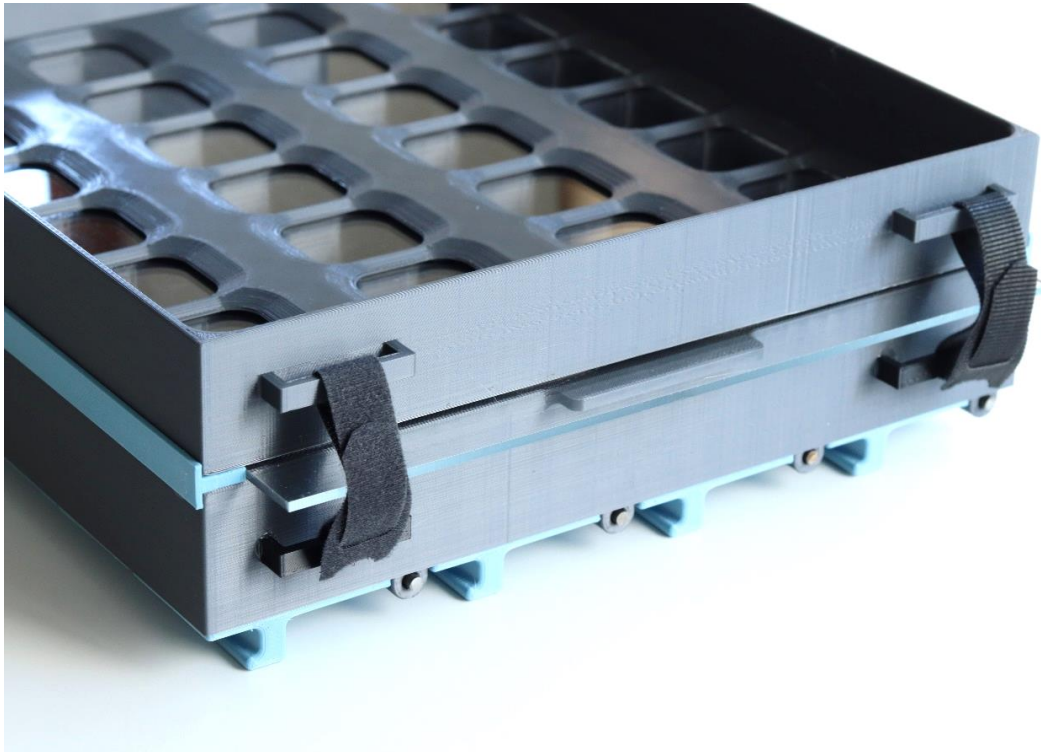


Figure 68: Replace Velcro Loops

Step nine: All medications are now sorted into the patient's pill boxes.



Figure 69: Pills in Patient Container

Step ten: Patients can now access their pills each day by opening that day's lid.

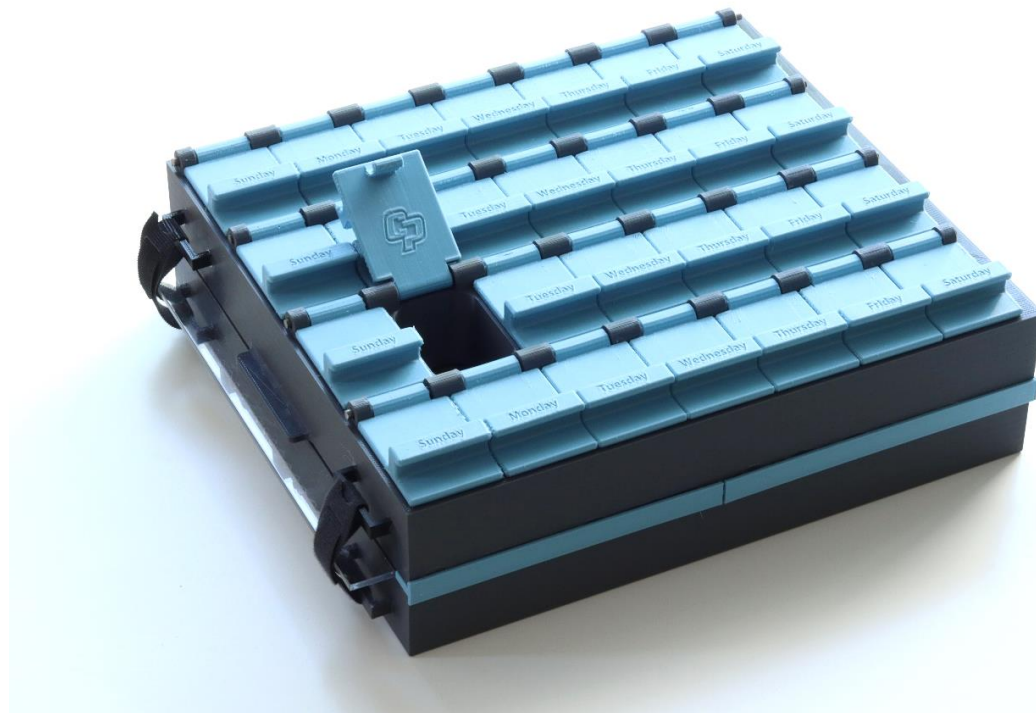


Figure 70: Patient Container Lid Open

Appendix G. Safety Check List

SENIOR PROJECT CONCEPTUAL DESIGN REVIEW HAZARD IDENTIFICATION CHECKLIST

- | Y | N | |
|-------------------------------------|-------------------------------------|--|
| <input type="checkbox"/> | <input checked="" type="checkbox"/> | Will any part of the design create hazardous revolving, reciprocating, running, shearing, punching, pressing, squeezing, drawing, cutting, rolling, mixing or similar action, including pinch points and sheer points? |
| <input type="checkbox"/> | <input checked="" type="checkbox"/> | Can any part of the design undergo high accelerations/decelerations? |
| <input type="checkbox"/> | <input checked="" type="checkbox"/> | Will the system have any large moving masses or large forces? |
| <input type="checkbox"/> | <input checked="" type="checkbox"/> | Will the system produce a projectile? |
| <input type="checkbox"/> | <input checked="" type="checkbox"/> | Would it be possible for the system to fall under gravity creating injury? |
| <input type="checkbox"/> | <input checked="" type="checkbox"/> | Will a user be exposed to overhanging weights as part of the design? |
| <input type="checkbox"/> | <input checked="" type="checkbox"/> | Will the system have any sharp edges? |
| <input checked="" type="checkbox"/> | <input type="checkbox"/> | Will all the electrical systems properly grounded? |
| <input type="checkbox"/> | <input checked="" type="checkbox"/> | Will there be any large batteries or electrical voltage in the system above 40 V either AC or DC? |
| <input checked="" type="checkbox"/> | <input type="checkbox"/> | Will there be any stored energy in the system such as batteries, flywheels, hanging weights or pressurized fluids? |
| <input type="checkbox"/> | <input checked="" type="checkbox"/> | Will there be any explosive or flammable liquids, gases, dust fuel part of the system? |
| <input type="checkbox"/> | <input checked="" type="checkbox"/> | Will the user of the design be required to exert any abnormal effort or physical posture during the use of the design? |
| <input type="checkbox"/> | <input checked="" type="checkbox"/> | Will there be any materials known to be hazardous to humans involved in either the design or the manufacturing of the design? |
| <input type="checkbox"/> | <input checked="" type="checkbox"/> | Can the system generate high levels of noise? |
| <input checked="" type="checkbox"/> | <input type="checkbox"/> | Will the device/system be exposed to extreme environmental conditions such as fog, humidity, cold, <u>high temperatures, etc...</u> ? |
| <input checked="" type="checkbox"/> | <input type="checkbox"/> | Will the system easier to use safely than unsafely? |
| <input checked="" type="checkbox"/> | <input type="checkbox"/> | Will there be any other potential hazards not listed above? If yes, please explain below? |

Due to the device relying on visual verification by the nurses, there is a risk of human error resulting in the incorrect number of pills going into the patient's pill box.

Figure 71: Project safety checklist