

Indian plan for Satellite-Based Navigation Systems for Civil Aviation

S. V. Kibe

Follow this and additional works at: <https://ohioopen.library.ohio.edu/spacejournal>



Part of the [Astrodynamics Commons](#), [Navigation, Guidance, Control and Dynamics Commons](#), [Space Vehicles Commons](#), [Systems and Communications Commons](#), and the [Systems Engineering and Multidisciplinary Design Optimization Commons](#)

Recommended Citation

Kibe, S. V. () "Indian plan for Satellite-Based Navigation Systems for Civil Aviation," *Online Journal of Space Communication*: Vol. 5 : Iss. 9 , Article 3.

Available at: <https://ohioopen.library.ohio.edu/spacejournal/vol5/iss9/3>

This Article is brought to you for free and open access by the OHIO Open Library Journals at OHIO Open Library. It has been accepted for inclusion in Online Journal of Space Communication by an authorized editor of OHIO Open Library. For more information, please contact debord@ohio.edu.

Indian plan for Satellite-Based Navigation Systems for Civil Aviation

Dr. S.V. Kibe

Abstract

The Airports Authority of India and the Indian Space Research Organisation (ISRO) have signed a Memorandum of Understanding (MOU) to implement a satellite based navigation system as part of the satellite based Communication, Navigation, Surveillance (CNS) and Air Traffic Management (ATM) plan for Civil Aviation in India.

For satellite based navigation in India two core constellations--Global Positioning System (GPS) of the United States and GLONASS of the Russian Federation--are available. The position accuracies achievable with these core constellations are not good enough for precision approach and landing requirements of Civil Aviation. These constellations need to be augmented. Three types of augmentation systems are possible - Ground Based Augmentation System (GBAS), Aircraft Based Augmentation Systems (ABAS) and Space Based Augmentation System (SBAS).

ISRO will implement SBAS as a proof of concept. Named GAGAN, it will incorporate GPS augmented by a geosynchronous segment. This paper describes the Indian Plan for a Satellite Based Navigation System for Civil Aviation. A brief outline of the three segments - User Segment, Space Segment and Ground Segment necessary for implementation of an SBAS system over the Indian airspace is described.

Introduction

International Civil Aviation Organisation (ICAO) Member States have endorsed Global Satellite Navigation System (GNSS) as a primary future navigation system for aviation by providing world-wide coverage and seamless navigation capability. GNSS satellite transmissions augmented by ground-based transmitters enable users to precisely navigate enroute, and perform terminal and non-precision and precision approaches.

The Airports Authority of India (AAI) has decided to implement an indigenous satellite-based regional GPS augmentation system known as Space based Augmentation System (SBAS) as part of the Satellite-based Communication, Navigation, Surveillance (CNS) / Air Traffic Management (ATM) plan for civil aviation. Towards this end, the National Plan for Satellite based Navigation System has been prepared. The Indian SBAS named GAGAN (GPS And Geo

Augmented Navigation) System will be implemented jointly by the Indian Space Research Organisation (ISRO) and AAI.

Present ATM systems in the Asia Pacific region suffer from shortcomings including:

- a. Air traffic congestion over large areas lacking adequate surveillance facilities.
- b. Choke points created by a constrained air route system built on an insufficient number of navigational aids.
- c. Dissimilar air-traffic separation (ATS) procedures and standards requiring changes to flight profiles when crossing Flight Information Region (FIR) boundaries.
- d. Duplication of resources and services based in un-coordinated CNS systems.
- e. Route congestion due to the lack of appropriate parallel ATS route structures.
- f. The existence of poor quality communication facilities and language difficulties.

The first SBAS system, a Wide Area Augmentation System (WAAS), was developed by the United States using two INMARSAT-III GEO Navigation payloads (POR & AOR-W). In 1996 the European Space Agency began developing the European Geostationary Navigation Overlay System (EGNOS) and was expected to be operational in the year 2004-2005. EGNOS uses the other two INMARSAT-III Navigation payloads (IOR & AOR-E). The MTSAT Satellite Augmentation System (MSAS) is being implemented by the Civil Aviation Bureau, Ministry of Land, Infrastructure and Transport, Government of Japan and was expected to be operational by 2004-2005. All evolving SBASs must comply with Standards And Recommended Practices (SARPs) specified by ICAO in order to provide seamless navigation to civilian aircraft across the globe. India's SBAS implementation will bridge the gap between the evolving EGNOS and MSAS system.

A mechanism is required where the Indian system becomes a part of an evolving Global Navigation Satellite System (GNSS) consisting of the core constellations and the SBASs.

The Need and Types of Augmentation

At present, there are two core constellations that provide satellite-based navigation in the world - The Global Positioning System (GPS) of the United States and GLObal NAVigation Satellite System (GLONASS) of the Russian Federation. These core constellations provide position accuracies on the order of 30 meters, Circular Error Probable (CEP) anywhere on the surface of the earth through inexpensive hand-held receivers. Both these systems operate in the L-

band. The accuracy available through these core constellations is not adequate for precision approach and landing requirements in civil aviation.

The core constellations can be augmented in three ways - Aircraft Based Augmentation System (ABAS) augments and/or integrates the information obtained from GNSS elements with information available on-board the aircraft in order to ensure operation according to the values specified in ICAO SARPs.

Ground Based Augmentation System (GBAS) consists of augmenting the core constellation through differential GPS elements implemented close to an airport and transmitting the corrections to the aircraft through a suitable data link.

Space Based Augmentation System (SBAS) refers to having GEO satellite based GPS compatible navigation payloads over a region supported by the necessary ground segment and uplink earth stations. The User Differential Range Errors (UDREs), improved iono-tropo grid models and improved GPS ephemeris are transmitted to the GEO based navigation payload that retransmits these to a modified GPS user receiver also called GNSS Receivers.

Civil aviation requirements for satellite-based navigation are specified in the ICAO SARPs which specifies the Signal-in-Space Performance requirements for civil aviation in terms of accuracy, integrity, time to alert, continuity and availability as follows:

- Accuracy (Horizontal): 16 m
- Accuracy (Vertical) : 6 m
- Integrity : $1-2 \times 10^{-7}$
- Time to Alert : 6 secs.
- Continuity : $1-8 \times 10^{-6}$
- Availability : 0.99 - 0.99999

Integrity

Integrity is a measure of trust that can be placed in the correctness of the information supplied by the total system. Integrity includes the ability of a system to provide timely and valid warnings to the users (alerts).

Time to Alert

The maximum allowable time elapsed from the onset of the navigation system being out of tolerance until the equipment enunciates the alert.

Continuity

Continuity of a system is the capability of the system to perform its function without unscheduled interruptions during the intended operation.

Availability

Availability of GNSS is characterized by the portion of time the system is to be used for navigation during which reliable navigation information is presented to the crew, auto pilot or other system managing the flight of the aircraft.

SBAS Concept

The Wide Area Differential GPS (WADGPS) also known as SBAS concept is illustrated in Figure 1. There are five major elements in any SBAS:

- i. Reference stations (RS)
- ii. Mission Control Centre (MCC)
- iii. Land Uplink Station (LUS)
- iv. The GEO Payload
- v. User GNSS receivers

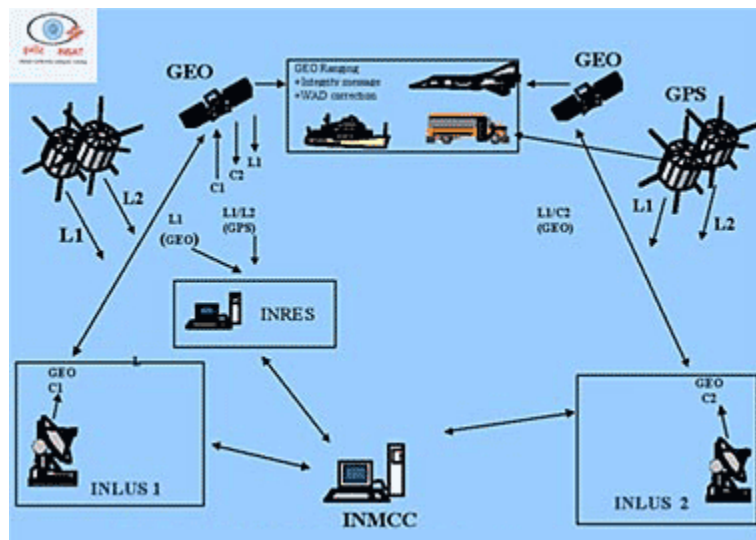

Fig. 1: WADGPS Ground Segment Concept

Indian Reference Stations (INRESs)

INRESs collect measurement data and broadcast messages from all the GPS and GEO satellites in view and forward it to the Indian Mission Control Centre (INMCC). As per the present planning, 8 INRESs will be located at the following places in India:

- New Delhi
- Bangalore
- Ahmedabad
- Calcutta
- Jammu
- Port Blair

- Guwahati
- Trivandrum

Indian Mission Control Centre (INMCC)

The chief functions of the INMCC are:

- Network Management (communication and computer)
- Integrity monitoring
- Iono-Tropo Model delay estimation
- Wide area corrections - separation of errors
- Orbit determination
- Command generation

The INMCC shall consist of a main frame computer and a host of secondary computers connected to a network. The communication interfaces of the INMCC with other ground segment elements is shown in Fig. 2. INMCC will be collocated with the INLUS at Bangalore.

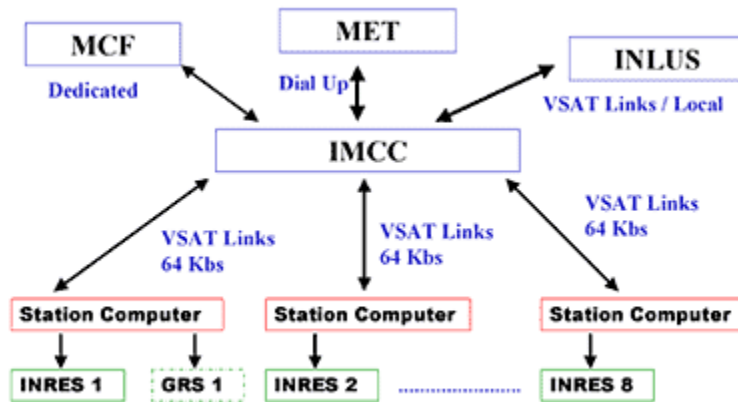

Fig. 2: Communication Interfaces

Indian Navigation Land Uplink Station (INLUS)

INLUS communicates with the Indian Navigation Payload. This earth station receives messages (which contain UDREs and Iono-tropo grid models) from the INRESs through the INMCC, format these messages and transmit them to the GEO satellite navigation payload for broadcast to users. The INLUS also provides GEO Ranging information and corrections to the GEO satellite clocks. Message formats and timing are as per the ICAO SARPs.

A configuration of the Indian Navigation Land Uplink Station is shown in Figure 3.

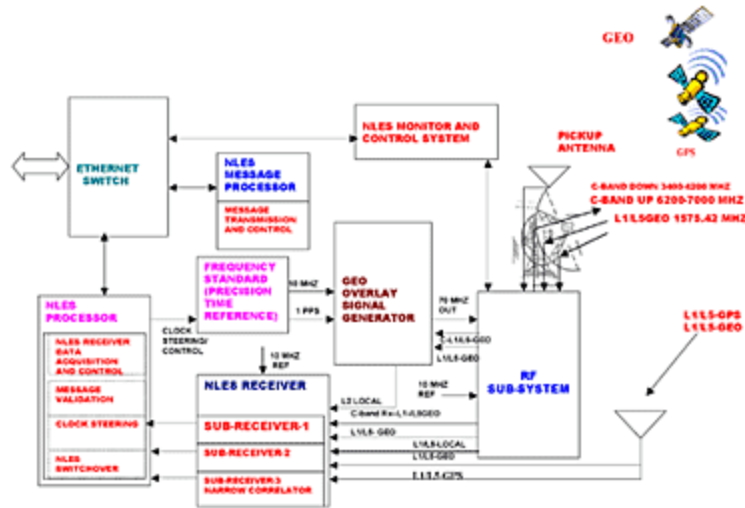

Fig. 3: Configuration of Indian Navigation Land Uplink Station

Navigation Payload

It is proposed to fly a Navigation payload compatible with GPS L1 frequency (and possibly GPS L5 frequency) on an Indian satellite to be positioned in the Indian Ocean Region between the orbital arc 48 deg. E to 100 deg.E longitude. The salient characteristics of the payload are:

- L1 D/L EIRP = 33.5 dBW
- Receive G/T = -5 dB/oK
- Power Amplifier = 40 Watts
- Coverage = Global
- Mass = 40 Kg
- Power = 140 W

The functions of the Nav. Payload are:

- to relay Geostationary overlay signal compatible with GPS L1 frequency for use by modified GPS receivers.
- to provide a CxC path for ranging by INRESs with an uplink from the INLUS.

The EIRP can be adjusted within a suitable range through on-board attenuator settings. The payload configuration and frequency plan are in shown in Figure.4 & 5 respectively. ISRO is looking into incorporating the GPS second civil frequency L2C or the third civil frequency L5.

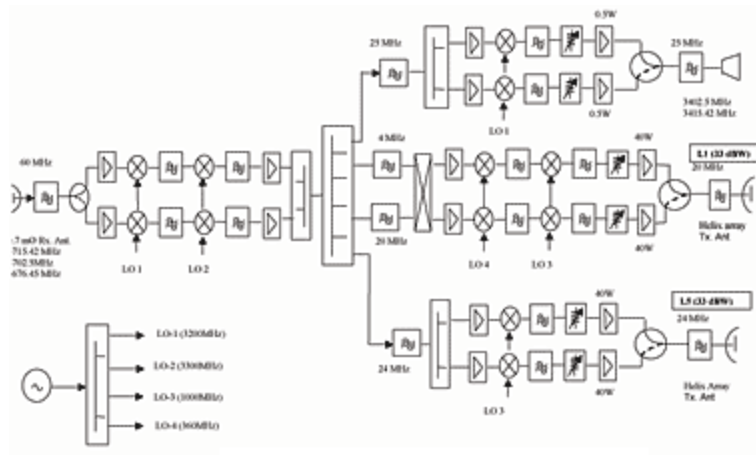

Fig. 4: Navigation Payload Schematic
[\(click for larger image\)](#)

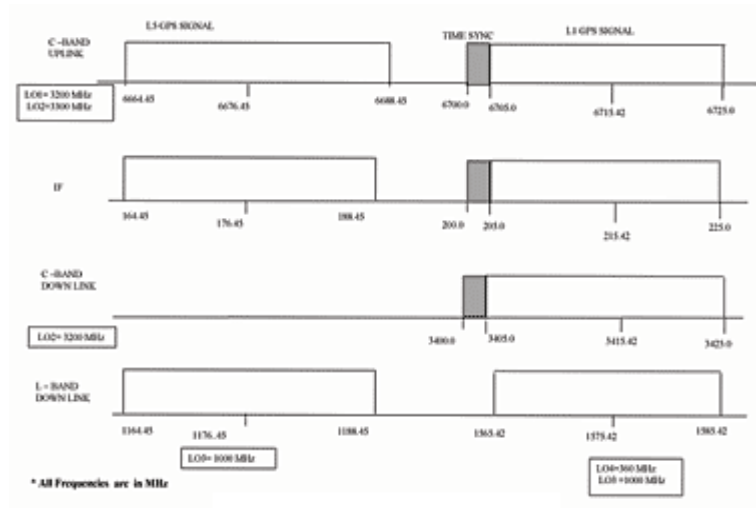

Fig. 5: Frequency Plan for the SATNAV
[\(click for larger image\)](#)

Several antenna configurations for L-band are under study. Some of the candidate antennae are:

- Prime focus reflector
- Helix array
- Patch array

The first payload was expected to be made operational in the year 2004. The L1/L5 frequency payload footprint is shown in Figure 6. A second payload shall be fabricated and kept as ground spare.

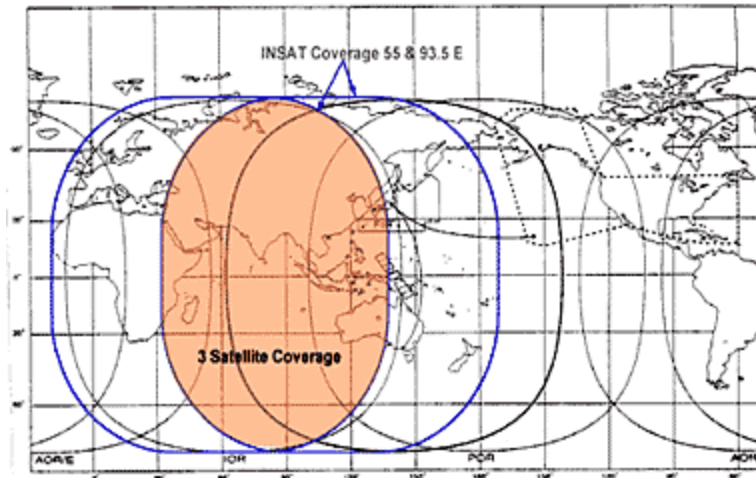

Fig. 6: Present Service Coverage for WAAS, EGNOS, MSAS, and Proposed INSAT Nav Payload

The GAGAN System

Three phases have been identified for reaching the Full Operational Capability (FOC) for GAGAN.

- Phase 1: Technology Demonstration System (TDS)
- Phase 2: Initial Experimental Phase (IEP)
- Phase 3 :Final Operational Phase (FOP)

Phase 1: Technology Demonstration System (TDS)

The objective of the Technology Demonstration System (TDS) is to develop indigenous capability in SBAS implementation. Under the TDS, the Indian Space Research Organisation (ISRO) is establishing the necessary ground and space segment for demonstration of SBAS functioning for enroute, Non-Precision Approach (NPA) and Cat.I landing capability over a limited airspace initially.

The ground segment configuration for the TDS phase is as follows:

- i. Up to 8 Indian Reference Stations (INRESSs) at widely separated geographical area in India.
- ii. An Indian Master Control Centre (INMCC) located at Bangalore.
- iii. An Indian Navigation Land Uplink Station (INLUS) collocated with the INMCC.
- iv. One Navigation Payload in the Indian Ocean Region (IOR) between the orbital locations 48° E to 100° E.

Phase 2: Initial Experimental Phase (IEP)

After the successful completion of the TDS, redundancies will be provided to the space-segment, INMCC, INLUS and system validation carried out over the entire

Indian Airspace possibly in association with an international agency. The conventional navigational aids will continue to be operational as prime mode. INMCC will be configured for WAD technology and for operations with Indian space-segment. Based on the experience of the TDS, additional augmentation will be worked out.

The activities during the Initial Operational Phase will be defined in greater detail after gaining experience during the TDS phase. Experience world-wide shows that in this phase most of the technical problems in the navigation software such as, integrity, availability etc. are resolved. Such resolutions are specific to the airspace and the availability of GPS satellites and GEO augmentations.

Phase 3: Final Operational Phase (FOP)

During the Final Operational Phase (FOP), additional INRESs will be established as required and the communication systems will be established with all redundancies. INMCC and NLES will be augmented with operational hardware and adequate redundancy. INRESs will be augmented with operational hardware.

During the IEP and the FOP, parallel attempts will be made to develop SATNAV compatible GNSS receivers of international standards indigenously.

Impact of Ionospheric tropospheric multi-path, ephemeris and clock related errors

The ionosphere delays the L-band signals and introduces unpredictable range errors. The ionospheric conditions in the low latitude regions are more difficult to measure and model. The ephemeris error in the data downlinked through the GPS L1 frequency to ordinary GPS receivers is in the vicinity of about 7 - 8 meters. This translates to an equivalent position error. In SBAS a better ephemeris model (through UDREs) is transmitted to the Geo-Stationary satellite which enables a modified GPS receiver to improve the ionospheric and ephemeris related errors resulting in better position accuracies. Clock errors are offset through accurate measurements made at INRESs since this is a one dimensional error.

Ephemeris

It is well known that the signal multi-path at the reference stations caused by satellite signal reflection and defraction from overhead and nearby objects degrades ranging measurements. Adequate care will be taken to have antennae and receivers at the INRESs to reduce multi-path errors.

Iono-Tropo Modelling

Iono-Tropo modelling and scintillation studies in the L-band will be carried out over the entire Indian Airspace as an integral part in the TDS Phase 1.

The following strategy has been adopted to develop suitable grid based ionospheric model over the Indian region.

- a. About 20 total electron content (TEC) receivers shall be located at the Centre of the 25 deg x 5 deg. ionospheric grid points (IGP) over the Indian region as shown in Figure 7.
- b. The data from these receivers shall be logged into a personal computer and the logged data shall be delivered to all academic and scientific institutions on which contracts are placed to carryout the necessary studies.
- c. All receivers and PCs shall have an uninterruptible power supply (UPS) and necessary housing at all the 20 sites. The instrumentation at all the sites shall be identical. A suitable Ionospheric Scinti-llation and TEC monitor receiver equipment which is best suited for these studies shall be deployed at all the sites.

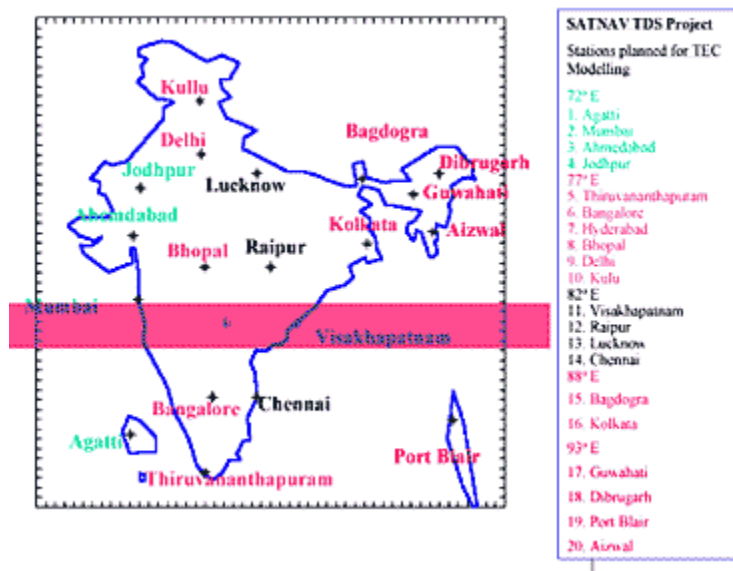

Fig. 7: Planned TEC Stations

International Coordination

Advanced Publication Information (API) for the Indian Nav. Payloads has been filed with the International Telecommunications Union (ITU).

During the IEP and FOP, international assistance would be sought for the definition of inter-operability for the Indian SBAS, system validation, testing and certification.

ACKNOWLEDGEMENTS

- The assistance rendered by Smt. Nalini R. Naik in preparing and typing the manuscript is gratefully acknowledged.