

A Comparative Study of Photo-Degradation of Atrazine in Aquatic Environments Using UV and UV/Fe (III)-TiO₂ Processes

Narges shamsedini^{1,2}, Mohammad Ali Baghapour³, Mansooreh Dehghany^{*3}

1) Department of Environmental Health Engineering, School of Health, Student Research Committee, Shiraz University of Medical Sciences, Shiraz, Iran

2) Fars water and wastewater company, Shiraz, Iran

3) Research Center for Health Sciences, Department of Environmental Health, School of Health, Shiraz University of Medical Sciences, Shiraz, Iran

* corresponding author: mdehghany@sums.ac.ir

ABSTRACT

A vast variety of pesticides are used for agricultural pests in Iran. The release of these persistent organic pollutants into water supplies leaves adverse effects on both the environment and public health. This study aimed to compare the photo-degradation of atrazine in the aquatic environment using UV and UV/Fe (III)-TiO₂ processes.

The effects of parameters including pH, the initial concentration of atrazine, and reaction time on the removal of atrazine in the aqueous phase using ultraviolet radiation (1020 μW/cm²) and UV/Fe (III)-TiO₂ were investigated. Residual concentrations were determined using HPLC. Finally, the data were analyzed using SPSS software (version 16) and the graph was made by MATLAB software.

The results demonstrated that the atrazine removal rate in both processes was significantly increased in acidic and alkaline conditions. By increasing initial atrazine concentrations, the removal rate was increased in both processes as well. Data showed that at the lower initial concentration of atrazine (0.1 and 1mg/l) the removal rate in UV/ Fe (III) - TiO₂ process was more than the UV process. However, at higher concentration, both processes were almost the same and the maximum removal efficiency (99.2% at UV and 99.11% at UV /Fe (III) - TiO₂) occurred at pH=11, initial Atrazine concentration of 10mg/L and the reaction time 30 min

In conclusion, UV and Fe⁺³-TiO₂/UV process was an appropriate method to reduce atrazine in contaminated water resources.

Keywords: Atrazine, UV, UV/Fe (III)-TiO₂, Photodegradation

INTRODUCTION

Atrazine is widely used in broadleaf weed control for several decades [1]. Atrazine contamination in groundwater, rivers and other aquatic systems has caused serious environmental impacts through agricultural runoff because of its persistence and ecotoxicity [2-4]. Also, Atrazine's half-life in groundwater has been reported to vary from 15 months to 20 years [5, 6]. United States Environmental Protection Agency (EPA) and European Union (EU) have established the maximum amount of herbicides in drinking water in the ppb range. EU has established the permissible limit for the Atrazine as 0.1μg/L [7-9]. However, EPA, World Health Organization (WHO), and Institute of Standards and Industrial Research of Iran (ISIRI) have established the MCL of Atrazine in drinking water as 3, 2, and 2μg/L, respectively[10-12]. Atrazine is easily absorbed through the digestive tract, skin, and lungs and chronic exposure to levels above the MCL causes heart diseases, retinal and muscle damage, weight loss, and damage to the adrenal gland [13]. This pesticide is well known as an endocrine disruptor for amphibians [14]

Atrazine showed some ecotoxicity in aquatic ecosystems even at the ppb level. In several cases ever reported, only 40–90% of Atrazine could be removed by the wild type Atrazine-degrading strain or mixed microbial consortium in the conventional biological treatment processes, even though hydraulic retention time (HRT) was prolonged to 5–7 d [15, 16]. As a result, not biological, but chemical and physical methods were often used for the treatment of Atrazine containing wastewater, such as zero-valent iron reduction[17], photocatalytic ozonation [18, 19], wet peroxide [20], adsorption [21], and so on [22, 23]. These techniques still require research to improve treatment efficiencies, identify degradation compounds and determine the cost and feasibility of full-scale applications. Thus, the oxidation processes described in this paper are another proposed option for the degradation of pesticide in water for consideration so that we can outperform the conventional and advanced processes used currently.

It is proposed that water purification using a new technology of high-power density UV-LED light source with titania nanoparticle photocatalysts provides a better way to remove the contaminants.

Titanium dioxide (TiO₂), or titania, is a commonly occurring oxide that has a wide range of applications, especially as a photocatalyst. In the presence of light, the photons have higher energy than the semiconductor bandgap, resulting in photons being absorbed, and an electron is promoted to the conduction band, leaving a hole in the valence band. This excited electron is then used directly to drive the chemical reaction [24].

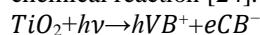

The degradation performance of TiO₂ is attributed to highly oxidizing hydroxyl radicals. Virtually any organic compound can be completely mineralized with irradiated TiO₂, except for cyanuric acid, which is fortunately non-toxic [25].

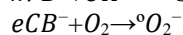
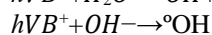
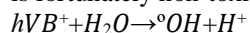

The electron/hole pair participates in reactions with absorbed molecules on the titania surface within milliseconds. In recent years, many groups have examined the effect of metal doping on the photocatalytic properties of TiO₂. The incorporation of transition metals into TiO₂ crystal lattice alters the photoreactivity by shifting the bandgap of the catalysts into the visible region [26-29]. For instance, Blazkova *et al.* doped Pt in TiO₂ immobilized on glass fibres by sol-gel technique to improve phenol photodegradation under UV irradiation [30]. The reflectance spectra of TiO₂-containing Fe have shown increased absorption dependence on annealing temperature and Fe concentration [31].

Photolysis involves the interaction of artificial or natural light with the target molecule and the induction of photochemical reactions, which can lead to its degradation to intermediate products whose further decomposition eventually yields mineralized end-products. Ultraviolet treatment has traditionally been employed for the disinfection of drinking water with the advantage of minimizing the formation of any regulated disinfection by-products, as compared to chlorination [25]. Bushnqe *et al.* showed that the Atrazine removal rate at a concentration of 5mg/L, in the presence of UV radiation with the intensity of 1.25 mw was 11% after 5 hours [32]. Fogarty *et al.* showed that photocatalytic oxidation of ciprofloxacin under UV-LED light was 98% after 60 min and the maximum degradation occurred in the first 20 min of reaction time [24].

The purpose of this project was to determine the degree of removal of Atrazine in water samples to provide data supporting the feasibility of this novel approach to water purification and comparison of the ultraviolet radiation and the UV /Fe (III) - TiO₂ methods for the photo-degradation Atrazine.

Materials and methods

This study was done in a batch reactor. The experiment was replicated twice in batch mode. The studied parameters were reaction time (0, 30, 60, 90 and 120 minutes), TiO₂ with iron (Fe⁺³) concentration (0 - 25mg/L), and initial Atrazine concentration (0.1, 1 and 10mg/L) at different pH levels (3-11). The optimal conditions were determined according to maximum Atrazine removal efficiency. One factor at the time of designing was used to determine the number of samples and then all data were presented based on the mean.

Chemicals and Analytical Method

Atrazine with 99.9% purity was purchased from Sigma Aldrich Company (USA). Other chemical products such as TiO₂ were purchased from Merck (Germany). We used a Scanning Electroscopie Microscope (SEM) (EM3200, KYKY Company, China) to determine the morphology and the mean diameter of the catalyst's particles. UV lamp, 1020μw/cm² was used as the radiation source. For Atrazine detection in the aqueous phase, a Waters Model high-performance liquid chromatography (HPLC) (Waters YL9100HPLC SYSTEM, USA) system with C18 columns (CP-SIL 5 CB column model, 250*4.6 mm, 5μm) was calibrated and tested prior to the injection of samples. The mobile phase included methanol and water (20/80V/V) with a flow rate of 0.5mL/min. A UV absorbance detector at 224 nanometer wavelength was used to detect Atrazine in the samples. The retention time for Atrazine was 9 minutes. The detection limit for the sample was 0.001mg/L. The atrazine chromatogram is presented in Fig. 1. The cell-gel method was used to prepare Fe⁺³-TiO₂ nanocatalyst powder [33]. At first, ferrous nitrate was dissolved in half of the propanol (121.775mL) and completely mixed. After 15 minutes, 121.775mL of propanol was mixed with 62.77 ml Titanium Tetra Iso Propoxide (TTIP) and then the mixture was added very slowly for 75 minutes to the former solution to form the sol. Meanwhile, deionized distilled water (8.33mL) was added to the solution as well. Thirty minutes after the addition of propanol to TTIP, the pH was adjusted to 3 by nitric acid. All the processes were performed in mixing mode using the homogenizer. Then, the resulting solution was placed on the magnetic mixer for 24 hours to form a jelly. Then, the formed jelly was put in the oven at 80 °C for 10 hours to evaporate the alcohol. To activate the catalyst, the jelly was put in the oven at 500±50 °C for 2 hours. The activated catalyst was put in a desiccator until it was cool. Finally, the catalyst was powdered [33]. In all the experiments, the amount of catalyst was stable (TiO₂=25mg/L).

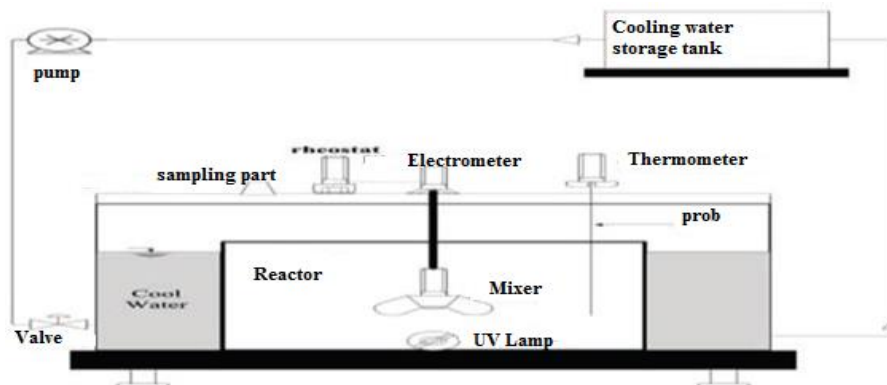

Fig. 1: The specification of the photochemical reactor

Reactor Specification

The specification of the photochemical reactor is shown in Fig. 1. The experiment was performed in a 1 litre volume reactor. The test was performed in a closed glass reactor with an adjustable mixer. The source of radiation was a UV lamp which was protected by a Quartz tube. The UV radiation source was immersed in the solution for better radiation. The whole system was wrapped in aluminium foil in order to prevent reflection.

Measuring the effect of different parameters on the removal rate of Atrazine by UV and UV /Fe (III) - TiO₂ processes

To measure the effect of different parameters on the removal rate of Atrazine by UV and UV /Fe (III) - TiO₂ processes in the aqueous phase, different parameters such as pH(3–11), initial Atrazine concentration (0.1, 1, and 10mg/L) similar to another study [50], and the contact times of 0, 30, 60, 90 and 120min were studied. The samples were passed through a Whatman filter cellulose acetate membrane with 0.22 micron pore size (Germany). After that, the residual Atrazine was determined by HPLC. All the experiments were performed in two replications in the presence of the control samples. Finally, SPSS software (version 16) with repeated measures was used to analyze the data and the graph was made by MATLAB software

RESULTS AND DISCUSSION

The retention time for the Atrazine was 9 minutes. The detection limit for the sample was 0.001mg/L. The atrazine chromatogram is presented in Fig. 2.

The photodegradation of Atrazine using UV and UV /Fe (III) - TiO₂ processes is shown in Figs. 3-5.

The effect of pH on the Atrazine removal efficiency at UV and UV /Fe (III) - TiO₂ processes is shown in Fig.3. According to Fig. 3, in both processes, the maximum and minimum removal efficiency of Atrazine occurred at pH of 11 and 7, respectively.

Furthermore, the maximum removal efficiency (99.2% at UV and 99.11% at UV /Fe (III) - TiO₂) occurred at pH=11, initial Atrazine concentration of 10mg/L and the reaction time 30 min. However, the results of regression analysis showed that there was no linear relationship and a significant difference between the Atrazine removal rates and pH ($P>0.05$).

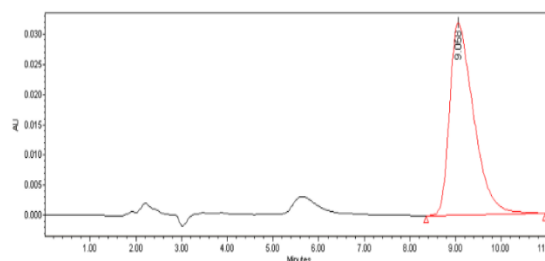

Fig.2: Atrazine chromatogram

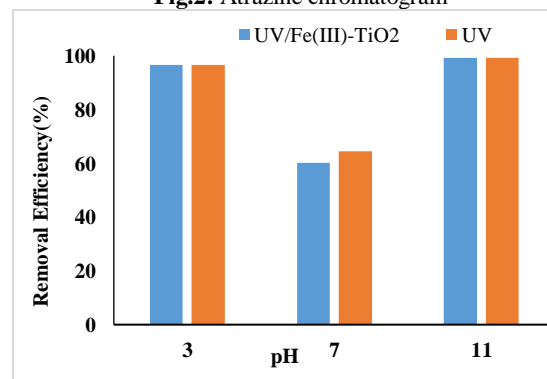

Fig. 3: Effect of pH on the removal efficiency of Atrazine by UV and UV /Fe (III) - TiO₂ processes (Initial Atrazine Concentration= 10mg/L, Reaction Time = 30 min, TiO₂=25mg/L).

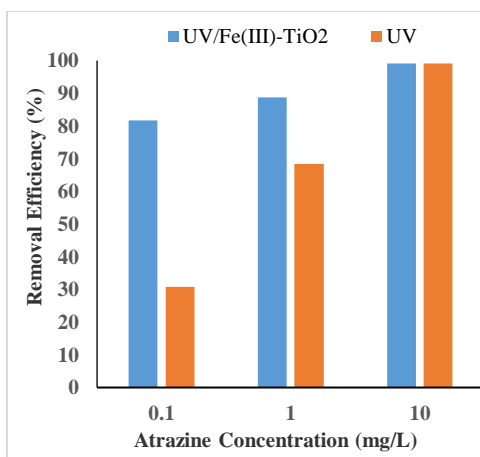

Fig. 4: Effect of initial Atrazine concentration on the removal efficiency of Atrazine by UV and UV /Fe (III) - TiO₂ processes (pH = 11, Reaction Time = 30 min, TiO₂=25mg/L).

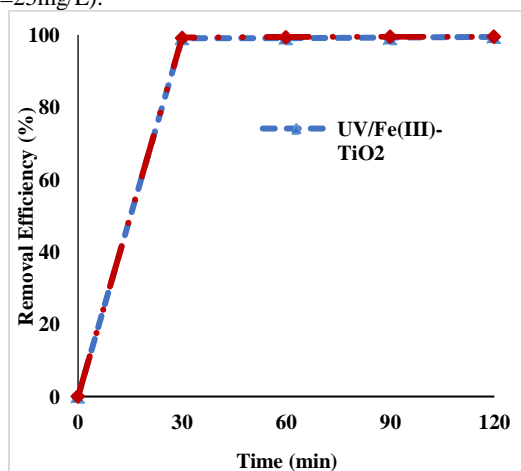

Fig. 5: Effect of reaction time on the removal efficiency of Atrazine by UV and UV /Fe (III) - TiO₂ processes (pH =11, Initial Atrazine Concentration= 10 mg/L, TiO₂=25 mg/L). According to Fig. 4, the maximum removal rate of Atrazine occurred at an initial Atrazine concentration of 10mg/L (99.11% at UV and 99.44% at UV /Fe (III) - TiO₂) and Atrazine removal rate increased by increasing the initial Atrazine concentration. However, the results of regression analysis showed that there was no linear relationship and a significant difference between the Atrazine removal rates and initial Atrazine concentration ($P > 0.05$).

According to Fig. 5, at first, the photodegradation of Atrazine was very fast (30 min reaction time) and then it became slow until it reached the plateau (120 min). The results showed that the removal efficiency of Atrazine increased with time and it reached 99.54% and 99.47% removal at UV and UV /Fe (III) - TiO₂ processes at 120 minutes, respectively. However, the results of regression analysis showed that there was a significant difference between the Atrazine removal rates and reaction time ($P < 0.05$).

The optimization of influencing parameters including pH, initial Atrazine concentration and the reaction time on the removal of Atrazine herbicide from the aqueous phase using UV and UV /Fe (III) - TiO₂ processes were studied in the current research.

Effect of pH on the Removal of Atrazine from the Aqueous Phase Using UV and UV /Fe (III) - TiO₂ processes

pH is one of the most important factors that affect the efficiency of many chemical and biological processes [26]. It has a significant role in the production of hydroxyl radical (OH[•]) as well. This radical has been shown to oxidize many different recalcitrant organic pollutants into mineral end-products [34]. Results showed that the maximum removal rate of Atrazine in both processes occurred at alkaline condition (pH=11) due to the formation of high concentrations of hydroxyl radical [35] (Fig.3). It can be assumed that Atrazine is degraded in this study through two possible ways including direct photolysis by UV radiation and oxidation by OH[•] radicals [36]. In general, the Atrazine removal rate has been indifferent pH levels by the UV slightly more than UV / Fe (III) - TiO₂ (Fig.3). A study conducted by Dehghani *et al.* showed that better removal of penicillin G occurred at acidic condition (pH=3) using UV radiation and the removal rate of antibiotic decreased by increasing pH [26]. But many other studies demonstrated that better removal of Atrazine occurred at higher pH levels [32, 37]. Also, Bushnqe *et al.* showed that pH does not play an important role in the direct photolysis of Atrazine and the removal rate increased by increasing pH [32]. Prado *et al.* also showed that the maximum removal rate of Atrazine was at pH=11.5 using the ozonation process and the removal rate of Atrazine increased as pH increased [37]. This result agrees with the research performed by Bushnqe [38] and Prado *et al.* [37].

Effect of Initial Atrazine Concentration on the Removal of Atrazine from the Aqueous Phase Using UV and UV /Fe (III) - TiO₂ processes

In both processes, the maximum photodegradation of Atrazine was related to the initial concentration of 10mg/L. In total, the Atrazine removal rate has been in low concentrations (0.1 and 1mg/l) by the UV/ Fe (III) - TiO₂ more than UVprocess but a concentration of 10mg/L the Atrazine removal rate in both processes have not been significantly different (Fig.4). We also found that increasing the Atrazine concentration led to higher photodegradation rates of the herbicide and followed the first-order kinetic [39]. The results of Baghapour *et al.*'s study indicated that the removal efficiency increased with increasing the concentration of Atrazine and the highest removal efficiency was obtained at Atrazine concentration of 10mg/L which was in the same line with the results of this survey

[38]. At the higher concentration of pollutants, the rate of Atrazine removal was higher due to higher kinetic. However, Dehghani *et al.* [26] and Hemati *et al.* [35] reported that removal efficiency decreased by increasing the initial concentration of penicillin G and phenol, respectively.

Effect of Reaction Time on the Removal of Atrazine from the Aqueous Phase Using UV and UV/Fe (III) - TiO₂ processes

According to the results, at first, the photodegradation of Atrazine was very fast (30 min) and then it became slow until it reached the plateau (120 min). The results showed that the removal efficiency of Atrazine increased with time and it reached 99.54% and 99.47% removal at UV and UV/Fe (III) - TiO₂ processes at 120 minutes, respectively (Fig.5). This phenomenon may be related to the higher chance of Atrazine photodegradation when the exposure time to the UV radiation and UV/Fe (III) - TiO₂ is increased and more oxidation reaction proceeds in the presence of hydroxyl radicals as well. In fact, the reaction rate at equilibrium reached a plateau. Moreover, determining the required time to reach equilibrium is also very important to have a cost-effective and economical process [40, 41]. Vlaardingerboek showed that Atrazine was completely degraded using UV/TiO₂ after 150 min reaction time[42]. Bahena *et al.* demonstrated that complete oxidation of Atrazine occurred at 75 min by TiO₂ in the presence of sunlight [43].

CONCLUSION

The results demonstrated that the Atrazine removal rate in both processes increased in acidic and alkaline conditions but in neutral conditions, it decreased. In total, the Atrazine removal rate has been indifferent pH levels by the UV slightly more than UV /Fe (III) - TiO₂). Also, in both processes with increasing concentrations, the Atrazine removal rate increased. In total, the Atrazine removal rate has been in low concentrations (0.1 and 1mg/l) by the UV/Fe (III) - TiO₂ more than UV process but at a concentration of 10mg/l, the Atrazine removal rate in both processes have not been significantly different. Also, the results showed that in both processes the removal efficiency of Atrazine increased with time and it reached 99.53% and 99.47% removal at UV and UV /Fe (III) - TiO₂ processes at 120 minutes, respectively. In both processes, the maximum rate of Atrazine removal at optimal condition occurred in pH=11, Atrazine concentration=10mg/L at 30 min. Based on the results, the UV process efficiency compared with the UV/Fe (III)-TiO₂ process to remove Atrazine from the aquatic environment has been not significantly different.

ETHICAL ISSUES

Not applicable

CONFLICT OF INTEREST

The authors declare no conflict of interest.

AUTHORS' CONTRIBUTIONS

The overall implementation of this study including design, experiments and data analysis, and manuscript preparation were the results of the corresponding author's efforts. All authors have made an extensive contribution to the review and finalization of this manuscript. All authors read and approved the final manuscript.

FUNDING/ SUPPORTS

Deputy of Research and Technology of Shiraz University of Medical Sciences had financial support for this research project

ACKNOWLEDGEMENT

This article was extracted from the thesis written by Mrs Narges Shamsedini, MSc student of Environmental Health engineering. The authors would like to thank the Deputy of Research and Technology of Shiraz University of Medical Sciences for its financial support for the research project of 93-7043 . They are also grateful to the research and consultation centre (RCC) of Shiraz University of Medical Sciences for editorial assistance.

REFERENCES

- [1] US Environmental Protection Agency (USEPA). Memorandum: Atrazine. HED Product and Residue Chemistry Chapters. Washington, D.C.: Office of Prevention, Pesticides and Toxic Substances; 2001.
- [2] Winkelmann D, Klaine S. Degradation and bound residue formation of four atrazine metabolites, deethylatrazine, deisopropylatrazine, dealkylatrazine and hydroxyatrazine, in a western Tennessee soil. *Environmental toxicology and chemistry*. 1991;10(3):347-54.
- [3] Kruger EL, Somasundaram L, Coats JR, Kanwar RS. Persistence and degradation of [14C] atrazine and [14C] deisopropylatrazine as affected by soil depth and moisture conditions. *Environmental Toxicology and Chemistry*. 1993;12(11):1959-67.
- [4] Graymore M, Stagnitti F, Allinson G. Impacts of atrazine in aquatic ecosystems. *Environment international*. 2001;26(7):483-95.
- [5] Grover R, Cessna A. *Environmental chemistry of herbicides*: CRC press; 1990.
- [6] Spalding RF, Exner ME, Snow DD, Cassada DA, Burbach ME, Monson SJ. Herbicides in groundwater beneath Nebraska's management systems evaluation

- area. *Journal of environmental quality*. 2003;32(1):92-99.
- [7] Farré M, Martínez E, Ramón J, Navarro A, Radjenovic J, Mauriz E, *et al.* Part per trillion determination of atrazine in natural water samples by a surface plasmon resonance immunosensor. *Analytical and bioanalytical chemistry*. 2007;388(1):207-14.
- [8] Getenga Z, Dörfler U, Iwobi A, Schmid M, Schroll R. Atrazine and terbuthylazine mineralization by an *Arthrobacter* sp. isolated from a sugarcane-cultivated soil in Kenya. *Chemosphere*. 2009;77(4):534-39.
- [9] Beale DJ, Porter NA, Roddick FA. A fast screening method for the presence of atrazine and other triazines in water using flow injection with chemiluminescent detection. *Talanta*. 2009;78(2):342-47.
- [10] Katsumata H, Kojima H, Kaneco S, Suzuki T, Ohta K. Preconcentration of atrazine and simazine with multiwalled carbon nanotubes as solid-phase extraction disk. *Microchemical journal*. 2010;96(2):348-51.
- [11] Katsumata H, Kaneco S, Suzuki T, Ohta K. Determination of atrazine and simazine in water samples by high-performance liquid chromatography after preconcentration with heat-treated diatomaceous earth. *Analytica chimica acta*. 2006;577(2):214-19.
- [12] Nasser S, Dehghani M, Amin S, Naddafi K, Zamanian Z. Fate of atrazine in the agricultural soil of corn fields in Fars province of Iran. *Iranian Journal of Environmental Health Science & Engineering*. 2009;6(4):223-32.
- [13] Van Leeuwen JA, Waltner-Toews D, Abernathy T, Smit B, Shoukri M. Associations between stomach cancer incidence and drinking water contamination with atrazine and nitrate in Ontario (Canada) agroecosystems, 1987-1991. *International Journal of Epidemiology*. 1999;28(5):836-40.
- [14] Fatima M, Mandiki S, Douxfils J, Silvestre F, Coppe P, Kestemont P. Combined effects of herbicides on biomarkers reflecting immune-endocrine interactions in goldfish: immune and antioxidant effects. *Aquatic Toxicology*. 2007;81(2):159-67.
- [15] Kontchou CY, Gschwind N. Biodegradation of Triazine Compounds by a Stable Mixed Bacterial Community. *Ecotoxicology and environmental safety*. 1999;43(1):47-56.
- [16] Ghosh PK, Philip L. Atrazine degradation in anaerobic environment by a mixed microbial consortium. *Water Research*. 2004;38(9):2277-84.
- [17] Dombek T, Dolan E, Schultz J, Klarup D. Rapid reductive dechlorination of atrazine by zero-valent iron under acidic conditions. *Environmental Pollution*. 2001;111(1):21-27.
- [18] Horikoshi S, Hidaka H. Non-degradable triazine substrates of atrazine and cyanuric acid hydrothermally and in supercritical water under the UV-illuminated photocatalytic cooperation. *Chemosphere*. 2003;51(2):139-42.
- [19] Farré MJ, Franch MI, Malato S, Ayllón JA, Peral J, Doménech X. Degradation of some biorecalcitrant pesticides by homogeneous and heterogeneous photocatalytic ozonation. *Chemosphere*. 2005;58(8):1127-33.
- [20] Rodríguez EM, Álvarez PM, Rivas FJ, Beltrán FJ. Wet peroxide degradation of atrazine. *Chemosphere*. 2004;54(1):71-78.
- [21] Campos C, Snoeyink VL, Mariñas B, Baudin I, Laine J. Atrazine removal by powdered activated carbon in floc blanket reactors. *Water Research*. 2000;34(16):4070-80.
- [22] Saltmiras DA, Lemley AT. Atrazine degradation by anodic Fenton treatment. *Water research*. 2002;36(20):5113-19.
- [23] Ma J, Graham NJ. Degradation of atrazine by manganese-catalysed ozonation—influence of radical scavengers. *Water Research*. 2000;34(15):3822-28.
- [24] Fogarty C. Photocatalytic Oxidation of Ciprofloxacin Under UV-LED Light. Worcester Polytechnic Institute. 2013.
- [25] Carp O, Huisman CL, Reller A. Photoinduced reactivity of titanium dioxide. *Progress in solid state chemistry*. 2004;32(1):33-177.
- [26] Dehghani M, Nasser S, Ahmadi M, Samaei MR, Anushiravani A. Removal of penicillin G from aqueous phase by Fe-TiO₂/UV process. 2014.
- [27] Dvoranova D, Brezova V, Mazúr M, Malati MA. Investigations of metal-doped titanium dioxide photocatalysts. *Applied Catalysis B: Environmental*. 2002;37(2):91-05.
- [28] Wang Y, Cheng H, Zhang L, Hao Y, Ma J, Xu B, *et al.* The preparation, characterization, photo electrochemical and photocatalytic properties of lanthanide metal-ion-doped TiO₂ nanoparticles. *Journal of molecular catalysis A: chemical*. 2000;151(1):205-16.
- [29] Ohno T, Tanigawa F, Fujihara K, Izumi S, Matsumura M. Photocatalytic oxidation of water by visible light using ruthenium-doped titanium dioxide powder. *Journal of Photochemistry and Photobiology A: Chemistry*. 1999;127(1):107-10.
- [30] Blazkova A, Csölleová I, Brezova V. Effect of light sources on the phenol degradation using Pt/TiO₂ photocatalysts immobilized on glass fibres. *Journal of photochemistry and photobiology A, Chemistry*. 1998;113(3):251-56.
- [31] Chen J-N, Chan Y-C, Lu M-C. Photocatalytic oxidation of chlorophenols in the presence of manganese ions. *Water science and technology*. 1999;39(10):225-30.

- [32] Bushnaq Z. Evaluation of UVA, UVB and UVC Photolysis and Photocatalysis for the Removal of Atrazine from Contaminated Water. 2006.
- [33] NavôÁoa JA, Testab JJ, Djedjeianb P, PadroÂnb JR, RodrôÁguezb D, Litterb MI. Iron-doped titania powders prepared by a sol±gel method. Part II: Photocatalytic properties. *Applied Catalysis A: General*. 1999;178(191):111-20.
- [34] Konstantinou IK, Albanis TA. Photocatalytic transformation of pesticides in aqueous titanium dioxide suspensions using artificial and solar light: intermediates and degradation pathways. *Applied Catalysis B: Environmental*. 2003;42(4):319-35.
- [35] Hemmati Borji S, Nasseri S, Nabizadeh Nodehi R, Mahvi A, Javadi A. Photocatalytic degradation of phenol in Aqueous Solutions by Fe (III)-doped TiO₂/UV Process. *Iranian Journal of Health and Environment*. 2011;3(4):369-80.
- [36] Du Y, Su Y, Lei L, Zhang X. Role of oxygen in the degradation of atrazine by UV/Fe (III) process. *Journal of Photochemistry and Photobiology A: Chemistry*. 2009;208(1):7-12.
- [37] Prado J, Esplugas S. Comparison of different advanced oxidation processes involving ozone to eliminate atrazine. 1999.
- [38] Baghapour MA, Nasseri S, Derakhshan Z. Atrazine removal from aqueous solutions using submerged biological aerated filter. *Journal of Environmental Health Science and Engineering*. 2013;11(1):6-11.
- [39] Batra M, Pandey J, Suri C, Jain R. Isolation and characterization of an atrazine-degrading *Rhodococcus* sp. strain MB-P1 from contaminated soil. *Letters in applied microbiology*. 2009;49(6):721-29.
- [40] Dehghani M, Nasseri S, Zamanian Z. Biodegradation of alachlor in liquid and soil cultures under variable carbon and nitrogen sources by bacterial consortium isolated from corn field soil. *Iran J Environ Health Sci Eng*. 2013;10(1):10-21.
- [41] Dehghani M, Naseri S, Karamimanesh M. Removal of 2, 4-Dichlorophenolxyacetic acid (2, 4-D) herbicide in the aqueous phase using modified granular activated carbon. *J Environ Health Sci Eng*. 2014;12(28):2-10.
- [42] Vlaardingerboek A, Brignon J-M, Genty A, Feenstra L, Oesterholt I, Krupanek J, *et al.* An Inventory and Assessment of Options for Reducing Emissions: Atrazine. *Source Control of Priority Substances in Europe*. 2009.
- [43] Bahena CL, Martínez SS. Photodegradation of chlorbromuron, atrazine, and alachlor in aqueous systems under solar irradiation. *International Journal of Photoenergy*. 2006.