

**A Process-Based Approach for Integrating the Last Planner System In 4D  
Modeling for Equipment Workspace Planning in Elevated Urban Highway  
Projects**

Charles Nnaemeka Igwe

A Thesis

In the Department

Of

Building, Civil & Environment Engineering

Presented in Partial Fulfillment of the Requirements

For the Degree of Doctor of Philosophy (Building Engineering) at

Concordia University

Montreal, Quebec, Canada

**January 2021**

**© Charles Nnaemeka Igwe, 2021**

**CONCORDIA UNIVERSITY**  
**School of Graduate Studies**

This is to certify that the thesis prepared

By: **Charles Nnaemeka Igwe**

Entitled: **A Process-Based Approach for Integrating the Last Planner System in 4D Modelling for Equipment Workspace Planning in Elevated Urban Highway Projects**

And submitted in partial fulfillment of the requirements for the degree of

**DOCTOR OF PHILOSOPHY (Building Engineering)**

Complies with the regulations of the University and meets the accepted standards with respect to originality and quality.

Signed by the final examining committee:

\_\_\_\_\_ Chair

Dr. Y. Zhang

\_\_\_\_\_ External Examiner

Dr. Abdulkadir Ganah

\_\_\_\_\_ External to Program

Dr. Ketra Schmitt

\_\_\_\_\_ Examiner

Dr. Osama Moselhi

\_\_\_\_\_ Examiner

Dr. Ahmed Soliman

\_\_\_\_\_ Thesis Supervisor

Dr. Fuzhan Nasiri

\_\_\_\_\_ Thesis Supervisor

Dr. Amin Hammad

Approved by: Ashutosh Bagchi  
Chair of Department

Mourad Debbabi  
Dean of Faculty

---

## **ABSTRACT**

### **A Process-Based Approach for Integrating the Last Planner System in 4D Modelling for Equipment Workspace Planning in Elevated Urban Highway Projects**

**Charles Igwe. Ph.D.**

**Concordia University, 2021**

Transportation developments are shifting from the construction of new highways to the reconstruction of existing ones, especially in urban areas. The reconstruction of elevated urban highways typically requires substantial capital investments and long durations. The prevalence of non-value adding activities otherwise referred to as non-physical wastes according to the Lean Construction (LC) paradigm is one attributable reason for this. Another feature of urban highway projects is the use of heavy construction equipment. Planning the equipment workspace becomes very important to facilitate the reduction/elimination of non-physical wastes and ensure no delays to the project completion arising from spatio-temporal conflicts. Four-dimensional (4D) modelling techniques have proven benefits to effective construction planning. Still, some limitations exist in the lack of a practical approach to support construction planning and incorporate workspace modelling in the 4D model development process. Several studies with different perspectives have been carried out to describe the gains of using 4D models in workspace management. However, none of them considered the effects of the limited usable space in the reconstruction of elevated urban highways. Moreover, the requirements for multiple levels of detail (LOD) in scheduling large and complex projects present a new challenge. To counter these challenges, a considerable amount of time is required to ensure that the LOD of the 4D model is sufficient to account for the following: (1) *micro-scheduling of heavy equipment*

*typically used in these types of operations, and (2) producing a 4D model with a sufficient LOD to accommodate daily work plans.*

The purpose of this study is to categorize and prioritize factors contributing to non-physical wastes using empirical data obtained from a questionnaire survey. The survey results identified "planning" as an important factor in promoting non-physical wastes in elevated urban highway projects. A hybrid Multi-Criteria Decision Making (MCDM) approach was proposed to formalize selecting project planning/scheduling methods applicable to elevated urban highway projects where micro-scheduling short duration activities involving heavy construction equipment is critical to project success. Equipment workspace planning was considered a vital aspect in the planning process as conventional planning methods fail to consider spatial planning for short duration activities, especially in highway projects. To facilitate the equipment workspace planning, a research initiative that involved developing a detailed 4D model by integrating the Last Planner System (LPS), a LC planning and scheduling technique in a 4D model with multiple LOD's was proposed. The development of this 4D model can help facilitate the reduction of non-physical wastes during the construction phase of elevated urban highways, improve the reliability of the planning process, and reduce the time waste associated with planning and scheduling urban highway projects subject to space constraints. The research method is described, and a case study is developed to demonstrate the proposed method's feasibility.

*Dedicated to the memory of my late parents, Sir Julius Igwe and Dame Mercy Igwe, and late brother, Christopher' Scanner' Ojika, I will forever miss you.*

## **ACKNOWLEDGEMENTS**

My deepest gratitude to God almighty, my help in times past, my provider and my sustainer in times of need. Words would fail me to express my appreciation to my amiable supervisors, Dr. Fuzhan Nasiri and Dr. Amin Hammad, for their overwhelming support, constructive criticism and advice. The legacy of their excellent work will shape my professional career for years to come.

I would also like to thank my committee members, Dr. Osama Moselhi, Dr. Ketra Schmitt, Dr. Ahmad Soliman, for their valuable inputs and precious time. I would also like to acknowledge Erika Jamerson of Kalloc studios Inc. for providing the 4D software and allowing us to contribute to the development of the software, Mr. Patrick Wilson, project manager from Kewitt involved in the construction of the Turcot interchange, for his invaluable assistance in developing the case study.

I acknowledge members of the sustainable energy and infrastructure systems engineering lab. and lab. of smart infrastructure systems for their criticism and support and the gift of the friendship we have shared over the last couple of years.

My acknowledgement goes to my lovely parents Chief (Sir) Julius Igwe and Lolo (Dame) Mercy Igwe, both of blessed memory, for the gift of life, my siblings: Ann, Joy, Yunis, Oge, Ijay, Marko and every member of the Iloabuchi family for their support and encouragement.

I acknowledge the Niger Delta Development Commission (NDDC) for the postgraduate scholarship that made this dream a reality.

Finally, I thank my lovely wife and Pearl, Ngozi and my children, Audrey, Alexander and Anthony, for the sacrifices they had to make due to my continuous absence. Your love and prayer saw me through.

# TABLE OF CONTENTS

List of Tables .....	vii
List of Figures .....	ix
List of Abbreviations.....	xi
Chapter 1 : Introduction.....	1
1.1. Problem Statement.....	4
1.2. Research Scope .....	6
1.3. Aim & Objectives .....	6
1.4. Significance and Motivation of Research .....	7
1.6. Structure of Research Proposal.....	8
1.7. Chapter Summary .....	10
Chapter 2 : Literature Review.....	11
2.1. Concept and Application of Lean Thinking.....	11
2.2. Lean Construction .....	12
2.2.1. Principles of Lean Construction.....	13
2.2.2. Criteria for Lean Construction.....	16
2.3. Concept of Waste in Lean Construction .....	17
2.3.1. Lean Construction Wastes .....	18
2.4. Lean Construction Tools and Techniques .....	20
2.4.1. Last Planner System (LPS).....	21
2.4.2. Increased Visualization .....	26
2.4.3. Construction Process Simulation Modelling.....	27
2.5. Lean Intervention in Highway Projects.....	32

2.5.1. Lean Project Delivery System .....	33
2.5.2. Virtual Design and Construction (VDC) .....	35
2.5.3. Building Information Modeling (BIM).....	36
2.5.4. 4D Modeling.....	38
2.6. Barriers to Implementation of Lean Construction .....	41
2.6.1. Challenges to Implementing Lean-BIM in Highway Projects.....	43
2.7. Construction Workspace Management .....	46
2.7.1. Classification of Workspaces in Construction .....	49
2.7.2. Workspace Generation and Allocation .....	52
2.7.3. Workspace Congestion Analysis .....	56
2.7.4. Resolution of workspace conflicts .....	58
2.7.5. Advanced Workspace Visualization Tools .....	60
2.8. Construction Planning.....	63
2.8.1. Multi-Criteria Decision-Making Methods (MCDM).....	64
2.9. Micro-Level Space Planning .....	69
2.9.1. Equipment Space Planning .....	70
2.9.2. Level of Development (LOD) Approach for Equipment Space Planning .....	72
2.10. Summary .....	76
Chapter 3 : Overview of Proposed Research Method.....	78
3.1. Categorization and Prioritization of LC Wastes .....	79
3.2. Process-Based Approach for Equipment Space Planning .....	80
3.3. Summary .....	82
Chapter 4 : Ranking and Categorization of Lean construction Wastes .....	83



4.2. Ranking the LC Wastes Based on the TFV.....	84
4.2.1. Data Collection and Analysis.....	85
4.3. Categorizing and Ranking Factors Promoting LC Wastes .....	92
4.3.1. Data Collection and Analysis.....	93
4.4. Discussion .....	99
4.5. Summary .....	100
Chapter 5 : Framework for Equipment Workspace Management Using The Last Planner And 4D BIM For Elevated Highway Projects .....	102
5.1. Approach for Equipment Space Planning .....	102
5.1.1. A1- Product Breakdown Structure .....	104
5.1.2. A2- Develop Detailed Phase Plan .....	105
5.1.3. A3- Plan Activity Workspace Using Lookahead Plan.....	106
5.1.4. A-4 Equipment Workspace Management .....	109
5.2. Conceptual Framework for Equipment Workspace Planning .....	113
5.2.1. Case Study .....	118
5.3. Summary .....	128
Chapter 6 : Conclusions and Future Work.....	130
6.1. Summary of the Research Work.....	130
6.2. Research Contributions .....	132
6.3. Limitations and Recommendations for Future Works.....	134
6.5. Recommendations for Future Works .....	135
References .....	137
Appendix i: Publications .....	185

---

**LIST OF TABLES**

Table 2.1: Integrated TFV view of construction as production .....	17
Table 2.2: LC wastes .....	19
Table 2.3: Ease of implementation of Lean techniques in highway projects .....	21
Table 2.4: Quality criteria for evaluating tasks for commitment.....	25
Table 2.5: Basic modelling elements.....	30
Table 2.6: Comparison of simulation approaches.....	31
Table 2.7: Barriers to the implementation of LC .....	42
Table 2.8: Workspace classification studies .....	50
Table 2.9: Proposed workspace definitions .....	51
Table 2.10: Workspace congestion equations from previous research.....	57
Table 2.11: Related studies on workspace conflict and resolution.....	59
Table 2.12: Related studies on advanced visualization for construction workspaces.....	61
Table 2.13: Recent literature on workspace management in construction projects.....	62
Table 2.14: Table of relative scores .....	67
Table 2.15: Random Index (RI) .....	67
Table 2.16: CBA definitions.....	68
Table 4.1: Respondents profile and distribution.....	86
Table 4.2: Cronbach internal consistency benchmark .....	86
Table 4.3: RII of LC waste based on the ‘Transformation’ aspect of construction .....	88
Table 4.4: RII of LC waste based on the ‘Flow’ aspect of construction.....	88
Table 4.5: RII of LC waste based on the ‘Value’ aspect of construction .....	88
Table 4.6: p-value results of ANOVA test.....	91
Table 4.7: Judgement matrix for one respondent .....	94
Table 4.8: Summary of results .....	94

Table 4.9: CBA implementation.....98

Table 5.1: Parameters for describing lookahead planning ..... 108

Table 5.2: Quality criteria for evaluating tasks for commitment planning ..... 116

Table 5.3: Different types of constraints and purpose..... 121

Table 5.4: Clash analysis output 1 ..... 125

Table 5.5: Information to build ACD based DES model ..... 126

Table 5.6:Clash analysis output 2 ..... 127

**LIST OF FIGURES**

Figure 1.1: Global productivity growth Source ..... 2

Figure 1.2: Thesis structure..... 9

Figure 2.1: Evolution of LC.....12

Figure 2.2: Components of the Last Planner System .....25

Figure 2.3: Other components of the LPS .....26

Figure 2.4: Lean project delivery system.....34

Figure 2.5: How Lean-BIM generates value. ....37

Figure 2.6: Applications of the 4D Model.....41

Figure 2.7: IFC Alignment .....45

Figure 2.8: Overview of infrastructure modules .....45

Figure 2.9: Key Challenges to implementing Lean-BIM.....46

Figure 2.10: Construction workspace classification .....49

Figure 2.11: Proposed workspace classification.....51

Figure 2.12: Working ranges and lifting capacities of a 120T crawler crane .....71

Figure 2.13: LOD approach for equipment workspace planning .....76

Figure 3.1: Overview of research methodology .....79

Figure 3.2: Representation of IDEF0.....81

Figure 3.3: IDEF0 context diagram for equipment workspace planning .....81

Figure 4.1: Sub-Research Method .....84

Figure 4.2: TFV based visualization of LC wastes based on the RII .....89

Figure 4.3: MCDM Hierarchy.....92

Figure 4.4: Identified factors for comparing alternatives .....96

Figure 5.1: IDEF0 process diagram for equipment workspace planning .....103

Figure 5.2: Bridge model showing bridge terminology .....104

Figure 5.3: PBS of a bridge .....	105
Figure 5.4: PBS linked to WBS for bridge construction.....	106
Figure 5.5: Lookahead planning process.....	107
Figure 5.6: Workspace requirements identification.....	110
Figure 5.7: Rule-based heuristics for conflict resolution .....	112
Figure 5.8: Framework for integrating the LPS and detailed 4D model for equipment space planning .....	115
Figure 5.9: Case study workflow .....	119
Figure 5.10: Infracore bridge model .....	119
Figure 5.11: Autodesk classification manager for Revit.....	120
Figure 5.12: Snapshot of Bridge model in Revit .....	120
Figure 5.13: Construction work zone .....	121
Figure 5.14: Lookahead schedule filter .....	121
Figure 5.15: 4D-LOD D: Operational fieldwork .....	123
Figure 5.16: Equipment selection .....	123
Figure 5.17: Equipment workspace representation .....	124
Figure 5.18: Graphical view of identified conflict.....	125
Figure 5.19: Equipment conflict warning .....	126
Figure 5.20: Stroboscope model for precast deck installation.....	127
Figure 5.21: Snapshots of equipment simulation.....	128

## LIST OF ABBREVIATIONS

3D	3-Dimension
4D	4-Dimension
ABC	Accelerated Bridge Construction
ABS	Agent-Based Simulation
ACD	Activity Cycle Diagrams
AE	Approximation Envelop
AEC	Architecture, Engineering, Construction
AHP	Analytical Hierarchy Process
BB	Bounding Box
BIM	Building Information Modelling
CAD	Computer-Aided Design
CBA	Choosing By Advantage
CCM	Critical Chain Method
CDW	Construction and Demolition Waste
CI	Continuous Improvement
CIFE	Centre For Integrated Facility Engineering
CMAR	Construction Manager at Risk
CPM	Critical Path Method
CR	Consistency Ratio
CSA	Critical Space Analysis
CSF	Critical Success Factor
DB	Design-Build
DBB	Design-Bid-Build
DES	Discrete Event Simulation

DSR	Design Science Research
FWWP	Feasible Weekly Work Plan
GDP	Gross Domestic Product
ICT	Information and Communication Technology
IDEF0	Integration Definition for Process Modelling
IFC	Industry Foundation Classes
ILPD	Integrated Lean Project Delivery
IPD	Integrated Project Delivery
JIT	Just-In-Time
KPI	Key Performance Indicator
LC	Lean Construction
LOA	Level of Accuracy
LOC	Level of Coordination
LoD	Level of Detail
LOD	Level of Development
LOI	Level of Information
LPDS	Lean Project Delivery System
LPS	Last Planner System
MCDM	Multi-Criteria Decision Making
PBES	Prefabricated Bridge Elements and Systems
PBS	Product Breakdown Structure
PDM	Precedence Diagram Method
PDS	Project Delivery System
POP	Product-Organization-Process
PPC	Percentage Plan Complete
RI	Random Index

SBS	Space Breakdown Structure
SD	System Dynamics
SPMT	Self-Propelled Modular Transporter
STA	State Transport Agencies
STROBOSCOPE	STate and ResOurce-Based Simulation of CONstruction ProcEsses
TFV	Transformation-Flow-Value
TPM	Total Preventive Maintenance
TPS	Toyota Production System
TQM	Total Quality Management
VDC	Virtual Design and Construction
VSM	Value Stream Mapping
WBS	Work Breakdown Structure
WWP	Weekly Work Plan



## CHAPTER 1 : INTRODUCTION

The duration of construction projects is becoming an increasing source of worry and concern to all key players in the construction industry. For quite some time now, there has been an ever-increasing desire to ensure that construction projects are delivered on time and on a budget to ensure value delivery to stakeholders. The construction industry worldwide is a contributor to the Gross Domestic Product (GDP) of nations and a significant employment source due to its labour intensiveness. Statistics Canada (2016) reveals that the construction sector contributed about 6.0% to Canada's gross domestic product and served as the 5<sup>th</sup> largest employer by industry, accounting for approximately 7.3% of jobs among all industries. Canadian Business Journal (2013) also asserts that over the last decade, 6500 projects were supported through infrastructure Canada to build and repair thousands of kilometres of expressways and highways across the country. This investment in construction is essential as the number, type and distribution of the physical structures in a country provide the first indication of development. Considering the importance of the construction sector plays in the social-economic development of a nation, it becomes imperative to seek better ways to optimize her performance to meet the Key Performance Indicators (KPI) of various stakeholders.

Historically, the construction industry's productivity falls short compared to other sectors, such as manufacturing (Figure 1.1). The manufacturing industry has recorded a better performance in productivity, flow and waste minimization by adopting a new production philosophy called "Lean manufacturing" adapted from the Toyota Production System (TPS). The construction industry has, however, failed to match the productivity of its manufacturing counterpart due, among other factors to the prevalence of non-value adding activities (non-physical wastes), prompting a paradigm shift to (i) increase productivity, efficiency, infrastructure value; quality and sustainability (ii) reduce lifecycle costs, lead times and duplications via effective collaboration and communication with stakeholders, by adopting and transferring some lean

manufacturing principles, tools and techniques to construction. Hence, the construction industry is adopting a wide range of techniques (e.g. Accelerated Bridge Construction, Virtual Design and Construction) and tools (e.g. computer simulation, Building Information Modelling) to improve its understanding and control of construction processes to improve productivity and reduce fragmentation. Different construction projects (e.g. residential, industrial, highway) require slightly different approaches to ensure their success.

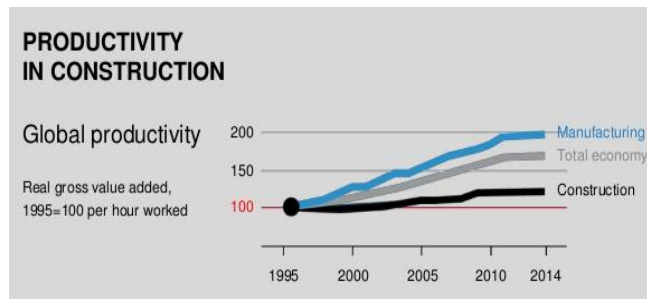

Figure 1.1: Global productivity growth Source: Economist 2017)

Highway infrastructures are critical for any nation's socio-economic development and growth as they provide access to employment, social, health, and educational services. Therefore, the need for new and reconstructed highways is important considerations for many nations of the world. Transportation developments are shifting from the construction of new highways to the deconstruction and reconstruction of existing facilities. Large numbers of reconstruction and rehabilitation works are expected on existing highways either due to existing highway infrastructure nearing or already surpassed their service life or due to the effects of urbanization placing additional demands on existing highways. In some circumstances, road infrastructure investments appear to be the catalyst for economic growth, while in others, economic growth puts pressure on existing transport infrastructures. Current practice in the construction industry suggests that there is typically budget overrun and schedule slippage in highway projects (Dawood and Shah 2007; Hannon 2007). Developing a feasible construction plan is a critical task in managing construction projects as the planning process is the bridge that

links design and construction. Effective planning, which considers the spatial requirements of activities, is recognized as an important factor in a project's success. Su (2013) contended that without a comprehensive and effective plan which considers spatial-temporal relationships between site objects, workspace conflict might frequently occur. Space planning is a distinct area in the construction planning process that is highly problematic due to its dynamic nature. The workspace is an important resource that should be planned and managed effectively to manage the project duration alongside cost, time, labour, equipment and material (Akinci et al. 2002c; a; b; Chavada et al. 2012b; a; Dawood and Mallasi 2006). However, during the planning and scheduling of construction activities, construction space planning is usually not given the same importance as other KPI's. Workspace planning is typically carried out intuitively based on the experience of the planner and the project manager (Akinci et al. 2002a; Heesom and Mahdjoubi 2004; Sadeghpour et al. 2006) but this is not enough to account for the dynamic nature of construction sites. Chau et al. (2004) contended that in practice, the initial site layout drawings are not updated as construction progresses and this lack of a formal representation of the dynamic nature of the workspace is not a true reflection of the relationship between the construction schedule and the workspace, and this typically leads to delays. One of the significant issues in traditional project management tools is that they do not convey workspace occupied as the project progresses and space availability and needs (Mallasi 2009).

Horizontal construction presents some unique challenges not encountered in vertical construction. Typical among them are (1) the consideration for ground topography and existing infrastructure, (2) disruption of human and vehicle movement and the associated user costs, (3) noise and dust pollution, which provides a bigger challenge than experienced in vertical construction, (4) spatio-temporal constraints. These unique challenges place more demand on construction practitioners in ensuring that clients get value for their money, especially in urban highway projects where complex highway interchanges, constantly changing traffic patterns, and workspace constraints place additional challenges on planning and coordinating construction

activities. In response to these demands, research on the use of Information and Communications Technology (ICT) tools in construction has gained ground in recent years, although mainly focused on the horizontal construction domain. The use of tools such as Building Information Modelling (BIM) to improve constructability has expanded to include 4D modelling (Hijazi et al. 2009; Zhang et al. 2016) 5D (4D model linked with cost estimating) (Metkari and Attar 2013; Stewart 2017), 6D (5D model linked with sustainable development). Techniques such as the last planner system (LPS) have been widely and successfully applied in vertical construction but there is a dearth of research regarding its application to horizontal construction.

### **1.1. Problem Statement**

Addressing the challenge of ageing highways can be a difficult and sometimes contentious issue as there are many options and impacts to consider. Some of the major challenges include developing a suitable traffic management plan to reduce the effect of the reconstruction work on motorists, selecting an appropriate construction management approach to facilitate construction flow, reducing work variability, managing spatio-temporal conflicts and understanding the workspace requirements for each activity. The reconstruction of urban highways requires heavy construction equipment and planning the equipment workspace becomes important to reduce or eliminate delays arising from spatio-temporal conflicts. Conventional planning methods (network diagram, critical path method) do not consider space constraints in the planning process and typically focus just on the time and cost aspect (Chau et al. 2004; Dawood and Mallasi 2006; Mallasi 2006; Wang et al. 2004), and therefore do not effectively represent and communicate the workspace interference between construction activities. Technologies such as 4D BIM have been used to improve workspace planning, and the application of 4D BIM in vertical construction is on the rise, but its application in horizontal projects have been limited (Fanning et al. 2014; Shah et al. 2009; Yabuki 2010), and this is partly due to the differences inherent between vertical and horizontal construction. Several studies having different perspectives have been carried out to

describe the different gains of using the 4D BIM in workspace management. However, they have been restricted to certain types of workspaces (material storage areas, path space) but did not consider equipment workspace management. Moon et al. (2014a) also claimed that existing research considered a workspace a physical execution area of a single element rather than an operational task level. Furthermore, none of the previous studies on equipment workspace management considered the effects of a “shared” workspace in the reconstruction of elevated urban highways where the old and new highway structures will share the same workspace. Regardless of the proven gains and potential of 4D BIM, there are still some limitations in current 4D technologies, and one important limitation is the lack of dynamic representation of activity workspace, which crucially includes equipment workspace. Therefore, it becomes important to seek an integrated approach to account for the dynamic and complex features of an activity workspace in 4D simulation to allow for a more comprehensive analysis based on reliability scheduling. Moreover, the requirements for short-duration schedules in large and complex projects in urban areas present a whole new challenge in designing the workspace (Hammad et al. 2007; Said and El-Rayes 2013; Wang et al. 2004). To counter these challenges, a considerable amount of time is required to ensure that the level of detail of the plan is sufficient to account for the following: (1) *micro-scheduling of the heavy equipment typically used in these types of operations*, (2) *phasing of the demolition and reconstruction activities*, (3) *designing the equipment workspace requirement for (1) and (2) above*.

The integration of the LPS and 4D modelling provides an excellent opportunity to enhance the planning process, reduce variability, improve workflow, reduce waste and plan dynamic equipment workspace to prevent spatio-temporal clashes in elevated urban highway projects. This research, therefore, seeks to propose a method of integrating the LPS and 4D modelling for equipment workspace management in elevated urban highway reconstruction projects and helps answer the question of how the interaction of LC technique and 4D BIM can improve schedule reliability and facilitate equipment workspace planning in congested urban areas.

## 1.2. Research Scope

This study focuses on using 4D simulations to elucidate the dynamic representation of activity workspace in elevated urban highway reconstruction projects focusing on equipment workspace requirements and planning. The term “activity workspace” represents the dynamic workspace required for each activity on the construction schedule. Consequently, this work addresses some of the limitations of existing research in equipment space planning and its dynamic representation in a 4D model. In the context of this research, equipment workspace refers to the workspace generation, allocation, conflict detection, resolution and dynamic representation of construction equipment at any time during construction.

## 1.3. Aim & Objectives

This study aims to “***Integrate the last planner system in a detailed 4D model for equipment workspace planning in elevated urban highway construction projects***”. To elucidate the research aim, the following objectives will be achieved:

1. Review the scope of research on lean construction in vertical construction and its extension to horizontal construction and suggest lean construction tools/techniques intended to maximize value and eliminate waste on highway reconstruction projects
2. Investigate and suggest the best use applications of 4D model for highway construction.
3. Rank the LC wastes based on their influence on the transformation, flow and value processes in construction.
4. Categorize and rank the factors that promote LC wastes in urban highway projects based on the TFV model and propose a two-step multi-criteria decision-making method to formalize project scheduling techniques in elevated urban highway projects.
5. Develop a conceptual framework for integrating the LPS and detailed 4D modelling for equipment workspace planning and specify the 4D-LOD and validate the framework using a case study approach.

## 1.4. Significance and Motivation of Research

A critical consideration in seeking better ways to manage construction processes is understanding the problem area requiring intervention. One such area is the dynamic workspace requirements for heavy construction equipment in urban highway reconstruction projects and how to reduce the time it takes to undertake the tasks required to complete such a project. Over the last five years, over 429 billion US dollars have been invested in upgrading and constructing new roads by Canadian and US governments. It is, therefore, essential to ensure value delivery to stakeholders by ensuring timely delivery of projects. However, currently, the delivery of new and reconstructed highways is perceived to take too much time, thus preventing the travelling public from enjoying the benefit of the urgently needed infrastructure. Sillars (2009) claims there is growing frustration from taxpayers over the delivery of highway construction projects. These delays place additional financial burdens (cost of increased travel time, also known as user-costs) on commercial carriers and the travelling public. One specific waste that will be addressed in this research is ‘Time Waste’ and how it can be reduced by using the LPS to improve the reliability of the schedule for equipment utilization and workspace planning in elevated urban highway construction projects. These projects are considered equipment-intensive and planning the equipment workspace becomes necessary to facilitate the project's delivery and avoid spatio-temporal conflicts. This study is significant as it identifies and ranks factors attributable to delays during the construction of urban highways, formalizes a project planning/scheduling technique applicable to these types of projects mainly, and introduces a conceptual framework for equipment workspace planning to prevent spatio-temporal related delays.

Transparency, collaboration and prompt information sharing among project stakeholders are the antidotes to the challenges usually witnessed on construction sites. This becomes more important as the size and complexity of the project increases as obtains in large infrastructure projects such as the Turcot Interchange reconstruction project. The Turcot interchange in the city

of Montreal, Quebec-Canada is a major passenger and freight transportation axis, used by more than 300,000 vehicles per day. The interchange was built in 1967 and has almost reached the end of its useful life after more than 50 years of service. The infrastructures are in poor condition and require an ever-increasing amount of repair work. Reconstructing the highway was deemed the best solution to ensure structural durability, improve highway safety, minimize the impact on the local area and ensure adequate integration of the project with the urban setting. The project will cost approximately \$3.7 billion Canadian dollars and involves the construction of new links on the local road network, demolition and reconstruction of existing elevated highways that have reached the end of their useful life and relocation of some structures. One of the project's highlights is its commitment to waste reduction by ensuring that about 80% of demolished materials will be recycled, which translates to about 300,000m<sup>3</sup> of materials that will be recycled and reused (Ministry of transport 2017).

There are lots of design and construction challenges in highway projects of such magnitude, and some of the challenges identified in the Turcot interchange project, which motivates this research include:

- Carrying out dismantling and construction concurrently
- Managing spatio-temporal clashes
- Managing the schedule

The development of a detailed 4D to address the issues becomes imperative. This will be achieved by integrating the last planner system for improved planning and scheduling while ensuring that the spatio-temporal clashes are eliminated to enhance the workflow.

### **1.6. Structure of Research Proposal**

This thesis contains six chapters. The thesis structure (Figure 1.2: Thesis structure) and a brief explanation of the contents of each chapter are presented below:



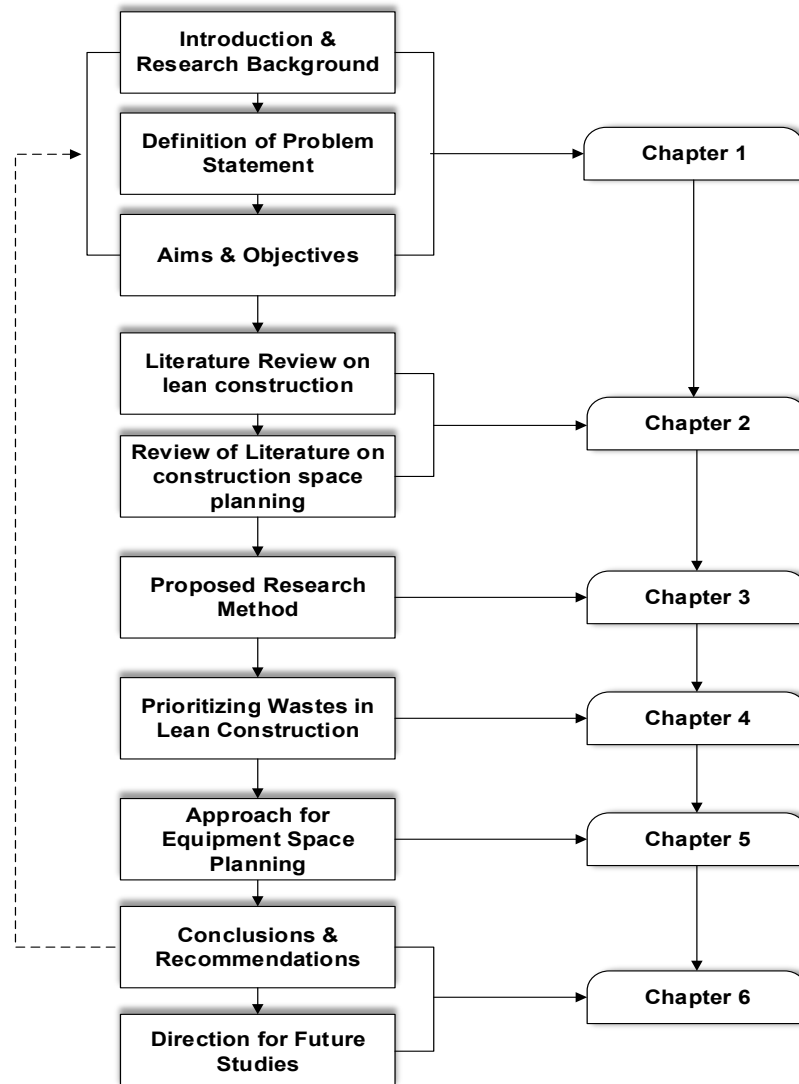

Figure 1.2: Thesis structure

- Chapter 1, **Introduction**, provides general background on the research and the research problem. It also elucidates the problem statement, the aim and objectives of the research and the scope. The significance and motivation behind the research were highlighted.
- Chapter 2 contains the **Literature Review** and is divided into two parts. The first part focuses on lean construction and provides insight into the existing literature on the lean construction principles, tools and techniques and barriers mitigating its implementation in highway projects. The second part will elucidate the importance of construction space planning with an

emphasis on equipment space planning. The importance and role of the 4D model as a tool for waste reduction will also be explored with an emphasis on reducing the “time waste” through workspace planning for elevated highway reconstruction projects.

- Chapter 3 highlights the **Research Method** adapted is explained to justify the chosen methodology. This chapter will also highlight the research model development, steps and assumptions, as well as the advantages and limitations of the proposed model
- In Chapter 4, a **two-step multi-criteria decision-making method was applied to categorize and rank factors promoting LC wastes based on the Transformation-Flow-Value theory**. Planning was identified as an essential factor leading to LC wastes; a formalized method for selecting project planning/scheduling techniques in urban highway projects is presented to mitigate the effects of poor planning.
- Chapter 5 highlights the **research approach for equipment workspace planning**. A conceptual framework is developed to facilitate an understanding of the processes involved in workspace planning using the 4D modelling technique and a case study is developed to implement the developed framework.
- In chapter 6, the **conclusions, recommendations and directions for future works** are highlighted.

### 1.7. Chapter Summary

The problem of productivity and fragmentation has been identified as two challenges limiting the construction sector's performance and requires a paradigm shift for them to be solved. This chapter identified some challenges related to the construction of urban highways such as poor or inadequate planning, especially relating to heavy equipment in urban highway projects. The aim, objectives, significance and research motivation are also presented, providing a foundation and structure for the rest of the thesis.

## CHAPTER 2 : LITERATURE REVIEW

The first part of this chapter focuses on relevant scholarly works in lean construction that impact this research work. A brief overview of LC's history and evolution will be provided and the main principles governing it. Some lean construction tools/techniques will be highlighted, emphasizing the lean tools used in this work. The importance of 4D models in improving the effectiveness of LC will also be highlighted. The second part of the chapter will focus on the literature on construction space planning. The discussion will elucidate how the LPS can be used to improve the micro-scheduling of equipment workspace.

### 2.1. Concept and Application of Lean Thinking

The reduction and eventual elimination of waste is the main idea behind lean thinking. It is based on the philosophy that rejects all kinds of waste and emphasizes value generation (Howell and Ballard 1997a). Fewings (2013) asserted that lean thinking goes beyond seeking to eliminate waste but extends its focus to value delivery to the client throughout all project phases. It provides a means for specifying value, helps differentiate value-adding from non-value adding activities and facilitates the sequential arrangement of value-adding activities (Womack and Jones 2003). The principle of lean thinking is based on three main concepts: (1) Reduction in the share of non-value activities, (2) Reduction in the lead time and variability, and (3) Increased flexibility, transparency and simplicity of operations (Koskela 2000). Understanding these principles and the use of tools and techniques that will facilitate their implementation provides an opportunity for improving the performance of construction projects through the systematic identification and removal of wastes (non-value-adding activities) from the construction process.

Lean thinking evolved from the Toyota Production System (TPS) developed and made famous by Ohno for Toyota (Ohno 1988). The two main goals of the TPS were to create value and reduce waste. These goals formed the foundation of the lean production system adapted and implemented in the manufacturing sector. LC evolved (Figure 2.1) from lean production due to

the need to improve the construction sector's productivity to mirror that of the manufacturing sector. To facilitate the implementation of LC, it was necessary to understand lean manufacturing thinking, principles and applications to facilitate the transfer and implementation of the same within the construction sector.

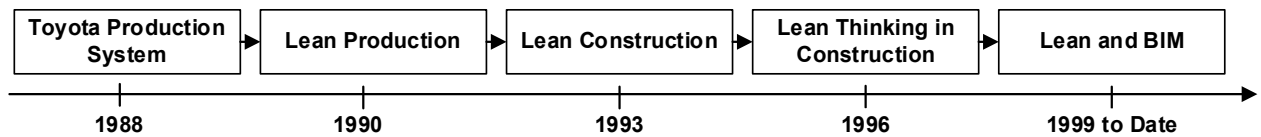

Figure 2.1: Evolution of LC

## 2.2. Lean Construction

LC was first discussed by Koskela, who investigated what was referred to as “the new production philosophy and its application to construction.” He asserted that the attempt to improve the construction of buildings and other structures would continue to fall short of the desired results due to the absence of a general theory of production (Koskela 1992). According to Koskela, three fundamental elements (transformation, flow and value) need to be added to a production theory for the gains of the lean production system in manufacturing to have any meaning for construction (Koskela 2000).

LC has continued to evolve over the years and represents a way to design production systems to discourage, minimize and eventually eliminate waste of materials, time and effort to facilitate the generation value (Koskela et al. 2002a). Green and May (2005) claimed that LC could be regarded as a set of techniques, a social-technical paradigm or a cultural commodity that can be directly applied to construction. LC refers to the application and adaptation of the concepts and principles of the TPS to construction (Sacks et al. 2010a; b) and emphasizes the reduction of non-value activities, otherwise referred to as waste, as a means of value improvement. LC is a system that promotes flow and value generation (Aziz and Hafez 2013). Emmitt (2014) revealed that LC is a production system designed to reduce the waste of materials,

time, and effort to create maximum value for the client. He also revealed that LC has far-reaching interpretations that range from definitions, including design and construction activities, to very limited interpretations related to precise functions and applications. Regardless of the different definitions of LC, reduction/elimination of waste and focus on value as defined by the client are two recurring themes. A report by the construction task force set up by the United Kingdom (UK) Deputy Prime Minister in 1998, popularly known as the “Egan report,” adapted the essence of lean thinking and set the tone for the implementation of LC in the UK (Egan 1998) and its subsequent proliferation to other countries. Winch (2012), however, warns that the extent to which the trade-off nature of the construction process can be changed is an important consideration regarding the application of the lean construction approach.

Over the years, numerous studies have been carried out on LC, with different authors putting forth arguments regarding the perceived benefits of implementing lean on construction projects. Some of the benefits that can be gained from implementing lean include improvement in planning reliability (Ballard 1999, 2001; Cho and Ballard 2011; Hammond et al. 2000; Liu and Ballard 2008, 2009), project delivery times (Diekmann et al. 2003), cost (Salem et al. 2006), productivity (Agbulos et al. 2006; Kung et al. 2008), job satisfaction (Nahmens et al. 2012) among others. However, regardless of the perceived benefits of implementing LC, there have been some criticisms of its lack of focus on “people-related” themes. LC should be built on the social-technical system having a balanced view of hard (process-related) and soft (people related) elements (Emiliani and Stec 2005; Liker 2004; Shah and Ward 2007; Sui Pheng et al. 2011) like the TPS that focuses on “respect for people” as one of its foundational pillars. LC's emphasis has been on the “hard” elements due to its “process-focused” approach.

### **2.2.1. Principles of Lean Construction**

Five basic principles provide the foundations for implementing LC. These are value, value stream, flow, pull and continuous improvement.

### 2.2.1.1. *Value*

“Value” is the starting point for lean thinking in construction. Value can only be defined by the client and is best expressed in precise terms to meet their requirements at a specific price and time (Womack and Jones 2003). According to Hines et al. (2004), value is enhanced by reducing internal waste present in a system. However, value creation is often mistaken for cost reduction. Value can, however, be hard to establish (Liker 2004) as any activity that does not add value is regarded as waste. Jørgensen and Emmitt (2008) revealed that construction processes consist of value-adding activities, essential but non-value-adding activities and non-value-adding activities. Non-value-adding activities (pure waste) are activities that the client would not pay for, essential but non-value-adding activities that are part of the project requirements that must be performed for regulatory/compliance reasons. In contrast, value-adding activities are usually transformational activities that the client pays for.

### 2.2.1.2. *Value stream*

A value stream is an analysis of activities undertaken during the construction process. It is a two-step process that involves analyzing the current and future states of tasks that make up an activity using the current and future state maps. It aims to identify activities that create value (value-adding), activities that do not create value but are necessary for value creation (non-value but essential) and those that create no value and can be avoided with proper planning (non-value-adding). The visualization of the value stream is achieved through a technique known as Value Stream Mapping (VSM). Womack (2006) contended that VSM helps identify and visualize the challenges and benefits associated with the current system of working using the current state map to improve them using the future state map. Visualizing the value stream facilitates identifying and eliminating waste within a construction process (Kivistö et al. 2013).

### 2.2.1.3. *Flow*

This principle is based on the unhindered movement of activities within a work package by removing the bottlenecks that would otherwise have hindered it. Bicheno (2008) argued that this principle is centred on designing a process to ensure the most efficient and effective way of achieving identified value is applied. The flow principle is important as any disruption in the workflow causes a ripple effect on the project and could increase its cost and duration.

### 2.2.1.4. *Pull*

The pull principle is a change from the traditional construction practice of using the master or phase schedule to determine activities' sequencing. In the pull system, work is "pulled" by production capacity or the next activity's readiness in the construction process. Liker (2004) claimed that the pull principle's main aim is to reduce/eliminate inventory while enhancing the organization's capability to respond to changes in client demands. The pull system requires the quick flow of information to avoid accumulated demand deviations (Shahabuddin 2012) and is achieved using the LPS. An important consideration in adopting the pull technique is to break down work into small packages to facilitate flexibility in responding to changes (Hopp and Spearman 1996).

### 2.2.1.5. *Continuous improvement (CI)*

CI is geared towards perfection by the practising organization by using feedback loops to improve and enhance a process. The continuous quest for perfection is intrinsically linked to an organization's goal to meet client expectations (Matzler et al. 1996). The gains of endorsing continuous improvement are to avoid large, risky process re-engineering by developing a process incrementally to facilitate small continuous changes (Slack et al. 2010). The involvement of management and employees is mandatory for achieving CI, and it is only feasible where the organizational structure supports CI initiatives and reward improvement ideas.

### 2.2.2. Criteria for Lean Construction

Koskela proposed a means for adapting lean production concepts into construction and suggested three ways through which this can be attempted, namely: (1) **T**ransformation; (2) **F**low; and (3) **V**alue generation (TFV) theory of production (Koskela 1992). This three-way view of production subsumes the transformation dominated construction management (Bertelsen and Koskela 2003; Koskela et al. 2002b) and is one of the primary criteria for implementing lean construction. The TFV represents the relationship between the three main concepts in managing a construction project and how they contribute to its success. Three essential features are involved in construction. The first characteristics involve the transformation of input into output. This input may be in the form of labour, equipment and materials. The second characteristic is “flow” and concerns activities along the value chain such as transportation, storage, waiting and inspection. The third feature involves meeting the client's expectations by ensuring the final product conforms to the client's requirements. These three features are encapsulated in the TFV model, which regards construction as a transformation process. The TFV supports the insight that three fundamental aspects of construction should be managed simultaneously.

Koskela (2000) claimed that three principles are important to the TFV model: (i) the division of construction into smaller and manageable sub-processes and these sub-processes further divided into tasks which should then be assigned appropriately, (ii) reduction in the cost associated with each sub-process, and, (iii) linking the output value of a process to its input value. Although each concept of production has its methods and practices, they can be integrated for simplicity. The purpose of this integration is to how the principles of lean production can be applied to construction. Table 2.1 provides an overview of the TFV (adapted from Koskela et al. 2002a).



Table 2.1: Integrated TFV view of construction as production (adapted from Koskela et al. 2002a)

Description	Transformation view	Flow view	Value generation view
Conceptualization of construction as production	Direct transformation of construction inputs into outputs	The flow of materials composed of procurement, inspection, moving, waiting and transformation	Creating value for the client by fulfilling his stated requirements
Main principles	Ensures that the construction process is more efficient	Elimination and reduction of all non-value adding activities (waste)	Ensures the best functional worth alternative is selected to reduce/eliminate value loss
Procedures	Work breakdown structure, materials requirement planning, organizational responsibility chart	Last planner system to facilitate pull production and continuous flow of work	Value stream mapping, quality function deployment
Contribution to the construction process	Ensure that what has to be done is done	Ensures that what is unnecessary is done as little as possible	Ensures client requirements are met in the best possible manner with the least possible cost for the stated quality requirement

The TFV approach considers the *flow* of information, workers, material, equipment and every other resource needed to facilitate a construction process (Sacks et al. 2009).

### 2.3. Concept of Waste in Lean Construction

Waste is anything that makes use of resources without creating value (Womack and Jones 2003, 1997). However, it is challenging to measure waste when measured in terms of the efficiency of the processes, equipment or personnel (Alarcon 1997). Traditional studies on construction wastes have focused on material wastes without consideration for the entire construction process. Most studies on construction waste are based on the conversion model, where material wastes define waste (Formoso et al. 1999). Viana et al. (2012) revealed that material loss, often resulting from the environmental impact of construction and demolition material waste, focused on several studies. However, the conceptualization of waste is rarely discussed in these studies. They further claimed that the construction management community's effort in understanding non-physical wastes is relatively small, as many studies focused on the consequences and not the root causes that should be avoided. A broader conceptualization of non-physical wastes based on the

identification and separation of avoidable and unavoidable non-value-adding activities is required (Lapinski et al. 2006; Mao and Zhang 2008).

### **2.3.1. Lean Construction Wastes**

In the LC paradigm, the waste is directly associated with using resources that do not add value to the final product. This implies that improving value-adding and non-value-adding work and eliminating waste by removing non-value-adding activities are two ways of improving construction processes. Improving construction flows provides a means of reducing non-value adding activities. The interpretation of flow in construction captured by the TFV theory of production views the construction process as a flow composed of value-adding activities (represented by “transformation”) and non-value adding activities. In general, the lean approach aims to create the highest value for the customer by reducing the share of non-value adding activities (also known as wastes). The concept of non-value adding activities regarded as non-physical waste was first suggested by Ford and Crowther (Ford and Crowther 1988), which formed the basis for the TPS (Liker 2004). The first categorization of non-physical wastes was provided by Ohno (Ohno 1988). These wastes (Table 2.2 adapted from Ohno 1988) provide the starting point for the discussion on LC wastes.

According to Koskela et al. (2013), Ohno’s list has been widely used and diffused into the construction industry. Other categories of wastes have been identified and cited in literature such as additional capital investment (Monden 2011), unutilized talent (Liker 2004), working under suboptimal conditions (Koskela 2000), design of products that do not meet the needs of customers (Womack and Jones 2003), “making-do” (Koskela 2004) and unnecessary capital investment (Monden 2011).

Table 2.2: LC wastes

	Type	Examples
D	Defects	<ul style="list-style-type: none"> <li>• Incorrect information on drawings</li> <li>• Rework</li> <li>• Inspections to reduce/remove defects,</li> <li>• Production of defective work, not meeting specifications</li> </ul>
O	Over-production	<ul style="list-style-type: none"> <li>• Producing items earlier than needed or beyond specification</li> <li>• Producing more than is required</li> <li>• Generating waste through over-staffing</li> </ul>
W	Waiting	<ul style="list-style-type: none"> <li>• Equipment downtime</li> <li>• Documents awaiting approval, updating or processing</li> <li>• Workers unable to do value-creating work</li> <li>• Waiting time between processes or for the capacity to take the next step</li> </ul>
N	Non-utilized talent	<ul style="list-style-type: none"> <li>• People working one or two levels below their true capability</li> <li>• Lack of knowledge learned from one project transferred to another</li> <li>• Losing time and ideas, skills improvement and learning opportunities</li> </ul>
T	Transportation	<ul style="list-style-type: none"> <li>• Moving work in progress from one place to another</li> <li>• Moving temporary site facilities from one location to another</li> <li>• Delivering equipment, incomplete orders</li> <li>• Moving material to and from storage</li> </ul>
I	Inventory	<ul style="list-style-type: none"> <li>• Excess raw material, WIP or finished goods causing longer lead times, damaged goods, transportation/storage costs and delays</li> <li>• Too much material compromising the workspace</li> <li>• Large site storage of materials</li> </ul>
M	Motion	<ul style="list-style-type: none"> <li>• Unnecessary movement of people and equipment that does not add value</li> <li>• Walking between workplace and welfare facilities, manual paperwork processing</li> <li>• Unnecessary movement of personnel and equipment at the site</li> </ul>
E	Extra-processing	<ul style="list-style-type: none"> <li>• Taking unnecessary steps</li> <li>• Providing higher quality products than necessary and produced to standards beyond specifications</li> <li>• Inefficient processing, primarily due to poor design or work planning</li> </ul>
M	Making-Do	<ul style="list-style-type: none"> <li>• Starting a task without all its standard inputs</li> <li>• Execution of a task is continued, although the availability of at least one standard input has ceased.</li> </ul>

Formoso et al. (1999) claimed that a significant portion of construction waste could be attributed to problems that happened pre-construction, e.g. poor design, inadequate planning, and supplier selection. The identification of waste is, therefore, fundamental to the success of LC. The main idea behind lean thinking in construction is to facilitate the removal of waste and enhance value. However, the fragmented nature of the construction sector lends itself to encouraging waste. A typical construction process has different subprocesses involving different stakeholders, and coordinating their activities becomes more difficult as the size and complexity

of the project increase, thereby leading to more non-value-added activities due to poor coordination of project information, which impacts flows.

Alarcon (1997) attempted the first classification of factors deemed responsible for promoting non-physical wastes based on the TFV theory. Subsequently, other attempts have been made to ascertain the causative factors promoting non-physical wastes (Alwi et al. 2002a; Formoso et al. 1999; Josephson and Saukkoriipi 2007; Kaliannan et al. 2018; Khaleel and Al-Zubaidy 2018; Nagapan et al. 2012; Vilasini et al. 2011). However, these studies failed to provide a relationship between the identified factors and the LC wastes they promote. The reduction of non-physical wastes can be facilitated by applying LC tools and techniques discussed in the next section.

#### **2.4. Lean Construction Tools and Techniques**

LC techniques describe non-traditional project delivery approaches to manage and improve the collaborative relationships that typically exist in the project environment (Wodalski et al. 2011). Some application of these techniques includes the application of VSM in construction supply chain management (Arbulu and Tommelein 2002), workflow analysis in precast concrete fabrication (Ballard et al. 2003), work scheduling and management using LC (Huber and Reiser 2003; Kenley 2004; Tommelein 1999), huddle meeting, first-run studies (Deshpande et al. 2011; Salem et al. 2004, 2006), lookahead planning and simulation (Ben-Alon and Sacks 2017; Dave et al. 2016; Hamzeh et al. 2016, 2012b, 2015; Samudio et al. 2011). However, there is a dearth of research on the implementation of these tools on highway projects. Wodalski et al. (2011) provided recommendations on the applicability of lean tools and techniques used in vertical construction (Table 2.2) based on highway projects' perceived ease of implementation. They ranked these techniques as "straightforward", "moderate" or "difficult" based on their "ease of implementation" with respect to the agreement between a potential lean technique and the current practice in the highway project delivery process.

Table 2.3: Ease of implementation of Lean techniques in highway projects (adapted from Wodalski 2011)

Lean Techniques in Vertical Construction	Ease of Implementation in Horizontal Construction
5-S (organizing workflow)	Straightforward
Collaborative planning	Straightforward
Customer focus	Straightforward
Daily huddle meeting (pre-task planning)	Straightforward
Standard work	Straightforward
Takt time	Straightforward
Value stream mapping	Straightforward
Continuous flow (one-piece flow)	Moderate
Workflow levelling	Moderate
<b>Last planner system*</b>	Moderate
Just-In-Time delivery	Moderate
<b>Increased visualization*</b>	Moderate
<b>Simulation and modelling*</b>	Moderate
Batch size-reduction	Moderate
Supply chain management	Moderate
First, run studies	Difficult
Integrated form of agreement	Difficult
Target Costing	Difficult

\* Discussed below in further details

### 2.4.1. Last Planner System (LPS)

Construction projects are complex, burdened by many uncertainties, and subjected to changes in planning. According to Nahmias and Cheng (2005), the more a forecast looks into the future, the less accurate it is likely to be. A study revealed that only 36%-65% of planned activities are completed as scheduled (Ballard 1999; Howell and Ballard 1997b), leading to the need for developing an improved planning and scheduling technique. The LPS was developed by Ballard (2000) based on lean principles and sought to improve the quality and reliability of the scheduling process (Liu and Ballard 2008). The term 'last planner' comes from identifying the person responsible for executing any task and committing to the task start date (Wodalski et al. 2011). It is mainly synonymous with LC and appears to be the most popular and implemented LC technique (Green and May 2005; Jørgensen 2005). Over the years, it has been refined through theoretical studies, individual and field experiences of various researchers (Jørgensen 2006). The LPS is built on the assumption that reactive work planning is executed on the lowest possible level (by

the person whose planning releases work directly for execution by the workforce at the operational level) in the hierarchy of planners to increase the reliability of the planning process and address the waste associated with planning uncertainty and deviation (Jørgensen 2006).

The LPS is a pull-based production planning and control method to reduce uncertainty in construction workflow (Ballard and Howell 2003; Pellicer et al. 2015) by determining what *should* be done, what *can* be done and what *will* be done. It is designed to produce a more reliable project plan (Heigermoser et al., 2019). The integrated approach used in the LPS supports plan reliability and leads to a reduction in task variations at the project implementation stage (O. AlSehaimi et al. 2014; Russell et al. 2014). It reduces variations in planned tasks, improves project performance and supports the achievement of higher productivity when compared with similar projects not managed by the LPS method (Fernandez-Solis et al. 2013; Nieto-Morote and Ruz-Vila 2011; Wambeke et al. 2012)

Ballard and Tommelein (2016) asserted that the LPS comprises two different stages: the long term planning stage, which comprises the master schedule (milestone plan) and the phase plan, and the short-term planning stage comprising of the lookahead plan and the commitment plan.

### *2.4.1.1. Master Schedule*

The LPS starts with developing the master schedule. The master schedule is a front-end planning process that produces a schedule describing work to be carried out over the entire project duration. It involves project-level activities and identifies major milestone dates (Hamzeh et al. 2012a). It is usually established using historical data or average productivity rates to determine the project's likely duration and create the phase schedule.

### *2.4.1.2. Phase Plan*

The phase plan is obtained from the master schedule and breaks down the master schedule into manageable work packages, the parties responsible for actualizing them and their interactions. It

works backwards from the milestone dates and highlights tasks that should be done based on the available capacity and commitment to complete the work collaboratively by the parties involved. This is particularly important because schedule planning for a project cannot be performed in much detail before the events being planned (Bhatla and Leite 2012). Phase scheduling produces efficient scheduling and planning (Seppanen et al. 2010) further refined using lookahead planning.

### *2.4.1.3. Lookahead Plan*

The Lookahead plan is the third step in the LPS process and is the backbone of the LPS (Lindhard and Wandahl 2014) as it forms a link between the master plan and the Weekly Work Plan (WWP). It is used to decompose the phase schedule into the level of operations, designing operations, identifying constraints, assigning responsibilities and then making tasks ready by removing constraints (Ballard 1997, 2000; Hamzeh 2009; Hamzeh et al. 2009; Seppanen et al. 2010). Lookahead planning improves the scheduling process's reliability by ensuring that only tasks ready for execution are included in the WWP to ensure workflow is maintained. In LPS terms, this is called the making-ready process (Jang and Kim 2008). The planning horizon for the lookahead plan depends on the project's size and complexity but usually between 4 to 6 weeks. Tasks for inclusion in the lookahead plan must satisfy some preconditions, e.g. availability of correct plans, drafts and specifications, availability of materials, resource availability including workers, equipment and activity workspace (Koskela 1999) to ensure their soundness. Activities become sound by analyzing all preconditions for each activity scheduled for construction in a time frame of up to 6 weeks into the future (Lindhard and Wandahl 2013). Each week, the lookahead window slides one week forward. An activity with all preconditions fulfilled is moved to a buffer containing a workable backlog of activities that are ready for execution. The WWP comprises activities from this workable backlog to ensure that only sound tasks are included (Hamzeh et al. 2008).

### 2.4.1.4. Commitment Plan

The foundation of the LPS is based on collaboration and reliability planning. Reliability planning is based on commitment planning by the last planners. The commitment plan, also commonly referred to as WWP, is the last stage of the LPS process. It is a highly detailed plan that drives and controls the entire construction process. All the tasks making up the WWP are measurable and presented at a high level of detail to make them easy to accomplish. Heigermoser *et al.* (2019) revealed that the commitment plan specifies the individual work steps that will be done. The percent plan complete (PPC) is used at the end of each weekly plan to measure the percentage of completed work compared to the planned work (Hamzeh et al. 2012a). Ballard (2000) asserted that for any task to be included in the WWP, some criteria must be fulfilled (Table 2.4 adapted from Ballard 2000). The main components of the LPS (adapted from Mossman 2011) are shown in Figure 2.2.

The LPS facilitates collaboration and communication (Ballard and Tommelein 2016) and reduces the fragmentation within the construction industry. Priven and Sacks (2016) revealed that the nature of conversations within the LPS process supports social network development among stakeholders in the construction process. The LPS requires collaboration, and without this, it cannot succeed. However, regardless of the perceived gains of implementing the LPS, recent studies reveal that the application of the LPS principles on projects is fragmented, and the more complex and crucial elements of the LPS are not currently been implemented in practice (Daniel 2017; Dave et al. 2015; Kalsaas 2012; Khanh and Kim 2016; Koch et al. 2015). The complex elements of the LPS include lookahead planning, make-ready planning and root cause analysis (Alarcón et al. 2011; Daniel 2017). The very nature of construction makes the implementation of the LPS challenging to achieve. Some challenges facing the implementation of the LPS includes the use of incompatible procurement strategies, low supply chain integration, cultural and structural issues within the organization (Johansen and Porter 2003), lack of understanding of lean principles, and wrongly perceiving LPS as only a micro-planning-system (Alarcon and Seguel



2002; Salem et al. 2005), late implementation and weak commitment to LPS implementation (AlSehaimi et al. 2009), organizational resistance to change (Fernandez-Solis et al. 2013), the absence of standardized training material on LPS implementation, lack of integration of information modelling systems such as BIM (Dave et al. 2015), among others.

Table 2.4: Quality criteria for evaluating tasks for commitment (adapted from Ballard 2000)

Quality criterion	Question to answer
Definition	Is the task defined so that workers understand what, when, where and with what?
Soundness	Have all constraints been removed that can be removed prior to the plan period?
Sequence	Is the task adequately sequenced?
Integrity	Has the plan sequence been simulated using 4D to detect and resolve clashes?
Size	Does workload, the amount of work to be accomplished, match the capability of those who are to perform the task?

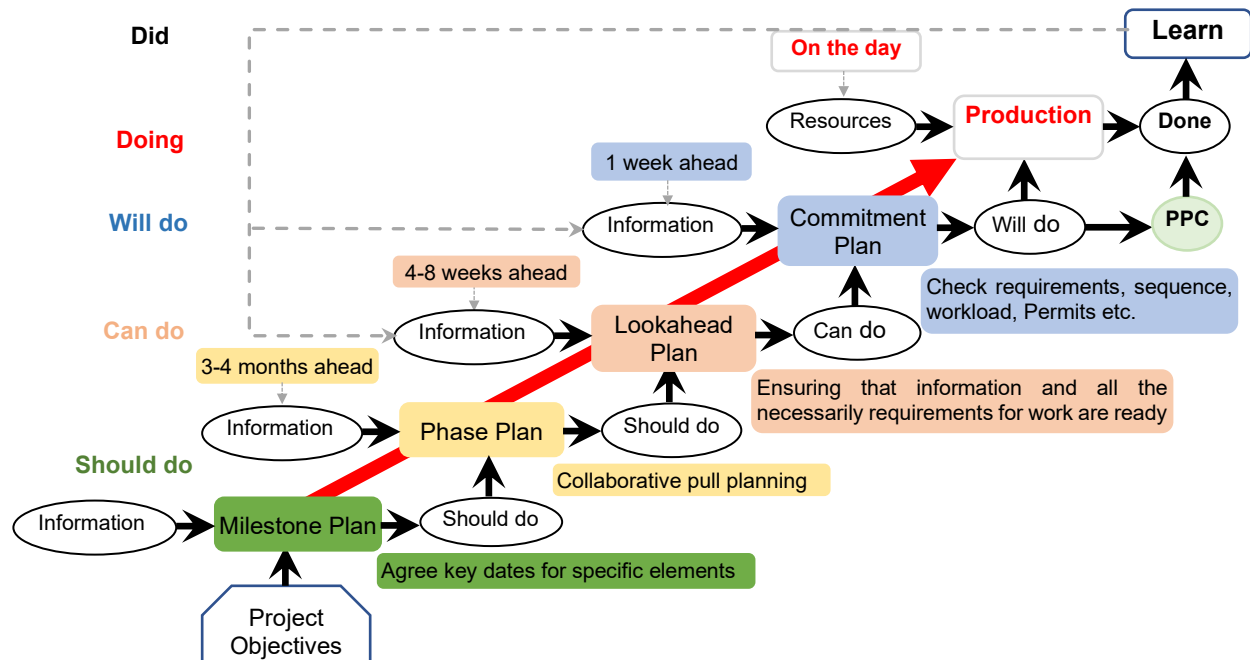

Figure 2.2: Components of the Last Planner System (adapted from Mossman 2011)

Regardless of the challenges and criticisms regarding the LPS, it is still widely being utilized with reported gains. Several studies have investigated the implementation of the LPS on construction projects. Results show that implementing the LPS can help shield production units from workflow uncertainty (Ballard and Howell 1998), improve the reliability of planning (Gonzalez et al. 2007), reduce workflow variation by reducing the difference between tasks that are predicted

to be executed and those actually executed (Jang and Kim 2007), enhance productivity (Liu et al. 2010), strengthen the social network among the project participants including frontline supervisors and direct workers (Fauchier and Alves 2013), creates productivity improvement, workflow, reduces project delivery time (Fernandez-Solis et al. 2013), leads to process improvements (Castillo et al. 2015), and improves stakeholder satisfaction (Daniel et al. 2019). According to Daniel et al. (2016), the LPS involves other components (Figure 2.3), which increases its efficiency and forms an integral part of its application and success.

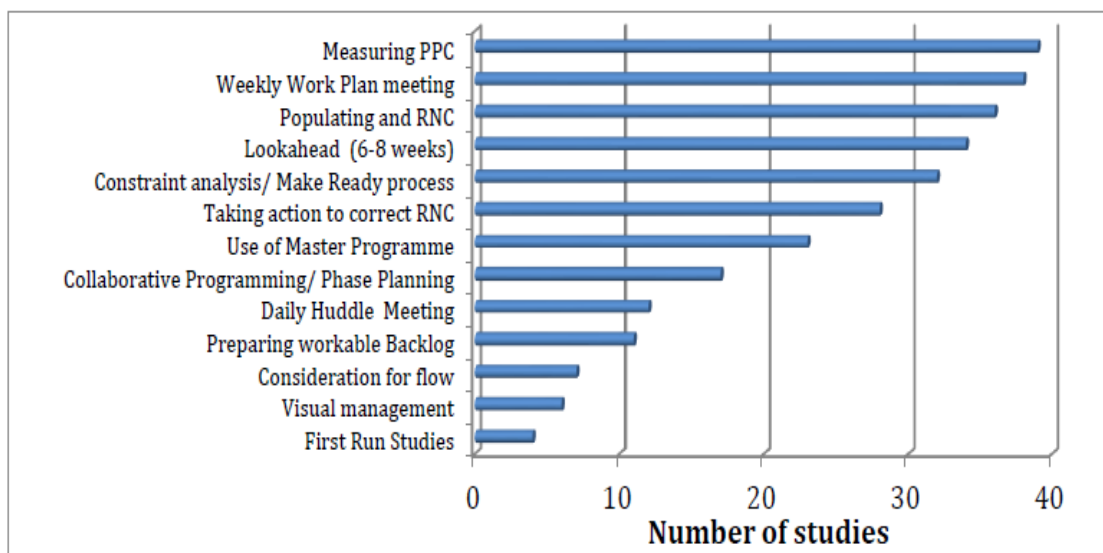

Figure 2.3: Other components of the LPS (adapted from Daniel et al. 2016)

**2.4.2. Increased Visualization**

One very critical requirement for the successful implementation of lean construction tools and techniques is improved transparency. This is, however, difficult to achieve due to the fragmented nature of the construction industry. Formoso et al. (2002) asserted that the inability of production systems in construction to function below their full potential is because of a lack of transparency. In the traditional conversion model of construction, it is presupposed that the subprocesses in the entire production process can be independently analyzed and implemented without total consideration to other subprocesses (Koskela 1992), and there appears to be no emphasis on

transparency since it is presupposed that subprocesses can be independently realized (Brady 2014). The lack of transparency arising from the traditional conversion model of construction leads to communication issues, and there is little feedback on the causes of problems in the process since control is focused on time and cost rather than on learning and improvement (Koskela and Howell 2001). Project information relevant to a process or sub-process must be shared sensibly to encourage communication and facilitate quick decisions, critical features of a transparent process (G. D. Galsworth 1997; Bauch 2004; Bowen and Lawler III 2006; Nijhof et al. 2009).

### **2.4.3. Construction Process Simulation Modelling**

The use of simulation and computer modelling provides an excellent means of promoting the principles of LC. Simulation enables the modeller to change the logic of construction processes by adding, deleting or updating an event to evaluate different solutions in response to construction problems without the cost of implementing these changes. It also helps provide information about real-world systems (Law et al. 1991) and evaluate their performance based on the information input (Halpin and Riggs 1992). Models simulating the entire construction process can be built and analyzed to provide more value for the client. These models can simulate tasks, resources and constraints to provide guidance in optimizing resource use, reducing costs, identifying and reducing project risks and enhance the planning process (Law et al. 1991; RazaviAlavi and AbouRizk 2015).

Simulation serves as a useful tool for designing optimal resources associated with a construction operation and analyzing an ongoing operation to evaluate and refine it. Therefore, it allows the modeller to experiment with different scenarios in a low-cost, low-pressure environment (Abdullah et al. 2009). It provides managers with an environment to incorporate their prior knowledge or experience into random processes and allows the modeller to build sophisticated decision structures in the model to represent the actual operation accurately (AbouRizk 2010). A simulation-based scheduling approach has been suggested by previous scholars for detailed

scheduling at the construction operation level, capitalizing on the capability of discrete-event simulation (DES) to mimic the construction operation logic and investigate resource allocation among activities. Several works have been carried out to highlight the importance and application of simulation in construction. Simulation has been applied to study resource allocation and productivity measurements (AbouRizk et al. 1992), compare alternative construction methods to select the optimum method (Oloufa 1993), analyze the workflow and the construction processes involved in heavy civil projects (Vanegas et al. 1993), study and evaluate construction scheduling (Alves et al. 2006; Hamzeh et al. 2015; Song and Eldin 2012; Tommelein et al. 1994; Wang et al. 2014; Zayed and Halpin 2000), risk assessment on construction projects (Cho and Kim 2008; Kang et al. 2013) and supply chain management (Hamzeh et al. 2007). In the simulation approach, individual activities, dependencies among them and resource availability are considered. This capability makes simulation suitable for the development and investigation of construction schedules.

### *2.4.3.1. Simulation in LC*

Halpin and Kueckmann (2002) explored the relationship between simulation and LC. They revealed that lean thinking provides a structured framework to redesign production processes, while simulation provides the methodology for evaluating the benefits. A generic set of guidelines to test lean principles in a simulation model was proposed by Farrar et al. (2004). Mao and Zhang (2008) suggested a framework to streamline the construction process and create innovative construction methods and applied simulation to test the efficacy of the system. Abbasian-Hosseini et al. (2014) used computer simulation to quantify and evaluate the results of applying lean principles in the bricklaying process, and Nikakhtar et al. (2015) applied simulation to quantify the effects of lean principles on a reinforcement process. Simulation can be used to validate LC concepts before field implementation as it enables the analysis of the impacts of LC theory on a project by supporting a variety of procedures, including model sensitivity and scenario analyses (Poshdar et al. 2016).





#### *2.4.3.2. simulation in bridge construction project*

The features of bridge construction projects arising from their performance sequence, constraints, resourcing issues and structural adequacies make their planning and analysis more complex (Chan and Lu 2012). To facilitate lean thinking in bridge construction projects, planners need to employ scheduling techniques to better control and maximize resource usage; this can be achieved using simulation. Simulation has also been applied in the domain of bridge construction. A few examples include the application of simulation to resolve construction dispute during a bridge construction project (AbouRizk and Dozzi 1993), study of the repetitive cycles of placing the concrete segments and stay cables in the construction of cable-stayed bridges (Huang et al. 1994), understand the logistics and operations involved in a highway viaduct construction project in Hong Kong (Chan and Lu 2005), investigate the application of simulation in bridge construction (Marzouk et al. 2007), guide the planning and construction of bridge deck (Marzouk et al. 2008; Said et al. 2009), study the construction process involved in bridges based on day-to-day data (Ailland et al. 2010), generate schedule for bridge construction (Wu et al. 2010) and, for the phasing evaluation of elevated urban highway reconstruction projects (Mawlana et al. 2012, 2015).

#### *2.4.3.3. Discrete Event Simulation (DES)*

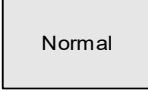
DES provides an excellent means to model and evaluate construction processes, including the overall project duration and resource utilization (Wu et al. 2010). Mawlana et al. (2015) asserted that DES could accommodate deterministic and stochastic modelling of construction operations and allows for extensive sensitivity analysis to be carried out. There are several software packages available to develop DES models. MicroCYCLONE (Halpin and Riggs (1992) and STROBOSCOPE (Martinez 1996) are two popular software used in construction simulation. These two programs use similar modelling elements to represent activities and resources (Table 2.5). These modelling elements are combined to form a network used to develop Activity Cycle Diagrams (ACD) simulation models suitable for micro-scheduling construction activities.

Table 2.5: Basic modelling elements (adapted from Martinez 1996)

Modelling Element	Description
	These represent tasks that start immediately after the end of another task. A normal acquire the resources required to perform its tasks from the task that has just finished
	These represent tasks that start only when certain conditions are met. They can acquire only inactive resources. The default condition for a combi to start is that none of its directly preceding queues is empty
	These are used to hold idle resources. Each queue is associated with a resource type.
	This is used to connect network nodes and indicates the direction and type of resources flowing through them.

Simulation provides a means for achieving the goals of LC as it helps identify potential areas of improvement in construction projects by aiding in identifying and removing non-value adding activities. A comprehensive comparison of the different simulation approaches is shown in Table 2.6 (adapted from Andres and Poler 2016).

Table 2.6: Comparison of simulation approaches (adapted from Andres and Poler 2016)

	Discrete Event Simulation	System Dynamics	Agent-Based Simulation
Decision-making level	Operational	Strategic	Operational and tactical
Degree of centralization	Centralized: One thread of control. Entities are described as passive objects, and the rules that drive the system are concentrated in the flowchart blocks	Centralized: Useful to model systems consisting of homogenous entities, dominated by general laws, uniform in time and space	Decentralized: Each agent has its thread of control. The process is described from the entity's viewpoint. It is useful in more complex systems
Level of abstraction	Low: Tends to look at the smaller detail of a system	High: Tends to take a more overall perspective and considers the holistic approach of systems	Low: Abstraction of the systems basic components are individually done
The complexity of the modelled system	Low level of abstraction makes the modelling process detailed and complex	Higher degrees of abstraction leads to lower complexity models	Low level of abstraction makes the model more rigorous and considerably more complex
Modelling approach	The top-down approach focused on modelling the system in detail	The top-down approach focused on modelling the system from a global perspective	Individual-based. A bottom-up approach focused on modelling the entities and their interactions
Mathematical approximation	Stochastic in nature. Randomness is generated using statistical distribution	Generally deterministic and variables usually represent average values	Generally stochastic. Can use input distribution to model random behaviour
Evolution over time	The system is modelled as a network of queues and activities; state changes occur at discrete points of time and at irregular discrete time steps	The system is represented as a set of stocks and flows; state changes occur continuously over time, are continuous, approximated by small discrete steps of equal length	The system is modelled considering that state changes occur at discrete points in time. State changes occur in defined steps of discrete-time
Entities behaviour to making decisions	Passive: The behaviour of the entities in the model is determined by the system	Passive: Individual entities are not explicitly modelled but are instead represented as a continuous quantity in stock	Active: Specific attributes are assigned to each agent, which determines what happens to them throughout the simulation
Data requirements	Requires detailed data. Input distributions are often based on collecting/measuring objective data	Minimal data required to build the model. Input distributions are often based on theories or subjective data	Requires detailed data to model agent behaviour. Input distributions are often based on theories or subjective data
Validation	Established rules for validation	Established rules for validation	Validation rules cannot be directly transferred

## **2.5. Lean Intervention in Highway Projects**

Infrastructure projects are projects primarily carried out to fill a need in society. One such need is the provision of new and reconstructed highways. In most developed countries of the world, the focus is on reconstructing existing highways that may be approaching or surpassing their service life or to accommodate the effect of urbanization. As a result, reconstruction and rehabilitation work on existing highways is expected to increase over the coming years and ensuring that highway construction works are completed on schedule places state transport agencies under increased pressure. The current practice in the construction industry indicates that urban highway projects are often overrun in budget and time due to different factors, including the high cost of equipment and materials, meteorological and environmental factors, and a large number of unpredictable factors (Dawood and Shah 2007; Hannon 2007).

Limited workspace, maintaining an acceptable flow of traffic, availability of enough workspace for construction workers and sufficient lane width for road users without a compromise to safety, and, phasing of construction works to account for the number of contractors involved, independent resource utilization planning by each contractor and the large number of concurrent activities taking place at the same time are some specific challenges encountered in urban highway projects (Doriani 2012; Mawlana et al. 2012, 2015)

The procurement method typically adapted for infrastructure highway projects also serves as an inhibitor to successfully implementing the lean concept in such public-sector projects. However, BIM tools integrated with lean principles can facilitate the adoption and implementation of lean construction principles in highway construction. According to Strafacci (2008), *“implementing a BIM process for road and highway design starts with creating coordinated, reliable design information about the project. This results in an intelligent 3D model of the road in which elements of the design are related to each other dynamically, not just points, surfaces and alignments, but a rich set of information and the attributes associated with it.”*



### **2.5.1. Lean Project Delivery System**

Different project delivery systems (PDS) such as design-build, design-bid-build, construction management at risk are used in the construction sector. However, despite the logic of traditional, many owners/customers remain dissatisfied (Lichtig 2006). To ensure that owners/customers get value for their money, the construction industry needs to move towards better coordination of participants and more collaborative and integrated approaches to provide more predictable results to owners/customers (Egan 1998). The lean project delivery system (LPDS), also known as integrated project delivery (IPD) (Post 2010) and integrated lean project delivery (ILPD) (Walker 2009), provides a viable solution to the problem of corroborative and integrated approaches to facilitate better outcomes for construction projects.

Lean project delivery system (LPDS) is a project-centric delivery that seeks to align interests, objectives and practices of the project stakeholders through a team-based approach by applying several lean techniques (Hanna et al. 2010; Wodalski et al. 2011). It is a prescriptive model for managing projects in which project definition is represented as a process of aligning ends, means and constraints (Ballard 2008) and builds cooperation in the context of a single integrated team involving the major project stakeholders as equals in the pursuit of a shared goal (Mossman et al. 2010). LPDS seeks to improve project outcomes through a collaborative approach of aligning the project teams' incentives and goals through shared risk and reward, early involvement of all parties, and a multiparty agreement (Sarkar 2015). Mastroianni and Abdelhamid (2003) claim that conventional project management techniques provide structure and rules of engagement but currently do not promote the removal of waste in design and construction processes nor focus on adding real value. LPDS can augment conventional methods to include what the owner wants while improving the bottom line for the stakeholders involved (Howell and Ballard 1997a; Koskela 1992). In the LPDS, it is assumed that the job of the project delivery team is not only to provide what the client wants but also to provide guidance to aid the client in deciding

what they want. Consequently, it is imperative to comprehend the purpose and constraints of the client, expose the client to other means through which their purpose may be achieved and help them understand the consequences of their desire. An overview of the LPDS adapted from Ballard 2008 is shown in Figure 2.4.

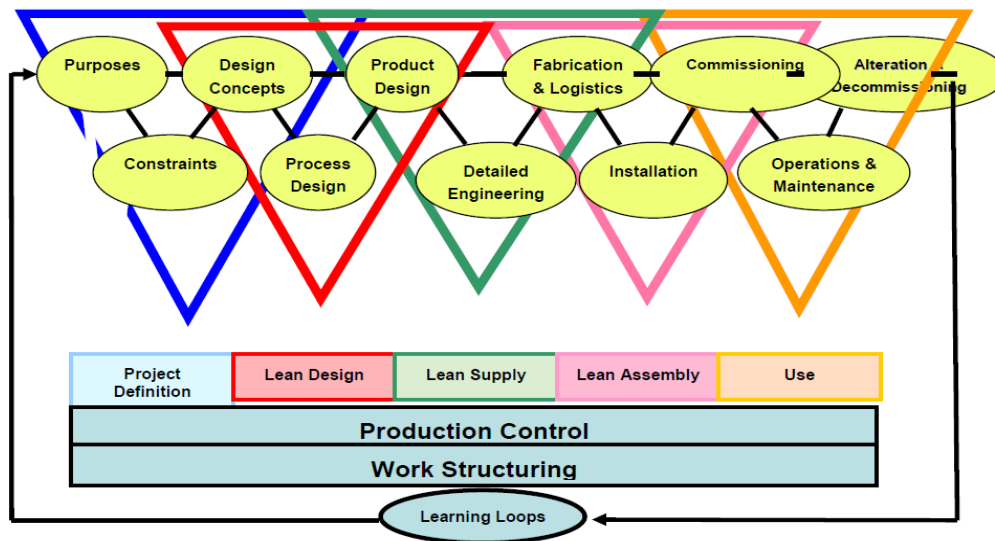

Figure 2.4: Lean project delivery system (adapted from Ballard 2008)

Traditionally, state transportation agencies (STA) adopt the design-bid-build (DBB) project delivery method to complete transportation infrastructure projects either alone or in a combination of construction manager at risk (CMAR) and design-build (DB) (Hanna et al. 2010; Wodalski et al. 2011). This, however, has not improved productivity or reduced the fragmentation in the construction industry. LPDS can improve quality, shorten project duration, reduce costs, improve collaboration and transparency, reduce waste and enhance value for the client/owner. Developing a true LPDS requires integrating lean philosophy through the systematic application of lean techniques within an integrated project delivery framework. While many lean techniques and tools can be implemented in isolation, the IPD framework's utilization is a vital baseline requirement for developing a true LPDS (Wodalski et al. 2011).

### **2.5.2. Virtual Design and Construction (VDC)**

The Centre for integrated facility engineering (CIFE) at Stanford University proposed the first definition for VDC and defined VDC as “the use of multidisciplinary performance models of construction projects, including their product, organization and process (POP) models to support business objectives (Khazode 2010; Khazode et al. 2006; Kunz and Fischer 2012). Mandujano et al. (2015) considered VDC as a structured process, a set of measurable activities conceived to produce a specific outcome. The VDC project model is an integrated model that emphasizes those aspects of the projects that can be designed and managed, i.e., the *product*, the *organization* that will define, design, construct and operate it and the *process* that the organization will follow (Kunz and Fischer 2012). Although VDC and BIM are sometimes used interchangeably, BIM represents the form/scope of the product, which is an important but small portion of the VDC framework (Kunz and Fischer 2012). Kam et al. (2014) revealed that subtle additions to VDC in terms of the modelling scope, the drivers of modelling and social methods for leveraging the models make VDC more comprehensive and holistic than BIM. VDC refers to the entire POP model (which has BIM as part of the product definition) and includes all processes over the planning, design, construction and operation of a project as well as the project organization supporting these processes (Kam et al., 2014; Kunz and Fischer 2012; Mandujano et al. 2015).

VDC provides an excellent means for incorporating lean tools and techniques in the delivery of new and reconstructed highways. It fosters early collaboration and has the potential of transforming the construction process (Zeiss 2012), facilitates the reduction of waste by first building virtually to check for buildability and makes cost-less changes to the design if need be. Khazode et al. (2006) provided guidelines for using VDC principles during the LPDS and highlighted specific examples of how VDC can be used during the LPDS. VDC provides the technology to sustain the lean implementation effort and helps achieve lean principles (Khazode et al. 2007). Regardless of the perceived benefits of implementing VDC, some challenges mitigate

its full adoption and implementation in horizontal construction. According to Kunz and Fischer (2012), VDC emerges in three stages: visualization, integration of multiple models and automation. In the first stage, visualization is relatively easy to achieve with current PC technology. However, because VDC models are multi-disciplinary (they include product, organization and process models), integrating these models is typically hindered by interoperability issues. Another challenge to implementing VDC in the infrastructure domain is the lack of an assessment tool and methodologies to measure and facilitate its implementation (Kam et al. 2014). They further asserted that developing an assessment methodology for VDC will allow for an accurate assessment of the performances and challenges facing its implementation, provide opportunities for improvement and create a healthy feedback loop among academia, private and public organizations, and industry groups, thus leading to the optimization and maximization of returns.

A variety of tools and techniques have been developed under the VDC framework and includes product visualization tools (3D object modelling technology), product and process modelling and visualization tools (4D visualization tools), organizational and process modelling tools, online collaboration tools and techniques to analyze the effectiveness of multi-stakeholder meetings (Khanzode et al. 2006). Measuring the gains from VDC implementation in a systematic manner is important, considering the cost of investment in both software and training.

### **2.5.3. Building Information Modeling (BIM)**

BIM is a digital representation of the physical and functional characteristics of a facility (Suermann and Issa 2009) and is the process of generating and managing building data during its life cycle (Lee et al. 2006). BIM promotes a more cohesive design and construction process with positive ramifications for cost, quality and duration (Eastman et al. 2011). BIM covers geometry, spatial relationships, geographic information, quantities and properties of the building component (Lee et al. 2012) and can LC outcomes by reducing waste and inefficiency (Sacks et al. 2010a).

BIM is helping to transform the ways construction projects are designed, analyzed, constructed and managed by creating a corroborative platform for project stakeholders. It can, therefore, serve as an excellent tool in reducing lean wastes when adequately utilized. It facilitates communication, collaboration and transparency among project stakeholders, promotes the optimal use of resources, helps to reduce waste by conceptualizing the entire project before the commencement of construction, used for space planning in worksites, helps in costing and estimation and accurate production of material take-off requirements and provides an excellent means of documentation among others. BIM also leads to faster and more effective processes by reducing field coordination problems to reduce waste of waiting, leads to better designs, facilitates in the reduction of reworks arising from defects, controlled whole life cycle costing, synchronized design and construction planning, reduction of conflicts, clash detection and changes, verification, guidance and tracking of activities (Azhar et al. 2015; Eastman et al. 2011).

BIM is, among other things, a visualization tool, and visualization helps in eliminating the confusion that may arise from unclear or misinterpreted information. In the construction of elevated urban highways, BIM as a visualization tool has a tremendous impact on waste reduction as it facilitates the exchange of information and promotes coordination. The relationship between BIM and LC is shown in Figure 2.5 (adapted from Eroshkin et al. 2016).

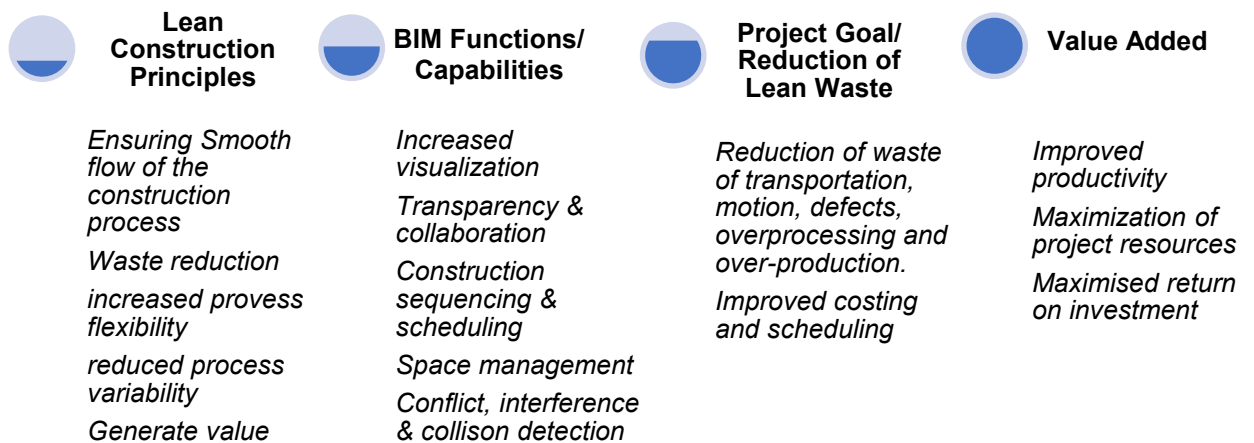

Figure 2.5: How Lean-BIM generates value (adapted from Eroshkin et al. 2016).

The implementation of BIM can facilitate the reduction of LC waste. BIM can be used as a decision support tool to achieve stable flows (Sacks et al. 2009) and has become the standard approach for project information coordination and automation (Azhar et al. 2015). Dave et al. (2013), however, contended that it is crucial to understand the application of lean and BIM to facilitate an improvement in the production management of infrastructure projects due to their value and strategic significance to the development of any nation. Technologies such as 4D BIM aim to improve the productivity of the construction sector and work better when integrated with contemporary management concepts such as LC tools, techniques, and methodology. The integration of 4D BIM and LC in elevated urban highway projects can provide new opportunities for better implementation, monitoring, and evaluating projects in this domain.

#### **2.5.4. 4D Modeling**

A 4D model can be defined as the integrated visualization of 3D engineering data, i.e. spatial data, and a construction schedule with purpose-built modelling technology (Hartmann et al. 2008; Heesom and Mahdjoubi 2002a, 2004; Jongeling and Olofsson 2007; Webb et al. 2004). It is obtained by linking a 3D model to the fourth dimension of time. According to Koo and Fischer (2000), the project's temporal and spatial aspects are linked as they would be during the actual construction process in the 4D model. 4D models facilitate logistics and site layout planning (Zhang et al. 2000), promotes collaboration (Fischer and Kam 2001; Kähkönen and Leinonen 2001), helps improve workspace planning (Akinci et al. 2002c; a; Heesom and Mahdjoubi 2002b; a), used for constructability reviews (Hartmann et al. 2008; Hartmann and Fischer 2007), aids scheduling, scheduling, workflow-based and location-based planning, identification and resolution of spatio-temporal conflicts, safety issues and site workspace management (Jongeling and Olofsson 2007; Koo and Fischer 2000; O'Brien et al. 2012; Platt 2007) and visualization of designs for marketing and communication purposes, design review, cost estimating, bid preparation and procurement (Hartmann et al. 2008).

The systematic use of the 4D model can lead to significant cost and time savings and can be especially useful in projects with multiple stakeholders (Teixeira 2014). It helps boost collective decision making and the development of constructability and execution strategies. Khanzode et al. (2006) reveal that 4D models can communicate the construction sequence at the macro and micro levels. They explained further that they could be used to communicate issues like material movement and staging areas throughout the project, access routes and disruptions due to construction on other areas surrounding the construction project at the macro level. They can be utilized on the micro-level to demonstrate the construction sequence for a project allowing project teams to determine the laydown areas available during construction. The research on 4D technology is influenced by increasing project complexities, requirements for projects to be delivered in a shorter time and a general need for better planning techniques (Platt 2007) and facilitates the delivery of complex projects. According to Kang et al. (2006), 4D models help express numeric construction schedule data in a visual format, and this visualization helps planners visualize the construction process as it would be built. The elements in a 4D model will contain its geometric attributes that from its 3D shape, and the time attribute that specifies the construction schedule and may facilitate a deeper understanding of the construction process since it provides the actor with the visual elements that can be used to simulate a sequence of construction tasks (Mahalingam et al. 2010).

One important use of 4D models is detecting and analyzing spatio-temporal clash (Dodds and Johnson 2012; Patel 2015). Spatio-temporal clash occurs when activities' space requirements interfere with one another or with work in place (Akinci et al. 2002c). Two main types of spatio-temporal clashes exist: (a) hard clashes, interferences between physical components and (b) soft clashes, interferences between different clearance volumes and workspaces (Staub-French and Khanzode 2007). Regardless of the benefits of 4D modelling, it is not without limitations. Developing the 4D model requires a labour-intensive information input process to ensure that the level of detail (LOD) is sufficient to test and analyze sequencing alternatives

(Harris and Alves 2013). The LOD is important because the level of interactivity required with the 4D simulation is critical in ensuring the project plan's reliability (Heesom and Mahdjoubi 2004). Koo and Fischer (2000) also revealed that developing a 4D model involves categorizing the activities of the original schedule and creating relationships between the activities with the 3D model components in a 4D simulation application. This process becomes laborious as the size and complexity of the project increases involves significant work hours and creates additional up-front costs to the project. According to Heesom and Mahdjoubi (2004), another limitation of current 4D modelling applications involves its visual representation as they are unable to represent the dynamic capabilities of the simulation accurately. They further contended that to promote 4D simulation, it is necessary to improve the system to ensure that it requires a minimum level of input. Automating schedule data preparation and building the 4D model in the design stages can expedite 4D model development (Koo and Fischer 2000). Improvements in current 4D models must, therefore, be made to expedite their generation and aid users in conducting the model analysis.

4D simulations provide an excellent opportunity for space planning in highway projects, but currently, the ability of 4D models to dynamically represent work execution space, including equipment space, is an area of research that has been neglected and requires further attention. However, it is not a “fix-it-all” technology, and its full potential will be realized only when it can be customized to suit the need of individual sites. A 4D model's ability to accurately simulate construction is strongly linked to the planning process's reliability and ability to identify and remove constraints to make plans ready for implementation.

The 4D model's reliability can be increased with support from the LPS and vice versa (Bhatla and Leite 2012), making it essential to develop a framework for integrating the LPS in a 4D model. There have been attempts to integrate the LPS and 4D to enhance the understanding of construction processes to facilitate collaborative planning and improve project progress monitoring (Bhatla and Leite 2012; Khanzode 2010; Sacks et al. 2011, 2013; Toledo et al. 2014).



However, these contributions were purely conceptual and failed to provide any practical evidence to validate the framework implementation (Toledo et al. 2016). Figure 2.6 summarizes the best use of 4D models for highway construction gleaned from the literature.

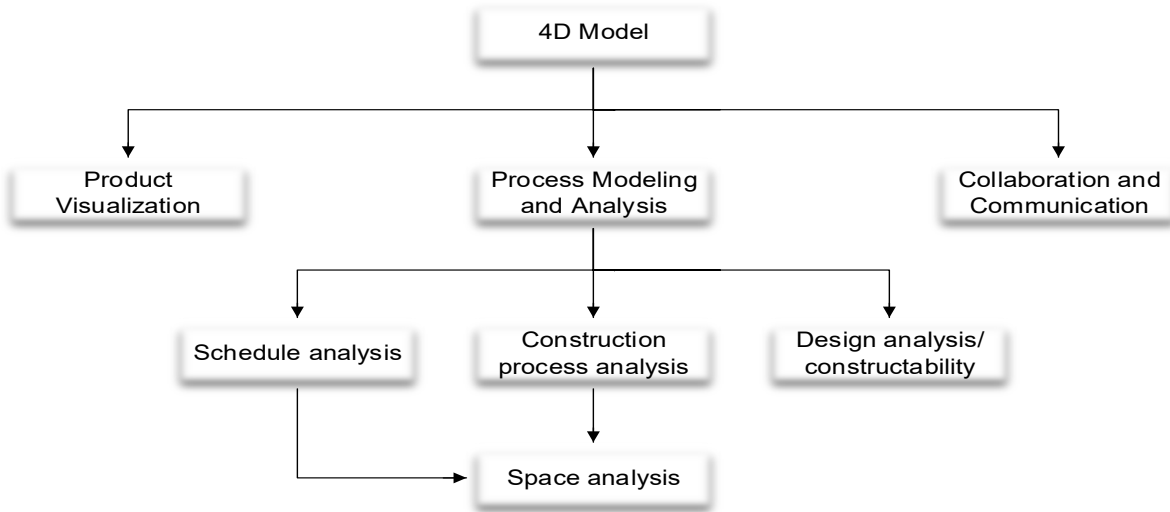

Figure 2.6: Applications of the 4D Model

In the delivery of new and reconstructed highways and indeed in all projects, construction planning and scheduling play a crucial role in developing a feasible 4D model, and it is, therefore, essential to ensure that the scheduling is done in such a way as to avoid workflow clash which is a form of spatio-temporal clash. However, regardless of the significant number of research on the gains and applications of 4D modelling, very few have focused on applying the 4D model in micro-scheduling of heavy construction equipment used in highway construction.

## **2.6. Barriers to Implementation of Lean Construction**

Research has shown that lean intervention in construction reduces variability, improves construction flow and ensures that value is provided to the client regarding the project KPI's. Regardless of the perceived and actual benefits that can be directly or indirectly gained from implementing lean in construction, some barriers prevent its full implementation and realization of its gains.

Several studies have been carried out to identify the barriers to the implementation of lean in different countries. Based on an extensive literature review, this study summarizes the significant findings on lean implementation barriers into two broad categories: external and internal barriers. The choice of this categorization is to provide proper intervention measures to the identified barriers and not spend too much time trying to remove barriers outside the direct influence of the construction industries. The external barriers are corporate based issues affecting the construction industries, such as the organizational culture and management commitment to lean intervention, while the internal barriers are project-based issues affecting the successful implementation of lean on a project level. These barriers are summarized in Table 2.7.

Table 2.7: Barriers to the implementation of LC

	Main Theme	Barriers to Implementation	References
<b>EXTERNAL BARRIERS</b>	Management Issues	<ul style="list-style-type: none"> <li>• Poor client and supplier involvement</li> <li>• Lack of top management support and commitment</li> <li>• Poor project definition</li> <li>• Delay in decision making</li> <li>• Poor selection strategies for procurement (project delivery method)</li> <li>• Organizational culture</li> <li>• Lack of organizational culture supporting teamwork</li> </ul>	Alarcon et al. (2002); Alinaitwe (2009); Bashir et al. (2015); Common et al. (2000); Forbes et al. (2002); Forbes and Ahmed (2004); Oladiran (2008); Sarhan and Fox (2013); Shang and Sui Pheng (2014)
	Financial Issues	<ul style="list-style-type: none"> <li>• Inadequate project funding</li> <li>• Implementation cost</li> <li>• Poor professional wages</li> <li>• Lack of incentive and motivation for workforce</li> </ul>	Common et al. (2000); Dulaimi and Tanamas (2001); Mossman (2009); Oladiran (2008); Sarhan and Fox (2013)
	Government Issues	<ul style="list-style-type: none"> <li>• Corruption</li> <li>• Inconsistent government policies</li> <li>• Lack of social amenities and infrastructure</li> <li>• Inflation</li> <li>• Material availability and unsteady price commodities</li> <li>• Lack of social amenities and infrastructure</li> </ul>	Alinaitwe (2009); Oladiran (2008); Wodalski et al. (2011)
<b>INTERNAL BARRIERS</b>	Educational Issues	<ul style="list-style-type: none"> <li>• Lack of an understanding of what lean entails</li> <li>• Lack of technical skills for lean implementation</li> <li>• Inadequate training and exposure for the requirements of LC implementation</li> <li>• Lack of training to facilitate the holistic implementation of lean</li> <li>• Lack of lean awareness</li> </ul>	Abdullah et al. (2009); Alarcon et al. (2002); Alinaitwe (2009); Castka et al. (2004); Common et al. (2000); Cua et al. (2001); Mossman (2009); Oladiran (2008); Sarhan and Fox (2013)

Collaborative Planning	<ul style="list-style-type: none"> <li>• Poorly defined focus and low understanding of the lean concept</li> <li>• Lack of training to support lean intervention</li> <li>• Lack of group culture and shared vision</li> <li>• Lack of time for implementing new practices in projects that were already underway</li> <li>• Weak communication among project stakeholders</li> <li>• Fragmentation of the construction sector</li> </ul>	Abdullah et al. (2009); Alarcon et al. (2002); Alarcon and Seguel (2002); Ayarkwa et al. (2012); Castka et al. (2004); Cua et al. (2001); Johansen et al. (2004); Johansen and Porter (2003); Salem et al. (2006); Sarhan and Fox (2013); Shang and Pheng (2014)
Benchmarking	<ul style="list-style-type: none"> <li>• Lack of management leadership</li> <li>• Lack of agreed lean methodology</li> <li>• Fragmentation of the construction industry</li> <li>• Lack of formal “best practice.”</li> </ul>	Ayarkwa et al. (2012); Fawcett and Cooper (2001); Sarhan and Fox (2013)
TQM	<ul style="list-style-type: none"> <li>• Lack of an understanding and implementation of client requirement</li> <li>• Lack of management leadership</li> <li>• No formal/systematic means of ensuring continuous improvement</li> </ul>	Haupt and Whiteman (2004)
Variability Reduction	<ul style="list-style-type: none"> <li>• Incomplete design</li> <li>• Design/construction dichotomy</li> </ul>	Koskela (1999); Lamming (1993); Sarhan and Fox (2013)
Flow Reliability	<ul style="list-style-type: none"> <li>• Lack of prefabrication</li> <li>• Use of non-standard components</li> <li>• Poor material requirement planning</li> </ul>	Koskela (1999); Paez et al. (2005); Pheng and Chuan (2001); Shmanske (2003)
JIT	<ul style="list-style-type: none"> <li>• Uncertainty in the supply chain</li> <li>• Poor supplier integration in the construction process</li> <li>• Poor transportation and communication</li> <li>• Lack of inventory control</li> </ul>	Pheng and Hui (1999); Polat and Arditi (2005); Womack and Jones (2003)
Pull Scheduling	<ul style="list-style-type: none"> <li>• Inadequate resources</li> <li>• Inadequate planning</li> <li>• Poor implementation of the last planner system</li> </ul>	Ballard and Howell (1998); Mader (2003); Matthews et al. (2000)

### 2.6.1. Challenges to Implementing Lean-BIM in Highway Projects

An essential criterion for BIM's success is the availability of open standards for the lossless exchange of high-quality BIM data between software applications from different manufacturers. According to Amann et al. (2015), the Industry Foundation Classes (IFC), drawn up by the international organization BuildingSMART, presents a standardized data model that meets these requirements. The IFC is data elements representing parts of buildings or elements of the process and contains the relevant information about those parts (BuildingSMART 2017). They are used by computer applications to assemble a computer readable model of the facility to be built and

contains all the information regarding the model and their relationships (Beal n.d.). IFC provides an environment of interoperability among compliant software applications in the architecture, engineering, construction, and facilities management industry (AEC/CM). They allow building simulation software to automatically acquire building geometry and other building data from project models created with IFC compliant software and facilitate the direct exchange of input and output data with other simulation software (Bazjanac and Crawley 1997; Yabuki 2010). However, IFC mainly supports structural engineering while ignoring civil engineering (Amann et al., 2015).

The lack of an official IFC standard for representing 3D model data in the infrastructure domain is a challenge towards the adoption of BIM in infrastructure projects (Yabuki 2010). He further revealed that there is no standard 3D software for infrastructures, thus leading to the problem of interoperability. Interoperable product models are necessary to share to exchange data, and presently attempts are being made at extending the IFC definitions for infrastructure works, beginning with alignment and expanding into other areas such as roads, rails, bridges and tunnels (BuildingSMART 2017). Due to the rapidly increasing importance of BIM for infrastructure, research is currently in progress to develop a comprehensive civil engineering extension that will make it possible to describe elements such as roads, railways, bridges and tunnels (Amann et al. 2015). They further asserted that the first steps towards developing an IFC infrastructure have been made as part of the IFC alignment project, aiming to develop an alignment extension.

The IFC alignment model will be the basis for many other infrastructure-related data models such as IFC Road, IFC Bridge and IFC Tunnel (Figure 2.7 adapted from BuildingSMART 2017). Until this is done, the problem of interoperability will limit the application of BIM to highway projects. An overview of the infrastructure modules (adapted from BuildingSMART 2017) is shown in Figure 2.8.

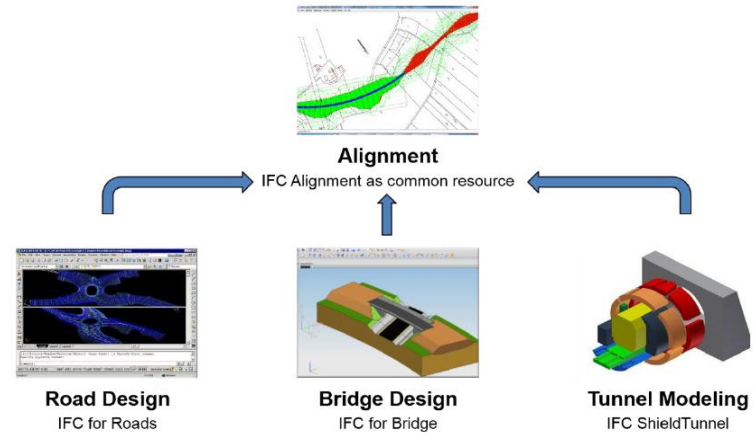

Figure 2.7: IFC Alignment (adapted from BuildingSMART 2017)

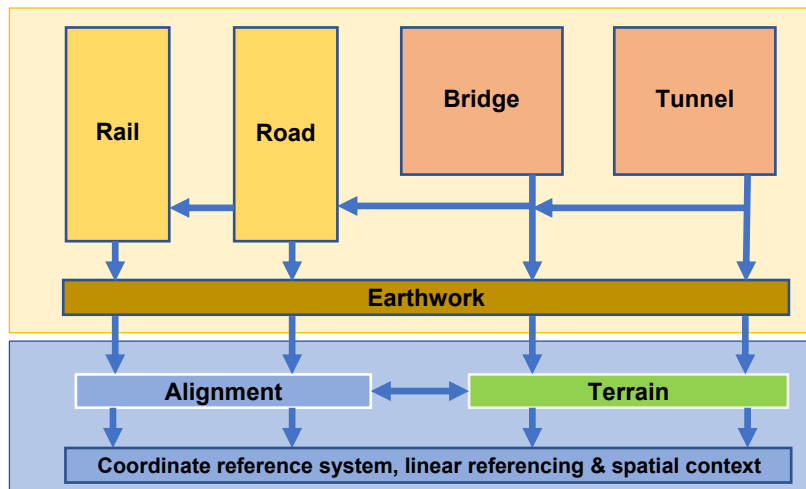

Figure 2.8: Overview of infrastructure modules (adapted from BuildingSMART 2017)

Other factors aside from the challenge of operability, are responsible for the slow adoption and implementation of lean-BIM in infrastructure projects. One of these factors is the planning and scheduling techniques applied to infrastructure projects, especially related to the delivery of new and reconstructed urban highways. The effectiveness of traditional planning and scheduling techniques typically applied in building construction projects have a limited application in infrastructure projects (Harmelink and Yamin 2001; Kang et al. 2006,2012 2013) as they fail to address the spatial nature of the project (Kang et al. 2012; Koo and Fischer 2000; Shah et al. 2009). The project delivery method typically adapted to deliver new and reconstructed highways is the Design-Bid-Build (DBB), which inhibits collaboration and innovation. In the DBB method,

the design is usually done by a consultant and then general contractors tender bids and perform construction if they win. Hence the requirements for the implementation of Lean-BIM are challenging to achieve because of the project delivery method. Yabuki (2010) contended that to facilitate the adoption of BIM in the infrastructure domain, the current project delivery system must be changed or modified. Other challenges facing the implementation of Lean BIM are shown in Figure 2.9. It is also revealed that the adoption and use of BIM in infrastructure projects are only at an average level of implementation (Chong et al. 2016; Shou et al. 2015).

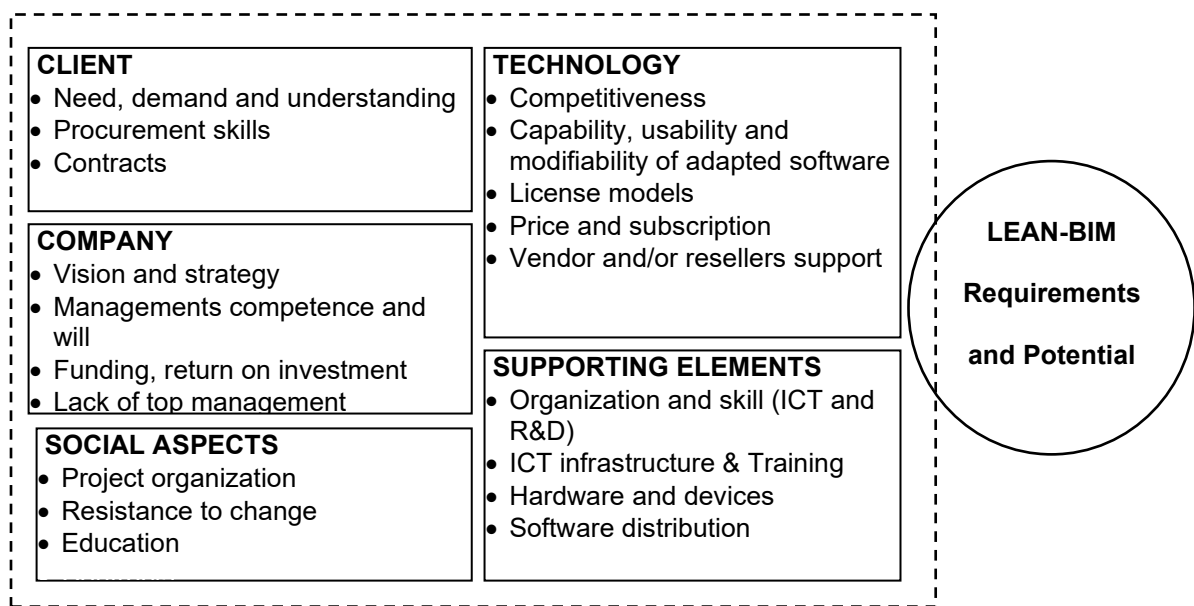

Figure 2.9: Key Challenges to implementing Lean-BIM

## 2.7. Construction Workspace Management

Construction Workspace Management (CWM) refers to the process of classifying, planning and managing the workspace requirements for construction projects. It includes processes such as workspace generation, representation and allocation, and includes the process of workspace conflict detection and resolution at any time during a construction project (Chavada et al. 2012b). Workspaces are one of the critical resources required for the successful management of a project. Luo et al. (2019) asserted that workspaces accommodate and constrain activities as they form and evolve spatiotemporally as the project progress. Construction workspaces aim to align project

resources (i.e. personnel and equipment) with available space to ensure that construction activities can be carried out safely and productively. A construction site is a complex and dynamic environment where the dynamic objects on site interact with each other in a complex and spatio-temporal manner. According to Koo and Fischer (2000), this complexity makes it hard to better understand the construction processes with traditional methods, especially in planning the construction workspace. However, the dynamic nature of construction activities makes the management of workspaces challenging using conventional planning methods, especially when it relates to micro-scheduling of short duration activities requiring the use of heavy construction equipment. Mallasi (2006) asserts that conventional planning methods do not effectively represent and communicate the interference between construction activities and do not consider space constraints in the planning process. They typically focus just on the time and cost aspect (Chau et al. 2004; Dawood and Mallasi 2006; Mallasi 2006; Wang et al. 2004).

Getuli and Capone (2018) asserted that incorporating workspace considerations from the spatial and temporal perspective in construction planning and scheduling plays a vital role in proactively preventing spatio-temporal issues that have the potential of reducing productivity and causing site safety-related issues. Spatio-temporal conflicts have been acknowledged as one of the leading causes of productivity loss (Lucko et al. 2014a; Wu and Issa 2014) and safety-related concerns (Son et al. 2019; Song and Marks 2019; Vahdatikhaki and Hammad 2015a) therefore, making Construction Workspace Management (CWM) an important aspect in construction projects. Construction activities require a set of adequate workspaces to be executed safely and productively (Wu and Chiu 2010). Therefore, the construction workspace scheduling problem focuses on ensuring the availability of activity execution workspaces. Winch and North (2006) argued that two main problems in space planning, which are independent but require different approaches, are: planning the activity workspace and planning the site layout. Most previous studies on workspace planning assumed that the resources for activity execution occupy the required workspace for the duration of the activity, adapted the same method for identifying

workspace for workers and materials regardless of their different space generation principles and failed to consider micro-scheduling of short duration activities (Choi et al. 2014). Workspace planning is usually carried out based on the planners' intuition rather than a formalized process (Akinci et al. 2002b; Sadeghpour et al. 2006), making it challenging to design a workspace for short duration activities, especially for large and complex projects (Hammad et al. 2007; Said and El-Rayes 2013; Wang et al. 2004). Furthermore, current planning techniques do not typically consider the spatial requirements for each activity. Choi et al. (2014), therefore, argued the need for an integrated approach to workspace planning that will account for the dynamic and complex interaction between construction activities and the workspace required to complete them. Su (2013) summarized the challenges involved in workspace planning into three: (1) how to generate complex workspace shapes, (2) how to facilitate the modelling process (i.e. automate or semi-automate) considering that most of the existing model requires extensive user input, and (3) how to release the constraints coming from the product model itself as many existing methods only use the product based approach to derive workspaces.

Construction workspace planning involves three continuous procedures to ensure its effectiveness: (1) identification of workspace based on the 3D model, (2) determination of tasks time associated with the identified workspace, and (3) arranging a logical task sequence (Zhou et al. 2010). Most previous studies on workspace planning assumed that the resources for activity execution occupy the required workspace for the duration of the activity, adapted the same method for identifying workspace for workers and materials regardless of their different space generation principles, and failed to consider micro-scheduling of short-duration activities (Choi et al. 2014). The succeeding sections will explore different aspects of construction planning and scheduling concerning spatial requirements.



### 2.7.1. Classification of Workspaces in Construction

Planning the workspace requires a clear understanding of its characteristics to classify them. Twelve (12) types of workspaces were identified (Riley 1994); these provided the basis for the classification by Riley and Sanvido (1995) shown in Figure 2.10

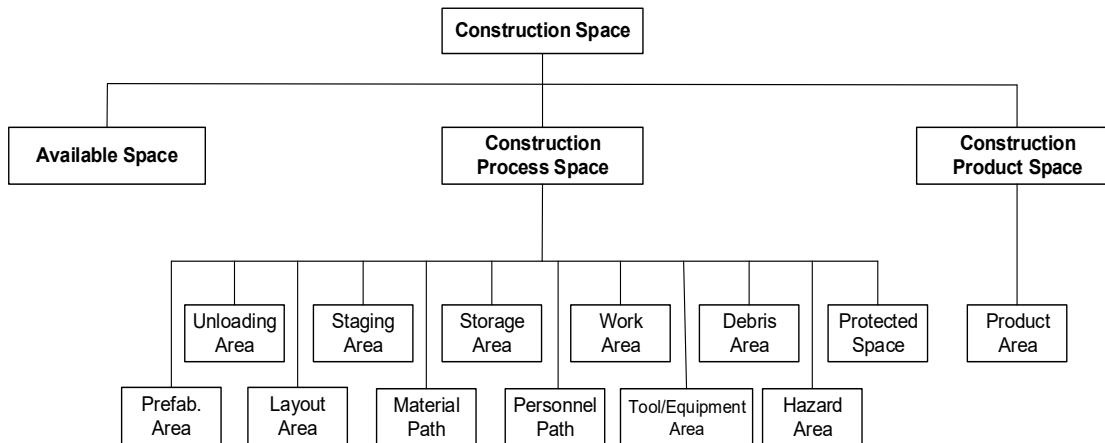

Figure 2.10: Construction workspace classification (adapted from Riley and Sanvido 1995)

Akinci et al. (2002) further grouped these 12 spaces into three categories (i) macro-level spaces; large-scale spaces, e.g. staging, storage, unloading, prefabrication areas (ii) micro level spaces; spaces required close to the construction activity site, e.g. crew, equipment, hazard and protected areas and also included the space for the actual work being performed (iii) path; spaces required for transporting material, personnel. According to Choi et al. (2014), classifying the workspace makes it easier to understand workspace planning requirements. They classified workspaces based on function (direct and indirect) and movability (fixed and flexible). Although this classification is an improved version from that proposed by Riley and Sanvido (1995), it introduces some complexities in correcting classifying workspaces. For example, they classified a staging area as a direct workspace based on function, and based on movability, asserted that staging rea could be both fixed and flexible. However, the staging area is not a direct workspace but an indirect workspace. Direct workspaces are workspaces required for only value-adding

activities (e.g. labour space, object space). Table 2.8 shows the results of other workspace classification studies.

Table 2.8: Workspace classification studies

Author	Space classification
Song and Chua (2005)	Product space, process space, protection space, path space
Dawood and Mallasi (2006)	Product space, process space, equipment space, equipment path space, storage space, labour space, protected space, support space
Winch and North (2006)	Product space, installation space, available space, required space
Moon et al. (2009)	Installation space, prefabrication space, transfer space, loading space, safety space
Wu and Chiu (2010)	Path space, material space, labour space, equipment space, site layout space, building component space
Chua et al. (2010)	Process space, resource handling space, product space, usable space, dead space
Chavada et al. (2012b)	Main space, support space, object space, safety space,
Choi et al. (2014)	Object space, working space, temporary storage space, path space, unavailable space
Zhang et al. (2015b)	Building component space, worker space, material handling path space, equipment space, protective space

The different workspace classifications shown in Table 2.8 are all variants from the work of Riley and Sanvido (1995), but slightly different terminologies have been used. For instance, some authors (Chua et al. 2010; Dawood and Mallasi 2006; Song and Chua 2005; Winch and North 2006) used product space, and others used building component space to represent the space occupied by either the permanent building component space, temporary building component space or material storage space (Wu and Chiu 2010; Zhang et al. 2015a). Based on the above differences in terminologies, a generic workspace classification is proposed. The proposed classification (Figure 2.11) recognizes two broad categories of workspaces: direct and indirect workspaces. Direct workspaces are spaces required for transformation activities only (transformation of inputs into outputs), referred to as value-adding activities. Indirect workspaces are support spaces required to facilitate transformation activities (also referred to as essential but non-value adding activities). The proposed classification is different from the classifications adopted in previous studies as it considers workspaces based on their static and dynamic qualities. Definitions for the proposed classification is also provided (Table 2.9)

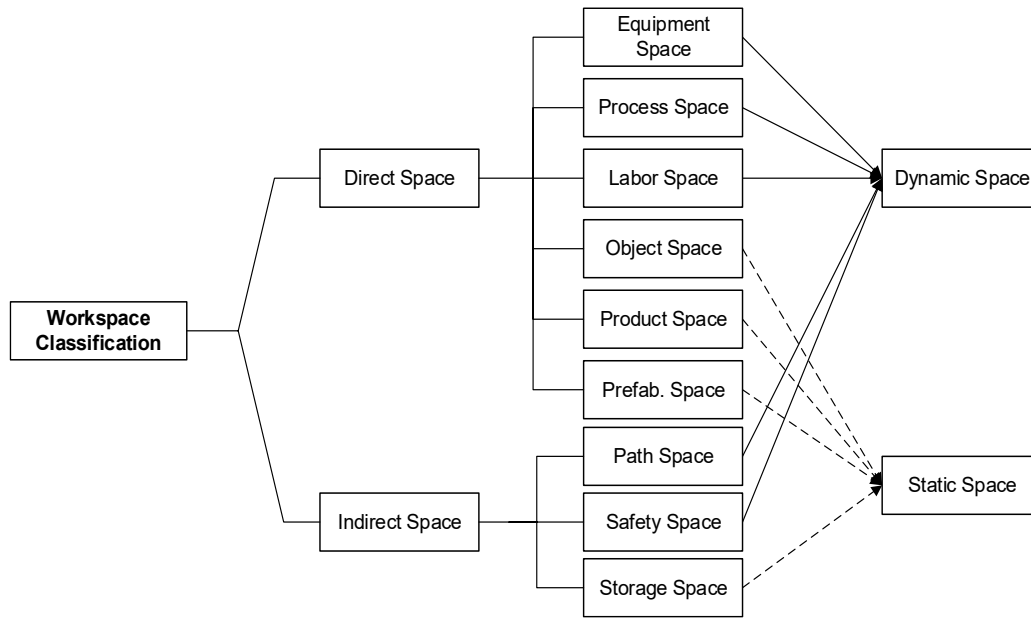

Figure 2.11: Proposed workspace classification

Table 2.9: Proposed workspace definitions

Workspace	Definition
Equipment space	Space occupied by construction equipment when in operation
Process space	Space required to facilitate transformation activities and includes material handling space, set-up space, working space and staging space
Labour space	Space occupied by personnel directly involved in transforming input into output
Object space	Space occupied by construction components (e.g. prefab walls, decks) prior to installation
Product space	Space occupied by construction components (e.g. prefab walls, decks) during and after installation
Prefabrication space	Space reserved for prefabrication of construction components (e.g. prefab walls, decks)
Path space	Space required for the movement of labourers, equipment and materials
Safety space	Space required for the safe operation of construction activities. Includes unavailable space, hazard space and protection space
Storage space	Space required for storage. Includes debris space and material laydown space

Workspace classification is an important consideration in workspace planning. Despite the importance of workspace planning, certain factors still prevent its application in practice. Some of the identified factors includes: poor construction planning, poor coordination and collaboration between project stakeholders, selection of inadequate construction method, poor site layout (Bansal 2011; Dawood and Mallasi 2006; Winch and North 2006), and unique and complex construction designs (Ovararin 2001; Shapira and Lyachin 2009).

### **2.7.2. Workspace Generation and Allocation**

Workspace generation and allocation is the process of generating workspaces and allocating them to activities and locations. Wang et al. (2018b) revealed that there are currently two methods used for generating workspaces: solid geometry-based and cell-based. The solid geometry-based method is based on the approach that utilizes one or more solid geometry objects to represent space requirements. The majority of research in this domain allocated workspaces using Bounding Boxes (BB) (Choi et al. 2014; Kim et al. 2014; Mirzaei et al. 2018; Shang and Shen 2016; Wang et al. 2018a), Axis-aligned Bounding Boxes or composite shape geometries (Hammad et al. 2007; Su and Cai 2014). The solid-based approach is applicable for modelling workspaces of static objects (Kim and Teizer 2014; Su and Cai 2014) and moving objects such as cranes (Lei et al. 2013; Tantisevi and Akinci 2007). This approach is easy to model, and clashes among workspaces are easy to detect and analyze because the workspaces are geometric elements (Wang et al. 2018b). The cell-based method is another approach for generating workspaces that use grids and cells to represent space usage (ElNimr et al. 2016; Moon et al. 2014b; Park et al. 2011; Vahdatikhaki and Hammad 2015b; Wang et al. 2018b; Zhang et al. 2007). This method is often used for the movability analysis of site objects. It, however, involves intensive calculation because numerous cells are processed.

Integrated approaches to workspace management, focusing on productivity, started to emerge in more recent years (between 2004 to date). Mallasi (2006) proposed a product-based approach for workspace generation. This approach assigns an activity workspace based on its approximation envelope (AE). The AE approach represents the workspace geometry by a 3D box generated from a construction product, and it is usually larger than the original bounding box. However, this method fails to consider the dynamic nature of construction activities, and the 3D box is incapable of accurately representing all types of workspaces and does not apply to congested sites.

Hammad et al. (2007) developed a prototype system to generate workspaces and detect spatio-temporal conflicts in a three-dimensional environment. Their method extended previous research on equipment workspace analysis and represented equipment workspaces using composite shapes. However, their prototype system did not take into consideration the scheduling constraints and how it affects workspaces. Their research, therefore, lacked the analytical robustness presented by 4D modelling. They also failed to show the implication of micro-level scheduling short duration activities in their developed method. The use of 4D simulation to detect spatiotemporal conflicts by linking the 3D BIM model with the schedule and construction space requirements was proposed by Haque and Rahman (2009). Moon et al. (2009) proposed an integrated approach for allocating workspaces using a semi-automatic method based on resource requirements. The drawback to this approach stems from the fact that the workspaces are allocated using a bounding box for each model object. In practice, however, planners tend to identify the required workspaces not only based on model objects but also scheduled activities. The developed approach lacked conflict resolution strategies and was based on AutoCAD rather than BIM software.

Bargstädt and Elmahdi (2010) developed a method called 'The Spatial Network' integrated with a simulation tool for allocating workspaces. Their methodology only considered workspace requirements at a high level of detail. A constraint-based simulation was conducted to illustrate the level of workspace occupation at regular intervals in a 2D colour-coded grid. However, their approach did not include 4D visualization capability or conflict detection and resolution strategies. Su (2013b) proposed generating workspaces by using the input-based and a product model-based approach. He asserted that in the input-based approach, the workspace is generated based on the level of detail of the user input, and the generated workspace is flexible and able to meet different modelling requirements. In contrast, the product-based approach uses the product model as the input and generates workspaces equivalent to the product geometries. However, these approaches require extensive information from user input for large-scale projects and are

not a true representative of the construction process. Semenov et al. (2014) modelled the workspace dynamics using a Resource-Constrained Project Scheduling Problem (RCPSP) approach to demonstrate and optimize workspace utilization in terms of workflow disturbance. The objective was to provide activities with their required workspaces throughout their execution period. However, their approach failed to consider the activity schedule and lacked schedule conflict detection and resolution strategies. The approach also considered only the visualization of activity conflict in 3D.

A lifecycle approach to the modelling and planning of construction workspaces, which considers the evolution pattern of space requirements of activities, was proposed by Su and Cai (2014). They developed an object-oriented structure of workspaces with both geometric and temporal attributes. This research presents advances in terms of modelling various geometric shapes of workspaces over time. Wu and Guo (2014) used space syntax in analyzing critical workspace. The space syntax provides a set of techniques for analyzing spatial configurations and encompasses a set of theories and tools for simulating the spatial structure of actual scenarios and; the critical working space implies that there is no extra floating space; thus, any conflict is expected to lead to a loss of productivity. However, this approach typically does not consider the time aspect nor provides a strategy for conflict resolution.

The majority of the studies highlighted in this section focused on improving productivity on project sites by identifying spaces necessary for safely executing construction activities and assumed that resources for activity execution occupy their required workspace for the activity duration. Vahdatikhaki and Hammad (2015a) claimed that despite the effectiveness of previous studies in reducing spatio-temporal conflicts, they are not fully capable of averting safety risks as they do not improve the safety in congested sites. To consider safety-related issues in workspace planning, it is vital to consider the dynamic equipment workspaces (DEW).

### 2.8.2.1. *Dynamic Equipment Workspaces (DEW)*

Dynamic equipment workspaces (DEW), alternatively termed “safety envelops” (Zolynski et al. 2014), considers the space around construction equipment required for safely executing an activity. DEW is applied to equipment, as opposed to activities (Vahdatikhaki and Hammad 2015a) mainly for safety considerations on construction sites by adopting real-time technologies such as vision-based tracking (Chi and Caldas 2011; Son et al. 2019; Teizer 2015; Yang et al. 2015), real-time location systems (Alshibani and Moselhi 2016; Carbonari et al. 2011; Chae and Yoshida 2010; Teizer et al. 2010; Vahdatikhaki and Hammad 2014; Wu et al. 2013; Zolynski et al. 2014), path planning (Bohács et al. 2016; Hong and Ma 2017; Lei et al. 2014; Lin et al. 2014; Song and Marks 2019; Wang et al. 2011; Zhang et al. 2009) and avoidance of overlap between the workspaces of different activities of equipment based on construction equipment activity recognition (Akhavian and Behzadan 2015; Rashid and Louis 2019).

Two general approaches can be found in the literature addressing the generation of DEW. One approach is based on proximity measurements independent of the pose, state and speed of the equipment, and therefore they over-conservatively reserve the space within the radius of the equipment (Chae 2009; Cheng and Teizer 2013; Luo et al. 2014; Marks 2014; Marks and Teizer 2013; Pradhananga 2014; Talmaki and Kamat 2012; Teizer et al. 2010; Wu et al. 2013; Zolynski et al. 2014) and the other approach is based on proximity measurement that is dependent on the pose, state and speed of the equipment (Hukkeri 2012; Vahdatikhaki and Hammad 2015a; Wang and Razavi 2015; Worrall and Nebot 2008; Zhang and Hammad 2011)

Another important consideration in the research on DEW lies in modelling their workspace requirements due to their dynamism. Tantisevi and Akinci (2007) reveal that the continuous movements of mobile cranes result in changes in the workspace requirements with time for any given operation. According to Su (2013a), due to the different types of construction equipment available, there are no standard rules to suggest that when using a specific piece of equipment, a pre-determined space will be required. Without this information, a full spatial analysis of micro-

level equipment spaces cannot be carried out. One way to counter this limitation is by utilizing information available in crane databases (e.g. “Crane Information, Specifications and Charts 2018) or using the equipment database available in commercial 4D software, e.g. Fuzor by (Kallotech 2017). Research on DEW has mainly focused on conflict/collision detection concerning safety and productivity. There is a dearth of research on conflict resolution strategies for DEW (with the exception of path planning and re-planning, e.g. Cai et al. 2016; Kayhani et al. 2018; Lei et al. 2014; Wang et al. 2011; Zhang and Hammad 2011), and the integration of project schedule in the generation and analysis of DEW.

### **2.7.3. Workspace Congestion Analysis**

Workspace congestion analysis is an important aspect of workspace planning. Workspace congestion occurs when the available workspace is either limited or smaller than the workspace required. This can occur even when there are no temporal or physical conflicts. The demand and supply of resources determine workspace congestion criticality for work execution (Chua et al. 2010; Dawood and Mallasi 2006; Winch and North 2006; Wu and Chiu 2010). Workspace congestion can also be determined by space utilization. Table 2.10 shows the central studies that developed equations for calculating workspace congestion. The space congestion equations proposed by the various authors (Chavada et al. 2012b; Chua et al. 2010; Dawood and Mallasi 2006; Winch and North 2006) are similar and consider space congestion as a ratio of the required space to available space. However, the work of (Semenov et al. 2014) extends the space congestion problem by considering that the workspaces may not always be utilized throughout the activity’s operation time. (i.e. the function  $v(w)$  represents the volume of the corresponding workspace, the notation  $(w_{i(n,k)})$  is used to emphasise that the workspace  $(w_i)$  is associated with the activity  $(n)$  and the related resource  $(k)$  only when the activity is performed).



Table 2.10: Workspace congestion equations from previous research

Author	Equation	Definitions
Dawood & Mallasi (2006)	$f (co) = \frac{\sum Total\ volume\ of\ space\ needed}{\sum Total\ volume\ of\ available\ space}$	$f (co)$ is the criterion function for the ratio of conflicting workspace volumes. The total volume of space needed represents the total volume of conflicts between 3D execution spaces of activities. The total volume of space available is the volume of all activity execution spaces.
Winch & North (2006)	$s = \frac{r}{a} \times 100$	Spatial loading (s) is the ratio of required space (r) to available space (a).
Chua et al. (2010)	$U_s = \frac{\sum Operator\ space}{Total\ boundary\ space}$	Spatial utilization ( $U_s$ ) is the intensity of a space imposed by an activity. Operator space is the amount of space necessary for the operator to perform an activity. Total boundary space refers to the amount of space depicting the activity space.
Chavada et al. (2012)	$CgS (\%) = \frac{\sum Required\ activity\ resources \times Unit\ volume}{Available\ workspace\ volume\ for\ activity}$	Workspace congestion (CgS) is the ratio between the volume for required resources and the volume available for activity execution.
Semenov et al. (2014)	$f = p_{nk} (t) = \{u_{nk} \frac{v_k}{v(w_{i(n,k)})} \frac{d_{nk}}{d_n} \text{ if } t_n \leq t < t_n + d_n$	Workspace congestion factor ( $w_{i(n,k)}$ ): This is obtained when units consume resources $u_{nk}$ with the corresponding spatial rate $v_k$ and operational time $d_{nk}$ . Where the function $v(w)$ is the volume of the corresponding workspace.
Saeedfar et al. (2016)	$D_{L \& E} = \sum Q \times (S_P + S_S)$	Space demand for labour and equipment ( $D_{L \& E}$ ) is the product of the number of resources (Q) and the sum of the safety space ( $S_S$ ) and performance space ( $S_P$ ).
Shang & Shen (2016)	$M_{SC} = \sum_1^K M_{SU_K}$	$M_{SU}$ is a $n \times m$ matrix representing the space usage of objects in the full construction stage. "n" denotes the number of space units, and m, the number of time divisions on a schedule. $M_{SC}$ is the congestion matrix that detects spatio-temporal collisions between multiple objects using identical space units at same time divisions.

#### **2.7.4. Resolution of workspace conflicts**

Workspace conflicts pose different challenges in a construction site, such as safety and productivity issues. Therefore, resolving workspace conflicts is an important consideration in construction planning. Workspace conflicts are closely related to space demands required to execute an activity safely. Akinici et al. (2002c) revealed that workspace conflicts occur when the space requirements for an activity interfere with one another or with work in place. According to Staub-French and Khanzode (2007), two main types of spatio-temporal conflict exist (a) hard conflict, interferences between physical components, and (b) soft conflict; interferences between different clearance volumes and workspaces. Wu and Chiu (2010) proposed a 4D workspace conflict detection and analysis system, providing a visualization environment to identify conflicts. However, their work relied on third-party systems and did not consider any resolution strategy to resolve the identified conflicts. Choi et al. (2014) suggested that to resolve workspace conflicts, the project manager should consider the workspace's movability, the criticality of an activity, the activity execution plan, and the material management plan. Moon et al. (2014c) added the process of conflict resolution, building upon their previous study on workspace management. They proposed using a genetic algorithm to minimize both spatial and temporal interferences (interference occurs where two or more activities share adjacent workspaces) and a workspace generation methodology based on an object and a surface-based workspace model using the 3D bounding box concept linked with Work Breakdown Structure (WBS) to facilitate conflict resolution.

Two broad strategies are identified in the literature for resolving workspace conflicts: (1) using mathematical models/ algorithms that involve examining the logical sequence of activities, decreasing the overlapping time between activities by reducing the duration of activities, changing the level of activity resources or changing construction methods (Bansal 2011), and (2) rule-based heuristics strategies that involve changing the direction of the workspace, modifying the location

and size of the workspace, dividing the workspace into smaller components and delaying the start date of activities based on their float time (Kassem et al. 2015). Related studies in workspace conflict detection and resolution strategies are presented in Table 2.11. Some studies assumed there were no schedule conflicts and, therefore, did not explicitly consider them (Hammad et al. 2007; Lai and Kang 2009). The resolution strategies proposed in such studies were focused on resolving conflicts due to the interferences between physical components and their workspaces. For ease of reference, the workspace definitions proposed in Table 2.9: Proposed workspace definitions have been used in describing the type of space in consideration in Table 2.11.

Table 2.11: Related studies on workspace conflict and resolution

Author	Type of Space	Conflict detection		Conflict resolution approach	
		Schedule Conflict	Workspace Conflict	Mathematical models/ Algorithms	Rule-based heuristic
Song and Chua (2005)	Path space		✓		✓
Dawood and Mallasi (2006)	Process ws		✓		✓
Hammad et al. (2007)	Equipment ws		✓	✓	
Lai and Kang (2009)	Equipment ws and Product ws		✓	✓	
Mallasi (2009)	Process ws		✓	✓	
Chua et al. (2010)	Labour ws	✓	✓	✓	
Bansal (2011)	Process ws	✓	✓		✓
Zhang and Hu (2011)		✓	✓		✓
Chavada et al. (2012b)	Process ws	✓	✓		✓
Dang and Bargstädt (2013)	Process ws	✓		✓	
Choi et al. (2014)	Process ws	✓	✓		✓
Kim and Teizer (2014)	Equipment ws		✓	✓	
Kim and Fischer (2014)	Process ws	✓		✓	
Lucko et al. (2014b)	Process ws	✓			✓
Moon et al. (2014a)	Process ws	✓	✓		✓
Semenov et al. (2014)	Process ws	✓	✓	✓	
Su and Cai (2014)	Process ws		✓	✓	
Kassem et al. (2015)	Process ws	✓	✓		✓
Said and Lucko (2016)	Process ws	✓		✓	
Isaac et al. (2017)	Path space	✓		✓	
Mirzaei et al. (2018)	Process ws		✓	✓	
Getuli and Capone (2018)	Object ws		✓		✓
Rohani et al. (2018)	Process ws	✓	✓		✓
Semenov et al. (2018)	Process ws	✓		✓	
Su and Cai (2018)	Process ws	✓		✓	
Wang et al. (2018a)	Labour WS		✓		✓
Jin et al. (2019)	Process WS		✓	✓	

### **2.7.5. Advanced Workspace Visualization Tools**

Visualization technologies (e.g. BIM, 4D CAD, virtual prototyping, virtual reality and augmented reality) play an important role in construction workspace management to facilitate the detection and analysis of spatio-temporal clashes (Dodds and Johnson 2012; Patel 2015). Several research works developed some advanced visualization tools for visualizing workspaces (Table 2.12).

The development of advanced visualization tools facilitates workspace planning and conflict visualization. However, these tools are special-purpose tools, mainly for research purposes and not commercially available. A summary of studies carried out on workspace management and planning within the last decade relevant to this research work is shown in Table 2.13. A glance at the table shows that most of the reviewed studies were in the vertical construction domain and utilized the 3D model for workspace generation and allocation; however, the conflict visualization was performed based on the 4D model. Also, the type of space considered in the reviewed studies have been “normalized” for ease of comparison based on the workspace definitions proposed in this study.

Table 2.12: Related studies on advanced visualization for construction workspaces

Author	Tool	Description
Dawood and Mallasi (2006)	PECASO	PECASO (patterns execution and critical analysis of site space organization). The tool utilized a structured query language (SQL) to organize the product's coordinates to the required execution sequence and a layer in AutoCAD to assign workspaces.
Winch and North (2006)	AreaMan and SpaceMan	AreaMan is a 2D tool for calculating the areas of available space, while SpaceMan facilitates the identification of critical spaces and their relationship to the critical path. It can also suggest ways of resolving conflicts in the process of Space-Time brokerage.
Huang et al. (2007)	DSS	Dessault Systems Solutions (DSS) facilitated the 3D visualization and animation of a construction plan. The tool allowed project planners to rehearse and analyze the activity sequence to ascertain the presence of conflict.
Kamat and Martinez (2007)	C-COLLIDE	This tool was developed to provide users with comprehensive feedback on workspace conflict among static (e.g. idle equipment), dynamic (e.g. active equipment), and abstract (e.g. hazard or protected areas) construction resources in dynamic 3D construction process visualizations.
Borrmann et al. (2009)	ForBAU	The tool was developed as a virtual representation of the construction site that formed the basis for simulating the construction process to identify potential problems early
Lai and Kang (2009)	VC-COLLIDE	The tool identified static and dynamic conflicts by rehearsing the sequence of construction activities to detect spatio-temporal clash.
Zhou et al. (2010)	"Computer supported collaboration work" (CSCW)	The developed tool supports enables construction planners to review construction plans with a 4D simulation model.
Bansal 92011)	Animation manager	The animation manager facilitated conflict resolution using the Total Float (TF) adjusting activity space demand by changing the locations of conflicting spaces or dividing the originally assigned spaces into smaller parts.
Chavada et al. (2012b)	nD planning	The prototype tool enables the management of AEW in real-time mode within a 5D environment.
Moon et al. (2014a)	Workspace conflict visualization system (WoCoViS)	A visualization system that simulates the 4D object of workspace conflicts based on schedule data
Moon et al. (2014b)	4D workspace conflict detector (4D-WCD)	The system consists of a workspace generation module, workspace allocation module, workspace overlapping analysis module and a 4D simulation module.
Moon et al. (2014c)	BIM-based schedule workspace optimization system (BIM-SWACOS)	This tool comprises five modules: CPM schedule generation module, workspace information generation module, schedule workspace interference analysis module, GA-based schedule workspace interference module, and 4D simulation module of workspace interference.
Su and Cai (2018)	Graphical planning method (GPM)	The developed tool is a workspace aware tool that facilitates workspace planning and visualization by incorporating workspace requirements into the modelling process. It, however, lacks resolution strategies for detected workspace conflict

Table 2.13: Recent literature on workspace management in construction projects

Author	WS Classification	WS generation & allocation		Space Type(s) Considered	Conflict detection		Conflict Resolution		Conflict Visualization		Area of Application	
		3D	4D		SC	WSC	MM/A	R-B H	3D	4D	VC	HC
Chua et al. (2010)	✓		✓	Labor	✓	✓	✓			✓	✓	
Wu and Chiu (2010)	✓	✓		Process		✓		✓	✓		✓	
Bansal (2011)		✓		Process	✓	✓		✓		✓	✓	
Zhang and Hu (2011)			✓	Process	✓	✓		✓		✓	✓	
Chavada et al. (2012b)	✓	✓		Process	✓	✓		✓		✓	✓	
Choi et al. (2014)	✓		✓	Process	✓	✓		✓		✓	✓	
Moon et al. (2014a)			✓	Process	✓	✓		✓		✓	✓	
Moon et al. (2014c)			✓	Process	✓		✓			✓	✓	
Kim and Fischer (2014)		✓		Process	✓		✓		✓		✓	
Semenov et al. (2014)		✓		Process	✓	✓	✓			✓	✓	
Su and Cai (2014)			✓	Process		✓	✓			✓	✓	
Kassem et al. (2015)			✓	Process	✓	✓		✓		✓	✓	
Zhang et al. (2015b)	✓	✓		Process ws		✓		✓		✓	✓	
Shang and Shen (2016)		✓		Process		✓	✓			✓	✓	
Mirzaei et al. (2018)		✓		Labour and Object ws		✓	✓			✓	✓	
Getuli and Capone (2018)		✓		Object ws		✓		✓		✓	✓	
Rohani et al. (2018)		✓		Process ws	✓	✓	✓			✓	✓	
Semenov et al. (2018)		✓		Process ws		✓	✓		✓		✓	
Su and Cai (2018)		✓		Process	✓		✓			✓	✓	
Wang et al. (2018a)			✓	Labor ws		✓		✓		✓	✓	
Jin et al. (2019)		✓		Process ws		✓	✓		✓		✓	
Proposed approach	✓		✓	Equipment & Process	✓	✓		✓		✓		✓
<b>Legends</b>												
WSC= Workspace conflict (Physical conflict, i.e. interferences between physical components of the workspace)				SC= Schedule conflict WGA= Workspace congestion analysis MM/A= Mathematical models/Algorithms				R-B H= Rule-based heuristics VC= vertical construction HC= Horizontal construction				

## **2.8. Construction Planning**

The main aim of any project is to deliver the highest value to all stakeholders, including the end-users, by reducing or eliminating wastes. The project must satisfy some basic requirements such as time, cost, quality, and scope. Construction planning, therefore, involves multi-criteria decision making, fundamental to the success or otherwise of a project. To address these decision problems, a wide variety of methods, techniques and tools have been developed during the last decades. Some of these methods, techniques and tools have been extensively reviewed in some review papers (Antunes et al. 2015; Herroelen 2005; Herroelen and Leus 2004; Zhou et al. 2013). Methods of project planning and scheduling have evolved over the years from the traditional planning approach based on deterministic networks to more sophisticated approaches based on probabilistic methods (Al Nasser et al. 2016). De Falco and Falivene (2009) provided some examples of traditional planning methods, which include the Gantt chart, Critical Path Method (CPM), and Programme Evaluation and Review Techniques (PERT). They further asserted that the simplifying hypothesis on which the traditional planning approaches are generally based has often compromised the degree to which they reliably represent the real problem faced on construction sites. In more recent times, over the last few decades, technological advancement have witnessed the gradual introduction of more integrated computer-based methods capable of handling potential uncertainties to produce more reliable schedules (Lee and Rojas 2010).

Project planning presents a variety of decision problems broadly classified into project representation, project scheduling, resource allocation and risk analysis (Pellerin and Perrier 2019). Project scheduling is an integral part of the planning process and is typically understood as a full process itself. Project scheduling is concerned with networking activities and the duration associated with them to forecast the project's duration and avoid potential delays. In elevated urban highway projects, project delays may be attributable to the prevalence of non-value adding activities. Poor planning and unreliable schedule were revealed as essential factors responsible

for promoting LC wastes in highway projects (Heyl, 2015; Nazeck et al., 2008). Wodalski et al. (2011) claimed that by examining the root causes of delays in highway projects, it was easy to see how the choice of the selected planning and scheduling method contributed to the LC wastes.

Construction planning methods are broadly classed into bar charts, network-based methods such as the CPM and Linear Scheduling Methods (LSM) such as the Line of Balance (LOB). Although the CPM has been widely used for planning and scheduling, it has been recognized as unsuitable for repetitive construction projects such as highways (Sharma and Bansal 2018; Zhang 2015) and does not ensure resource continuity nor considers spatial requirements. LSM was developed to counter the limitation of the CPM in scheduling repetitive activities typified in highway projects. However, Zhang (2015) reveals that the LSM ignores workers' learning effect by assuming crew productivity is unchanged and cannot accommodate non-typical and non-repetitive activities. Sharma and Bansal (2018) compared network-based methods and linear scheduling methods; however, they asserted that LSM is not popular among project planners as the method has been focused on concept development rather than actual implementation. A critical consequence of poor planning and scheduling, especially in elevated urban highway projects, is manifested in the form of spatio-temporal issues. It, therefore, becomes essential to adopt a formalized method in selecting the scheduling technique to adopt. Selecting the specific type of schedule to be used is a multi-criteria decision-making problem as there are different factors to consider to ensure that the selected method matches the project requirement.

### **2.8.1. Multi-Criteria Decision-Making Methods (MCDM)**

MCDM methods cover a wide range of quite distinct approaches (Zavadskas et al., 2014). According to Løken (2007), the available methods can be categorized into three areas: value measurement models (e.g. Weighted Sum Model, Analytical Hierarchical Process), goal, aspiration and reference level models (e.g. TOPSIS) and Outranking models (e.g. ELECTRE, PROMETHEE). Arroyo (2014) added a new category, which is Choosing by Advantage (CBA),



developed by Jim Suhr (Suhr 1999). The basic principle of all MCDM methods is to generate or formulate a decision table/ hierarchy, and this is achieved through a systematic method (Bhushan and Rai, 2007; Dodgson et al., 2009; Srinivasa and Kuma, 2014) that involves defining the problem and establishing the decision context, identifying the decision options, determining the requirements and establishing the alternatives, criteria and sub-criteria and developing the evaluation criteria.

A large number of works have been conducted which facilitates the evaluation of the characteristics of different MCDM methods (Albiñana and Vila 2012; Antucheviciene et al. 2011, 2012; Baležentis et al. 2012; Kou et al. 2012; Peng et al. 2011; Stanujkic et al. 2012), their development, applications and ability to help solve practical problems. There is, however, no unique and well-defined methodology that decision makers could follow step-by-step from the beginning to the end of a decision-making process (Zavadskas et al. (2014). More recently, one or more MCDM techniques (hybrid method) have been applied in the construction management domain to make the decision-making process more robust (Erdogan et al. 2017; Temiz and Calis 2017). Zavadskas et al. (2016) claim that hybrid MCDM involves various combinations of several decision-making methods and accounts for about 11% of the total papers on developments and applications of MCDM techniques within the past decade. They further reveal that the most popular methodological hybrid MCDM approaches are combinations of MCDM with strong mathematical background, e.g. Analytical Network Process (ANP) or Analytical Hierarchical Process (AHP) with other methods. Two MCDM methods will be briefly highlighted in the following sections.

#### *2.8.1.1. Analytical Hierarchical Process (AHP)*

The AHP is a decision-making strategy used to compare alternatives on given criteria based on assigning priority weightings to the alternatives (Saaty and Roseanna 1987) and has been extensively applied in research to solve decision-making problems construction management domain (Balubaid and Alamoudi 2015; Erdogan et al. 2017). The major characteristics of the AHP

are the use of pair-wise comparisons to compare the alternatives concerning the various criteria and to estimate criteria weights based on expert judgement (Løken 2007). It is the most widely applied MCDM method in construction management (Darko et al. 2018; Jato-Espino et al. 2014; Mardani et al. 2015) due to its systematic and straightforward implementation steps (Al-Harbi 2001; Dobi et al. 2010; Fong and Choi 2000). There are various justifications for using the AHP in construction management, and the extant literature on the application of AHP reveals three main justifications for applying this method. The AHP does not require a statistically significant large sample size to achieve sound and statistically robust results since it is based on expert judgement (Abudayyeh et al. 2007; Tavares et al. 2008). Some studies used sample sizes ranging from four to nine (Akadiri et al. 2013; Chou et al. 2013; Hyun et al. 2008; Lam et al. 2008; Pan 2008; Pan et al. 2012; Zhang and Zou 2007; Zou and Li 2010). Only a few studies used sample sizes greater than 30 (Ali and Al Nsairat 2009; El-Sayegh 2009).

Darko et al. (2018) revealed that the AHP consists of three steps: (1) hierarchy formulation- the first level of the hierarchy contains the decision goal, while the subsequent levels represent the breakdown of the decision criteria, sub-criteria and alternatives for reaching the decision goal; (2) pairwise comparison between criteria at the second level of the hierarchy; and verification of consistency using a Consistency Ratio (CR). AHP has been proved to reduce bias and ensure subjective judgments that are validated using consistency analysis. It can use both subjective and objective data for proper decision making, and this capability makes it essential for construction-related decision making (Abudayyeh et al. 2007; Hsu et al. 2008). The procedure required for the AHP as proposed by Saaty (1980, 1987) includes the following steps:

- 1) Pairwise comparison is determined for each level of the AHP by constructing a matrix for the pairwise elements using a table of relative scores (Table 2.14).
- 2) The values in each column of the pairwise matrix are summed; after that, each element of the matrix is divided by its column total to generate a normalized pairwise matrix.

- 3) When all the normalized pairwise comparisons are made, the relative priority vectors, also known as the criteria weights  $w$ , are calculated by finding the row averages.
- 4) The consistency of comparison is determined by using the eigenvalue ( $\lambda_{max}$ ) to calculate the consistency index (CI),  $[CI = (\lambda_{max} - n) / (n - 1)]$  where  $n$  is the number of criteria. The consistency ratio (CR) is then calculated by dividing the CI by the appropriate value of the random index (RI) (Table 2.15). A perfectly consistent decision-maker should always obtain  $CI = 0$ , but small values of inconsistency may be tolerated if  $\frac{CI}{RI} < 0.1$ .
- 5) If CR does not exceed 0.10, it is acceptable, but if it does, the judgment matrix is inconsistent and should be reviewed and improved.

However, the AHP can be subject to inconsistent judgement and criteria ranking and has often been criticized for its inability to handle uncertain and imprecise decision-making problems.

Table 2.14: Table of relative scores

Value of $a_{jk}$	Interpretation
9	$j$ is extremely more important than $k$
8	
7	$j$ is strongly more important than $k$
6	
5	$j$ is more important than $k$
4	
3	$j$ is slightly more important than $k$
2	
1	$j$ is equally important as $k$

Table 2.15: Random Index (RI)

Size of matrix (n)	1	2	3	4	5	6	7	8	9	10
Random consistency	0	0	0.58	0.90	1.12	1.24	1.32	1.41	1.45	1.49

### 2.8.1.2. Choosing by Advantage

The CBA is a collaborative MCDM method developed by Suhr (1999) that helps project stakeholders reach a consensus regarding preferred alternatives. It is based on differentiating the alternatives by summarizing their advantages and introducing the subjective part of the decision at the end of the process by weighing the importance of the advantage (Arroyo et al. 2014). This

technique has been applied in MCDM problems in the construction industry involving contractor selection (Demirkesen and Bayhan 2019; Karakhan et al. 2018), safety planning (Karakhan et al. 2016; Nnaji et al. 2018; Zuluaga et al. 2018), choice of building design (Arroyo et al. 2015, 2016a; b; Kpamma et al. 2016; Parrish and Tommelein 2009), construction method (Martinez et al. 2016; Murguia and Brioso 2017), and type of contract (Haapasalo et al. 2015; Schöttle and Arroyo 2016). CBA is more transparent and presents several benefits than traditional MCDM methods (Arroyo 2014) and has been shown to reduce group decision time and stakeholders' frustration compared to the weighted sum method (Arroyo et al. 2016a). Table 2.16 presents a glossary of terms relevant to the CBA method (Suhr 1999).

Table 2.16: CBA definitions (Suhr 1999)

Term	Definition
Alternatives	Options to be considered by the method. At least two alternatives are required for a decision to be necessary.
Factor	A property of an alternative that is material to the decision. Factors can be social or environmental but do not include the cost
Criterion	The “Want” criterion defines a specific value or set of values that are preferred for a factor. “Must have” criterion specifies values that a factor must have for that alternative to be considered feasible.
Attribute	Quality or characteristics belonging to one alternative.
Advantage	Difference between two alternatives when their attributes are compared

In implementing the CBA method, the following steps are followed (Arroyo et al. 2015):

- (1) Identify the alternatives for consideration in the decision process.
- (2) Define the factors that will help differentiate among alternatives.
- (3) Define the *must* and *want* criteria for each factor.
- (4) Summarize the attributes of each alternative.
- (5) Decide the advantages of each alternative.
- (6) Decide the importance of each advantage (lofA). The lofA corresponds to a value that is given for each factor for each alternative. The sum of the lofA for all factors represents the total importance of that alternative to the decision maker.

## **2.9. Micro-Level Space Planning**

Micro-level space is the area required within the proximity of the component being installed. This space also includes the construction component/product being installed and the labour and equipment required (Akinci et al. 2002). Different methods have been proposed for micro-level space planning. A prototype system for assessing micro-level spatial constraints existing within the construction schedule was proposed (Thabet et al. 1992). This approach proposed the use of scheduling in two stages, resource-based scheduling and space-based scheduling. During the space-based scheduling methodology, the demand for space required during the activity execution was compared against the space availability for selected work areas. Riley (1994) built on this approach to develop a construction space model to describe the construction space needed to execute a task. The construction space model was expanded to include the definition of various space behaviour patterns, which described how labour resources used space over time (Riley and Sanvido 1997). Akinci and Fischer (2000) developed a mechanism for capturing micro-level activity space requirements at a general level through space templates related to construction models, while Mallasi and Dawood (2001) attempted to model the dynamic nature of construction operations using the space breakdown structure (SBS) that allowed the visualization of discrete work execution patterns for various tasks in a modelling environment.

A more dynamic micro-level workspace by integrating a scheduling tool with a CAD tool to enable a construction planner to develop spatial layouts of the construction site was developed (Guo 2002). This system could identify spatial conflicts as well as the severity of the conflict. Space conflicts were measured based on the degree of overlap of the space and duration of the overlap. Once a space conflict was identified, the system employed a strategy of either amending the space demand of the activity or adjusting the schedule. Akinci et al. (2002) proposed the idea of including workspace planning and representation in 4D simulations to detect and analyze, categorize and prioritize potential time-space conflict, North and Winch (2002) suggested the use

of Critical Space Analysis (CSA) as a means of determining the amount of conflict existing between workspaces where the amount of space needed by resources executing a task is compared to the amount of space available to complete the task. Conflict resolution was by either adjusting the schedule or changing the space demand. Choi et al. (2014) proposed a framework for micro-level space planning that considers each activity's spatial feature. The framework consisted of five phases, including the 4D model generation, workspace requirements identification, workspace occupation representation, workspace conflict identification and resolution.

Other research efforts, mainly in the domain of vertical construction, have been carried out in the domain of space planning, but they have mostly been focused on macro-level space planning and have advocated the use of space templates to represent the dimensional properties of space objects. A significant limitation of this approach lies in its inability to represent the dynamic nature of the workspace required during task execution. Planning micro-level space is challenging to achieve due to its dynamic nature and becomes increasingly so with short-duration activities.

### **2.9.1. Equipment Space Planning**

The space required by construction equipment is primarily dependent on the construction method being used, the type of equipment selected, and the nature of the activity to be carried out. According to Tantisevi and Akinci (2007), a significant challenge in modelling workspace requirements of cranes stems from the dynamic operation of crane operation. Although cranes are typically located at fixed places, some parts, such as their booms and hooks, move during operation. These movements result in changes in the workspace requirements of cranes over time during a given operation. For example, the location and shape of the lift of a crane will define the required lifting zone (Figure 2.12 adapted from Kobelco 2011) that should be covered by changing the length and angle of the boom of the crane.

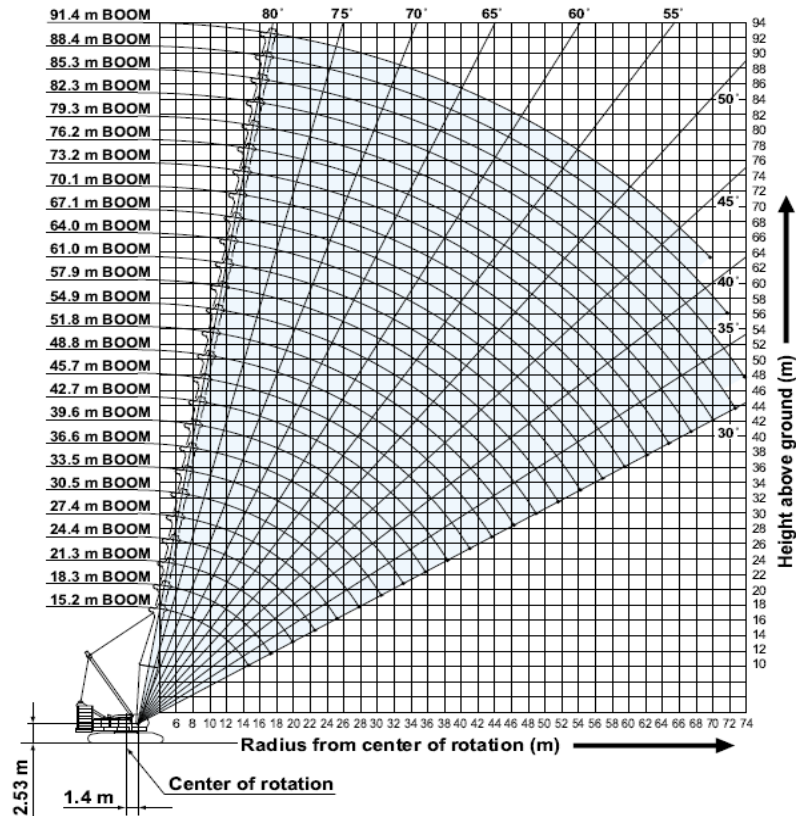

Figure 2.12: Working ranges and lifting capacities of a 120T crawler crane (adapted from Kobelco 2011)

Hammad et al. (2007) revealed that spatial constraints might limit the crane boom's length and angle in some rehabilitation projects. These constraints impose a specific construction method, such as using two cooperative telescopic cranes instead of one larger straddle crane. They further revealed that the complex relationships between the lifting capacity of a crane and its dimensions make it important to carefully consider the workspaces used in the spatial analysis of projects requiring cranes. Cranes are one of the essential pieces of equipment on sites, must be selected based on their respective life-capacity charts typically produced by crane manufacturers as a guide only. The selection of the appropriate equipment facilitates the planning of the required workspace. The equipment workspace for most activities follows specific evolution patterns. The concept of workspace evolution patterns is to ascertain the characteristics of construction activity with its space usage. These patterns depend on the construction method, nature of the task being performed and the planning Level of Development (LOD). The nature of

the task being performed by the equipment is a function of the overall space, which also includes the physical and hazard space. For instance, the space required for the installation of a precast bridge deck is illustrated as:

$$Workspace = Product_{Space} + Equipment_{Space} + Operation_{Space} + Facilities_{Space}$$

The product<sub>space</sub> includes the bridge component for installation, the operation space includes the space for the installation or deconstruction activity, labour space, lay down space, the equipment space includes the path space, equipment workspace, safety/hazard space, while the facilities space includes the space for site facilities. The primary consideration of this research is planning equipment workspace for different activities (especially activities on the critical path), and the activity workspace evolution pattern can be represented as:

$$Activity_{Workspace} = Object_{Space} + Equipment_{Space}$$

Su (2013) revealed that due to the different types of construction equipment available, there are no standard rules to suggest that when using a specific piece of plant, a pre-determined space will be required. Without this information, a full spatial analysis of micro-level equipment spaces cannot be carried out. One way to counter this limitation is by utilizing information available in crane databases (e.g. D-Crane) or use the equipment database available in commercial 4D software.

### **2.9.2. Level of Development (LOD) Approach for Equipment Space Planning**

A Building Information Model (BIM) has different dimensions with specific purposes such as the 3D model, used to represent geometries of model elements (e.g. doors, columns, beams) 4D model, related to planning by adding the time element to show how the project evolves with time,



5D model, related to the cost aspects of the projects for cost estimation, analysis and budget monitoring, 6D model, related to sustainability by analyzing the energy consumption of a building for and energy efficiency, and the 7D model containing detailed operations and facility management information. Botton *et al.* (2015) claimed that the term Level of Development (LOD) is widely used in the BIM approach to show that detailing should comprise geometric and non-graphical information. The BIM Acceleration Committee (2016) revealed that the basis for the concept of LOD is the recognition that model elements evolve at different rates throughout the design process. It follows that LOD should only be used to describe model elements, not models as a whole. Different design disciplines and project organizations require different information to be available at project milestones.

For this reason, several organizations have introduced further terms such as Level of Detail (graphic oriented), Level of Information (non-graphic oriented), Level of Accuracy (tolerance-oriented), and Level of Coordination (collaboration oriented)(BIM Acceleration Committee 2016). As the range of options for specifying LOD requirements increases, so does the complexity of defining requirements, and the challenge is to achieve actual added project value using such approaches (Hooper 2015). According to Trelidal *et al.* (2016), the concept of LOD allows for a simple approach for specifying the requirements for the content of object-oriented models in a BIM process. LOD is sometimes referred to or interpreted as Level of Detail rather than Level of Development. There are important differences. **Level of Detail** is a measure of the amount of information provided. Because it is only a measure of quantity, the underlying assumption is that all provided information is relevant to the project and can be relied upon with certainty. **Level of Development** is the degree to which the element's geometry and attached information have been thought through – the degree to which project team members may rely on the information when using the model. Level of Detail can be thought of as an input to the element, while the Level of Development is reliable output (BIM Acceleration Committee 2016).

Kensek (2014) claimed that the subject of LOD had received attention from researchers and practitioners in the BIM domain, including the American Institute of Architects (AIA). They developed AIA E202, a document that provides guiding principles about the BIM model and the LOD relationship with the proposed use of the model at every project stage. The LOD requirements for the different dimensions of the BIM model need to be adequately defined to ensure a common understanding of the requirements for successful project delivery, especially in 4D models that define the linkage of the construction schedule with the 3D model and show how the project evolves with time. Planning the micro-level space requirement for heavy equipment requires a more detailed approach as it focuses on the interaction of the construction schedule with the 3D model (Akinci et al. 2002) and simulation (Heesom 2004; Mallasi 2006; Winch and North 2006; Wu and Chiu 2010). Therefore, it is required that both the 3D model and the schedule are at a sufficient LOD to ensure that the simulation is realistic. Adopting the LOD approach for equipment workspace entails matching the schedule LOD with the process model and construction method for the construction activity to arrive at a product model at a high LOD to facilitate the planning, visualization and representation of equipment workspace. The LOD specification in 4D models should, therefore, be able to manage both the graphical level of details and the temporal level of information (Heesom and Mahdjoubi 2004) and must be such that it can facilitate effective construction processes (Guevremont & Hammad 2019).

The graphical LOD includes LOD 100-concept design, LOD 200-schematic design, LOD 300-detailed design, LOD 350-construction document, and LOD 400-fabrication and assembly (BIMFORUM 2019), while the temporal LOD is defined by the construction schedule LOD. Stephenson *et al.* (2010) defined five LOD's of the construction schedule, and Ballard and Howell (2003) defined four schedules LOD. Regardless of the schedule, LOD defined, the schedule LOD needs to match the 3D LOD to ensure a more realistic 4D simulation. This is particularly important since a 4D simulation should be continually used, evaluated and refined as the project progresses (Umar et al. 2015), since the real contribution of 4D simulation is in the visual interest it offers to

professionals to visualize spatial aspects of the construction process (Heesom and Mahdjoubi 2004). Butkovic et al. (2019) claimed that 4D-LOD needs to be defined to provide more dynamic 4D simulations. Guevremont & Hammad (2019) proposed five 4D-LOD (LOD A: demonstrative/summary, LOD B: major work coordination and feasibility, LOD C; contractual baseline at the time of bid, LOD D: operational fieldwork, and LOD E: Detailed equipment movements and workspaces) for major capital construction projects.

In urban highway projects requiring heavy construction equipment, it becomes crucial to adopt the LOD approach to facilitate the planning, visualization and representation of equipment workspace to avoid unnecessary project delays to spatio-temporal conflicts. Adopting the LOD approach for equipment workspace entails matching the schedule LOD, the process model, and the construction method for the construction activity to arrive at a high LOD product model. The 4D-LOD proposed by (Guevremont and Hammad 2019) is adapted for this study; Figure 2.13 shows an example of the different stages of the LPS, the product model, the process models and the resultant 4D-LOD used in this study.

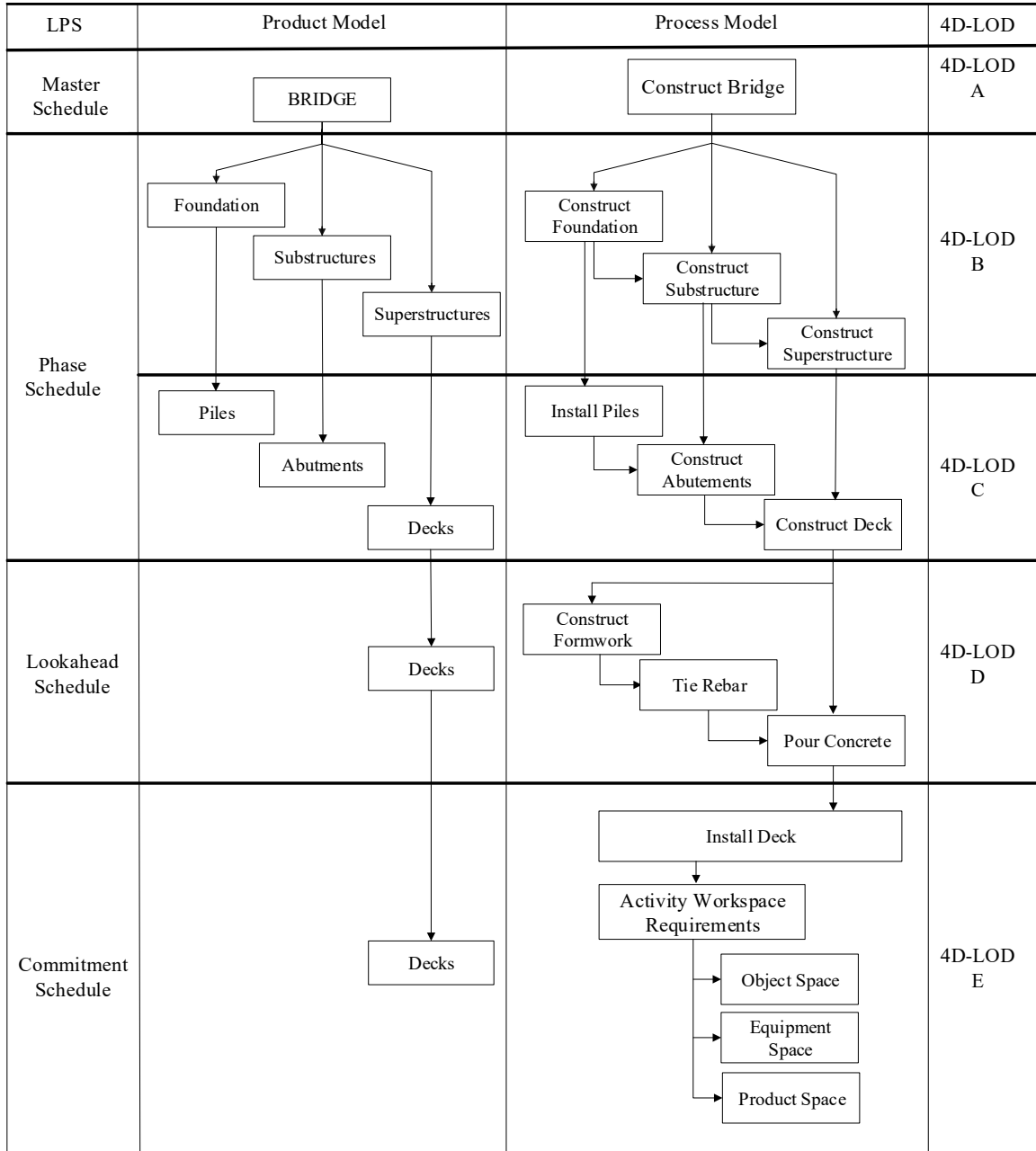

Figure 2.13: LOD approach for equipment workspace planning

## 2.10. Summary

This chapter provided an overview of LC techniques and tools and how they can be applied to infrastructure projects. A critical criterion for extending lean construction to infrastructure projects is integrating it with technology such as BIM, but this is not without challenges. The integration of

lean and BIM in infrastructure highway projects to enhance value and reduce waste is an emerging area of research expected to enhance construction projects' successful delivery in this domain.

One area where LC tools and techniques can help improve the productivity of infrastructure projects is in micro-level space equipment workspace planning for short duration activities. Commitment planning is an essential aspect of micro-level space planning due to the high Level of Detail (LOD) required to succeed. Moreover, the requirements for a short duration schedule in large and complex projects in the urban area present a whole new challenge in designing the workspace. A significant limitation in existing research in this area is their inability to consider the dynamic nature of equipment workspace requirements. The detection of spatio-temporal conflicts between equipment workspace and product space in infrastructure projects have received relatively little attention. Recently, some research efforts have focused on using 4D simulations to detect time-space conflicts, but these efforts have failed to account for the dynamic nature of equipment workspace subject to micro-scheduling. Another problem existing research has failed to address the level of detail (LOD) required in a 4D model for workspace planning. This is an important consideration to ensure that the model adheres to what is obtainable in real-life construction projects. However, one crucial consideration in determining the LOD of 4D models is ensuring the 3D model has been developed enough to match the LOD of the schedule.

## **CHAPTER 3 : OVERVIEW OF PROPOSED RESEARCH METHOD**

The previous chapter provided a review of LC, criteria for LC and the tools and techniques required to apply to highway projects. Wastes associated with LC were also elucidated. The importance of 4D models in construction was highlighted and challenges faced in the dynamic space planning, and the inability of current research to dynamically model equipment workspace requirements for short-duration activities. The focus of this chapter is to present an overview of the proposed research method (Figure 3.1) aimed at (1) prioritizing the main contributory factors promoting lean wastes using a multi-criteria decision-making approach to highlight the need for more effective planning, (2) develop an approach for equipment space planning by focusing on micro-scheduling using the last planner and 4D simulation (3) specify the LOD requirement for equipment space planning, and (4) develop a framework for integrating the LPS and 4D modelling for micro-scheduling of heavy construction equipment.

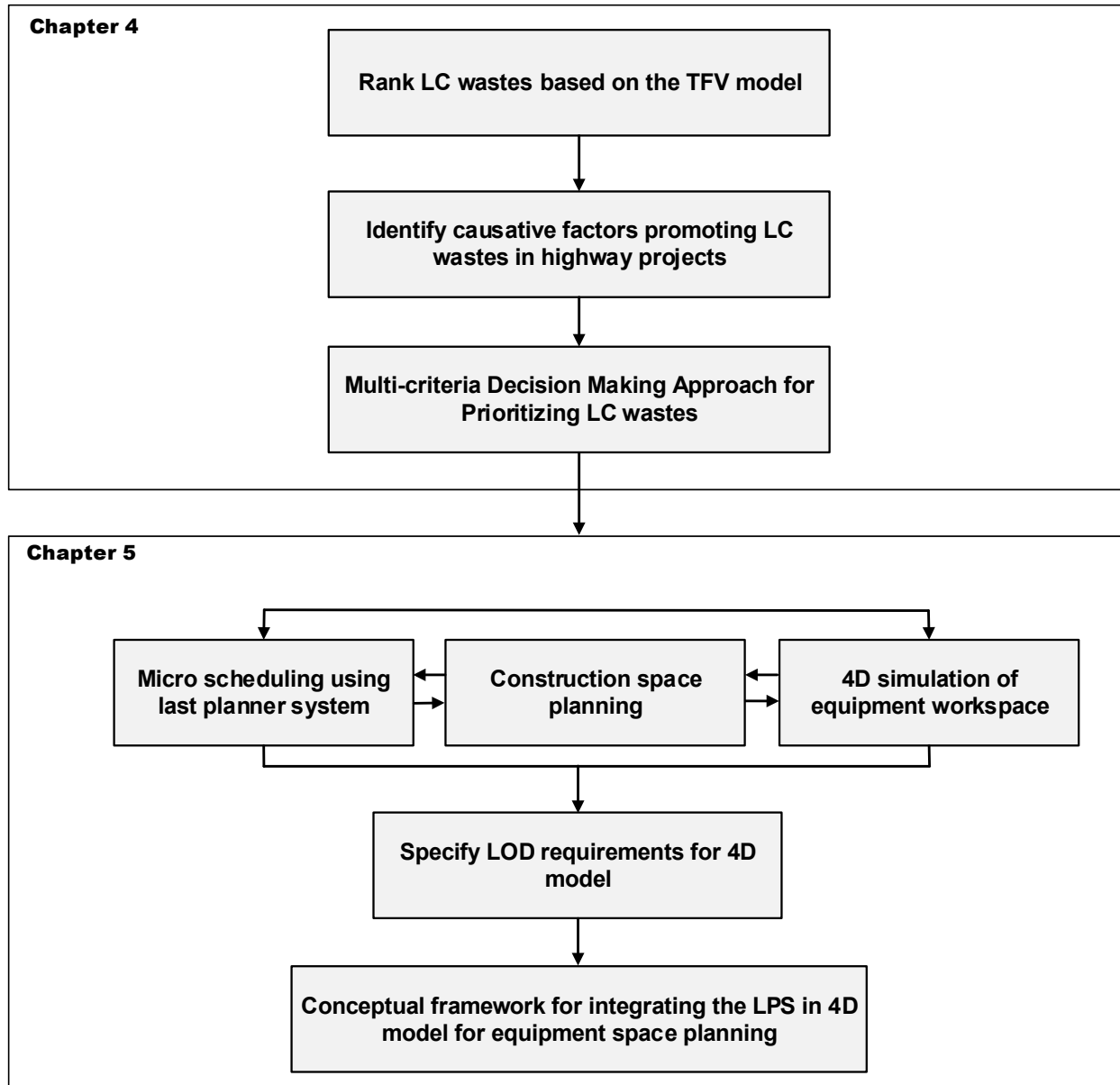

Figure 3.1: Overview of research methodology

### 3.1. Categorization and Prioritization of LC Wastes

Two of the research objectives (objectives 3 and 4) were realized starting from a theoretical approach; this formed the basis of ranking the LC wastes based on their degree of influence on the TFV process. After that, the factors responsible for promoting LC wastes in urban highway projects were categorized based on the TFV and priority weights assigned. A means of reducing

the highest-ranked waste in the transformation phase using a multi-criteria decision-making technique. The categorization of the factors promoting LC wastes broken down in a hierarchical format facilitates applying a hybrid MCDM approach by applying the Analytical Hierarchical Process (AHP) and the Choosing by Advantage (CBA). The goal of the AHP in this research is to obtain priority weights for factors promoting LC wastes. After that, CBA was applied to select the best alternative to reduce one of the identified factors promoting LC wastes and elucidate its implication for elevated urban highway projects. This component is presented in *Chapter 4*.

### **3.2. Process-Based Approach for Equipment Space Planning**

The development of a construction model integrating the product model and workspace requirements and considers the dynamic representation of equipment workspaces is an essential consideration for elevated highway construction projects. For a formalized equipment workspace planning process, creating the 4D model, workspace requirements identification, workspace occupation representation and workspace conflict resolution are important considerations.

The approach for developing a 4D model for equipment workspace planning, generation and representation in elevated urban highway projects comprises three distinct components: (i) micro-scheduling using the LPS, (ii) construction space planning using the PBS and LOD approach, and (iii) 4D simulation of activity workspace. These components will help create a framework highlighting the steps and requirements for creating a detailed 4D model with different LODs for equipment workspace planning. Process modelling was applied to facilitate the formalization of the framework. Process modelling is used to construct a formal representation of a process (Pawlewski and Hoffa 2014). Among the various existing languages for process modelling, Pereira and Silva (2016) claim that the business process model and notation (BPMN), event-driven process chain (EPC), unified modelling language activity diagrams (UML-AC), integration definition (IDEF), and role activity diagram (RAD) are the most common commonly used. A process model using the Integration Definition for Process Modelling (IDEF0) modelling



methodology is applied. It provides a means for modelling the functions (activities, actions, processes, operations) required by a system and the functional relationships and data supporting the integration of those functions (Dorador and Young 2000). This technique helps define the strategies to follow to facilitate a system's improvement by describing the information flow necessary to support each activity. It has been widely used in the research community due to its flexibility and clarity for modelling activities and information flows. The generic representation of the IDEF0 diagram, as proposed by Dorador and Young (2000), is shown in Figure 3.2. To plan the activity workspace for construction equipment, a context diagram (Figure 3.3) was created highlighting the process required to accomplish this.

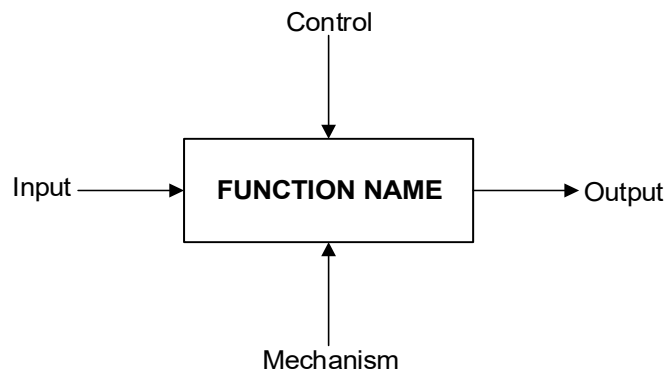

Figure 3.2: Representation of IDEF0

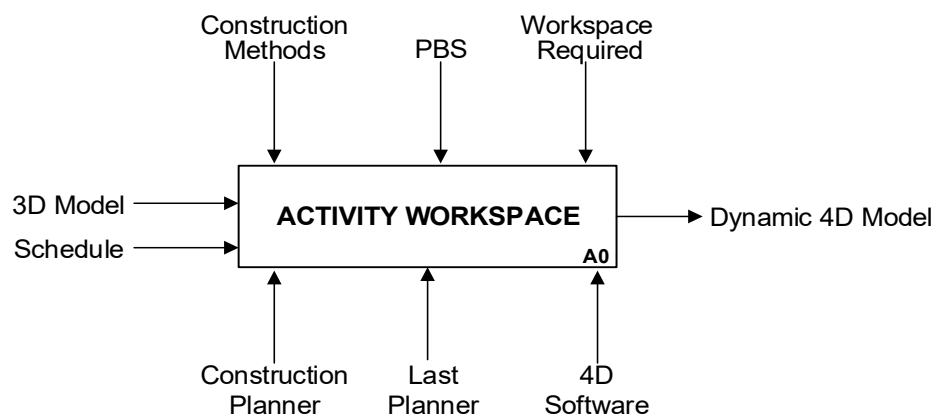

Figure 3.3: IDEF0 context diagram for equipment workspace planning

To facilitate workspace planning for this study, the construction method, the PBS of the 3D model and the workspace are required based on the selected construction method, and the product model would serve as the *control* to regulate the simulation. The contest diagram (Figure 3.3) will be decomposed into the following processes and subprocesses in *Chapter 5* :

- (i) Formalizing the PBS
  - Classification of the product group
- (ii) Scheduling construction activities
  - Create tasks for the product group
- (iii) Planning the activity workspace requirements using the LPS
  - Select product group
  - Create a lookahead plan
  - Update tasks and dependencies
- (iv) Visualizing the equipment workspace
  - Generate equipment workspace
  - Spatio-temporal analysis
  - 4D visualization of activity workspace

### 3.3. Summary

This chapter presented an overview of the proposed methodology for integrating the LPS and detailed 4D modelling for equipment workspace planning in elevated urban highway reconstruction projects. Two main components were identified as being relevant to realizing the proposed methodology: (1) categorizing and prioritizing LC wastes to highlight the need for better planning, and (2) developing an approach for equipment workspace planning using the IDEF0 modelling approach to elucidate the inputs, processes and outputs required to facilitate planning equipment workspaces. The following chapters will focus on expatiating the research methodology.

## **CHAPTER 4 : RANKING AND CATEGORIZATION OF LEAN CONSTRUCTION WASTES**

The prevalence of wastes in the construction sector has been touted as one of the major causes of low productivity. However, research efforts in this area have mainly been focused on Construction and Demolition Waste (CDW). Two of the research objectives will be addressed in this chapter.

- Rank the LC wastes based on their influence on the transformation, flow and value processes in construction.
- Categorize and rank the factors that promote LC wastes in urban highway projects based on the TFV model and propose a two-step multi-criteria decision-making method to formalize project scheduling techniques in elevated urban highway projects.

The methodology flowchart to achieve these objectives is shown in Figure 4.1.

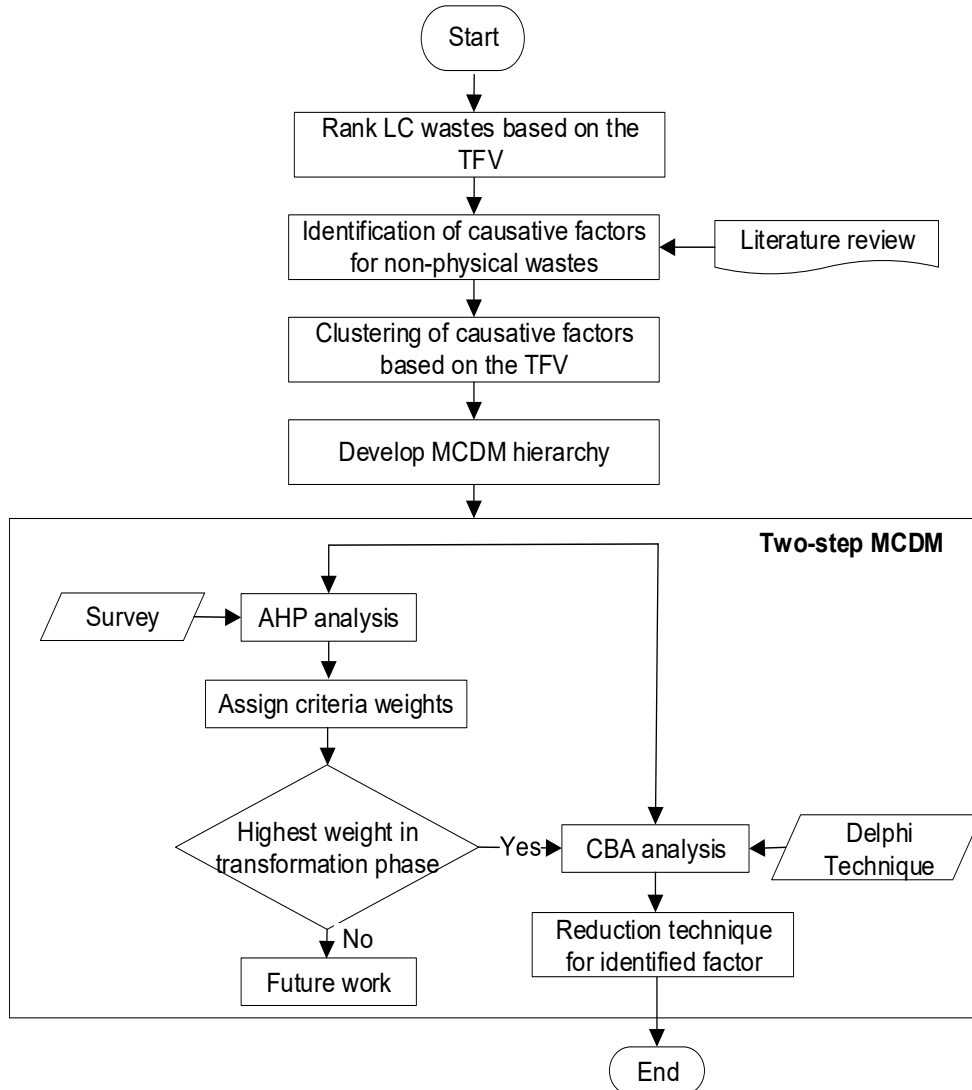

Figure 4.1: Sub-Research Method

## 4.2. Ranking the LC Wastes Based on the TFV

There are different categories of LC wastes (See section 2.3.1. Lean Construction Wastes which generally impact construction projects' performance. However, the influence of these wastes have typically been viewed from a project perspective, and this does not indicate how these wastes affect the three main phases (transformation, flow and value) of a project based on the LC paradigm. Understanding the degree of influence of the LC wastes on the TFV process of construction is imperative to understand better how to reduce them. The following sections

present the process of an empirical study to ascertain how the LC wastes affect construction projects based on the TFV.

#### 4.2.1. Data Collection and Analysis

A structured questionnaire was designed to ascertain how the most common LC wastes affect the transformation, flow and value processes of construction. The questionnaire was divided into two sections and had 33 questions in total. The first section aimed at obtaining information from the respondents regarding their level of education, number of years of work experience, organization type, size and area of specialization. Section 2 addressed the level of influence of each LC waste on the TFV process using ordinal scales. The ordinal scale utilizes integers in ascending or descending order as a basis for ranking. The integers do not indicate that the intervals between scales are equal, nor do they indicate absolute quantities. They are merely numerical labels (Naoum, 2012). A 5-point Likert scale was utilized with values: 1 for “not important,” 2 for “slightly important,” 3 for “moderately important,” 4 for “very important” and 5 for “extremely important.” The respondents were asked to give opinions on each LC waste and the process (Transformation, flow or value) where they exert the most significant influence based on their experience.

Data was collected over four months using purposive sampling technique. This involved identifying and selecting individuals or groups knowledgeable about or experienced with the topic of interest. A total of 109 questionnaires were circulated, and 60 valid responses representing a response rate of 55% was used for the analysis. To ascertain the data's internal reliability, Cronbach's alpha coefficient ( $\alpha$ ) was computed using Equation 1 (Cronbach 1951). Tables 4.1 and 4.2 show the survey respondents' profiles and the interpretation of the internal reliability results.

$$\alpha = \frac{k}{k - 1} \left( 1 - \frac{\sum_{i=1}^k \sigma_{yi}^2}{\sigma_x^2} \right) \quad (1)$$

where: k refers to the number of scale items

$\sigma_{yi}^2$  refers to the variance associated with item i

$\sigma_x^2$  refers to the variance associated with the observed total score

Table 4.1: Respondents profile and distribution

Category	Description	Frequency	%
Clustering of individuals	<b>Number of years of experience</b>	60	100
	More than 10	13	22%
	6-10 years	18	30%
	3- 5 years	29	48%
	<b>Level of education</b>	60	100
	Ph.D.	13	22%
	Masters	15	25%
	Bachelors	26	43%
	Diploma	6	10%
	<b>Job position</b>	60	100
	Project Management	12	20%
	Site Engineer	28	47%
	Team Leader/Foremen	20	33%
Clustering of organizations	<b>Size of organization</b>	60	100
	Large (More than 200 employees)	24	40%
	Medium (50-200 employees)	15	25%
	Small (Less than 50 employees)	21	35%
	<b>Type of project</b>	60	100
	Buildings	32	53%
	Roads and Bridges	24	40%
	Other Civil Projects	4	7%

Table 4.2: Cronbach internal consistency benchmark ((DeVellis 2016)

Cronbach's alpha	Internal consistency
$0.9 \leq \alpha$	Excellent
$0.8 \leq \alpha < 0.9$	Good
$0.7 \leq \alpha < 0.8$	Acceptable
$0.6 \leq \alpha < 0.7$	Questionable
$0.5 \leq \alpha < 0.6$	Poor
$\alpha < 0.5$	Unacceptable

The reliability analysis obtained using  $\alpha$  was 0.8, showing that the collected data is consistent. The sample was, therefore, considered suitable for further statistical analysis.

#### 4.2.1.1. Approach to Data Analysis

The approach to the data analysis involved the Relative Importance Index (RII) to rank the LC wastes based on their perceived degree of influence on the three main processes in construction

(transformation, flow and value) and the one way ANOVA to compare the means of two or more samples using hypothesis testing.

The RII has been used extensively in construction management research (Bekr 2014; Enshassi et al. 2017; Ikau et al. 2016) and is computed using Equation 2:

$$RII = \frac{\sum w}{A * N} \quad (2)$$

where: w represents the importance given to each factor by the respondents,

A refers to the highest weight (i.e. 5)

N represents the total number of respondents (60).

The one-way ANOVA is used to compare the means of two or more samples and tests the hypothesis that samples in all groups are drawn from populations with the same mean (Chan et al. 2017). The hypothesis for the one way ANOVA are:

- The null hypothesis ( $H_0$ ): there is no difference between the groups and equality between means.
- The alternative hypothesis ( $H_A$ ): there is a difference between the means and groups.

A 95% confidence level and a significance level of 5% was adopted for the analysis. The calculated probability ( $p$ -value) is the probability of finding the observed results when the null hypothesis is correct. The null hypothesis implies that the compared samples' means are statistically equal, and this will be rejected if the  $p$ -value is lower than 5% (0.05).

#### 4.2.1.2. Results

Table 4.3 shows the respondents' perception of how the different categories of LC wastes affect the "Transformation" aspect of construction projects. Making-Do was adjudged as the most crucial non-physical waste during the transformation process of construction, followed closely by Non-Utilized talent. From Table 4.4, it is observed that "Waiting" and "Transportation" are the two most essential aspects in the "Flow" aspect of construction, and Table 4.5 shows that

“Overproduction” is the most crucial waste category affecting the “Value” aspect of construction.

Figure 4.2 shows the graphical summary of the LC wastes on the TFV process.

Table 4.3: RII of LC waste based on the ‘Transformation’ aspect of construction

LC Waste	Degree of impact on the Transformation aspect of construction projects					Weighted Total	RII	Rank
	5	4	3	2	1			
	Making-Do	16	18	18	8			
Non-Utilized Talent	18	14	14	14	0	216	0.72	2
Defect/Rework	14	18	16	12	0	214	0.71	3
Extra-Processing	10	14	16	16	4	190	0.63	4
Overproduction	6	14	14	16	10	170	0.57	5
Waiting	0	16	20	16	8	164	0.55	6
Transportation	0	14	16	16	14	150	0.50	7
Inventory	0	6	18	20	16	134	0.45	8
Motion	0	10	12	18	20	132	0.44	9

Table 4.4: RII of LC waste based on the ‘Flow’ aspect of construction

LC Waste	Degree of impact on the Flow aspect of construction projects					Weighted Total	RII	Rank
	5	4	3	2	1			
	Waiting	16	18	18	8			
Transportation	18	16	14	12	0	220	0.73	2
Making-Do	14	13	19	14	0	207	0.69	3
Motion	12	16	18	14	0	206	0.69	3
Extra-Processing	0	16	16	18	10	158	0.53	5
Inventory	0	16	16	16	12	156	0.52	6
Overproduction	0	10	20	20	10	150	0.50	7
Defect/Rework	0	14	16	14	16	148	0.49	8
Non-Utilized Talent	0	6	16	18	20	128	0.43	9

Table 4.5: RII of LC waste based on the ‘Value’ aspect of construction

LC Waste	Degree of impact on the Value aspect of construction projects					Weighted Total	RII	Rank
	5	4	3	2	1			
	Overproduction	36	24	0	0			
Inventory	24	30	6	0	0	258	0.86	2
Non-Utilized Talent	4	20	20	16	0	192	0.64	3
Extra-Processing	0	24	20	16	0	188	0.63	4
Motion	10	14	16	12	8	186	0.62	5
Defect/Rework	10	12	14	10	14	174	0.58	6
Transportation	0	18	16	8	18	154	0.51	7
Waiting	0	4	20	24	12	136	0.45	8
Making-Do	0	4	16	22	18	126	0.42	9



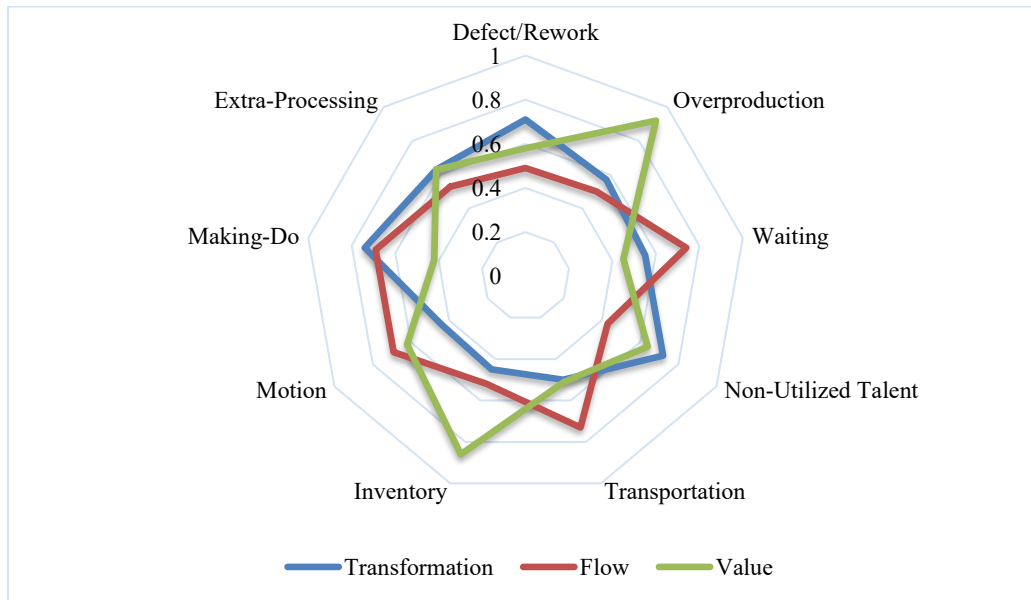

Figure 4.2: TFV based visualization of LC wastes based on the RII

To perform the ANOVA single factor test, the respondents were split into four sample categories (No of years of experience, level of education, size of organization and type of project). These four categories were selected because they provide necessary personal information about the respondents and their organization. The results (Table 4.6) show no significant differences in the mean of the different sample categories because their  $p$ -values are more significant than 0.05. However, in terms of the number of years of work experience, the respondents have different perceptions for two items: wastes due to overproduction (LW-F11) and wastes due to extra-processing (LW-F18) in the flow phase with  $p$ -values of 0.0109 and 0.0197, respectively. Similarly, in terms of the organization's size, waste due to overproduction in the flow phase (LW-F11) has a  $p$ -value of 0.0417 was perceived differently by the respondents. Based on the type of project, there were different perceptions by the respondents on waste due to overproduction in the transformation phase (LW-T2) with a  $p$ -value of 0.0320. Hence, the null hypothesis ( $H_0$ ) is rejected in favour of the alternative hypothesis ( $H_A$ ). These results provide insight that the

respondents' perception related to LW-F11, LW-F18 and LW-T2 are affected by their number of years of experience, size of the organization and project type.

The results show that the LC wastes have different degrees of influence on the TFV process. The highest-ranked wastes in the transformation aspect of construction were found to be "Making-Do," "Waiting" has more impact on the flow aspect of construction, while "Overproduction" had the most significant influence on the value aspect of construction. Understanding the degree of importance each category of LC wastes has on the construction process facilitates an understanding of the driver waste (highest ranked waste category) for each process. The effect of LC wastes has previously not been revealed by previous research, as most studies on non-physical wastes focused on understanding and ranking the factors promoting them without consideration for the construction phase where they are most prevalent.

Table 4.6: p-value results of ANOVA test

No	Code	Description	ANOVA: Single Factor			
			No. of years of experience	Level of education	Size of organization	Type of Project
1	LW-T1	Wastes due to defect/rework in the transformation phase	0.8623	0.1748	0.6240	0.0992
2	LW-T2	Wastes due to overproduction in the transformation phase	0.6694	0.0668	0.1979	0.0320
3	LW-T3	Wastes due to waiting in the transformation phase	0.6964	0.3324	0.9073	0.9963
4	LW-T4	Wastes due to non-utilized talent in the transformation phase	0.4556	0.3273	0.6546	0.1179
5	LW-T5	Wastes due to transportation in the transformation phase	0.4438	0.1675	0.6562	0.1306
6	LW-T6	Wastes due to inventory in the transformation phase	0.5124	0.9222	0.3298	0.1197
7	LW-T7	Wastes due to motion in the transformation phase	0.9089	0.7141	0.4962	0.5852
8	LW-T8	Wastes due to making-do in the transformation phase	0.1115	0.8085	0.3409	0.4161
9	LW-T9	Wastes due to extra-processing in the transformation phase	0.7284	0.6361	0.5244	0.9130
10	LW-F10	Wastes due to defect/rework in the flow phase	0.9886	0.8588	0.8511	0.6648
11	LW-F11	Wastes due to overproduction in the flow phase	0.0109	0.4544	0.0417	0.1674
12	LW-F12	Wastes due to waiting in the flow phase	0.7577	0.8529	0.7995	0.8655
13	LW-F13	Wastes due to non-utilized talent in the flow phase	0.1671	0.9180	0.5409	0.2498
14	LW-F14	Wastes due to transportation in the flow phase	0.2253	0.4142	0.1874	0.3585
15	LW-F15	Wastes due to inventory in the flow phase	0.1221	0.4937	0.4982	0.0622
16	LW-F16	Wastes due to motion in the flow phase	0.9720	0.2251	0.8405	0.2967
17	LW-F17	Wastes due to making-do in the flow phase	0.2001	0.1231	0.6206	0.0510
18	LW-F18	Wastes due to extra-processing in the flow phase	0.0197	0.5622	0.9814	0.6825
19	LW-V19	Wastes due to defect/rework in the value phase	0.5823	0.1118	0.4440	0.8629
20	LW-V20	Wastes due to overproduction in the value phase	0.8596	0.9150	0.8521	0.1682
21	LW-V21	Wastes due to waiting in the value phase	0.0669	0.7328	0.1798	0.8318
22	LW-V22	Wastes due to non-utilized talent in the value phase	0.8337	0.1243	0.4987	0.1128
23	LW-V23	Wastes due to transportation in the value phase	0.7242	0.8471	0.9698	0.1090
24	LW-V24	Wastes due to inventory in the value phase	0.5597	0.9350	0.1120	0.8526
25	LW-V25	Wastes due to motion in the value phase	0.6134	0.7143	0.8544	0.0979
26	LW-V26	Wastes due to making-do in the value phase	0.7646	0.4770	0.6084	0.1069
27	LW-V27	Wastes due to extra-processing in the value phase	0.9064	0.9526	0.1929	0.0549

### 4.3. Categorizing and Ranking Factors Promoting LC Wastes

The sub-research flowchart (Figure 4.1) showed the process for categorizing and ranking the factors that promote LC wastes in highway projects using a two-step multi-criteria decision-making method, formalize a project scheduling technique for elevated urban highway projects.

Factors that contribute to non-physical wastes were identified from previous studies (**See Section 2.3.1. Lean Construction Wastes**). These factors were cross-referenced and placed into eight groups by merging similar factors based on a similar procedure adopted by Wambeke et al. (2011). For example, changes in design, document problems, design errors, construction drawing errors and complicated design (Alwi et al. 2002b; Bossink and Brouwers 1996) were grouped under "Design and documentation". The eight groups were then re-clustered into three categories based on the TFV to create the decision hierarchy (Figure 4.3).

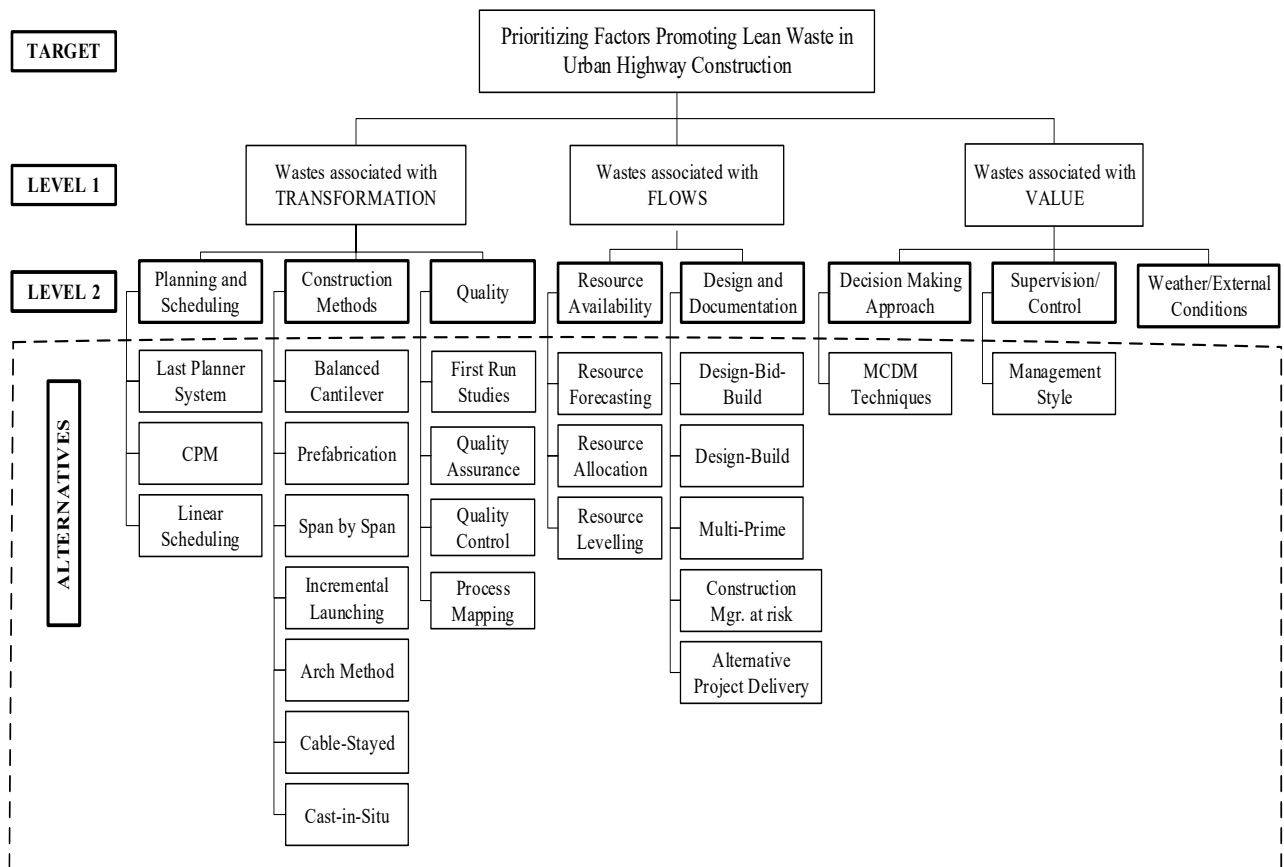

Figure 4.3: MCDM Hierarchy

In developing the decision hierarchy, the target was to prioritize the factors or criteria (Level 2 of the decision hierarchy) responsible for promoting LC wastes in the context of elevated urban highway construction. Techniques that can potentially improve or influence each selected criterion are included as “alternatives.” For instance, planning and scheduling were identified as level 2 criteria, techniques such as the CPM, LSM and LPS were identified as techniques and alternatives to improve the planning and scheduling process.

### **4.3.1. Data Collection and Analysis**

A structured questionnaire survey was developed to assign priority weights to the factors that promote non-physical wastes in elevated urban highway projects using the AHP. The questionnaires were administered to construction firms operating in Canada. The sample for the study was purposively drawn from the top 40 construction companies in Canada. The questionnaire was targeted at individuals with more than five years' experience in the construction sector. The respondents were asked to provide a pairwise comparison of the Level 2 criteria using the AHP. The scope of the research method was to conduct further analysis of the highest-ranked non-physical waste in the transformation phase. This was achieved by applying the CBA method.

#### *4.3.1.1. AHP Analysis and Results*

A total of 80 anonymized questionnaires were returned. However, since the AHP is based on expert judgement, only participants with more than five years of experience were considered for the analysis. Furthermore, only respondents involved in roads and highway construction were considered for the analysis since the research focused on highway projects. Therefore, only 41 responses were used for the analysis. The steps for the AHP application (**See Section 2.8.1.1.** Analytical Hierarchical Process (AHP) proposed by Saaty (1980) was applied to analyze each response to obtain a judgement matrix for level 2 of the decision hierarchy. The data's consistency is determined using the eigenvalue ( $\lambda_{max}$ ) to calculate the consistency index (CI). A perfectly consistent response is obtained when  $CI = 0$ . If the  $CI \neq 0$ , then the consistency ratio (CR) is used

to measure the level of inconsistency by dividing the CI with the appropriate value of the random index (RI) proposed by (Saaty 1980). A judgement matrix is only accepted as a consistent one if  $CR < 0.1$ . Table 4.7 shows an example of the judgement matrix for one respondent (See **Appendix III** for detailed calculation).

Table 4.7: Judgement matrix for one respondent

		Comparison Matrix			Transformation Matrix			$w_k$	WS	$\lambda_{max}$
		Trans.	Flows	Value	Trans.	Flows	Value			
Level 2	Transformation	1.00	3.00	5.00	0.50	0.92	0.45	0.66	2.00	3.04
	Flows	0.33	1.00	4.00	0.20	0.31	0.36	0.29	0.87	3.02
	Value	0.20	0.25	1.00	0.12	0.08	0.09	0.10	0.29	3.00
		1.53	4.25	10.00					Ave. $\lambda_{max}$	3.02
									CI	0.01
									CR	0.0163

Each respondent's judgment matrix was calculated, and the aggregation of individual judgement (AIJ) was performed using the arithmetic mean method (AMM) to aggregate the individual responses. The AIJ constructs an aggregated decision matrix and combines each respondent's responses to get the aggregated group result. The aggregated final weight is shown in Table 4.8.

Table 4.8: Summary of results

Level 1	Level 2	Relative Weights
<b>Transformation</b>	Planning and scheduling	0.19
	Construction method	0.08
	Quality	0.05
<b>Flows</b>	Resource availability	0.16
	Design and documentation	0.17
<b>Value</b>	Decision-making approach	0.21
	Supervision/control	0.10
	Weather/External conditions	0.04

The results show the weights of the different factors. Planning and scheduling were revealed to be the highest contributor to non-physical wastes in the transformation phase of construction, with a weight of 0.19. This implies that reducing non-physical wastes attributable to poor planning and scheduling will lead to an improvement in the transformation phase of construction projects and led to the process of formalizing the process of selecting the appropriate planning/scheduling technique applicable to elevated urban highway projects using the CBA.

### 4.3.1.2. CBA Analysis and Results

The last question in the questionnaire survey used for the AHP analysis requested the email address of participants interested in participating in the second phase of the analysis. Based on the feedback, fifteen project managers with an average experience of 10.5 years working in elevated urban highway projects were selected for the CBA analysis. The Delphi technique was employed for collecting data for the second research objective of formalizing the process of selecting a project planning and scheduling technique using the CBA method. The Delphi technique has been widely used in the construction management domain as a data collection technique from a panel of selected experts and does not require a large sample size (Alaloul et al. 2015; Ameyaw et al. 2016).

### ***CBA Step-by-Step Application***

**Step 1:** Identify alternatives for consideration in the decision process.

Three planning and scheduling techniques were identified, as described previously in the MCDM hierarchy formulation. The LPS, CPM and LSM.

**Step 2:** Define the factors that are going to be assessed to differentiate the alternatives.

The participants were asked to list factors that influence their choice of planning and scheduling techniques employed on their projects. The lists were cross synthesized, reworded, combined and reduced. The combined list was reduced to 15 factors (Figure 4.4) and sent back to the respondents for their consensus. This process went through three rounds of iteration using the Delphi technique before arriving at the seven factors used for the analysis.

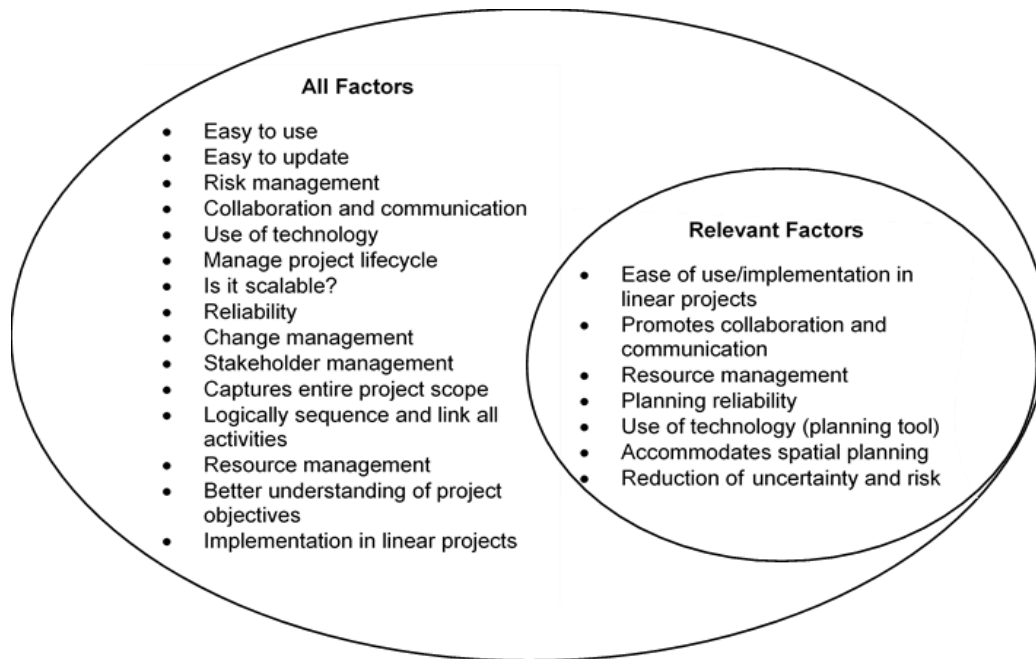

Figure 4.4: Identified factors for comparing alternatives

**Step 3:** Define the “must” criterion, which provides the rules for judging the factors.

The “must” criterion for each factor was then agreed upon. To achieve this, a short questionnaire was sent to the respondents. The respondents were asked to “agree,” “disagree,” or “comment” on the “must” criteria presented by the researcher. For example, factor 1 considered the “ease of implementation in linear projects,” and “easier is better” was considered the “must criteria.” The participants were also asked to provide weights for the criteria using a 5-point Likert scale (where five on the Likert scale represented 100 and one represented 0). The arithmetic mean of the assigned weights was used in the decision context.

**Step 4:** Summarize the attributes of each alternative.

The attributes of each alternative were obtained from existing literature as a starting point and sent to the participants. Based on the feedback received, some of the attributes were modified. The least desirable attribute for each identified factor is underlined and used as a comparison to describe the advantage of an alternative based on that factor.



**Step 5:** Decide the advantages of each alternative.

Once the attributes are summarized, the criteria are applied to identify the advantages. Note that there will always be at least one alternative for each factor that does not have an advantage because it has the least preferred attribute or characteristic in that criterion.

**Step 6:** Decide the importance of each advantage (lofA). The lofA corresponds to the value given to each alternative's advantage based on each factor by each participant.

A template (Table 4.4) was sent to the participants. Each participant was asked to assign weights to each selected alternative's advantage based on the agreed factors and criteria. The decision-makers then decide on the second “best” alternative and assign weight to it. The least preferred alternative is automatically assigned a weight of zero. The sum of the lofA for all factors represents the total importance of that alternative. Finally, the weights assigned by each participant were aggregated using the arithmetic mean to arrive at a group consensus. The final analysis is shown in Table 4.9.

### *4.3.1.3. Validation of CBA Result*

To validate the CBA analysis results, separate interviews were conducted with five project managers and a site foreman. The interviewees were from two separate construction companies involved in the construction of a major highway interchange in Montreal, Canada and had a combined work experience of 33 years. The interviewees had no prior knowledge of the research results. They were presented with the factors and criteria used for the CBA analysis and asked to select a project planning and scheduling technique. The responses obtained were consistent with the results of the analysis. However, they were unanimous in their assertion that changing the factors and criteria would lead to a different outcome in choosing the planning and scheduling technique.

Chapter 4: Categorization of LC Wastes

Table 4.9: CBA implementation

S/N	Factor & Criterion	Last Planner System		Critical Path Method		Linear Scheduling	
1	Ease of use/ implementation in linear projects <b>Crit.:</b> Easier is better <b>Max. Weight:</b> 50	<b>Attr.:</b> Easy to use and based on operational planning		<b>Attr.:</b> <u>Convolutd in complex projects and ineffective for continuous linear projects</u>		<b>Attr.:</b> Used in linear projects where the majority of the work is made up of highly repetitive activities	
		<b>Adv.:</b> understand the presence of variability in production, human-focused	lofA 35	<b>Adv.:</b>	lofA 0	<b>Adv.:</b> Performs optimally when applied to linear projects	lofA (50)
2	Promotes collaboration and communication during the project execution phase <b>Crit.:</b> Higher is better <b>Max. Weight:</b> 100	<b>Attr.:</b> Planning is done mainly at the project level and is therefore flexible		<b>Attr.:</b> <u>Planning is rigid, and process-focused and carried out on a strategic level</u>		<b>Attr.:</b> Planning is carried out on a strategic level and best implemented as an effective management tool at the field level	
		<b>Adv.:</b> More collaboration and communication during the execution stage	lofA (100)	<b>Adv.:</b>	lofA 0	<b>Adv.:</b> Collaboration and communication during the execution stage	lofA 60
3	Resource management <b>Crit.:</b> Higher is better <b>Max. Weight:</b> 50	<b>Attr.:</b> The process of “making ready” and constraint removal are tools in resource management		<b>Attr.:</b> Integrated with Network planning tools		<b>Attr.:</b>	
		<b>Adv.:</b> enhanced collaboration and communication promotes resource management	lofA 20	<b>Adv.:</b> Facilitates resource allocation, levelling and smoothing	lofA (50)	<b>Adv.:</b> Resource allocation/levelling is not possible as it lacks resource allocation and levelling capabilities	lofA 0
4	Plan reliability <b>Crit.:</b> Higher is better <b>Max. Weight:</b> 25	<b>Attr.:</b> Planning is done detail closer to the task execution		<b>Attr.:</b> <u>Planning is comprehensive with long term focus</u>		<b>Attr.:</b> Easy to schedule continuity on linear projects, improving coordination and continuity	
		<b>Adv.:</b> Commitment planning by the last planners increases planning reliability	lofA (25)	<b>Adv.:</b>	lofA 0	<b>Adv.:</b> Improved coordination and continuity and visualization of the time-space relationship	lofA 15
5	Use of technology (planning tools) <b>Crit.:</b> Availability of technology is better <b>Max. Weight:</b> 50	<b>Attr.:</b> Planning is carried out in the “big room” using big plane boards and stickers		<b>Attr.:</b> Well-advanced tools available for use, easily adapted to numerical computerization		<b>Attr.:</b> <u>Intuitive and easy to understand but cannot easily be adapted to numerical computerization as readily as network methods</u>	
		<b>Adv.:</b> Simple and manual planning technique	lofA 0	<b>Adv.:</b> Availability of technology supporting the implementation	lofA (50)	<b>Adv.:</b> Limited number of computerization implementation platforms	lofA 0
6	Ability to accommodate space planning <b>Crit.:</b> Ability to accommodate space planning is better <b>Max. Weight:</b> 100	<b>Attr.:</b> Pull based scheduling that facilitates micro scheduling. Focuses on “how” instead of “what”		<b>Attr.:</b> <u>Focuses on “what” instead of “how.” Emphasizes the critical path</u>		<b>Attr.:</b> Considers and accurately represents space-time relationships	
		<b>Adv.:</b> Constraint removal techniques facilitate space planning	lofA 50	<b>Adv.:</b>	lofA 0	<b>Adv.:</b> Facilitates the visualization of space-time relationships	lofA (100)
7	Reduction of uncertainty and risk <b>Crit.:</b> Higher is better <b>Max. Weight:</b> 50	<b>Attr.:</b> Produces a predictable and reliable workflow		<b>Attr.:</b> Complemented by EVM and PERT with mathematical abilities.		<b>Attr.:</b>	
		<b>Adv.:</b> Project percent complete (PPC) and Variance Analysis (VA) can be used to reduce uncertainty and risk	lofA 35	<b>Adv.:</b> Statistical abilities help planners to get a better idea of time and schedule risk	lofA (50)	<b>Adv.:</b> There is no method to incorporate duration and production uncertainty	lofA 0
	<b>Total lofA</b>		<b>(265)</b>		<b>150</b>		<b>225</b>

#### **4.4. Discussion**

The characteristics and nature of projects in the construction sector differ from one project to another. This difference makes it difficult to standardize the process of selecting project planning and scheduling tools for construction projects. The variation in projects, scope, size and duration is so significant that one single technique cannot solve all the problems. Highway projects are different from other construction projects as they often involve the management of several factors, including traffic management and spatial considerations, especially in urban areas. Across the literature, the focus has been on applying different planning and scheduling technique with little emphasis on selecting the technique to apply. Selecting the appropriate planning and scheduling method is essential to achieving project success and defining essential factors and criteria to help achieve project objectives should be the starting point in selecting the appropriate planning and scheduling technique. Usually, the CPM is the most widely used method for planning and scheduling construction activities. However, for certain projects, such as elevated urban highway projects, CPM becomes complex and challenging to use and understand (Harmelink and Yamin 2001). Ahuja and Thiruvengadam (2004) further claimed that only technical precedence and resource availability constraints are explicitly shown in CPM networks. The CPM also does not consider spatial constraints. This limitation makes it difficult for the CPM to be applied to the construction of elevated urban highway projects where spatial constraints and the uninterrupted usage of resources such as heavy construction equipment is important to project success.

During the project execution phase, there is a need to effectively plan the construction work concerning the work schedule and resource availability (Ahuja and Thiruvengadam 2004). Having accurate and up-to-date information on each activity and the resource needed to actualize them impact effective project scheduling of linear projects. However, deterministic project scheduling, such as the CPM and LSM, does not provide the flexibility and uncertainties inherent in construction projects, especially in elevated urban highway projects. The schedules developed

for these projects should consider logical precedence constraints of activities and spatio-temporal constraints by creating relationships between the project environment, organizational characteristics and the planner's capabilities. This is where the LPS has a significant advantage over the other planning and scheduling tools. Jørgensen (2006) revealed that LPS increases the planning process's reliability and helps address the non-physical wastes associated with planning uncertainty and deviation.

The CBA analysis presented in this research shows the suitability of the LPS over the CPM and LSM in planning and scheduling elevated urban highway projects based on the highlighted factors. The actual outcome of the LPS is that the process can reveal poor planning and scheduling and facilitates a proactive approach to developing solutions for their improvement (Wodalski et al. 2011). According to Wu et al. (2019), the LPS provides a way to improve highway construction projects' efficiency.

#### **4.5. Summary**

Non-physical wastes affect the different phases in different ways. The highest-ranked wastes in the transformation aspect of construction were found to be "Making-Do," "Waiting" has more impact on the flow aspect of construction, while "Overproduction" had the most significant influence on the value aspect of construction. After ranking the LC wastes, it became imperative to ascertain the factors contributing to them and proffer a solution for the highest-ranked waste factor in the transformation phase. This was achieved using a two-step MCDM technique. The AHP was utilized to assign priority weights to factors promoting non-physical wastes. The results revealed that non-physical wastes attributable to planning and scheduling had the highest effect in the transformation phase of construction projects.

The second step of the MCDM method utilized the CBA method to select the most suitable planning and scheduling technique applicable to elevated urban highway projects based on some selected factors. The CBA was combined with the AHP because it provides a more robust analysis

and rationale for selecting alternatives by using specific factors and criteria to define the attribute and advantages of one alternative over another. The results reveal the LPS is suitable for planning and scheduling elevated urban highway projects due to its ability to outperform the LSM in CPM in some specific areas, such as its ability to facilitate collaboration and communication. However, it was observed that the LSM and the LPS are closely related based on the respondents' views, and as such, further investigation is required to ascertain how these two methods can be used together in elevated urban highway projects. Future research would also expand the research methodology to include selecting reduction techniques for other identified factors promoting LC wastes in highway projects. The analysis presented in this chapter provides a formalized way of selecting the planning and scheduling technique in elevated urban highway projects based on some essential factors associated with this type of project and serves as an input in developing the framework for equipment workspace planning by integrating the LPS in a 4D model.

## **CHAPTER 5 : FRAMEWORK FOR EQUIPMENT WORKSPACE MANAGEMENT USING THE LAST PLANNER AND 4D BIM FOR ELEVATED HIGHWAY PROJECTS**

Construction processes typically involve dynamic elements, including activity workspaces, storage spaces, and path spaces critical for construction 4D planning. However, among these, equipment workspaces currently are not represented dynamically in 4D models. This chapter aims to expatiate the proposed approach for equipment workspace introduced in Section 3.2 and develop a conceptual framework for integrating the LPS and detailed 4D modelling for equipment workspace planning. The proposed framework highlights the 4D-LOD requirements for equipment space planning in urban highway projects.

### **5.1. Approach for Equipment Space Planning**

Workspace planning is of great importance in large infrastructure projects such as bridges where heavy construction equipment is required and is, therefore, an essential criterion for the success of this kind of project. To facilitate workspace planning, the IDFE0 context diagram presented in Figure 3.3: IDEF0 context diagram for equipment workspace planning is expanded to highlight four processes (A1 to A4) shown in Figure 5.1. These processes will be explained in the succeeding sections.

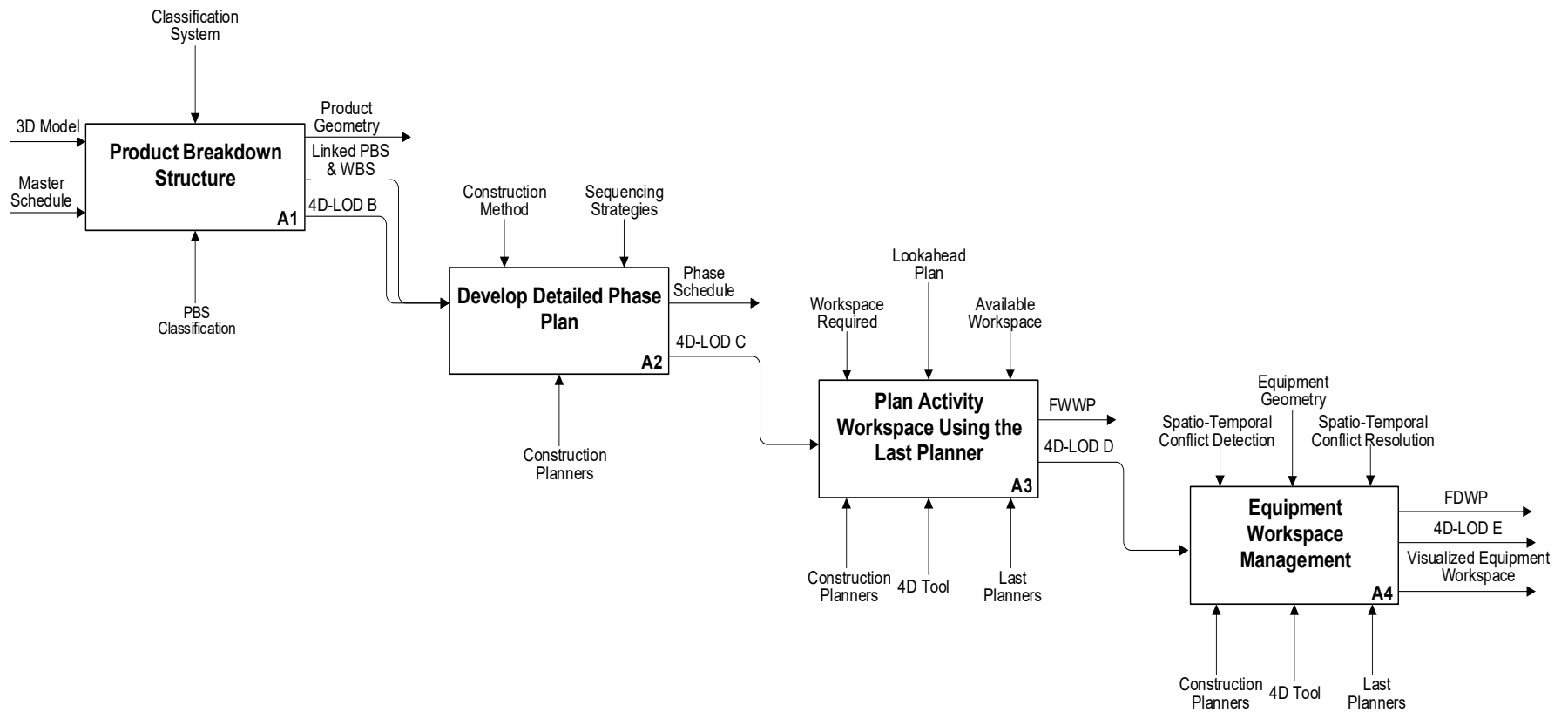

Figure 5.1: IDEF0 process diagram for equipment workspace planning

### **5.1.1. A1- Product Breakdown Structure**

The Product Breakdown Structure (PBS) serves as means for uniquely identifying by name and number all the elements of the product model in the 3D model to facilitate the explicit tagging of their characteristics (Lamers 2002). It is used to reduce complex projects into manageable components to obtain a clear understanding of the product, its components and the requirements for providing those components. The PBS helps us decompose the 3D model to make it easy to organize and manage classification data. Formalizing the PBS using a classification system helps create a shared understanding between project participants, and when consistently used, ensures standardization and the easy retrieval of information and is the first step towards creating the Work Breakdown Structure (WBS).

The first step in formalizing the PBS is to break down the 3D bridge model (Figure 5.2) into the different product groups (Figure 5.3) and classify them according to a classification system (e.g. MasterFormat, UniFormat, Uniclass and Omniclass). This classification should allow for the secure exchange of information regardless of the authoring platform used and, therefore, be based on standard data structures.

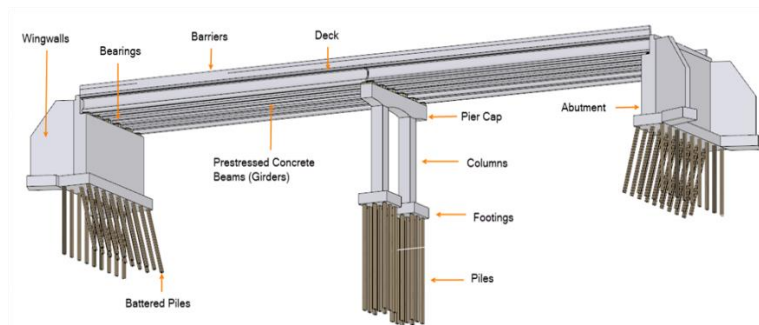

Figure 5.2: Bridge model showing bridge terminology



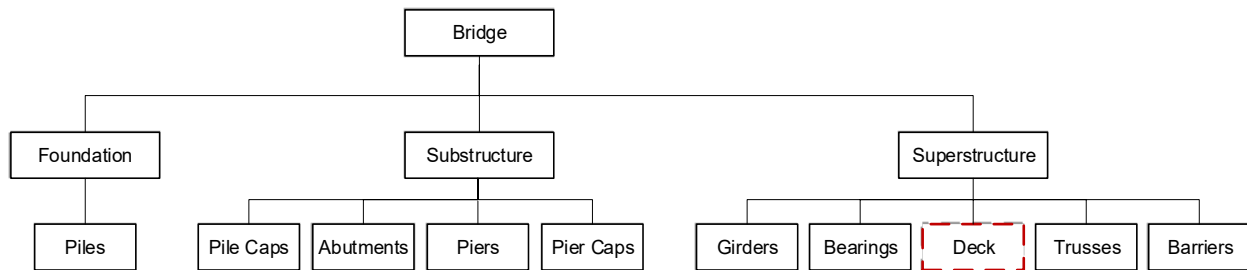

Figure 5.3: PBS of a bridge

Formalizing the PBS of the bridge helps to better put the work required into perspective as the classified product groups help to decompose each product into a WBS to help break down the product groups into tasks and processes required for their actualization and facilitate the planning of the equipment workspace. The PBS is subsequently linked with the work breakdown structure (WBS) of the master schedule. The resultant 4D model is designated as 4D-LOD B, used for major work coordination and feasibility.

### 5.1.2. A2- Develop Detailed Phase Plan

Developing the detailed phase plan involves refining and improving the LOD of the master schedule, agreeing on the construction methods to adopt for each phase based on the site conditions, and deciding the strategies to adopt to ensure that the resultant phase schedule is as realistic as possible to the contractual baselines at the time of the bid. This is achieved with detailed input from the project management team. Different techniques exist for estimating task durations (e.g. simulation, expected productivity, three-point estimates) to ensure that the LOD of the WBS is further refined to match the details required for the LOD of the PBS. The PBS is linked to the WBS (Figure 5.4) to create tasks for the selected bridge product. The resulting 4D model is the 4D-LOD C, consisting of sets of integrated project execution schedules matching the contractual baseline at the time of the bid.

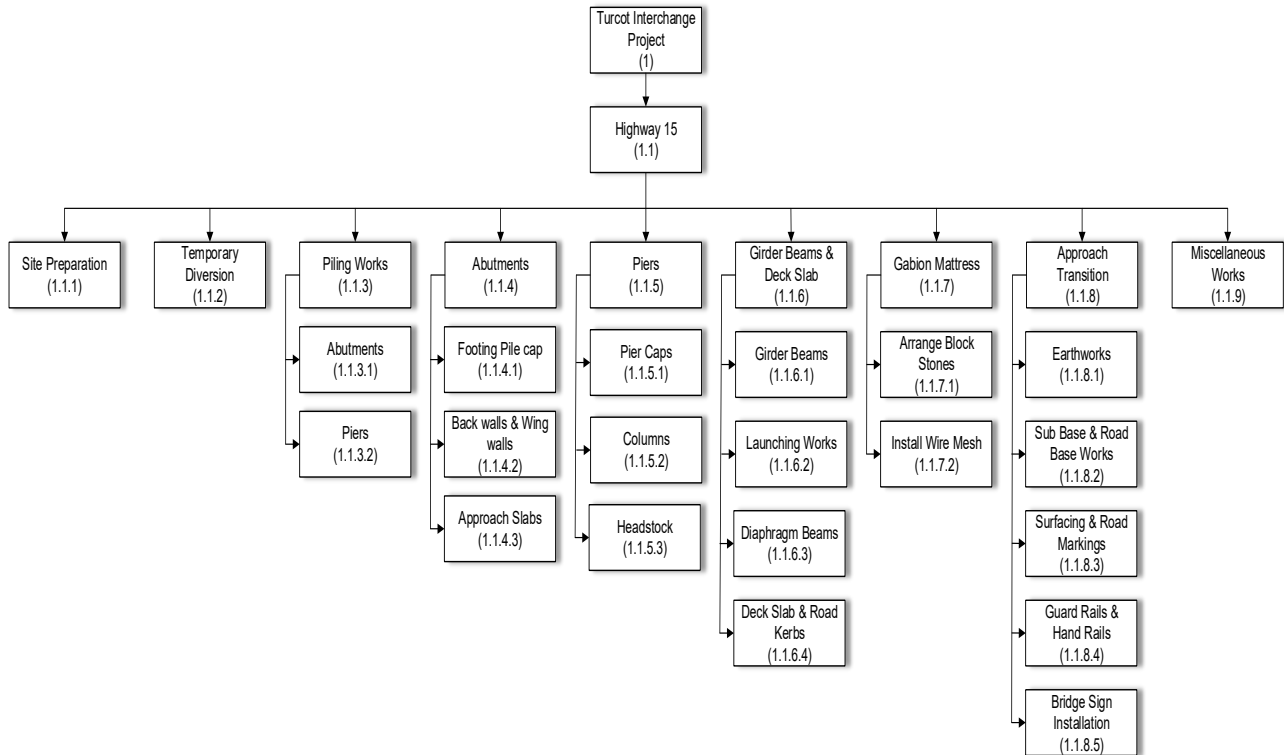

Figure 5.4: PBS linked to WBS for bridge construction

### 5.1.3. A3- Plan Activity Workspace Using Lookahead Plan

The process starts by using the lookahead plan to break down work described in the phase schedule, identify and remove constraints (e.g., activities with high space demands) to ensure the schedule's feasibility. Lookahead planning involves breaking down work into operations and identifying and removing constraints that may prevent the scheduled tasks from being actualized. Figure 5.5 and Table 5.1 (adapted from Hamzeh et al. 2015) highlight the lookahead planning process and the parameters required to obtain the Feasible Weekly Work Plan (FWWP). The FWWP is a constraint-free weekly plan that forms the basis for the weekly schedule.

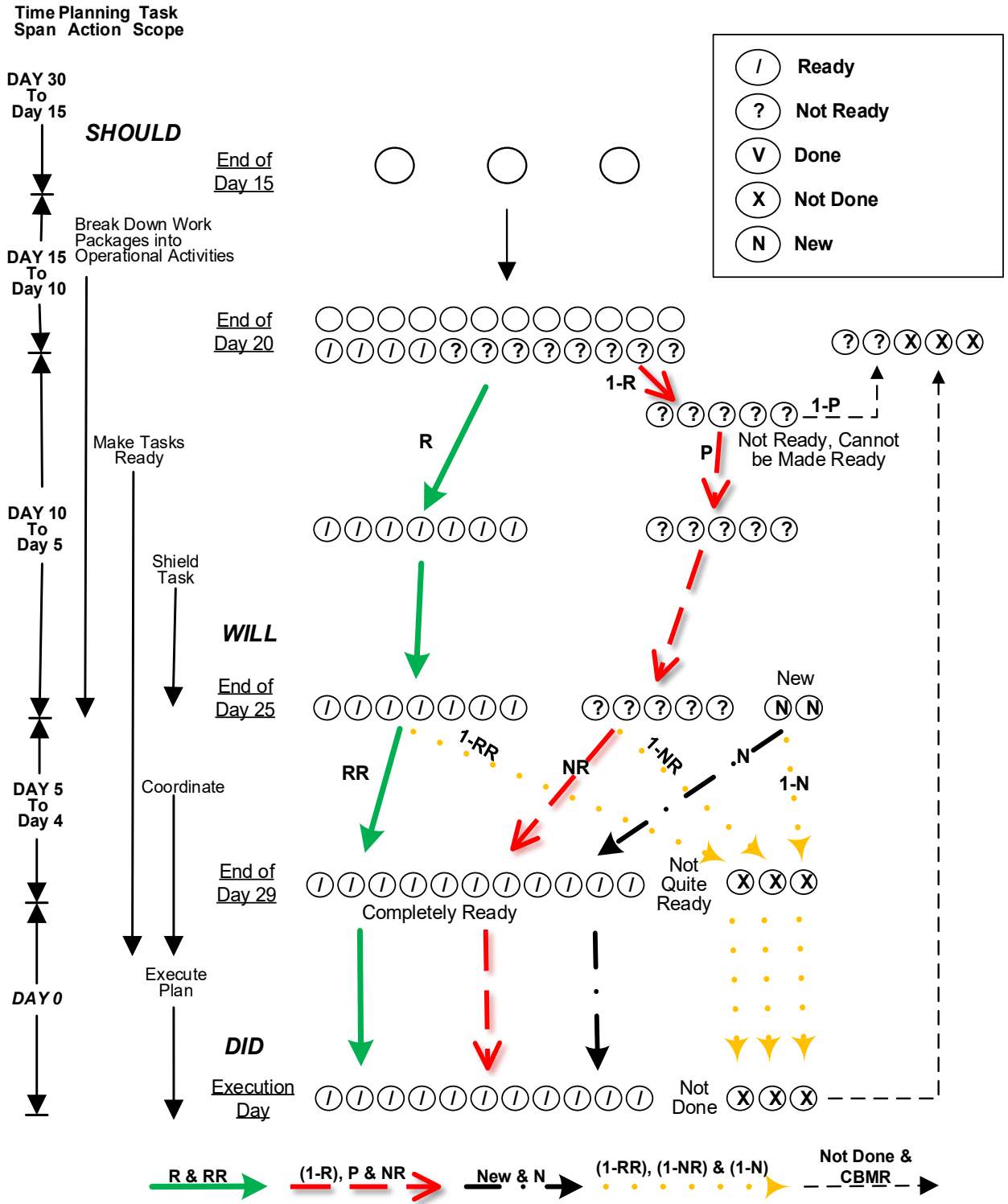

Figure 5.5: Lookahead planning process (adapted from Hamzeh et al. 2015)

Table 5.1: Parameters for describing lookahead planning (adapted from Hamzeh et al. 2015)

Parameter	Description
Processes	Number of tasks in a work package in the phase plan
Operations	Number of tasks that an activity in a process gets broken into
P	Percentage of tasks that are Not Ready but have a chance to become ready prior to the scheduled execution
R	Percentage of tasks made ready prior to execution
RR	Percentage of Ready tasks that are entirely unconstrained and Really Ready
NR	Percentage of Not Ready tasks that will be made Ready prior to execution day
New	Number of tasks added to the WWP without undergoing lookahead planning
N	Percentage of New tasks made ready prior to the execution day

Hamzeh et al. (2015) revealed the four distinct levels of phases used to describe the lookahead plan, and these are phase, processes, operations/activities and steps. The project is divided into phases (e.g., bridge superstructure); the project phase is expressed in terms of processes (e.g., precast decks that are part of the superstructure). Processes are broken down into operations/activities (e.g., installation of the precast deck), and operations are further divided into steps required to achieve them (e.g., rigging, the positioning of the deck). The processes are further decomposed into their constituent operations.

Prior to execution, some operations are unconstrained, and hence Ready for execution (R), while some are constrained (lacking specific prerequisites) and hence Not-Ready (1-R). The operations that are *Not Ready* are made ready by removing the constraints by providing task prerequisites (such as manpower, space, equipment). There is the possibility of making a certain percentage (P) of the *Not Ready* tasks ready by further removing constraints while the remaining (1-P) percent *Cannot Be Made Ready* (CBMR) and will undergo a similar analysis in the lookahead planning cycle. However, it is sometimes impossible to remove all constraints before the scheduled operation. Only plans that are *Ready* and those that have their constraints removed prior to the execution week are incorporated in the WWP. Some new tasks (*New*) that had not been anticipated earlier due to oversight or poor process decomposition may be required to be added to the WWP. Some of the *New* tasks may be successfully executed (N), while others (1-N) may have to be carried over. During the execution week, it may be required to update tasks

and dependencies as a percentage of tasks previously perceived as *Ready* may indeed be unconstrained and designated *Really-Ready and* are classed as *Done* tasks after their execution. The remaining percentage of tasks previously perceived to be *Ready* are actually constrained (1-RR) and thus cannot be completed as initially planned and therefore join the *Not Done* tasks. The outcome of this process is the FWWP. Linking the FWWP the PBS produces the 4D-LOD D: operational fieldwork.

### **5.1.4. A-4 Equipment Workspace Management**

Equipment workspace management is the process of planning and managing the equipment workspace and includes spatio-temporal analysis. Equipment workspace management requires knowing the activity workspace requirements. The workspace requirement identification helps to create an understanding of the size and location of the workspace and subsequently generate the required equipment workspace. Figure 5.6 highlights the workspace requirement identification process.

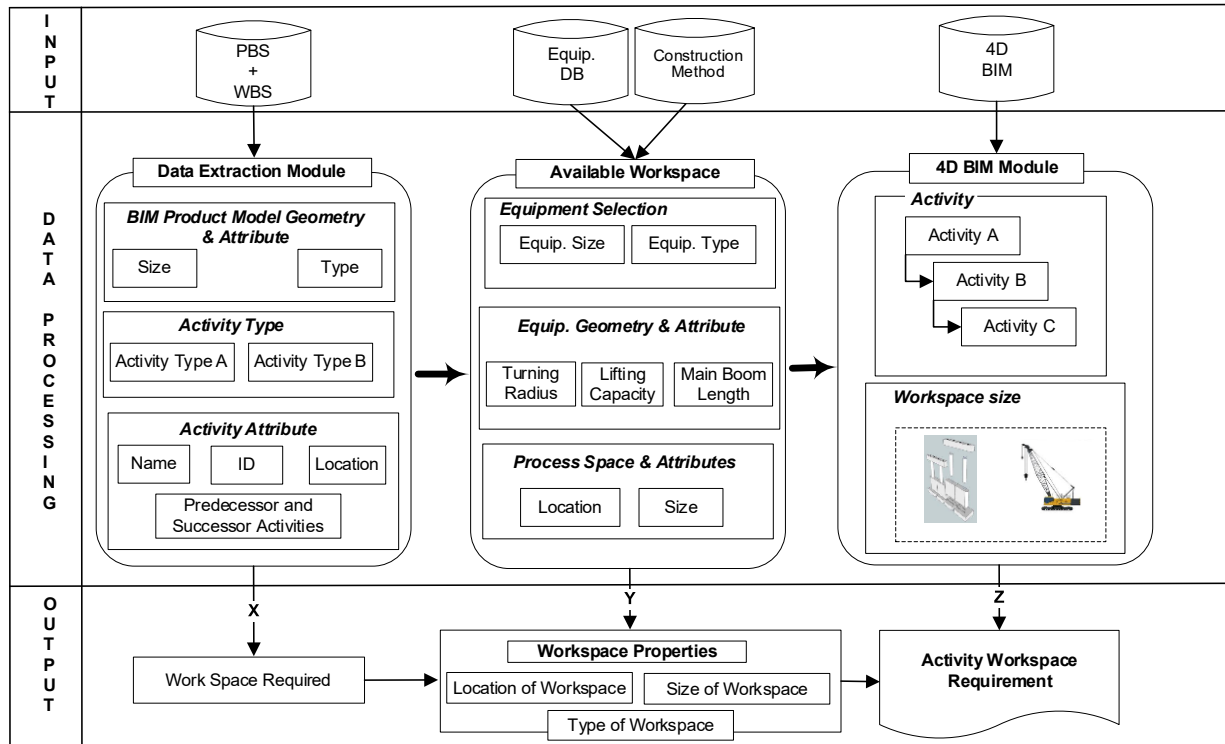

Figure 5.6: Workspace requirements identification

The WBS and PBS contain information about the activity to be performed and the spatial relationship between the activity and the PBS. This information is required to select the proper equipment from the equipment database for the activity. The equipment database contains important information regarding the size and properties of each piece of equipment.

The activity attributes are generated and assigned based on the WBS and the PBS. Each activity is associated with one or more objects (e.g. the bridge decks are associated with the activity “install bridge deck”), and the product model geometry and attributes are obtained from the 3D BIM. The activity attributes and the BIM product model attribute provide necessary information on the working space required (X in Figure 5.6). The construction method, which is typically outlined in the project execution plan (PEP), serves as an important step in selecting the appropriate equipment based on the available workspace. The equipment selection is therefore based on the available workspace and the equipment attributes. The available workspace is obtained from the BIM model by creating work zones. These work zones indicate the maximum

space available for activities within its location. The location and size of the process space are also obtained as part of the available space (Y in Figure 5.6). The activity workspace (Z) is, therefore, a combination of X and Y and depicts the total space required to execute an activity, i.e. safely:

$$\text{Activity Workspace} = \text{Space Bridge object} + \text{Space Equipment} + \text{Space Others (Labor, storage)}$$

The equipment workspace management also includes spatio-temporal analysis (conflict detection and resolution). To perform spatio-temporal analysis, the bounding volumes of the different 3D elements of the workspaces (i.e. object and equipment space) and the interference between them are analyzed using bounding volumes. A bounding volume is a 3D geometry constructed to enclose all surfaces of an object. The bounding volumes provide fast intersection tests, and they should be small enough to enclose the object. Most previous research performed conflict detection using the BB conflict detection algorithms in a 3D environment. In this study, the conflict detection is performed in the 4D environment by transforming the bounding volume to the position and scale of workspace objects, and spatio-temporal conflict is resolved using rule-based heuristics (Figure 5.7) to generate a spatio-temporal free activity workspace.

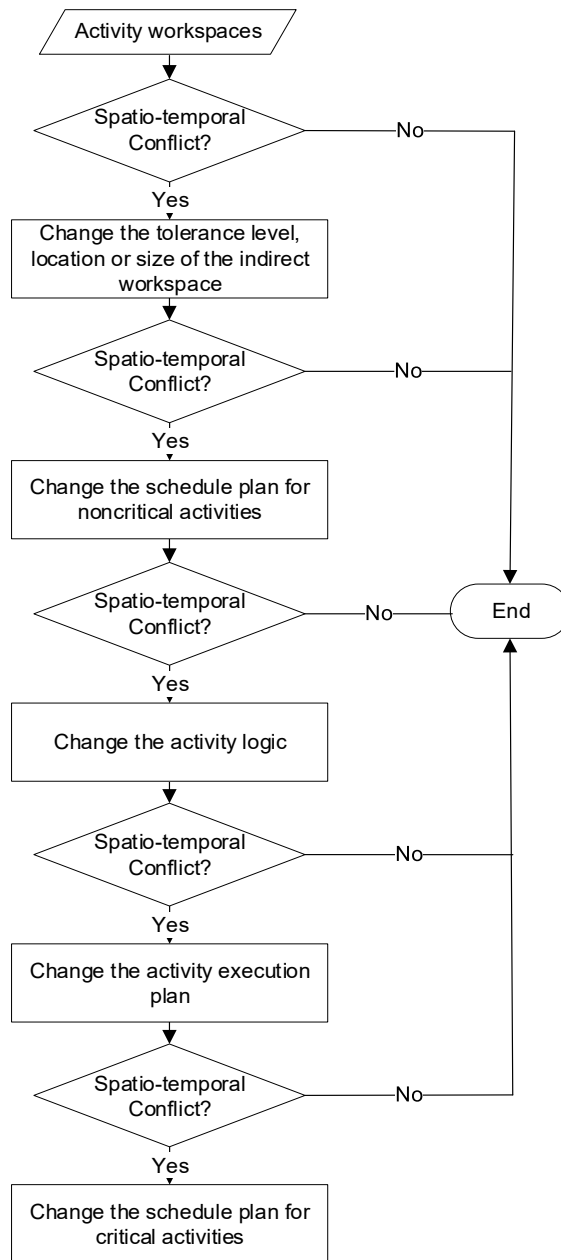

Figure 5.7: Rule-based heuristics for conflict resolution

The rule-based heuristics for conflict resolution consists of the following steps:

1. Change the tolerance, location or size of the indirect workspace: The first step in resolving a spatio-temporal conflict is to change the tolerance, location or size of the flexible workspace (i.e. material storage space) only if the flexible workspace is among the conflicted workspaces.



2. Change the schedule plan for non-critical activities: This strategy involves changing the start time of non-critical activities with conflicting space occupation or splitting the working time based on the activity's total float or slack.
3. Change the activity logic: Some workspace problems, especially between object workspaces and fixed workspaces, may be resolved by changing the logical sequence between activities.
4. Change the activity execution plan: Some workspace problems may not be resolved by steps 1-3. These workspace problems may be resolved by changing the activity execution plan. The activity execution plan includes the material, size and type of equipment and the techniques required to execute an activity. For instance, a project manager may decide to deploy one 40ton crawler crane instead of two 20ton cranes. When changing the activity execution plan, care should be taken to ensure no productivity loss due to the change.
5. Change the schedule plan for critical activities: The workspace problem that cannot be resolved by steps 1-4 are resolved by changing the schedule plan for critical activities. Changing the schedule plan for critical activities is the last option, as this may lead to a delay in the project completion date. However, a delay due to the schedule alone (i.e., it is already captured proactively) is better than a delay caused by spatio-temporal conflict (reactive delay).

The proposed approach enables the resolution of conflicts, one after another, in a heuristic way, until all conflicts are resolved. The 4D model obtained after the spatio-temporal conflict resolution is referred to as the 4D-LOD E: detailed equipment movements and workspaces.

### **5.2. Conceptual Framework for Equipment Workspace Planning**

The approach for equipment space planning introduced in Section 3.2 and discussed in Section 5.1 facilitated developing a conceptual framework for integrating the LPS and 4D modelling for equipment workspace planning in elevated urban highway reconstruction projects (Figure 5.8).

The framework addresses issues relating to *micro-scheduling of equipment, equipment workspace requirement* and *4D model requirements for equipment workspace planning, representation and visualization* using the following steps:

**Step 1: Define the construction method.** The construction method is typically defined based on the project execution plan and the activity method statement during the pre-construction phase. In the reconstruction of elevated urban highways, several construction methods exist, and selecting an appropriate method is crucial in selecting the equipment type and size.

**Step 2: Formalize PBS.** The 3D model is broken down into its different constituents and formalized according to a classification system. Formalizing the PBS is an essential consideration for equipment workspace planning in elevated highway projects. It enables categorizing the bridge components, extracts the product geometry and assigns tasks using the WBS of the master baseline schedule to understand the various activity's workspaces.

**Step 3: Link WBS of phase schedule to PBS.** The WBS of the phase schedule is refined to improve the LOD and linked to the PBS of the initial 4D model. This linkage helps ensure that all the necessary tasks are identified. This process leads to creating a 4D- LOD C representing the contractual baseline at the bid time.

**Step 4: Create construction work zones.** Construction work zones are created to facilitate an understanding of the available workspaces for a specified time. The work zones provide valuable input to the lookahead planning process and indicate the "available space" for the lookahead planning window.

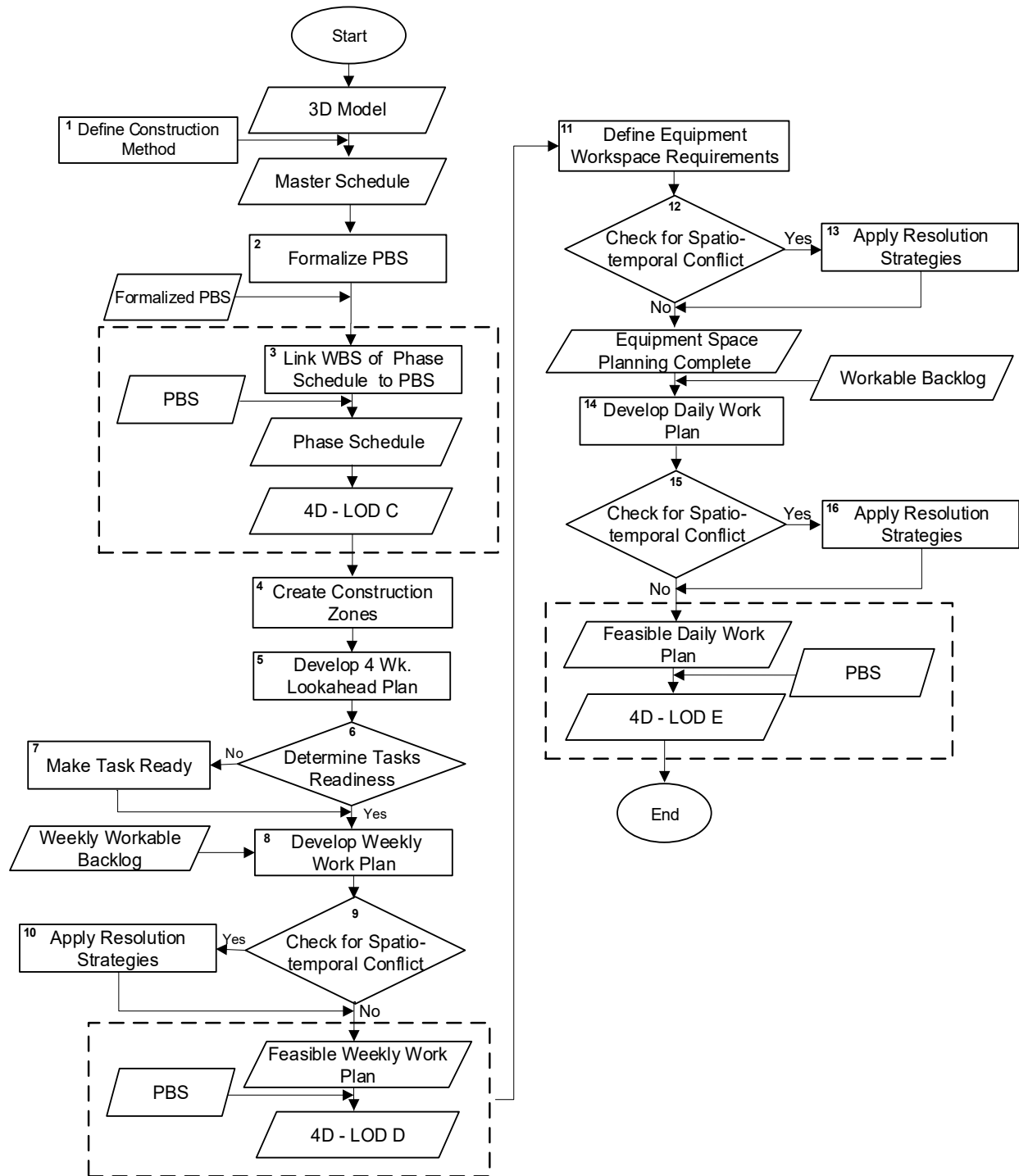

Figure 5.8: Framework for integrating the LPS and detailed 4D model for equipment space planning

**Step 5: Develop a four-week lookahead plan.** The phase schedule is decomposed using the LPS into a 30 days lookahead plan by breaking down the work into operations. The lookahead plan helps to identify and remove constraints that may affect the work plan. It identifies the work that can be done by matching the workflow to capacity, maintaining a balance of work to minimize downtime and develop weekly plans for how the work will be completed. Matching workflow to capacity is the main advantage of the LPS over other scheduling techniques.

**Step 6: Determine task readiness.** Constraints analysis is carried out to ascertain the ‘readiness’ of tasks to be added to the WWP. Tasks for inclusion in the WWP are assessed based on some criteria (Table 5.2 adapted from Ballard 2000). Tasks that fulfil all the criteria are referred to as “Ready Tasks” and included in the WWP.

Table 5.2: Quality criteria for evaluating tasks for commitment planning (adapted from Ballard 2000)

Quality criterion	Question to answer
Definition	Is the task defined so that workers understand what, when, where and with what to realize the task?
Soundness	Have all constraints been removed prior to the plan period?
Sequence	Is the task adequately sequenced?
Integrity	Has the plan sequence been simulated using 4D to detect conflicts?
Size	Does workload match the capability of those who are to perform the task?

**Step 7: Make tasks ready.** Tasks that do not fulfil the criteria in the previous step are required to be “Made Ready.” The primary consideration of “making tasks ready” is to ensure the removal of constraints based on the quality criteria and other project-specific constraints. Usually, some tasks are made ready before the execution week and subsequently included in the WWP.

**Step 8: Develop weekly work plans.** This step is the output of steps 6 and 7. All unconstrained plans from step 6 and plans that can have their constraints removed before the execution week from step 7 are included in the WWP. The workable backlog (excess tasks that are ready but not urgent are moved to the fallback list to be executed in case of available capacity during execution) are also included in the WWP. This step also includes checking for schedule conflicts by determining the activity logic to check for temporal constraints.

**Steps 9:** *Check for spatio-temporal conflicts.* The next step involves checking for spatio-temporal conflicts between the product space and other types of spaces (e.g. laydown space, safety space). Three types of conflicts are assessed, challenging conflicts (two components are occupying the same space), soft conflicts (occurs when an element is not given the spatial or geometric tolerances it requires) and workflow conflicts. The workflow conflicts have been addressed in steps 5-7. Hard and soft conflicts are checked using different techniques (e.g. bounding box, constructive solid geometry). However, very few 4D software tools have in-built capacities to perform spatio-temporal analysis.

**Step 10:** *Apply conflict resolution strategies.* If spatio-temporal conflicts are detected, the rule-based heuristics (Figure 5.7) is applied to resolve any potential conflict. The conflict-free WWP is regarded as the FWWP, and a 4D-LOD D representing operational fieldwork is obtained.

**Step 11:** *Define equipment workspace requirements.* To facilitate the equipment workspace, the workspace requirement for activities on the FWPP is determined. The activity workspace is a combination of various workspace. These spaces combined are the “required space,” typically based on the “available space.”

**Steps 12 & 13** involve repeating steps 9 & 10 to check for and resolve spatio-temporal conflicts resulting from the equipment workspace requirements.

**Step 14:** *Develop a daily work plan.* The last planners develop the Daily Work Plan (DWP). Steps 9 & 10 are repeated to obtain the Feasible Daily Work Plan (FDWP). The 4D model, at this stage, has the required level of abstraction required (LOD-E) for micro-scheduling the short duration activities involving the use of the equipment and provides an accurate representation and visualization of the equipment space usage. The resultant 4D model is designated as 4D-LOD E representing detailed equipment movement and workspaces.

**5.2.1. Case Study**

The framework is implemented using a case study. The case study is inspired by the Turcot Interchange reconstruction project in the city of Montreal, Quebec-Canada. The interchange is a major passenger and freight transportation axis, used by more than 300,000 vehicles per day and has reached the end of its useful life after more than 50 years of service (Ministry of transport 2017). Some of the challenges encountered in this project include managing spatio-temporal clashes resulting from phased deconstruction and reconstruction works and managing the workflow and schedule. The case study focused on installing 28 bridge precast deck panels consisting of 128 short-duration activities, two crawler cranes and two trucks for hauling. The implementation of the case study was achieved in Fuzor 4D software (Kallotech 2017). The case study workflow is shown in Figure 5.9.

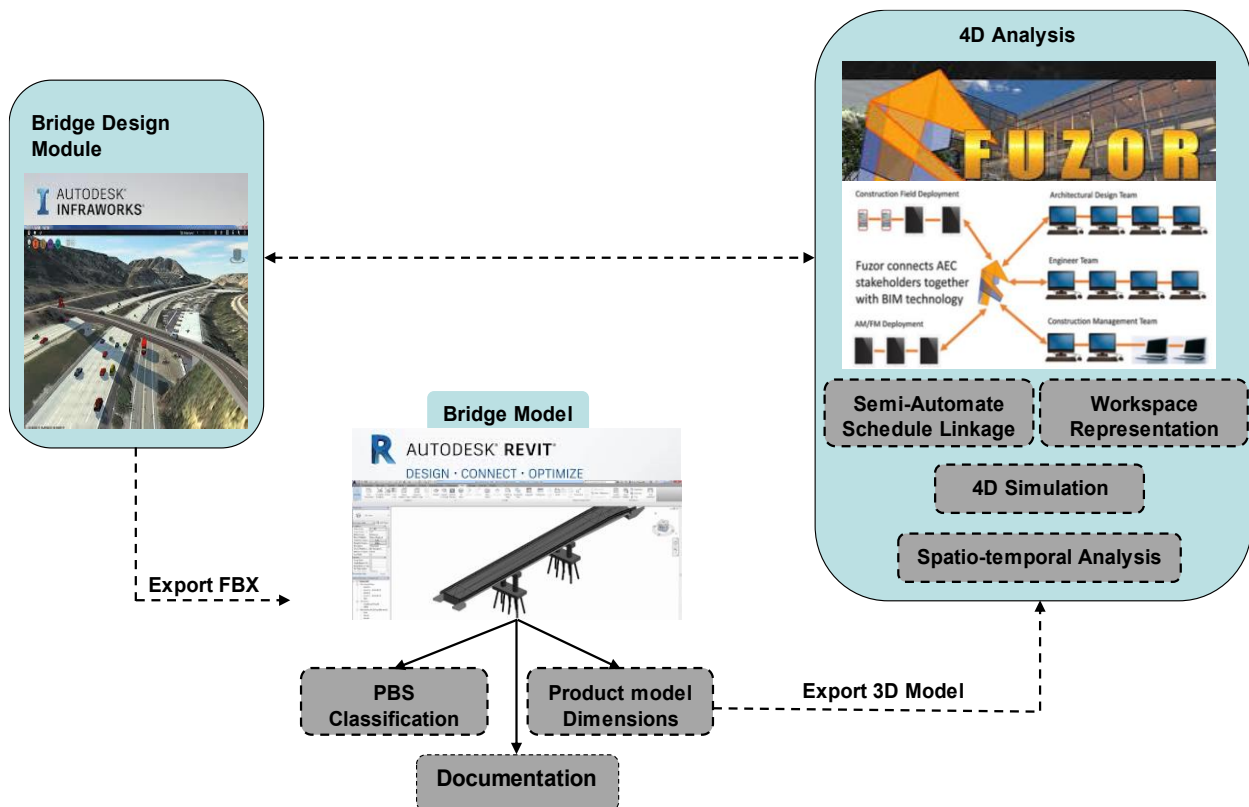

Figure 5.9: Case study workflow

The 3D model (Figure 5.10) was created in a 3D modelling software (Autodesk Infracore) and exported in fbx format into Revit (Autodesk 2019) to allow for the classification of the PBS. Classifying the PBS allows for the easy exchange and retrieval of information about the bridge model and facilitates the WBS creation.



Figure 5.10: Infracore bridge model

This study advocates using the Autodesk classification manager for Revit (Figure 5.11) for formalizing the PBS. This classification system has a distinct advantage over other stand-alone classification systems as it includes the Uniclass 2015, OmniClass, Uniformat and MasterFormat, IFC4, ASTM E1557-Uniformat II and FCIM space databases, is easy to use, fully customizable and can be integrated with other classification to facilitate interoperability between different classification systems.

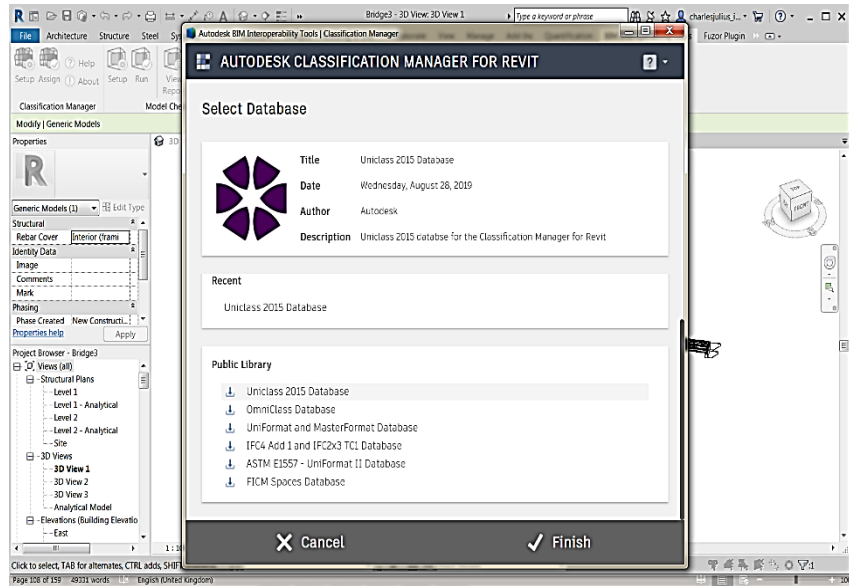

Figure 5.11: Autodesk classification manager for Revit

and size.

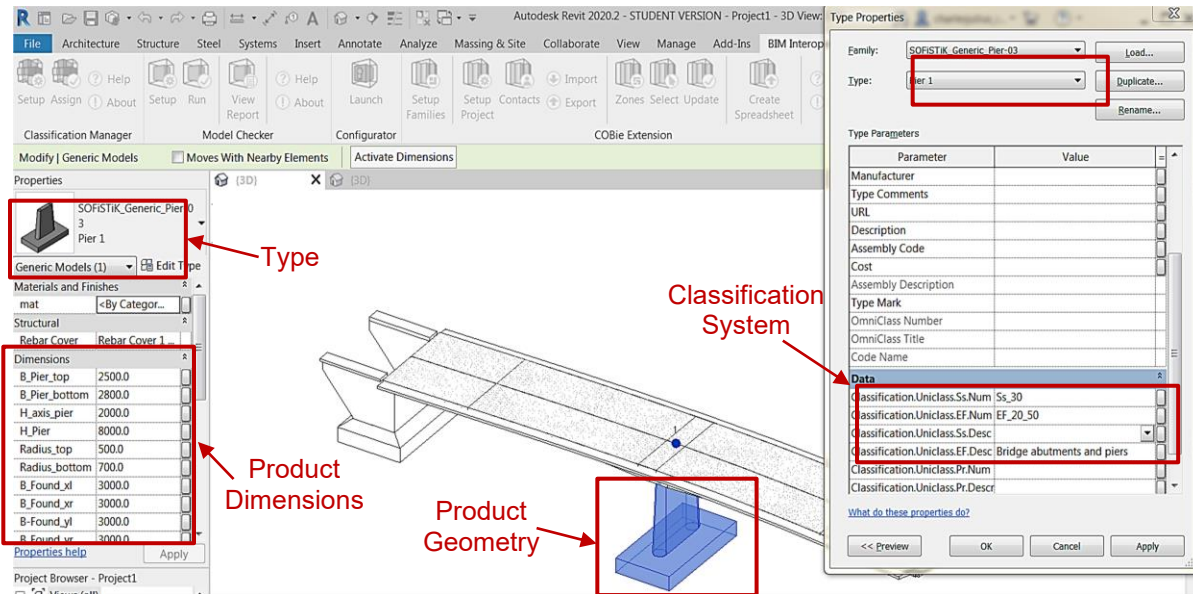

Figure 5.12: Snapshot of Bridge model in Revit

The 3D model was then exported from Revit into an interchangeable format suitable for the 4D modelling software (Fuzor) (Kallotech 2020) and linked with the phase schedule (provided by the project manager in the case study project) to obtain the 4D LOD C representing the contractual baseline at the time of the bid. To facilitate workspace planning and the decomposition



of the phase schedule into WWP, the case project was divided into different work zones (Figure 5.13).

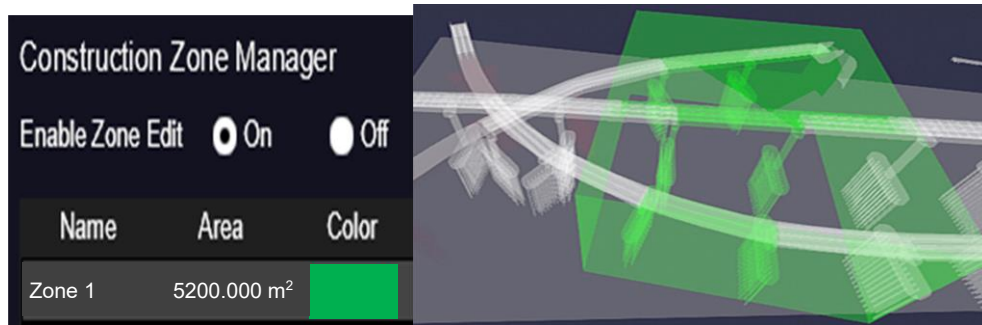

Figure 5.13: Construction work zone

The phase schedule is further decomposed into the lookahead schedule (based on the process highlighted in Figure 5.5: Lookahead planning process) by ensuring that only tasks that fulfil the quality criteria (Table 2.4: Quality criteria for evaluating tasks for commitment) are included in the WWP. The lookahead filter (Figure 5.14) is used to filter the schedule based on the lookahead planning horizon to make it easier to plan and sequence the tasks properly.



The LPS emphasizes constraints identification and removal to ensure that work plans can be actualized. Typical constraints identified in the case study project are shown in Table 5.3. These constraints are typical of urban highway projects.

Table 5.3: Different types of constraints and purpose

Constraint	Purpose
Traffic management	Ensure minimal disruption of traffic by making sure that the task will not overly impact the traffic management plan

Constructability	Ensure the uninterrupted execution of the planned work, availability of complete design, and avoiding design changes
Resource availability	Ensure the availability of materials, equipment, machinery and workers
Environmental and social	Ensure fair weather and safe working conditions.
Spatio-temporal	Ensure the availability of sufficient space for activity execution
Prerequisite work	Ensure the completion of prerequisite activities

The main constraints identified in the case study project were traffic management and spatio-temporal. Creating the work zones helped put these constraints into perspective and subsequently aided in their resolution. The unconstrained WWP fulfilling the quality criteria (Table 5.2: Quality criteria for evaluating tasks for commitment planning) is regarded as the FWWP. The workspace requirements identification procedure detailed in Figure 5.6: Workspace requirements identification is subsequently applied to obtain the activity workspaces.

The project manager devised the activity execution plan in the case project, and the required activities workspaces were determined based on the object attributes of tasks in the FWWP. Selecting a task on the schedule reveals the object attribute, such as its size and the work zone assigned. Figure 5.15 shows the activity “deck installation.” Figure a highlights the activity schedule. Figure b highlights the product model based on the activity selected, while figure c shows the object’s volume. The level of detail at this stage is the 4D-LOD D for operational fieldwork.

ID	Obj #	Name	Simulate Planned		
			P.Duration	Planned Start	Planned End
<div style="display: flex; justify-content: space-between;"> <span>Expand All</span> <span>Collapse All</span> </div>					
1.2	0	+ Abutment	46 days	3/19/2020	5/21/2020
1.3	0	+ Pier	22 days	4/2/2020	5/1/2020
2	0 (12)	- Superstructure Constr	41 days	5/4/2020	6/29/2020
2.1	0	+ Girders	17 days	5/4/2020	5/26/2020
2.2	0 (12)	- Deck	9 days	5/27/2020	6/8/2020
2.2.1	0 (12)	- Deck Installation	9 days	5/27/2020	6/8/2020
2.2.1.1	2	Deck Slabs & Ro	5 days	5/27/2020	6/2/2020
2.2.1.2	0	Loading of Precat	2 days	6/3/2020	6/4/2020
2.2.1.3	10	Installation of Pre	2 days	6/5/2020	6/8/2020
2.3	0	+ Gabion Mattress	15 days	6/9/2020	6/29/2020

(a) Activity selection

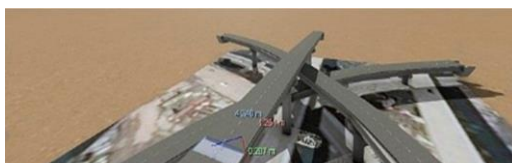

Object Volume: 2.411 m<sup>3</sup>

Installation of Precast Deck

Figure 5.15: 4D-LOD D: Operational fieldwork

To obtain the 4D-LOD E, which represents the equipment movement and workspaces, the equipment is selected from the equipment library of the 4D tool. The equipment selection is based on the equipment geometry and the available workspace. Figure 5.16a shows the equipment selection module, while figure b shows the equipment attribute to ensure the correct equipment size is selected.

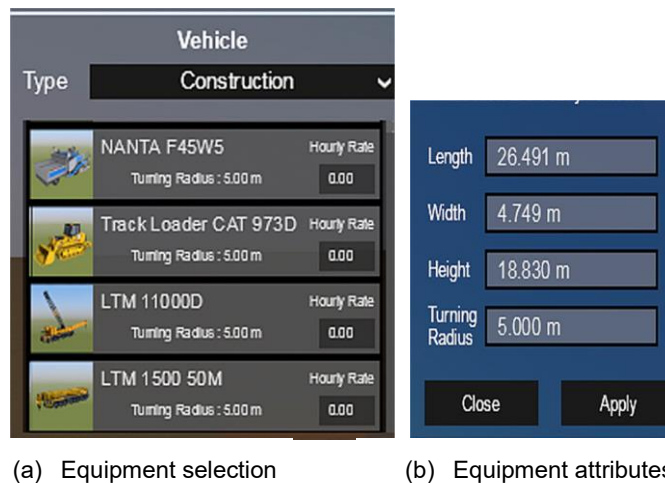

Figure 5.16: Equipment selection

After that, the Bounding Box (BB) method was applied to generate the workspace around the extents of the equipment and bridge product to be installed (Figure 5.17). The BB's geometry is also saved and stored within the 4D software and can be easily extracted to facilitate spatio-temporal analysis for potential conflicts in the activity workspaces. This represents an advancement compared to most previous studies where the workspaces were generated in the

3D authoring tool or, in the case where they were generated in the 4D tool, could not easily store and retrieve the workspaces.

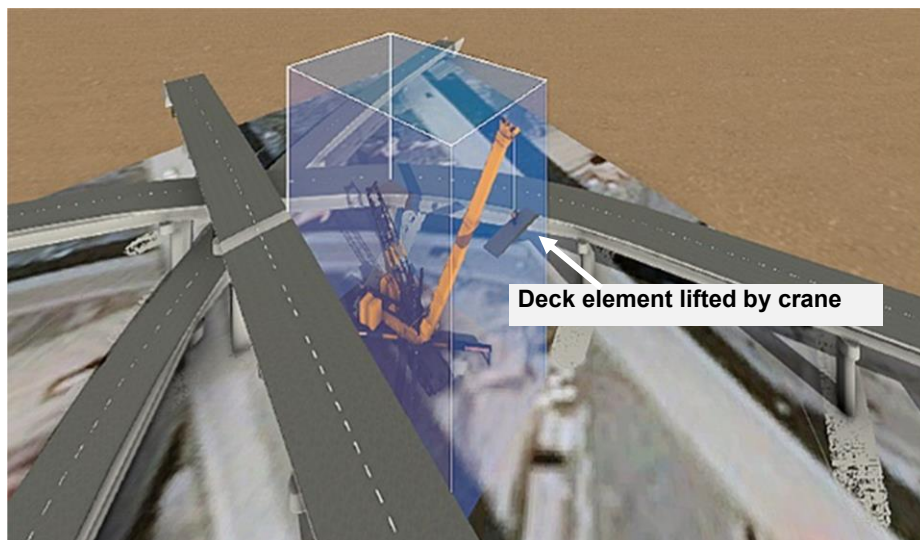

Figure 5.17: Equipment workspace representation

After representing the work-space occupation of the selected activities with the BB, spatio-temporal conflict analysis is performed within the 4D environment to check for spatio-temporal conflicts. Table 5.4 shows the results of the spatio-temporal analysis. Ten workspace problems were identified during the spatio-temporal analysis relating to hard clashes, i.e. construction clash (interference between physical components) and seven relating to soft clashes (interference between clearance volumes and workspaces). The view column helps to focus on the clash (e.g. NewClash\_1 in Figure 5.19). A clash was observed between the girder's clearance volume and the pier based on the tolerance level. The tolerance level is used to assign clash tolerance. A

higher tolerance will filter out minor intersections. To resolve the detected clash, the tolerance level was increased.

Table 5.4: Clash analysis output 1

<input checked="" type="checkbox"/> Report	Clash Name	Type	View	Stage	Level	Grid Intersection	Assigned To
<input checked="" type="checkbox"/>	NewClash_1	Construction	<input checked="" type="checkbox"/>	Active	Level 1		None
<input checked="" type="checkbox"/>	NewClash_2	Construction	<input type="checkbox"/>	Active	Level 1		None
<input checked="" type="checkbox"/>	NewClash_3	Construction	<input type="checkbox"/>	Active	Level 1		None
<input checked="" type="checkbox"/>	NewClash_4	Construction	<input type="checkbox"/>	Active	Level 1		None
<input checked="" type="checkbox"/>	NewClash_5	Construction	<input type="checkbox"/>	Active	Level 1		None
<input checked="" type="checkbox"/>	NewClash_6	Construction	<input type="checkbox"/>	Active	Level 1		None
<input checked="" type="checkbox"/>	NewClash_7	Construction	<input type="checkbox"/>	Active	Level 1		None
<input checked="" type="checkbox"/>	NewClash_8	Construction	<input type="checkbox"/>	Active	Level 1		None
<input checked="" type="checkbox"/>	NewClash_9	Temporary	<input type="checkbox"/>	Active	Level 1		None
<input checked="" type="checkbox"/>	NewClash_10	Construction	<input type="checkbox"/>	Active	Level 1		None
<input checked="" type="checkbox"/>	NewClash_11	Construction	<input type="checkbox"/>	Active	Level 1		None
<input checked="" type="checkbox"/>	NewClash_12	Equipment	<input type="checkbox"/>	Active	Level 3		None
<input checked="" type="checkbox"/>	NewClash_13	Temporary	<input type="checkbox"/>	Active	Level 3		None
<input checked="" type="checkbox"/>	NewClash_14	Temporary	<input type="checkbox"/>	Active	Level 3		None
<input checked="" type="checkbox"/>	NewClash_15	Equipment	<input type="checkbox"/>	Active	Level 3		None
<input checked="" type="checkbox"/>	NewClash_16	Equipment	<input type="checkbox"/>	Active	Level 3		None
<input checked="" type="checkbox"/>	NewClash_17	Equipment	<input type="checkbox"/>	Active	Level 3		None

Total Clashes: 17      New: 0      Active: 17      Resolved: 0  
Tolerance: 0.0032808401 ft

Item 1	
Element ID	115838
Category	Girder
WBS Code	1.16
Level	Superstructure

Item 2	
Element ID	92407
Category	Pier
WBS Code	1.15
Level	Substructure

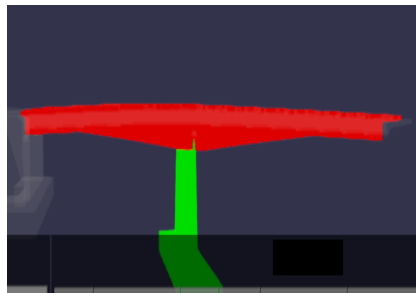

Figure 5.18: Graphical view of identified conflict

The equipment conflict is represented differently (Figure 5.20). The simulation automatically terminates when an equipment clash is detected to enable its resolution. The conflicts were resolved by applying the rule-based heuristics,



Figure 5.19: Equipment conflict warning

After a conflict-free equipment workspace is obtained based on the FWWP, the Daily Work Planning (DWP) process commences. To facilitate the timing of the tasks in the DWP, DES (See **Section 2.4.3. Construction Process Simulation Modelling.**) is applied. Applying DES helps to ensure that all the required processes and resources are identified. Activity Circle Diagram (ACD) is used to develop the simulation model. ACD's are the natural way to represent the DES activity paradigm (Kang and Choi 2010). An essential consideration in developing an ACD based DES model is identifying work tasks, the sequence of operation, available resources, logic of resource utilization, state and interaction among resources and outcome of work task. Table 5.5 shows the information utilized for building the simulation model (Figure 5.20) to install a precast deck slab using crawler cranes.

Table 5.5: Information to build ACD based DES model

Conditions for Activity to commence	Activity	Activity Outcome
<ul style="list-style-type: none"> <li>• Yard crane idle</li> <li>• Empty truck idle</li> <li>• Precast deck slab idle</li> <li>• Rigging team @ precast yard</li> </ul>	Loading of the precast deck slab	<ul style="list-style-type: none"> <li>• Precast deck slab loaded</li> <li>• Truck ready to haul</li> <li>• Yard crane idle</li> </ul>
<ul style="list-style-type: none"> <li>• Not applicable</li> </ul>	The arrival of precast concrete deck slab to the site for installation	<ul style="list-style-type: none"> <li>• Crawler crane ready for load</li> <li>• Truck ready to be offloaded</li> <li>• Precast deck slab idle</li> </ul>
<ul style="list-style-type: none"> <li>• Crawler crane ready to lift precast deck</li> <li>• Loaded truck ready to be offloaded</li> <li>• Rigging team idle</li> </ul>	Positioning crane, rigging the load	<ul style="list-style-type: none"> <li>• Loaded crawler crane lifts load</li> <li>• Unloaded truck ready to return</li> </ul>

	Positioning of the precast deck slab for placement	<ul style="list-style-type: none"> <li>Precast deck slab idle on the crawler crane</li> <li>Precast deck slab ready for placement</li> </ul>
•	Placing of the precast deck slab	<ul style="list-style-type: none"> <li>Unloaded crawler crane idle</li> <li>Precast deck slab placed</li> <li>Rigging team idle</li> </ul>
• Unloaded crawler crane idle	Repositioning of crane	<ul style="list-style-type: none"> <li>Crawler crane ready for load</li> </ul>

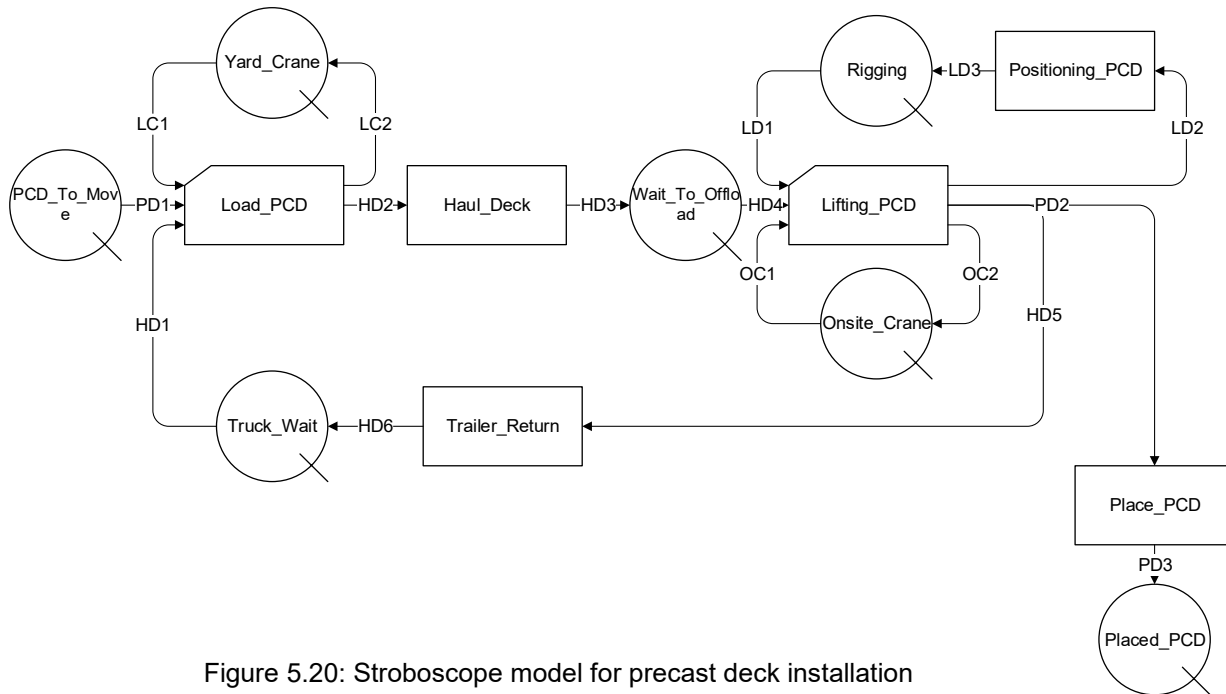

Figure 5.20: Stroboscope model for precast deck installation

The simulated duration represents the real-world system and needs to be validated by the LPS (which is based on commitment planning). The spatio-temporal checking process is repeated, and any potential conflicts are resolved by applying rule-based heuristics. Table 5.6 shows the clash analysis output after the application of rule-based heuristics.

Table 5.6: Clash analysis output 2

Report	Clash Name	Type	View	Stage	Level	Grid Intersection	Assigned To
<input checked="" type="checkbox"/>	NewClash_1	Construction	<input checked="" type="checkbox"/>	Resolved	Level 1		None
<input checked="" type="checkbox"/>	NewClash_2	Construction	<input type="checkbox"/>	Resolved	Level 1		None
<input checked="" type="checkbox"/>	NewClash_3	Construction	<input type="checkbox"/>	Resolved	Level 1		None
<input checked="" type="checkbox"/>	NewClash_4	Construction	<input type="checkbox"/>	Resolved	Level 1		None
<input checked="" type="checkbox"/>	NewClash_5	Construction	<input type="checkbox"/>	Resolved	Level 1		None
<input checked="" type="checkbox"/>	NewClash_6	Construction	<input type="checkbox"/>	Resolved	Level 1		None
<input checked="" type="checkbox"/>	NewClash_7	Construction	<input type="checkbox"/>	Resolved	Level 1		None
<input checked="" type="checkbox"/>	NewClash_8	Construction	<input type="checkbox"/>	Resolved	Level 1		None
<input checked="" type="checkbox"/>	NewClash_9	Temporary	<input type="checkbox"/>	Resolved	Level 1		None
<input checked="" type="checkbox"/>	NewClash_10	Construction	<input type="checkbox"/>	Resolved	Level 1		None
<input checked="" type="checkbox"/>	NewClash_11	Construction	<input type="checkbox"/>	Resolved	Level 1		None
<input checked="" type="checkbox"/>	NewClash_12	Equipment	<input type="checkbox"/>	Resolved	Level 3		None
<input checked="" type="checkbox"/>	NewClash_13	Temporary	<input type="checkbox"/>	Resolved	Level 3		None
<input checked="" type="checkbox"/>	NewClash_14	Temporary	<input type="checkbox"/>	Resolved	Level 3		None
<input checked="" type="checkbox"/>	NewClash_15	Equipment	<input type="checkbox"/>	Resolved	Level 3		None
<input checked="" type="checkbox"/>	NewClash_16	Equipment	<input type="checkbox"/>	Resolved	Level 3		None
<input checked="" type="checkbox"/>	NewClash_17	Equipment	<input type="checkbox"/>	Resolved	Level 3		None

Total Clashes: 17    New: 0    Active: 0    Resolved: 17



The output of the equipment planning process is a 4D-LOD E representing the detailed equipment movements and workspaces. Snapshots of the equipment workspace simulation are shown in Figure 5.21.



Figure 5.21: Snapshots of equipment simulation

The case study only considered the installation of one type of bridge component. In practice, the equipment workspace requirement for all the bridge components needs to be determined.

### **5.3. Summary**

Many workers, equipment and materials share limited space during construction. Since space constraints can inhibit productivity, it is essential to detect and analyze workspace conflicts in advance. Current approaches for identifying equipment related spatial conflicts are based on discrete event simulation of dynamic equipment motion. However, the accuracy of spatial conflicts



detected using such approaches is error-prone since it depends on the time increment rate for the simulation to be set by the user. In large and complex projects, the use of 4D modelling can help provide advance information about spatiotemporal clashes. 4D simulation allows the construction team to comprehend space utilization at various stages of the project while visually identifying potential conflicts before they occur. An ideal 4D model development should facilitate synergy between the 4D modelling process and the task scheduling without requiring the planners' extra effort and provide visual or analytical clues to the construction planner during the modelling process. A convenient and efficient modelling approach should provide visual clues and analytical functionalities to facilitate the planner's decision-making process. However, producing a 4D model with a sufficient level of detail is laborious and time-consuming.

Moreover, very little work has been carried in the domain of equipment workspace analysis; hence this research, to account for this shortcoming. A conceptual framework for equipment workspace planning was introduced. The framework seeks to address limitations in the development of 4D simulations in equipment workspace planning and representation. It promotes greater collaboration and coordination using the LPS when planning the space requirements for equipment during task execution

## **CHAPTER 6 : CONCLUSIONS AND FUTURE WORK**

This research investigated the interaction between lean construction and 3D model for equipment workspace planning in elevated urban reconstruction projects. A literature review conducted revealed a dearth of research on the implementation of LC tools/techniques on highway projects, and some criteria required for the implementation of LC on highway projects were revealed. Another observation from the literature was a lack of research on equipment space planning and visualization on highway projects. To address both problems, a 4D based framework was introduced. This framework integrated the last planner system (LPS), a lean technique in a 4D model with a different level of development (LOD) and highlighted attributes required for equipment space planning. The framework was evaluated using a case study. Therefore, the rest of this chapter will provide conclusions based on the preceding chapters, the major work undertaken in this study, and the summarised research contributions. Direction for future research are identified and discussed

### **6.1. Summary of the Research Work**

This research aimed to integrate the last planner system of construction planning in a detailed 4D model for equipment workspace planning in elevated urban highway projects using a process-based approach. The process-based approach facilitated specifying the LOD requirements for 4D models for equipment workspace planning. To realize the research's aim of integrating the LPS and detailed 4D model for equipment workspace planning in elevated urban highway reconstruction projects, five objectives were specified. To achieve the first two objectives, i.e. (1) review the scope of research on lean construction in vertical construction and its extension to horizontal construction and suggest lean construction tools/techniques intended to maximize value and eliminate waste on highway reconstruction projects, and (2) investigate and suggest the best use applications of 4D models for highway construction, a comprehensive literature review was conducted. The review highlighted the current research scope on LC and its

application on highway projects and elucidated how the LPS, an LC technique, can improve the construction planning process. Currently, much of the scheduling is undertaken using the heuristic knowledge of construction planners without much consideration given to the last planners' inputs.

An investigation of the use of 4D simulation for workspace planning revealed some common assumptions and limitations in the 4D modelling approach typically adapted for workspace planning. It also emerged from the literature that spatio-temporal conflicts are a significant problem on the construction site, more so during the reconstruction of elevated urban highways where space is a scarce resource. Some work has been undertaken to detect time-space conflicts using 4D simulation modelling. However, these efforts have mainly been concentrated in the building domain. These efforts have also been static and failed to consider micro-scheduling and the dynamic nature of equipment workspaces. The literature review also revealed the prevalence of non-value adding activities (wastes) in the construction industry leading to objective (3) rank the LC wastes based on their influence on the transformation, flow and value processes in construction. The results reveal making-do, waiting, and overproduction as the highest-ranked waste affecting the transformation, flow, and value aspects of construction, respectively. This led to objective (4) categorizing and ranking the factors that promote LC waste in urban highway projects based on the TFV model and propose a two-step multi-criteria decision-making method to formalize project scheduling techniques in elevated urban highway projects. The factors contributing to non-physical wastes were identified and ranked using the AHP. The results reveal planning and scheduling as the most critical waste factor contributing to the transformation phase of construction projects. The CBA method was applied to select a suitable planning and technique for elevated urban highway projects, and the results revealed the LPS as a method suitable for urban highway projects due to its ability to accommodate workspace planning and its facilitation of collaboration and communication, especially during the project execution phase. Objective (5) was the development of a process-based conceptual framework for equipment workspace planning. This framework showed how the LPS could be integrated into

a 4D model. The process-based conceptual framework also specified the LOD requirements for equipment workspace planning. Finally, the developed framework was implemented and validated using a case study approach.

One important consideration in the application of the LPS is the need to emphasize people over systems. People are required to drive any meaningful change within a process or an organization. This is highlighted by the role the last planners play in the development of a reliable schedule through commitment-based planning. It, therefore, becomes imperative that more emphasis be placed on the development of people rather than systems. Systems, policies and procedures don't run themselves, people do.

### 6.2. Research Contributions

The following contributions were made to the body of knowledge by the research:

(1) The influence of LC wastes on the TFV model of construction was ascertained by ranking them based on how they affect the three main phases of the TFV process. With regards to this contribution, the following conclusions can be drawn:

- The LC wastes have different degrees of influence on the TFV process.
- Making-do has the most significant influence on the transformation aspect of construction. The transformation aspect of construction is linked to the project execution phase. The process of making-do ensures that resources are available and match the capacity required to produce the desired results by removing constraints.
- In the flow aspect of construction, the waste of “waiting” has the highest impact.
- The waste of overproduction affects the value phase more than the transformation or flow phase.
- Most causes of wastes are due to the weakness of the performing organization's management system, it can thus be surmised that there is a close relationship between

waste, value, and organization management system and efficiency in project performance.

(2) Categorized and ranked the factors LC wastes in urban highway projects based on the TFM model and proposed a two-step MCDM to formalize project scheduling techniques in elevated urban highway projects. In the first step of the two-step MCDM technique, the AHP was utilized to derive priority weights for the identified factors. Therefore, the second part of the two-step MCDM method focused on formalizing the process for selecting project planning and scheduling techniques applicable to urban highway projects using the CBA. The following conclusions can be drawn based on this contribution:

- Poor planning and scheduling is the highest contributory factor in the transformation phase of projects.
- There is a formalized process for selecting the project planning and scheduling method for different projects. The choice of the project planning and scheduling technique is usually influenced by the history of the performing organizations' previous projects and the project management office.
- A formalized process for selecting project planning and scheduling applicable to urban highway projects revealed the LPS is best suited for urban highway projects when the focus is on micro-level scheduling and equipment workspace planning.

(3) Developed a conceptual framework for integrating the LPS and detailed 4D modelling for equipment workspace planning and specify the 4D-LOD. The following conclusions can be drawn based on this contribution:

- Research efforts in 4D modelling have not considered the 4D-LOD requirements for elevated highway projects.
- Integrating the LPS in the 4D modelling process and specifying the 4D-LOD for equipment workspaces is expected to become increasingly crucial as transportation

developments shift from new highways to the rehabilitation and reconstruction of existing ones.

- Defining and adopting 4D-LOD is an important consideration for workspace management studies, especially in urban highway projects, to provide a more realistic 4D simulation.
- The developed method will help construction practitioners effectively plan the workspace required for construction equipment in areas with high space demands.

### 6.3. Limitations and Recommendations for Future Works

A new approach to equipment workspace planning was proposed. However, some limitations which were identified are:

1. **The process of generating the 4D simulation for the equipment workspace is laborious and very time-consuming.**

Across the literature, there is a lack of consensus on the actual gains achieved from implementing 4D modelling compared to the time and effort required to achieve the modelling. In generating the 4D simulation of equipment, it was required to micro-schedule the task involving the equipment and then simulating the equipment coupled with the task. For large projects involving many different equipment and activities, this process becomes cumbersome due to the very low level of abstraction required for the modelling.

2. **The approach for equipment workspace representation within the 4D software is not dynamic.**

The equipment workspace is typically represented using bounding boxes or constructive solid geometry to facilitate spatio-temporal analysis. However, this representation is static and not dynamic. The implication is that each time the position of the equipment is changed, it will be required to represent a new workspace as opposed to a dynamic representation where the represented workspace moves with the equipment.

**3. Manual linking of schedule to the 3D model.**

Linking of the schedule to the 3D model is done manually. This becomes difficult as the size and complexity of the project increases.

**4. Only one type of construction method was considered in the 4D simulation of the equipment workspace.**

There are different construction methods employed in bridge construction projects. However, only one method was considered in the 4D simulation. A more robust simulation would consider the other construction methods and compare the workspace requirements for the different methods.

**6.5. Recommendations for Future Works**

Several future research areas were identified and includes:

**1. Application of Agent-Based System (ABS) to simulate the activity of the last planners.**

It is vital to apply simulation to better understand the last planners' decision-making, and ABS provides a means of doing this based on the low level of abstraction requires and the ability to model.

**2. Extending the schedule LOD from level 5 to 6 to account for micro-level planning capable of accommodating short-duration activities.**

Currently, level 5 is the lowest level of abstraction for construction schedules based on the LOD approach. However, this does not accurately represent the LOD required to accommodate construction planning on an hourly basis.

**3. Semi-automated methods for generating high 4D-LOD models.**

The research's main limitation is the manual linking of the schedule to the 3D model. This process is laborious, time-consuming and error-prone, and is likely responsible for the lack of research on equipment workspace planning in urban highway projects. Hence, future works will consider a

process for semi-automating automating the process of linking the schedule with the 3D model to generate the 4D model.

#### **4. Ontology development methods**

BIM ontology is intended to represent knowledge interactions between BIM players, their deliverables and requirements. Presently, several research efforts focus on leveraging BIM models with discipline-specific information and information exchange between a BIM authoring program and discipline design tools (Lee 2014). It, however, remains challenging to tailor BIM to suit construction management tasks such as workspace planning. 4D models only describe the construction process. To effectively plan and simulate construction activities, the workspace requirements must be identified, generated and allocated. Therefore, an ontology-based approach for describing and extracting workspace requirements is required to facilitate dynamic workspace planning.



---

## REFERENCES

- Abbasian-Hosseini, S., Nikakhtar, A., and Ghoddousi, P. (2014). "Verification of lean construction benefits through simulation modelling: A case study of bricklaying process." *KSCE Journal of Civil Engineering*, 18(5), 1248–1260.
- Abdullah, S., Abdul Razak, A., Bakar, A., Hassan, A., and Sarrazin, I. (2009). "Towards Producing Best Practice in the Malaysian Construction Industry: The Barriers in Implementing the Lean Construction Approach."
- AbouRizk, S. M., and Dozzi, S. P. (1993). "Application of computer simulation in resolving construction disputes." *Journal of construction engineering and management*, American Society of Civil Engineers, 119(2), 355–373.
- AbouRizk, S. M., Halpin, D. W., and Lutz, J. D. (1992). "State of the art in construction simulation." *Proceedings of the 24th conference on Winter simulation*, ACM, 1271–1277.
- Abudayyeh, O., Zidan, S. J., Yehia, S., and Randolph, D. (2007). "Hybrid Prequalification-Based, Innovative Contracting Model Using AHP." *Journal of Management in Engineering*, 23(2), 88–96.
- Agbulos, A., Mohamed, Y., Al-Hussein, M., AbouRizk, S., and Roesch, J. (2006). "Application of lean concepts and simulation analysis to improve the efficiency of drainage operations maintenance crews." *Journal of Construction Engineering and Management*, American Society of Civil Engineers, 132(3), 291–299.
- Ahuja, V., and Thiruvengadam, V. (2004). "Project scheduling and monitoring: current research status." *Construction Innovation*, Emerald Group Publishing Limited, 4(1), 19–31.
- Ailland, K., Bargstädt, H.-J., and Hollermann, S. (2010). "Construction process simulation in bridge building based on significant day-to-day data." *Simulation Conference (WSC), Proceedings of the 2010 Winter*, IEEE, 3250–3261.
- Akadiri, P. O., Olomolaiye, P. O., and Chinyio, E. A. (2013). "Multi-criteria evaluation model for

- the selection of sustainable materials for building projects.” *Automation in Construction*, Elsevier, 30, 113–125.
- Akhavian, R., and Behzadan, A. H. (2015). “Construction equipment activity recognition for simulation input modeling using mobile sensors and machine learning classifiers.” *Advanced Engineering Informatics*, Elsevier, 29(4), 867–877.
- Akinci, B., Fischen, M., Levitt, R., and Carlson, R. (2002a). “Formalization and automation of time-space conflict analysis.” *Journal of Computing in Civil Engineering*, American Society of Civil Engineers, 16(2), 124–134.
- Akinci, B., Fischer, M., and Kunz, J. (2002b). “Automated generation of workspaces required by construction activities.” *Journal of Construction Engineering and Management*, American Society of Civil Engineers, 128(4), 306–315.
- Akinci, B., Fischer, M., Kunz, J., and Levitt, R. (2002c). “Representing workspaces generically in construction method models.” *Journal of Construction Engineering and Management*, American Society of Civil Engineers, 128(4), 296–305.
- Al-Harbi, K. M. A.-S. (2001). “Application of the AHP in project management.” *International Journal of Project Management*, Elsevier, 19(1), 19–27.
- Alaloul, W. S., Liew, M. S., and Zawawi, N. A. W. (2015). “Delphi technique procedures: A new perspective in construction management research.” *Applied Mechanics and Materials*, Trans Tech Publ, 661–667.
- Alarcon, L. F. (1997). “Tools for the identification and reduction of waste in construction projects.” *Lean Construction*, L. Alarcon, ed., Balkema, Rotterdam, The Netherlands, Netherlands, 365–377.
- Alarcón, L. F., Diethelm, S., Rojo, O., and Calderón, R. (2011). “Assessing the impacts of implementing lean construction.” *Revista ingeniería de construcción*, 23(1), 26–33.
- Alarcon, L. F., Diethelmand, S., Rojo, O., Alarcón, L. F., Diethelm, S., and Rojo, O. (2002). “Collaborative implementation of lean planning systems in Chilean construction companies.”

- International Group of Lean Construction*, C. T. Formoso and G. Ballard, eds., IGLC, Brazil, 541–551.
- Alarcon, L. F., and Seguel, L. (2002). “Developing Incentive Strategies for Implementation of Lean Construction.” *10th Annual Conference of the International Group for Lean Construction*, C. T. Formoso and G. Ballard, eds., International Group for Lean Construction, Brazil, 403–414.
- Albiñana, J. C., and Vila, C. (2012). “A framework for concurrent material and process selection during conceptual product design stages.” *Materials & Design*, Elsevier, 41, 433–446.
- Alhassan, M. (2011). *State-of-the-art report on full-depth precast concrete bridge deck panels*. Precast/Prestressed Concrete Institute (PCI), Chicago.
- Ali, H. H., and Al Nsairat, S. F. (2009). “Developing a green building assessment tool for developing countries—Case of Jordan.” *Building and Environment*, Elsevier, 44(5), 1053–1064.
- Alinaitwe, H. M. (2009). “Prioritising lean construction barriers in Uganda’s construction industry.” *Journal of Construction in Developing Countries*, Universiti Sains Malaysia, 14(1), 15–30.
- AlSehaimi, A., Tzortzopoulos, P., and Koskela, L. (2009). “Last Planner System: Experiences From Pilot Implementation in the Middle East.” *International Group of Lean Construction*, Y. Cuperus and E. H. Hirota, eds., IGLC, Taiwan, 53–66.
- Alshibani, A., and Moselhi, O. (2016). “Productivity based method for forecasting cost & time of earthmoving operations using sampling GPS data.” *ITcon*, 21, 39–56.
- Alves, T. da C. L., Tommelein, I. D., and Ballard, G. (2006). “Simulation as a Tool for Production System Design in Construction.” *14th Annual Conference of the International Group for Lean Construction*, 341–353.
- Alwi, S., Hampson, K. D., and Mohamed, S. A. (2002a). “Non value-adding activities in Australian construction projects.”
- Alwi, S., Hampson, K., and Mohamed, S. (2002b). “Non Value-Adding Activities: A Comparative Study of Indonesian and Australian Construction Projects.” *10th Annual Conference of the*

- International Group for Lean Construction*, C. T. Formoso and G. Ballard, eds., 627–638.
- Amann, J., Borrmann, A., Center, L. O., and Gladbach, B. (2015). *Creating a 3D-BIM-compliant road design based on IFC alignment originating from an OKSTRA-accordant 2D road design using the TUM Open Infra Platform and the OKSTRA class library*. Technische Universität München, Cologne, Germany.
- Ameyaw, E. E., Hu, Y., Shan, M., Chan, A. P. C., and Le, Y. (2016). “Application of Delphi method in construction engineering and management research: a quantitative perspective.” *Journal of Civil Engineering and Management*, Taylor & Francis, 22(8), 991–1000.
- Andres, B., and Poler, R. (2016). “A review of approaches and tools for collaborative networks simulation.” *Brazilian Journal of Operations and Production Management*, Associação Brasileira de Engenharia de Produção (ABEPRO), 232–242.
- Antucheviciene, J., Zakarevicius, A., and Zavadskas, E. K. (2011). “Measuring congruence of ranking results applying particular MCDM methods.” *Informatica*, Vilnius University Institute of Mathematics and Informatics, 22(3), 319–338.
- Antucheviciene, J., Zavadskas, E. K., and Zakarevicius, A. (2012). “Ranking redevelopment decisions of derelict buildings and analysis of ranking results.” *Economic Computation and Economic Cybernetics Studies and Research*, 46(2), 37–62.
- Antunes, R., González, V. A., and Walsh, K. (2015). “Identification of Repetitive Processes at Steady- and Unsteady-state: Transfer Function.” *23rd Annual Conference of the International Group for Lean Construction*, O. Seppänen, V. A. González, and P. Arroyo, eds., 793–802.
- Arbulu, R. J., and Tommelein, I. D. (2002). “Value Stream Analysis of Construction Supply Chains: Case Study on Pipe Supports Used in Power Plants.” *10th Annual Conference of the International Group for Lean Construction*, C. T. Formoso and G. Ballard, eds., 183–195.
- Arroyo, P. (2014). “Exploring decision-making methods for sustainable design in commercial buildings.” UC Berkeley.

- Arroyo, P., Fuenzalida, C., Albert, A., and Hallowell, M. R. (2016a). "Collaborating in decision making of sustainable building design: An experimental study comparing CBA and WRC methods." *Energy and Buildings*, Elsevier, 128, 132–142.
- Arroyo, P., Tommelein, I. D., and Ballard, G. (2014). "Comparing AHP and CBA as decision methods to resolve the choosing problem in detailed design." *Journal of construction engineering and management*, American Society of Civil Engineers, 141(1), 4014063.
- Arroyo, P., Tommelein, I. D., and Ballard, G. (2015). "Selecting globally sustainable materials: A case study using Choosing by Advantages." *Journal of Construction Engineering and Management*, American Society of Civil Engineers, 142(2), 5015015.
- Arroyo, P., Tommelein, I. D., Ballard, G., and Rumsey, P. (2016b). "Choosing by advantages: A case study for selecting an HVAC system for a net zero energy museum." *Energy and Buildings*, Elsevier, 111, 26–36.
- Autodesk. (2019). "Revit: Built for Building Information Modelling." <<https://www.autodesk.com/products/revit/overview>> (Jan. 29, 2019).
- Ayarkwa, J., Agyekum, K., Adinyira, E., and Osei-Asibey, D. (2012). "Barriers to Successful Implementation of Lean Construction in the Ghanaian Building Industry." *Journal of construction*, Journal of Construction, 5(1).
- Azhar, S., Khalfan, M., and Maqsood, T. (2015). "Building information modelling (BIM): now and beyond." *Construction Economics and Building*, 12(4), 15–28.
- Aziz, R. F., and Hafez, S. M. (2013). "Applying lean thinking in construction and performance improvement." *Alexandria Engineering Journal*, Elsevier, 52(4), 679–695.
- Baker, D., Bridges, D., Hunter, R., Johnson, G., Krupa, J., Murphy, J., and Sorenson, K. (2002). *Guidebook to decision-making methods*. WSRC-IM-2002-00002, Department of Energy, USA.
- Baležentis, A., Baležentis, T., and Misiunas, A. (2012). "An integrated assessment of Lithuanian economic sectors based on financial ratios and fuzzy MCDM methods." *Technological and*

- Economic Development of Economy*, Taylor & Francis, 18(1), 34–53.
- Ballard, G. (1997). "Lookahead Planning: The Missing Link in Production Control." *5th Annual Conference of the International Group for Lean Construction*, S. N. Tucker, ed., 13–26.
- Ballard, G. (1999). "Improving Work Flow Reliability." *7th Annual Conference of the International Group for Lean Construction*, 275–286.
- Ballard, G. (2000). "The Last Planner System of Production Control." The University of Birmingham, Birmingham.
- Ballard, G. (2001). "Cycle Time Reduction in Home Building." *9th Annual Conference of the International Group for Lean Construction*, G. Ballard and D. Chua, eds.
- Ballard, G. (2008). "The lean project delivery system: An update." *Lean Construction Journal*, 1–19.
- Ballard, G., Harper, N., and Zabelle, T. (2003). "Learning to see workflow: an application of lean concepts to precast concrete fabrication." *Engineering, Construction and Architectural Management*, MCB UP Ltd, 10(1), 6–14.
- Ballard, G., and Howell, G. (1998). "Shielding production: essential step in production control." *Journal of Construction Engineering and management*, American Society of Civil Engineers, 124(1), 11–17.
- Ballard, G., and Howell, G. A. (2003). "An Update on Last Planner." *11th Annual Conference of the International Group for Lean Construction*.
- Ballard, G., and Tommelein, I. (2016). "Current process benchmark for the last planner system." *Lean Construction Journal*, 89, 57–89.
- Balubaid, M., and Alamoudi, R. (2015). "Application of the Analytical Hierarchy Process (AHP) to Multi-Criteria Analysis for Contractor Selection." *American Journal of Industrial and Business Management*, Scientific Research Publishing, 5(09), 581.
- Bansal, V. K. (2011). "Use of GIS and topology in the identification and resolution of space conflicts." *Journal of Computing in Civil Engineering*, American Society of Civil Engineers,

25(2), 159–171.

- Bargstädt, H. J., and Elmahdi, A. (2010). “Automatic generation of workspace requirements using qualitative and quantitative description.” *Proceedings of the 10th International Conference on Construction Applications of Virtual Reality*.
- Bashir, A. M., Suresh, S., Oloke, D. A., Proverbs, D. G., and Gameson, R. (2015). “Overcoming the challenges facing lean construction practice in the UK contracting organizations.” *International Journal of Architecture, Engineering and Construction*, International Association for Sustainable Development and Management, 4(1), 10–18.
- Bazjanac, V., and Crawley, D. B. (1997). “The implementation of industry foundation classes in simulation tools for the building industry.” *Lawrence Berkeley National Laboratory*.
- Beal, V. (n.d.). “Industry Foundation Classes.” *webopedia*, <[https://www.webopedia.com/TERM/I/Industry\\_Foundation\\_Classes.html](https://www.webopedia.com/TERM/I/Industry_Foundation_Classes.html)> (Nov. 30, 2018).
- Bekr, G. A. (2014). “Study of the causes and magnitude of wastage of materials on construction sites in Jordan.” *Journal of Construction Engineering*, Hindawi, 2014.
- Ben-Alon, L., and Sacks, R. (2017). “Simulating the behavior of trade crews in construction using agents and building information modelling.” *Automation in Construction*, Elsevier, 74, 12–27.
- Bertelsen, S., and Koskela, L. (2003). “Avoiding and Managing Chaos in Projects.” *11th Annual Conference of the International Group for Lean Construction*.
- Bhatla, A., and Leite, F. (2012). “Integration Framework of BIM with the Last Planner System.” *20th Annual Conference of the International Group for Lean Construction*, I. D. Tommelein and C. L. Pasquire, eds.
- Bhushan, N., and Rai, K. (2007). *Strategic decision making: applying the analytic hierarchy process*. Springer Science & Business Media.
- Bicheno, J. (2008). *The lean toolbox for service systems*. PICSIE books.
- BIM Acceleration Committee. (2016). “Levels of development definitions.” *The New Zealand BIM handbook: A guide to enabling BIM on building projects*, New Zealand.

- BIMFORUM. (2019). *Part I For Building Information Models Level of Development Specification*.
- Bohács, G., Gyimesi, A., and Rózsa, Z. (2016). "Development of an intelligent path planning method for materials handling machinery at construction sites." *Periodica Polytechnica Transportation Engineering*, 44(1), 13–22.
- Borrmann, A., Klaubert, C., and Günthner, W. A. (2009). "ForBAU The virtual construction site project." *CIB W78*.
- Bossink, B. A. G., and Brouwers, H. J. H. (1996). "Construction waste: quantification and source evaluation." *Journal of construction engineering and management*, American Society of Civil Engineers, 122(1), 55–60.
- Boton, C., Kubicki, S., and Halin, G. (2015). "The Challenge of Level of Development in 4D/BIM Simulation Across AEC Project Lifecycle. A Case Study." *Creative Construction Conference*, Elsevier, Krakow, Poland, 59–67.
- BuildingSMART. (2017). "IFC Alignment." *buildingSMART International: Home of openBIM*, <<http://www.buildingsmart-tech.org/infrastructure/projects/alignment>> (Nov. 30, 2018).
- Butkovic, B., Heesom, D., and Oloke, D. (2019). "The need for multi-LOD 4D simulations in construction projects." Kungliga Tenkniska Hoegskolan/Royal Institute of Technology.
- Cai, P., Cai, Y., Chandrasekaran, I., and Zheng, J. (2016). "Parallel genetic algorithm based automatic path planning for crane lifting in complex environments." *Automation in Construction*, Elsevier, 62, 133–147.
- Canadian Business Journal. (2013). "The Current State of Canada's Construction Industry." *The Canadian Business Journal*, <[http://www.cbj.ca/the\\_current\\_state\\_of\\_canada\\_s\\_construction\\_industry/](http://www.cbj.ca/the_current_state_of_canada_s_construction_industry/)>.
- Carbonari, A., Giretti, A., and Naticchia, B. (2011). "A proactive system for real-time safety management in construction sites." *Automation in construction*, Elsevier, 20(6), 686–698.
- Castillo, T., Alarcón, L. F., Salvatierra, J., and Alarcón, D. (2015). "Analyzing the Interrelation Between Management Practices, Organizational Characteristics and Performance



- Indicators for Construction Companies.” *23rd Annual Conference of the International Group for Lean Construction*, O. Seppänen, V. A. González, and P. Arroyo, eds., 691–700.
- Castka, P., Bamber, C. J., and Sharp, J. M. (2004). “Benchmarking intangible assets: enhancing teamwork performance using self-assessment.” *Benchmarking: An International Journal*, Emerald Group Publishing Limited, 11(6), 571–583.
- Chae, S. (2009). “Development of warning system for preventing collision accident on construction site.” *Proceedings of the 26th International Symposium on Automation and Robotics in Construction (ISARC 2009)*, Austin, TX, USA.
- Chae, S., and Yoshida, T. (2010). “Application of RFID technology to prevention of collision accident with heavy equipment.” *Automation in construction*, Elsevier, 19(3), 368–374.
- Chan, A. P. C., Darko, A., Ameyaw, E. E., and Owusu-Manu, D.-G. (2017). “Barriers affecting the adoption of green building technologies.” *Journal of Management in Engineering*, American Society of Civil Engineers, 33(3), 4016057.
- Chan, W.-H., and Lu, M. (2005). “Logistics and operations simulation in precast viaduct construction: case study.” *Computing in Civil Engineering (2005)*, 1–12.
- Chan, W.-H., and Lu, M. (2012). “Construction operations simulation under structural adequacy constraints: the Stonecutters Bridge case study.” *Proceedings of the Winter Simulation Conference*, Winter Simulation Conference, 261.
- Chau, K. W., Anson, M., and Zhang, J. P. (2004). “Four-dimensional visualization of construction scheduling and site utilization.” *Journal of Construction Engineering and Management*, American Society of Civil Engineers, 130(4), 598–606.
- Chavada, R. D., Kassem, M., Dawood, N. N., and Naji, K. K. (2012a). “A framework for construction workspace management: a serious game engine approach.” *Computing in Civil Engineering (2012)*, 57–64.
- Chavada, R., Dawood, N., and Kassem, M. (2012b). “Construction workspace management: the development and application of a novel nD planning approach and tool.” *Journal of*

- Information Technology in Construction*, International Council for Research and Innovation in Building and Construction.
- Cheng, T., and Teizer, J. (2013). "Real-time resource location data collection and visualization technology for construction safety and activity monitoring applications." *Automation in Construction*, Elsevier, 34, 3–15.
- Chi, S., and Caldas, C. H. (2011). "Automated object identification using optical video cameras on construction sites." *Computer-Aided Civil and Infrastructure Engineering*, Wiley Online Library, 26(5), 368–380.
- Cho, S., and Ballard, G. (2011). "Last Planner and Integrated Project Delivery." *Lean Construction Journal*.
- Cho, T., and Kim, T. S. (2008). "Probabilistic risk assessment for the construction phases of a bridge construction based on finite element analysis." *Finite Elements in Analysis and Design*, Elsevier, 44(6), 383–400.
- Choi, B., Lee, H.-S., Park, M., Cho, Y. K., and Kim, H. (2014). "Framework for work-space planning using four-dimensional BIM in construction projects." *Journal of Construction Engineering and Management*, American Society of Civil Engineers, 140(9), 4014041.
- Chong, H. Y., Lopez, R., Wang, J., Wang, X., and Zhao, Z. (2016). "Comparative analysis on the adoption and use of BIM in road infrastructure projects." *Journal of Management in Engineering*, American Society of Civil Engineers, 32(6), 5016021.
- Chou, J.-S., Pham, A.-D., and Wang, H. (2013). "Bidding strategy to support decision-making by integrating fuzzy AHP and regression-based simulation." *Automation in Construction*, Elsevier, 35, 517–527.
- Chua, D. K. H., Yeoh, K. W., and Song, Y. (2010). "Quantification of spatial temporal congestion in four-dimensional computer-aided design." *Journal of Construction Engineering and Management*, American Society of Civil Engineers, 136(6), 641–649.
- Common, G., Johansen, E., and Greenwood, D. (2000). "A Survey of the Take-Up of Lean

- Concepts Among UK Construction Companies.” *8th Annual Conference of the International Group for Lean Construction*.
- “Crane Information, Specifications and Charts | Bigge Crane and Rigging.” (2018). <<https://www.bigge.com/crane-information/>> (Sep. 26, 2019).
- Cronbach, L. J. (1951). “Coefficient alpha and the internal structure of tests.” *psychometrika*, Springer, 16(3), 297–334.
- Cua, K. O., McKone, K. E., and Schroeder, R. G. (2001). “Relationships between the implementation of TQM, JIT, and TPM and manufacturing performance.” *Journal of Operations Management*, Elsevier, 19(6), 675–694.
- Dang, T., and Bargstädt, H.-J. (2013). “Integration of simulation and pareto-based optimization for space planning in the finishing phase.” *Proceedings of the 2013 Winter Simulation Conference: Simulation: Making Decisions in a Complex World*, IEEE Press, 3191–3202.
- Daniel, E. I. (2017). “Exploratory study into the use of Last Planner System and collaborative planning for construction process improvement.” Nottingham Trent University.
- Daniel, E. I., Pasquire, C., and Dickens, G. (2019). “Development of Approach to Support Construction Stakeholders in Implementation of the Last Planner System.” *Journal of Management in Engineering*, American Society of Civil Engineers, 35(5), 4019018.
- Darko, A., Chan, A. P. C., Ameyaw, E. E., Owusu, E. K., Pärn, E., and Edwards, D. J. (2018). “Review of application of analytic hierarchy process (AHP) in construction.” *International Journal of Construction Management*, 1–17.
- Dave, B., Hämmäläinen, J.-P., and Koskela, L. (2015). “Exploring the recurrent problems in the Last Planner Implementation on construction projects.” *Proceedings of the Indian Lean Construction Conference (ILCC 2015)*, Institute for Lean Construction Excellence, India.
- Dave, B., Kubler, S., Främmling, K., and Koskela, L. (2016). “Opportunities for enhanced lean construction management using Internet of Things standards.” *Automation in Construction*, 61, 86–97.

- Dawood, N., and Mallasi, Z. (2006). "Construction workspace planning: assignment and analysis utilizing 4D visualization technologies." *Computer-Aided Civil and Infrastructure Engineering*, Wiley Online Library, 21(7), 498–513.
- Dawood, N., and Shah, R. K. (2007). "An innovative approach for improvement of communications through visual schedule model in road construction." *7th International Conference on Construction Applications of Virtual Reality*, Pennsylvania State University University Park, PA, 216–223.
- Demirkesen, S., and Bayhan, H. G. (2019). "Subcontractor Selection with Choosing-By-Advantages (CBA) Method." *IOP Conference Series: Materials Science and Engineering*, IOP Publishing, 22020.
- Deshpande, A. S., Filson, L. E., Salem, O. M., and Miller, R. A. (2011). "Lean techniques in the management of the design of an industrial project." *Journal of Management in Engineering*, 28(2), 221–223.
- Diekmann, J. E., Balonick, J., Krewedl, M., and Troendle, L. (2003). "Measuring Lean Conformance." *11th Annual Conference of the International Group for Lean Construction*.
- Dobi, K., Gugić, J., and Kancijan, D. (2010). "AHP as a decision support tool in the multicriteria evaluation of bids in public procurement." *Proceedings of the ITI 2010, 32nd International Conference on Information Technology Interfaces*, IEEE, 447–452.
- Dodds, J., and Johnson, S. (2012). *Mastering Autodesk Navisworks 2013*. Wiley Publishing, Inc., Indianapolis.
- Dodgson, J. S., Spackman, M., Pearman, A., and Phillips, L. D. (2009). *Multi-criteria analysis: a manual*. Department for Communities and Local Government: London.
- Dorador, J. M., and Young, R. I. M. (2000). "Application of IDEF0, IDEF3 and UML methodologies in the creation of information models." *International Journal of Computer Integrated Manufacturing*, Taylor & Francis, 13(5), 430–445.
- Doriani, A. (2012). "Simulation-Based 4D Modeling for Planning and Scheduling of Elevated

- Urban Highway Reconstruction Projects.” Concordia University.
- Dulaimi, M. F., and Tanamas, C. (2001). “The principles and applications of lean construction in Singapore.” *9th International Group for Lean Construction*.
- Eastman, C. M., Eastman, C., Teicholz, P., Sacks, R., and Liston, K. (2011). *BIM handbook: A guide to building information modelling for owners, managers, designers, engineers and contractors*. John Wiley & Sons, New Jersey.
- Economist, T. (2017). “The construction industry’s productivity problem.” *The Economist*, <<https://www.economist.com/leaders/2017/08/17/the-construction-industrys-productivity-problem>> (Nov. 15, 2018).
- Egan, J. (1998). “The Egan report-rethinking construction.” *report of the construction industry task force to the deputy prime minister*. London.
- El-Sayegh, S. M. (2009). “Multi-criteria decision support model for selecting the appropriate construction management at risk firm.” *Construction Management and Economics*, Taylor & Francis, 27(4), 385–398.
- ElNimr, A., Fagiar, M., and Mohamed, Y. (2016). “Two-way integration of 3D visualization and discrete event simulation for modelling mobile crane movement under dynamically changing site layout.” *Automation in Construction*, Elsevier, 68, 235–248.
- Emiliani, M. L., and Stec, D. J. (2005). “Leaders lost in transformation.” *Leadership & Organization Development Journal*, Emerald Group Publishing Limited, 26(5), 370–387.
- Emmitt, S. (2014). *Design management for architects*. John Wiley & Sons.
- Enshassi, A., Sundermeier, M., and Zeiter, M. A. (2017). “Factors contributing to rework and their impact on construction projects performance.” *International Journal of Sustainable Construction Engineering & Technology*, 8(1).
- Erdogan, S. A., Šaparauskas, J., and Turskis, Z. (2017). “Decision making in construction management: AHP and expert choice approach.” *Procedia Engineering*, Elsevier, 172, 270–276.

- Eroshkin, S. Y., Kallaur, G. Y., and Papikian, L. M. (2016). "Lean construction and BIM: complementing each other for better project management." *Review of Business and Economics Studies*, 4(4), 17–22.
- De Falco, M., and Falivene, L. (2009). "Improving Project Control and Guidance through a Time-Frame Simulation Approach." *IFIP International Conference on Advances in Production Management Systems*, Springer, 417–424.
- Fanning, B., Clevenger, C. M., Ozbek, M. E., and Mahmoud, H. (2014). "Implementing BIM on infrastructure: Comparison of two bridge construction projects." *Practice Periodical on Structural Design and Construction*, American Society of Civil Engineers, 20(4), 1–8.
- Farrar, J. M., AbouRizk, S. M., and Mao, X. (2004). "Generic implementation of lean concepts in simulation models." *Lean Construction Journal*, 1(1), 1–23.
- Fauchier, D., and Alves, T. da C. L. (2013). "Last Planner System Is the Gateway to Lean Behaviors." *21st Annual Conference of the International Group for Lean Construction*, C. T. Formoso and P. Tzortzopoulos, eds., 559–568.
- Fawcett, S. E., and Bixby Cooper, M. (2001). "Process integration for competitive success: benchmarking barriers and bridges." *Benchmarking: An International Journal*, MCB UP Ltd, 8(5), 396–412.
- Fernandez-Solis, J. L., Porwal, V., Lavy, S., Shafaat, A., Rybkowski, Z. K., Son, K., and Lagoo, N. (2013). "Survey of motivations, benefits, and implementation challenges of last planner system users." *Journal of construction engineering and management*, American Society of Civil Engineers, 139(4), 354–360.
- Fewings, P. (2013). *Construction project management: an integrated approach*. Routledge.
- Fischer, M., and Kam, C. (2001). "4D Modelling: technologies and research." *Workshop on 4D Modelling: Experiences in UK and Overseas. Organised by The Network on Information Standardisation, Exchanges and Management in Construction. 17th October*.
- Fong, P. S.-W., and Choi, S. K.-Y. (2000). "Final contractor selection using the analytical hierarchy

- process.” *Construction management and economics*, Taylor & Francis, 18(5), 547–557.
- Forbes, L. H., and Ahmed, S. M. (2004). “Adapting lean construction methods for developing nations.” *Proceedings of the 2nd Latin American and Caribbean Conference for Engineering & Technology*, 2–4.
- Forbes, L. H., Ahmed, S. M., and Barcala, M. (2002). “Adapting lean construction theory for practical application in developing countries.” *Proceedings of the first CIB W107 International Conference: Creating a Sustainable Construction Industry in Developing Countries* (Eds. Division of Building Technology, CSIR), Stellenbosch, South Africa, 11–13.
- Ford, H. (2019). *Today and Tomorrow: Commemorative Edition of Ford’s 1926 Classic*. Routledge, New York.
- Ford, H., and Crowther, S. (1988). *Today and Tomorrow*. Productivity Press.
- Formoso, C. T., Isatto, E. L., and Hirota, E. H. (1999). “Method for Waste Control in the Building Industry.” *7th Annual Conference of the International Group for Lean Construction*, 325–330.
- Getuli, V., and Capone, P. (2018). “Computational workspaces management: a workflow to integrate workspaces dynamic planning with 4D BIM.” *ISARC. Proceedings of the International Symposium on Automation and Robotics in Construction*, IAARC Publications, 1–8.
- Gonzalez, V., Alarcon, L. F., and Mundaca, F. (2007). “Investigating the Relationship Between Planning Reliability and Project Performance.” *15th Annual Conference of the International Group for Lean Construction*, C. L. Pasquire Christine L. and P. Tzortzopoulos, eds., 98–108.
- Green, S. D., and May, S. C. (2005). “Lean construction: arenas of enactment, models of diffusion and the meaning of “leanness”™.” *Building Research & Information*, 33(6), 498–511.
- Guevremont, M., and Hammad, A. (2019). “Defining Levels of Development for 4D Simulations of Major Capital Construction Projects.” *Advances in Informatics and Computing in Civil and Construction Engineering*, Springer, 77–83.

- Haapasalo, H., Aapaoja, A., Björkman, S., and Matinheikki, M. (2015). "Applying the choosing by advantages method to select the optimal contract type for road maintenance." *International Journal of Procurement Management*, Inderscience Publishers (IEL), 8(6), 643–665.
- Halpin, D. W., and Kueckmann, M. (2002). "CEPM 1: lean construction and simulation." *Proceedings of the 34th conference on Winter simulation: exploring new frontiers*, Winter Simulation Conference, 1697–1703.
- Halpin, D. W., and Riggs, L. S. (1992). *Planning and analysis of construction operations*. John Wiley & Sons.
- Hammad, A., Zhang, C., Al-Hussein, M., and Cardinal, G. (2007). "Equipment workspace analysis in infrastructure projects." *Canadian Journal of Civil Engineering*, NRC Research Press, 34(10), 1247–1256.
- Hammond, J., Choo, H. J., Austin, S., Tommelein, I. D., and Ballard, G. (2000). "Integrating Design Planning, Scheduling, and Control With DePlan." *8th Annual Conference of the International Group for Lean Construction*.
- Hamzeh, F., Ballard, G., and Tommelein, I. D. (2012a). "Rethinking Lookahead Planning to Optimize Construction Workflow." *Lean Construction Journal*.
- Hamzeh, F., Kallassy, J., Lahoud, M., and Azar, R. (2016). "The First Extensive Implementation of Lean and LPS in Lebanon: Results and Reflections." *24th Annual Conference of the International Group for Lean Construction*.
- Hamzeh, F. R. (2009). "Improving construction workflow-The role of production planning and control." University of California, Berkeley.
- Hamzeh, F. R., Abi Morshed, F., Jalwan, H., and Saab, I. (2012b). "Is Improvisation Compatible with Lookahead Planning? An Exploratory Study." *20th Annual Conference of the International Group for Lean Construction*, I. D. Tommelein and C. L. Pasquire, eds.
- Hamzeh, F. R., Ballard, G., and Tommelein, I. D. (2008). "Improving Construction Work Flow – The Connective Role of Lookahead Planning." *16th Annual Conference of the International*



- Group for Lean Construction*, P. Tzortzopoulos and M. Kagioglou, eds., 635–646.
- Hamzeh, F. R., Ballard, G., and Tommelein, I. D. (2009). "Is the Last Planner System Applicable to Design? A Case Study." *17th Annual Conference of the International Group for Lean Construction*, Y. Cuperus and E. H. Hirota, eds., 165–176.
- Hamzeh, F. R., Saab, I., Tommelein, I. D., and Ballard, G. (2015). "Understanding the role of 'tasks anticipated' in lookahead planning through simulation." *Automation in Construction*, 49, Part A, 18–26.
- Hamzeh, F. R., Tommelein, I. D., Ballard, G., and Kaminsky, P. M. (2007). "Logistics Centers to Support Project-Based Production in the Construction Industry." *15th Annual Conference of the International Group for Lean Construction*, C. L. Pasquire Christine L. and P. Tzortzopoulos, eds., 181–191.
- Hanna, A. S., Wodalski, M., and Whited, G. (2010). "Applying Lean Techniques in Delivery of Transportation Infrastructure Projects." *18th Annual Conference of the International Group for Lean Construction*, K. Walsh and T. Alves, eds., 609–619.
- Hannon, J. J. (2007). *Emerging technologies for construction delivery*. Transportation Research Board.
- Haque, M. E., and Rahman, M. (2009). "Time-space-activity conflict detection using 4D visualization in multi-storied construction project." *International Visual Informatics Conference*, Springer, 266–278.
- Harmelink, D. J., and Yamin, R. A. (2001). *Development and application of linear scheduling techniques to highway construction projects*. Joint Transportation Research Program, Indiana Department of Transportation and Purdue University, West Lafayette, IN.
- Harris, B., and Alves, T. da C. L. (2013). "4D Building Information Modeling and Field Operations: An Exploratory Study." *21st Annual Conference of the International Group for Lean Construction*, C. T. Formoso and P. Tzortzopoulos, eds., 811–820.
- Hartmann, T., and Fischer, M. (2007). "Supporting the constructability review with 3D/4D models."

- Building Research & Information*, Taylor & Francis, 35(1), 70–80.
- Hartmann, T., Gao, J., and Fischer, M. (2008). “Areas of application for 3D and 4D models on construction projects.” *Journal of Construction Engineering and Management*, American Society of Civil Engineers, 134(10), 776–785.
- Haupt, T. C., and Whiteman, D. E. (2004). “Inhibiting factors of implementing total quality management on construction sites.” *The TQM Magazine*, Emerald Group Publishing Limited, 16(3), 166–173.
- Heesom, D. (2004). “An analytical system for space planning on construction sites.” University of Wolverhampton, University of Wolverhampton.
- Heesom, D., and Mahdjoubi, L. (2002a). *Visualization development for the virtual construction site. Built Environment Division, University of Wolverhampton, under EPSRC Grant No. GR N 876*, Wolverhampton.
- Heesom, D., and Mahdjoubi, L. (2002b). *Technology Opportunities and Potential for the Virtual Construction Site: Emerging Research Initiatives*. University of Wolverhampton.
- Heesom, D., and Mahdjoubi, L. (2004). “Trends of 4D CAD applications for construction planning.” *Construction Management and Economics*, Taylor & Francis, 22(2), 171–182.
- Heigermoser, D., de Soto, B. G., Abbott, E. L. S., and Chua, D. K. H. (2019). “BIM-based Last Planner System tool for improving construction project management.” *Automation in Construction*, Elsevier, 104, 246–254.
- Herroelen, W. (2005). “Project scheduling—Theory and practice.” *Production and operations management*, Wiley Online Library, 14(4), 413–432.
- Herroelen, W., and Leus, R. (2004). “Robust and reactive project scheduling: a review and classification of procedures.” *International Journal of Production Research*, Taylor & Francis, 42(8), 1599–1620.
- Heyl, J. von. (2015). “Lean Simulation in Road Construction: Teaching of Basic Lean Principals.” *23rd Annual Conference of the International Group for Lean Construction*, O. Seppänen,

- V. A. González, and P. Arroyo, eds., 403–412.
- Hijazi, W., Alkass, S., and Zayed, T. (2009). “Constructability assessment using BIM/4D CAD simulation model.” *AACE International Transactions*, 4, 1–14.
- Hines, P., Holweg, M., and Rich, N. (2004). “Learning to evolve: a review of contemporary lean thinking.” *International journal of operations & production management*, Emerald Group Publishing Limited, 24(10), 994–1011.
- Hong, B., and Ma, X. (2017). “Path planning for wheel loaders: a discrete optimization approach.” *2017 IEEE 20th International Conference on Intelligent Transportation Systems (ITSC)*, IEEE, 1–6.
- Hooper, M. (2015). “Automated model progression scheduling using level of development.” *Construction Innovation*, Emerald Group Publishing Limited, 15(4), 428–448.
- Hopp, W., and Spearman, M. (1996). “Factory physics: foundations of factory management.” *InvinIMcGraw Hill, Chicago, IL*.
- Howell, G., and Ballard, G. (1997a). “Lean production theory: Moving beyond ‘Can-Do.’” *Lean construction*, AA. Bakelma, Rotterdam, 17–23.
- Howell, G., and Ballard, G. (1997b). “Factors affecting project success in the piping.” *Lean construction*, CRC Press, 161.
- Hsu, P.-F., Wu, C.-R., and Li, Z.-R. (2008). “Optimizing resource-based allocation for senior citizen housing to ensure a competitive advantage using the analytic hierarchy process.” *Building and Environment*, Elsevier, 43(1), 90–97.
- Huang, R.-Y., Grigoriadis, A. M., and Halpin, D. W. (1994). “Simulation of cable-stayed bridges using DISCO.” *Proceedings of the 26th conference on Winter simulation*, Society for Computer Simulation International, 1130–1136.
- Huang, T., Kong, C. W., Guo, H., Baldwin, A., and Li, H. (2007). “A virtual prototyping system for simulating construction processes.” *Automation in Construction*, Elsevier, 16(5), 576–585.
- Huber, B., and Reiser, P. (2003). “The Marriage of CPM and Lean Construction.” *11th Annual*

*Conference of the International Group for Lean Construction.*

- Hukkeri, R. B. (2012). "Machine control system implementing intention mapping." Google Patents.
- Hyun, C., Cho, K., Koo, K., Hong, T., and Moon, H. (2008). "Effect of delivery methods on design performance in multifamily housing projects." *Journal of Construction Engineering and Management*, American Society of Civil Engineers, 134(7), 468–482.
- Ikau, R., Joseph, C., and Tawie, R. (2016). "Factors influencing waste generation in the construction industry in Malaysia." *Procedia-Social and Behavioral Sciences*, Elsevier, 234, 11–18.
- Isaac, S., Su, Y., Lucko, G., and Dagan, D. (2017). "Work-path modelling and spatial scheduling with singularity functions." *Journal of Computing in Civil Engineering*, American Society of Civil Engineers, 31(4), 4017008.
- Jang, J. W., and Kim, Y.-W. (2007). "Use of percent of constraint removal to measure the make-ready process." *Conference of the International Group for Lean Construction, Michigan, USA Christine Pasquire and Patricia Tzortzopoulos (eds)*, 529–538.
- Jang, J. W., and Kim, Y. W. (2008). "The Relationship Between the Make-Ready Process and Project Schedule Performance." *16th Annual Conference of the International Group for Lean Construction*, P. Tzortzopoulos and M. Kagioglou, eds., 647–656.
- Jato-Espino, D., Castillo-Lopez, E., Rodriguez-Hernandez, J., and Canteras-Jordana, J. C. (2014). "A review of application of multi-criteria decision-making methods in construction." *Automation in Construction*, Elsevier, 45, 151–162.
- Jin, H., Nahangi, M., Goodrum, P. M., and Yuan, Y. (2019). "Multiobjective Optimization for Scaffolding Space Planning in Industrial Piping Construction Using Model-Based Simulation Programming." *Journal of Computing in Civil Engineering*, American Society of Civil Engineers, 34(1), 6019001.
- Johansen, E., and Porter, G. (2003). "An Experience of Introducing Last Planner Into a UK Construction Project." *11th Annual Conference of the International Group for Lean*

*Construction.*

- Johansen, E., Porter, G., and Greenwood, D. (2004). "Implementing Lean: UK Culture and System Change." *12th Annual Conference of the International Group for Lean Construction*, S. Bertelsen and C. T. Formoso, eds.
- Jongeling, R., and Olofsson, T. (2007). "A method for planning of work-flow by combined use of location-based scheduling and 4D CAD." *Automation in Construction*, Elsevier, 16(2), 189–198.
- Jørgensen, B. (2005). "Designing to target cost: one approach to design/construction integration." *Designing Value*, CIB Publication 307, DTU Lyngby, 311–319.
- Jørgensen, B. (2006). "Integrating Lean Design and Lean Construction: Processes and Methods." *Integrating lean design and lean construction: processes and methods*, The Technical University of Denmark, Denmark.
- Jørgensen, B., and Emmitt, S. (2008). "Lost in transition: the transfer of lean manufacturing to construction." *Engineering, Construction and Architectural Management*, 15(4), 383–398.
- Josephson, P.-E., and Saukkoriipi, L. (2007). *Waste in construction projects: Call for a new approach*. Chalmers University of Technology.
- Kähkönen, K., and Leinonen, J. (2001). "Advanced communication technology as an enabler for improved construction practice." *Workshop on 4D Modelling: Experiences in UK and Overseas. Organised by The Network on Information Standardisation, Exchanges and Management in Construction. 17th October*.
- Kaliannan, S., Nagapan, S., Abdullah, A. H., Sohu, S., and Jhatial, A. A. (2018). "Determining Root Cause of Construction Waste Generation: A Global Context." *Civil Engineering Journal*, 4(11), 2539–2547.
- Kallotech. (2017). "Fuzor Software." <<https://www.kalloctech.com/design.jsp>>.
- Kalsaas, B. T. (2012). "The Last Planner System Style of Planning: Its Basis in Learning Theory." *Journal of Engineering, Project & Production Management*, 2(2).

- Kam, C., Senaratna, D., McKinney, B., Xiao, Y., and Song, M. (2014). *The VDC Scorecard: Formulation and validation*. Center for Integrated Facility Engineering: Stanford University, Centre for Integrated Facility Engineering (CIFE), Stanford University.
- Kamat, V. R., and Martinez, J. C. (2007). "Interactive collision detection in three-dimensional visualizations of simulated construction operations." *Engineering with Computers*, 23(2), 79–91.
- Kang, D., and Choi, B. K. (2010). "Visual modelling and simulation toolkit for activity cycle diagram." *24th European Conference on Modeling and Simulation*, SCS Europe.
- Kang, L., Pyeon, J., Moon, H., Kim, C., and Kang, M. (2012). "Development of Improved 4D CAD System for Horizontal Works in Civil Engineering Projects." *Journal of Computing in Civil Engineering*, American Society of Civil Engineers, 27(3), 212–230.
- Kang, L. S., Jee, S. B., Kim, C. H., Pak, S. Y., and Moon, H. S. (2006). "4D System for visualization scheduling progress of horizontal construction project including earthwork." *Proceedings CONVAR Conference 2006*, 4–6.
- Kang, L. S., Kim, S.-K., Moon, H. S., and Kim, H. S. (2013). "Development of a 4D object-based system for visualizing the risk information of construction projects." *Automation in Construction*, Elsevier, 31, 186–203.
- Karakhan, A. A., Rajendran, S., Gambatese, J., and Nnaji, C. (2018). "Measuring and Evaluating Safety Maturity of Construction Contractors: Multicriteria Decision-Making Approach." *Journal of Construction Engineering and Management*, American Society of Civil Engineers, 144(7), 4018054.
- Karakhan, A., Gambatese, J., and Rajendran, S. (2016). "Application of Choosing by Advantages Decision-Making System to Select Fall-Protection Measures." *24th Annual Conference of the International Group for Lean Construction*.
- Kassem, M., Dawood, N., and Chavada, R. (2015). "Construction workspace management within an Industry Foundation Class-Compliant 4D tool." *Automation in Construction*, Elsevier, 52,

42–58.

- Kayhani, N., Taghaddos, H., and BehzadiPour, S. (2018). "Construction Equipment Collision-Free Path Planning Using Robotic Approach." *ISARC. Proceedings of the International Symposium on Automation and Robotics in Construction*, IAARC Publications, 1–6.
- Kenley, R. (2004). "Project Micro-Management: Practical Site Planning and Management of WorkFlow." *12th Annual Conference of the International Group for Lean Construction*, S. Bertelsen and C. T. Formoso, eds.
- Kensek, K. M. (2014). *Building information modelling*. Routledge.
- Khaleel, T., and Al-Zubaidy, A. (2018). "Major factors contributing to the construction waste generation in building projects of Iraq." *MATEC Web of Conferences*, EDP Sciences, 2034.
- Khanh, H. D., and Kim, S. Y. (2016). "A survey on production planning system in construction projects based on the Last Planner System." *KSCE Journal of Civil Engineering*, Springer, 20(1), 1–11.
- Khanzode, A. (2010). *An integrated, virtual design and construction and lean (IVL) method for coordination of MEP. Unpublished Technical Report*, Center for Integrated Facility Engineering, Stanford University.
- Khanzode, A., Fischer, M., Reed, D., and Ballard, G. (2006). *A guide to applying the principles of virtual design & construction (VDC) to the lean project delivery process. CIFE, Stanford University, Palo Alto, CA*, Center for Integrated Facility Engineering, Stanford University.
- Khanzode, A., Reed, D., and Dilsworth, B. (2007). "A Virtual Success: Using BIM, combined with lean construction techniques, results in enhanced field productivity for a California medical campus project." *Modern Steel Construction*, THE AMERICAN INSTITUTE OF STEEL CONSTRUCTION, INC., 47(11), 22.
- Kim, H., Moon, H., Kim, C., and Kang, L. (2014). "Workspace Generation and Interference Optimization Algorithm by Work-type using 3D Model Object in a Construction Project." *Journal of The Korean Society of Civil Engineers*, Korean Society of Civil Engineers, 34(6),

1911–1918.

- Kim, K., and Teizer, J. (2014). “Automatic design and planning of scaffolding systems using building information modelling.” *Advanced Engineering Informatics*, Elsevier, 28(1), 66–80.
- Kim, T. W., and Fischer, M. (2014). “Automated generation of user activity–space pairs in the space-use analysis.” *Journal of Construction Engineering and Management*, American Society of Civil Engineers, 140(5), 4014007.
- Kivistö, G., Ohlsson, H., and Jacobsson, T. (2013). “Expanding Lean into Transportation Infrastructure Construction.” *Master of Science Thesis in the Quality and Operations Management Programme*, Citeseer.
- Koch, C., Sage, D., Dainty, A., and Simonsen, R. (2015). “Understanding operations strategizing in project-based organizations: middle managers’ interaction and strategy praxis.” *Engineering project organization journal*, Taylor & Francis, 5(2–3), 106–117.
- Koo, B., and Fischer, M. (2000). “Feasibility study of 4D CAD in commercial construction.” *Journal of Construction Engineering and Management*, American Society of Civil Engineers, 126(4), 251–260.
- Koskela, L. (1992). *Application of the new production philosophy to construction*. Center for Integrated Facility Engineering, Stanford.
- Koskela, L. (1999). “Management of Production in Construction: A Theoretical View.” *7th Annual Conference of the International Group for Lean Construction*, 241–252.
- Koskela, L. (2000). *An exploration towards a production theory and its application to construction*. VTT Technical Research Centre of Finland.
- Koskela, L. (2004). “Making do - the eighth category of waste.” *12th Annual Conference of the International Group for Lean Construction*, S. Bertelsen and C. T. Formoso, eds.
- Koskela, L., Bølviken, T., and Rooke, J. A. (2013). “Which Are the Wastes of Construction?” *Proceedings for the 21st Annual Conference of the International Group for Lean Construction.*, 3–12.



- Koskela, L., Howell, G., Ballard, G., and Tommelein, I. (2002a). "The Foundations of Lean Construction." *Design and Construction: Building in value*, R. Best and G. De Valence, eds., Butterworth-Heinemann, Oxford, 221–225.
- Koskela, L., Huovila, P., and Leinonen, J. (2002b). "Design management in building construction: from theory to practice." *Journal of construction research*, World Scientific, 3(01), 1–16.
- Kou, G., Lu, Y., Peng, Y., and Shi, Y. (2012). "Evaluation of classification algorithms using MCDM and rank correlation." *International Journal of Information Technology & Decision Making*, World Scientific, 11(01), 197–225.
- Kpamma, Z. E., Adjei-Kumi, T., Ayarkwa, J., and Adinyira, E. (2016). "An exploration of the choosing by advantages decision system as a user engagement tool in participatory design." *Architectural Engineering and Design Management*, Taylor & Francis, 12(1), 51–66.
- Kung, D., Alex, D. P., Al-Hussein, M., and Fernando, S. (2008). "Application of lean thinking to improve the productivity of water and sewer service installations." *Canadian Journal of Civil Engineering*, NRC Research Press, 35(4), 418–430.
- Kunz, J., and Fischer, M. (2012). *Virtual design and construction: themes, case studies and implementation suggestions*. Center for Integrated Facility Engineering (CIFE), Stanford University, Center for Integrated Facility Engineering (CIFE), Stanford University.
- Lai, K.-C., and Kang, S.-C. (2009). "Collision detection strategies for virtual construction simulation." *Automation in Construction*, 18(6), 724–736.
- Lam, K., Lam, M. C., and Wang, D. (2008). "MBNQA-oriented self-assessment quality management system for contractors: fuzzy AHP approach." *Construction Management and Economics*, Taylor & Francis, 26(5), 447–461.
- Lamers, M. (2002). "Do you manage a project, or what? A reply to 'Do you manage work, deliverables or resources,' International Journal of Project Management, April 2000." *International Journal of Project Management*.
- Lamming, R. (1993). *Beyond partnership: strategies for innovation and lean supply*. Prentice-Hall

London.

- Lapinski, A., Horman, M., and Riley, D. (2006). "Lean Processes for Sustainable Project Delivery." *Journal of Construction Engineering and Management*, 132(10), 1083–1091.
- Law, A. M., Kelton, W. D., and Kelton, W. D. (1991). *Simulation modelling and analysis*. McGraw-Hill New York.
- Lee, K.-M., Lee, Y.-B., Shim, C.-S., and Park, K.-L. (2012). "Bridge information models for the construction of a concrete box-girder bridge." *Structure and Infrastructure Engineering*, Taylor & Francis, 8(7), 687–703.
- Lee, N., and Rojas, E. M. (2010). "Defining high-level project control data for visual information systems." *Construction Research Congress 2010: Innovation for Reshaping Construction Practice*, 518–527.
- Lee, Y. B., Lee, K. M., Park, Y. K., Park, M. S., Yoon, M. G., Shin, H. Y., and Parl, K., L. (2006). "Application of Digital Mock-Up Technology to Design and Construction of Precast Segmental Bridges." *In 2nd ACF International Conference, IABSE; 1999, Indonesia*, 43–49.
- Lei, Z., Han, S., Bouferguène, A., Taghaddos, H., Hermann, U., and Al-Hussein, M. (2014). "Algorithm for mobile crane walking path planning in congested industrial plants." *Journal of Construction Engineering and Management*, American Society of Civil Engineers, 141(2), 5014016.
- Lei, Z., Taghaddos, H., Hermann, U., and Al-Hussein, M. (2013). "A methodology for mobile crane lift path checking in heavy industrial projects." *Automation in construction*, Elsevier, 31, 41–53.
- Lichtig, W. A. (2006). "The integrated agreement for lean project delivery." *Constr.Law.*, HeinOnline, 26, 25–32.
- Liker, J. (2004). *The Toyota way: 14 management principles from the world's greatest manufacturer*. McGraw-Hill, New York.
- Lin, J. J.-C., Hung, W.-H., and Kang, S.-C. (2014). "Motion planning and coordination for mobile

- construction machinery.” *Journal of Computing in Civil Engineering*, American Society of Civil Engineers, 29(6), 4014082.
- Lindhard, S., and Wandahl, S. (2013). “Improving onsite scheduling—looking into the limits of Last Planner System.” *The Built & Human Environment Review*, 6(1), 46–60.
- Lindhard, S., and Wandahl, S. (2014). “Scheduling of large, complex, and constrained construction projects—an exploration of LPS application.” *International Journal of Project Organisation and Management*, Inderscience Publishers, 6(3), 237–253.
- Liu, M., and Ballard, G. (2008). “Improving Labor Productivity Through Production Control.” *16th Annual Conference of the International Group for Lean Construction*, P. Tzortzopoulos and M. Kagioglou, eds., 657–666.
- Liu, M., and Ballard, G. (2009). “Factors Affecting Work Flow Reliability - A Case Study.” *17th Annual Conference of the International Group for Lean Construction*, Y. Cuperus and E. H. Hirota, eds., 177–186.
- Liu, M., Ballard, G., and Ibbs, W. (2010). “Workflow variation and labour productivity: A case study.” *Journal of management in engineering*, American Society of Civil Engineers, 27(4), 236–242.
- Løken, E. (2007). “Use of multicriteria decision analysis methods for energy planning problems.” *Renewable and Sustainable Energy Reviews*, Elsevier, 11(7), 1584–1595.
- Lucko, G., Said, H. M. M., and Bouferguene, A. (2014a). “Spatially constrained scheduling with multidirectional singularity functions.” *Construction Research Congress 2014: Construction in a Global Network*, 1448–1457.
- Lucko, G., Said, H. M. M., and Bouferguene, A. (2014b). “Construction spatial modelling and scheduling with three-dimensional singularity functions.” *Automation in Construction*, Elsevier, 43, 132–143.
- Luo, X., Li, H., Wang, H., Wu, Z., Dai, F., and Cao, D. (2019). “Vision-based detection and visualization of dynamic workspaces.” *Automation in Construction*, Elsevier, 104, 1–13.

- Luo, X., O'Brien, W. J., Leite, F., and Goulet, J. A. (2014). "Exploring approaches to improve the performance of autonomous monitoring with imperfect data in location-aware wireless sensor networks." *Advanced Engineering Informatics*, Elsevier, 28(4), 287–296.
- M. Said, H. M., and Lucko, G. (2016). "Float types in spatial construction scheduling." *Journal of Construction Engineering and Management*, American Society of Civil Engineers, 142(12), 4016077.
- Mader, R. P. (2003). "Last planner process aids construction." *Contractor Magazine*.
- Mahalingam, A., Kashyap, R., and Mahajan, C. (2010). "An evaluation of the applicability of 4D CAD on construction projects." *Automation in Construction*, Elsevier, 19(2), 148–159.
- Mallasi, Z. (2006). "Dynamic quantification and analysis of the construction workspace congestion utilizing 4D visualization." *Automation in Construction*, Elsevier, 15(5), 640–655.
- Mallasi, Z. (2009). "Towards minimizing space-time conflicts between site activities using simple generic algorithm the best execution strategy." *Journal of Information Technology in Construction (ITCon)*, 14(14), 154–179.
- Mandujano, M. G., Alarcon, L. F., Kunz, J., and Mourgues, C. (2015). "Use of Virtual Design and Construction, and Its Inefficiencies, From a Lean Thinking Perspective." *23rd Annual Conference of the International Group for Lean Construction*, O. Seppänen, V. A. González, and P. Arroyo, eds., 836–845.
- Mao, X., and Zhang, X. (2008). "Construction process reengineering by integrating lean principles and computer simulation techniques." *Journal of Construction Engineering and Management*, American Society of Civil Engineers, 134(5), 371–381.
- Mardani, A., Jusoh, A., Nor, K., Khalifah, Z., Zakwan, N., and Valipour, A. (2015). "Multiple criteria decision-making techniques and their applications—a review of the literature from 2000 to 2014." *Economic Research-Ekonomiska Istraživanja*, Sveučilište Jurja Dobrile u Puli, Odjel za ekonomiju i turizam'Dr. Mijo, 28(1), 516–571.
- Marks, E. (2014). "Active safety leading indicators for human-equipment interaction on

- construction sites.” Georgia Institute of Technology.
- Marks, E. D., and Teizer, J. (2013). “Method for testing proximity detection and alert technology for safe construction equipment operation.” *Construction Management and Economics*, Taylor & Francis, 31(6), 636–646.
- Martinez, E., Tommelein, I., and Alvear, A. (2016). “Formwork system selection using choosing by advantages.” *Construction Research Congress*, 1700–1709.
- Martinez, J. (1996). “STROBOSCOPE: State and Resource-Based Simulation of Construction Processes.” The University of Michigan.
- Marzouk, M., El-Dein, H. Z., and El-Said, M. (2007). “Application of computer simulation to the construction of incremental launching bridges.” *Journal of Civil Engineering and Management*, Taylor & Francis, 13(1), 27–36.
- Marzouk, M., Said, H., and El-Said, M. (2008). “Special-purpose simulation model for balanced cantilever bridges.” *Journal of Bridge Engineering*, American Society of Civil Engineers, 13(2), 122–131.
- Mastroianni, R., and Abdelhamid, T. (2003). “The Challenge: The Impetus for Change to Lean Project Delivery.” *11th Annual Conference of the International Group for Lean Construction*.
- Matthews, J., Pellew, L., Phua, F., and Rowlinson, S. (2000). “Quality relationships: partnering in the construction supply chain.” *International Journal of Quality & Reliability Management*, MCB UP Ltd, 17(4/5), 493–510.
- Matzler, K., Hinterhuber, H. H., Bailom, F., and Sauerwein, E. (1996). “How to delight your customers.” *Journal of Product & Brand Management*, MCB UP Ltd, 5(2), 6–18.
- Mawlana, M., Hammad, A., Doriani, A., and Setayeshgar, S. (2012). “Discrete event simulation and 4D modelling for elevated highway reconstruction projects.” *Proceedings of the XIVth International Conference on Computing in Civil and Building Engineering, Moscow State University of Civil Engineering*.
- Mawlana, M., Vahdatikhaki, F., Doriani, A., and Hammad, A. (2015). “Integrating 4D modelling

- and discrete event simulation for phasing evaluation of elevated urban highway reconstruction projects." *Automation in Construction*, 60, 25–38.
- Metkari, A. A., and Attar, A. C. (2013). "Application of Building Information Modeling Tool for Building Project." *International Journal of Science and Research*, 4(5), 324–329.
- Ministry of transport, sustainable mobility and transportation electrification. (2017). "Turcot." <<https://www.turcot.transports.gouv.qc.ca/fr/Pages/default.aspx>>.
- Mirzaei, A., Nasirzadeh, F., Parchami Jalal, M., and Zamani, Y. (2018). "4D-BIM Dynamic Time-Space Conflict Detection and Quantification System for Building Construction Projects." *Journal of Construction Engineering and Management*, American Society of Civil Engineers, 144(7), 4018056.
- Monden, Y. (2011). *Toyota production system: an integrated approach to just-in-time*. CRC Press.
- Moon, H., Dawood, N., and Kang, L. (2014a). "Development of workspace conflict visualization system using 4D object of work schedule." *Advanced Engineering Informatics*, Elsevier, 28(1), 50–65.
- Moon, H., Kamat, V. R., and Kang, L. (2014b). "Grid cell-based algorithm for workspace overlapping analysis considering multiple allocations of construction resources." *Journal of Asian Architecture and Building Engineering*, Architectural Institute of Japan, 13(2), 341–348.
- Moon, H., Kang, L., Dawood, N., and Ji, S. (2009). "Configuration method of health and safety rule for improving productivity in construction space by multi-dimension CAD system." *ICCEM/ICCPM*, KICEM, Korea.
- Moon, H., Kim, H., Kim, C., and Kang, L. (2014c). "Development of a schedule-workspace interference management system simultaneously considering the overlap level of parallel schedules and workspaces." *Automation in Construction*, Elsevier, 39, 93–105.
- Mossman, A. (2009). "Why isn't the UK construction industry going lean with gusto?" *Lean Construction Journal*, 5(1), 24–36.

- Mossman, A. (2011). "Last Planner; Collaborative conversations for predictable design and construction delivery." <[https://connect.innovateuk.org/c/document\\_library/get\\_file?groupId=471824&folderId=3928062&title=Last+Planner+collaborative+conversations+for+predictable+design+%26+construction+delivery.pdf](https://connect.innovateuk.org/c/document_library/get_file?groupId=471824&folderId=3928062&title=Last+Planner+collaborative+conversations+for+predictable+design+%26+construction+delivery.pdf)>.
- Mossman, A., Ballard, G., and Pasquire, C. (2010). "Lean Project Delivery—innovation in integrated design & delivery." *Architectural Engineering and Design Management*, 1–28.
- Murguia, D., and Brioso, X. (2017). "Using 'Choosing by Advantages' and 4D Models to Select the Best Construction-Flow Option in a Residential Building." *Procedia Engineering*, Elsevier, 196, 470–477.
- Nagapan, S., Rahman, I. A., and Asmi, A. (2012). "Factors contributing to physical and non-physical waste generation in construction industry." *International Journal of Advances in Applied Sciences*, 1(1), 1–10.
- Nahmens, I., Ikuma, L. H., and Khot, D. (2012). "Kaizen and Job Satisfaction-A Case Study in Industrialized Homebuilding." *Lean Construction Journal*.
- Nahmias, S., and Cheng, Y. (2005). *Production and operations analysis*. McGraw-hill New York.
- Naoum, S. (2012). *Dissertation research and writing for construction students*. Routledge.
- Al Nasser, H. A., Widen, K., and Aulin, R. (2016). "A taxonomy of planning and scheduling methods to support their more efficient use in construction project management." *Journal of Engineering, Design and Technology*, Emerald Group Publishing Limited.
- Nazech, E. M., Zaldi, D., and Trigunaryah, B. (2008). "Identification of construction waste in road and highway construction projects." *11th East Asia-Pacific Conference on Structural Engineering & Construction*, Department of Civil Engineering, National Taiwan University, Taipei, Taiwan, 1–7.
- Nieto-Morote, A., and Ruz-Vila, F. (2011). "Last planner control system applied to a chemical plant construction." *Journal of Construction Engineering and Management*, American

- Society of Civil Engineers, 138(2), 287–293.
- Nikakhtar, A., Hosseini, A. A., Wong, K. Y., and Zavichi, A. (2015). “Application of lean construction principles to reduce construction process waste using computer simulation: a case study.” *International Journal of Services and Operations Management*, Inderscience Publishers, 20(4), 461–480.
- Nnaji, C., Lee, H. W., Karakhan, A., and Gambatese, J. (2018). “Developing a Decision-Making Framework to Select Safety Technologies for Highway Construction.” *Journal of Construction Engineering and Management*, American Society of Civil Engineers, 144(4), 4018016.
- O. AlSehaimi, A., Tzortzopoulos Fazenda, P., and Koskela, L. (2014). “Improving construction management practice with the Last Planner System: a case study.” *Engineering, Construction and Architectural Management*, Emerald Group Publishing Limited, 21(1), 51–64.
- O’Brien, W., Gau, P., Schmeits, C., Goyat, J., and Khwaja, N. (2012). “Benefits of three-and four-dimensional computer-aided design model applications for review of constructability.” *Transportation Research Record: Journal of the Transportation Research Board*, Transportation Research Board of the National Academies, (2268), 18–25.
- Ohno, T. (1988). *Toyota production system: beyond large-scale production*. CRC Press.
- Oladiran, O. J. (2008). “Lean-in-Nigerian construction: State, barriers, strategies and ‘Go-to-Gemba’ approach.” *Proceedings of the IGLC–16, Manchester, UK*, 16–18.
- Oloufa, A. A. (1993). “Modeling operational activities in object-oriented simulation.” *Journal of Computing in Civil Engineering*, American Society of Civil Engineers, 7(1), 94–106.
- Ovararin, N. (2001). “Quantifying productivity loss due to field disruptions in masonry construction.” The University of Texas, Austin, Texas.
- Paez, O., Salem, S., Solomon, J., and Genaidy, A. (2005). “Moving from lean manufacturing to lean construction: Toward a common socio-technological framework.” *Human Factors and*



- Ergonomics in Manufacturing & Service Industries*, Wiley Online Library, 15(2), 233–245.
- Pan, N.-F. (2008). “Fuzzy AHP approach for selecting the suitable bridge construction method.” *Automation in construction*, Elsevier, 17(8), 958–965.
- Pan, W., Dainty, A. R. J., and Gibb, A. G. F. (2012). “Establishing and weighing decision criteria for building system selection in housing construction.” *Journal of Construction Engineering and Management*, American Society of Civil Engineers, 138(11), 1239–1250.
- Park, M., Yang, Y., Lee, H.-S., Han, S., and Ji, S. (2011). “Floor-level construction material layout planning model considering actual travel path.” *Journal of Construction Engineering and Management*, American Society of Civil Engineers, 138(7), 905–915.
- Parrish, K., and Tommelein, I. D. (2009). “Making Design Decisions Using Choosing by Advantages.” *17th Annual Conference of the International Group for Lean Construction*, Y. Cuperus and E. H. Hirota, eds., 501–510.
- Patel, H. (2015). “3 Types Of 3D BIM Clash Detection Have Their Own Importance | Analysis | The BIM Hub.” *theBIMhub*, <[https://thebimhub.com/2015/06/23/3-types-of-3d-bim-clash-detection-have-their-own-i/#.XABO7jhKg\\_I](https://thebimhub.com/2015/06/23/3-types-of-3d-bim-clash-detection-have-their-own-i/#.XABO7jhKg_I)> (Nov. 29, 2018).
- Pawlewski, P., and Hoffa, P. (2014). “Languages of process modelling.” *Research in Logistics & Production*, 4(3), 221–229.
- Pellerin, R., and Perrier, N. (2019). “A review of methods, techniques and tools for project planning and control.” *International Journal of Production Research*, Taylor & Francis, 57(7), 2160–2178.
- Pellicer, E., Cerveró, F., Lozano, A., and Ponz-Tienda, J. L. (2015). “The Last Planner System of Construction Planning and Control as a Teaching and Learning Tool.” *INTED2015 Proceedings, 9th International Technology, Education and Development Conference*.
- Peng, Y., Kou, G., Wang, G., and Shi, Y. (2011). “FAMCDM: A fusion approach of MCDM methods to rank multiclass classification algorithms.” *Omega*, Elsevier, 39(6), 677–689.
- Pereira, J. L., and Silva, D. (2016). “Business process modelling languages: A comparative

- framework.” *New Advances in Information Systems and Technologies*, Springer, 619–628.
- Pheng, L. S., and Chuan, C. J. (2001). “Just-in-time management of precast concrete components.” *Journal of Construction Engineering and Management*, American Society of Civil Engineers, 127(6), 494–501.
- Pheng, L. S., and Hui, M. S. (1999). “The application of JIT philosophy to construction: a case study in site layout.” *Construction Management & Economics*, Taylor & Francis, 17(5), 657–668.
- Platt, A. (2007). *4D CAD for highway construction projects. 4D CAD for highway construction projects*, Pennsylvania State University.
- Polat, G., and Arditi, D. (2005). “The JIT materials management system in developing countries.” *Construction Management and Economics*, Taylor & Francis, 23(7), 697–712.
- Poshdar, M., González, V. A., O’Neill, M., Shahbazpour, M., Walker, C. G., and Golzarpoor, H. (2016). “The Role of Conceptual Modeling in Lean Construction Simulation.” *24th Annual Conference of the International Group for Lean Construction*.
- Post, N. (2010). “Integrated Project Delivery Boosters Ignore Many Flashing Red Lights.” *Engineering News-Record*, 264, 14–22.
- Pradhananga, N. (2014). “Construction site safety analysis for human-equipment interaction using spatio-temporal data.” Georgia Institute of Technology.
- Priven, V., and Sacks, R. (2016). “Impacts of the social subcontract and last planner system interventions on the trade-crew workflows of multistory residential construction projects.” *Journal of Construction Engineering and Management*, American Society of Civil Engineers, 142(7), 4016013.
- Rashid, K. M., and Louis, J. (2019). “Construction Equipment Activity Recognition from IMUs Mounted on Articulated Implements and Supervised Classification.” *Computing in Civil Engineering 2019: Smart Cities, Sustainability, and Resilience*, American Society of Civil Engineers Reston, VA, 130–138.

- RazaviAlavi, S., and AbouRizk, S. (2015). "A hybrid simulation approach for quantitatively analyzing the impact of facility size on construction projects." *Automation in Construction*, 60, 39–48.
- Riley, D. R. (1994). "Modeling the Space Behavior of Construction Activities." The Pennsylvania State University.
- Riley, D. R., and Sanvido, V. E. (1995). "Patterns of construction-space use in multistory buildings." *Journal of Construction Engineering and Management*, American Society of Civil Engineers, 121(4), 464–473.
- Riley, D. R., and Sanvido, V. E. (1997). "Space planning method for multistory building construction." *Journal of Construction Engineering and Management*, American Society of Civil Engineers, 123(2), 171–180.
- Rohani, M., Shafabakhsh, G., Haddad, A., and Asnaashari, E. (2018). "Strategy management of construction workspaces by conflict resolution algorithm and visualization model." *Engineering, Construction and Architectural Management*, Emerald Publishing Limited, 25(8), 1053–1074.
- Russell, M. M., Liu, M., Howell, G., and Hsiang, S. M. (2014). "Case studies of the allocation and reduction of time buffer through the use of the last planner system." *Journal of Construction Engineering and Management*, American Society of Civil Engineers, 141(2), 4014068.
- Saaty, T. (1980). *The analytic hierarchy process: planning, priority setting, resource allocation*. McGraw-Hill International Book Company.
- Saaty, T., and Roseanna, W. (1987). "The analytic hierarchy process—what it is and how it is used." *Mathematical modelling*, Elsevier, 9(3–5), 161–176.
- Sacks, R., Barak, R., Belaciano, B., Gurevich, U., and Pikas, E. (2011). "Field Tests of the Kanbimâ„ç Lean Production Management System." *19th Annual Conference of the International Group for Lean Construction*, J. Rooke and B. Dave, eds.
- Sacks, R., Barak, R., Belaciano, B., Gurevich, U., and Pikas, E. (2013). "KanBIM Workflow

- Management System: Prototype implementation and field testing.” *Lean Construction Journal*.
- Sacks, R., Koskela, L., Dave, B., and Owen, R. (2010a). “Interaction of Lean and Building Information Modeling in Construction.” *Journal of Construction Engineering and Management*, 136(9), 968–980.
- Sacks, R., Radosavljevic, M., and Barak, R. (2010b). “Requirements for building information modelling based lean production management systems for construction.” *Building Information Modeling and Collaborative Working Environments*, 19(5), 641–655.
- Sacks, R., Treckmann, M., and Rozenfeld, O. (2009). “Visualization of workflow to support lean construction.” *Journal of Construction Engineering and Management*, American Society of Civil Engineers, 135(12), 1307–1315.
- Sadeghpour, F., Moselhi, O., and Alkass, S. T. (2006). “Computer-aided site layout planning.” *Journal of Construction Engineering and Management*, American Society of Civil Engineers, 132(2), 143–151.
- Saeedfar, A., Song, L., and Gore, S. (2016). “Dynamic Space Conflict Modeling for Construction Operations.” *ISARC. Proceedings of the International Symposium on Automation and Robotics in Construction*, Vilnius Gediminas Technical University, Department of Construction Economics ..., 1.
- Said, H., and El-Rayes, K. (2013). “Optimal utilization of interior building spaces for material procurement and storage in congested construction sites.” *Automation in Construction*, Elsevier, 31, 292–306.
- Said, H., Marzouk, M., and El-Said, M. (2009). “Application of computer simulation to bridge deck construction: A case study.” *Automation in Construction*, Elsevier, 18(4), 377–385.
- Salem, O., Genaidy, A., Luegring, M., Paez, O., and Solomon, J. (2004). “The Path from Lean Manufacturing to Lean Construction: Implementation and Evaluation of Lean Assembly.” *Proceedings of the 12th Annual Conference on Lean Construction*, S. Bertelsen and C. T.

- Formoso, eds.
- Salem, O., Solomon, J., Genaidy, A., and Luegring, M. (2005). "Site implementation and assessment of lean construction techniques." *Lean construction journal*, 2(2), 1–21.
- Salem, O., Solomon, J., Genaidy, A., and Minkarah, I. (2006). "Lean construction: From theory to implementation." *Journal of Management in Engineering*, American Society of Civil Engineers, 22(4), 168–175.
- Samudio, M., Alves, T. da C. L., and Chambers, D. (2011). "Employing the Principle Of 'Going and Seeing' to Construction." *19th Annual Conference of the International Group for Lean Construction*, J. Rooke and B. Dave, eds.
- Sarhan, S., and Fox, A. (2013). "Barriers to implementing lean construction in the UK construction industry." *The Built & Human Environment Review*, 6(1).
- Sarkar, D. (2015). "A framework for the development of Lean Integrated Project Delivery Model for infrastructure road projects." *International Journal of Civil and Structural Engineering*, Integrated Publishing Association, 5(3), 261.
- Schöttle, A., and Arroyo, P. (2016). "The Impact of the Decision-Making Method in the Tendering Procedure to Select the Project Team." *24th Annual Conference of the International Group for Lean Construction*.
- Semenov, V., Anichkin, A., Morozov, S., Tarlapan, O., and Zolotov, V. (2014). "Effective project scheduling under workspace congestion and workflow disturbance factors." *Australasian Journal of Construction Economics and Building-Conference Series*, 35–50.
- Semenov, V., Arishin, S., Petrishchev, K., and Zolotov, V. (2018). "Holistic framework for spatial-temporal analysis of production schedules." *25th ISPE International Conference on Transdisciplinary Engineering*, Modena, 807–816.
- Seppanen, O., Ballard, G., and Pesonen, S. (2010). "The Combination of Last Planner System and Location-Based Management System." *18th Annual Conference of the International Group for Lean Construction*, K. Walsh and T. Alves, eds., 467–476.

- Shah, R. K., Dawood, N. N., and Dean, J. T. (2009). "An innovative approach for generation of virtual construction model and a time location plan for road construction projects." *Proceedings of the CIB-W078 26th international conference on managing IT in construction*, Istanbul, Turkey.
- Shah, R., and Ward, P. T. (2007). "Defining and developing measures of lean production." *Journal of operations management*, Elsevier, 25(4), 785–805.
- Shahabuddin, S. (2012). "The bullwhip effect: Is there a solution." *The Business Review, Cambridge*, 20(2), 30–36.
- Shang, G., and Sui Pheng, L. (2014). "Barriers to lean implementation in the construction industry in China." *Journal of Technology Management in China*, Emerald Group Publishing Limited, 9(2), 155–173.
- Shang, Z., and Shen, Z. (2016). "A Framework for a Site Safety Assessment Model Using Statistical 4D BIM-Based Spatial-Temporal Collision Detection." *Construction Research Congress*, 2187–2196.
- Shapira, A., and Lyachin, B. (2009). "Identification and analysis of factors affecting safety on construction sites with tower cranes." *Journal of Construction Engineering and Management*, American Society of Civil Engineers, 135(1), 24–33.
- Sharma, S., and Bansal, V. K. (2018). "Location-based planning and scheduling of highway construction projects in hilly terrain using GIS." *Canadian Journal of Civil Engineering*, NRC Research Press, 45(7), 570–582.
- Shmanske, S. (2003). "JIT and the Complementarity of Buffers and Lot Size." *American Business Review*, University of New Haven, 21(1), 100.
- Shou, W., Wang, J., Wang, X., and Chong, H. Y. (2015). "A comparative review of building information modelling implementation in building and infrastructure industries." *Archives of computational methods in engineering*, Springer, 22(2), 291–308.
- Sillars, D. (2009). "Development of decision model for selection of appropriate timely delivery

- techniques for highway projects.” *Journal of the Transportation Research Board*, Transportation Research Board of the National Academies, (2098), 18–28.
- Slack, N., Chambers, S., and Johnston, R. (2010). *Operations management*. Pearson education.
- Son, H., Seong, H., Choi, H., and Kim, C. (2019). “Real-Time Vision-Based Warning System for Prevention of Collisions between Workers and Heavy Equipment.” *Journal of Computing in Civil Engineering*, American Society of Civil Engineers, 33(5), 4019029.
- Song, L., and Eldin, N. N. (2012). “Adaptive real-time tracking and simulation of heavy construction operations for look-ahead scheduling.” *Automation in Construction*, Elsevier, 27, 32–39.
- Song, S., and Marks, E. (2019). “Construction Site Path Planning Optimization through BIM.” *Computing in Civil Engineering 2019: Visualization, Information Modeling, and Simulation*, American Society of Civil Engineers Reston, VA, 369–376.
- Song, Y., and Chua, D. K. H. (2005). “Detection of spatio-temporal conflicts on a temporal 3D space system.” *Advances in Engineering Software*, Elsevier, 36(11–12), 814–826.
- Srinivasa, R., and Kuma, R. D. (2014). *Multi criterion analysis in engineering and management*. PHL Learning Private Limited, Delhi.
- Stanujkic, D., Magdalinovic, N., Jovanovic, R., and Stojanovic, S. (2012). “An objective multi-criteria approach to optimization using MOORA method and interval grey numbers.” *Technological and Economic Development of Economy*, Taylor & Francis, 18(2), 331–363.
- Statistics Canada. (2016). “Construction.” *Statistics Canada*.
- Staub-French, S., and Khanzode, A. (2007). “3D and 4D modelling for design and construction coordination: issues and lessons learned.” *Journal of Information Technology in Construction (ITcon)*, 12(26), 381–407.
- Stephenson, L., Douglas, E., Hanks, D., Hollmann, J., Jagathnarayanan, A., Nosbich, M., Uppal, K., White, P., and Wolfson, D. (2010). *Schedule classification system*. AACE International.
- Stewart, P. (2017). “An Overview of The Process From an Irish Construction Project Management

Perspective.”

<[http://www.irishconstruction.com/building\\_information\\_modelling\\_an\\_overview\\_of\\_the\\_process\\_from\\_an\\_irish\\_construction\\_project\\_management\\_perspective.PAGE3164.html](http://www.irishconstruction.com/building_information_modelling_an_overview_of_the_process_from_an_irish_construction_project_management_perspective.PAGE3164.html)>.

Strafaci, A. (2008). “What does BIM mean for civil engineers? Road and highway projects can benefit from design using building information modelling.” *Civil engineering news*, <[http://images.autodesk.com/adsk/files/what\\_does\\_bim\\_mean\\_for\\_civil\\_engineers\\_ce\\_news\\_1008.pdf](http://images.autodesk.com/adsk/files/what_does_bim_mean_for_civil_engineers_ce_news_1008.pdf)> (Jul. 6, 2017).

Su, X. (2013a). “A Spatial Temporal Information Model for Construction Planning.” *A spatial temporal information model for construction planning*, Purdue University.

Su, X. (2013b). “A Spatial Temporal Information Model for Construction Planning.” *A spatial, temporal information model for construction planning*, Purdue University.

Su, X., and Cai, H. (2014). “Life cycle approach to construction workspace modeling and planning.” *Journal of Construction Engineering and Management*, American Society of Civil Engineers, 140(7), 4014019.

Su, X., and Cai, H. (2018). “A graphical planning method for workspace-aware, four-dimensional modeling to assist effective construction planning.” *Journal of Information Technology in Construction (ITcon)*, 23(17), 340–353.

Suermann, P. C., and Issa, R. R. A. (2009). “Evaluating industry perceptions of building information modelling (BIM) impact on construction.” *Journal of Information Technology in Construction (ITcon)*, 14(37), 574–594.

Suhr, J. (1999). *The choosing by advantages decision-making system*. Greenwood Publishing Group.

Sui Pheng, L., Shang, G., Pheng, S. L., and Shang, G. (2011). “Bridging Western management theories and Japanese management practices: Case of the Toyota Way model.” *Emerald Emerging Markets Case Studies*, Emerald Group Publishing Limited, 1(1), 1–20.

Talmaki, S., and Kamat, V. R. (2012). “Real-time hybrid virtuality for prevention of excavation



- related utility strikes.” *Journal of Computing in Civil Engineering*, American Society of Civil Engineers, 28(3), 4014001.
- Tantisevi, K., and Akinci, B. (2007). “Automated generation of workspace requirements of mobile crane operations to support conflict detection.” *Automation in Construction*, Elsevier, 16(3), 262–276.
- Tavares, R. M., Tavares, J. M. L., and Parry-Jones, S. L. (2008). “The use of a mathematical multicriteria decision-making model for selecting the fire origin room.” *Building and Environment*, Elsevier, 43(12), 2090–2100.
- Teixeira, H. (2014). “VDC implementation in transport infrastructure projects.” *Bim-Vdc*, Norwegian University of Science and Technology.
- Teizer, J. (2015). “Status quo and open challenges in vision-based sensing and tracking of temporary resources on infrastructure construction sites.” *Advanced Engineering Informatics*, Elsevier, 29(2), 225–238.
- Teizer, J., Allread, B. S., Fullerton, C. E., and Hinze, J. (2010). “Autonomous pro-active real-time construction worker and equipment operator proximity safety alert system.” *Automation in construction*, Elsevier, 19(5), 630–640.
- Temiz, I., and Calis, G. (2017). “Selection of construction equipment by using multi-criteria decision-making methods.” *Procedia Engineering*, Elsevier, 196, 286–293.
- Thabet, W. Y., Morad, A. A., and Beliveau, Y. J. (1992). “WorkSpace Constraints Modeling for Process Scheduling Using Artificial Intelligence and 3D Computer Modeling Technologies.” *Computing in Civil Engineering and Geographic Information Systems Symposium*, ASCE, 727–736.
- Toledo, M., González, V. A., Villegas, A., and Mourgues, C. (2014). “Using 4D Models for Tracking Project Progress and Visualizing the Owner’s Constraints in Fast-Track Retail Renovation Projects.” *22nd Annual Conference of the International Group for Lean Construction*, B. T. Kalsaas, L. Koskela, and T. A. Saurin, eds., 969–980.

- Toledo, M., Olivares, K., and González, V. (2016). "Exploration of a Lean-Bim Planning Framework: A Last Planner System and Bim-Based Case Study." *24th Annual Conference of the International Group for Lean Construction*.
- Tommelein, I. D. (1999). "Lean construction experiments using discrete-event simulation: techniques and tools for process re-engineering?" *Int'l. Journal of Computer-Integrated Design and Construction, CIDAC, Special Issue on Construction Process Re-engineering*, 1(2), 53–63.
- Tommelein, I. D., Carr, R. I., and Odeh, A. M. (1994). "Assembly of simulation networks using designs, plans, and methods." *Journal of Construction Engineering and Management*, American Society of Civil Engineers, 120(4), 796–815.
- Treldal, N., Vestergaard, F., and Karlshoj, J. (2016). "Pragmatic use of LOD- a modular approach." *European conference on product and process modelling*, S. Christodoulou and R. Scherer, eds., Taylor & Francis, Cyprus.
- Umar, U. A., Shafiq, N., Malakahmad, A., Nurudin, M. F., Khamidi, M. F., Farhan, S. A., and Gardezi, S. S. S. (2015). "4D BIM application in AEC industry: Impact on integrated project delivery." *Research Journal of Applied Sciences, Engineering and Technology*, Maxwell Scientific Publisher, 10(5), 547–552.
- Vahdatikhaki, F., and Hammad, A. (2014). "Framework for near real-time simulation of earthmoving projects using location tracking technologies." *Automation in Construction*, Elsevier, 42, 50–67.
- Vahdatikhaki, F., and Hammad, A. (2015a). "Dynamic equipment workspace generation for improving earthwork safety using real-time location system." *Advanced Engineering Informatics*, Elsevier, 29(3), 459–471.
- Vahdatikhaki, F., and Hammad, A. (2015b). "Risk-based look-ahead workspace generation for earthwork equipment using near-real-time simulation." *Automation in Construction*, Elsevier, 58, 207–220.

- Vanegas, J. A., Bravo, E. B., and Halpin, D. W. (1993). "Simulation technologies for planning heavy construction processes." *Journal of Construction Engineering and Management*, American Society of Civil Engineers, 119(2), 336–354.
- Viana, D. D., Formoso, C. T., and Kalsaas, B. T. (2012). "Waste in Construction: a Systematic Literature Review on Empirical Studies." *20th Annual Conference of the International Group for Lean Construction*, I. D. Tommelein and C. L. Pasquire, eds.
- Vilasini, N., Neitzert, T. R., and Gamage, J. R. (2011). "Lean methodology to reduce waste in a construction environment." Pacific Association of Quantity Surveyors (PAQS).
- Walker, B. (2009). "Integrated Lean Project Delivery Healthcare's Lifeline in 2009." *Healthcare Design*, 52–59.
- Wambeke, B. W., Hsiang, S. M., and Liu, M. (2011). "Causes of variation in construction project task starting times and duration." *Journal of construction engineering and management*, American Society of Civil Engineers, 137(9), 663–677.
- Wambeke, B. W., Liu, M., and Hsiang, S. M. (2012). "Using last planner and a risk assessment matrix to reduce variation in mechanical related construction tasks." *Journal of Construction Engineering and Management*, American Society of Civil Engineers, 138(4), 491–498.
- Wang, H. J., Zhang, J. P., Chau, K. W., and Anson, M. (2004). "4D dynamic management for construction planning and resource utilization." *Automation in Construction*, Elsevier, 13(5), 575–589.
- Wang, J., Hou, L., Chong, H.-Y., Liu, X., Wang, X., and Guo, J. (2014). "A cooperative system of GIS and BIM for traffic planning: A high-rise building case study." *International Conference on Cooperative Design, Visualization and Engineering*, Springer, 143–150.
- Wang, J., and Razavi, S. N. (2015). "Low false alarm rate model for unsafe-proximity detection in construction." *Journal of Computing in Civil Engineering*, American Society of Civil Engineers, 30(2), 4015005.
- Wang, Q., Guo, Z., Mei, T., Li, Q., and Li, P. (2018a). "Labor crew workspace analysis for

- prefabricated assemblies' installation: A 4D-BIM-based approach." *Engineering, Construction and Architectural Management*, Emerald Publishing Limited, 25(3), 374–411.
- Wang, Q., Guo, Z., Mintah, K., Li, Q., Mei, T., and Li, P. (2018b). "Cell-Based Transport Path Obstruction Detection Approach for 4D BIM Construction Planning." *Journal of Construction Engineering and Management*, American Society of Civil Engineers, 145(3), 4018141.
- Wang, X., Zhang, Y. Y., Wu, D., and Gao, S. De. (2011). "Collision-free path planning for mobile cranes based on ant colony algorithm." *Key Engineering Materials*, Trans Tech Publ, 1108–1115.
- Webb, R. M., Smallwood, J., and Haupt, T. C. (2004). "The potential of 4D CAD as a tool for construction management." *Journal of Construction Research*, World Scientific, 5(01), 43–60.
- Winch, G. M. (2012). *Managing Construction Projects*. John Wiley & Sons.
- Winch, G. M., and North, S. (2006). "Critical space analysis." *Journal of Construction Engineering and Management*, American Society of Civil Engineers, 132(5), 473–481.
- Wodalski, M. J., Thompson, B. P., Whited, G., and Hanna, A. S. (2011). *Applying Lean Techniques in the Delivery of Transportation Infrastructure Construction Projects*. National Center for Freight and Infrastructure Research and Education (CFIRE) University of Wisconsin-Madison, Madison, United States.
- Womack, J., and Jones, D. (2003). *Lean Thinking: Banish Waste and Create Wealth in Your Corporation*. Simon and Schuster.
- Womack, J. P. (2006). "Value stream mapping." *Manufacturing engineering*, 136(5), 145–156.
- Womack, J. P., and Jones, D. T. (1997). "Lean thinking—banish waste and create wealth in your corporation." *Journal of the Operational Research Society*, Taylor & Francis, 48(11), 1148.
- Worrall, S., and Nebot, E. (2008). "A probabilistic method for detecting impending vehicle interactions." *2008 IEEE International Conference on Robotics and Automation*, IEEE, 1787–1791.

- Wu, H., Tao, J., Li, X., Chi, X., Li, H., Hua, X., Yang, R., Wang, S., and Chen, N. (2013). "A location-based service approach for collision warning systems in concrete dam construction." *Safety science*, Elsevier, 51(1), 338–346.
- Wu, I.-C., Borrmann, A., Beißert, U., König, M., and Rank, E. (2010). "Bridge construction schedule generation with pattern-based construction methods and constraint-based simulation." *Advanced Engineering Informatics*, Elsevier, 24(4), 379–388.
- Wu, I., and Chiu, Y. (2010). "4D Workspace conflict detection and analysis system." *Proceedings of the 10th International Conference on Construction Applications of Virtual Reality*.
- Wu, L.-W., and Guo, S.-J. (2014). "An application of space syntax to critical working space analysis: The case of building construction." *Journal of Marine Science and Technology*, 22(5), 572–582.
- Wu, W., and Issa, R. R. A. (2014). "Key issues in workforce planning and adaptation strategies for BIM implementation in the construction industry." *Construction Research Congress 2014: Construction in a Global Network*, 847–856.
- Wu, X., Zhao, W., Ma, T., and Yang, Z. (2019). "Improving the Efficiency of Highway Construction Project Management Using Lean Management." *Sustainability*, Multidisciplinary Digital Publishing Institute, 11(13), 3646.
- Yabuki, N. (2010). "Toward adoption of virtual construction in the infrastructure domain." *Journal of Society for Social Management Systems*, SMS10-160.
- Yang, J., Park, M.-W., Vela, P. A., and Golparvar-Fard, M. (2015). "Construction performance monitoring via still images, time-lapse photos, and video streams: Now, tomorrow, and the future." *Advanced Engineering Informatics*, Elsevier, 29(2), 211–224.
- Yee, A. A. (2001). "Structural and economic benefits of precast/prestressed concrete construction." *PCI Journal*, 46(4).
- Zavadskas, E. K., Antucheviciene, J., Turskis, Z., and Adeli, H. (2016). "Hybrid multiple-criteria decision-making methods: A review of applications in engineering." *Scientia Iranica*.

- Transaction A, Civil Engineering*, Sharif University of Technology, 23(1), 1.
- Zavadskas, E. K., Turskis, Z., and Kildienė, S. (2014). "State of the art surveys of overviews on MCDM/MADM methods." *Technological and economic development of economy*, Taylor & Francis, 20(1), 165–179.
- Zayed, T. M., and Halpin, D. W. (2000). "Construction engineering I: Simulation as a tool for resource management." *Proceedings of the 32nd conference on Winter simulation*, Society for Computer Simulation International, 1897–1906.
- Zeiss, G. (2012). "Using BIM techniques to transform highway and road construction." *Between the poles; All about infrastructure*, <<https://geospatial.blogs.com/geospatial/2012/08/using-bim-techniques-to-transform-highway-and-road-construction.html>> (Nov. 29, 2018).
- Zhang, C., and Hammad, A. (2011). "Multiagent approach for real-time collision avoidance and path replanning for cranes." *Journal of Computing in Civil Engineering*, American Society of Civil Engineers, 26(6), 782–794.
- Zhang, C., Hammad, A., and Albahnassi, H. (2009). "Path re-planning of cranes using a real-time location system." *Automation and Robotics applications-26th International Symposium on Automation and Robotics in Construction (ISARC2-09)*, 412–420.
- Zhang, C., Hammad, A., Zayed, T. M., Wainer, G., and Pang, H. (2007). "Cell-based representation and analysis of spatial resources in construction simulation." *Automation in Construction*, Elsevier, 16(4), 436–448.
- Zhang, C., Zayed, T., Hijazi, W., and Alkass, S. (2016). "Quantitative Assessment of Building Constructability Using BIM and 4D Simulation." *Open Journal of Civil Engineering*, Scientific Research Publishing, 6(03), 442.
- Zhang, G., and Zou, P. X. (2007). "Fuzzy analytical hierarchy process risk assessment approach for joint venture construction projects in China." *Journal of Construction Engineering and Management*, American Society of Civil Engineers, 133(10), 771–779.
- Zhang, J.-P., Anson, M., and Wang, Q. (2000). "A New 4D Management Approach to Construction

- Planning and Site Space Utilization.” *Computing in Civil and Building Engineering (2000)*, 15–22.
- Zhang, J. P., and Hu, Z. Z. (2011). “BIM-and 4D-based integrated solution of analysis and management for conflicts and structural safety problems during construction: 1. Principles and methodologies.” *Automation in construction*, Elsevier, 20(2), 155–166.
- Zhang, L. (2015). *Repetitive project scheduling: Theory and methods*. Elsevier.
- Zhang, S., Sulankivi, K., Kiviniemi, M., Romo, I., Eastman, C. M., and Teizer, J. (2015a). “BIM-based fall hazard identification and prevention in construction safety planning.” *Safety science*, Elsevier, 72, 31–45.
- Zhang, S., Teizer, J., Pradhananga, N., and Eastman, C. M. (2015b). “Workforce location tracking to model, visualize and analyze workspace requirements in building information models for construction safety planning.” *Automation in Construction*, 60, 74–86.
- Zhou, J., Love, P. E. D., Wang, X., Teo, K. L., and Irani, Z. (2013). “A review of methods and algorithms for optimizing construction scheduling.” *Journal of the Operational Research Society*, Taylor & Francis, 64(8), 1091–1105.
- Zhou, W., Heesom, D., and Feng, A. (2010). “An interactive approach to collaborative 4D construction planning.” *Journal of Information Technology in Construction (ITCon)*, 14(5), 30–47.
- Zolynski, G., Schmidt, D., and Berns, K. (2014). “Safety for an autonomous bucket excavator during typical landscaping tasks.” *New Trends in Medical and Service Robots*, Springer, 357–368.
- Zou, P. X. W., and Li, J. (2010). “Risk identification and assessment in subway projects: case study of Nanjing Subway Line 2.” *Construction Management and Economics*, Taylor & Francis, 28(12), 1219–1238.
- Zuluaga, C. M., Albert, A., and Arroyo, P. (2018). “Protecting Bridge Maintenance Workers from Falls: Evaluation and Selection of Compatible Fall Protection Supplementary Devices.”

*Journal of Construction Engineering and Management*, American Society of Civil Engineers,  
144(8), 4018073.



## **APPENDIX I: PUBLICATIONS**

### **Journal Publications:**

- **Igwe, C.**, Hammad, A. and Nasiri, F., 2021. Multi-criteria decision-making method for selecting scheduling technique in elevated urban highway projects. *International Journal of Construction Project Management* 13(1), pp 1-25 (***In Press***).
- **Igwe, C.**, Hammad, A. and Nasiri, F., 2020. Framework for equipment workspace management using the last planner and 4D BIM for elevated urban highway projects. *Engineering, Construction and Architectural Management* (***Submitted- Under Review***).
- **Igwe, C.**, Hammad, A. and Nasiri, F., 2020. Empirical study on non-physical waste factors in the construction industry. *Journal of Construction Engineering and Management* (***Submitted- Under Review***).
- **Igwe, C.**, Nasiri, F. and Hammad, A., 2020. Construction workspace management: critical review and roadmap. *International Journal of Construction Management*, pp.1-14.
- **Igwe, C.**, Hammad, A. and Nasiri, F., 2020. Influence of lean construction wastes on the transformation-flow-value process of construction. *International Journal of Construction Management*, pp.1-7.
- Mohammadi, A., **Igwe, C.**, Amador-Jimenez, L. and Nasiri, F., 2020. Applying lean construction principles in road maintenance planning and scheduling. *International Journal of Construction Management*, pp.1-11.

### **Conference Publications:**

- **Igwe, C.**, Hammad, A., and Nasiri, F. (2019). "Using lean tools and 4D modelling for equipment workspace planning". Proceedings of *Canadian society of engineering conference, Laval, Canada*.

- **Igwe, C.**, Nasiri, F., and Hammad, A. (2019). "Using Choosing-by-Advantage method for selecting scheduling technique in elevated urban highway projects." Proceedings of *project management symposium*, University of Maryland, Baltimore, United States.
- **Igwe, C.**, Mohammadi, A., Hammad, A., and Nasiri, F. (2018). "House of wastes: What it is and its implication for project management. Proceedings of *project management symposium*, University of Maryland, Baltimore, United States.
- Mohammadi, A., **Igwe, C.**, Amador-Jimenez, L., and Nasiri, F. (2018). "Asset management framework for road maintenance." Proceedings of *Canadian society of engineering conference*, Vancouver, Canada.
- **Igwe, C.**, Hammad, A., and Nasiri, F. (2017). "Evaluating the impact of buildability assessment and value management on construction project delivery. Proceedings of *project management symposium*, University of Maryland, Baltimore, United States.

## **APPENDIX II: RESEARCH SURVEY 1**

My name is Charles Igwe, a doctoral student at Concordia University Montreal conducting research in lean construction. The objective of this questionnaire is to rank the lean construction waste (also referred to as non-physical wastes) based on their degree of influence on the transformation, flow and value processes of construction using the relative importance index. The goal of the research is to better understand how the LC wastes affect construction as a first step to mitigating them.

Please feel free to share the survey link with colleagues and peers in the construction domain.

### **Confidentiality**

- The information provided will be used only in support of this research project
- Completing this survey is completely voluntary
- All participant information (names, organization and email address) will be kept confidential, and you will receive a copy of the analyzed results upon request.

If you have any concerns about this survey, please contact: Charles Igwe ([c\\_igwe@live.concordia.ca](mailto:c_igwe@live.concordia.ca)).

We would like to thank you in advance for your assistance.

Sincerely

Charles Igwe

Doctoral Student

Department of Building, Civil and Environmental Engineering

Concordia University

Montreal, Quebec

# Ranking the Lean Construction Wastes Based on the Transformation-Flow-Value Process of Construction

The goal of this survey is to rank the lean construction wastes (also referred to as non-physical wastes) based on the transformation-flow-value process. The non-physical wastes include Defect/Rework, Overproduction, Waiting, Non-utilized Talent, Transportation, Inventory, Motion, Extra-Processing and Making-Do.

The survey is divided into two sections and contains 33 questions in total. (Please answer all questions)

The table below provides an explanation of the TFV process.

\* Required

An integrated view of construction as production

Description	Transformation view	Flow view	Value generation view
Conceptualization of construction as production	Direct transformation of construction inputs into outputs	The flow of materials composed of procurement, inspection, moving, waiting and transformation	Creating value for the client by fulfilling his stated requirements
Main principles	Ensures that the construction process is more efficient	Elimination and reduction of all non-value adding activities (waste)	Ensures the best functional worth alternative is selected to reduce/eliminate value loss
Procedures	Work breakdown structure, materials requirement planning, organizational responsibility chart	Last planner system to facilitate pull production and continuous flow of work	Value stream mapping, quality function deployment
Contribution to the construction process	Ensure that what has to be done is done	Ensures that what is unnecessary is done as little as possible	Ensures client requirements are met in the best possible manner with the least possible cost for the stated quality requirement

1. What is your highest level of education? \*

---

2. How many years of work experience do you have \*

More than 10 years

Between 6-10 years

Between 3-5 years

0-3 years

3. What is your role within your organization? \*

Project Management

Site Engineer

Team Lead/Foreman

Others (Please specify)

4. What is the size of your organization? \*

Large (More than 200 employees)

Medium (50-200 employees)

Small (Less than 50 employees)

5. What type of projects is your organization typically involved in \*

Buildings

Roads and Bridges

Other civil projects (Please specify)

6. If you would like to receive the summary of the result, please provide your email address below

---

Rank the LC wastes based on the TFV

7. How important is the waste of "Defect/Rework" in the TRANSFORMATION phase of construction

1 2 3 4 5

Not Important      Extremely Important

8. How important is the waste of "Overproduction" in the TRANSFORMATION phase of construction

1 2 3 4 5

Not Important      Extremely Important

9. How important is the waste of "Waiting" in the TRANSFORMATION phase of construction

1 2 3 4 5

Not Important      Extremely Important

10. How important is the waste of "Non-Utilized Talent" in the TRANSFORMATION phase of construction

1 2 3 4 5

Not Important      Extremely Important

11. How important is the waste of "Transportation" in the TRANSFORMATION phase of construction

1 2 3 4 5

Not Important      Extremely Important

12. How important is the waste of "Inventory" in the TRANSFORMATION phase of construction

1 2 3 4 5

Not Important      Extremely Important

13. How important is the waste of "Motion" in the TRANSFORMATION phase of construction

1 2 3 4 5

Not Important      Extremely Important

14. How important is the waste of "Extra-Processing" in the TRANSFORMATION phase of construction

1 2 3 4 5

Not Important      Extremely Important

15. How important is the waste of "Making-Do" in the TRANSFORMATION phase of construction

1 2 3 4 5

Not Important      Extremely Important

16. How important is the waste of "Defect/Rework" in the FLOW phase of construction

1 2 3 4 5

Not Important      Extremely Important

17. How important is the waste of "Overproduction" in the FLOW phase of construction

1 2 3 4 5

Not Important      Extremely Important

18. How important is the waste of "Waiting" in the FLOW phase of construction

1 2 3 4 5

Not Important      Extremely Important

19. How important is the waste of "Non-Utilized Talent" in the FLOW phase of construction

1 2 3 4 5

Not Important      Extremely Important

20. How important is the waste of "Transportation" in the FLOW phase of construction

1 2 3 4 5

Not Important      Extremely Important

21. How important is the waste of "Inventory" in the FLOW phase of construction

1 2 3 4 5

Not Important      Extremely Important

22. How important is the waste of "Motion" in the FLOW phase of construction

1 2 3 4 5

Not Important      Extremely Important

23. How important is the waste of "Extra-Processing" in the FLOW phase of construction

1 2 3 4 5

Not Important      Extremely Important



24. How important is the waste of "Making-Do" in the FLOW phase of construction

1 2 3 4 5

Not Important      Extremely Important

25. How important is the waste of "Defect/Rework" in the VALUE phase of construction

1 2 3 4 5

Not Important      Extremely Important

26. How important is the waste of "Overproduction" in the VALUE phase of construction

1 2 3 4 5

Not Important      Extremely Important

27. How important is the waste of "Waiting" in the VALUE phase of construction

1 2 3 4 5

Not Important      Extremely Important

28. How important is the waste of "Non-Utilized Talent" in the VALUE phase of construction

1 2 3 4 5

Not Important      Extremely Important

29. How important is the waste of "Transportation" in the VALUE phase of construction

1 2 3 4 5

Not Important      Extremely Important

30. How important is the waste of "Inventory" in the VALUE phase of construction

1 2 3 4 5

---

Not Important      Extremely Important

---

31. How important is the waste of "Motion" in the VALUE phase of construction

1 2 3 4 5

---

Not Important      Extremely Important

---

32. How important is the waste of "Extra-Processing" in the VALUE phase of construction

1 2 3 4 5

---

Not Important      Extremely Important

---

33. How important is the waste of "Making-Do" in the VALUE phase of construction

1 2 3 4 5

---

Not Important      Extremely Important

---

## **APPENDIX III: RESEARCH SURVEY 2**

My name is Charles Igwe, a doctoral student at Concordia University Montreal conducting research in lean construction. The objective of this questionnaire is to rank the factors promoting the occurrence of lean construction wastes (also referred to as non-physical wastes) in highway projects using the Analytical Hierarchical Process (AHP). The goal of the research is to provide a pairwise comparison for factors promoting LC wastes and assign priority weights to the factors. The multi-criteria decision-making hierarchy for the criteria and factors is attached to the survey questionnaire. The scope of the survey is limited to performing pairwise comparisons for only the level 2 criteria of the MCDM hierarchy.

Please feel free to share the survey link with colleagues and peers in the construction domain.

### **Confidentiality**

- The information provided will be used only in support of this research project
- Completing this survey is completely voluntary
- All participant information (names, organization and email address) will be kept confidential, and you will receive a copy of the analyzed results upon request.

If you have any concerns about this survey, please contact: Charles Igwe ([c\\_igwe@live.concordia.ca](mailto:c_igwe@live.concordia.ca)).

We would like to thank you in advance for your assistance.

Sincerely

Charles Igwe

Doctoral Student

Department of Building, Civil and Environmental Engineering

Concordia University

Montreal, Quebec

# Lean Wastes

The goal of this survey is to derive priorities for the critical factors (Level 2) that impact wastes in highway construction projects based on the transformation, flow, value process (shown below). The MCDM hierarchy (shown below) was designed based on an extensive literature review.

\* Required

TFV Process

Description	Transformation view	Flow view	Value generation view
Conceptualization of construction as production	Direct transformation of construction inputs into outputs	The flow of materials composed of procurement, inspection, moving, waiting and transformation	Creating value for the client by fulfilling his stated requirements
Main principles	Ensures that the construction process is more efficient	Elimination and reduction of all non-value adding activities (waste)	Ensures the best functional worth alternative is selected to reduce/eliminate value loss
Procedures	Work breakdown structure, materials requirement planning, organizational responsibility chart	Last planner system to facilitate pull production and continuous flow of work	Value stream mapping, quality function deployment
Contribution to the construction process	Ensure that what has to be done is done	Ensures that what is unnecessary is done as little as possible	Ensures client requirements are met in the best possible manner with the least possible cost for the stated quality requirement

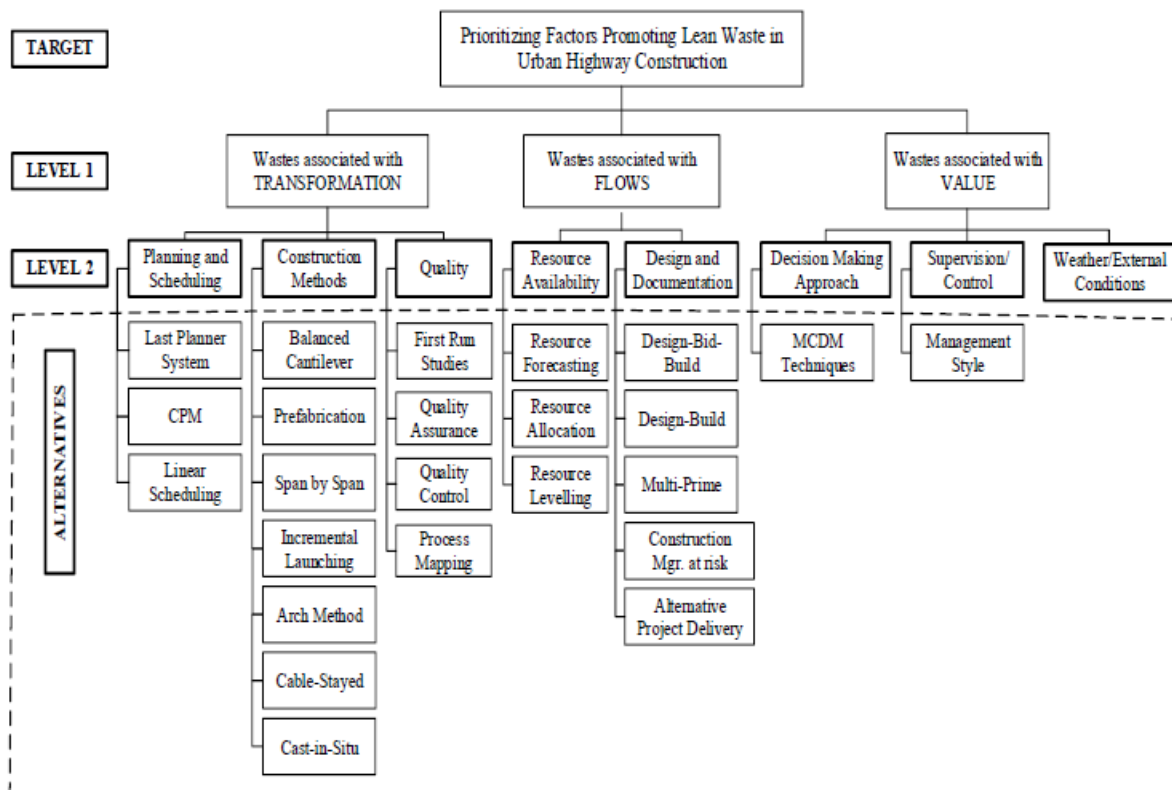

A-1)With respect to minimizing wastes in the TRANSFORMATION phase of highway construction projects, how important is selecting the "right" planning and scheduling technique to selecting the "right" construction method? \*

- Extremely more Important (9)
- Strongly more Important (7)
- More Important (5)
- Slightly more Important (3)
- Equally Important (1)
- Slightly less Important (3)
- Less Important (5)
- Strongly less Important (7)
- Extremely less Important (9)

A-2)With respect to minimizing wastes in the TRANSFORMATION phase of highway construction projects, how important is selecting the "right" planning and scheduling technique to ensuring the client quality expectations are achieved? \*

- Extremely more Important (9)
- Strongly more Important (7)
- More Important (5)
- Slightly more Important (3)
- Equally Important (1)
- Slightly less Important (3)
- Less Important (5)
- Strongly less Important (7)
- Extremely less Important (9)

A-3) With respect to minimizing wastes in the TRANSFORMATION phase of highway construction projects, how important is the chosen construction method to ensuring client quality expectations are achieved? \*

- Extremely more Important (9)
- Strongly more Important (7)
- More Important (5)
- Slightly more Important (3)
- Equally Important (1)
- Slightly less Important (3)
- Less Important (5)
- Strongly less Important (7)
- Extremely less Important (9)

B-1) With respect to minimizing wastes in the FLOW phase of highway construction projects, what is the relative importance of resource availability to design and documentation in achieving successful project delivery? \*

- Extremely more Important (9)
- Strongly more Important (7)
- More Important (5)
- Slightly more Important (3)
- Equally Important (1)
- Slightly less Important (3)
- Less Important (5)
- Strongly less Important (7)
- Extremely less Important (9)

C-1) With respect to minimizing wastes in the VALUE phase of highway construction projects, what is the relative importance of the decision making approach to supervision and control in achieving successful project delivery? \*

- Extremely more Important (9)
- Strongly more Important (7)
- More Important (5)
- Slightly more Important (3)
- Equally Important (1)
- Slightly less Important (3)
- Less Important (5)
- Strongly less Important (7)
- Extremely less Important (9)

C-2) With respect to minimizing wastes in the VALUE phase of highway construction projects, what is the relative importance of the decision-making approach to weather/external conditions in achieving successful project delivery? \*

- Extremely more Important (9)
- Strongly more Important (7)
- More Important (5)
- Slightly more Important (3)
- Equally Important (1)
- Slightly less Important (3)
- Less Important (5)
- Strongly less Important (7)
- Extremely less Important (9)

C-3) With respect to minimizing wastes in the VALUE phase of highway construction projects, what is the relative importance of supervision/control to weather/external conditions in achieving successful project delivery? \*

- Extremely more Important (9)
- Strongly more Important (7)
- More Important (5)
- Slightly more Important (3)
- Equally Important (1)
- Slightly less Important (3)
- Less Important (5)
- Strongly less Important (7)
- Extremely less Important (9)

D-1) How many years of practical experience do you possess? \*

---

D-2) What is your position within your organization? \*

---

D-3) What type of project is your organization typically involved in? \*

---

D-4) Would you like to be sent a copy of the survey results? \*

- Yes
- No



D-5) If you answered "Yes" to the previous please provide your email address.

---

D-6) Would you like to be contacted for the second phase of the data collection? \*

Yes

No

D-7) If you answered "Yes" to the previous please provide your email address.

---

### APPENDIX III: DETAILED AHP ANALYSIS

**Step 1:** To compute the weights for the different criteria, an  $m \times m$  real matrix designated as matrix **A** is constructed where  $m$  is the number of evaluation criteria considered, with each entry  $a_{jk}$  of the matrix **A** representing the importance of the  $j$ th criterion relative to the  $k$ th criterion. If  $a_{jk} > 1$ , then the  $j$ th criterion is more important than the  $k$ th criterion. However, if  $a_{jk} < 1$ , then the  $j$ th criterion is less important than the  $k$ th criterion. If two criteria have the same importance, then the entry  $a_{jk}$  is 1.

$$\text{Matrix } A_{jk} = \begin{matrix} & A_{11} & A_{12} & A_{13} \\ A_{21} & & A_{22} & A_{23} \\ A_{31} & & A_{32} & A_{33} \end{matrix}$$

**Level 2 comparison matrix**

	Planning	Construction method	Quality
Planning	1.00	2.00	6.00
Construction method	0.50	1.00	4.00
Quality	0.17	0.25	1.00
Total	1.67	3.25	11.00

**Step 2:** The normalized pairwise comparison matrix ( $A_{norm}$ ) is computed as

$$\bar{a}_{jk} = \frac{a_{jk}}{\sum_{l=1}^m a_{lk}}$$

**Level 2 normalized matrix ( $A_{norm}$ )**

	Planning	Construction method	Quality
Planning	0.60	0.62	0.55
Construction method	0.30	0.31	0.36
Quality	0.10	0.08	0.09

**Step 3:** The criteria weight **w** is built by averaging the entries on each row of  $A_{norm}$  i.e

$$w_j = \frac{\sum_{l=1}^m \bar{a}_{jl}}{m}$$

**Criteria Weight (w)**

	Planning	Construction method	Quality	w
Planning	0.60	0.62	0.55	0.59
Construction method	0.30	0.31	0.36	0.32
Quality	0.10	0.08	0.09	0.09

**Step 4:** There are sub-processes involved in checking the consistency of the responses. Each value in the first column of the pairwise comparison matrix is multiplied by the criteria weight of the first item considered. The same procedure is applied for other items on the matrix. The weighted sum is then obtained by the summation of the values across the rows.

$$0.59 \begin{bmatrix} 1.00 \\ 0.50 \\ 0.17 \end{bmatrix} + 0.32 \begin{bmatrix} 2.00 \\ 1.00 \\ 0.25 \end{bmatrix} + 0.09 \begin{bmatrix} 6.00 \\ 4.00 \\ 1.00 \end{bmatrix} = \begin{bmatrix} 0.59 \\ 0.29 \\ 0.10 \end{bmatrix} + \begin{bmatrix} 0.65 \\ 0.32 \\ 0.08 \end{bmatrix} + \begin{bmatrix} 0.54 \\ 0.36 \\ 0.09 \end{bmatrix} = \begin{bmatrix} 1.77 \\ 0.97 \\ 0.27 \end{bmatrix}$$

The elements of the vector of the weighted sum are then divided by the corresponding criteria weight. The eigenvalue ( $\lambda_{max}$ ) is obtained as the average of the resulting row matrix:

$$\begin{bmatrix} 1.77/0.59 \\ 0.97/0.32 \\ 0.27/0.09 \end{bmatrix} = \begin{bmatrix} 3.02 \\ 3.01 \\ 3.00 \end{bmatrix}$$

$$\lambda_{max} = \frac{3.02 + 3.01 + 3.00}{3} = 3.01$$

The consistency index (CI) is thereafter obtained using the formula:

$$CI = \frac{\lambda_{max} - n}{n - 1} = \frac{3.01 - 3}{3 - 1} = 0.0046$$

**Step 5:** Finally, the consistency ratio is (CR) is computed by comparing it with the appropriate consistency index called the Random Consistency Index (RI) shown in Table 4.

$$CR = \frac{CI}{RI} = \frac{0.0046}{0.58} = 0.008 < 0.1$$

Since the CR obtained is less than 0.10, we can assume our judgment matrix is reasonably consistent. A perfectly consistent decision-maker should always obtain CI = 0, but small values of inconsistency may be tolerated, if:

$$\frac{CI}{RI} < 0.1$$