



Article

Conceptual Design and Analysis of Small Power Station for Supporting Unmanned Aerial Vehicle (UAV) Deployment

Surya Alhadi^a, Suchada Rianmora^{b,*}, and Maroay Phlernjai^c

School of Manufacturing Systems and Mechanical Engineering, Sirindhorn International Institute of Technology, Thammasat University, Rangsit, Pathum Thani 12120, Thailand

E-mail: ^asuryaalhadi22@gmail.com, ^{b,*}suchada@siit.tu.ac.th (Corresponding author),

^cmaroay_p@siit.tu.ac.th

Abstract. “Flight time” of unmanned aerial vehicle (UAV) or drone flying robot is the key component for supporting industrial activities. In practice, most battery-powered drones can fly 20 - 30 minutes for a single charging cycle. When the battery depleted, the drone is forced to come back to the station to recharge, or swap in a charged battery. However, these tasks are manually done by human multiple times. Aside from the inconvenience, human error and inappropriate force application may damage the socket compartment or loosen the locking system between battery and socket, making higher risk of the battery accidentally fall off from the socket during the flight. This research presents a “Small power station” to automatically load and unload battery from the drone’s mainframe with a constant force. The station has two main functions: drone positioning, and six-slot-battery exchange mechanism. Product design and development (PDD) and Kano analysis method were applied to properly list necessary compartments of the designed station. Finite element analysis (FEA) and kinematic calculation were applied to virtually check whether or not the developed platform was designed in the safety boundary. “DJI Matrice 100” drone was applied as the case study to demonstrate the proposed approach.

Keywords: Finite element analysis, unmanned aerial vehicle, conceptual design, Kano analysis, product design and development.

ENGINEERING JOURNAL Volume 25 Issue 8

Received 31 January 2021

Accepted 26 July 2021

Published 31 August 2021

Online at <https://engj.org/>

DOI:10.4186/ej.2021.25.8.51

1. Introduction

Unmanned aerial vehicle (UAV) is one of the advanced technologies in the form of aircraft. The shape resembles an airplane or helicopter that can be operated without being driven by a crew or pilot on board. UAV or sometimes called drone flying robot can fly thousands of kilometers depends on the specification, and the small drone also useful in a confined space [1]. Previously drone was only used for military applications, it used to carry out various kinds of intelligence activities that can monitor all parts of the area that are very dangerous. But apparently in this all-sophisticated era, drones have been widely used by all parties.

According to a Wall Street Journal report, the history of non-military drone use began in earnest in 2006. Government agencies usually use a drone to do mapping in the air, this drone is also very important for detecting wind directions. In 2013, logistic companies such as Amazon and DHL developed the drone delivery system, it used to carry or deliver goods in the shipping facilities for a sensitive product. In a recent application, the drone used to capture 3D images or videos in the room or outside environments using a mounted camera [2].

The percentage drone uses shown in Fig. 1, the top five applications are respectively belonging to photography 42.9%, real estate or properties business 20.7%, utilities 10.9%, construction 8.6%, and agriculture 8%. Based on the Consumer Technology Association (CTA) the growth market for the drone in the United States has increased significantly every year since 2013 until present [3].

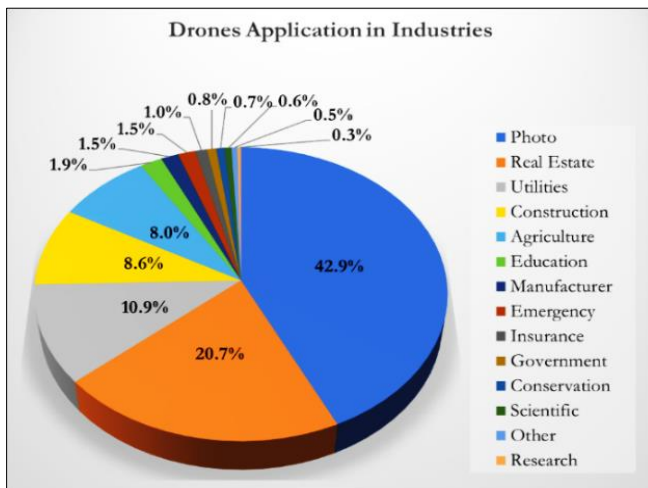

Fig. 1. Drones percentage of uses.

There are so many applications today for the drone in the industrial activities, e.g., routine inspection activities, warehousing management, delivery services, agricultural and infrastructure development [4, 5].

Some limitations appear for this robotic aircraft to fulfill those activities, and one of the most crucial problems is on their flight time. The heavyweight of the battery translates directly into increased energy

requirements of the UAV's motors, which limits the flight time available for surveillance and monitoring applications [6]. Most of the drones are powered by Li-Po batteries which only power drones up to 25-30 minutes for a single flying cycle. Li-Po batteries are used by many autonomous aerial vehicles because they have a high energy density, and they can sustain from the high current loads. However, with a relatively long charging time of 1-2 hours depending on the battery type, the availability or the flying cycles of the drone are limited. Moreover, manually swapping a new battery into the drone every 30 minutes is not only a tedious task, but also increasing risk of damaging the drone structure and battery socket due to human stress and error.

As times evolved, many researchers invented new technologies about this flying robot. However, because of the flight time limitations, the usefulness of the drones could not be fully realized. Some existing solution tries to overcome this problem by using robot hand and automatic battery swapping system with linear positioner. This paper proposes the design concept of a small power station to increase the flying cycle of the drone by automating battery swapping action with a ring-shaped battery storage and tapered hole positioner. This design is expected to be adopted in several working areas which use drones, reducing human stress and error while working in the repetitive works and perform a good continuous flying cycle for the drone itself. Some existing designs of battery swapping platform and charging platform are reviewed in the next section. In contrast to existing studies, this paper tries to offer a quick battery swap design that minimize the time for post-landing activities: drone positioning, locating battery socket, swapping and release. Therefore, it could impact the drone deployment for the specific activity in the industrial environment.

2. Literature Review

Recently, transportation cost is one of the expensive and important elements in logistics and supply chain. These elements need to be minimized and some researchers have tried to simply estimate the transportation cost per trip as a constant that is not depended upon the transportation quantity; some have tried to consider and launch new methods of computing the transportation cost that are more robust and realistic.

For supporting suppliers' point of view and requirement, size of the vehicle (e.g., truck) applied and the maximum number of trucks that can be applied optimistically and economically must be taken into consideration for supporting transportation from the manufacturers to the customers. For a lower unit cost, the suitable choice is medium-sized truck rather than the small-sized truck [7 - 10].

Moreover, the supply chain involves many inventory items, which is more complicated than a single inventory item. In order to satisfy the delivery system in urban logistics services, vehicle routing problem with drones

(VRPD) is used to minimizing transportation cost that normally solved by truck only [11].

The vehicle routing problems with drones (VRPD) is a variant of a vehicle routing problem (VRP) with the implementation of drones in the operations. In VRPD, the problem aims to find the optimal set of routes for a fleet of vehicles to travel in the delivery process to a given set of customers. The VRPD concept is also the solution to solve the last mile delivery (the furthest customer) problem, which means if the last mile delivery service is fulfilled with truck service it will give the higher transportation cost and consume more time to be satisfied.

The VRPD aims to determine a set of vehicles of minimum total cost over a single period with several constraints regarding to the trucks, drones, and service area limitation [12].

The approach of the VRPD concept is used to conduct in this research regarding to the delivery services which are fulfilled with drones only. The main problem is found and the main question is raised as “how to design a small power station to make the drone fly continuously without truck implementation on it”.

The benefits obtained from some existing designs were applied as the key guidelines to create the proposed design of the power station system. However, the drone’s flight time limitations have been existed and needed to be improved.

2.1. Types of UAVs

Basically, two main types of UAVs are mentioned and discussed which are *rotary-wing type*, and *fixed-wing type*. The key components of the UAVs consist of a body that moves by using multiple rotors, and the frame or structure that is similar to a general aircraft having a fixed wing on either side of the body [13].

2.1.1. Rotary-wing type

The *rotary-wing* or *rotorcraft* types tend to be more popular since they can take-off and land vertically, thus not requiring a launcher or runway, they can hover and are very agile making them best suited for more precision manoeuvrability applications. However, these types of UAVs require more mechanical and electronic complexity leading to more complicated maintenance, decreasing operational time and increasing costs.

More generally, where possible limitation issues exist, this type presents about small load capabilities, increasing power requirements, decreasing operational duration, and increasing costs. Comparing to rotary-wing types, fixed-wing types provide simple structure, and they can be maintained easily where the essential benefits are shown through more efficient aerodynamics, decreasing operational costs, and increasing flight time.

There are two types of rotary-wing type. One being a *helicopter*, consisting of a single rotor system. Another type being a *multirotor*. A multirotor can have up to eight rotors on the main platform; since adding motors can provide

greater stability, redundancy, and greater lifting capacity. The most popular rotorcraft platform is the “*quadcopter*” [14, 15].

Different types of rotary-wing or rotorcraft type can be classified into *quadrotor*, *hexacopter*, and *octocopter*.

1. Quadrotor

This type of rotor copter contains four arms, and each arm has a motorized propeller at its tip (Fig. 2). Simply saying that, quadcopters can be illustrated as a design of helicopter with four propellers. Some advantages of this type can be expressed as these following statements [14];

- providing a stable and simple to operate UAV
- carrying various ranges of payloads
- landing and taking off in a small space
- being harder to detect than many of the other UAV configurations due to small size and quiet rotors



Fig. 2. Drone – Quadrotor (DJI Mavic Pro Platinum) [16].

2. Hexacopter

This type has six propellers which are arranged in a circular shape above the main body of the hexacopter. For main body, it often carries a camera and features two legs shaped like skis (Fig. 3). These skis-like shape allow the flying device to be stable when it lands. Moreover, the six propellers (i.e., forming as rotating fan-like structure) give this craft more maneuverability and flying power than a quadcopter [14].



Fig. 3. Drone – Hexacopter (Hobbypower DIY F550 Hexacopter Frame Kit) [17].

3. Octocopter

This type contains more rotors than a hexacopter. It has eight fully functioning propellers; these are powered by eight motors (Fig. 4). Thus, octocopter has more flying capability than the previous two (quadcopters and hexacopters). The benefits of quadcopters and hexacopters are considered and combined for creating octocopter design platform where the flying speed, maneuverability and uplift power are the key components. The advantages obtained from this type are mentioned as [14];

- very stable during flying
- high quality of the results



Fig. 4. Drone – Octocopter (Spreading Wings S1000) [18].

2.1.2. Fixed-wing type

This type can carry larger loads for longer distances using less power. The key concept of this design is about “decreasing in costs and increasing in efficiency”. However, the downside to this platform is the requirement for a runway during landing or take-off precisely. This type needs to be controlled with a constant forward motion where the way it reacts (i.e., hover) is not similar to a rotary type; a fixed-wing type has a bigger size and requires more space. These issues decrease the manoeuvrability of the UAV [19-23]. Figure 5 presents the shape and design of a fixed-wing type drone that is available in the market.

Moreover, in order to resolve the aforementioned issues, developing a fixed wing aircraft with the ability to take off vertically and transition to horizontal flight has been introduced. This type of fixed-wing aircraft has vertical take-off and landing (VTOL) technology [24].



Fig. 5. Drone – Fixed wing (Ai450 v2.5 ER) [25].

2.1.3. Combined-wing type

After adding the benefits obtained from the existing rotary- and fixed-wing drones, a unique type of drone called “combined-wing type” has been presented. As a combination it provides the stability and manoeuvrability of a rotary-wing drone with the long flight range of a fixed-wing drone. Furthermore, no runway or additional equipment is required for take-off [26, 27]. These three types of drones have been applied to the proper applications where their advantages and disadvantages are used as the key addressed issues.

Moreover, to improve their flying performance, the different power sources should be taken into considerations.

2.2. UAV Power Sources

One of the main considerations with the UAV design is regard to its power source. Since the UAV must supply its motor when flying or hovering, some types of energy providing devices are needed. The power sources available in the market can be categorized into two types: Generator type and energy storage type. The generators produce the required power on the fly, which include solar power, fuel cells (FCs), and combustion engines. On the other hand, the energy storage such as batteries only transfer the stored energy to the UAV and must be recharged after use.

Diesel combustion engine can provide a robust and very high energy density due to the nature of the fuel use. However, the structures are bulky and heavy and relatively complex. Recent applications of combustion engine are still limited to the fixed wing drone. The noise from the engine can also be undesirable.

The solar power source can extend the flight time if a large area of solar panel can be installed on the drone. The solar power is normally used with the fixed-wing type from the space requirement but can also be used as a secondary source in a hybrid with battery powered rotary UAVs. Its disadvantages lie in the dependence of the sunlight, and the large surface area which make it not be suitable for indoor application of UAVs.

The FCs generate power using hydrogen as fuel and air as an oxidizer in its electrochemical reaction. The cells require flows of the fuel and oxidizer to produce electricity and water as the by product. Proton-exchange membrane (PEM) type FCs are used in drone application due to high power density and peak power delivery. Still, the overall size including the hydrogen tank can be large on the limited space of the UAV. Also, the technology is relatively expensive compared to other power sources.

In general, the generator type sources have the advantage of the longer expected flight time due to its high energy density. However, the energy storage type power source is generally smaller in size and require less maintenance. For small-sized rotary UAVs, the use of battery is much more common despite its limited flight time per charge of the battery. The common choices of battery for most UAVs in the market now are Lithium Polymer (Li-Po) and Lithium Ion (Li-ion). The Li-ion

batteries can deliver higher energy and power density at a lower cost than Li-Po. Li-Po battery has a slightly less power density than Li-ion, but it might be favorable in some design because of the thinner profile of the cells. Other types of available batteries, such as Pb-acid, NiMH, NiCad, Li-air are reviewed in [20].

As the UAV are relying on the limited battery life, manufacturers usually include Battery Management System (BMS) to constantly measure the status of the battery and inform the user for any require replacement or maintenance.

2.3. Endless Flyer

Normally, the endless flyer contains two main functions. For the first function is about “positioning the UAV into the center of the landing platform”, and the second one is about “the battery swapping mechanism” [28-31].

Method: The UAV is asked to fly and land on a platform, and it is adjusted precisely to match the target position for initiating the battery swapping mechanism. After completing all of the initiation activities, the battery will be swapped and charged with fully-charging mode.

Discussion: This approach is quite interesting and good enough for battery swapping activity. Since it focuses on how to optimize landing position before swapping battery. The positioning system of the Endless Flyer uses a set of sweeping arms to rearrange and align the drone before attempting battery swap. One drawback of the method is the risk of damaging the drone’s leg during the sweeping action. If the sweeping force is too strong, the drone can be dragged and bent at the legs.

2.4. Wired/Wireless Energy Supplies

The functions applied for this design will be briefly explained in the “Method” section, in which the disadvantages found during flying activity will be mentioned at the “Discussion” area.

Method: This design provides automatic charging voltage and current adjustment via wireless message transmission from a smart charger. The voltage and current of the smart battery charging can be adjusted according to the different ambient temperatures to provide safe operation. Additionally, the current battery status and warning messages can be sent via wireless message transmission to the smartphone [32, 33].

Discussion: However, in the actual scenario, wireless power supplies might produce obstacles while transferring the power in the flying state. The UAV might not be able to reach the wireless power sources area to recharge the power supply. Although many studies have explored wireless supply methods, such as electrodynamic induction, electrostatic induction, or electromagnetic radiation, none is efficient enough, large amounts of losses occur, and large and expensive devices are often needed. Although the power supply system can allow UAV to remain in the air continuously, but permanent flying might

cause the heating problems on the motor or other onboard circuits. In the end, the UAV has to be landed on an area to cool down the system temperature.

2.5. UAV Recharge Platforms

The key components of this platform will be explained and discussed.

Method: Using a ground platform to supply energy is another solution that allows UAVs to fly continuously. When the UAV detects that its battery is running out, it returns to the platform and recharges/exchanges its battery automatically. Several institutions have already developed prototype battery recharge platforms [34, 35].

Discussion: With a recharging system, waiting for a battery to fully recharge is time-consuming compared to swapping the battery with a new battery. For aerial surveillance in particular, real-time information may be the most important factor. To meet this demand, a large number of the drone may be required to fulfill the continuous flying, which could be spatially inappropriate and expensive.

2.6. Factor of Safety for Structural Design

Factors of safety (FoS) is a term describing the load carrying capacity of a system beyond the expected or actual loads. Essentially, the factor of safety is how much stronger the system is than it usually needs to be for an intended load. Safety factors are often calculated using detailed analysis because comprehensive testing is impractical on many projects, such as bridges and buildings, but the structure’s ability to carry load must be determined to a reasonable accuracy. The formula of the factor of safety can be shown in Eq. (1).

In which FoS is a safety factor, Y_s is yield strength, and D_s is designed stress/actual stress. The value of safety factor may vary based on the criteria of the machine/structure. Table 1 and 2 will present about the factors of safety information.

$$\text{FoS} = \frac{Y_s}{D_s} \quad (1)$$

Table 1. Factor of safety based on the type of loads [36].

No.	FoS	Type of Loads
1	1.25 - 2	Static Load
2	2 - 3	Dynamic Load
3	3 - 4.5	Shock Load

Table 2. Factor of safety suggested in design [37].

No.	FoS	Parameter/Uncertainty Condition
1	1.25 - 1.5	Controlled conditions and working stress can be determined with certainty.
2	1.5 - 2.0	Known material, fixed load and stress environmental conditions can be determined easily
3	2.0 - 2.5	Materials that operate on an average basis with limits on known loads.
4	2.5 - 3.0	Known materials without undergoing the test. Under load and average stress conditions.
5	3.0 - 4.5	Uncertain load, stress and environmental conditions.
6	Repetitive Load: the numbers suggested above can be used but with the endurance limit as 'significant strength'	
7	Impact Load: the numbers suggested above can be used but impact factors must be included	
8	Brittle material: the numbers suggested above are multiplied by two for brittle material, where the safety factor is calculated against ultimate strength	

2.7. Finite Element Analysis

The finite element method (FEM) is a numerical method for solving problems of engineering and mathematical physics. FEA is a computerized method for predicting how a product reacts to real-world forces, fluid flow, heat, vibration, and other physical effects [38]. FEA, moreover, helps to predict the behavior of products affected by many physical effects, including:

- Mechanical vibration
- Fatigue
- Motion
- Fluid flow
- Mechanical stress
- Heat transfer

A variety of specializations under the umbrella of the mechanical engineering discipline (such as aeronautical, biomechanical, and automotive industries) commonly use integrated FEM in design and development of their products. In a structural simulation, FEM helps tremendously in producing stiffness and strength visualizations and also in minimizing weight, materials, and costs [39].

FEM allows detailed visualization of where structures bend or twist and indicates the distribution of stresses and displacements. The software part provides a wide range of simulation options for controlling the complexity of both modelling and analysis of a system. Simply saying that, the software can show whether a product will break, wear out, or work, and it is used to predict what is going to happen

when the specific structure of material is applied in the design of a new product.

The key points, for supporting product design and development (PDD), FEM allows entire designs to be constructed, refined, and optimized before the design is manufactured.

In this research, the main analysis used is *von-Mises stress* in SolidWorks platform. The von-Mises yield criterion (in 1913) suggests that the yielding of materials begins when the second deviatoric stress invariant J_2 reaches a critical value [40]. It is a part of plasticity theory that is suitable for ductile materials, such as metals.

3. Methodology

Five main topics will be presented in this section: overall of the research, research background, conceptual design, system level design, and detailed design.

3.1. Research Outline

This topic is about the overall activities required for accomplishing the research objective where the main tasks are performed in sequences.

1. Calculating drone landing error to find the maximum error angles (acceptable range) at each leg, and shock absorption stroke.
2. Designing the landing platform and clamping mechanism based on the error calculation. A conical shape (a funnel) will be applied as the key concept.
3. Designing the gripper for loading and unloading battery where the shape and size of socket are the key components.
4. Creating the guideline of a customized socket design mounted to the mainframe of a drone for quickly releasing battery.
5. Preparing the design of battery storage ring to charge the batteries in a compact space.
6. Designing appropriate working sequences for battery exchange.

Step 1: the drone should descent and be landed completely on the designed platform within the error range where all legs will move slowly down to the funnel-shaped platform.

Step 2: the clamping mechanism locks the battery compartment tightly.

Step 3: the gripper starts to swap the battery.

Step 4: the drone is ready to take off.

7. Simulating two considerations for making sure that the designed system can support and prevent damage during landing.

- Kinematics of gripper
- Effect of landing load on the platform (static)

The details of these tasks will be presented and discussed in following sections.

3.2. Research Concept and Addressed Issues

Presented in this section are about the main concept and issues which are addressed before generating the drafted design of the proposed model of Drone's power station.

3.2.1. Small power station concept

This is used to solve the flight time problem from the drone where the idea of a new design has been started by raising the question about 'how to generate continuous flying from the drone to satisfy the services regarding drone usages in industrial activities'. In order to identify how to apply this small power station system to the service areas with a clearer view, two scenarios of the vehicle routing problems with drones (VRPD) platform are shown Fig. 6 and 7 respectively.

In *scenario 1*, the power station was placed in within the services areas to handle the drone activities on that spot. This scenario will be implemented in the service area that is very far from each cluster and exceed the drone's flight time in one single flying cycle. Therefore, the drone will be moved from the first power station to another power station to fulfill the requirement.

In *scenario 2*, the power station will be handled on the specific area that is needed continuous flying or endless flying from the drone. The power station will provide the power supply to make sure the drone can perform a completed service for the activities.

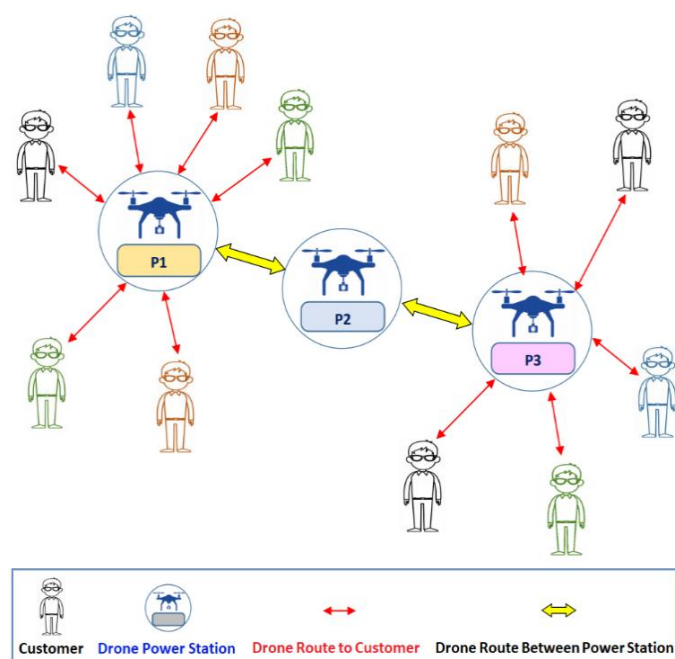

Fig. 6. Illustration of the drone's power station service for scenario 1.

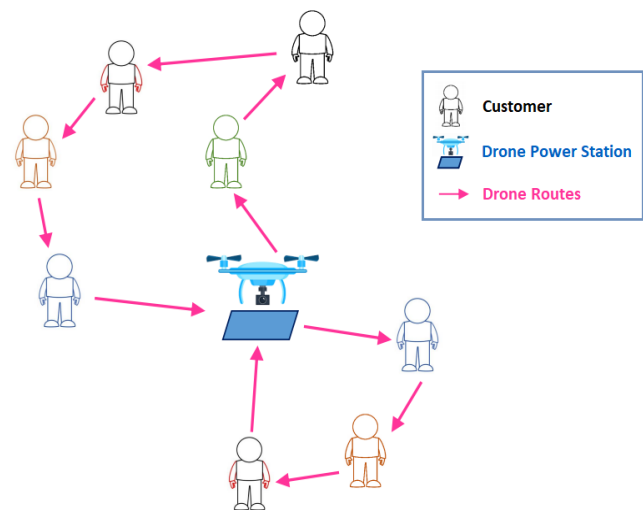

Fig. 7. Illustration of the drone's power station services for scenario 2.

3.2.2. Addressed issues







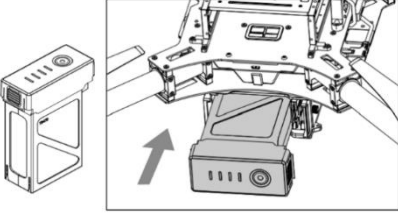

To accomplish the results of this research, the following issues are addressed to approach the case study:

1. *Size of the drone*: type of the drone that is used or demonstrating the proposed design is "DJI Matrice-100" where the diagonal wheelbase dimension is 650 mm, and the weight is 2.4 kg approximately (with TB47D battery) without payload.
2. *The landing location*: the platform for landing will be adjusted according to the dimension of drone and the swapping battery activity, in which "the error of the landing point" is the key concept of the design stage.
3. *Size of the battery*: "TB47D battery" (weight = 0.6 kg), it will be also considered for designing the battery gripper and charging storage to generate the automatic battery swapping mechanism.
4. *System mechanism*: two main functions are listed, "positioning the drone location" into the desired area, and "battery changing mechanism" for loading and unloading the battery from the drone and battery storage.

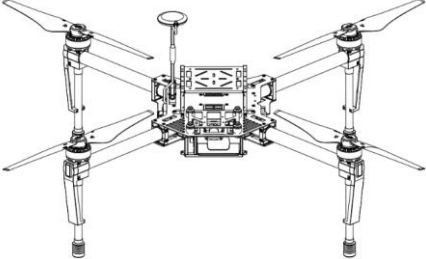
In order to create a new design, product design and development (PDD) concept is widely applied for developing a new product where five main stages are required: *concept development*, *system-level design*, *detailed design*, *testing and refinement*, and *production ramp-up* [41].

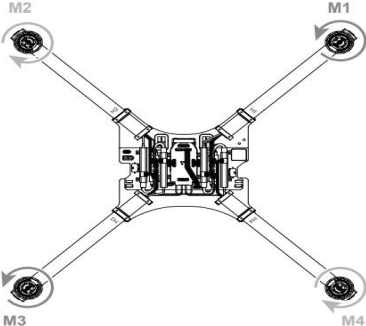
In this research, for the area of interest, the first three stages were applied where a new design of the automation system of battery exchange platform was introduced as an alternative channel for supporting the continuous and endless flying cycle of the drone. The expected results of this research, the obtained design could provide some good points for supporting the industrial-scale platform, transportation, logistics and supply chain management, or inventory system where the drone is asked for the main device to accomplish their activities.

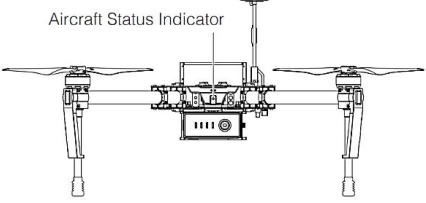
Table 3. Graphical images and real images of “DJI Matrice 100 drone”.

Graphical image [45]	Real image [44, 46, 47]	Description
		Battery and socket area
		Drone in isometric view
		Drone and 4 legs from top view
		Drone from front view

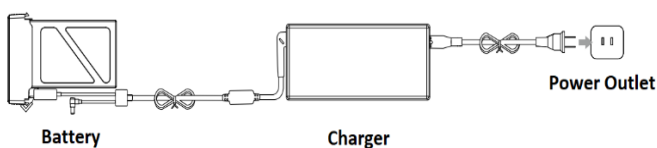

Fig. 11. The way to charge battery [45].

3.3.2. Triple “F” concept (Form/Fit/Function)

After obtaining the information about the components and sub-components of the specified drone, the concept called ‘triple F’ is applied. The triple F rules (FFF) used to conduct the design criteria for this research paper, the phrase referred to form, fit, and function. It is widely used in terms of identifying the characteristics of system design/single component in CAD process.

The description of the modification criteria of this system that must be achieved in the design are:

1. *Form*: The form of this system refers to the shape, size, dimensions, mass, and weight of the drone that is being used in this research. Mainly all of the parts and assembly will be considered the size of the drone’s battery TB47D (weight = 0.6 kg) and the drone’s size with a diagonal wheelbase distance 650mm. For the details of the drone’s specification can be seen in the DJI Matrice 100 user manual [45].
2. *Fit*: The fit in this system will be considered all of the drone’s components also. The clamping, fixtures, and landing platform will be designed according to the shape of the battery socket and drone’s leg, so it will give the smooth process in doing the main activities for the system.
3. *Function*: The system will be used to perform the battery swapping and drone’s positioning. Other

parts and assembly also need to support all of these functions such as a mixed screw, arm actuation, and some of the mechanical parts.

3.4. System Level Design

In order to construct the mainframe of the proposed design model which is the “loading system” for supporting drone, all compartments are classified into chunks or groups as “system level design” structure (Fig. 12).

Constructing this structure can help design engineer to minimize time and cost spent for maintaining, assembly and disassembly purposes. The proposed power station system can be classified into 4 main groups: *landing platform*, *clamber/fixture mechanism*, *batteries magazine*, and *battery gripper*. The material selection and the specific detail of each component will be explained in the next section, detailed design phase.

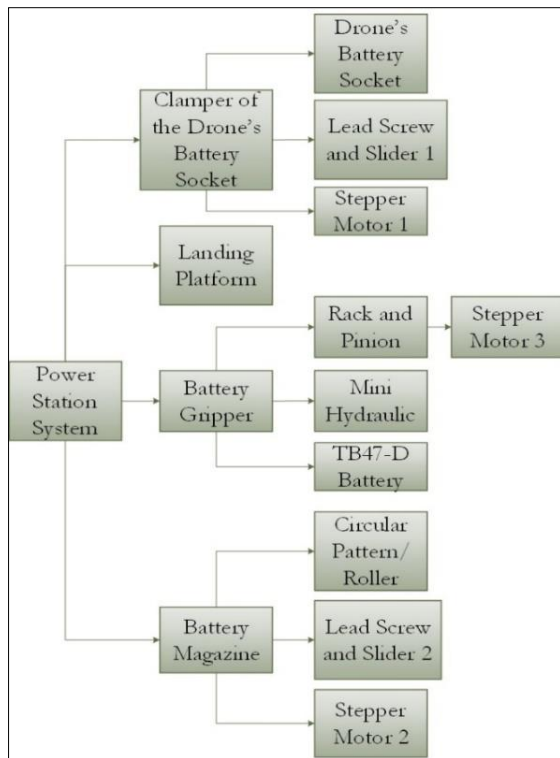

Fig. 12. System level design of the power station.

3.5. Detailed Design

3.5.1. Clamper design

The process of replacing or swapping the battery is the main activity in this system, to optimize that process, the object or the drone must be formed in a fixed position. Clamping or fixing the object is one of the most important steps to conduct a battery swapping process. In order to perform a good clamping or fixing process for the drone, the landing platform should be designed first to check whether or not the drone will land at the initial location within the area of interest. The normal landed state of DJI M100 drone is shown in Fig. 13. The dashed lines

represent enveloping boxes and circles proportion to the size of rotors, body, and the whole drone, respectively. The legs are concentric with the rotors.

In practice, the error was found during landing activity, thus, the dimension of the landing platform was designed according to the “center-error” assumption of the drone’s legs when landed in a specific spot. This error occurred during landing was 100 mm approximately from the center of each leg. The detail of the error and the proposed landing platform are illustrated in Fig. 14 and 15, respectively. The cone shape on that landing platform was designed to let the drone falls by natural gravity into the center of the desired location. It could help the clamping process run smoothly and efficiently, for the detail of the design can be seen in Fig. 16.

After constructing the landing platform, the next step is designing the clamping mechanism for the drone after landing. The clamping mechanism was designed and focused on fixing the drone while doing the swapping battery process to prevent any movement in the aircraft principal axes (Fig. 17).

The proposed design of the clamping mechanism is shown in Fig. 18, it used screwdriver concept to adjust the fixture position to clamps the drone. The detail of each part from this subsystem are presented in the Table 4.

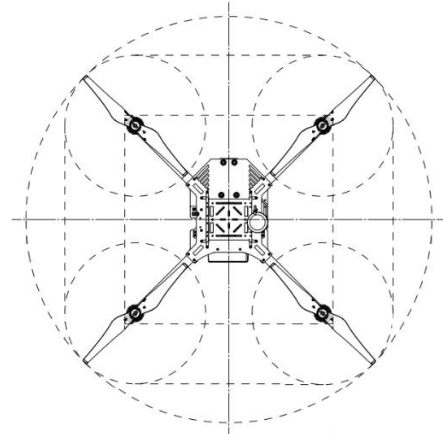

Fig. 13. DJI M100 proportion of parts in normal landed state. [45].

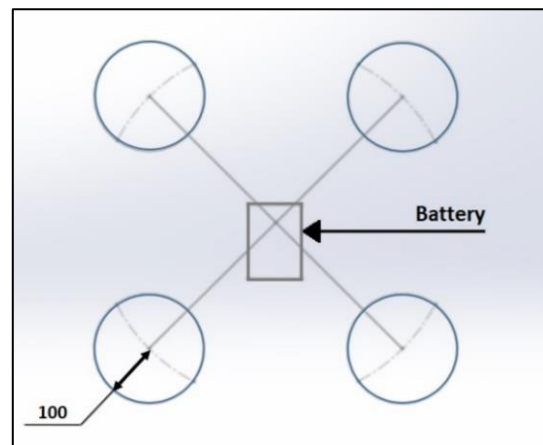

Fig. 14. Legs landing error and the constraint.

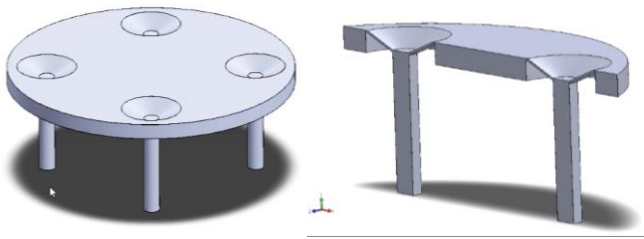

Fig. 15. Proposed design of the landing platform.

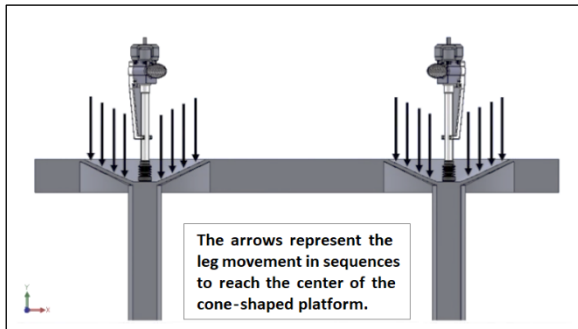

Fig. 16. Illustration of drone's legs position while landing.

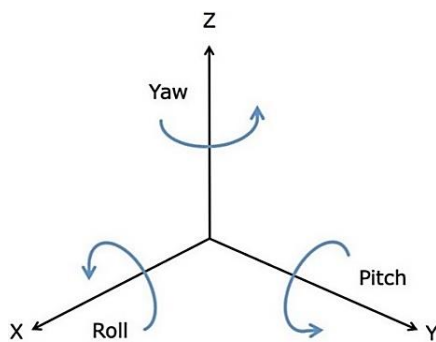

Fig. 17. Principal axes of an aircraft.

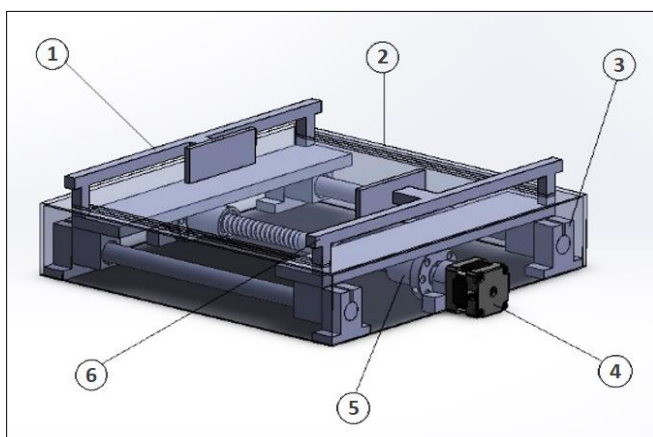
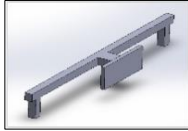
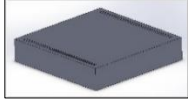
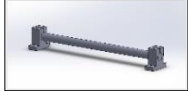
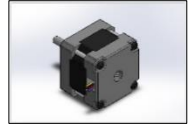

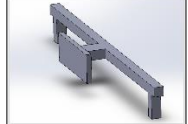

Fig. 18. Assembly of the clamping mechanism.

Table 4. Details of each component for creating clamping mechanism.

Part no.	Part name	Detail picture	Description
1	Left fixture		To clamp the drone from the left side
2	Surface cover		To cover-up the mechanical parts
3	Set of sliders		Rail for the fixture while moving
4	Stepper motor		The actuator for driving the screwdriver
5	Set of mixed screw		To move left and right fixtures
6	Right fixture		To clamp the drone from the right side

3.5.2. Battery gripper

The robotic arm or gripper is widely used in terms of the automation process for material handling [48, 49]. One of the famous robotic arms is the claw machine, it is often used the linkage system to convert the rotational torque into linear motion of the claw [50, 51]. The battery gripper is one of the most important subsystems to design, the gripper used to load and unload the battery while doing the swapping battery process.

The design of this gripper refers to the size of the drone's battery TB47D. The proposed design of the battery gripper can be seen in Fig. 19, and the detail of each part shown in Table 5.

The design of this gripper refers to the size of the drone's battery TB47D. It will be considering the contact surface of the gripper and the battery while performing the swapping process, as shown in Fig. 20. This gripper will be driven by a mini hydraulic actuator and available to move in 1 DOF with a rack and pinion mechanism. The contact surface distance is approximately 95 mm.

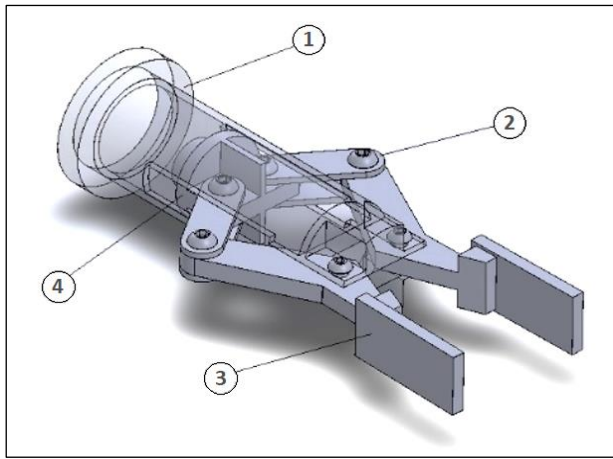
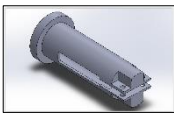
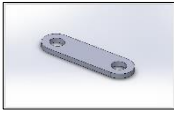

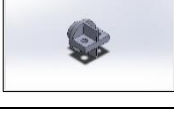

Fig. 19. Design of the battery gripper.

Table 5. Details of each compartment of the battery gripper.

Part no.	Part name	Detail picture	Description
1	Main tube		The mainframe of the battery gripper
2	Arm gripper		The connector of the main gripper
3	Main gripper		The key part for the battery gripper
4	Actuator couple		The connector from the actuator to the gripper

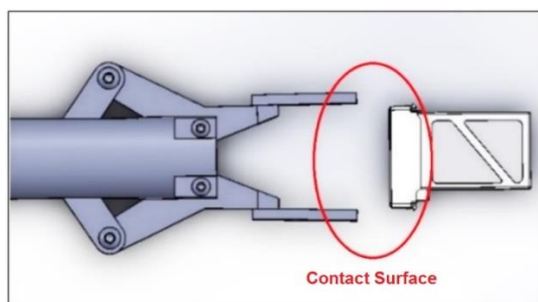

Fig. 20. Gripper and battery contact surface.

3.5.3. Battery storage/recharging system

The design of battery storage or charging storage for the drone is referred from the size of TB47D battery, it used a circular pattern to get an efficient workflow while doing the battery swapping process. The detailed design of battery charging storage can be seen Fig. 21.

The number of battery slot was designed by calculating the drone flight time and charging time of the battery. The drone can fly up to 30 minutes by using one battery without any payload on it, and each battery will be fully charged in 120 minutes approximately. Based on that information the number of battery slots required to perform an endless flying cycle is 6 slots including for the safety condition. One slot on this battery storage will be reserved for the empty battery that has been used before by the drone.

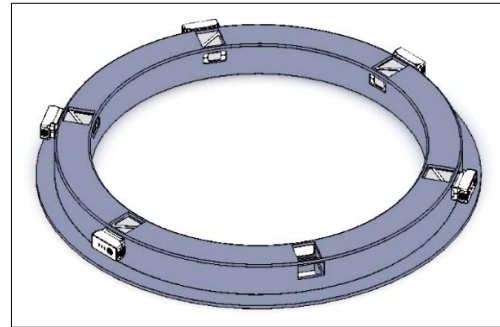

Fig. 21. Battery storage/charging system with ring-shaped design.

4. Design Analysis (Refinement and Testing)

From the existing design of the drone with Matrice 100 series, on each of the four-landing gear ground-contact points, there are pneumatic shock absorbing landing gear “feet” as shown in Fig. 22. When the drone is controlled to come down for a landing, it gently settles down on a pneumatic cushion of air which is located in each of the 4 ground contact points. While this feature is not going to salvage the drone from a catastrophic landing (i.e., it might cause a sudden terrible disaster), it dissipates the “hop and bounce” effect sometimes found. It should make a difference in reducing stress on the structure as a whole. However, with the weight of the drone itself, the load applied on the floor or platform should be considered for helping drone to increase the stability and reliability during landing. For assisting the ways to create clean and clear design of the power station platform proposed in this research, analyzing about the force applied on the area of interest is very interesting and necessary when the system is controlled automatically by computer.

In practice, when the error or emergency event is suddenly happened, no one can get to that place and fix the problem properly. After identifying the components and sub-components of the desired platform model, the load applied onto the loading platform will be studied by using ‘finite element analysis (FEA) for static load. The main point of the FEA in SolidWorks is the von-Mises stress analysis since the von-Mises stress is used to predict yielding of materials under any loading condition from results of simple uniaxial tensile tests. In 1924, Hencky offered a physical interpretation of von-Mises criterion suggesting that yielding begins when the elastic energy of distortion reaches a critical value [52]. For this reason, the

von-Mises criterion is also known as the maximum distortion strain energy criterion. Applying FEA can assist the design engineer to check whether or not the created 3D models can support the load distributed on the landing platform properly.

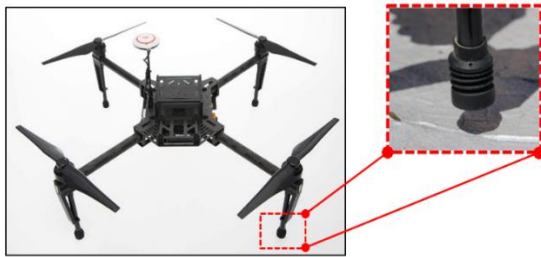

Fig. 22. The pneumatic shock absorbing landing gear 'feet'.

4.1. FEA for Landing Platform

Actually, it would be better to apply the compact software for calculating the entire story of force distribution, air flow, and stress or strain analysis on the object of interest with random parameters. However, in product design and development (PDD), in order to reveal and extract hidden issues from the target users, everything should be established from "conceptual design" where the users' viewpoint should be replaced by manual free-hand sketch, artworks, drafted ideas or 2D-image platform. The designers have played as the important roles for representing the characteristics of users and manufacturers. Making easy-to-access calculation platform with the proper assumptions based on what will be happened next could reduce time spent for trail-and-error selecting parameters applied as the inputs for the compact simulation or software.

Illustrated in Fig. 23 and 24 are the conditions for supporting the calculation platform. These are obtained from brainstorming, collaborating, and turning ideas into action to identify stress analysis on the structure.

The key point of this part is shown through the way to archive the maximum stress and displacement of the design. After obtaining the trends of the expected results, these guidelines were applied into "FEA analysis" platform.

For Fig. 23, FEA Simulation could be defined by these considerations:

Load Assumption: $7.5 \text{ kg} \times 2 \times 9.8 \text{ m/s}^2 \sim 150 \text{ N}$
(Assume 2 times of F_{total} for FEA simulation)
Distributed evenly among F_1, F_2, F_3, F_4 .

Material: ASTM A36 Steel;
Yield Strength, $S_y = 250 \text{ MPa}$
Young's modulus, $E = 200 \text{ GPa}$
Factor of safety (F_{os}) = 2

$$\text{Allowable Stress} = \frac{S_y}{F_{os}} = \frac{250}{2} = 125 \text{ MPa}$$

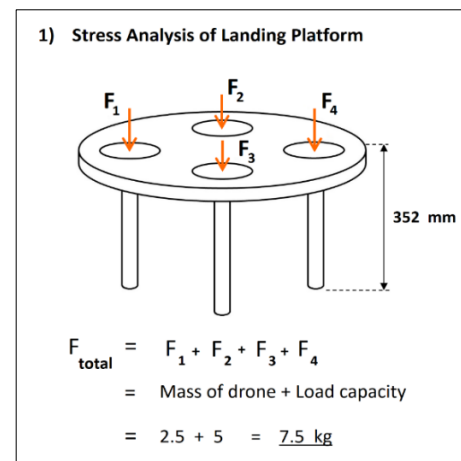

Fig. 23. The conditions for supporting manual calculation of stress analysis of landing platform.

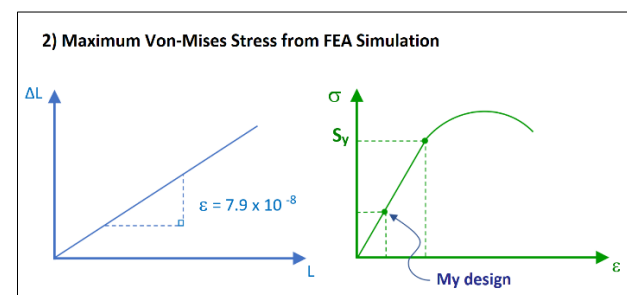

Fig. 24. (Cont.) The conditions for supporting manual calculation of stress analysis of landing platform.

For Fig. 24, the displacement or deflection of the platform's legs (ΔL) is considered as strain (ϵ) multiplied with length of leg (L_0). When the strain (ϵ) equals the stress (σ) divided by Young's modulus (E), therefore, ΔL is equal to $7.9 \times 10^{-8} \times 352 \text{ mm}$, or is as $2.78 \times 10^{-5} \text{ mm}$.

With this amount, the design of the leg might not be sensitive to load applied. Moreover, according to the allowable stress (125 MPa) calculated manually from the previous stage and the obtained value of the maximum Von-Mises stress (σ'_{max}) from FEA simulation, the platform can withstand the load without facing the risk of yielding failure; $\sigma'_{max} = 27 \text{ kPa}$ and $\sigma'_{max} < 125 \text{ MPa}$.

The load assumption to conduct the FEA analysis on the landing platform is defined according to the load that happened in the structure, detail of the load assumption can be seen in Fig. 25. The load assumption 7.5 Kg is multiplied by 2, this number came from the "Factor of Safety (FoS)" based on type of load and parameter uncertainty of Table 1 and 2. The action of the force (150 N) applied on the developed landing platform is simulated by FEA in SolidWorks application. The results of FEA of the landing platform are presented in Fig. 26 to Fig. 28; the maximum von-Mises stress is around 27,000 Pascal. That result is less than the yield strength of 250 MPa for the ASTM A36 steel used in the simulation, we can exactly say that our design is safe.

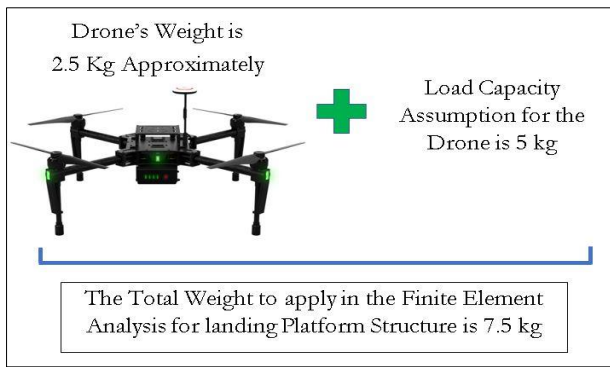

Fig. 25. Load assumption for FEA on the landing platform.

4.2. FEA for Battery Gripper

Battery gripper is a very important sub-system in the process and manufacture of this design. To determine the gripper ability and strength of this robot gripper, FEA is also applied to the design structure. The working load assumption is based on the weight of the TB47D battery, which is 0.6 kg. This value will be multiplied by the factor of safety based on Table 1 and 2 presented previously. The total mass used is 0.6 kg multiplied by 2, which is 1.2 rounded around 1.5 kg. The total force that applied in the stress analysis of battery gripper is 15N according to the load assumption of the structure. The results are shown in Fig. 29 and 31.

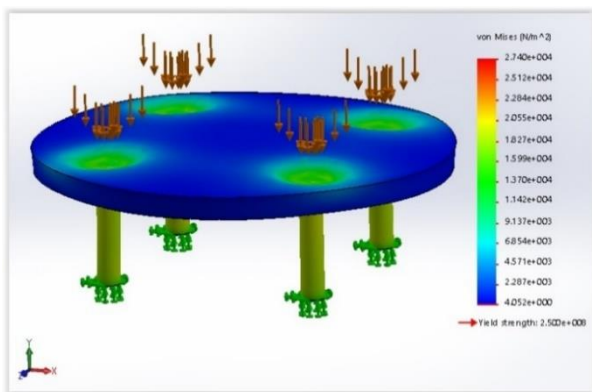

Fig. 26. Von-Mises stress of the landing platform.

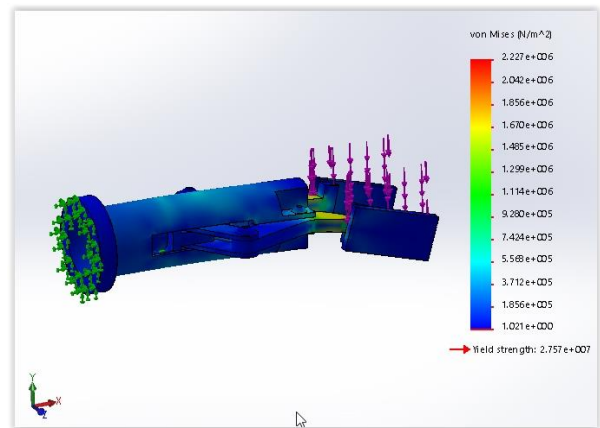

Fig. 29. Von-Mises stress of battery gripper.

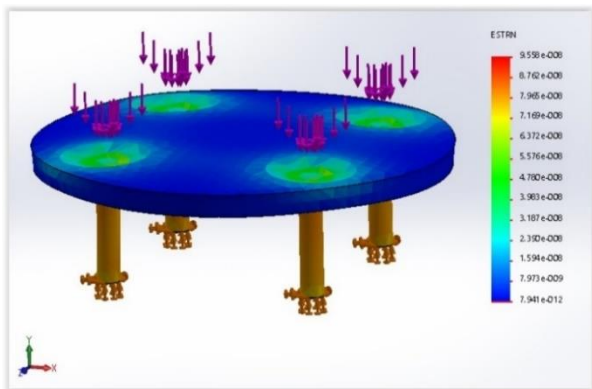

Fig. 27. Equivalent Strain of the landing platform.

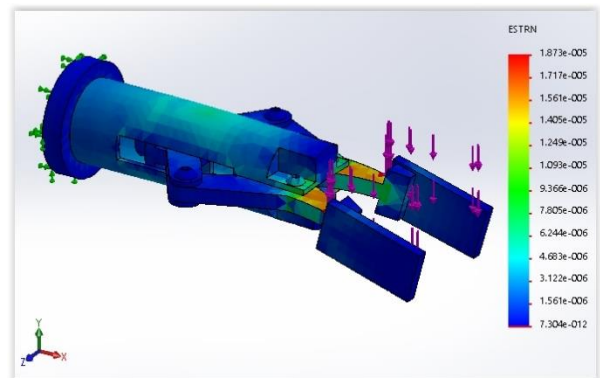

Fig. 30. Equivalent Strain of battery gripper.

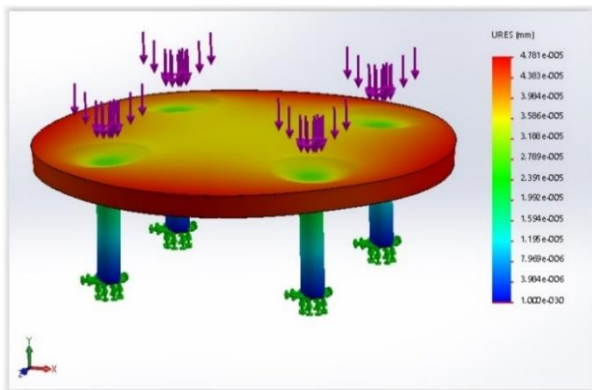

Fig. 28. Displacement of the landing platform.

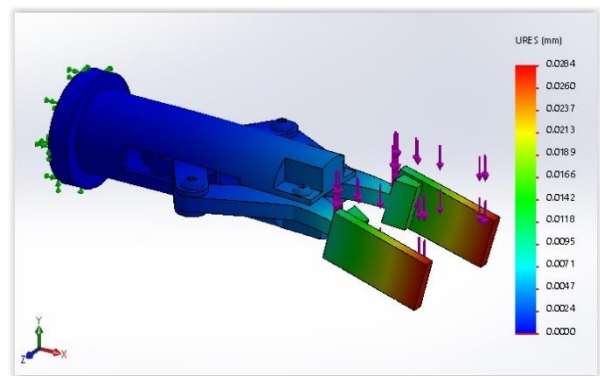

Fig. 31. Displacement result of battery gripper.

4.3. Kinematic Diagram Analysis of Battery Gripper

The key point for kinematics and mechanism calculation in this design is “battery gripper” which is represented as “sub-system” of the battery swapping platform. The battery gripper will be used to load and unload the TB47D battery from and into the UAV. The ideal position should be met with the size of the battery that is around 95 mm (Fig. 32).

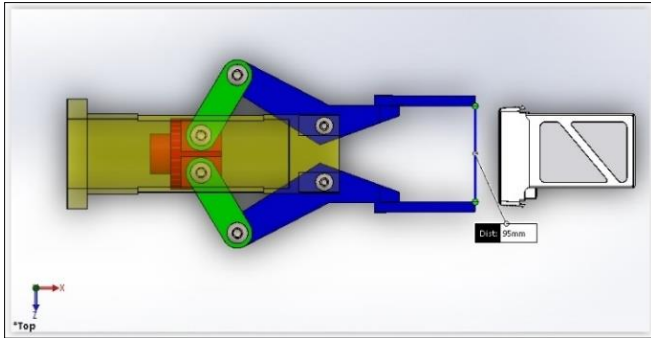

Fig. 32. The appropriate distance while gripping the battery.

Then, the kinematic diagram of the battery gripper was made. This diagram (Fig. 33) could be applied to calculate the maximum stroke of the linear actuator to reach the ideal position while gripping and releasing the battery. The calculation can be expressed in the Eq. (4) - (6) below.

$$\begin{aligned}\theta_1 &= 180^\circ - (\angle BCF + \angle DCF) \\ &= 180^\circ - \{135^\circ + (180^\circ - 164.63^\circ)\} \\ &= 29.63^\circ\end{aligned}\quad (4)$$

$$\begin{aligned}\theta_3 &= \sin^{-1} \left[\frac{L_1 \sin \theta_1 + L_2}{L_3} \right] \\ &= 57.35^\circ\end{aligned}\quad (5)$$

$$\begin{aligned}L_4 &= L_1 \cos \theta_1 + L_3 \cos \theta_3 \\ &= 124.69 \text{ mm}\end{aligned}\quad (6)$$

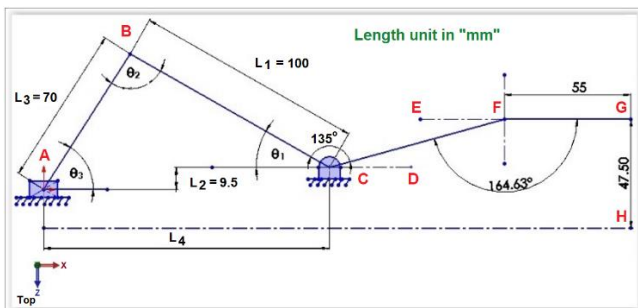

Fig. 33. Kinematic diagram of battery gripper.

5. Results and Discussions

5.1. Results from Kano Analysis

The google-online survey was applied as the key tool for launching and collecting the questionnaire results, the survey was distributed to the drone users and some people who have an engineering background. The total of respondents obtained from that survey was 52 respondents (this group are persons in the 17-45 age range). After determining the total number of each category, satisfaction index (SI) and dissatisfaction index (DI) calculated by using Eq. (2) and Eq. (3) in Section 3 - Concept. The data listed in Table 6 were considered as the no. of respondents who decided to select criteria 1/2/3 with six categories or requirement: Attractive (A), must-be (M), reverse (R), one dimensional (O), questionable (Q), and indifferent (I). Three criteria of requirement (C.R.) applied in this study are:

1. The system will work in fully automatic state or semi-automatic (C.R. 1)
2. The system will have portable location or fixed location (C.R. 2)
3. The system will have the charging storage or not have (C.R. 3)

The number listed in Table 6 could be translated in this way; C.R.1 with Attractive (A) category (the 1st column and the 1st row), twenty four target users would like to get the system of the drone that can work in fully automatic or semi-automatic mode. Containing this requirement might make the target users feel so excited since the design of the drone is “Attractive” for them. This might imply a great opportunity to launch this model to the market.

Table 6. Kano analysis attributes calculation.

Category	C.R. 1	C.R. 2	C.R. 3
A	24	20	25
O	15	10	11
I	11	17	13
M	1	1	1
R	0	1	1
Q	1	3	1
Total	52	52	52
DI	0.31	0.23	0.24
SI	0.76	0.62	0.72

Voice of customer analysis was done by using the Kano model, the satisfaction index (SI) and dissatisfaction index (DI) of each attribute were plotted into the Kano diagram (Fig. 34). According to the result of the Kano diagram, all three attributes were located around the attractive (A) curve. These results could be revealed something about “experiences and backgrounds” of the target customers. The majority answers were fallen into the group of respondents who translated the meaning of

“Drone or UAV” with their own perceptions influenced from advertisements, forums or experts where the key point of this device is “smart and hard to be controlled by manual mode”. Whereas, the ones who were from smaller group of respondents, expressed the specific requirements for improving UAV performance according to their own practical observations and tests. Therefore, the obtained results were quite strange since “the fully automatic attribute (C.R. 1)” and “the battery charging attribute (C.R. 3)”, actually, should be placed in the “must-be curve”; since these two conditions are the fundamental functions required in UAV design. Fortunately, in terms of customer orientation, this could imply a bright direction to a new design of “Drone or UAV” in this era, since “the attractive curve” indicates the customer’s excitement to the offered attributes.

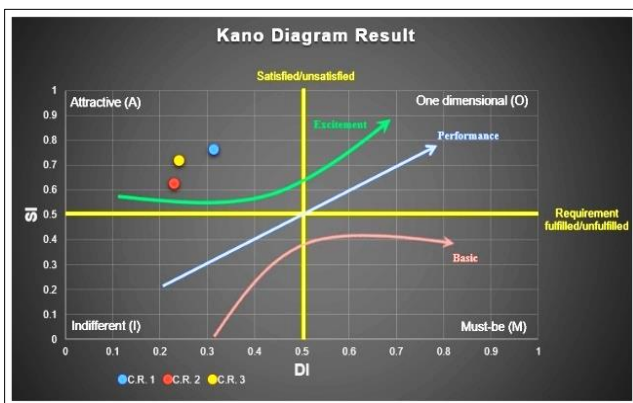

Fig. 34. Kano diagram of the customer analysis result.

However, the customer’s perceptions and opinions were subjective, according to the PDD concept, the discussion among designers were required before making final decision. In the end, the decision of designing the attributes returns to the engineering drafter and consideration of the factors that influence during the manufacturing process. The final result of the subsystem design was mentioned as the assembling activity in which one fully power station system was obtained (Fig. 35).

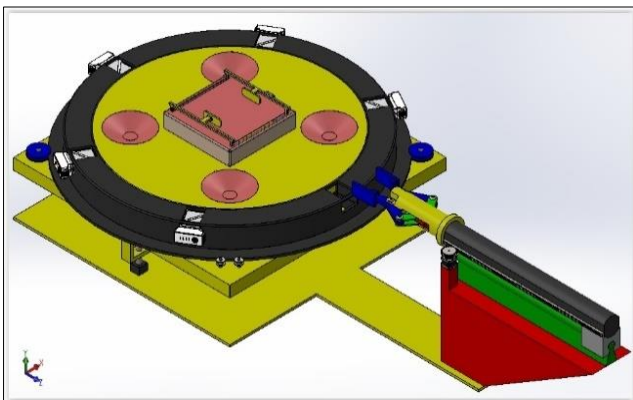

Fig. 35. Full system assembly of the drone power station.

5.2. Workflow Diagram

The workflow (Fig. 36) of this system starts when the drone is landing to the platform and finishes until the drone flies again. Two main functions in this system are in step 2 and step 3 which are drone positioning by using the fixture (Fig. 37) and battery swapping process. The charging storage is implemented by a circular motion and a linear motion to get an efficient workflow. The circular motion is used to rotate the charging storage to ensure the battery and charging socket stay in the execution position of the gripper. The linear motion in Y-axis used to give a path for the gripper while loading and unloading the battery from and to the drone.

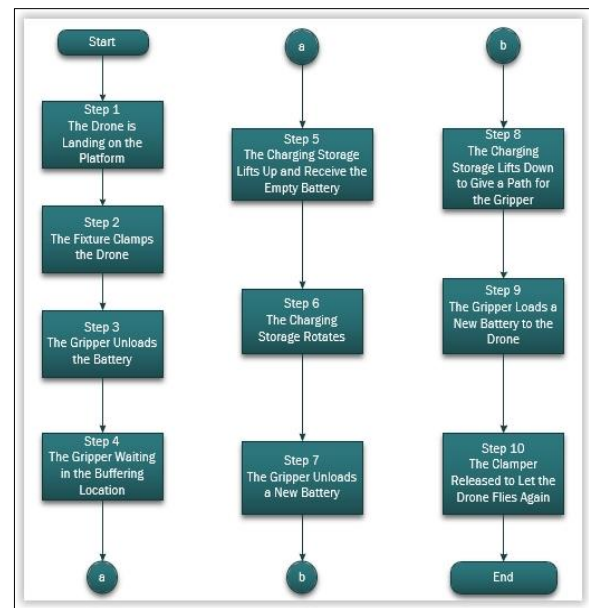

Fig. 36. System workflow for the automation process.

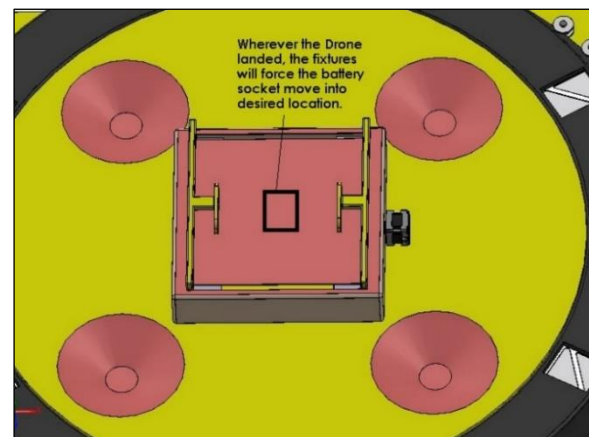

Fig. 37. Drone’s positioning by the fixtures and cone shape platform.

5.3. Processes

For the processes required to support this proposed research, 3D virtual model of each step is presented via Table 7 (Part 1) and 8 (Part 2).

Table 7. Processes required for a new proposed platform of “landing position” – Part 1.

Steps	Virtual model	Description
1		The drone is landing.
2		The drone is clamped by the fixture.
3		The gripper unloads the battery from the drone.
4		The gripper is stated in waiting mode and it is in the buffering location.

Table 8. Processes required for a new proposed platform of “power station - charging storage” - Part 2.

Steps	Virtual model	Description
1		The charging storage lifts to get the empty battery.
2		Charging storage rotates to let the gripper unload the new battery.
3		The gripper unloads a new battery from the charging storage.
4		Charging storage lifts down to open the path for loading a new battery to the drone (Preparation stage).
5		The gripper is loading a new battery to the drone.

For “Part 1”, the process starts from making the realistic situation to land the drone at the target area (Step 1). Then, the designed mechanism for fixing the drone in place is active (Step 2). Gripping device starts to remove the empty battery out of the drone (Step 3). The last step of this part, drone is waiting for reinstalling the fully-charged battery in Step 4.

For “Part 2”, this part focusses on “how to charge the battery and move the battery properly by using the developed design of power station”. This part starts from getting the empty battery out (Step 1) by charging storage. When the charging storage rotates, the gripper is ready for unloading a new battery (Step 2). Then, a new battery is removed from the charging storage by the gripper (Step 3). The entire platform of charging storage is asked to lift down slowly to provide some spaces for loading a new battery to the drone at the battery socket area (Step 4). In Step 5, the gripper starts to load a new battery to the drone. Once the battery is completely inserted in place, the clamp unlocks automatically and the drone is ready to fly.

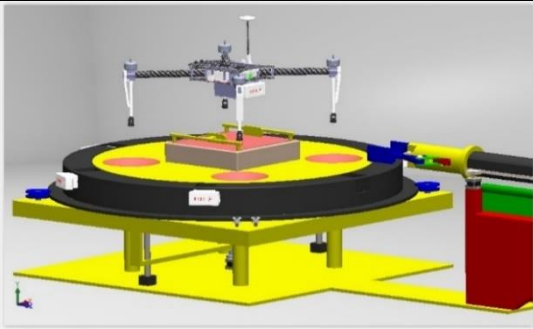
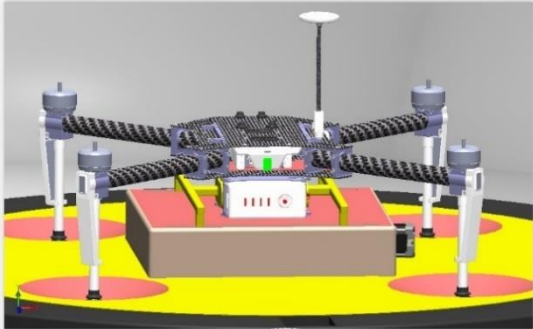
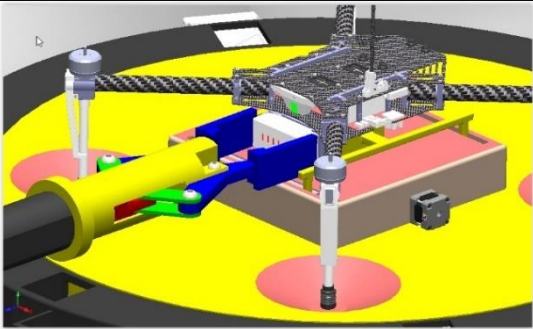
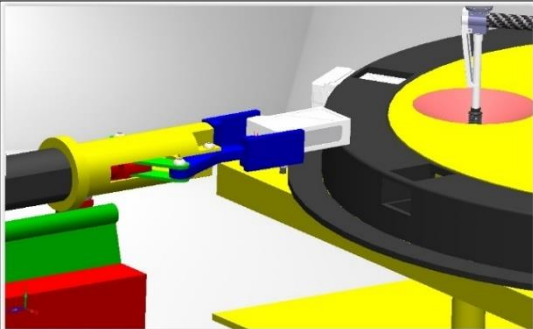
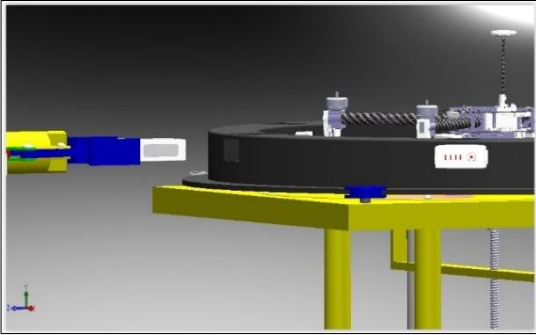
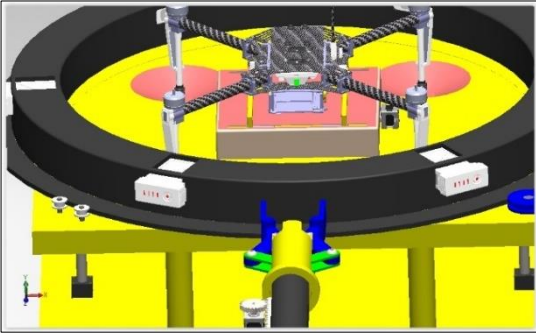
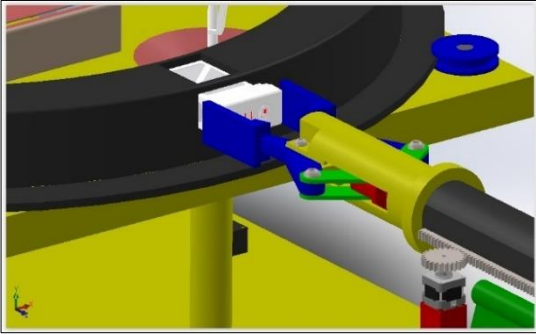
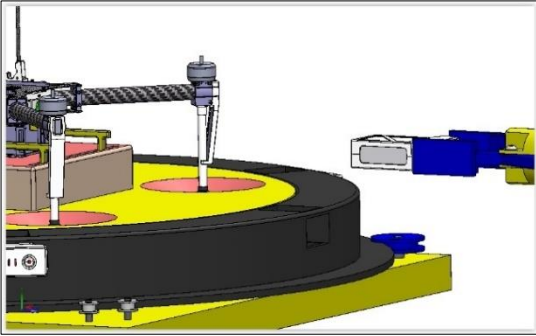
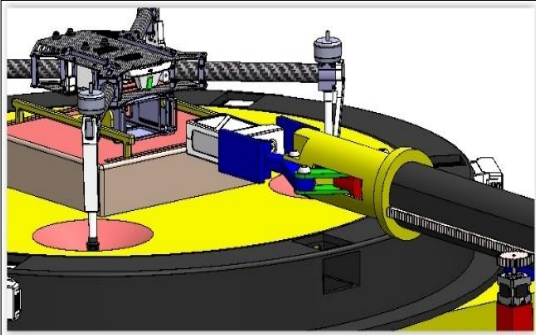
5.4. Discussions

After testing the load applied on the platform and the gripper by FEA, the researchers were curious to know what would happen next about ‘the number of life cycles of the proposed design. Therefore, the simulated results and the related works were used to answer this.

1. For the landing platform

The landing platform is made of ASTM A36 steel with a fatigue strength of roughly 200 MPa [53]. With the repeating maximum compression load of 2.7×10^{-2} MPa, it is safe to say that the landing platform can last more than ten million cycles.

2. For the gripper

The gripper is made of 1060 aluminum alloy which has a fatigue strength of about 21 MPa [54]. With the repeated loading of 2.2 MPa based on simulation, the gripper should be able to last more than a million cycle under this load.

Since the battery exchange station is operated every 30 minutes of flying time, that means 2 cycles of operation per hour; therefore, the landing platform and the gripper should last safely more than ten years (safety factor of 5) without fatigue or static failures.

6. Conclusion

The customer analysis attributes that have been offered are successfully fulfilled in the CAD model construction where the load distributed from the drone to the conceptual-designed platform during landing are virtually tested by finite element analysis (FEA) and kinematic calculation to make sure the structure was designed in the safety boundary.

Finite element analysis (FEA) is carried out in the two components sub-system. First is the landing platform we used the material ASTM A36 Steel with a yield strength of 250 MPa, and second is a battery gripper we used the material Aluminum 1060 Alloy with a yield strength of 27 MPa. The maximum von-Mises stress on the landing platform was 2.7×10^{-2} MPa and the resulting displacement was not more than 4.78×10^{-5} mm. For the battery gripper the maximum von-Mises stress is 2.2 MPa with a displacement not exceeding 0.03 mm. From all those values, it can be concluded that the design that we have done is safe. The maximum von-Mises stress is not exceeded the yield strength of the material and the displacement that occurs is not significant.

In the battery gripper, kinematics analysis is also carried out to determine the maximum stroke on the linear actuator. From the calculation results that we obtained, the ideal position to grips the battery is when the linear coupler and linkage (θ_3) made the angle at 57 degrees (Fig. 37). From the calculations above, it can also be concluded that the maximum angle of the linear actuator (θ_3) must be between 0 and 57 degrees when the gripper operates.

Performing virtual simulation can help the design engineer eliminate the possible errors which might be occurred in the manufacturing stage. The proposed power station platform can support the drone to easily position its legs in place, and with the simulation results, the developed platform allowed the drone to perform a continuous flying by quickly swapping the empty battery with a fully charged one where the constant pulling/pushing force was applied automatically.

Since the aim of this research is to introduce a concept development of the drone application to load and unload battery automatically, the optimal 3D virtual model of the ‘power station platform’ was used to represent as the final result. However, with the assistance of PDD, in order to complete the whole processes required, the real testing activity (e.g., physical testing) and production ramp-up process should be done in the next study.

Acknowledgement

The authors would like to offer our gratitude to “SZ DJI Technology Co., Ltd.” for giving us the opportunity to apply “DJI M100 drone” as the case study. The DJI M100 was chosen due to its popularity and the usage of the drone specification was used solely for academic purpose and not with commercial intention in anyway. This research was conducted at the computer laboratory of Industrial Engineering Program, School of Manufacturing Systems and Mechanical Engineering, Sirindhorn International Institute of Technology, Thammasat University. We really appreciate the provided instruments and greatly assisted to finish this paper.

References

- [1] D. Krijnen and C. Dekker, "Drone 2.0 with Subsumption Architecture," *Artificial Intelligence Research Seminar*, 2014.
- [2] A. Wendel, M. Maurer, G. Graber, T. Pock, and H. Bischof, "Dense reconstruction on-the-fly," in *IEEE Conference on Computer Vision and Pattern Recognition (CVPR)*, San Fransisco, pp. 1450-1457, 2012.
- [3] E. Ciampa, "Practical issues on the use of drones for construction inspections," *Journal of Physics: Conference Series*, vol. 1249, p. 012016, 2019.
- [4] M. Hassanalain and A. Abdelkefi, "Classification, applications, and design challenge of drones: A review," *Progress in Aerospace Sciences*, vol. 91, no. 05, pp. 99-131, 2017.
- [5] A. C. Watts, V. G. Ambrosia, and E. A. Hinkley, "Unmanned aircraft systems in remote sensing and scientific research: Classification and consideration of use," *Remote Sensing*, vol. 4, pp. 1671-1692, 2012.
- [6] S. J. Kim, G. J. Lim, "Drone-aided border surveillance with an electrification line battery charging system," *J. Intell. Rob. Syst.*, vol. 92, pp. 657–670, 2018.
- [7] J. Shu, Z. Li, H. Shen, T. Wu, and W. Zhong, "A logistics network design model with vendor managed inventory," *International Journal of Production Economics*, vol. 135, pp. 754-761, 2012.
- [8] S. Kositphon and P. Chaovalitwongse, "An application of systems thinking for solving inventory management problems," *Eng. J.*, vol. 20, pp. 67-88, 2016.
- [9] P. Huynh and P. Yenradee, "Vendor managed inventory for multi-vendor single-manufacturer supply chain: A case study of instant noodle industry", *Eng. J.*, vol. 24, no. 6, pp. 91-107, Nov. 2020.
- [10] B. Hu, C. Meng, D. Xu, and Y.-J. Son, "Supply chain coordination under vendor managed inventory-consignment stocking contracts with wholesale price constraint and fairness," *International Journal of Production Economics*, vol. 202, pp. 21-31, 2018.
- [11] A. Sainathan and H. Groenevelt, "Vendor managed inventory contracts—coordinating the supply chain while looking from the vendor's perspective," *European Journal of Operational Research*, vol. 272, pp. 249-260, 2019.
- [12] M. A. Darwish and O. M. Odah, "Vendor managed inventory model for single-vendor multi-retailer supply chains," *European Journal of Operational Research*, vol. 204, pp. 473-484, 2010.
- [13] B. Dvoretz. "The 6 best hexacopters." wiki.ezvid.com. <https://wiki.ezvid.com/best-hexacopters> (accessed Jun. 1, 2021).
- [14] "Hexacopters, quadcopters and octocopters – What is the Difference?" <https://bit.ly/3v0JNNE> (accessed Jun. 1, 2021).
- [15] "Drone types: multi-rotor vs fixed-wing vs single rotor vs hybrid VTOL." <https://www.auav.com.au/articles/drone-types/> (accessed Jun. 1, 2021).
- [16] "DJI Mavic Pro with 4K foldable, obstacle avoidance quadcopter drone." <https://bit.ly/2TJDkcR> (accessed Jun. 1, 2021).
- [17] "Hobbypower DIY F550 hexacopter frame kit." <https://amzn.to/3z36aVX> (accessed Jun. 1, 2021).
- [18] "Octocopter (Spreading Wings S1000)." <https://bit.ly/2TO2O97> (accessed Jun. 1, 2021).
- [19] A. Sato and H. Naknishi, "Observation and measurement in disaster areas using industrial use unmanned helicopters," in *12th IEEE Int. Symp. Safety, Secure Rescue Robot. SSRR 2014 - Symp. Proc.*, 2014, pp. 1–5.
- [20] A. Townsend, I. N. Jiya, C. Martinson, D. Bessarabov, and R. Gouws, "A comprehensive review of energy sources for unmanned aerial vehicles, their shortfalls and opportunities for improvements," *Helijon*, vol. 6, 2020.
- [21] B. Jackson, "Fixed wing vs multirotor drones for surveying." <https://bit.ly/3w6B6CD> (accessed Jun. 1, 2021).
- [22] A. S. Saeed, A. B. Younes, C. Cai, and G. Cai, "A survey of hybrid unmanned aerial vehicles," *Progress in Aerospace Sciences*, vol. 98, pp. 91–105, 2018.
- [23] M. A. Boon, A. P. Drijfhout, and S. Tesfamichael, "Comparison of a fixed-wing and multi-rotor uav for environmental mapping applications: A case study," *International Conference on Unmanned Aerial Vehicles in Geomatics*, Bonn, Germany, 2017.
- [24] "Types of Drones - Fixed Wing." <https://bit.ly/3pyMkgN> (accessed Jun. 1, 2021).
- [25] "Fixed wing (Ai450 v2.5 ER)." <https://terra-drone.co.id/fixed-wing/> (accessed Jun. 1, 2021).
- [26] Afridrones. "Afridrones." [Afridrones.com](https://afriidrones.com/). <https://afriidrones.com/> (accessed Jun. 1, 2021).
- [27] J. Reid. "Fixed Wing VTOL UAV, a combination of designs." <https://bit.ly/3g1DrJu> (accessed Jun. 1, 2021).
- [28] K. Fujii, K. Higuchi, and J. Rekimoto, "Endless flyer: A continuous flying drone with automatic battery replacement," in *IEEE 10th International Conference on Ubiquitous Intelligence and Computing and IEEE 10th International Conference on Autonomic and Trusted Computing*, Vetri sul Mere, 2013.
- [29] D. Lee, J. Zhou, and W. T. Lin, "Autonomous battery swapping system for quadcopter," in *International Conference on Unmanned Aircraft Systems (ICUAS)*, 2015, pp. 118-124.
- [30] N. K. Ure, G. Chowdhary, T. Toksoz, J. P. How, M. A. Vavrina, and J. Vian, "An automated battery management system to enable persistent missions with multiple aerial vehicles," *IEEE/ASME Transactions on Mechatronics*, vol. 20, no. 1, pp. 275-286, 2015.
- [31] K. A. O. Suzuki and P. K. Filho, "Automatic battery replacement system for UAVs: Analysis and design,"

- Journal of Intelligence Robot System*, vol. 65, no. 09, pp. 563-586, 2011.
- [32] W. Y. Bai and H. T. Huang, "Automatic charging voltage and current adjustment through the wireless message transmission," in *6th Global Conference on Consumer Electronics*, Nagoya, 2017
- [33] J. Kim, J. Lee, J. Jeong, H. Kim, J. S. Park, and T. Kim, "SAN: Self-adaptive navigation for drone battery charging in wireless drone networks," in *30th International Conference on Advanced Information Networking and Applications Workshops (WAINA)*, Crans-Montana, 2016.
- [34] D. R. Dale, "Automated ground maintenance and health management for autonomous unmanned aerial vehicles," M.S. thesis, Dept. of Electrical Engineering and Computer Science, MIT, Cambridge, MA, 2007.
- [35] F. P. Kemper, K. A. O. Suzuki, and J. R. Morrison, "UAV consumable replenishment: Design concepts for automated service stations," *Journal of Intelligent Robotic Systems*, vol. 61, no. 01, pp. 369-397, 2011.
- [36] S. Alhadi, "Senior research," Islamic University of Indonesia, 2018.
- [37] J. P. Vidosic, *Machine Design Projects*. New York: Ronald Press Company, The University of Michigan, 1957.
- [38] N. Jai-ngam and K. Tangchaichi, "Designing a hard disk drive kinetic air particle detachment system using finite element analysis," *Eng. J.*, vol. 22, no. 3, pp. 65-81, Jun. 2018.
- [39] S. Gu, "Application of finite element method in mechanical design of automotive parts," in *2nd International Seminar on Advances in Materials Science and Engineering, Singapore*, 2017, vol. 231, p. 012180.
- [40] R. G. Budynas, J. K. Nisbett, and J. E. Shigley, "Load and stress analysis," in *Shigley's Mechanical Engineering Design*, 8th ed. Singapore: McGraw-Hill, 2008.
- [41] D. Unger and S. Eppinger, "Improving product development process design: A method for managing information flows, risks, and iterations," *Journal of Engineering Design*, vol. 22, no. 10, pp. 689-699, 2011.
- [42] S. Ullah and J. Tamaki, "Analysis of Kano-model-based customer needs for product development," *System Engineering*, vol. 14, no. 05, pp. 154-172, 2011.
- [43] Q. L. Xu, R. J. Jiao, X. Yang, M. G. Helander, H. M. Khalid and O. Anders, "Customer requirement analysis based on an analytical Kano model," in *IEEE International Conference on Industrial Engineering and Engineering Management*, 2007, pp. 1287-1291.
- [44] C. DJI. "Matrice 100, Quadcopter for Developer." www.dji.com (accessed Nov. 20, 2020).
- [45] *DJI Matrice100 User Manual*, DJI Company, 2017, pp. 1-75. Accessed Nov. 20, 2020. [Online]. Available: https://dl.djicdn.com/downloads/m100/M100_User_Manual_EN.pdf
- [46] "Matrice 100 TB47D battery." <https://bit.ly/3pPFTu9> (accessed Oct. 11, 2020).
- [47] D. Deploy. "Our 4 favorite things about the new DJI Matrice 100 drone (not a review)." <https://bit.ly/3pN4BXn> (accessed Oct. 10, 2020).
- [48] R. Cabas and C. Balaguer, "Design and development of a light weight embodied robotic hand activated with only one actuator," in *IEEE/RSJ International Conference on Intelligent Robots and Systems*, Edmonton, 2005, pp. 2369-2374.
- [49] M. T. Rana and A. Roy, "Design and construction of a robotic arm for industrial automation," *International Journal of Engineering Research & Technology*, vol. 6, no. 05, pp. 919-922, 2017.
- [50] B. F. Erlingsson, I. Hreimsson, P. I. Pálsson, S. J. Hjálmarsson, and J. T. Foley, "Axiomatic design of a linear motion robotic claw with interchangeable grippers," *Procedia CIRP*, vol. 53, pp. 213-218, 2016.
- [51] M. Furqan and E. M. Rathi, "Industrial robotic claw for cottage industries," in *International Conference on Computing, Mathematics and Engineering Technologies*, Sukkur, 2019.
- [52] H. Henky, "Zur Theorie plastischer Deformationen und der hierdurch im Material hervorgerufenen Nachspannungen," *Z Angew Math Mech*, vol. 4, pp. 323-335, 1924, doi: 0.1002/zamm.19240040405.
- [53] Y. Gorash and D. Mackenzie, "On cyclic yield strength in definition of limits for characterisation of fatigue and creep behavior," *Open Engineering*, vol. 7, pp. 126-140, 2017.
- [54] D. Kopeliovich. "Wrought aluminum alloy 1060." <https://bit.ly/3kN44Rv> (accessed Sep. 15, 2020).

Surya Alhadi, photograph and biography not available at the time of publication.

Suchada Rianmora, photograph and biography not available at the time of publication.

Maroay Phlernjai, photograph and biography not available at the time of publication.