

PROCEEDING ICoSET 2017

**International Conference on Science Engineering
and Technology (ICoSET) and International
Conference on Social Economic Education and
Humaniora (ICoSEEH)
08 - 10 November 2017
Pekanbaru, Indonesia**

ICoSET 2017 Partner and Support

Organizer :



Co-Organizers :



ORGANIZING COMMITTEE

Conference Chair:

Dr. Evizal Abdul Kadir, ST., M.Eng

Conference Co-Chair Science:

Dr. Dedikarni, ST., M.Sc

Conference Co-Chair Social:

Dr. Sri Yuliani, M.Pd

Technical Program Chair:

Prof. Dr. Ku Ruhana Ku Mahamud

Assoc. Prof. Dr. Tole Sutikno

Technical Program Committees:

Prof. Dr. Detri Karya, SE., MA
(Islamic University of Riau, Indonesia)

Prof. Dr. Tengku Dahril, M.Sc
(Islamic University of Riau, Indonesia)

Prof. Dr. Sugeng Wiyono, MMT (Islamic
University of Riau, Indonesia)

Prof. Zainal A. Hasibuan, MLS., Ph.D
(University of Indonesia, Indonesia)

Prof. Dr. Usama Fauzi Juniansyah
(University of Tokyo, Japan)

Prof. Dr. Zailuddin Arifin
(Universiti Teknologi MARA, Malaysia)

Prof. Ahmed A. Al Absi
(Kyungdong University Korea)

Prof. Kazuhiko Nagatomo
(Dayeh University)

Assoc. Prof. Dr. Shahrul Kamal Abdul
Rahim
(Universiti Teknologi Malaysia)

Ahn, Young Mee, Ph.D
(Inha University, Korea)

Hitoshi Irie, Ph.D
(Chiba University, Japan)

Julie Yu-Chih Liu, Ph.D
(Yuan Ze University, Taiwan)

Chia-Yu Hsu, Ph.D
(Yuan Ze University, Taiwan)

Prof. Dr. Hasan Basri Jumin, M.Sc
(Islamic University of Riau, Indonesia)

Prof. Dr. Syafrinaldi, SH., M.CL (Islamic
University of Riau, Indonesia)

Prof. Dr. Seno Himala Putra,
M.Pd (Islamic University of Riau,
Indonesia)

Prof. Josaphat Tetuko Sri Sumantyo, Ph.D
(Chiba University, Japan)

Prof. Dr. Eko Supriyanto
(Universiti Teknologi Malaysia)

Prof. Jhon Lee, B.Sc, M.Sc., Ph.D
(Kyungdong University Korea)

Prof. Wisup Bae, Ph.D
(Sejong University, Korea)

Assoc. Prof. Dr. Azhan Hashim Ismail
(Universiti Teknologi MARA, Malaysia)

Dr. Inkyo Cheong
(Inha University, Korea)

Dr. Montira Leelakriangsak
(Prince of Songkla University, Thailand)

Kuen-Song Lin, Ph.D
(Yuan Ze University, Taiwan)

Liang Chih Yu, Ph. D
(Yuan Ze University, Taiwan)

Dr. Tulyapong Tulyapitak
(Prince of Songkla University, Thailand)

Dr. Wahyudi Sutopo
(Solo State University, Indonesia)

Dr. Zulfatman
(University of Muhammadiyah Malang,
Indonesia)

Dr. Anas Puri, ST., MT
(Islamic University of Riau)

Dr. Eng. Muslim, ST., MT
(Islamic University of Riau)

Dr. Eng. Husnul Kausarian, B.Sc (Hons).,
M.Sc
(Islamic University of Riau)

Dr. Shukor Sanim Mohd Fauzi (Universiti
Teknologi MARA, Malaysia)

Organizing Committee:

Faizan Dalilla, ST., M.Si
Augusta Adha, ST., MT

Secretary:

Dr. Zetriuslita, S.Pd., M.Si
Heriyanto, SP., M.Si
Reni Anggraini Putri, SE

Treasurer:

Bismi Annisa, ST., MT

Information Technology (IT):

Abdul Syukur, S.Kom., M.Kom
Hendra Gunawan, ST., M.Eng

FOREWORD FROM CHAIR OF ICOSET & ICOSEEH

UNIVERSITAS ISLAM RIAU

In the name of Allah, Most Gracious, Most Merciful

Assalamualaikum Wr. Wb,

Welcome to the International Conference on Science Engineering and Technology (ICoSET) and International Conference on Social Economic Education and Humaniora (ICoSEEH).

ICoSET & ICoSEEH 2017 has a theme “Sustainability Development in Developing Country”. This forum provides researchers, academicians, professionals, and disciplinary working or interested in the field of Science Electrical Technology and Social Education Economy and Humaniora to show their works and findings to the world.

I would like to express my hearty gratitude to all participants for coming, sharing and presenting your experiences in this vast conference. There are more than 150 papers submitted to ICoSET & ICoSEEH UIR 2017. However only high quality selected papers are accepted to be presented in this event, so we are also thankful to all the international reviewers and steering committee for their valuable work. I would like to give a compliment to all partners in publications and sponsor ships for their valuable supports.

Organizing such a prestigious conference was incredibly challenge and would have been impossible without our outstanding committee, So, I would like to extend my sincere appreciation to all committees and volunteers from Chiba University, Saga University, Universiti Teknologi Mara, Universiti Utara Malaysia, Dayen University, Kyungdong University for providing me with much needed support, advice, and assistance on all aspects of the conference. We do hope that this event will encourage the collaboration among us now and in the future.

We wish you all find opportunity to get rewarding technical programs, intellectual inspiration, renew friendships and forge innovation and that everyone enjoys some of what in Pekanbaru-Riau special.

Pekanbaru, 8th November 2017

Dr. Evizal Abdul Kadir, M.Eng

Chair of ICoSET & ICoSEEH 2017

**FOREWORD FROM RECTOR
UNIVERSITAS ISLAM RIAU**

It is our great pleasure to join and to welcome all participants of the International Conference on Science Engineering and Technology (ICoSET) and International Conference on Social Economic Education and Humaniora (ICoSEEH) 2017 in Pekanbaru. I am happy to see this great work as part of collaborations among Chiba University, Saga University, Universiti Teknologi Mara, Universiti Utara Malaysia, Dayen University, Kyungdong University. In this occasion, I would like to congratulate all participants for their scientific involvement and willingness to share their findings and experiences in this conference.

I believe that this conference can play an important role to encourage and embrace cooperative, collaborative, and interdisciplinary research among the engineers and scientists. I do expect that this kind of similar event will be held in the future as part of activities in education research and social responsibilities of universities, research institutions and industries internationally.

My heart full gratitude is dedicated to organizing committee members and the staff of Islamic University of Riau for their generous effort and contribution toward the success of the ICoSET & ICoSEEH 2017.

Pekanbaru, 8th November 2017

Prof. Dr. H. Syafrinaldi, SH., MCL

Rector of Islamic University of Riau

Pekanbaru, Indonesia

TIME SCHEDULE

International Conference on Science Engineering and Technology (ICoSET) and International Conference on Social Economic Education and Humaniora (ICoSEEH) Pekanbaru, Indonesia, 08-10 November 2017

TIME	ACTIVITIES	PERSON IN CHARGE	VENUE
November 08, 2017			
08.00-08.30	Registration	Committee	Auditorium Rectorat 4 th Floor
08.30-09.15	Opening Ceremony:	Committee	
	Quran Recitation	Committee	
	Indonesia Raya National Anthem	Committee	
	Speech of the Committee	Chairman of the committee Dr. Evizal Abdul Kadir, ST, M.Eng	
	Opening speech	Rector of Islamic Universty of Riau Prof. Dr. H. Syafrinaldi, SH., MCL	
	Performing Arts (Traditional Dance)	Committee	
09.15-09.30	Photo Session and Coffee Break	Committee	
09.30-12.00	Keynote speakers: 1. Prof. Dr. Shigeki Inaba: Professor of Agronomy. Agricutural Plant Science & Agricultural Economics. Saga University, Japan. 2. Prof. John Lee PhD, ME, MSc, BSc: President Kyungdong Global Campus Research, Kyoto University, Japan 3. Yohei Murakami, Ph.D: Center for the Promotion of Interdisciplinary Education	Moderator 1. Dr. Ujang Paman Ismail, M.Agr 2. Dr. Evizal Abdul Kadir., M.Eng 3. Arbi Haza Nst, B.IT, M.IT	
12.00-13.00	Lunch Break	Committee	
13.00-15.00	Parallel Session 1 Participants	Moderator	4 rd Floor
15.00-15.30	Coffee Break	Committee	
15.30-17.30	Parallel Session 2 Participants	Moderator	
17.30-17.45	Closing Ceremony	Committee	

TIME	ACTIVITIES	PERSON IN CHARGE	VENUE
November 09, 2017			
07.30-08.00	Re-registration	Committee	1 st Floor
08.00-17.00	Siak Tour: 1. Istana Siak 2. Klenteng Hock Siu Kiong (Bangunan Merah) 3. Masjid Syahabuddin 4. Balai Kerapatan Adat		

LIST OF PRESENTES

International Conference on Science Engineering and Technology (ICoSET)

ROOM 1

Time Slot	No	Paper ID	Author	Title
Parallel Presentation 1 (13.00-15.00)	1	1001	Evizal Abdul Kadir, Ahmed A. Al Absi, Sri Listia Rosa	Feasibility Study On Solar Power Generation In Islamic University Of Riau Pekanbaru Capacity 1 Mw
	2	1002	Arbi Haza Nasution, Yohei Murakami, Toru Ishida	Similarity Cluster of Indonesian Ethnic Languages
	3	1007	Jaroji, Agustiawan, Rezki Kurniati	Design Self Service Software Prototype For Village Office Using Unified Modeling Language
	4	1009	Yoanda Alim Syahbana, Memen Akbar	Analysis Of Frame Loss Position Influence And Type Of Video Content To Perceived Video Quality
	5	1010	Apri Siswanto, Norliza Katuk, Ku Ruhana Ku-Mahamud, Evizal Abdul Kadir	An Overview of Fingerprint Template Protection Approaches
	6	1013	Yuniarti Yuskar, Dewandra Bagus Eka Putra, Tiggi Choanji, Ziadul Faiez, Muhammad Habibi	Sandstone Reservoir Characteristic Based on Surficial Geological Data of Sihapas Formation in Bukit Suligi Area, Southwest Central Sumatra Basin
Parallel Presentation 2 (15.30-17.30)	7	1015	Raisa Baharuddin, Selvia Sutriana	Effect of Maturity Level of Compost And Shallot Varieties to Growth and Yield in Peat Soil
	9	1019	Ida Syamsu Roidah, Dona Wahyuning Laily	Improving Family Revenues Through Role of Household Mother In Rejotangan District
	10	1026	Fathra Annis Nauli1, Jumaini, Diva de Laura	Relationship Between Adolescent Characteristic and Bullying Incidents At Private Junior High School In Pekanbaru
	11	1025	Husnul Kausarian, Batara, Dewandra Bagus Eka Putra, Adi Suryadi, Evizal Abdul Kadir	Measurement of Electric Grid Transmission Lines as the Supporting of National Energy Program in West Sumatera Area, Indonesia through Geological Mapping and Assessment

ROOM 2

Time Slot	No	Paper ID	Author	Title
Parallel Presentation 1 (13.00-15.00)	1	1012	Dewandra Bagus Eka Putra, Yuniarti Yuskar, Catur Cahyaningsih, Seppia Khairani	Rock Mass Classification System Using Rock Mass Rating (Rmr) Of A Cut Slope In Riau – West Sumatra Road
	2	1016	Sisca Vaulina, Khairizal, Hajry Arief Wahyudy	Factors Affecting Production of Coconut (<i>Cocos Nucifera</i> Linn) In Gaung Anak Serka District Indragiri Hilir Regency, Riau Province
	3	1004	Nur Khamdi, Muhammad Imam Muthahhar	Determining Sliders Position by Using Pythagoras Principle of 3-DOF Linear Delta Robot
	4	1005	Desti	Morphological Characterization of Nibung (<i>Oncosperma Tigillarum</i> (Jack) Ridl.) As Riau Province Mascot Flora
	5	1006	Novrianti, Ali Musnal, Hardi, Bop Duana A, Leovaldo P	Weight On Bit Analysis In Rate Of Penetration Optimization Using Bourgoyne And Young Method
	6	1008	Idham Nugraha, Febby Asteriani, Puji Astuti, Retno Sawitri, Firdaus Agus	The Effects of Tengku Agung Sultanah Latifah Bridge Toward Physical Development in Siak Sub Districts
	7	1003	Heriyanto	Efficiency Of Rubber People Production In Kampar Regency Of Riau Province
	8	1011	Ariyon, M, Nugroho, R. S.	Production Optimization Esp-To-Gas Lift In High Gor Case Using Well Simulator
	9	1014	Anas Puri	Effect of Safety Factors on The Calculated Deflection of 1-Pile Row Full Scale Nailed-Slab Pavement System Resting on Soft Clay Due to Concentric Loadings
Parallel Presentation 2 (15.30-17.30)	10	1017	Dody Yulianto, Dedikarni, Kurnia Hastuti, Juraiz Saputra	Utilization Of Palm Oil Waste With Polypropylene Matriks (Pp) Recycling On Particle Board Composite (Particle Board)
	11	1018	Tengku Idris Nurkhairi Hidayati	Profile of Habits of Mind Student of Biology Education Program Islamic University of Riau
	12	1020	Hermaini, Sugeng Wiyono, Anas Puri	Study Of Concrete On Rigid Pavement With Addition Scanfibre
	13	1021	Muhammad Ariyon	Energy Resource Development Strategy At Indragiri Hulu Regency Riau Province
	14	1022	Rosyadi, Agusnimar, Abdul Fatah Rasidi	Giving <i>Chlorella sp</i> with Different Amount for Development <i>Moina sp</i>
	15	1023	Sri Ayu Kurniati, Welly Sampurno	Analysis Of The Competitiveness Of Farming Oil Palm People Bengkalis Regency In Mandau
	16	1027	Ernita, M. Noer, Sidik Arif Irawan	Green Beans Plant Response (<i>Vigna Radiata</i> L) On Liquid Organic Fertilizer (Lof) Nasa and NPK Compound Fertilizer
	17	1028	Darus, Hajry Arief Wahyudy	Analysis Of Human Resources Work In Production Activity Hydroponic Vegetables Commodity (Case Study: Technical implementation Unit of Agro Garden in Islamic University of Riau)

TABLE OF CONTENTS

Organizing Committee -----	i
Foreword From Chair of ICoSET & ICoSEEH Universitas Islam Riau -----	iii
Foreword From Rector Universitas Islam Riau -----	iv
Time Schedule -----	v
Table of Contents -----	vii
1001:Feasibility Study On Solar Power Generation In Islamic University Of Riau Pekanbaru Capacity 1 Mw (Evizal Abdul Kadir, Ahmed A. Al Absi, Sri Listia Rosa) -----	1
1002:Similarity Cluster of Indonesian Ethnic Languages (Arbi Haza Nasution, Yohei Murakami, Toru Ishida) -----	12
1003:Efficiency Of Rubber People Production In Kampar Regency Of Riau Province (Heriyanto) -----	28
1004: Determining Sliders Position by Using Pythagoras Principle of 3- DOF Linear Delta Robot (Nur Khamdi, Muhammad Imam Muthahhar) -----	36
1005:Morphological Characterization of Nibung (Oncosperma Tigillarum (Jack) Ridl.) As Riau Province Mascot Flora (Desti) -----	41
1006: Weight On Bit Analysis In Rate Of Penetration Optimization Using Bourgoyne And Young Method (Novrianti, Ali Musnal, Hardi, Bop Duana A, Leovaldo P) -----	46
1007: ---Design Self Service Software Prototype For Village Office Using Unified Modeling Language (Jaroji, Agustiawan, Rezki Kurniati) -----	56
1008:The Effects of Tengku Agung Sultanah Latifah Bridge Toward Physical Development in Siak Sub Districts (Idham Nugraha, Febby Asteriani, Puji Astuti, Retno Sawitri, Firdaus Agus) -----	67
1009:Analysis Of Frame Loss Position Influence And Type Of Video Content To Perceived Video Quality (Yoanda Alim Syahbana, Memen Akbar) -----	73
1010: An Overview of Fingerprint Template Protection Approaches (Apri Siswanto, Norliza Katuk, Ku Ruhana Ku-Mahamud, and Evizal Abdul Kadir) -----	80
1011:Production Optimization Esp-To-Gas Lift In High Gor Case Using Well Simulator (Ariyon, M, Nugroho, R. S) -----	94
1012:Rock Mass Classification System Using Rock Mass Rating (Rmr) Of A Cut Slope In Riau – West Sumatra Road (Dewandra Bagus Eka Putra, Yuniarti Yuskar, Catur Cahyaningsih, Seppia Khairani1) -----	106

1013:Sandstone Reservoir Characteristic Based on Surficial Geological Data of Sihapas Formation in Bukit Suligi Area, Southwest Central Sumatra Basin (Yuniarti Yuskar, Dewandra Bagus Eka Putra, Tiggi Choanji, Ziadul Faiez, Muhammad Habibi) -----	112
1014:Effect of Safety Factors on The Calculated Deflection of 1-Pile Row Full Scale Nailed-Slab Pavement System Resting on Soft Clay Due to Concentric Loadings (Anas Puri) -----	118
1015:Effect of Maturity Level of Compost And Shallot Varieties to Growth and Yieldin Peat Soil (Raisa Baharuddin, Selvia Sutriana) -----	125
1016:Factors Affecting Production of Coconut (Cocos Nucifera Linn) In Gaung Anak Serka District Indragiri Hilir Regency, Riau Province (Sisca Vaulina, Khairizal, Hajry Arief Wahyudy) -----	133
1017:Utilization Of Palm Oil Waste With Polypropylene Matriks (Pp) Recycling On Particle Board Composite (Particle Board) (Dody Yulianto, Dedikarni Kurnia Hastuti, Juraiz Saputra) -----	142
1018:Profile of Habits of Mind Student of Biology Education Program Islamic University of Riau (Tengku Idris, Nurkhalro Hidayati) -----	151
1019:Improving Family Revenues Through Role Of Household Mother In Rejotangan District (Ida Syamsu Roidah dan Dona Wahyuning Laily) -----	159
1020:Study Of Concrete On Rigid Pavement With Addition Scanfibre (Hermaini, Sugeng Wiyono, Anas Puri) -----	165
1021:Energy Resource Development Strategy At Indragiri Hulu Regency Riau Province (Muhammad Ariyon) -----	178
1022:Giving Chlorella sp with Different Amount for Development Moina sp (Rosyadi, Agusnimar, Abdul Fatah Rasidi) -----	189
1023:Analysis Of The Competitiveness Of Farming Oil Palm People Bengkalis Regency In Mandau (Sri Ayu Kurniati, Welly Sampurno) -----	198
1024: Learning Outcome Comparison In Biology Subject Between Problem Based Learning (Pbl) Method Applied And Guided Discovery Learning (Gdl) Method Applied At Class Xi Sman Pekanbaru Academic Year 2016/2017 (Suryanti, Sepita Ferazona) -----	212
1025:Measurement of Electric Grid Transmission Lines as the Supporting of National Energy Program in West Sumatra Area, Indonesia through Geological Mapping and Assessment (Husnul Kausarian, Batara, Dewandra Bagus Eka Putra, Adi Suryadi, Evizal Abdul Kadir) -----	221
1026:Relationship Between Adolescent Characteristic and Bullying Incidents at Private Junior High School In Pekanbaru (Fathra Annis Nauli, Jumaini, Diva de Laura) -----	230

1027: Green Beans Plant Response (<i>Vigna Radiata</i> L) On Liquid Organic Fertilizer (Lof) Nasa and NPK Compound Fertilizer (Ernita, M. Noer, Sidik Arif Irawan) -----	238
1028: Analysis Of Human Resources Work In Production Activity Hydroponic Vegetables Commodity (Case Study: Technical Implementation Unit Of Agro Garden In Islamic University Of Riau) (Darus, Hajry Arief Wahyudy) -----	254

LIST OF PAPERS

International Conference on Science Engineering and Technology (ICoSET)

Pekanbaru, Indonesia, 08-10 November 2017

No	ID	Author	Paper
1	1001	Evizal Abdul Kadir, Ahmed A. Al Absi, Sri Listia Rosa	Feasibility Study On Solar Power Generation In Islamic University Of Riau Pekanbaru Capacity 1 Mw
2	1002	Arbi Haza Nasution, Yohei Murakami, Toru Ishida ³	Similarity Cluster of Indonesian Ethnic Languages
3	1003	Heriyanto	Efficiency Of Rubber People Production In Kampar Regency Of Riau Province
4	1004	Nur Khamdi, Muhammad Imam Muthahhar	Determining Sliders Position by Using Pythagoras Principle of 3-DOF Linear Delta Robot
5	1005	Desti	Morphological Characterization of Nibung (<i>Oncosperma Tigillarum</i> (Jack) Ridl.) As Riau Province Mascot Flora
6	1006	Novrianti, Ali Musnal, Hardi, Bop Duana A, Leovaldo P	Weight On Bit Analysis In Rate Of Penetration Optimization Using Bourgoyne And Young Method
7	1007	Jaroji, Agustawan, Rezki Kurniati	Design Self Service Software Prototype For Village Office Using Unified Modeling Language
8	1008	Idham Nugraha, Febby Asteriani, Puji Astuti, Retno Sawitri, Firdaus Agus	The Effects of Tengku Agung Sultanah Latifah Bridge Toward Physical Development in Siak Sub Districts
9	1009	Yoanda Alim Syahbana, Memen Akbar	Analysis Of Frame Loss Position Influence And Type Of Video Content To Perceived Video Quality
10	1010	Apri Siswanto, Norliza Katuk, Ku Ruhana Ku-Mahamud, and Evizal Abdul Kadir	An Overview of Fingerprint Template Protection Approaches
11	1011	Ariyon, M, Nugroho, R. S.	Production Optimization Esp-To-Gas Lift In High Gor Case Using Well Simulator
12	1012	Dewandra Bagus Eka Putra, Yuniarti Yuskar, Catur Cahyaningsih, Seppia Khairani ¹	Rock Mass Classification System Using Rock Mass Rating (Rmr) Of A Cut Slope In Riau – West Sumatra Road
13	1013	Yuniarti Yuskar, Dewandra Bagus Eka Putra, Tiggi Choanji, Ziadul Faiez, Muhammad Habibi	Sandstone Reservoir Characteristic Based on Surficial Geological Data of Sihapas Formation in Bukit Suligi Area, Southwest Central Sumatra Basin
14	1014	Anas Puri	Effect of Safety Factors on The Calculated Deflection of 1-Pile Row Full Scale Nailed-Slab Pavement System Resting on Soft Clay Due to Concentric Loadings
15	1015	Raisa Baharuddin, Selvia Sutriana	Effect of Maturity Level of Compost And Shallot Varieties to Growth and Yieldin Peat Soil
16	1016	Sisca Vaulina, Khairizal, Hajry Arief Wahyudy	Factors Affecting Production of Coconut (<i>Cocos Nucifera</i> Linn) In Gaung Anak Serka District Indragiri Hilir Regency, Riau Province

No	ID	Author	Paper
17	1017	Dody Yulianto, Dedikarni Kurnia Hastuti, Juraiz Saputra	Utilization Of Palm Oil Waste With Polypropylene Matriks (Pp) Recycling On Particle Board Composite (Particle Board)
18	1018	Tengku Idris, Nurkhairo Hidayati	Profile of Habits of Mind Student of Biology Education Program Islamic University of Riau
19	1019	Ida Syamsu Roidah dan Dona Wahyuning Laily	Improving Family Revenues Through Role Of Household Mother In Rejotangan District
20	1020	Hermaini, Sugeng Wiyono, Anas Puri	Study Of Concrete On Rigid Pavement With Addition Scanfibre
21	1021	Muhammad Ariyon	Energy Resource Development Strategy At Indragiri Hulu Regency Riau Province
22	1022	Rosyadi, Agusnimar, Abdul Fatah Rasidi	Giving <i>Chlorella sp</i> with Different Amount for Development <i>Moina sp</i>
23	1023	Sri Ayu Kurniati, Welly Sampurno	Analysis Of The Competitiveness Of Farming Oil Palm People Bengkalis Regency In Mandau
24	1024	Suryanti, Sepita Ferazona	Learning Outcome Comparison In Biology Subject Between Problem Based Learning (Pbl) Method Applied And Guided Discovery Learning (Gdl) Method Applied At Class Xi Sman Pekanbaru Academic Year 2016/2017
25	1025	Husnul Kausarian, Batara, Dewandra Bagus Eka Putra, Adi Suryadi, Evizal Abdul Kadir	Measurement of Electric Grid Transmission Lines as the Supporting of National Energy Program in West Sumatra Area, Indonesia through Geological Mapping and Assessment
26	1026	Fathra Annis Nauli, Jumaini, Diva de Laura	Relationship Between Adolescent Characteristic and Bullying Incidents at Private Junior High School In Pekanbaru
27	1027	Ernita, M. Noer, Sidik Arif Irawan	Green Beans Plant Response (<i>Vigna Radiata L</i>) On Liquid Organic Fertilizer (Lof) Nasa and NPK Compound Fertilizer
28	1028	Darus, Hajry Arief Wahyudy	Analysis Of Human Resources Work In Production Activity Hydroponic Vegetables Commodity (Case Study: Technical implementation Unit of Agro Garden in Islamic University of Riau)

FEASIBILITY STUDY ON SOLAR POWER GENERATION IN ISLAMIC UNIVERSITY OF RIAU PEKANBARU CAPACITY 1 MW

Evizal Abdul Kadir¹, Ahmed A. Al Absi², Sri Listia Rosa³

^{1,3}Department of Information Technology, Faculty of Engineering, Universitas Islam Riau
Jl. Kaharuddin Nasution No.113, Marpoyan, Pekanbaru 28284 Riau, Indonesia

²Department of Information Technology, Kyungdong University
Global Campus, Gosung, Gangwondo, 24764, South Korea

Email: evizal@eng.uir.ac.id, absiahmed@kduniv.ac.kr, sriliatarosa@eng.uir.ac.id

Abstract

Currently electricity power supplies have limited resources because of most power generation from diesel engine and others limited resources. Solar power is one of alternative energy resources that having in tropical region especially in Indonesia. This research conduct on feasibility and capacity that potential be generate in Islamic University of Riau. Method use is based on survey and data collected in area of campus Islamic University of Riau. Results shows within as space on open area that available as 2 Hectare in Islamic University of Riau, potential to generate electricity power by installing solar photovoltaic as much as 1 MW. This capacity have potential to replace electricity usage in campus daily in day time and night time will be less because not much activity compare to daytime. With this solar photovoltaic power generation will be reduce University expenses in monthly electric bill as well in night time power is surplus then can be sell to resident that get extra income for University.

Keywords: *Solar Power, Feasibility Study, UIR*

1. INTRODUCTION

This diesel based energy has several problems that need to be taken into consideration. Firstly, the CO₂ emissions due to fuel for generators were 569.000 tons in 2012. Secondly, oil spills and pollution (both chemical and acoustic) are especially important in the arctic region. The pristine characteristics of this environment, like the low temperatures that regulate the climate or the inability of the habitat of cleaning itself, make the problems mentioned above even worst. Thirdly, the transportation of fuel to remote areas can be dangerous and highly cost, especially during winter. An

interesting approach to solve this problem could be the introduction of stand-alone

PV systems. This kind of systems has the possibility of reducing fuel consumption and noise level of the area. The election of Photovoltaic (PV) energy as the substitute of the fuel generators comes from an analysis of the characteristics that make the arctic environment a unique place. The relatively high irradiances, long day lights and the low ambient temperature are key factors that increase the efficiency of the solar energy production. In addition, PV systems require almost no maintenance, which make it an important aspect in a

country where no technicians, tools and equipment are easily available.

When it comes to our energy needs, there are three main problems. We have confused needs and desires, cheap energy and not educated ourselves enough on understanding energy. Need is a word that gets used out of context all the time, it falls into the category of words like have to, should, got to and must. When we hear those words, we feel as if our choice is taken away and we are presented with something we have to do or else. The reason is what is it we need in our homes that require energy, people say all the time to me, but I need a dryer, air-con and else. When in reality they are just desires. Things we would like to have to make our days easier so we can get more done in a day. So that we can go to work to pay for our electricity bills in reality, more people on earth live without electricity than with, so we don't need it at all to survive. Have a think about how much excess electrical load you have in your home just because it saves you time or helps you do something faster.

The next part of the problem is cheap energy, what has made us go out and buy a lot of electrical devices that save us time. That way we can go to work and make more money as it's cheaper to have the electricity work for us at home while we go work. This has helped a lot of desires become needs. Cheap energy has helped bad building designs to get built because we don't need

to insulate or think about solar aspect anymore. We just put the air-con on, and that will heat and cool the house at the touch of a button, cheap fossil fuels have had an enormous part in making renewable energy seem expensive. Fossil fuels receive a huge chunk of currency from governments to keep the energy coming so that we don't get upset when there is no energy at the power points. If they charged us the true cost of what it takes to get energy to our power points, I guarantee that would instantly help reduce the need for energy in our homes. The math is simple, multiply your energy bill by 10 times, and that's how much of a discount the government is paying for you every month right now to subsidies fossil fuels and that is worldwide.[1]

2. LITERATURE REVIEW

Solar PV technology converts energy from solar radiation directly into electricity. Solar PV cells are the electricity-generating component of a solar energy system. When sunlight (photons) strikes a PV cell, an electric current is produced by stimulating electrons (negative charges) in a layer in the cell designed to give up electrons easily. The existing electric field in the solar cell pulls these electrons to another layer. By connecting the cell to an external load, this current (movement of charges) can then be used to power the load (e.g., a light bulb) as shows in figure 1.

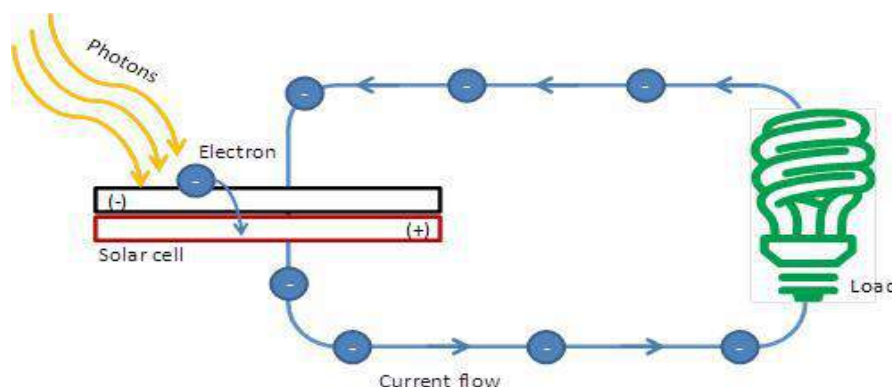

Figure 1. Generation of electricity from a PV cell

PV cells are assembled into a PV panel or modules, PV modules are then connected to create an array. The modules are connected in series and then in parallel

)

electricity generated by the array is then converted by an inverter to useable alternating current (AC) that can be consumed by adjoining buildings and facilities or exported to the electricity grid. PV system size varies from small residential (2–10 kW), to commercial (100–500 kW), to large utility scale (10+ MW). Central distribution plants are also currently being built in the 100+ MW scale. Electricity from utility-scale systems is commonly sold back to the electricity grid.

as needed to reach the specific voltage and current requirements for the array. The direct current (DC

A typical PV system is made up of several key components, including:

- PV modules
- Inverter
- Balance-of-system (BOS) components.

These, along with other PV system components, are discussed in turn below in figure 2.

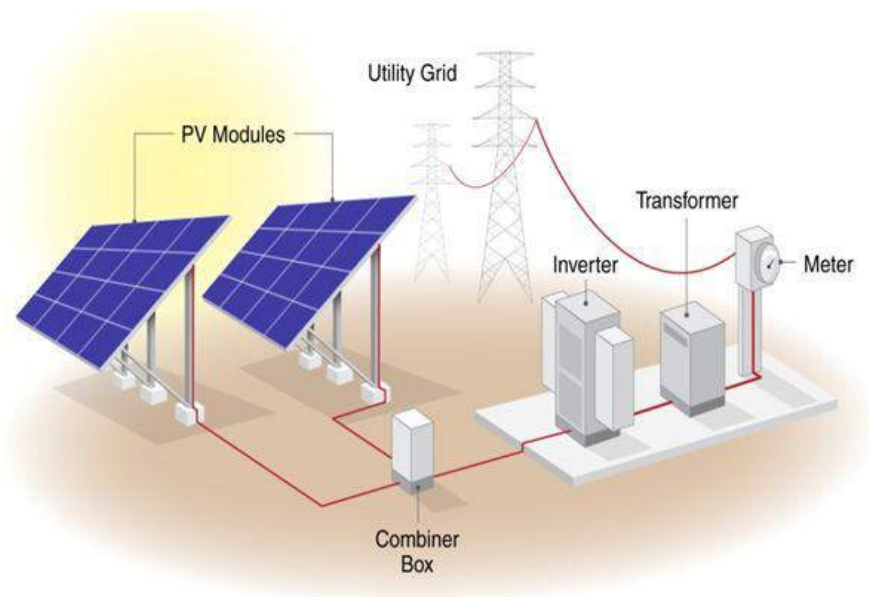

Figure 2. Ground-mounted array diagram

Module technologies are differentiated by the type of PV material used, resulting in a range of conversion efficiencies from light energy to electrical energy. The module efficiency is a measure of the percentage of solar energy converted into electricity.

Two common PV technologies that have been widely used for commercial- and utility-scale projects are crystalline silicon and thin film. Traditional solar cells are made from silicon. Silicon is quite abundant

and nontoxic. It builds on a strong industry on both supply (silicon industry) and product side. This technology has been demonstrated to be functional for over 30 years in the field. The performance degradation, a reduction in power generation due to long-term exposure, is under 1% per year. Silicon modules have a lifespan in the range of 25–30 years but can keep producing energy beyond this range.

Typical overall efficiency of silicon solar panels is between 12% and 18%. However, some manufacturers of mono-crystalline panels claim an overall efficiency nearing 20%. This range of efficiencies represents significant variation among the crystalline silicon technologies available. The technology is generally divided into mono- and multi-crystalline technologies, which indicates the presence

of grain-boundaries (i.e., multiple crystals) in the cell materials and is controlled by raw material selection and manufacturing technique. Crystalline silicon panels are widely used based on deployments worldwide. Figure 3 shows two examples of crystalline solar panels: mono and multi silicon installed on tracking mounting systems



Figure 3. Mono and multi crystalline solar panels.

3. METHODOLOGY

The research focuses on two cases, an internet café with existing solar panels and an upcoming school facility. In the field study measurements were done on the solar panels of the internet café, to get accurate data, valid for the location. Laboratory work with solar PV has been done at Chalmers to see how angles and reflectors affect the power output. Different sources of climate data for Universitas Islam Riau (UIR) campus has been studied and compared, in order to evaluate which data to use. A literature study was done within the field of stand-alone power systems. Scientific articles were studied to evaluate equations and methods for the dimensioning of solar power systems. Since climate data varies between different sources, the field study includes measurements of the actual

generation from solar panels in UIR campus. From these results, which was compared with literature concerning solar radiation, conclusions could be drawn, of which data source that should be used in the research, for the dimensioning of the energy systems. Measurements were also done to evaluate the importance of maintenance of solar panels. The generation by the panels at the internet café was measured before and after cleaning the panels. To evaluate if it is economic to use reflectors the expected increased generation from attached reflectors has been calculated. The reflections from a metal surface were analyzed in a laboratory test. The attachment of the reflectors was designed to suit the panels and the solar path throughout the year, as shows in Figure 4. The required size and cost of the reflectors was evaluated for the cost-comparison.

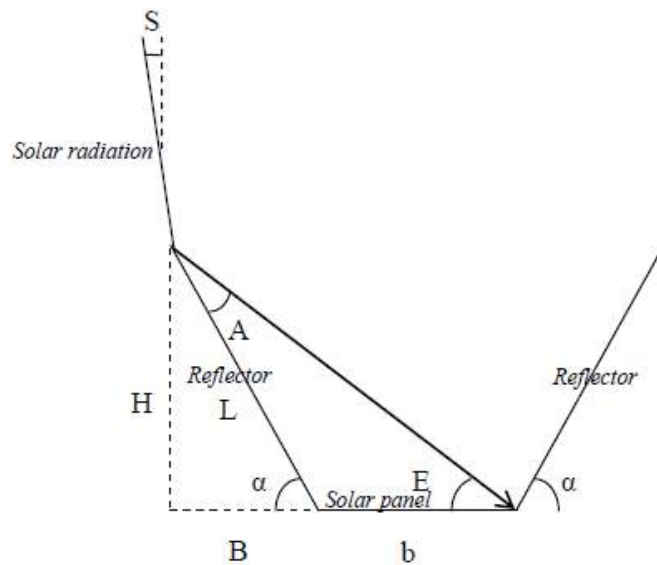

Figure 4. The proposed attachment of reflectors.

Geometrical theory was used to evaluate Equation 1, which was used to calculate the expected increased generation for different solar paths.

$$E = 2 * \alpha - S - 90 \quad (1)$$

The angle E means that the reflections will add as an extra light source with the incoming angle E. The increased radiation (R), during solar noon, was calculated with Equation 2.

$$R = \cos (90 - E) * \eta_r * \eta_{surf} \quad (2)$$

The reflection efficiencies (η_r) are evaluated from the results of an experiment by (4). When the increased generation over one full day should be estimated, the solar height and the varying generation over the day are included. Equation 3 was evaluated to estimate the increased generation over one full day (RF).

$$RF = R * \eta_{6r} + R * \eta_{5r} + R * \eta_{0r} \quad (3)$$

η_{6r} is the part of the total daily generation that occurs during the time when all the six panels fully can absorb reflections. η_{5r} is

the part of the generation that occurs when five of the panels are affected by the reflectors. η_{0r} is the part of the generation that occurs when none of the panels are affected by the reflections.

Reflectors lead to an increased temperature, which results in decreased efficiency. The estimated increased temperature (ΔT) and the decreased efficiency per ΔT gives the decreased efficiency. In order to recommend and present a cost-effective energy system, based on solar panels, a few alternative systems have been designed and compared. The systems are designed by estimating the power consumption throughout the year and adapting the power generation to the load. The month with lowest values of insolation was used for dimensioning the generation, in order to cover the electricity demand for every month of the year. Attached reflectors were included in some of the alternatives to give conclusions if reflectors should be recommended to solar power systems. Some of the alternatives use a Maximal Power Point Tracker (MPPT) charge controller, while other uses a regular Pulse Width Modulations (PWM) controller. This gives a conclusion of which investment is preferred.

The dimensioning of the energy storage differs for the two cases. For the case of the internet café, the energy system mainly works as a backup system during power blackouts. The energy storage was dimensioned to cover the energy demand during one day with a generation at a low level. The low level is defined as the tenth lowest daily irradiation that occurs during one year of climate data. The dimensioning for the school case is based on the expected generation during a *single-day scenario* and a *five-day scenario*. The *single-day scenario* is the lowest expected daily irradiation from one year climate data and the *five-day scenario* is the lowest expected insolation during a period of five days. For the school facility the energy storage was dimensioned to cover the demand at all times, but some of the loads are allowed to be reduced during periods of low generation. This is regulated by reducing the lighting when the battery capacity reaches a level of 70 % and by turning off the charge of two third of the computers when the battery capacity reaches a level of 60 %. The consumption during periods of low generation is therefore dependent of the capacity of the energy storage, since the loads will be reduced at a certain capacity level. The required capacity is in its turn dependent of the consumption.

The expected annual generation and the supply of power, to the loads, during periods of low solar radiation, have been analysed and used as a value of performance for the alternative systems. In case of a period of low insolation, the alternative energy systems, designed for the school facility, will supply the loads with power during different periods of time. The Matlab calculations are used to calculate how long time the computers in the school can be fully used during the *five-day scenario*. This gives a value of performance for the alternative systems. Sensitivity analyses

were done to evaluate the robustness of the alternative systems. The robustness of the alternative systems is checked by calculating the Depth of Discharge (DOD) of the battery bank, during periods with low generation, when both the generation and the battery capacity are reduced with 20 %.

To see if the alternative systems, designed for the school facility, can withstand the *single-day scenario* and the *five-day scenario*, with a 20 % decreased insolation and a 20 % decreased battery capacity, the Matlab calculations was used. For the *single-day scenario* the required capacity was calculated, with the decreased insolation and reduced capacity. The result was compared with the capacity of the dimensioned energy storage. The expected DOD for the *five-day scenario*, with the decreased insolation and reduced capacity, was received directly from the Matlab calculations. For the economic point of view an investment analysis was done for both cases. The payoff time and the Net Present Value (NPV) were used. The economic and expected lifetime of the system affects the result. A lifetime of 25 years was used for the NPV calculation. The expected interest rate and future electricity price affect the results a lot. The investment analysis was done with interest rates of 10 and 20 % and with an increased electricity price of 5 or 10 % per year.

4. RESULTS

Pekanbaru city located in Riau Province continues to grow along with the economic progress, so it is estimated the growth of Pekanbaru City energy consumption will increase. In the assessment of a solar power source, the elevation angle is measured from the angular height of the sun from the horizontal position. Figure 5 shows a map of Pekanbaru city in Riau Province.



Figure 5. Map of Pekanbaru in Riau.

Both height and latitude is measured from sea level. 0 degree elevation occurs at sunrise and 90 degree elevation occurs at midday. The elevation angle varies daily and depends on the latitude of the location which happens every year. The most

important of the photovoltaic system parameters is the maximum elevation angle, which is the maximum angle on the horizon at every year. Table 1 shows total of energy generate from sun irradiance in Universitas Islam Riau.

Table 1. Total irradiance of energy

Month	POA irradiance beam after shading and soiling (kWh/mo)	POA irradiance beam nominal (kWh/mo)	POA irradiance total after shading and soiling (kWh/mo)	POA irradiance total nominal (kWh/mo)	PV array DC energy (kWh/mo)	System AC energy (kWh/mo)
Jan	291,891.0	310,201.0	1,105,210.0	1,185,240.0	141,523.0	134,856.0
Feb	257,792.0	302,909.0	1,024,700.0	1,079,370.0	131,471.0	124,026.0
Mar	470,827.0	496,397.0	1,355,180.0	1,427,100.0	171,904.0	161,980.0
Apr	522,494.0	549,994.0	1,399,630.0	1,474,190.0	177,423.0	166,438.0
May	830,770.0	874,405.0	1,751,120.0	1,844,280.0	217,771.0	201,057.0
Jun	729,188.0	767,567.0	1,632,260.0	1,719,130.0	207,482.0	191,094.0
Jul	609,959.0	652,600.0	1,755,750.0	1,850,200.0	221,139.0	204,299.0
Aug	851,714.0	928,120.0	1,800,750.0	1,895,540.0	228,181.0	209,284.0
Sep	820,977.0	864,185.0	1,682,650.0	1,772,170.0	213,616.0	196,184.0
Oct	746,300.0	785,673.0	1,625,290.0	1,711,800.0	205,724.0	190,814.0
Nov	519,566.0	546,933.0	1,366,530.0	1,425,800.0	173,579.0	164,030.0
Dec	252,588.0	276,407.0	1,075,930.0	1,134,410.0	141,288.0	134,228.0

Average annual irradiation long-term, there are two main sources data of solar resources, i.e. data derived from satellites and land-based measurement. Therefore both sources have advantages respectively, and then the selection of data sources will

depend on the location PLTS. Land-based location measurement can be used for calibrate data resources from other sources, such as satellites or stations meteorological, to improve accuracy and certainty. Figure 6

shows an estimate monthly potential energy generate by solar photovoltaic.

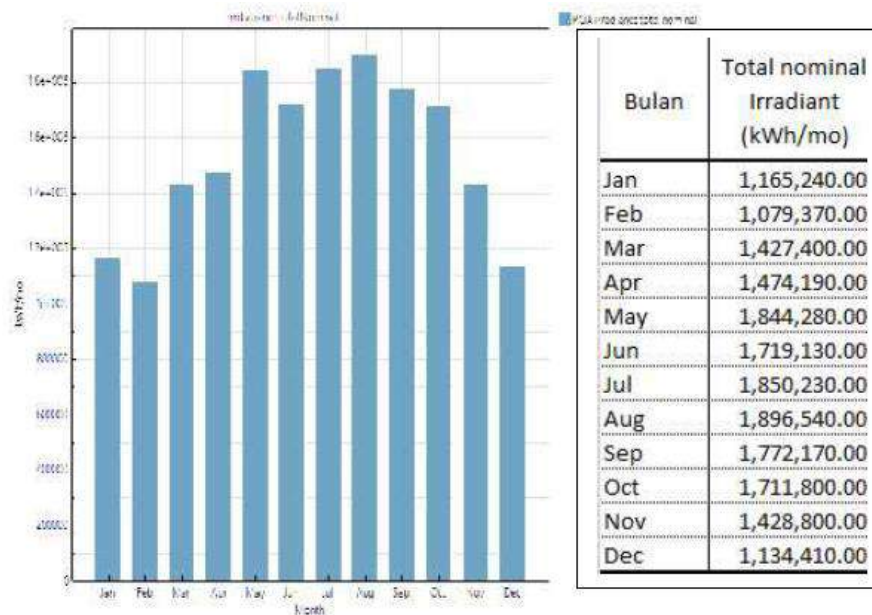

Figure 6. Estimated monthly graph of energy produced

In general, data for 10 years is needed to provide variations at the level reasonable belief. Data used in energy calculations sun for Photovoltaic Power Generation (PLTS) Universitas Islam Riau is the data coming from NASA NREL (National Renewable

Energy Laboratory) United States. These data sources have varying quality and resolution. It takes the right skills to interpret the data. Figure 7 shows estimated monthly energy loss due to inconsistence sun light

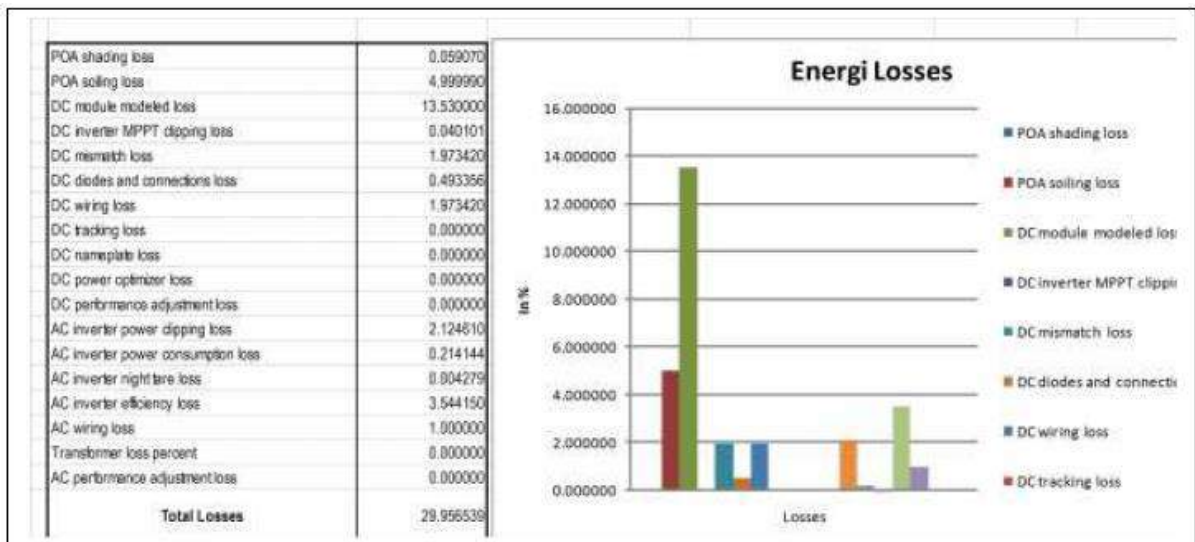

Figure 7. Estimated monthly energy losses

5. CONCLUSION

This feasibility study to find on how much power is able to generate using solar panel photovoltaic in Universitas Islam Riau as shown in results. In order to achieve power generation as much 1 Mega Watt (MW) then 2 hectare of land or empty area is required. Potential to generate as much 1 MW of electricity is benefit for University to reduce expenses or cost of monthly electricity billing, possibility of expand power generate by solar photovoltaic to share to other consumer such as resident, street lighting and other. The feasibility have been done based on environmental of Riau province especially in Pekanbaru City, some of number sun irradiance and duration of sub rise is calculated to achieve accurate data of potential power to generate.

REFERENCES

- [1] G. Papaefthymiou and D. Kurowicka, "Using copulas for modelling stochastic dependence in power system uncertainty analysis," *IEEE Trans. Power Syst.*, vol. 24, no. 1, pp. 40–49, Feb. 2009.
- [2] K. Xie, Y. Li, and W. Li, "Modelling wind speed dependence in system reliability assessment using copulas," *IET Renew. Power Gener.*, vol. 6, no. 6, pp. 392–399, Nov. 2012.
- [3] H. B. Azad, S. Mekhilef, and V. G. Ganapathy, "Long-term wind speed forecasting and general pattern recognition using neural networks," *IEEE Trans. Sustain. Energy*, vol. 5, no. 2, pp. 546–553, Apr. 2014.
- [4] S. S. Soman, H. Zareipour, O. Malik, and P. Mandal, "A review of wind power and wind speed forecasting methods with different time horizons," in *Proc. North Amer. Power Symp.*, Sep. 2010, pp. 1–8.
- [5] D. Lingfors and J. Widén, "Development and validation of a wide-area model of hourly aggregate solar power generation," *Energy*, vol. 102, pp. 559–566, 2016.
- [6] W. Wu, K. Wang, B. Han, G. Li, X. Jiang, and M. L. Crow, "A versatile probability model of photovoltaic generation using pair copula construction," *IEEE Trans. Sustain. Energy*, vol. 6, no. 4, pp. 1337–1345, Oct. 2015.
- [7] M. Larrañeta, S. Moreno-Tejera, M. Silva-Pérez, and I. Lillo-Bravo, "An improved model for the synthetic generation of high temporal resolution direct normal irradiation time series," *Sol. Energy*, vol. 122, pp. 517–528, 2015.
- [8] C.M. Fernández-Peruchena, M. Gastón, M. Sánchez, J. García-Barberena, M. Blanco, and A. Bernardos, "MUS: A multiscale stochastic model for generating plausible meteorological years designed for multiyear solar energy yield simulations," *Sol. Energy*, vol. 120, pp. 244–256, 2015.
- [9] J. Bright, C. Smith, P. Taylor, and R. Crook, "Stochastic generation of synthetic minutely irradiance time series derived from mean hourly weather observation data," *Sol. Energy*, vol. 115, pp. 229–242, 2015.
- [10] J. Ekström, M. Koivisto, I. Mellin, J. Millar, E. Saarijärvi, and L. Haarla, "Assessment of large scale wind power generation with new generation locations without measurement data," *Renew. Energy*, vol. 83, pp. 362–374, 2015.
- [11] J. Ekström, M. Koivisto, J. Millar, I. Mellin, and M. Lehtonen, "A statistical approach for hourly photovoltaic power generation modelling with generation locations without measured data," *Sol. Energy*, vol. 132, pp. 173–187, 2016.
- [12] M. Marinelli, P. Maule, A. N. Hahmann, O. Gehrke, P. B. Nørgård, and N. A. Cutululis, "Wind and photovoltaic large-scale regional models for hourly production evaluation," *IEEE Trans. Sustain.*

- Energy, vol. 6, no. 3, pp. 916–923, Jul. 2015.
- [13] P. E. Bett and H. E. Thornton, “The climatological relationships between wind and solar energy supply in Britain,” *Renew. Energy*, vol. 87 Part 1, pp. 96–110, 2016.
- [14] J. Widen, “Correlations between large-scale solar and wind power in a future scenario for Sweden,” *IEEE Trans. Sustain. Energy*, vol. 2, no. 2, pp. 177–184, Apr. 2011.
- [15] J. Vasilj, P. Sarajcev, and D. Jakus, “Estimating future balancing power requirements in wind–PV power system,” *Renew. Energy*, vol. 99, pp. 369–378, 2016.
- [16] M. Koivisto, J. Ekström, J. Seppänen, I. Mellin, J. Millar, and L. Haarla, “A statistical model for comparing future wind power scenarios with varying geographical distribution of installed generation capacity,” *Wind Energy*, vol. 19, pp. 665–679, May 2016.
- [17] M. Koivisto et al., “Wind speed modeling using a vector autoregressive process with a time-dependent intercept term,” *Int. J. Elect. Power Energy Syst.*, vol. 77, pp. 91–99, 2016.
- [18] D. Villanueva, A. Feijóo, and J. L. Pazos, “Simulation of correlated wind speed data for economic dispatch evaluation,” *IEEE Trans. Sustain. Energy*, vol. 3, no. 1, pp. 142–149, Jan. 2012.
- [19] D. C. Hill, D. McMillan, K. R. W. Bell, and D. Infield, “Application of autoregressive models to U.K. wind speed data for power system impact studies,” *IEEE Trans. Sustain. Energy*, vol. 3, no. 1, pp. 134–141, Jan. 2012.
- [20] H. Lütkepohl, *New Introduction to Multiple Time Series Analysis*, 2nd ed. Berlin, Germany: Springer-Verlag, 2007.
- [21] J. Hamilton, *Time Series Analysis*. Princeton, NJ, USA: Princeton Univ. Press, 1994.
- [22] D. A. Dickey and W. A. Fuller, “Likelihood ratio statistics for autoregressive time series with a unit root,” *Econometrica*, vol. 49, no. 4, pp. 1057–1072, 1981.
- [23] A. Harvey, *Time Series Models*. Rossendale, U.K.: Philip Allan, 1981.
- [24] G. Ljung and G. E. P. Box, “On a measure of lack of fit in time series models,” *Econometrica*, vol. 66, pp. 67–72, 1978.
- [25] B. Tammelin et al., “Production of the Finnish Wind Atlas,” *Wind Energy*, vol. 16, no. 1, pp. 19–35, 2013.
- [26] C. Rigollier, O. Bauer, and L. Wald, “On the clear sky model of the ESRA—European Solar Radiation Atlas—with respect to the heliosat method,” *Sol. Energy*, vol. 68, no. 1, pp. 33–48, 2000.
- [27] Solar radiation data (soda) service, Aug. 2016. [Online]. Available: <http://www.sodais.com/eng/services/>
- [28] Gamesa G128-5.0 MW Wind Turbine Data Sheet, Aug. 2016. [Online]. Available: <http://www.gamesacorp.com/recursos/doc/productos-servicios/aerogeneradores/catalogo-g10x-45mw-eng.pdf>
- [29] M. Mattei, G. Notton, C. Cristofari, M. Muselli, and P. Poggi, “Calculation of the polycrystalline PV module temperature using a simple method of energy balance,” *Renew. Energy*, vol. 31, no. 4, pp. 553–567, 2006.
- Aldous, S. *How Solar Cells Work*. Retrieved October, 2008, from <http://www.howstuffworks.com/solar-cell.htm>
- Ben Arnoldy. (2008). *Brighter Future for Solar Panels: Silicon Shortage Eases*. Retrieved 1/22, 2009, from <http://features.csmonitor.com/innovation/2008/06/05/brighter-future-for-solar-panels-silicon-shortage-eases/>
- CalFinder. *What is net metering?* Retrieved September, 2008, from

- <http://solar.calfinder.com/blog/solar-information/what-is-net-metering/>
- Charlie White. (2008). *Solar Cell Efficiency Reaches Breakthrough Cost per Watt*. Retrieved 1/14, 2009, from http://dvice.com/archives/2008/03/solar_cell_effi.php
- Code of Massachusetts Regulations. *Massachusetts Net Metering Laws*. <http://www.dsireusa.org/documents/Incentives/MA01R.htm>
- Commonwealth Solar. *Non-residential Rebate Calculator*. <http://www.masstech.org/SOLAR/Attachment%20A2-Non%20Residential%20Solar%20Rebate%20Calculator%20Only-070208.xls>
- Commonwealth Solar. *Overview*. Retrieved September, 2008, from <http://www.masstech.org/SOLAR/>
- Commonwealth Solar. (2008). *Solar Photovoltaic Rebates: Program Manual*. Retrieved September, 2008, from http://www.masstech.org/SOLAR/Commonwealth%20Solar%20Program%20Handbook_v2_070108.pdf
- Cooler Planet. (2008). *How Photovoltaic Cells Work*. Retrieved October, 2008, from <http://solar.coolerplanet.com/Content/Photovoltaic.aspx>
- Denis Lenardic. (2009). *Photovoltaic Applications and Technologies*. Retrieved 10/20, 2008, from www.pvresources.com
- DSIRE. *Massachusetts Incentives for Renewable Energy: Net Metering*. Retrieved November, 2008, from http://www.dsireusa.org/library/includes/incentive2.cfm?Incentive_Code=MA01R&State=MA&CurrentPageID=1
- DSIRE. *Massachusetts Incentives for Renewable Energy*. Retrieved November, 2008, from <http://www.dsireusa.org/documents/Incentives/MA01R.htm>
- Energy Information Administration. (2009). *Average Retail Prices of Electricity*. <http://www.eia.doe.gov/emeu/mer/prices.html>
- [1] abdul kadir evizal, “anteann theory,” *test*, vol. 1, no. 2, pp. 1–200.

SIMILARITY CLUSTER OF INDONESIAN ETHNIC LANGUAGES

Arbi Haza Nasution¹, Yohei Murakami², Toru Ishida³

^{1,3} Department of Social Informatics, Kyoto University, Japan

²Unit of Design, Kyoto University, Japan

Email: 1arbi@ai.soc.i.kyoto-u.ac.jp, 2yohei@i.kyoto-u.ac.jp, 3ishida@i.kyoto-u.ac.jp

Abstract

Lexicostatistic and language similarity clusters are useful for computational linguistic researches that depends on language similarity or cognate recognition. Nevertheless, there are no published lexicostatistic/language similarity cluster of Indonesian ethnic languages available. We formulate an approach of creating language similarity clusters by utilizing ASJP database to generate the language similarity matrix, then generate the hierarchical clusters with complete linkage and mean linkage clustering, and further extract two stable clusters with high language similarities. We introduced an extended k-means clustering semi-supervised learning to evaluate the stability level of the hierarchical stable clusters being grouped together despite of changing the number of cluster. The higher the number of the trial, the more likely we can distinctly find the two hierarchical stable clusters in the generated k-clusters. However, for all five experiments, the stability level of the two hierarchical stable clusters is the highest on 5 clusters. Therefore, we take the 5 clusters as the best clusters of Indonesian ethnic languages. Finally, we plot the generated 5 clusters to a geographical map.

Keywords: lexicostatistic, language similarity, hierarchical clustering, k-means clustering

1. INTRODUCTION

Nowadays, machine-readable bilingual dictionaries are being utilized in actual services (Ishida, 2011) to support intercultural collaboration (Ishida, 2016; Nasution et al., 2017c), but low-resource languages lack such sources. In order to save low-resource languages like Indonesian ethnic languages from language endangerment, prior works tried to enrich the basic language resource, i.e., bilingual dictionary (Wushoer et al., 2015; Nasution et al., 2016; Nasution et al., 2017a; Nasution et al., 2017b). Those previous researchers require lexicostatic/language similarity clusters of the low-resource languages to select the target languages. However, to the best of our knowledge, there are no published lexicostatic/language similarity clusters of Indonesian ethnic languages. To fill the void, we address this research goal:

- *Formulating an approach of creating a language similarity cluster.* We first obtain 40-item word lists from the Automated

Similarity Judgment Program (ASJP), further generate the language similarity matrix, then generate the hierarchical and k-means clusters, and finally plot the generated clusters to a map.

2. INDONESIAN ENDANGERED LANGUAGES

Indonesia has a population of 221,398,286 and 707 living languages which cover 57.8% of Austronesian Family and 30.7% of languages in Asia (Lewis et al., 2015). There are 341 Indonesian ethnic languages facing various degree of language endangerment (trouble / dying) where some of the native speaker do not speak Bahasa Indonesia well since they are in remote areas. Unfortunately, there are 13 Indonesian ethnic languages which already extinct. Figure 1 shows the level of development or endangerment of Indonesian ethnic languages. (Lewis et al., 2015)

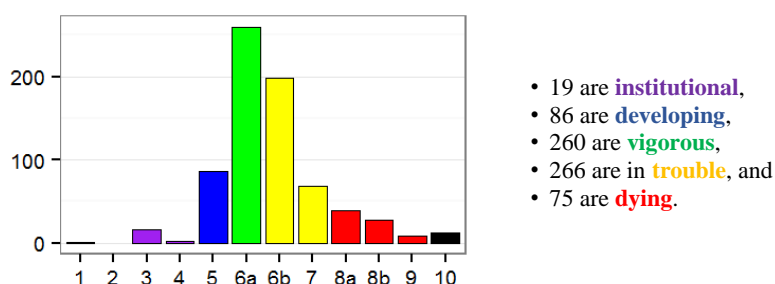

Figure 1. Indonesian Ethnic Languages Level of Development or Endangerment

Here are the definitions of each level of Development or Endangerment:

- *Institutional (EGIDS 0-4)* — The language has been developed to the point that it is used and sustained by institutions beyond the home and community.
 - Buginese (3 (Wider communication), 5,000,000), Javanese (4 (Educational), 84,300,000)
- *Developing (EGIDS 5)* — The language is in vigorous use, with literature in a standardized form being used by some though this is not yet widespread or sustainable.
 - Minangkabau (5 (Developing), 5,530,000), Bali (5 (Developing), 3,330,000)
- *Vigorous (EGIDS 6a)* — The language is unstandardized and in vigorous use among all generations.
 - Iranun (6a (Vigorous), 256,000), Batak Mandailing (6a (Vigorous), 1,100,000)
- *In trouble (EGIDS 6b-7)* — Intergenerational transmission is in the process of being broken, but the child-bearing generation can still use the language so it is possible that revitalization efforts could restore transmission of the language in the home.
 - Temuan (6b (Threatened), 22,700 (2008 JHEOA)), Tambunan Dusun (6b (Threatened), 15,600 (2000))
- *Dying (EGIDS 8a-9)* — The only fluent users (if any) are older than child-bearing age, so it is too late to restore natural intergenerational transmission through the home; a mechanism outside the home would need to be developed.
 - Nusa Laut (9 (Dormant), 2,230 (1989 SIL)), Ura (8b (Nearly extinct),

- *Extinct (EGIDS 10)* — The language has fallen completely out of use and no one retains a sense of ethnic identity associated with the language.
 - Kaniet (10 (Extinct)), Uruava (10 (Extinct))

3. AUTOMATED SIMILARITY JUDGMENT PROGRAM

Historical linguistics is the scientific study of language change over time in term of sound, analogical, lexical, morphological, syntactic, and semantic information (Campbell, 2013). Comparative linguistics is a branch of historical linguistics that is concerned with language comparison to determine historical relatedness and to construct language families (Lehmann, 2013). Many methods, techniques, and procedures have been utilized in investigating the potential distant genetic relationship of languages, including lexical comparison, sound correspondences, grammatical evidence, borrowing, semantic constraints, chance similarities, sound-meaning isomorphism, etc (Campbell, L. and Poser, W.J., 2008). The genetic relationship of languages is used to classify languages into language families. Closely-related languages are those that came from the same origin or proto-language, and belong to the same language family.

Swadesh List is a classic compilation of basic concepts for the purposes of historical-comparative linguistics. It is used in lexicostatistics (quantitative comparison of lexical cognates) and glottochronology (chronological relationship between languages). There are various version of swadesh list as shown in Table 1. To find the best size of the list, Swadesh states that "The only solution appears to be a drastic weeding out of the list, in the realization that quality is at least as important as quantity...Even the new list has defects, but they are relatively mild and few in number." (Swadesh, 1955)

Table 1. Modification of Swadesh List

Published Year	Number of Words
1950	225 (Swadesh, 1950)
1952	215 & 200 (Swadesh, 1952)
1971 & 1972	100 (Swadesh, 1971)

Table 2. Levenshtein Distance Algorithm

Step	Description
1	Set n to be the length of s. Set m to be the length of t. If n = 0, return m and exit. If m = 0, return n and exit. Construct a matrix containing 0..m rows and 0..n columns.
2	Initialize the first row to 0..n. Initialize the first column to 0..m
3	Examine each character of s (i from 1 to n).
4	Examine each character of t (j from 1 to m)
5	If s[i] equals t[j], the cost is 0. If s[i] doesn't equal t[j], the cost is 1.
6	Set cell d[i,j] of the matrix equal to the minimum of: a. The cell immediately above plus 1 : d[i-1, j] + 1 b. The cell immediately to the left plus 1 : d[i, j-1] + 1 c. The cell diagonally above and to the left plus the cost : d[i-1, j-1] + cost
7	After the iteration steps (3, 4, 5, 6) are complete, the distance is found in cell d[n, m]

A widely-used notion of string/lexical similarity is the edit distance or also known as Levenshtein Distance (LD): the minimum number of insertions, deletions, and substitutions required to transform one string into the other (Levenshtein, 1966). The Levenshtein Distance algorithm is shown in Table 2. For example, LD between "kitten" and "sitting" is 3 since there are three transformations needed: kitten

→ sitten (substitution of "s" for "k"), sitten → sittin (substitution of "i" for "e"), and finally sittin → sitting (insertion of "g" at the end). Another example between Indonesian word is LD between "satu" and "baru" is 2 since there are only two transformations needed: satu → batu (substitution of "b" for "s") and then batu → baru (substitution of "r" for "t") as shown in Figure 2.

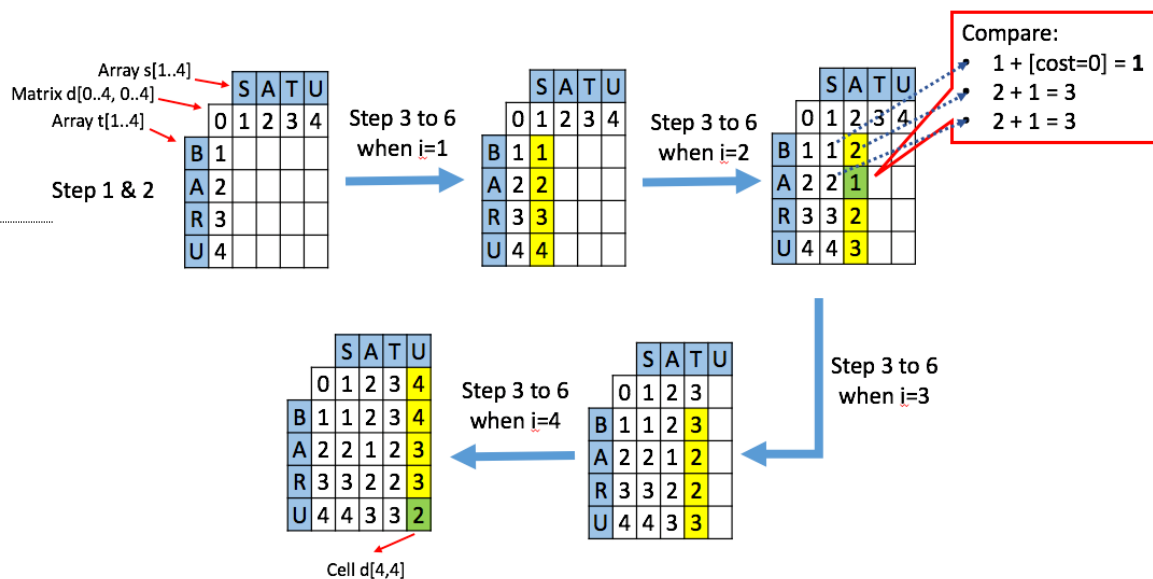

Figure 2. Example of transformations following Levenshtein Distance Algorithm

There are a lot of previous works using Levenshtein Distances such as dialect groupings of Irish Gaelic (Kessler, 1995) where they gather the data from questionnaire given to native speakers of Irish Gaelic in 86 sites. They obtain 312 different Gaelic words or phrases. Another work is about dialect pronunciation differences of 360 Dutch dialects (Heeringa, 2004) which obtain 125 words from Reeks Nederlandse Dialectatlassen. They normalize LD by dividing it by the length of the longer alignment. Tang (2015) measure linguistic similarity and intelligibility of 15 Chinese dialects and obtain 764 common syllabic units. Petroni (2008) define lexical distance between two words as the LD normalized by the number of characters of the longer of the two. Wichmann et al. (2010) extend Petroni definition as LDND and use it in Automated Similarity Judgment Program (ASJP).

The ASJP, an open source software was proposed by Holman et al. (2011) with the main goal of developing a database of Swadesh lists (Swadesh, 1955) for all of the world's languages from which lexical similarity or lexical distance matrix between languages can be obtained by

comparing the word lists. The classification is based on 100-item reference list of Swadesh (Swadesh, 1971) and further reduced to 40 most stable items (Holman et al., 2008). The item stability is a degree to which words for an item are retained over time and not replaced by another lexical item from the language itself or a borrowed element. Words resistant to replacement are more stable. Stable items have a greater tendency to yield cognates (words that have a common etymological origin) within groups of closely related languages.

4. LANGUAGE SIMILARITY CLUSTERING APPROACH

We formalize an approach to create language similarity clusters by utilizing ASJP database to generate the language similarity matrix, then generate the hierarchical clusters, and further extract the stable clusters with high language similarities. The hierarchical stable clusters are evaluated utilizing our extended k-means clustering. Finally, the obtained k-means clusters are plotted to a geographical map. The flowchart of the whole process is shown in Figure 3.

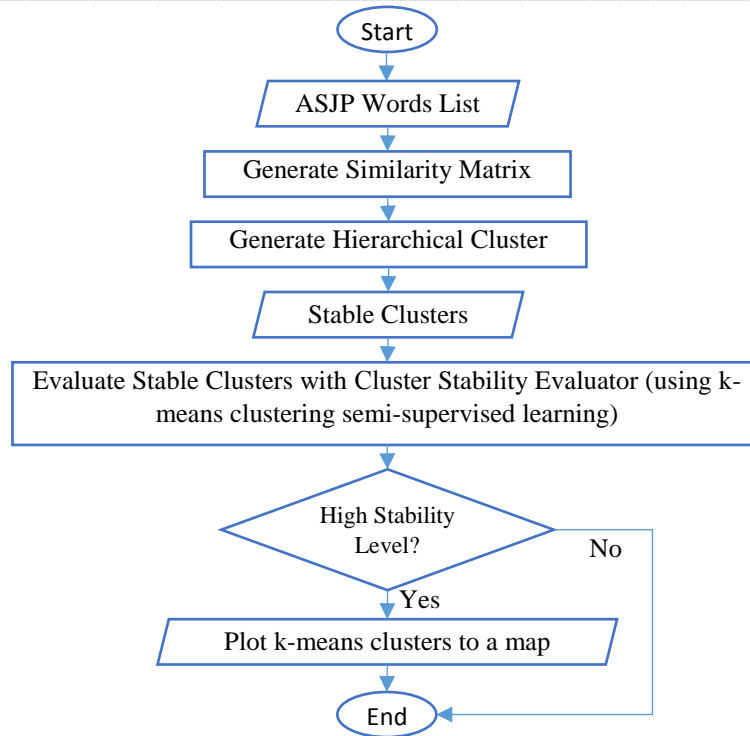

Figure 3. Flowchart of Generating Language Similarity Clusters

In this paper, we focus on Indonesian ethnic languages. We obtain words list of 119 Indonesian ethnic languages with the number of speakers at least 100,000. We further generate the similarity matrix ranked by the number of speakers as shown

in Figure 4. We added a white-red color scale where white color means the two languages are totally different (0% similarity) and the reddest color means the two languages are exactly the same (100% similarity).

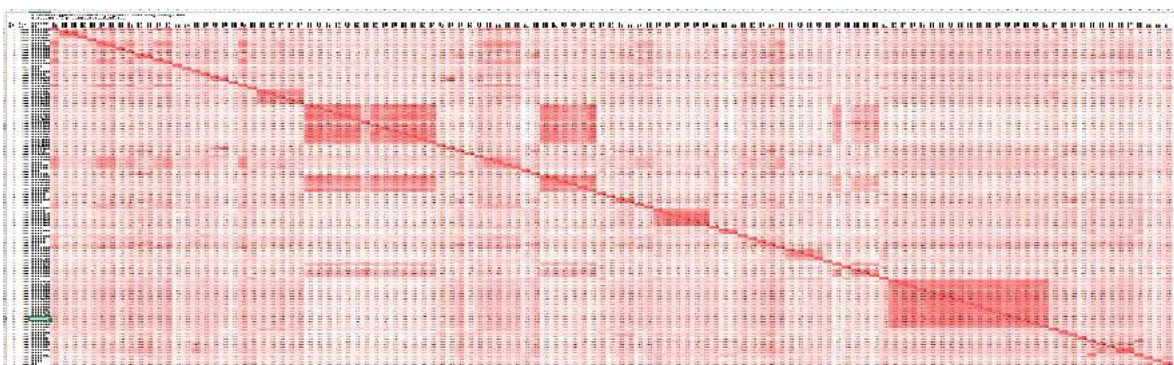

Figure 4. Language Similarity Matrix of 119 Indonesian Ethnic Languages

However, it is difficult to classify 119 languages and obtain a valuable information from the generated clusters, therefore, we further filtered the target languages based on the number of speaker and availability of the language information

in Wikipedia. We obtain 32 target languages as shown in Table 3 from the intersection between 46 Indonesian ethnic languages with number of speaker above 300,000 provided by Wikipedia and 119 Indonesian ethnic languages with number

of speaker above 100,000 provided by ASJP.

Table 3. List of 32 Indonesian Ethnic Languages Ranked by Population

Code	Ranked by Wikipedia	Ranked by AJSP	Population based on Wikipedia	Population based on AJSP	Language
L 1	1	1	21000000	232004800	INDONESIAN
L 2	3	2	84300000	84300000	OLD_OR_MIDDLE_JAVANESE
L 3	4	3	34000000	34000000	SUNDANESE
L 4	2	4	21000000	15848500	MALAY
L 5	7	5	3900000	15848500	PALEMBANG_MALAY
L 6	5	6	13600000	6770900	MADURESE
L 7	6	7	5500000	5530000	MINANGKABAU
L 8	8	8	3500000	5000000	BUGINESE
L 9	12	9	2700000	5000000	BETAWI
L 10	9	10	3500000	3502300	BANJARESE_MALAY
L 11	10	11	3500000	3500032	ACEH
L 12	11	12	3300000	3330000	BALI
L 13	16	13	1600000	2130000	MAKASAR
L 14	13	14	2700000	2100000	SASAK
L 15	14	15	2000000	2000000	TOBA_BATAK
L 16	17	16	1100000	1100000	BATAK_MANDAILING
L 17	18	17	1000000	1000000	GORONTALO
L 18	19	18	900000	1000000	JAMBI_MALAY
L 19	27	19	500000	900000	MANGGARAI
L 20	21	20	800000	770000	NIAS_NORTHERN
L 21	22	21	700000	750000	BATAK_ANGKOLA
L 22	24	22	600000	700000	UAB_METO
L 23	23	23	600000	600000	KARO_BATAK
L 24	25	24	500000	500000	BIMA
L 25	26	25	500000	470000	KOMERING
L 26	28	26	400000	350000	REJANG
L 27	32	27	300000	331000	TOLAKI
L 28	29	28	300000	300000	GAYO
L 29	30	29	300000	300000	MUNA
L 30	31	30	300000	250000	TAE
L 31	15	31	1900000	245020	AMBONESE_MALAY
L 32	20	32	900000	230000	MONGONDOW

We further generate the similarity matrix of those 32 languages as shown in Table 4. We also added a white-red color scale where white color means the two languages are totally different (0% similarity) and the reddest color means the two languages are

exactly the same (100% similarity). For a better clarity and to avoid redundancy, we only show the bottom-left part of the table. The headers follow the language code in Table 3

... of 32 Indonesian Ethnic Languages by ASJP (%)

	L1	L2	L3	L4	L5	L6	L7	L8	L9	L10	L11	L12	L13	L14	L15	L16	L17	L18	L19	L20	L21	L22	L23	L24	L25	L26	L27	L28	L29	L30	L31			
L2	24																																	
L3	39	22																																
L4	85	21	41																															
L5	68	32	39	73																														
L6	34	15	20	34	34																													
L7	62	25	31	62	64	34																												
L8	31	18	25	32	31	18	32																											
L9	69	10	25	67	58	23	50	24																										
L10	72	33	39	71	64	34	60	33	55																									
L11	27	11	19	27	30	22	25	16	21	25																								
L12	38	20	29	35	39	23	31	30	24	37	22																							
L13	33	22	24	30	32	25	33	36	25	33	16	29																						
L14	44	20	28	42	44	30	44	31	37	47	22	29	35																					
L15	37	24	23	37	36	21	40	25	35	37	13	21	25	35																				
L16	25	16	14	27	27	20	27	23	24	25	14	20	18	24	24																			
L17	19	14	16	18	19	9	18	20	14	17	12	12	18	20	17	9																		
L18	79	26	40	78	78	34	69	31	70	73	27	35	38	46	39	21	20																	
L19	30	18	24	30	34	19	32	36	26	32	10	23	29	31	32	21	16	34																
L20	26	21	17	23	25	13	29	26	24	29	12	16	19	24	29	21	19	24	25															
L21	24	16	15	26	26	19	26	21	21	24	12	21	18	23	59	98	9	20	19	20														
L22	13	10	9	11	14	12	18	19	10	19	10	12	21	18	15	9	14	15	22	16	9													
L23	47	22	28	48	50	23	40	30	40	44	21	32	27	35	51	40	17	47	28	33	40	12												
L24	18	10	16	17	18	12	18	21	18	19	6	14	21	25	22	14	8	17	30	19	14	18	19											
L25	33	19	25	33	33	18	25	23	29	36	14	23	22	22	24	24	16	30	26	29	25	20	36	14										
L26	28	20	16	27	32	18	30	17	21	29	15	17	17	30	25	20	11	32	18	15	19	12	29	4	19									
L27	30	14	18	28	27	17	26	32	23	33	11	21	27	21	26	14	11	28	36	25	14	19	28	26	20	13								
L28	37	27	28	36	37	20	37	26	28	38	18	25	23	35	28	18	17	40	26	23	17	20	41	18	37	29	28							
L29	14	12	12	14	13	13	11	21	18	12	8	16	24	14	14	9	11	13	15	15	10	11	14	21	14	4	29	11						
L30	42	29	31	41	39	27	42	60	30	47	20	28	42	40	34	27	23	44	38	35	26	29	38	30	29	21	38	38	25					
L31	72	23	35	70	58	37	59	36	62	60	23	34	36	43	33	28	19	69	33	29	26	17	36	19	29	24	29	31	16	42				
L32	30	18	24	32	31	13	26	26	27	34	11	21	25	24	24	17	26	32	23	24	17	12	28	14	24	20	20	27	15	38				
L33																																		

Hierarchical clustering is an approach which builds a hierarchy from the bottom-up, and does not require us to specify the number of clusters beforehand. The algorithm works as follows:

- Put each data point in its own cluster
- Identify the closest two clusters and combine them into one cluster
- Repeat the above step until all the data points are in a single cluster

Once this is done, it is usually represented by a dendrogram like structure. There are a few ways to determine how close two clusters are:

- ✓ Complete linkage clustering: Find the maximum possible distance between points belonging to two different clusters.
- ✓ Single linkage clustering: Find the minimum possible distance between points belonging to two different clusters.
- ✓ Mean/Average linkage clustering: Find all possible pairwise distances for points belonging to two different clusters and then calculate the average.
- ✓ Centroid linkage clustering: Find the centroid of each cluster and calculate the distance between centroids of two clusters.

Complete linkage and mean (average) linkage clustering are the ones used most often. We generate the distance matrix from the similarity matrix shown in Table 4 and further generate the hierarchical clusters

with `hclust` function with a complete linkage clustering method as shown in Figure 5 and a mean linkage clustering method as shown in Figure 6 using R, a free software environment for statistical computing and graphics.

From those two hierarchical clusters in Figure 5 and Figure 6, we select two stable clusters that always grouped together despite of changing the linkage clustering method. The first cluster consists of TOBA_BATAK, BATAK_MANDAILING, and BATAK_ANGKOLA, while the second cluster consists of MINANGKABAU, BETAWI, AMBONESE_MALAY, BANJARESE_MALAY, PALEMBANG_MALAY, JAMBI_MALAY, MALAY, and Indonesia. Since the two stable clusters have language similarities above 50% between the languages, they are good clusters to be referred when selecting target languages for computational linguistic researches that depends on language similarity or cognate recognition for inducing bilingual lexicons from the target languages (Mann, G.S., and Yarowsky, D., 2001; Wushouer et al., 2015; Nasution et al., 2016; Nasution et al., 2017a). The two clusters are actually enough for selecting the target languages for those researches. However, we still need to evaluate the stability of those clusters and we also need to identify the low language similarities clusters in order to grasp the whole picture of Indonesian ethnic languages. Thus, we utilize the alternative clustering approach which is a k-means clustering.

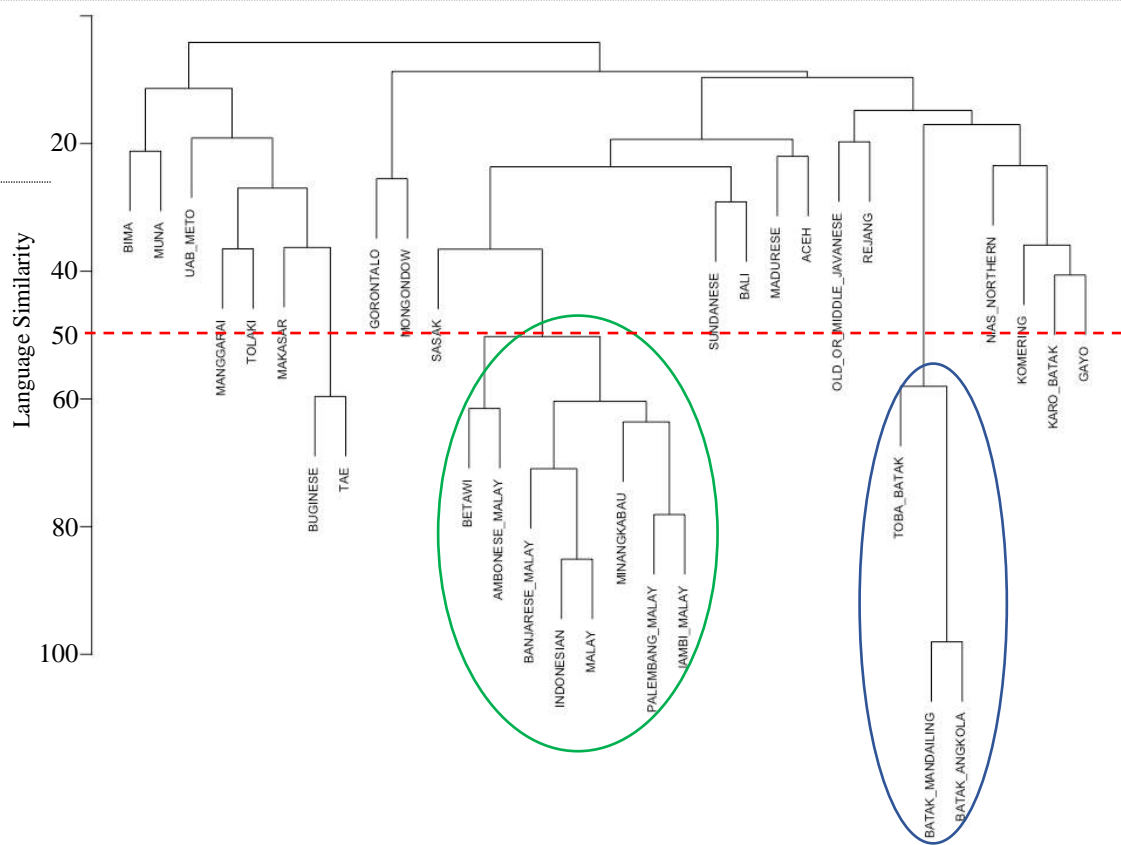

Figure 5. Hierarchical Clusters Dendrogram of 32 Indonesian Ethnic Languages – method: complete

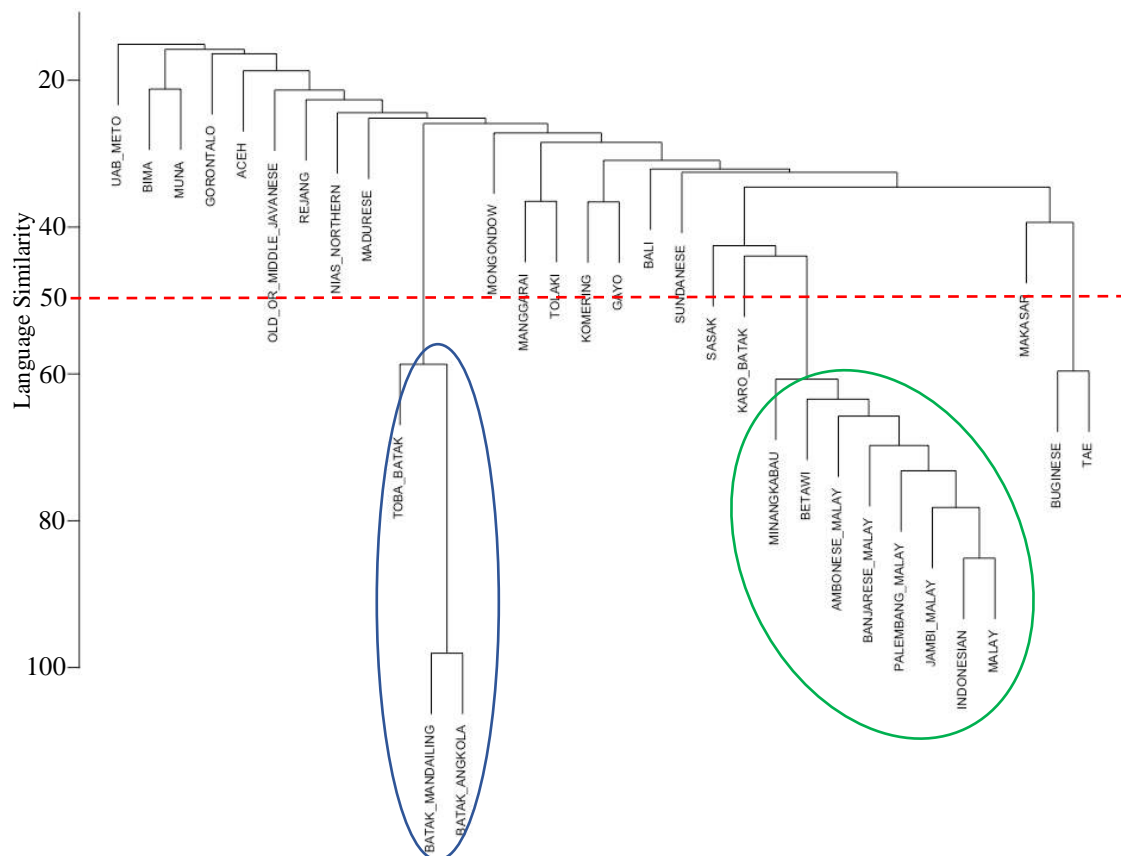

Figure 6. Hierarchical Clusters Dendrogram of 32 Indonesian Ethnic Languages – method: average

K-means clustering is an unsupervised learning algorithm that tries to cluster data based on their similarity. Unsupervised learning means that there is no outcome to be predicted, and the algorithm just tries to find patterns in the data. In k-means clustering, we have to specify the number of clusters we want the data to be grouped into. The algorithm works as follows:

- The algorithm randomly assigns each observation to a cluster, and finds the centroid of each cluster.
- Then, the algorithm iterates through two steps:
 - Reassign data points to the cluster whose centroid is closest.
 - Calculate new centroid of each cluster.

These two steps are repeated until the within cluster variation cannot be reduced any

further. The within cluster variation is calculated as the sum of the euclidean distance between the data points and their respective cluster centroids.

It is well known that standard agglomerative hierarchical clustering techniques are not tolerant to noise (Nagy, 1968; Narasimhan et al., 2006). There are many previous works on finding clusters which robust to noise (Guha et al., 1999; Langfelder, P., & Horvath, S., 2012; Balcan et al., 2014). However, to evaluate the stability of the hierarchical stable clusters, we introduced a simple approach of calculating their stability level of being grouped together despite of changing the number of k-means clusters. We extend the k-means clustering unsupervised learning to a k-means clustering semi-supervised learning by labeling the two hierarchical stable clusters beforehand.

ALGORITHM 1: Cluster Stability Evaluator

Input: *similarity_matrix, stable_clusters, minimum_k, maximum_trial*

Output: *stability_level*

trial ← 1

current_k ← *minimum_k*

maximum_k ← *length(similarity_matrix)*

scale2D ← *cmdscales(similarity_matrix)* //multidimensional to 2D scaling

while *current_k* ≤ *maximum_k*, **do**

successful_trial ← 0 // initialized for each *current_k*

while *trial* ≤ *maximum_trial*, **do**

k-clusters ← *kmeans(scale2D, current_k)*

if *stable_clusters* distinctly found in *k-clusters*, **then**

successful_trial++

trial++ // try again with the same number of cluster (*current_k*)

end

stability_level[current_k] = *successful_trial* / *maximum_trial*

current_k++ // increase the number of clusters

trial = 1 // reset the number of trial

end

return *stability_level*

Initially, we manually conduct several trials to estimate the minimum and maximum number of k-means cluster to obtain clusters which consist of the stable clusters distinctly. Based on the initial trials, we estimate the $minimum_k = 4$ and $maximum_k = 21$. Then, we calculate the stability level of the two hierarchical stable clusters where the number of clusters ranging from $minimum_k = 4$ to

$maximum_k = 21$ following Algorithm 1. We have five sets of experiments with the $maximum_trial$ equals 50, 500, 5,000, 50,000, and 500,000. In each experiment, a stability level of the two hierarchical stable clusters is measured for each number of k-means clusters by calculating the success rate of obtaining the two hierarchical stable clusters in the generated k -clusters as shown in Figure 7 to 11.

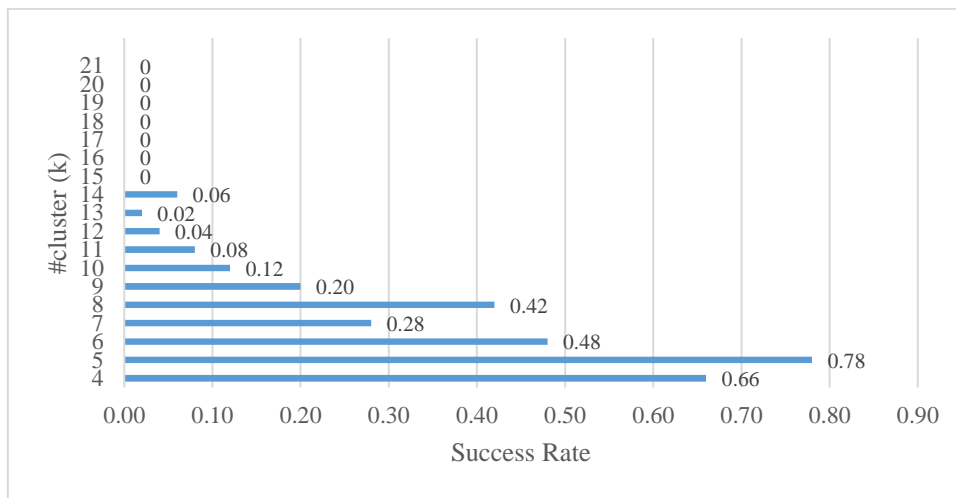

Figure 7. Obtaining Stable Clusters in 50 Trials

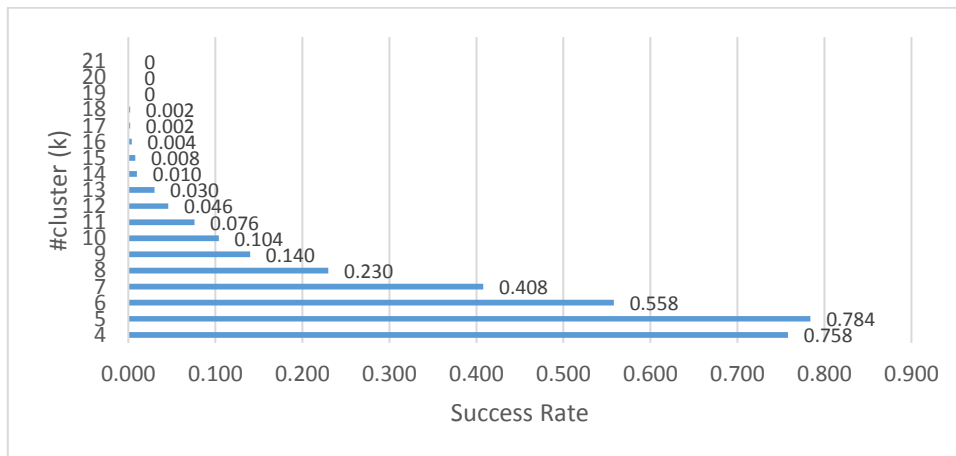

Figure 8. Obtaining Stable Clusters in 500 Trials

The higher the number of the trial, the more likely we can distinctly find the two hierarchical stable clusters in the generated k -clusters with a big number of clusters. For example, within 50 trials, we can not find the two hierarchical stable clusters distinctly in the generated k -clusters for big number of clusters ($k > 14$). However, within

50,000 and 500,000 trials, we can find the two hierarchical stable clusters distinctly in the generated k -clusters for all number of clusters between the $minimum_k = 4$ and the $maximum_k = 21$, even though the success rate is getting lower as the number of clusters increases. For all five experiments, the stability level of the two hierarchical

stable clusters is the highest (0.78) on 5 clusters.

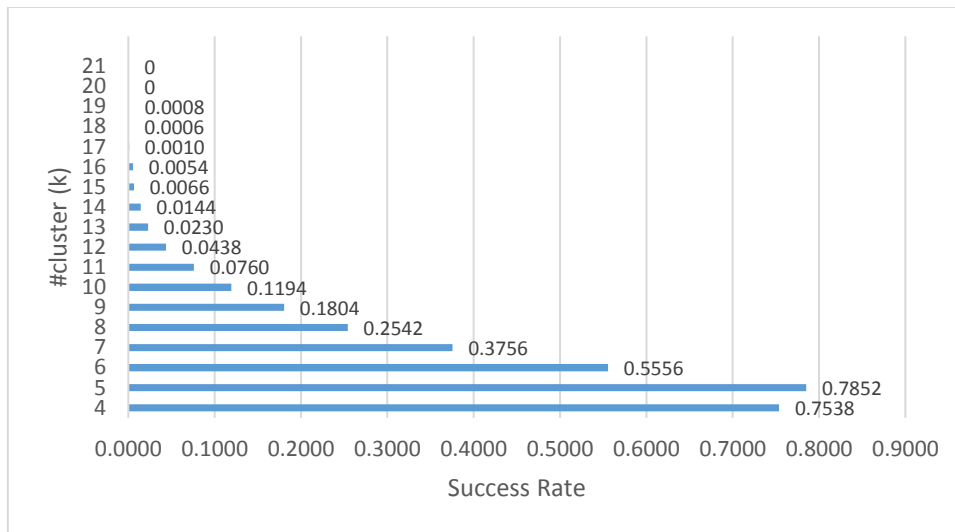

Figure 9. Obtaining Stable Clusters in 5,000 Trials

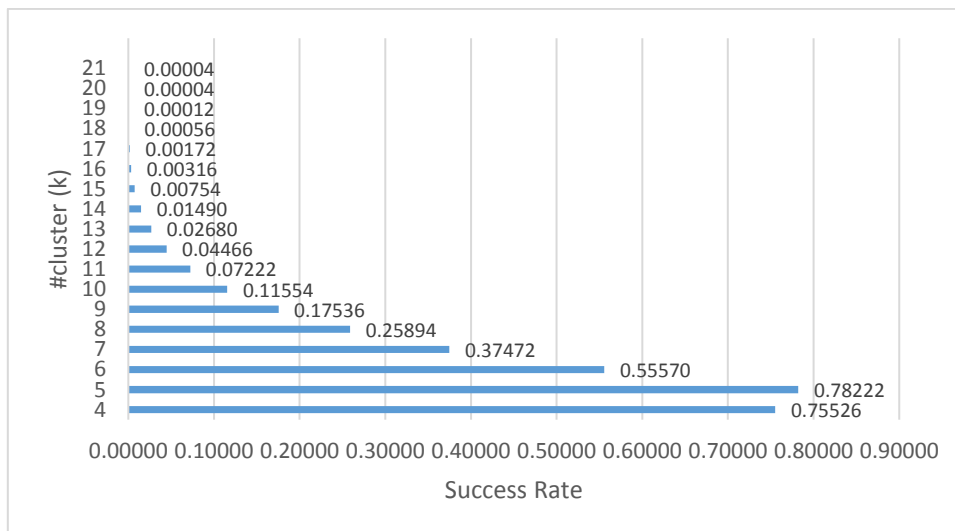

Figure 10. Obtaining Stable Clusters in 50,000 Trials

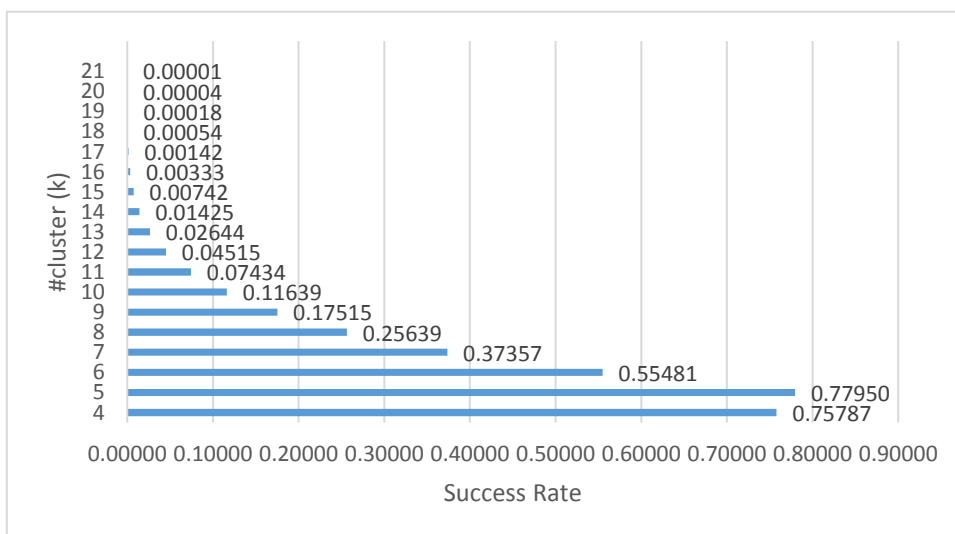

Figure 11. Obtaining Stable Clusters in 500,000 Trials

Therefore, we take the 5 clusters as shown in Figure 12 as the best clusters of Indonesian ethnic languages to be referred when selecting target languages for

computational linguistic researches that depends on language similarity or cognate recognition. We further plot the 5 clusters to a geographical map as shown in Figure 13.

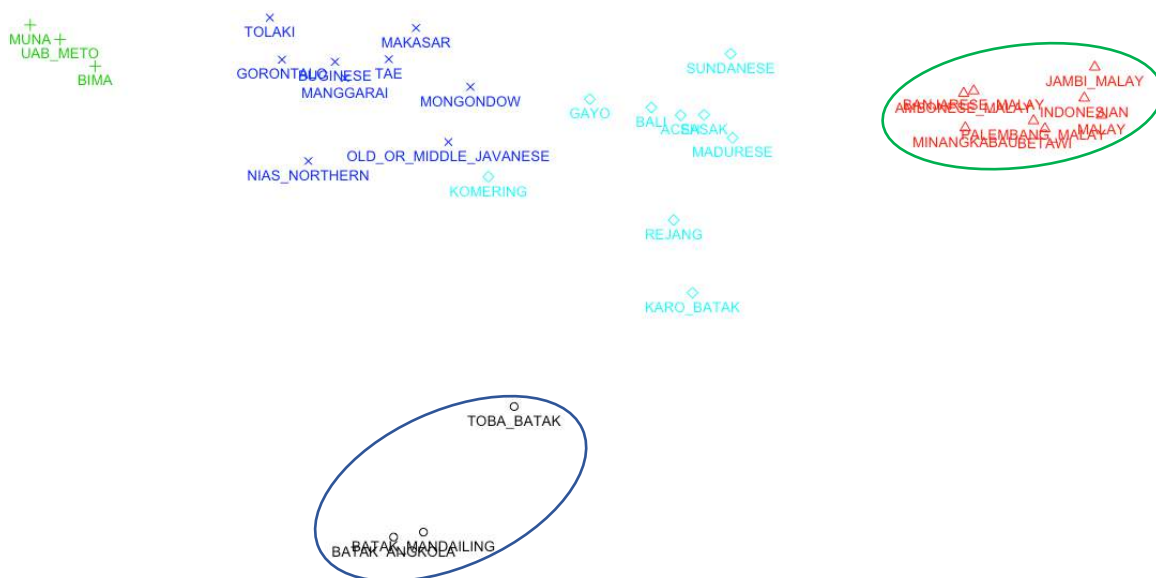

Figure 12. K-means Clusters of 32 Indonesian Ethnic Languages – 5 Clusters



Figure 13. Similarity Clusters Map of 32 Indonesian Ethnic Languages – 5 Clusters

4. CONCLUSION

We utilized ASJP database to generate the language similarity matrix, then generate the hierarchical clusters with complete linkage and mean linkage clustering, and further extract two stable clusters with the highest language similarities. We apply our

extended k-means clustering semi-supervised learning to evaluate the stability level of the hierarchical stable clusters being grouped together despite of changing the number of clusters. The higher the number of the trial, the more likely we can distinctly find the two hierarchical stable

clusters in the generated *k*-clusters. However, for all five experiments, the stability level of the two hierarchical stable clusters is the highest (0.78) on 5 clusters. Therefore, we take the 5 clusters as the best clusters of Indonesian ethnic languages to be referred to select target languages for computational linguistic researches that depends on language similarity or cognate recognition. Finally, we plot the generated 5 clusters to a geographical map. Our algorithm can be used to find and evaluate other stable clusters of Indonesian ethnic languages or other language sets.

ACKNOWLEDGMENT

This research was partially supported by a Grant-in-Aid for Scientific Research (A) (17H00759, 2017-2020) and a Grant-in-Aid for Young Scientists (A) (17H04706, 2017-2020) from Japan Society for the Promotion of Science (JSPS). The first author was supported by Indonesia Endowment Fund for Education (LPDP).

BIBLIOGRAPHY

- Balcan, M. F., Liang, Y., & Gupta, P. (2014). Robust hierarchical clustering. *The Journal of Machine Learning Research*, 15(1), 3831-3871.
- Campbell, L. (2013). *Historical Linguistics*. Edinburgh University Press.
- Campbell, L. and Poser, W.J. (2008). *Language classification. History and method*. Cambridge.
- Guha, S., Rastogi, R., & Shim, K. (1999, March). ROCK: A robust clustering algorithm for categorical attributes. In *Data Engineering, 1999. Proceedings., 15th International Conference on* (pp. 512-521). IEEE.
- Holman, E.W., Brown, C.H., Wichmann, S., Müller, A., Velupillai, V., Hammarström, H., Sauppe, S., Jung, H., Bakker, D., Brown, P., and others. (2011). Automated dating of the world's language families based on lexical similarity. *Current Anthropology* 52, 6 (2011), 841–875.
- Holman, E. W., Wichmann, S., Brown, C. H., Velupillai, V., Müller, A., & Bakker, D. (2008). Explorations in automated language classification. *Folia Linguistica*, 42(3-4), 331-354.
- Ishida, T. editor. (2011). *The Language Grid: Service-Oriented Collective Intelligence for Language Resource Interoperability*. Springer Publishing Company, Incorporated.
- Ishida, T. (2016). Intercultural collaboration and support systems: A brief history. In *International Conference on Principles and Practice of Multi-Agent Systems (PRIMA 2016)*, pages 3–19. Springer.
- Langfelder, P., & Horvath, S. (2012). Fast R functions for robust correlations and hierarchical clustering. *Journal of statistical software*, 46(11).
- Lehmann, W.P. (2013). *Historical linguistics: an introduction*. Routledge.
- Levenshtein, V. I. (1966). Binary codes capable of correcting deletions, insertions, and reversals. In *Soviet physics doklady* (Vol. 10, No. 8, pp. 707-710).
- Lewis, M. Paul, Gary F. Simons, and Charles D. Fennig (eds.) (2015). *Ethnologue: Languages of the World, Eighteenth edition*. Dallas, Texas: SIL International. Online version: <http://www.ethnologue.com>
- Mann, G.S., and Yarowsky, D. (2001). Multipath translation lexicon induction via bridge languages. In *Proceedings of the second meeting of the North American Chapter of the Association for Computational Linguistics on Language technologies*. Association for Computational Linguistics, 1–8.
- Nagy, G. (1968). State of the art in pattern recognition. *Proceedings of the IEEE*.
- Narasimhan, M., Jojic N., and Bilmes, J. (2006). Q-clustering. *Advances in Neural Information Processing Systems*.

- Nasution, A. H., Murakami, Y., and Ishida, T. (2016). Constraint-based bilingual lexicon induction for closely related languages. In Proceedings of the Tenth International Conference on Language Resources and Evaluation (LREC 2016), pages 3291–3298, Paris, France, May.
- Nasution, A. H., Murakami, Y., and Ishida, T. (2017a). A generalized constraint approach to bilingual dictionary induction for low-resource language families. *ACM Trans. Asian Low-Resour. Lang. Inf. Process.*, 17(1):1–29, September.
- Nasution, A. H., Murakami, Y., and Ishida, T. (2017b). Plan optimization for creating bilingual dictionaries of low-resource languages. In 2017 International Conference on Culture and Computing (Culture Computing), Sep.
- Nasution, A. H., Syafitri, N., Setiawan, P. R., and Suryani, D. (2017c). Pivot-based hybrid machine translation to support multilingual communication. In 2017 International Conference on Culture and Computing (Culture Computing), Sep.
- Swadesh, Morris. (1950). Salish Internal Relationships. *International Journal of American Linguistics*, Vol. 16, 157–167
- Swadesh, Morris. (1952). Lexicostatistic Dating of Prehistoric Ethnic Contacts. Proceedings of the American Philosophical Society, Vol. 96, 452–463.
- Swadesh, Morris. (1955). Towards Greater Accuracy in Lexicostatistic Dating. *International Journal of American Linguistics*, Vol. 21, 121–137.
- Swadesh, Morris. (1971). The Origin and Diversification of Language. Ed. post mortem by Joel Sherzer. Chicago: Aldine, p. 283.
- Tang, C., & van Heuven, V. J. (2015). Predicting mutual intelligibility of Chinese dialects from multiple objective linguistic distance measures. *Linguistics*, 53(2), 285–312.
- Wichmann, S., Holman, E. W., Bakker, D., & Brown, C. H. (2010). Evaluating linguistic distance measures. *Physica A: Statistical Mechanics and its Applications*, 389(17), 3632–3639.
- Wushouer, M., Lin, D., Ishida, T., and Hirayama, K. (2015). A constraint approach to pivot-based bilingual dictionary induction. *ACM Trans. Asian Low-Resour. Lang. Inf. Process.*, 15(1):4:1–4:26, November.

EFFICIENCY ANALYSIS OF RUBBER PRODUCTION FACTOR IN REGENCY OF KAMPARRIAU PROVINCE

Heriyanto

*Faculty of Agriculture, Universitas Islam Riau Jl. Kaharuddin Nasution, Marpoyan,
Pekanbaru 28284 Riau, Indonesia*

Email : heriyanto@agr.uir.ac.id

Abstract

Kampar regency is one of the districts in Riau province which contributes significantly to the economy in Riau Province, especially in the agricultural sector in the plantation sector. Rubber plantations are a source of prosperity, progress, independence, and pride of Kampar district government. Plantation management at present still relies on and relies on the abundance of human resources are relatively cheap. Efficiency, productivity, quality, sustainability are still low. This study aims to analyze the efficiency of rubber production in Kampar regency by building multiple linear regression model and production efficiency analysis. The results showed that the dominant factors affecting rubber production in Kampar Regency were number of plants, plant age, number of labor and investment. The factors of production are the number of plants, and the amount of labor is not technically efficient, allocative, and economical. The use of fertilizers tends to be technically and economically efficient, but allocatively inefficient. In order to obtain optimal production, this study recommends the need for rejuvenation of old or damaged rubber plants using superior seeds and maintained in accordance with the standards of rubber cultivation techniques. The efficient use of labor can be achieved by applying a rubber tapping system appropriately tailored to the conditions of the plant and the price of rubber. In addition, the use of balanced fertilizers in accordance with the recommended should be applied.

Keywords: *Dominant Factors, Technical Efficiency, Allocative Efficiency, Economic Efficiency*

INTRODUCTION

The agricultural sector in Indonesia is divided into five subsectors, namely food agriculture sub-sector, estate sub-sector, forestry sub-sector, livestock sub-sector and fishery sub-sector. The agricultural sector is continually required to play a role in the national economy through the formation of Gross Domestic Product (GDP), foreign exchange gain, food supply and industrial raw materials, poverty alleviation, employment and income generation.

The value of Gross Domestic Product (GDP) of agricultural, livestock, forestry and fishery products at 2000 constant prices amounted to 304,777.1 billion rupiahs in 2010 and 339,890.2 billion rupiahs in 2013 or an increase of 10.33 percent. While the role of agriculture sector to Indonesia's GDP in 2013 fell from 13.17 percent to 12.89 percent. The role of agriculture sector to GDP is ranked second after the management industry sector is

26.83 percent. (Badan Pusat Statistik Indonesia, 2014).

The contribution of the agricultural sector to the total value of GDP of Riau Province ADHK-DM in 2010 has an increasingly fluctuating trend. In 2010, the contribution of the agricultural sector to the total value of GRDP of ADHK-DM Province was 17.08%, increasing to 17.73% in 2014. During the period 2010 - 2014, the average growth of agricultural sector contribution increased by 0.75% per year. Where the agricultural sector ranked second only to the mining sector. GRDP for Kampar District from agriculture was 29.95 percent in 2009 and 28.91 percent in 2013 or decreased by 0.70 percent. Where the agricultural sector in kampar district ranks second after the mining sector. Thus seen that the agricultural sector is able to contribute significantly to PDRB Kampar regency.

At the Kampar regency level is not much different from the provincial level. In 2013 the largest area of plantation crops is occupied by oil palm plantation with an area of 190,486 Ha. While the rubber plant is in second with 92,509 Ha and Gambir plant is in third with 4,817 Ha. In the period of 2009-2012 the area of rubber plantation decreased. In 2009 the total area of rubber plant is 91,328 Ha and in 2012 the total area of rubber plant becomes 91,143 Ha. But not so with the production of rubber plants, where in the year 2009 to 2012 rubber production has increased from 46,656 tons to 61,040 tons. Whereas in 2012 until 2013

there was a tendency of increasing rubber plantation area to 92,609 ha and a decrease of rubber production to 60,714 tons (BPS Kabupaten Kampar, 2014). The decline in the area of rubber plantation is suspected due to the conversion of rubber land to palm oil which is considered easier in the company and has a higher economy.

Rubber plantations in Kampar regency are dominated by smallholder rubber plantations. Observing the results of smallholder productivity with low productivity of smallholder rubber based on data from Kampar District Plantation Office is only 0.78 tons / ha / year, caused by factors such as: (1) the majority of farmers have not used rubber planting material of superior clones grafting) and has not yet applied the standard of cultivation and maintenance of rubber plantation as well as recommended post-harvest technology, (2) there is a large old rubber garden area that needs to be rejuvenated soon. These factors affect each other. This factor becomes a determinant as well as a barrier to production, especially in rural areas so that rural communities, especially rubber farmers who have problems in their efforts to boost production.

Based on the above study in general this study was conducted with the aim to analyze the efficiency of rubber production in Kampar regency. Specifically aimed at analyzing the dominant factors affecting rubber production, analyzing technical efficiency, allocative efficiency and economic efficiency of rubber

METHODOLOGY

This research was conducted in Kampar Regency, using multy stage purposive sampling method with the criteria of 1-3 ha with the age of 13-25 years old. Samples were taken in 3 sub-districts, namely Kampar Kiri Hulu, Kampar Kiri Hilir and XIII Koto Kampar sub-districts, because the three districts are rubber production centers in Kampar regency.

Each sub-district took as many as 20 rubber farmers and a total sample of 60 rubber farmers.

Methods of data analysis in this study using Cobb-Douglas production function. The Cobb-Douglas function is a function or equation involving two or more variables. Mathematically, the Cobb-

Douglas function can be written as follows (Koutsoyiannis, 1997; Soekartawi, 2003):

$$Y = b_0 X_1^{b_1} X_2^{b_2} X_3^{b_3} X_4^{b_4} X_5^{b_5} e^u$$

Where:

Y = Number of rubber production (Kg / hectare / year)

X1 = Number of Plants (Tree / hectare / year)

X2 = Age of plant (hectare / year)

X3 = The amount of fertilizer (Kg / hectare / year)

X4 = Amount of labor (HKP / Hectare / year)

X5 = Investment (Rp / hectare / year)

b0 = Intercept

b1 ... b5 = Parameter of factors of production to be expected

e = Natural logarithm, e = 2,718

u = Pitfalls

The equation will be converted into multiple linear form to facilitate the calculation by using natural logarithmic transformation, the parameter is determined by using the *Ordinary Least Square (OLS)* method so that the equation becomes as follows:

$$\ln Y = \ln b_0 + b_1 \ln X_1 + b_2 \ln X_2 + b_3 \ln X_3 + b_4 \ln X_4 + b_5 \ln X_5 + u$$

Expected alpha parameters (Hypothesis) b1, b2, b3, b5 > 0 and b4 < 0.

In order to provide econometrically valid results it is necessary to test some econometric assumptions which include the detection of normality, multicollinearity, heteroscedasticity and autocorrelation of the equations in the regression model (Gujarati, 2003, Thomas, 1997; Verbeek et al., 2000).

Furthermore, after testing the econometric assumptions, production efficiency analysis is performed. In the terminology of economics suggests that efficiency can be classified into 3 (three) kinds, namely allocative efficiency,

RESULT AND DISCUSSION

Result of estimation model of rubber production factor in this research is very good as where seen from coefficient of determination (R²) that is 0,9470. This shows that 94.70 percent of the number of

technical efficiency, and economic efficiency. A production is said to achieve an allocative efficiency when the Marginal Product Value (MPV) equals the price of the factor of production. The Value of Marginal Product (MPV) is the addition of revenue received due to the additional use of the input unit. Mathematically can be written as follows (Soekartawi, 2003):

$$MPV_x = P_x \text{ atau } \frac{NPM_x}{P_x} = 1$$

Technical efficiency is the amount that shows the ratio between actual production and maximum production. Calculation of technical efficiency is done by calculating Marginal Physical Product (MPP) from each production factor. MPP is derived from the first derivative of the production function :

$$Y = b_0 \cdot X_1^{b_1} \cdot X_2^{b_2} \cdot X_3^{b_3} \cdot X_4^{b_4} \cdot X_5^{b_5}$$

$$MPP = \frac{dY}{dX} = b_0 \cdot b_1 \cdot X_1^{b_1-1} \cdot X_2^{b_2} \cdot X_3^{b_3} \cdot X_4^{b_4} \cdot X_5^{b_5}$$

Technical efficiency is achieved when MPP = 0. If MPP > 0, then the use of production input is not technically efficient, and if MPP < 0, it means the use of input is technically inefficient. The Economic efficiency is a quantity that shows the comparison between actual profit and maximum profit. Mathematically, the relationship between technical efficiency, allocative efficiency and economic efficiency are as follows (Soekartawi, 2003):

$$EE = TE \times AE$$

Where: EE = Economic Efficiency

TE = Technical Efficiency

AE = Allocative Efficiency

Thus, if TE and EA are known, then EE can also be calculated. The quantities of $TE \leq 1$, $AE \leq 1$, and EE do not always have to be less or equal to one..

production variables can be explained by the number of plants, the number of labor, the use of fertilizer, the age of plants, and working capital. While 5.30 percent is influenced by other variables that are not included in the model. This variation is significant at a real 1 percent level seen

from F arithmetic of 312.69 and probability <0.0001.

The result of normality test using Shapiro-Wilk statistic shows that the result of Shapiro-Wilk statistic calculation for rubber production is 0.88. The value is significant at a real 1 percent level. The multicollinearity test of VIF values for all independent variables (number of plants, plant age, amount of labor, use of fertilizers, and investment) has a value less than 10. The result of heteroscedasticity test shows a Breusch-pagan statistic of 7.77, the value is different with zero at 5 percent real level.

The value of Durbin-Watson (DW) in the built model is 2.064, at n = 60 and k = 6 from the DW distribution table with 1 percent real level obtained dL value of 1,808 and du 2,192. This indicates that the data is normalized, does not occur multicollinearity, does not occur heteroskedasticity and there is no autocorrelation.

The dominant factor affecting rubber production can be seen from the estimation of the model of the use of rubber production factors in Table 1 below

Table 1. Results of model estimation of the use of production factors of smallholder rubber farming in Kampar regency

Variabel	Parameter Estimate	Standard Error	t Value	Pr > t	Variance Inflation
Intercept	-0.88355	1.13016	-0.78	0.4378	0
Number of plants	0.88329	0.06079	14.53	<.0001	3.17175
Age of the plant	-0.11708	0.06370	-1.84	0.0716	1.39693
Amount of labor	0.14117	0.06030	2.34	0.0229	1.11531
The amount of fertilizer	0.00221	0.00508	0.43	0.6659	1.11590
Investment	0.23692	0.08901	2.66	0.0102	2.85166

Based on the estimation result of model in Table 1 it is known that there are four variables that have real effect on the production of smallholder rubber, that is the number of plants, plant age, labor, and investment. While the amount of fertilizer has no significant effect on the production of smallholder rubber in Kabupten kampar.

The coefficient of the number of plants has a positive sign that is 0.88329 which means that every 1 percent increase in the number of plants will increase the amount of production by 0.88329 percent, vice versa, any 1 percent reduction in the number of plants, will decrease the amount of production by 0.88329 percent with the assumption that other factors of production remain. This indicates that the number of plants responsive to rubber production, so it can give an idea that the number of plants is the factor of production of the greatest influence in determining the amount of rubber production. Based on this the farmers can still increase the number of cultivated rubber plants because each additional input will increase output. This is similar to the study Agustina at all (2016).

The result of the estimation can show that the data of plant age negatively affect the amount of rubber production and significantly different with zero at the real level of 10 percent so that hypothesis H0 accepted and hopotesis Haditolak. This means that if the age of the plant increases then the amount of production will be reduced. The coefficient of plant age has a negative sign that is -0.11708 which means that every 1 percent increase in plant life will decrease the amount of production by 0.11708 percent. Thus it can be concluded that if there is a decline in rubber production due to old age the rubber plant is time to be rejuvenated.

The coefficient of labor has a positive sign that is 0.14117 which means that every 1% increase in labor will increase the production amount of 0.14117%, and vice versa, 1% reduction of labor will decrease the production amount by 0, 14117 percent assuming other production factors remain. The effect of the use of labor on production is positive so that it can increase rubber production by increasing the use of labor without reducing the use of other production factors. The largest allocation of working time of farmers in farming is harvest labor. The greater the allocation of harvest work, the production (yield) tends to increase. This is similar to the study Rizal (2014), Ronal. S at all (2014), Yarna Hasian (2015), Gede at all (2015), Reni at all (2014), Silvira at all (2013), Felicia at all (2014), Lidya at all (2015), Shelvi at all (2014), Susilawati at all (2015), Stulov (2016), Reny at all (2014) dan Ongki at all (2015).

The coefficient of investment has a positive sign to production of 0.23692 which means that every 1 percent increase in working capital will increase the amount of production by 0.23692 percent, and vice versa, any 1 percent reduction in investment will decrease the production amount of 0, 23692 percent assuming other factors of production remain. This indicates that the effect of investment on rubber production is responsive to this matter with the study Desi (2015).

Production Efficiency

Soekartawi (2003) in the terminology of economics argues that efficiency can be classified into 3 (three) kinds, namely allocative efficiency, technical efficiency, and economic efficiency. Analysis results Technical efficiency, allocative efficiency or price and economic efficiency can be seen in table 2.

Table 2. Results of Technical Efficiency Analysis, Allocative Efficiency and Economic Efficiency

Variabel	Technical Efficiency	Allocative Efficiency	Economic Efficiency
Number of plants	-21.92*	-3.06*	66.98*
Amount of labor	-8.03*	-3.15*	25.27*
The amount of fertilizer	-0.13***	-0.31*	0.04***

Description: * Inefficient; ** not yet efficient; *** already efficient

The result of technical efficiency calculation shows that the value of technical efficiency of the number of plants, and labor of respectively -21.92, and -8.03. These values are <0 (small from zero), meaning that the use of plant quantity factors, labor and fertilizers is not technically efficient. Therefore it is necessary to add the use of factor of plant number, labor and fertilizer. While the value of technical efficiency for plant age factor is 150.78, the value is >0 (large from zero), meaning the plant's age factor is not technically efficient. It is therefore necessary to rejuvenate the old / damaged plants. Meanwhile, the value of technical efficiency of fertilizer use and investment = 0 (equal to zero), meaning that the use of fertilizer and investment is technically efficient.

The value of the allocative efficiency for the factor of the number of plants, labor, and the use of fertilizer, respectively is -3.06, -3.15, -0.31, the values are <1 (small of one), meaning that the amount factor plants, the amount of labor and the use of inocially inefficient fertilizers, thus reducing the use of production factors.

The result of the economic efficiency calculation shows that the number of plant and labor is 66,98 and 25,27, the value is >0 (big from zero), meaning the use of plant quantity factor and the amount of labor is not economically efficient. Therefore, it is necessary to increase the use of the number of plants and the number of workers. While the result of economic efficiency for fertilizer use factor is 0,04, the value is = 0 (equal to

zero), meaning that fertilizer is economically efficient.

5. CONCLUSION

The dominant factors affecting rubber production in Kampar regency are number of plants, plant age, number of labor and investment. All the statistically significant different factors had a positive effect except the age of the plant. Furthermore, the use of factors of production, in particular the number of plants and the number of labor, is not technically efficient, allocative, and economical. The use of fertilizers (dominated by urea fertilizers) uses tend to be technically and economically efficient, but alocatively inefficient.

The policy implications for optimizing rubber production in Kampar District are: First The use of the number of crops in smallholder rubber farming in Kampar Regency is known to be responsive to production and has not yet reached technically and economically efficient condition, therefore to optimize rubber production the farmers can still increase the use the number of plants. The average use of the number of smallholder rubber plantations in Kampar Regency is 431 stems / hectare, while to obtain optimal results, the recommended rubber planting distance from the Kampar Regency plantation is 6 x 3 meters or the total population of about 550 trees / hectare. Both the ages of the rubber plant have many old and damaged, therefore need to be rejuvenated rubber plant. Rejuvenation of rubber using superior seeds and maintained in accordance with the

standards of cultivation techniques is believed to be able to increase the productivity of rubber produced. Thirdly, to obtain a more optimal production and efficient use of labor, it is necessary to apply the appropriate rubber tapping system adapted to the condition of the plant and the price of rubber.

REFERENCES

- Agustina Pasaribu, Djaimi Bakce, Novia Dewi (2016). Analisis Efisiensi Produksi Usahatani Kelapa di Kecamatan Keritang Kabupaten Indragiri Hilir. *Jurnal Online Mahasiswa (JOM) Bidang Pertanian* Vol 3, No 1:1-11, Februari 2016.
- Badan Pusat Statistik. 2014. *Statistik Indonesia*. Biro Pusat Statistik, Jakarta.
- Badan Pusat Statistik. 2014. *Riau Dalam Angka 2014*. Badan Pusat Statistik Provinsi Riau, Pekanbaru.
- Badan Pusat Statistik. 2013. *Riau Dalam Angka 2013*. Badan Pusat Statistik Provinsi Riau, Pekanbaru.
- Badan Pusat Statistik. 2014. *Kampar Dalam Angka 2014*. Badan Pusat Statistik Kabupaten Kampar, Bangkinang.
- Badan Pusat Statistik. 2013. *Kampar Dalam Angka 2013*. Badan Pusat Statistik Kabupaten Kampar, Bangkinang.
- Desi Apriani Damanik (2015). Analisis Faktor-Faktor Yang Mempengaruhi Produksi Teh (Studi Kasus: PTPN IV Bahbutong, Kec. Sidamanik, Kab. Simalungun Sumatera Utara). *Jurnal Online Mahasiswa (JOM) Bidang Ilmu Ekonomi* Vol 2, No 2:1-15, Oktober 2015.
- Didit, H dan Adus, A. 2005. *Petunjuk Lengkap Budidaya Karet*. PTAgroMedia Pustaka, Jakarta.
- Direktorat Jendral Perkebunan Kementerian Pertanian. 2013. *Pedoman Teknis Pengembangan Tanaman Karet tahun 2014*, Jakarta.
- Felicia Marisa Sinabariba, Fembriarti Erry Prasmatiwi dan Suriaty Situmorang (2014). Analisis Efisiensi Produksi Dan Pendapatan Usahatani Kacang Tanah di Kecamatan Terbanggi Besar Kabupaten Lampung Tengah. *Jurnal Ilmu-Ilmu Agribisnis Universitas Lampung* Vol 2, No 4 :316-322, Oktober 2014.
- Gede Wegananda ajar Sangurjana, IWayan Widyantara dan Ida Ayu Listia Dewi (2016). Efektivitas dan Efisiensi Penggunaan Faktor Produksi Usahatani Cabai Besar di Desa Baturiti Kecamatan Baturiti Tabanan. *E-journal Agribisnis dan Agrowisata Universitas Udayana* Vol.5 No.1:1-11, Januari 2016.
- Gujarati, D, 2003. *Basic Econometrics*. Fourth Edition. International. Edition Mc Graw-Hill, Singapore:.
- Hanke, J. E., A. G. Reitsch, and D. W. Wichern. 2001. *Business Forecasting*. Seventh Edition. Prentice-Hall, Inc. Upper Saddle River, New Jersey.
- Hair, J.F. JR, R. E. Rolph, R. L. Tatham, and W. C. Black. *Multivariate Data Analysis*. Prentice-Hall International, Inc., New Jersey.
- Koutsoyiannis, A. 1977. *Theory of Econometrics*. Harper and Row Publisher Inc, New York.
- Ongki Fermadi, Fembriarti Erry Prasmatiwi, Eka Kasymir (2015). Analisis Efisiensi Produksi Dan Keuntungan Usahatani Jagung di Kabupaten Ogan Komering Ulu Timur Sumatera Selatan. *Jurnal Ilmu-Ilmu Agribisnis Universitas Lampung* Vol 3, No 1 :107-113, Januari 2015.
- Reni Ismawati, Cepriadi, Roza Yulida (2014). Analisis Faktor Produksi Terhadap Produksi Semangka (Citrullus Vulgaris, Scard) di Kecamatan

- Tampam Kota Pekanbaru. *Jurnal Online Mahasiswa (JOM) Bidang Pertanian* Vol 1, No 1:1-14, Februari 2014.
- Reny Novianty Sinaga, Dian Wijayanto dan Dardiyatno (2014). Analisis Pengaruh Faktor Produksi Terhadap Pendapatan dan Volume Nelayan Cantrang di Pelabuhan Perikanan Nusantara. *Journal of Fisheries Resources Utilization Management and Technology* Vol 3, No.2:85-93.
- Rizal R (2014). Analisis Efisiensi Penggunaan Input Produksi Usahatani Padi sawah di Desa Toribulu Kecamatan Toribulu Kabupaten Parigi Moutong. *Journal Agroland Universitas Tadulako* Vol.1 No.1 :29-36, April 2014.
- Ronal Simorangkir, max Nur Alam dan Abdul Muis (2014). Analisis Efisiensi Penggunaan Input Produksi Usahatani Jagung Manis di Desa Maku Kecamatan Dolo Kabupaten Sigi. *Journal Agroland Universitas Tadulako* Vol.21 No.1:37-44, April 2014.
- Salvatore, D. 2011. *Managerial Economics dalam Pekonomian Global*. Erlangga, Jakarta.
- Shelvi Sriyanti, Suardi Tarumun dan Yusmini (2014). Analytic of Production Factors Towards Updown Farming Enterprise Productivity Sungai Beringin Village Tembilahan Sub District Indragiri Hilir Regency. *Jurnal Online Mahasiswa (JOM) Bidang Pertanian* Vol 1, No 1:1-12, Februari 2014.
- Silvira, Hasman Hasyim dan Lily Fauzia (2013). Analisis Faktor-faktor yang mempengaruhi Produksi Padi Sawah (Studi Kasus: Desa Medang, Kecamatan Medang Deras Kabupaten Batu Bara). *Journal On Social Economic of Agriculture And Agribusiness* Vol 2, No 4:1-12, 4 April 2013.
- Soekartawi. 1990. *Teori Ekonomi Produksi dengan Pokok Bahasan Analisis Fungsi Cobb-Douglas*. PT. Raja Grafindo Persada, Malang.
- Soekartawi. 2003. *Teori Ekonomi Produksi; Pokok Bahasan Analisis Fungsi Cobb-Douglas*, Cetakan Ketiga, PT. Raja Grafindo Persada, Jakarta.
- Susilawati, Sugeng Yudiono dan Suyatno (2015). Analisis efisiensi alokatif Faktor-Faktor Produksi Usahatani Jagung Hibrida Di Kawasan Usaha Agribisnis Terpadu (Kuat) Rasau Jaya Komplek Kabupaten Kubu Raya. *Jurnal Social Economic of Agriculture* Vol 4, No 2:88-102, Desember 2015.
- Stulov. V.V (2016). Increase in Production Efficiency Due to the Use of Modernized Rubber Processing Rollers. *Journal of Machinery Manufacture and Reliability*, 2016, Vol. 45, No. 1: 78–82, Maret 2016.
- Pindyck, R. S. and D. L. Rubinfeld. 1991. *Econometric Models and Economic Forecasts*. Third Edition. McGraw-Hill Inc, New York.
- Thomas, R.L. 1997. *Modern Econometrics an Introduction*. Addison Wesley Longman, Harlow.
- Verbeek, M., KU Leuven, and Tilburg University. 2000. *A Guide to Modrn Econometrics*. Jonh Wiley and Sons Ltd., Chichester.
- Widarjono, A. 2009. *Ekonometrika Pengantar dan Aplikasi untuk Ekonomi dan Bisnis*. Ekonisia, Jakarta.
- Yarna Hasiani (2015). Efisiensi Faktor-faktor Produksi Usaha Pembesaran Ikan Nila Dalam Karamba Jaring aapung di Kabupaten Banjar. *Journal EnviroScienteeae* Vo.11 No.3:187-192, November 2015

DETERMINING SLIDERS POSITION BY USING PYTHAGORAS PRINCIPLE OF 3-DOF LINEAR DELTA ROBOT

Nur Khamdi¹, Muhammad Imam Muthahhar²

^{1,2}Department of Mechatronics, Politeknik Caltex Riau, Riau, Indonesia

Email: khamdi@pcr.ac.id¹ imam@alumni.pcr.ac.id²

Abstract

Linear delta robot is a type of parallel robot, which consists of three arms linked together in parallel with the center joint as the end effector. Delta robot has a 3-DOF for XYZ translation. This paper present an another way from inverse kinematics to determine three sliders Z-axis position using the Pythagoras principle and supported by Computer Aided Design (CAD).

Keywords: *Delta Robot, Pythagoras, Computer Aided Design*

1. INTRODUCTION

Delta or Parallel robot was designed by Reymond Clavel in 1988. In 1999, Dr. Clavel is presented with the Golden Robot Award, sponsored by ABB Flexible Automation Innovation for his work on the Delta robot [1]. Similarly, the robot manipulator generally like SCARA, Cartesian, and Articulated robots, that are Serial-link robot robot, Delta robot is also part of manipulator robot. The fundamental difference of Delta robot with Serial-link robot is on the construction, which the delta robot is kind of Parallel-link robot.

The advantages of manipulator robot that based of Parallel-link compare with Serial-link is on acceleration, stiffness, low inertia and high precision, and faster in operation in a cycle. This is because the actuators on the robot is separated in a fixed position to the moving mechanical system, thus create a faster movement with low

inertia, unlike the serial-link robot which the actuator has each connection/link so that when the robot manifold series is in motion, the burden not only on the mass of construction, but also the mass of own actuator that the results is slower movement. In [2], the author describes inverse kinematics analysis to determine position of three linear sliders. In this paper present an extended method by using pythagoras principle to determine Z-axis position of three linear sliders.

2. METHODOLOGY

In this paper, the method to determine Z-position of three sliders by using pythagoras principle. The XY-position of end effector is determined by using cartesian coordinat system. As despicted in Fig.1, hypotenuse is length of the arm (a), and the other side is height of slider/Z-position (b) and horizontal distance from spherical joint of end-effector to the slider that on fixed-base (c).

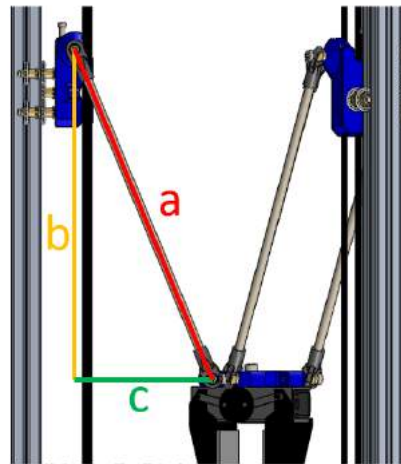

Fig. 1 Right triangle projection of slider-end effector connections

Length of the arm that can be set manually depend on the dimensions of the robot. The

origin $O(0,0)$ is located at one of poles of robot platform (P1) as shown in Fig.2.

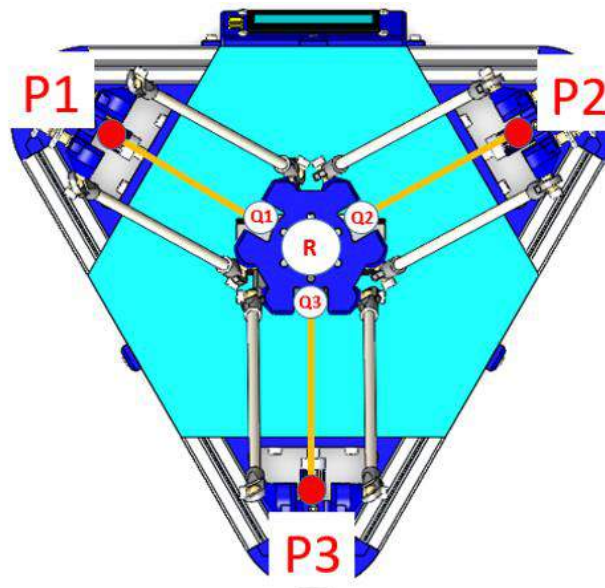

Fig. 2 Top view of Delta robot's workspace with poles and end-effector

There are several steps calculations before determining the Z-axis position of the sliders. First determine the XY coordinates of each point that required in the delta robot. Next determine the horizontal distance of spherical joint of the end-effector (Q_n) to the origin (P_n). The detail procedure to obtain horizontal distance of Q_n to P_n is using XY-coordinate, determine of resultant from the X-Y distance by using the Pythagoras equation. The resultant is a minimum distance of Q_n to P_n . After a minimum

distance Q_n-P_n is obtained, then determine the height of all the sliders position / Z-axis position also using Pythagoras equation. Z-position can be obtained if horizontal distance and length of arm is known.

A. Determining the XY Coordinates at The Required Point

Determine the XY coordinates of each point are required depending on the mechanic size of the robot to be made. However, it can also be done using CAD design using *AutoCAD*

software as a sketcher for robot concept to determine the XY coordinates. For example

that depicted in Fig. 3 sketching isosceles triangle using CAD

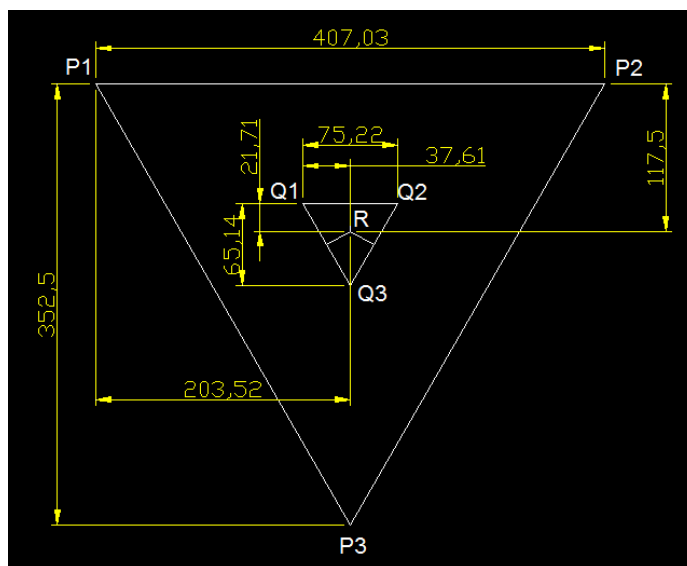

Fig. 3 Sketch and dimensions of fix-platform and moving platforms (end-effector)

As seen in Fig. 3, P1 is origin O, Q1 is the origin O' and R is the midpoint of the moving

platform. The data of sketch dimension that can be taken from Fig. 3 as shown in Table 1.

Table 1. Example for Coordinates of X and Y axis for points from origin

Point	X	Y
P1	0	0
P2	407,03	0
P3	203,52	-352,5
Q1 (from O')	0	0
Q2 (from O')	75,22	0
Q3 (from O')	37,61	-65,14
R (from O')	37,61	-21,71
R	203,52	-117,5

Coordinates of points being determined is useful for obtaining the resultant or minimum horizontal distance of Q1-P1, P2-Q2 and Q3-P3.

B. Determining Resultant Distance of Point Q to P

Determining resultant Q-P using Pythagoras equation where the resultant is hypotenuse, while 2 other side is the distance XY coordinates of Q-P as shown in Fig.4. So before determining the resultant Q-P, the distance of Q-P in XY coordinates should be determined first

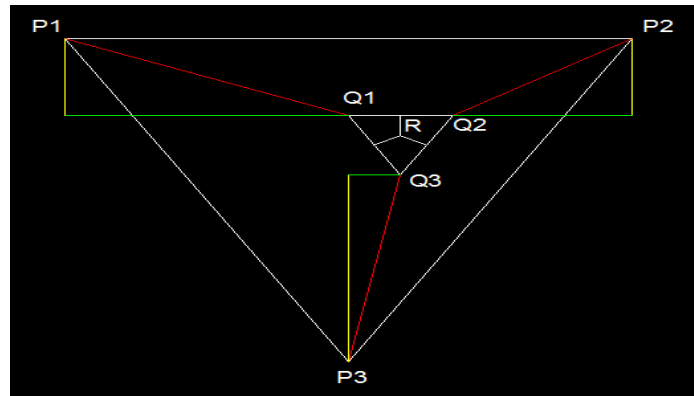

Fig. 4 The resultant line and both perpendicular lines

In Fig. 4 Hypotenuse is a red line, green line is the line of X-axis and yellow line is the line Y-axis. To determine the XY distance from Q1-P1 is requiring R points from origin and distance of R-Q1, in which:

$$Q1P1 = R - RQ1 \quad (1)$$

If using data in Table 1, Q1-P1 distance can be obtained on the X and Y-axis as:

$$Q1P1_x = (203,52 + X) - 37,61 \quad (2)$$

$$Q1P1_y = (-117,5 + Y) - (-21,71)$$

(3)

Variable of X and Y are the desired distances position on End-effector (point R). From equations 2 and 3, resultant value of Q1-P1 can be determined with Pythagoras equation:

$$Q1P1_{res} = \sqrt{Q1P1_x^2 + Q1P1_y^2} \quad (4)$$

As for determining the XY distance of Q2-P2 using equation:

$$Q2P2_x = P2 - Q1P1_x - Q1Q2_x \quad (5)$$

$$= 407,03 - Q1P1_x - 75,22$$

$$= 331,81 - Q1P1_x$$

$$Q2P2_y = Q1P1_y$$

(6)

The Y-axis coordinate value of Q2-P2 is equal to Q1-P1 because the points are always in parallel.

From equation 5 and 6, resultant value of Q2-P2 can be determined with Pythagoras equation:

$$Q2P2_{res} = \sqrt{Q2P2_x^2 + Q2P2_y^2} \quad (7)$$

To determine the XY distance of Q3-P3 with equation:

$$Q3P3 = P3 - Q1P1 - Q1Q3 \quad (8)$$

If using data in Table 1, Q3-P3 distance can be obtained on the X and Y-axis as:

$$Q3P3_x = 203,52 - Q1P1_x - 37,61 = 165,91 - Q1P1_x \quad (9)$$

$$Q3P3_y = (-352,5) - Q1P1_y - (-65,14) = (-287,36) - Q1P1_y$$

(10)

From equations 9 and 10, resultant value of Q3-P3 can be determined with Pythagoras equation:

$$Q3P3_{res} = \sqrt{Q3P3_x^2 + Q3P3_y^2} \quad (11)$$

C. Determining Z-axis position of sliders

Resultant of Q-P obtained by Equation 4, 7, and 11 were subsequently used to determine distance of Z-axis each using Pythagoras equation. As depicted in Fig.1 formed projection like a right triangle where (c) is the resultant distance Q-P, (a) is the length of the arm, and (b) is the height of the slider on the Z-axis that the desired position. The Pythagoras equation on the right-angled triangle as:

$$L^2 = (Q_n P_{n_{res}})^2 + Z_n^2 \quad (12)$$

If fix-length of arms and the resultant distance of Q-P are known, then to determine the height of slider from the origin from equation 12 becomes:

$$Z_n = \sqrt{L^2 - Q_n P_{n_{res}}^2} \quad (13)$$

Where $n = 1, 2,$ and $3.$

From equation which has been obtained, the slider position can be determined according to the desired position on the end-effector. The use of this method is another way to determine the movement of the slider Delta Robot that in general is using inverse kinematics calculation.

3. CONCLUSION

In this paper, we have illustrated pythagoras principle to determine sliders position of 3-DOF Linear Delta Robot as other way from inverse kinematics. In conclusion, the Z-axis position of three sliders same as inverse kinematics calculations.

The #1Online Encyclopedia Dedicated to Computer Technology [Online]. Available <http://www.webopedia.com/TERM/R/robotics.htm>

The #1Online Encyclopedia Dedicated to Computer Technology [Online]. Available <http://www.webopedia.com/TERM/R/robotics.htm>

he #1Online Encyclopedia Dedicated to Computer Technology [Online]. Available <http://www.webopedia.com/TERM/R/robotics.html>

he #1Online Encyclopedia Dedicated to Computer Technology [Online]. Available <http://www.webopedia.com/TERM/R/robotics.htm> (Ayob, Nurshazwani, & Jalani, 2015)

REFERENCES

- [1] Bonev, I. (2016). *Affordable Academic Parallel Robots*. Retrieved from Parallemic: <http://www.parallemic.org/Reviews/Review002.html>
- [2] Stolfi, F., Avanzini, A., Welker, B., & Isinhue, A. (2014). "Design Review of Delta Robot". *MECE E3430 Engineering Design*, 10-19.
- [3] Wikipedia. (2015). *Delta Robot*. Retrieved September 2015, from Wikipedia Website: https://en.wikipedia.org/wiki/Delta_robot
- [4] Liu, X. J., Wang, J., Oh, K. K., & Kim, J. (2003). "A New Approach to the Design of a DELTA Robot with a Desired Workspace". *Journal of Intelligent and Robotic Systems*, 210.
- [5] Vischer, P., & Clavel, R. (1998). "Kinematic Calibration of the Parallel Delta Robot". *Robotica*, 207-218.
- [6] Pauly, M. L. (2014). Workspace Analysis of a Linear Delta Robot: Calculating the Inscribed Radius. *Rose-Hulman Institute of Technology*.
- [7] Williams II, R. L. (2015). "The Delta Parallel Robot: Kinematics Solutions". *Internet Publication*. Retrieved from www.ohio.edu/people/williar4/html/pdf/DeltaKin.pdf
- [8] Greensite, F. (2012). "A New Proof of the Pythagorean Theorem and Its Application to Element Decompositions in Topological Algebras". *International Journal of Mathematics and Mathematical Sciences*.
- [9] Ratner, B. (2016). "Pythagoras: Everyone Knows His Famous Theorem, but Not Who Discovered It One Thousand Years before Him". *DM STAT-I Consulting*.
- [10] Ayob, M. A., Nurshazwani, W., & Jalani, J. (2015). "Inverse Kinematics Analysis of a 5-Axis RV-2AJ Robot Manipulator". *ARPN Journal of Engineering and Applied Sciences*.

MORPHOLOGICAL CHARACTERIZATION OF NIBUNG (*Oncosperma tigillarum* (Jack) Ridl.) AS RIAU PROVINCE MASCOT FLORA

Desti

Department of Biology Education, Faculty of Education, Universitas Islam Riau
Jl. Kaharuddin Nasution, Marpoyan, Pekanbaru 28284 Riau, Indonesia

Email : destibio@edu.uir.ac.id

Abstract

Nibung (*Oncosperma tigillarum* (Jack) Ridl.) is the identity of the Riau Province that serve as the mascot of the flora of the province. The purpose of doing research is to know the morphological characterization of the flora as the mascot nibung Riau Province. Morphological observation in the field can provide useful information for determining the character of a plant and into a special identifier and identity in distinguishing a plant. Morphological characters observed morphological character that consists of a quantitative and qualitative nature of the observed sample directly on the original habitat in nibung. Morphological observations of the next data diskoring and presented in the form of pictures. In addition, qualitative data are presented in visual form and description. The results showed that plants have a life habit nibung merumpun with a wooden rod hard. The plants live observable Nibung merumpun. Vegetative organ that has been observed is composed of parts of the roots, stems, and leaves. Type of plant rooting nibung root-shaped fibers. The stem and leaves are protected by spines hard long black. Its leaves are arranged menyirip nibung (pinnatus) with type compound leaves and pertulangan leaves. Generative organs observed is composed of organs of the flowers and fruit. Flowers plants nibung arrayed in Yellow River. While the fruit is round-shaped, dark green to dark purple. Types of flowering plants observed nibung pertained type compound interest.

Keywords: *Nibung, Morphological Characterization*

1. INTRODUCTION

Nibung (*Oncosperma tigillarum*) is typical of plants that serve as the mascot for the flora of the province of Riau. Nibung plant is one of the important germplasm in Riau Province. According to Jamsari,

(2008), germplasm as a descendant of the nature of the substance need to get attention, not only to collect and maintain, but also characterize and evaluate genetic diversity and genotipnya.

Morphological observation in the field can provide useful information for

determining the character of a plant that wants to be developed or be a special identifier in distinguishing a plant. Morphological characters of the identifier is important can be the identity of the plants. Morphological marker is the first step of the observed directly based on the nature of the morphological characteristics among others are secondary (Jamsari, 2008).

One of the obstacles faced in nibung plant conservation efforts in Riau Province is a natural growing place of habitat damage and exploitation are not responsible. In addition, yet the abundance of information on plant morphological characters nibung in Riau Province causing the plant not known by people in Riau in particular as the mascot flora regions themselves. Therefore, it is expected that with the characterization of the morphology of this activity can be a reference in the socialization and exploration efforts nibung plants as the mascot flora Riau, so expect public awareness will use wisely protective measures and the existence of this flora. In addition, it is expected to serve as a material consideration for policy makers in plant conservation efforts nibung in the days to come.

Characterization of the morphology of plants nibung (*O. tigillarum*) is expected to provide information about all the characters and morphology of etnobotaninya, so that it can help in the effort of development and conservation of plants nibung. To date information on the characterization of plant nibung in Riau Province is still not there. Therefore, the activities of the characterization of the morphology of Botanicals in Riau Province nibung is very important observed.

2. METHODOLOGY

Nibung (*O. tigillarum*) is typical of plants that serve as the mascot for the flora of the province of Riau. Nibung plant is one of the important germplasm in Riau Province. According to Jamsari, (2008), germplasm as a descendant of the nature of the substance need to get attention, not only

to collect and maintain, but also characterize and evaluate genetic diversity and genotype.

Morphological observation in the field can provide useful information for determining the character of a plant that wants to be developed or be a special identifier in distinguishing a plant. Morphological characters of the identifier is important can be the identity of the plants. Morphological marker is the first step of the observed directly based on the nature of the morphological characteristics among others are secondary (Jamsari, 2008).

One of the obstacles faced in nibung plant conservation efforts in Riau Province is a natural growing place of habitat damage and exploitation are not responsible. In addition, yet the abundance of information on plant morphological characters nibung in Riau Province causing the plant not known by people in Riau in particular as the mascot flora regions themselves. Therefore, it is expected that with the characterization of the morphology of this activity can be a reference in the socialization and exploration efforts nibung plants as the mascot flora Riau, so expect public awareness will use wisely protective measures and the existence of this flora. In addition, it is expected to serve as a material consideration for policy makers in plant conservation efforts nibung in the days to come.

Characterization of the morphology of plants nibung (*O. tigillarum*) is expected to provide information about all the characters and morphology of etnobotaninya, so that it can help in the effort of development and conservation of plants nibung. To date information on the characterization of plant nibung in Riau Province is still not there. Therefore, the activities of the characterization of the morphology of Botanicals in Riau Province nibung is very important observed.

3. RESULT AND DISCUSSION

Based on the results of observation of the morphological characterization,

characters have been observed qualitative and quantitative character measurements plants nibung (*O. tigillarum*). Details of the results of observations of plant morphological characters nibung described as follows:

1. Habit

The plant is a plant similar nibung Palm-paleman thrives around the area of the neighbourhood and the community of the plantation area in the District of Bengkalis Riau. Plants observed Nibung live merumpun, where each rumpunnya can consist of 8 to 18 with saplings nibung per clump. Plant saplings nibung resembles bamboo shoots at the base of rumpunnya. Plant clumps nibung can become very large and formed a unity

between the clumps of one with the other clumps. This is in accordance with the results of the research of Baba, Chan and Aksornkoe (2013) stating that the herbs in the family including Palma nibung that normally grows wild, grow berumpun like bamboo. One tree can have 5-30 nibung saplings.

2. Vegetative Organs

Vegetative organ that has been observed is composed of the part of root, stem, and leaf (Figure 1). Type of plant rooting nibung root-shaped fibers. The stem and leaves are protected by spines hard long black. Its leaves are arranged menyirip nibung (pinnatus) with type compound leaves and pertulangan leaves



Figure 1. Vegetative Plant Organs of Nibung; Root (A); stem (B), and leaf (C)

3. Generative Organs

Flowers plants nibung arrayed in Yellow Flower. While the fruit is round-shaped, dark green to dark purple. Types of flowering and fruit plants observed nibung pertained type compound interest. This is in line with the results of the research of Baba, Chan and Aksornkoae (2013) stating that plants nibung. Colour bright yellow inflorescence stalk. Flower tree shaped like bunches of mayang

nibung Palm hang, color yellow purplish green. In each one there are two types of flowers, flowers, male and female flowers. Generally 1 female flowers flanked by two male flowers. A perbungaannya wrapper also spiked. The fruit is globose, brought forth a dark purple coloured smooth surface. The morphology of the fruit plants nibung observed can be seen in Figure 2



Figure 2. The morphology of the flowers and Fruit Plants of Nibung

The stem is very strong and resistant nibung rotted so much used as a pillar of the coastal area houses and other building materials such as shipyards, docks and fishing by fishermen. In addition, nibung used as poles home staging, flooring, and bridges. Young shoots of plants has also been much nibung utilized by communities in the Province as a source of food and vegetables. Part of the young shoots of plants nibung rated by the community to have a better taste compared to bamboo shoots of bamboo.

In this case, the character of plant morphology nibung has been used in the process of identification and as a plant nibung identifier as the mascot of Riau Province. This is in accordance with statement of Jamsari (2008), which States

that each plant has specific morphological descriptions which is the marker of a plant. Morphological marker is a marker that had long been used in conducting taxonomic descriptions because it is more convenient, fast, simple and relatively cheap.

4. CONCLUSION

Characterization of the morphology of the plant was done nibung consists of characters which are quantitative and qualitative. The results showed that plants have a life habit nibung merumpun with wooden rods, which flourished around the area of the neighbourhood and the community of the plantation area in the District of Bengkalis Riau. Plants observed Nibung live merumpun, where each

rumpunnya can consist of 8 to 18 with saplings nibung per clump. Plant saplings nibung resembles bamboo shoots at the base of rumpunnya. Plant clumps nibung can become very large and formed a unity between the clumps of one with the other clumps.

Vegetative organ that has been observed is composed of parts of the roots, stems, and leaves. Type of plant rooting nibung root-shaped fibers. The stem and leaves are protected by spines hard long black. Its leaves are arranged menyirip nibung (pinnatus) with type compound leaves and pertulangan leaves. Generative organs observed is composed of organs of the flowers and fruit. Flowers plants nibung arrayed in Yellow River. While the fruit is round-shaped, dark green to dark purple. Types of flowering and fruit plants observed nibung pertained type compound interest.

ACKNOWLEDGEMENT

Directorate of Research and Public Service, Directorate-General of Research and Development for the Strengthening of the Ministry of Research, Technology and Higher Education, According to the Research Contract Number: 120/KONTRAK/LP-UIR/4-2017 Through Research Institutes Riau Islamic University.

REFERENCES

Baba, S., Chan, H.T dan Aksornkoe, S. 2013. Useful Product from Mangrove and other Coastal Plants. ISME Mangrove Educational Book Series No. 3. International Society for Mangrove Ecosystem (ISME). Okinawa, Japan and

International Tropical Timber Organization (ITTO). Yokohama. Japan.

Ernawati, E. 2009. Ethnobotany Of The Malay Tribes Community Land (A Case Study Of Village Aur Yellow Excl. Kampar Kiri Hulu Kab. Kampar). Theses Faculty Of Forestry IPB. Bogor.

Jamsari. 2008. Introduction to Breeding, the cornerstone of molecular, biological and Genetic. Unri Press. 232 case. Pekanbaru.

Kuni, B. E., G. Hardiansyah and Idham. 2015. Ethnobotany of Dayak Society relatives in the village of Perodah Sub-district Tapang Sekadau Regency Sekadau Upstream. Journal Of Sustainable Forest. Vol. 3 (3): 383 – 400.

Nurlia, A., H. Saberi and A. H. Lukman, 2013. The pattern of utilization of Marketing Nibung around Sembilang National Park Area of South Sumatra Province. Journal Of Forest Research Plant. Vol. 10 No. 4:241 – 251.

Saad, Z. S., Ahmad, M.H., M.F.A.. Rani Khodzuri, M.H., N.M. Noor Yusof and Y. Mukai. 2015. Assessing the Potential of Mangrove Educotourism to Marine Protected Areas: A Case of Tioman and Tulai Islands, Pahang, Malaysia. The Natural Resources. 2015, 6, 442-449.

Winantris, I., Syafri and A.T. Rahardjo. *Oncosperma tigillarum*. 2012 is Part of Delta Plain Character Palino on Delta Mahakam, Kalimantan. Bionatura – Journal of science – Biological and physical Sciences. Vol. 14 No. 3:228-236. ISSN 1411-0903

WEIGHT ON BIT ANALYSIS IN RATE OF PENETRATION OPTIMIZATION USING BOURGOYNE AND YOUNG METHOD

Novrianti¹, Ali Musnal², Hardi³, Bop Duana A⁴, Leovaldo P⁵
^{1,2,3,4,5} Universitas Islam Riau
Email : novrianti@eng.uir.ac.id

Abstract

Drilling is one of the key in the exploration and exploitation of oil and gas. In every drilling job, drilling target should be achieved well with the optimum Rate of Penetration (ROP). Calculation and analysis of rock, bit selection, Weight on Bit (WOB), optimum ROP, mechanical characteristic, and drilling hydraulic system need to be done in order to obtain optimum ROP. WOB optimization is one of the ways to obtain optimum ROP and also to avoid damage to the bit which caused by overloading. The drilling rate is successfully increase if the drilling time is short and the drilling target achieved according the plan itself. Calculation of ROP optimization at well X by using Burgoyne and Young method. This method is suitable to apply at well X because it caused by the drilling mechanical characteristic analysis. Calculation of bit usage time needs to be done before determine optimum ROP to determine RPM, WOB data is needed to optimize ROP in order to minimize drilling cost. From WOB analysis obtained, ROP at 0 ft – 200 ft is 42.87%, at 208 ft – 641 ft is 59.71%, at 641 ft – 943 ft is 59.08%, at 943 ft – 1149 ft is 63.09%, at 1149 ft – 1419 ft is 56.91%, at 1419 ft – 1653 ft is 55.88%, and at 1653 ft – 1894 ft is 58.85%.

Keywords: *Rate of Penetration (ROP), Weight*

1. INTRODUCTION

Drilling oil wells involves a large number of risks. Development of oilfield is subject to drill in cost efficient manners. For that reason oilfield drilling operations will face hurdles to reduce overall costs, increase performances and reduce the probability of encountering problems. (Eren and Ozbayoglu, 2010), (Kutas et al., 2015). Optimization drilling techniques succeed to reduce drilling cost noticeably. (Hasan et al., 2008), (Bahari and Baradaran Seyed, 2007). An essential part of these techniques is

drilling rate prediction. (Hasan et al., 2008), (Kaiser, 2007). Optimization of the drilling process is normally achieved by increasing the rate of penetration (ROP) in an environment that is bounded by financial costs and physical limits. Optimizing rate of penetration is the key factor to reduce cost per foot and Minimizing the time of exposure of drilled formations. (Bakly et al., 2007). Drilling engineer have been concerned about this issue considerably during last decade because it result in optimum drilling parameters selection,

which leads to minimize drilling cost per foot. (Bourgoyne and Young Jr., 1974)

Achieving the optimum ROP involves understanding a series of operational parameters such as flow rate and pressure at the bottom of the well (which are related to well clean liness and safety),the weight exerted on the drill bit (WOB) and the rotational speed of the bit or rotation per minute (RPM). The greater the weight and the higher the rotation of the bit, the faster the ROP will be.

However, increasing these parameters can also lead to excessive wear to the bit. Considering that the greatest costs are related to expenditure on rental of operational equipment, a bit change operation can be a very expensive procedure.(Formighieri and Filho, 2016)

In view of this, well drilling operations must be very carefully planned and executed to ensure that they run safely and within the time-frame predicted. Several data-driven models have been developed recently in attempts to deal with the current complexity of this problem and in response to in monitoring technologies. Some of these approaches employ neural networks as a black-box model of ROP and the operational variables (Edalatkhah, 2009), while others employ Bayesian networks for decision support or for prediction (Jacinto et al., 2013), (Al-yami et al., 2012)

There are also older mathematical models that are used for analytical support in parallel with the more modern models, primarily during the well planning phase. Of these, the model that has gained greatest acceptance is the Bourgoyne and Young Model (BYM) (Bourgoyne Jr. et al., 1986)

because it takes the largest number of operational parameters into account and still is widely employed. (Edalatkhah, 2009), (Formighieri and Filho, 2016). In this model, there are some unknown parameters or coefficients, which must be determined based on previous drilling experience in field (Bahari and Baradaran Seyed, 2007). Bourgoyne and Young method was published in 1974, which considers the effects of the depth, the characteristics of the formation being drilled, the mechanical factors of the drilling process WOB, RPM and the drilling fluid system properties.

The formation characteristics, which would determine WOB and ROP needs in order to achieve the target, are: (Adams and Charrier, 1985)

1. Soft Formation

This formation needs lower WOB, but when the other parameter already suit to this formation, such as the the rotation table is large enough and the circulation rate is good, ROP optimization will be achieved. With the addition of WOB, it may cause many problems, such as slope of the hole, bailing up, bit will break if it stuck on hard formation and the main problem is the hole will not form completely.

2. Hard Formation

Hard formation has higher compressive strength, the increase of small amount of WOB the bit and bearing will worn out fast.

2. METHODOLOGY

ROP optimization is done by calculating the effect of WOB and RPM. The equations which been used to calculate WOB are: (Irawan et al., 2012), (Alexandri, n.d.)

$$\left(\frac{w}{d_b}\right)_{Opt} = \frac{a_5 H_1 \left(\frac{w}{d_b}\right)_{max} + a_6 \left(\frac{w}{d_b}\right) t}{a_5 H_1 + a_6} \dots\dots\dots(1)$$

Which:

- (W/d) opt =Optimum bit weight per inch
- a5 = Bit weight constant
- H1 = Constants that depend on bit type

W/d = Weight on bit per inch of bit diameter, 1,000 lb/in.
 a6 = Rotary speed Constants

This equation is used to calculate RPM: (Amjad et al., 2015)

$$N_{opt} = 100 \left(\frac{\tau_H \left(\frac{W}{d_b} \right)_{max} - \left(\frac{W}{d_b} \right)_{opt}}{\tau_r \left(\frac{W}{d_b} \right)_{max} - 4} \right)^{\frac{1}{H_1}} \dots\dots\dots(2)$$

Where the abrasive constants of drilling bit (σ_H) is the average value when

the drilling is done. The torpidity of the drilling bit and bit time of use can be calculate by using these equations:

$$\sigma_H = \frac{T_r}{J_2(h_f + H_2 h_f^2 / 2)} \dots\dots\dots(3)$$

$$J_2 = \left[\frac{\left(\frac{W}{d_b} \right)_m - \left(\frac{W}{d_b} \right)}{\left(\frac{W}{d_b} \right) - 4} \right] \left[\frac{60}{N} \right]^{H_1} \left[\frac{1}{1 + H_2 / 2} \right] \dots\dots\dots(4)$$

$$T_{rH} = J_2 \sigma_H (h_f + H_2 h_f^2 / 2) \dots\dots\dots(5)$$

Which:

- T_r = Drilling time, hours
- J₂ = Bit torpidity parameteres
- h_f = Bit torpidity

in a normally compacted formation. (Kutas et al., 2015)

f₃ = effect of pore pressure

This term models the effect of compaction on ROP, assuming exponential increase of ROP with the increased pore pressure gradient. High ROP is common in formations like sandstone while low ROP is common in shale and limestone. The lower ROP is mainly related to overburden stresses, consequently adumbrate a more compacted and less porous interval. (Kutas et al., 2015)

f₄ = effect of differential pressure

This term represents the effect of pressure differential across the bottom of the hole on ROP. Increased bottom hole pressure can have a negative effect on ROP because cuttings can be held on bottom, increasing the friction and teeth wear of the drill- bits and also decreasing the hole cleaning efficiency. (Kutas et al., 2015)

f₅ = effect of drill bit diameter and WOB

This term models the effect of bit weight and bit diameter on penetration rate.

After the WOB and RPM analysis are done, optimum ROP determination can be done by using Bourgoyne and Young equation:

$$ROP = f_1 \times f_2 \times f_3 \times f_4 \times f_5 \times f_6 \times f_7 \times f_8 \dots\dots\dots(6)$$

Equation 1 consist of 8 sub – functions which act and have significant influence in the ROP performance (Hasan et al., 2008)(Kutas et al., 2015).(Bataee and Mohseni, 2011) Which:

f₁ = effect of formation strength

The expression of a₁ primarily represents the effect of formation strength on the rate of penetration (ROP), also represents drilled solid. (Kutas et al., 2015)

f₂ = effect of compaction on ROP

This term models the effect of compaction on ROP, assuming an exponential decrease in ROP with depth

Increased WOB has an exponential and proportional response on ROP. It should be noted that the drilling process starts after a minimal applied WOB. (Kutas et al., 2015)

f6 = effect of rotary speed

This term represents the effect of rotary speed on ROP. It assumes that the increased rotary speed is directly proportional and exponential to the penetration rate. Normally, after a maximum increased RPM (foundering point) it has negative effect on ROP. (Kutas et al., 2015)

f7 = effect of drill bit tooth wear

This term represents the effect of tooth wear on penetration rate. The value of a7 depends primarily on the bit type,

and less on formation type. (Kutas et al., 2015)

f8 = effect of bit hydraulic jet impact force

This term represents the effect of bit hydraulic on penetration rate. Increased jet force implies in better cleaning of cuttings around the bit teeth on the bottom of the hole, also better hydraulic environment for cutting transportation to the surface by maintaining the whole area around the bit and drill string more clean, avoiding differential sticking, decreasing friction rate, which could act against a higher ROP.

Equation 1 can be split into 8 different equations which can be seen at equation 7 to 14:

$$f1 = e^{2.303a1} \dots \dots \dots (7)$$

$$F2 = e^{2.303a2(1000-D)} \dots \dots \dots (8)$$

$$F3 = e^{2.303a3D0.69(gp-9)} \dots \dots \dots (9)$$

$$F4 = e^{2.303a4D(gp-\rho c)} \dots \dots \dots (10)$$

$$F5 = \left[\frac{\frac{W}{db} - \left(\frac{W}{db}\right)t}{4 - \left(\frac{W}{db}\right)t} \right]^{a5} \dots \dots \dots (11)$$

$$F6 = \left(\frac{N}{60}\right)^{a6} \dots \dots \dots (12)$$

$$F7 = e^{-a7h} \dots \dots \dots (13)$$

$$F8 = \left(\frac{Fj}{1000}\right)^{a9} \dots \dots \dots (14)$$

Where based on (Hasan et al., 2008) and (Formighieri and Filho, 2016)

a8 = Coefficients that must be chosen on the basis of previous drilling experience

D = True vertical well depth (ft)

gp = Pore pressure gradient (lbm/gal)

ρc = Equivalent mud density (lbm/gal)

W = Weight on bit (1000 lbf)

Db = Bit diameter (in)

(W/db)t = Threshold of weight on bit at which the bit begins to drill

N = Rotary speed (rpm)

h = Fractional tooth wear of the bit for which h = 0 at zero wear

Fj = Jet impact force (lbf)

(W/db)m = Constants for physical specifications of bit

τH = Formation abrasiveness constant (hr)

The variable constants which used in Bourgoyne and Yong method are: (Irawan et al., 2012)

Table1. Constants value from a1 to a8

Variable	Constant	Value
Formation Strength	a1	3.91
Normal Compaction	a2	9.45E-05
Under Compaction	a3	6.86E-05
Pressure Differential	a4	7.64E-05
Weight On Bit	a5	0.37
Rotary Speed	a6	1.97
Tooth Wear	a7	0.025
Jet Impact Force	a8	0.71

The actual data from well X before the optimization is done:

Table 2. Drilling Data of Well

Number	Depth Start (ft)	Depth End MD (ft)	Drill Time (hr)	WOB Act 1000 lbft	N rpm	Int Depth (ft)	ROP Actual
1	0.00	200	3	15	120	200	66.70
2	208	641	4	15	40	433	108.30
3	641	943	4	15	40	302	75.50
4	943	1,149	3.3	15	40	206	63.40
5	1,149	1,419	4	15	40	270	67.50
6	1,419	1,653	4	15	40	234	58.50
7	1,653	1,894	4	15	40	241	60.20
8	1,894	2,000	2	15	40	106	53.00

6. RESULT AND DISCUSSION

Based on the equation 1 and drilling data from table 2, WOB result can be seen in the table 3

Table 3. Calculation Result of Weight on Bit (WOB)

Data Number	Depth (ft)	(w/db)max	(w/db)t	H1	WOB Opt (1000 lb/ft)
1	200	15	14	1.8	14.25
2	641	15	14	1.7	14.24
3	943	15	14	1.7	14.24
4	1149	15	14	1.7	14.24
5	1419	15	14	1.7	14.24
6	1653	15	14	1.7	14.24
7	1894	15	14	1.7	14.24
8	2000	15	14	1.7	14.24

Table 4 shows the comparison between actual WOB and calculated WOB

Table 4. Comparison Between Actual WOB and Calculated WOB

Number	Depth (ft)	WOB Act lbft	WOB Opt 1000 lb/ft
1	208	15,000	14,250
2	641	15,000	14,240
3	943	15,000	14,240
4	1,149	15,000	14,240
5	1,419	15,000	14,240
6	1,653	15,000	14,240
7	1,894	15,000	14,240
8	2,000	15,000	14,240

Based on table 4, it shown that differences between actual WOB and calculated WOB is about 5%. To determine the increase of RPM, both WOB and RPM can be :

separately optimized, it needs to be combined. To determine RPM, drilling bit time of use is need to be calculated by using equation 5, and the result shown in table 5

Data Number	DepthMD (ft)	Tr (Jam)	h (ft)	db (inch)	(W/db)m	H1	H2	hf	(w/d) 1000 lb/in	J2	σ_H (jam)	dH/dTr	TrH (jam)
1	200	3	0.010	17.5	8.5	1.8	5	0.234	0.670	1.32	6.13	0.14	2.05
2	641	4	0.013	12.5	10	1.7	3	0.234	0.981	0.90	14.07	0.10	2.52
3	943	4	0.013	12.5	10	1.7	3	0.234	0.981	1.23	10.32	0.10	2.52
4	1149	3.25	0.010	12.5	10	1.7	3	0.234	0.981	1.38	7.46	0.12	2.05
5	1419	4	0.013	12.5	10	1.7	3	0.234	1.091	1.36	9.29	0.10	2.52
6	1653	4	0.013	12.5	10	1.7	3	0.234	1.091	1.48	8.55	0.10	2.52
7	1894	4	0.013	12.5	10	1.7	3	0.234	1.091	1.36	9.29	0.10	2.52
8	2000	2	0.009	12.5	10	1.7	3	0.234	1.091	1.54	4.10	0.19	1.26

Based on equation2, RPM can be calculated and shown in Table 6:

Table 6. RPM

Data Number	Depth (ft)	τ_H/tb	(w/db)max	(w/db)t	H1	WOB Opt (1000 lb/ft)	N Opt (Rpm)
1	200	2.98	15	14	1.8	14.25	41.21
2	641	5.59	15	14	1.7	14.24	57.03
3	943	4.10	15	14	1.7	14.24	47.52
4	1149	3.64	15	14	1.7	14.24	44.35
5	1419	3.69	15	14	1.7	14.24	44.68
6	1653	3.40	15	14	1.7	14.24	42.55
7	1894	3.69	15	14	1.7	14.24	44.68

8	2000	3.25	15	14	1.7	14.24	41.49
---	------	------	----	----	-----	-------	-------

There is significant comparison between actual RPM and calculated RPM. At 200 ft depth actual RPM is higher than calculated RPM. Afterwards, at 641 ft, 943 ft, 1149 ft, 1419 ft, 1653 ft, 1894 ft, and

2000 ft the differences between actual RPM and calculated RPM is about 15%. Combination of WOB and RPM calculation can be used to optimize ROP. This combination can be seen in Fig 1:

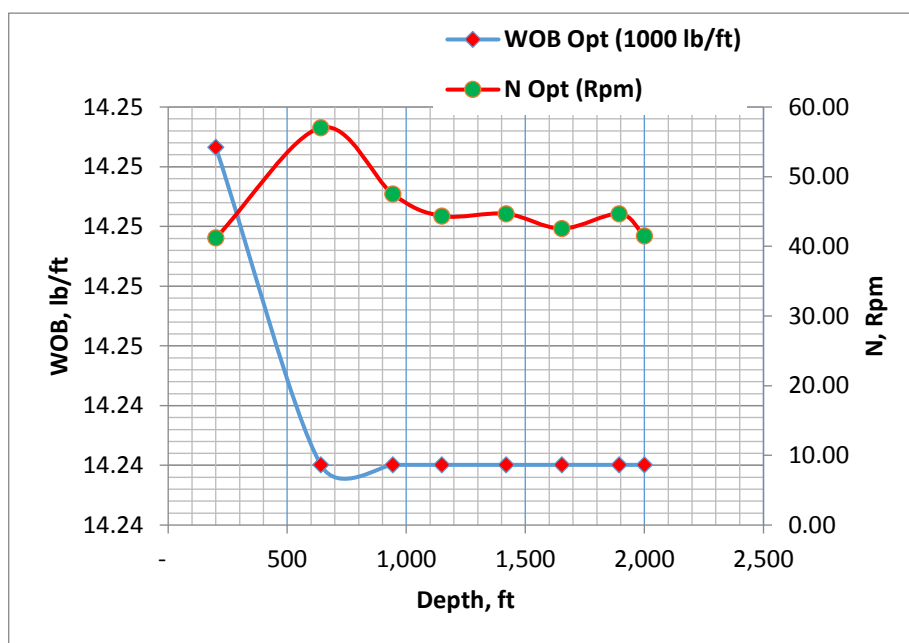

Fig 1. WOB and RPM Combination

By using equation 6, 7, 8, 9, 10, 11, 12, and 13 ROP can be calculated::

Table 7. ROP Optimization

Data Number	Depth MD (ft)	MW (ppg)	ECD (ppg)	N (rpm)	W/db (1000 lbft)	db (inch)	(W/db)t	H1	H2
1	200	9.2	8.74	41.21	14.25	17.5	14	1.8	5
2	641	9.2	9.36	57.03	14.24	12.5	14	1.7	3
3	943	9.2	9.39	47.52	14.24	12.5	14	1.7	3
4	1149	9.2	9.42	44.35	14.24	12.5	14	1.7	3
5	1419	9.6	9.6	44.68	14.24	12.5	14	1.7	3
6	1653	9.6	9.63	42.55	14.24	12.5	14	1.7	3
7	1894	9.6	9.86	44.68	14.24	12.5	14	1.7	3
8	2000	9.6	9.88	41.49	14.24	12.5	14	1.7	3

Table 7. ROP Optimization

hf	f1	f2	f3	f4	f5	f6	f7	f8	OPTIMIZED ROP (ft/hr)
0.23	49.90	2.52	0.97	1.01	1.60	0.48	1.00	0.01	95.39
0.23	49.90	2.47	0.98	0.99	1.60	0.90	1.00	0.01	173.04
0.23	49.90	2.44	0.98	0.99	1.60	0.64	1.00	0.01	120.11
0.23	49.90	2.42	0.98	0.98	1.60	0.56	1.00	0.01	103.34
0.23	49.90	2.39	0.98	1.00	1.60	0.57	1.00	0.01	105.92
0.23	49.90	2.37	0.98	1.00	1.60	0.50	1.00	0.01	91.19
0.23	49.90	2.35	0.98	0.96	1.60	0.54	1.00	0.01	95.63
0.23	49.90	2.33	0.98	0.96	1.60	0.47	1.00	0.01	82.42

The comparison between actual ROP and calculated ROP can be shown in fig. 2.

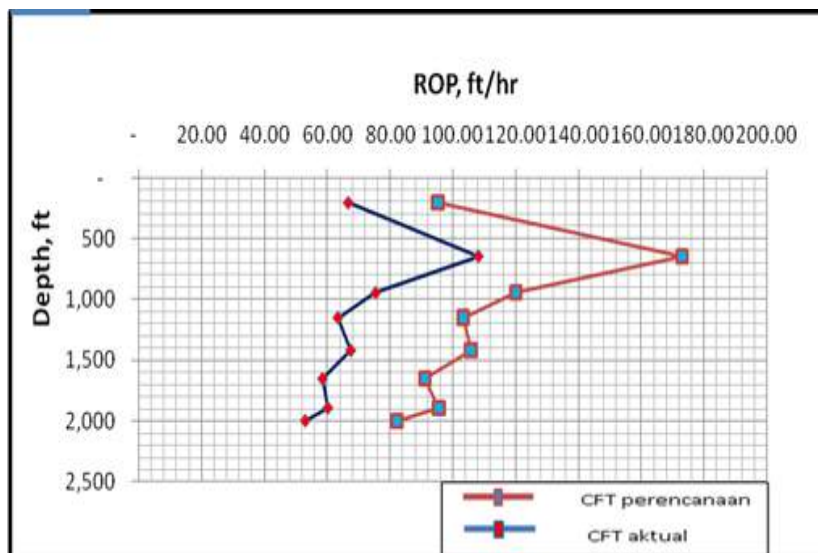

Fig 2.

Actual and Calculated ROP

After the mechanical parameter calculation between WOB and RPM by using Bourgoyne and Yong method, the differences between WOB and RPM can be determined. These parameters will affect ROP enhancement plan. After calculation

of optimized ROP, the incremental of ROP between actual ROP and optimized / calculated ROP expressed in percentage by using equation 14 which the result shown in table 9.

Table 9. ROP Incremental for Each Depth

Range of Depth (ft)	Actual ROP (ft/hr)	Optimized ROP (ft/hr)	ROP Incremental (%)
0 - 200	66.70	95.39	42.87
208 - 641	108.30	173.04	29.71
641 - 943	75.50	120.11	59.08
943 - 1149	63.40	103.34	63.09
1149 - 1419	67.50	105.92	56.91
1419 - 1653	58.50	91.19	55.88
1653 - 1894	60.20	95.63	58.85

4. CONCLUSION

After WOB analysis to the ROP enhancement plan at well X, by calculating the effect of mechanical parameter using Bourgyone and Young method, it can be concluded that:

1. Based WOB effect analysis, it gives 5% difference between actual WOB and calculated WOB.
2. Based on WOB effect and RPM, ROP obtained in various depth, at 0 ft – 200 ft ROP incremental obtained 42.87%, from 208 ft – 641 ft ROP incremental obtained 59.71%, at 641 ft – 943 ft ROP incremental obtained 59.08%, from 943 ft – 1149 ft ROP incremental obtained 63.09%, at 1149 – 1419 ft ROP incremental obtained 56.91%, at 1419 ft – 1653 ft ROP incremental obtained 55.88%, at 1653 ft – 1894 ft ROP incremental obtained 58.85%.

REFERENCES

- Adams, N.J., Charrier, T., 1985. Drilling engineering: A complete well planning approach.
- Al-yami, A.S., Schubert, J., Texas, A., 2012. Using Bayesian Network to Model Drilling Fluids Practices in Saudi Arabia. SPE Int. Prod. Oper. Conf. Exhib. 14–16.
- Alexandri, A., n.d. PERENCANAAN RATE OF PENETRATION 6.
- Amjad, Q.B., Taxila, O.U.E.T., Waheed, S., Uet, O., Buitems, T., Khan, M.S., 2015. SPE-181124-MS Drilling Optimization of Kohat / Potohar Region by Mathematical Model (Using Matlab) and CompArative Method-A Case Study.
- Bahari, A., Baradaran Seyed, A., 2007. Trust-Region Approach To Find Constants of Bourgoyne and Young Penetration\nRate Model in Khangiran Iranian Gas Field. Proc. Lat. Am. Caribb. Pet. Eng. Conf. 1–6. doi:10.2523/107520-MS
- Bakly, O. El, Ali, K., Dawey, M. El, Company, K.P., 2007. SPE / IADC 108298 Optimized Drilling Cost Per Foot in KPC Versus the Increase of Drilling Tangible and Intangible Cost (Case Study).
- Bataee, M., Mohseni, S., 2011. Application of Artificial Intelligent Systems in ROP Optimization: a Case Study in Shadegan Oil Field. Middle East Unconv. Gas Conf. Exhib. doi:10.2118/140029-ms
- Bourgoyne, a. T., Young Jr., F.S., 1974. A Multiple Regression Approach to Optimal Drilling and Abnormal Pressure Detection. SPE J. 14, 371–384. doi:10.2118/4238-PA
- Bourgoyne Jr., A.T., Millheim, K.K., Chenevert, M.E., Young Jr., F.S., Bourgoyne, A.T.J., Millheim, K.K., Chenevert, M.E., Young, F.S.J., 1986. Applied Drilling Engineering Chapter 8 Solutions. Soc. Pet. Eng. doi:10.2118/31656-MS
- Edalatkhah, 2009. Bit Selection Optimization using artificial Intelligence System.

- Eren, T., Ozbayoglu, M.E.E., 2010. Real Time Optimization of Drilling Parameters During Drilling Operations. SPE Oil Gas India Conf. Exhib. 1–14. doi:10.2118/129126-MS
- Formighieri, S., Filho, P.J.D.F., 2016. Estimation of Bourgoyne and Young Model coefficients using Markov Chain Monte Carlo simulation. Proc. - Winter Simul. Conf. 2016–Febru, 1172–1183. doi:10.1109/WSC.2015.7408243
- Hasan, M., Sensifai, B., National, B., Oil, I., 2008. Determining Bourgoyne and Young Model Coefficients Using Genetic Algorithm to Predict Drilling Rate. doi:10.3923/jas.2008.3050.3054
- Irawan, S., Abd Rahman, A.M., Tunio, S.Q., 2012. Optimization of weight on bit during drilling operation based on rate of penetration model. Res. J. Appl. Sci. Eng. Technol. 4, 1690–1695. doi:1690-1695, 2012
- Jacinto, C.M.C., Freitas Filho, P.J., Nassar, S.M., Roisenberg, M., Rodrigues, D.G., Lima, M.D.C., 2013. Optimization models and prediction of drilling rate (ROP) for the Brazilian pre-salt layer. Chem. Eng. Trans. 33, 823–828. doi:10.3303/CET1333138
- Kaiser, M., 2007. A Survey of Drilling Cost and Complexity Estimation Models. Int. J. Pet. Sci. Technol. 1, 1–22.
- Kutas, D.T., Mul, M.L., Nascimento, A., Estadual, U., Unesp, P., 2015. A Study of the Applicability of Bourgoyne & Young ROP Model and Fitting.

DESIGN SELF SERVICE SOFTWARE PROTOTYPE FOR VILLAGE OFFICE USING UNIFIED MODELING LANGUAGE

Jaroji¹, Agustiawan², Rezki Kurniati³

^{1,3} Department of Bachelor of Applied Software Engineering Politeknik Negeri Bengkalis

² Department of D-III Electronic Politeknik Negeri Bengkalis

Email : ¹jaroji@polbeng.ac.id, ²agustiawan@polbeng.ac.id, ³rezki@polbeng.ac.id

Abstract

Government bureaucracy that seem convoluted also occurs at the village government level. This is not caused by the standard service system that has been in force in general, but the staff and the lack of infrastructure that causes the excellent service to the community become disrupted. Self-service software can be a solution to reduce the bureaucratic path that is considered convoluted without having to eliminate the role of the parties concerned. In this self-service software the community can access services such as taking care of letters (certificate) and cover letters for various purposes. To minimize the public in typing use id card reader to read the number on the ID card. Before the software is fully implemented, it builds the first self-service software prototype, which begins with a running system analysis using PIECES analysis tools. Modeling process in software using unified modeling language method. Implementation of process modeling using PHP programming and interface using HTML5, CSS and javascript. The study produced a prototype of self service software that was installed on the computer stand of the design and assembled itself. Wifi connection is used to connect standing computer (client) with server.

Keywords: *self services, uml, pieces, village government*

1. INTRODUCTION

The Village Office is a government agency located at the lowest level, in Permendagri no. 84 of 2015, the village government structure consists of village heads, village consultative bodies, village apparatus consisting of village secretaries, regional executors and technical implementers (Kementerian Dalam Negeri, 2015). One of the tasks and services of the village government is to conduct population data collection and services for the production of Identity Card (KTP), Family

Card (KK), Birth Certificate, Death Letter, and Certificate of Move.

Information technology makes it easy for humans. Utilization can help the village government in serving the community. When viewing the villages in Bengkalis District, the utilization of this information technology has not been maximized. So far, the system used is still in the form of manual information system, some obstacles obtained in the use of this manual system such as complicate and slow down in the process of proposing new letters, changes or

deletion of data in particular provide reports on population data. Not a few also people who think that bureaucracy governed by complicated and difficult. This is based on the facts they see when they are taking care of the population administration. While the public wants a friendly, fast and effective service.

Self-service system can be a solution to provide excellent service to the community as well as to educate the application of information technology to the community. The self-service system can be described as a tool that can be utilized by the community in administering a certificate (such as birth certificate, death certificate, moving certificate requiring accuracy and accuracy of data), a letter of introduction and handling of Family Card (KK). Self-service systems should be designed to be easily used by people with different educational backgrounds. As a tool of identification of population data used Population Identity Number (NIK) which is listed on Identity Card (KTP), this is where the required number of the parent population number reader. At the same time provide information that the residents in question have and carry ID cards. Once the population data is identified by the system, people can choose the services listed on the screen, input the required data and then the service will be processed by the system. To ensure that the needs are properly identified, a prototype of self-service software is developed using the unified modeling language method

2. METHODOLOGY

2.1 Research Procedure

Here is a procedure used to complete the study:

1. Preparation

Before an information system is developed, it starts with a policy and planning to develop the system itself (Prasetya et al, 2014). At this stage it begins by propose the idea of self service at the village office, setting the boundaries of the problem or the scope of the service of handling the certificate. The objective to be achieved is to produce self service system for village office services. Data collection by interview method.

2. Identify user requirements

In the identification phase of user needs, activities include interviews with administrative offices in village offices and observations on documents such as the format of certificate and cover letter. These activities are carried out to explore the initial needs of the software. In addition, a study of literature on the theory of design and software development. Analysis of system requirements using PIECES. Itself stands for Performance, Information, Economics, Control, Efficiency, Service. This PIECES has six sections, from each of the six sections to a check list, each check list in the appropriate section of the name will bring up the problem. Here's an explanation of each section PIECES: 1. Performance (P) = Throughput, response time (system performance). 2. Information (I) = Outputs, inputs, data storage (information presented). 3. Economic (E) = Costs, benefits (benefits achieved). 4. Control (C) = Security (system security). 5. Efficiency (E) = People, users, machines (efficiency of people and processes). 6. Service (S) = Services provided. (Nugraha, 2017). Based on this analysis formulated a solution in the form of self-service software development installed on the computer stand.

3. Design the software

Unified Modeling Language (UML) is a consistent communication tool in terms of supporting current system developers. The rules for modeling UML are how the constructed elements can relate to one another. UML models are grouped by their nature (Widodo and Herlawati, 2011):

a. Usecase

It is the functionality that the system provides as units exchanging messages between units or actors, usually expressed by using verbs. It is denoted by a horizontal image of the ellipse and no two or more usecase names may be the same.

b. Sequence

The sequence diagram is one of the Interaction diagrams that describes how an operation is performed, what messages are sent and when they are executed. This diagram is organized by time. Objects related to the running process of the operation are sorted from left to right based on the timing of occurrence in ordered messages.

c. Activity

Basically Activity diagrams are often used by flowcharts. This diagram corresponds to the statechart diagram. The statechart diagram focuses on objects that are in a process (or process being an object), activity diagrams focusing on related activities occurring in a single process. So in other words, this diagram shows how these activities depend on each other.

4. Development the software

At this stage build the application and perform the implementation of the results of the requirements specification and software design through

programming. Input at this stage are structural diagram, behavioral diagram, user interface, build system, and architecture.

2.2 Self service

Self service technology is called self-help, which refers to technologies that allow customers to learn, receive information, train themselves and provide their own services (Howard and Worboys, 2003). Self service technology which is designed can be directly used by the community. The devices needed to access the technology in the form of a PC and a touch screen monitor placed on the computer stand. Position and appearance should be made easy, elegant and attractive to make it easier for people to use this self-service system. Assembling component hardware support required expertise in the field of electronics for all components are fused into one tool with one cable power.

3. RESULT AND DISCUSSION

3.1 Analysis of Current Systems

The flow of information systems for the handling of certificates and covering letters in progress can be explained that the community making the introduction letter or certificate came to the village office. Then through the administration section to check on the files that are brought such as ID cards, family cards. If the data is correct then the intended manufacture is immediately in the process. After the letter is finished. The letter was signed by the village head. If the village head does not exist then it can be represented by the village secretary. The signed letter is given to the submitting community. The letter is recorded in the letter-making book.

3.2 Analysis of PIECES

The results of PIECES's analysis of the service system of making a certificate and

spengantar in the village office are as follows

1. Performance

Table 1 PIECES analyst result for performance

Paramater	Analyst Result
Troughout	Data processing is using computer and office software like Microsoft word and excel. Employee staff performance in input data, making letter and letter of introduction of village office through computer not maximal done because of limited human resources.
Respon Time	The database for storing population information is still limited and not updated

2. Information

Table 2 PIECES analyst result for Information

Paramater	Analyst Result
Accuracy	The service system of making a letter and cover letter is still done conventionally that is displaying information in the administration service (counter), banners, and standing banner.
Relevance	The letter-making and cover letter service is dependent on the staff so that it becomes an issue if the staff is not present.
Tepat Waktu	Service system in the conventional way takes time in terms of data searching, re-input and re-verify. All will be checked one by one.

3. Economy

Table 3 PIECES analyst result for economy

Paramater	Analyst Result
Cost	Economically, the service of making a certificate and introduction to the village has not had an impact on the use of costs with the existing system.

4. Control

Table 4 PIECES analyst result for control

Paramater	Analyst Result
System control	Supervision of the service system of making a certificate and cover letter has been done by dividing the system permissions in accordance with the needs, but caused by the limited human resources will be computer skills it becomes somewhat hampered.

5. Efficiency

Table 5 result of PIECES for efficiency

Paramater	Analyst Result
Cost sources	Fees for the service of making a certificate and cover letter shall be borne by the Village Government. Villages also have potential budget that can be utilized to improve the service quality to the community.
Power Source	The service system of making the certificate and cover letter has not been flexible due to the system being done still manually and dependent on the staff of the village officials.

6. Service

Table 6 result PIECES for service

Paramater	Analyst Result
Service process	Currently the service of making the certificate and the village introduction is still done manually by way of the community coming to the village office. Then the village administration staff put on administrative completeness. Further verification is done. If the data is properly processed according to the desired service.

3.3 System Weakness Analysis

1. Every service. The administration must open the resident file. This takes time in searching and verifying data.
2. Any letter of introduction or certificate shall be made, the public shall complete the administration. Like a copy of ID card, copy of family card
3. If the clerk on the part of the administration is unable to attend, the service will be constrained

of ID card, a copy of the family card but still be able to make a letter or cover letter.

3. It takes technology to manufacture a letter or cover letter that does not depend on the presence of the administration.

3.4 Data Analyst

1. To facilitate the verification of population data and facilitate the search for data with minimal time in need of population database organized.
2. It takes a technology that facilitates the service without having to bring a copy

3.5 Modeling System

3.5.1 Use Case

In the usecase diagram the actor consists of Community and village admin. The community has three cases and village admin has one case. Figure 1 is described the usecase. Use case scenario described the sequence of steps describe between the user and the system.

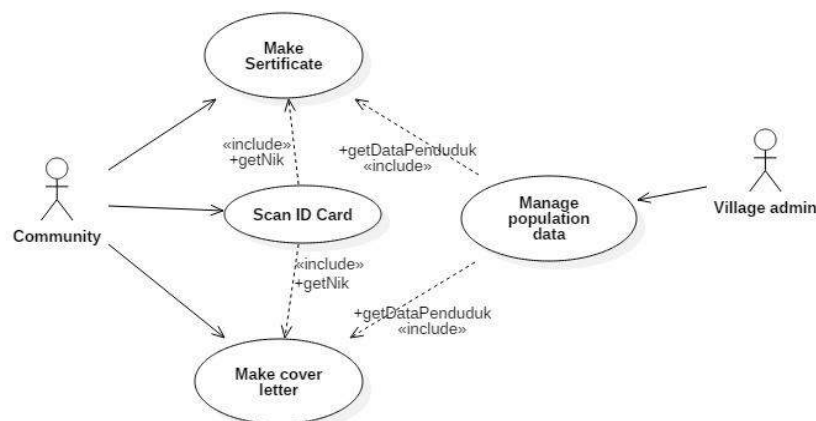

Figure 1 Use case diagram of the proposed system

1. Use case scenario make sertificate

Table 7 Use case scenario make sertificate

Use case name	Make Sertificate	
Use case id	1	
Actor	Community.	
pre condition	Actor must select menu of certificate type	
triger	Sistem check access privilage for actor, if Actor has the access, they can access the service	
Description	This use case describes the actor that make sertificate with the ID Card number and population data	
Typical course of events	Actor action a. Choice type of certificate b. Input data based on the selected certificate c. Click print button	system response a. Showing the page based on the selected type of certificate b. Save the data c. Print the certificate
Alternate courses	If Actor has the access, they can access the service	
conclusion	Actor has successful access the services	
Post condition	Sistem save the certificate data to database and give certificate to actor in pdf format	

2. Use case scenario scan ID Card

Table 8 Use case scenario scan ID Card

Use case name	Scan ID Card	
Use case id	2	
Actor	Community.	
pre condition	Actor must scan the correct ID Card	
triger	Actor have grant access the service	
Description	This use case describes the actor that scan ID Card for get id card number	
Typical course of events	Actor action a. Choice type of certificate b. Input data based on the selected certificate c. Click print button	system response a. Showing the page based on the selected type of certificate b. Save the data c. Print the certificate
Alternate courses	If the community give not valid ID Card number, system will rejected the request	
conclusion	Actor has successful access the services	
Post condition	Sistem give service access to actor	

4.5.2 Activity Diagram

The activity diagram in figure 2 is two of all the designed activity diagrams. In figure 2 (a) is an activity diagram to create a certificate, the public can choose the service menu and input data and press the

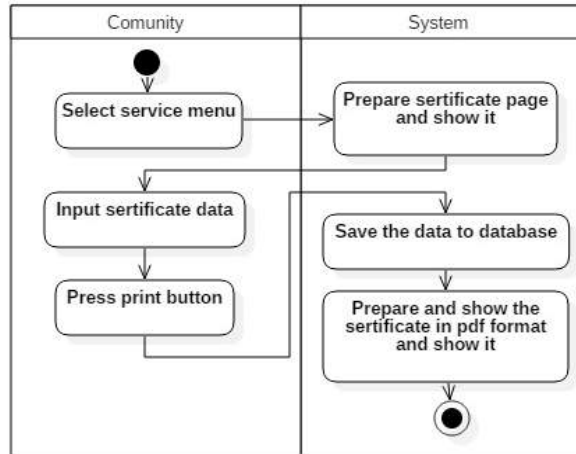

(a)

print button to get the certificate. Figure 2 (b) is an activity diagram for authentication, the public can enter the ID card in the slot provided to the parent population number are legible and displayed on the authentication page, the public can press the button to sign in to get into the service menu.

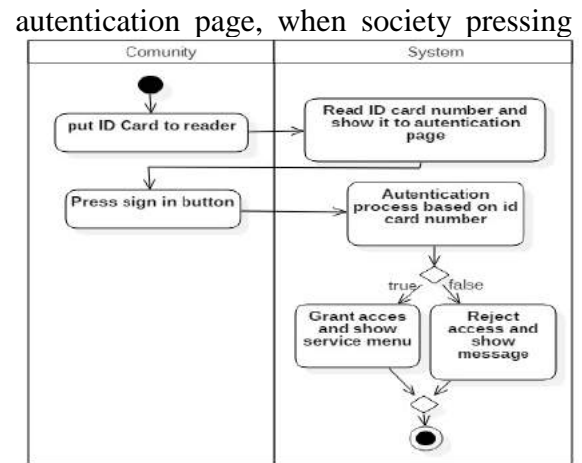

(b)

Figure 2 (a) Activity diagram make certificate (b) activity diagram authentication process

authentication page, when society pressing

4.5.2 Squence Diagram

Community scan ID card reader on standing computer, then system read parent number of residence and display it to

butt on sign in system check whether no registered in database. If the registered service page will open and if it is not registered, an access rejection message will be displayed, see figure 3 (a). To use community services to choose a menu of services, the system checks whether people have access rights to the service, for example poor letter-making services, not all communities can use the service. If access rights are available, then the public can input the data of the certificate and print it, see figure 3 (b).

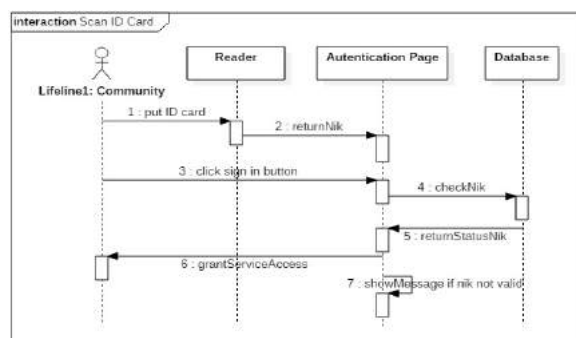

(a)

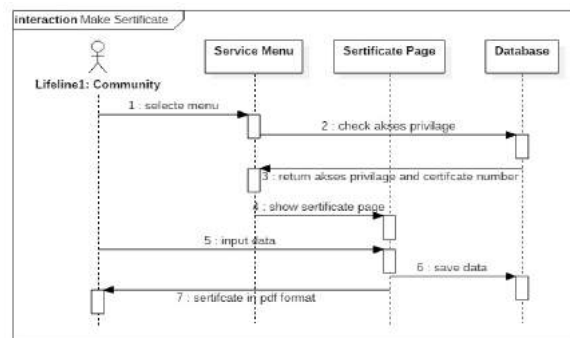

(b)

Figure 3 (a) Squence diagram authentication process (b) Squence diagram make sertificate

3.6 Computer Standing Design

Standing computer is used to facilitate the public in administrative affairs in the village office, so it is positioned in a place

that is easily accessible by the community, therefore designed an upright construction with the intention of the user can operate it by standing, as shown figure 4

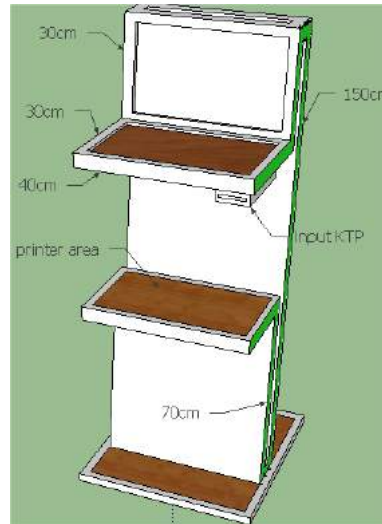

Figure 4. Standing computer design

Figure 4 shows the first rack (above) is a laptop equipped with a safety casing, underneath is placed a box equipped with a reader for reading the parent population number on the ID card that has been inserted. the second rack is where the printer to print the letters needed by the user.

3.7 Design Interface

Figure 5 is a design interface for user authentication, equipped with number keys to anticipate if the reader can not read the resident parent number properly. People can press Enter / Sign in to access the service.

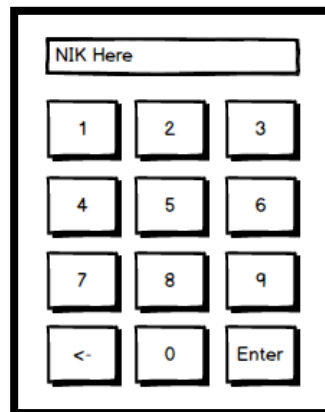

Figure 5 Design interface for authentication page

The design interface for the creation of a certificate is made similar to the official letter form. Figure 6 is one example of the interface design of making a certificate. In

this case people just choose the full name then all the required data will be seen. To get the certificate, people can choose the print button.

SURAT KETERANGAN DOMISILI
Nomor: xx/SKD/2014/2017/xx

Kepala Desa xxx Kecamatan Bengkalis Kabupaten Bengkalis, dengan ini menerangkan dengan sebenarnya:

Nama Lengkap

NIK

Tempat Lahir

Tanggal Lahir

Kewarganegaraan

Agama

Pekerjaan

Alamat

Yang bersangkutan benar Penduduk dan Berdomisili RT. 01 / RW. 01 Desa xxx, Kecamatan xxx Kabupaten xxx

Demikian Surat Keterangan Domisili ini kami buat dengan sebenarnya dan diberikan untuk dapat dipergunakan sebagaimana mestinya.

Tempat, date
Kepala Desa xx

Nama Kepala Desa

Figure 6 One of all interface design for make setificate

3.8 Implementation

The design of the interface is done to allow users to interact with the system. The design interface is done using hypertext

markup language (HTML5), Cascading Style Sheet (CSS 3) and jQuery for the system implemented a web-based server.

Authentication Page



Figure 7 Implementation result for authentication page

3.8.1 Certificate Page

SURAT KETERANGAN DOMISILI

Nomor : 470/SKD/2014/2017/50

Kepala Desa Tameran Kecamatan Bengkalis, Kabupaten Bengkalis, dengan ini menerangkan bahwa :

Nama Lengkap	<input type="text" value="-- Pilih Anggota Keluarga --"/>
Tempat Lahir	<input type="text"/>
Tanggal Lahir	<input type="text"/>
Jenis Kelamin	<input type="text"/>
Kewarganegaraan	<input type="text"/>
Agama	<input type="text"/>
Pekerjaan	<input type="text"/>
Status Perkawinan	<input type="text"/>
Alamat	<input type="text"/>

Yang bersangkutan benar Penduduk dan Berdomisili RT. / RW. Desa Kecamatan Kabupaten .

Demikian Surat Keterangan Domisili ini dibuat dengan sebenarnya, dan diberikan untuk dapat dipergunakan sebagai mana mestinya.

Tameran, 30 September 2017
KEPALA DESA TAMERAN
KECAMATAN BENGKALIS

<Nama kepala desa>



Figure 8 One of all implementation result for make setificate

3.8.2 Computer Standing

The material used for making a computer stand is a lightweight steel combine with aluminum. Electronics circuit for power suply computer and printer made centralized so that device only need one power supply with voltage 220 Volt. Computer standing communication and server using wifi.

4. CONCLUSION

Software generated in the form of self service prototype in village office. The use of unified modeling language methods helps translate business processes into processes that facilitate the creation of self service software prototypes. This software can be utilized by the village government to serve the people who want to take care of the letter and cover letter. Response and

input from community and village office staff is urgently needed for further software development. Response and input can be system functionality and a more ergonomic interface.

REFERENCES

Howard, M. and Worboys, C. (2003), Self-service – a contradiction in terms or customer-led choice?, *Journal of Consumer Behavior*, Vol. 2 No. 4, pp. 382-92.

<http://onlinelibrary.wiley.com/doi/10.1002/cb.115/abstract>

Kementrian Dalam Negeri (2015, December 31), *Susunan Organisasi dan Tata Kerja Pemerintah Desa*, September 29, 2017.

<http://ppid.kemendagri.go.id/dip/download/10010000192>

Nugraha, Ucu (2017). Analisis Sistem Informasi Pelayanan Desa XYZ Menggunakan Kerangka Kerja Pieces, *Jurnal Masyarakat Informatika Indonesia*, Vol. 2 No. 1 pp. 40-48

<http://ejournal.ferisulianta.com/download/JMII%20Vol%202%20No%201%202017/Paper%205%20JMII%20VOL%202%20No%201%20Tahun%202017.pdf>

Prasetya, H., Sholih., dan Artwodini, F, (2015), Perancangan Dan Pembuatan Sistem Informasi Manajemen Pustaka Pada Program Pendidikan Dokter Spesialis (Ppds) Anestesiologi Dan Reanimasi Rsud Dr. Soetomo. *Jurnal Teknik POMITS*.

<http://digilib.its.ac.id/public/ITS-paper-34474-5209100126-Paper.pdf>

Widodo, P.P dan Herlawati., 2011. Menggunakan UML (Unified Modeling Language), Bandung: Penerbit Informatika

THE EFFECTS OF TENGKU AGUNG SULTANAH LATIFAH BRIDGE TOWARD PHYSICAL DEVELOPMENT IN SIAK SUB DISTRICTS

Idham Nugraha¹, Febby Asteriani², Puji Astuti³, Retno Sawitri⁴, Firdaus Agus⁵

^{1, 2, 3, 4, 5}Urban and Regional Planning Departement, Universitas Islam Riau

Email: Idham.nugraha@eng.uir.ac.id

Abstract

The existence of Tengku Agung Sultanah Latifah Bridge is the main route access from and to the center of Siak's districts. That had the impacts of the development of the surrounding areas in Siak districts, mainly in the Siak sub districts. One of the impacts was physical development in Siak sub districts. Research objective was to identify the physical development impact toward the construction of the Tengku Agung Sultanah Bridge. The research methods were qualitative descriptive and quantitative. Prime and secondary data were used to determine the physical characteristics and the impacts of physical development after the construction of the Tengku Agung Sultanah Bridge. The results shown that the impacts of construction of Sultan Agung Sultanah Latifah bridge in the physical aspects were the change of city spreading pattern of concentric into linear pattern follow the pathway that direct to the bridge. The other impact was occurred land use change from non built up area into settlement and trading mainly in the city center and near of the bridge and the increasing the number of facilities and infrastructure in Siak sub districts.

Keywords: *access, bridge, physical development, land use*

1. INTRODUCTION

In terms of national development, the cities in Indonesia commit to develops their region. One of them was physical development, such as the development of facilities and infrastructure. The high availability of facilities and infrastructures will accelerate the social and economic development in the region (Prasetyo, 2017). The number of facilities and infrastructures were needed to respond the increasing the populations and their activities. Riau province was one of province in Indonesia that had the highest number of rivers. In geographical aspect, Riau province consisted of four main rivers like Siak, Rokan, Kampar and Indragiri. Therefore, Riau government tried to build bridges to improve their accessibility. One of them was The Tengku Agung Sultanah Latifah bridge that located in Siak Sri Indrapura districts.

The purposed of Tengku Agung Sultanah Latifah construction was to ease the access at Siak Sri Indrapura districts. The bridge was a facility that has functioned as an access point to or from Siak Districts to Pekanbaru city and vise versa. Before that, the access point was used ferry boat or boats. This bridge was connecting two lands that were separated by Siak river. Siak river as a big river in Riau Province that has width 100-150 meter with the depth was 20-29 meter and total length was 527 km. That made Siak river enables to pass by large ships. The constructions of Tengku Agung Sultanah Latifah bridge begin on 27 December 2002 with a cost amount of 277 billion rupiah from Siak District Expenditure Budget and the bridge start to operate from 11 August 2007.

There were some assumptions used in this research, towards the existence of Tengku Sultan Agung

Latifah bridge. The bridge was very influential to the development of surround area, such as :

a. The Population Movement

Regarding the existence of the bridge, the population movement in Siak sub districts becomes higher than before. That occurred because the people's activities will be speeded up and ease.

b. The Physical Development

The high number of people activities will affect the physical conditions in adjacent areas in this research was Siak sub districts. The change of physical could be in the form of land use change and the increasing the number of facilities and infrastructure.

c. The Improvement of Social and Economic Conditions

The existence of the bridge will improve the social and economic

conditions. With the high accessibility, that will be the trigger factors to the people come to the Siak sub districts and the will be improve the social and economic conditions.

Based on the above explanation, the research has a purposed that was to identify the effect of Tengku Agung Sultanah Latifah bridge toward physical development in Siak sub districts.

2. METHODOLOGY

The research methodology was used deductive approach and qualitative analysis. The first part was determined the theories related the city development and physical development. After that, the theories will be compared to the facts in the field. For the further explanation, the research methodology will be explained in table1

Table 1. The Steps of Research Analysis

No	Goal	Variables	Indicators	Analysis
1	The identification of physical characteristics in Siak Sub Districts.	The facts of physical conditions at Siak Sub Districts	Urban physical spreading: a. Social, economic conditions b. The physical characteristic conditions.	Descriptive Qualitative Analysis; a. The basic of city development. b. The pattern of city development
2	The analysis impacts of Tengku Agung Sultanah Latifah Bridge existence towards physical development in Siak Sub Districts	The City Development	The Development of Urban spread pattern; a. The land use pattern b. The pattern of transportation path c. The agglomeration of urban activities	This part was used descriptive qualitative and quantitative method based on primary and secondary data; 1. Primary data; based on field observation, interview to the government and the community with the number of samples was 202 people 2. Secondary data; government agencies
		Land Use Change	a. The urban land use b. The urban land use change	
		The increasing of the number Facilities and Infrastructures	a. The development of facilities and infrastructure b. The distributions of facilities and infrastructure	

Sources : The Results Analysis, 2013

3. RESULT AND DISCUSSION

Tengku Agung Sultanah Latifah bridge was located in the Kampung Rempak Village. The bridge characteristics were had length about 1.196 meters, width 16.95 meters with the pavements on the both sides, about 2.25 meters and the height of the bridge was 23 meters. The purposed of that bridge constructions was to ease the access into the Siak districts especially in Siak sub districts. These constructions have many benefits to the community around. Before the constructions, the access there was used ferry boat or boats. The bridge existence can be trigger factor in many aspects of Siak sub district's development, especially in economics,

physical and the other sectors that were being held by Siak government.

After the constructions of Tengku Agung Sultanah Latifah bridge, the Kampung Rempak Village had been significant developments especially in physical and economic aspect. The land use had been dominated by the settlements that follows the pattern of the roads and keep growing as the existence of the bridge. Besides that, the existence of the bridge was followed by the development of the facilities and infrastructures to support the activities. Today, The bridge also became the tourism icon in the Kampung Rempak Village, so made the village had high economic values

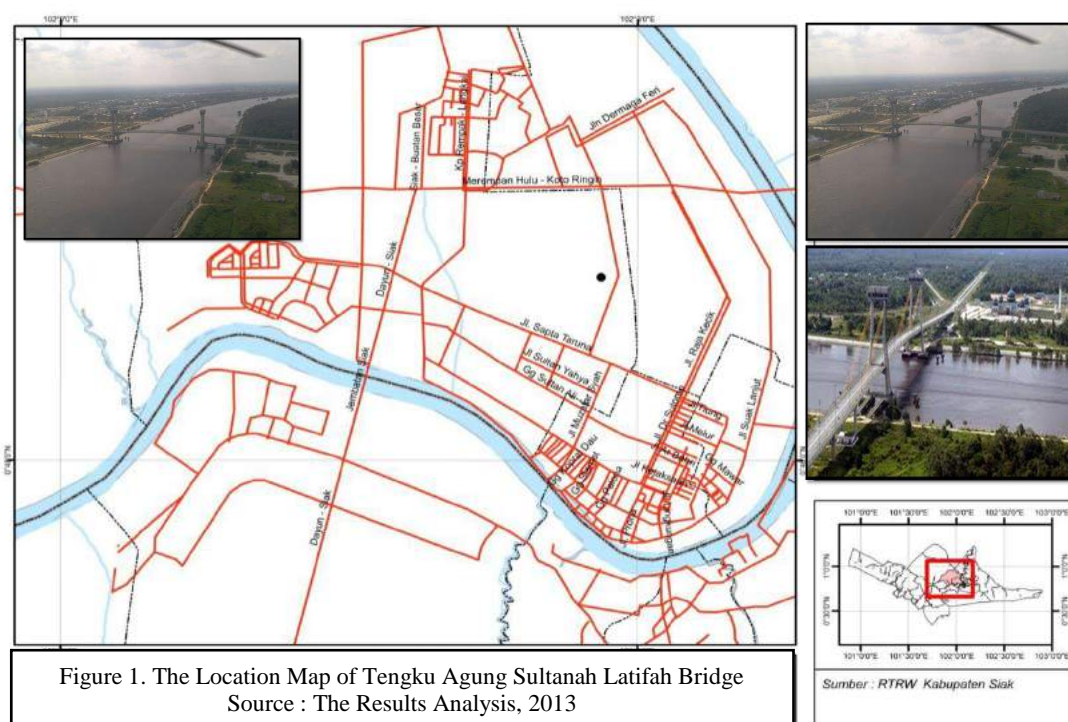

Figure 1. The Location Map of Tengku Agung Sultanah Latifah Bridge
Source : The Results Analysis, 2013

Based on analysis results of existing observation, the city development of Siak sub districts categorized as interstitial, that means the city had been develops inside. The areas and the height of building fixed while the quantity of built up land increased (Zahnd, 2006). The facts in Siak sub districts shown that the number of populations and built up land have been increased. The built up land in Siak sub districts encountered in the form of settlement, offices, commercials and the others supported facilities. The height of the building in Siak sub districts was dominated by two story building.

The spreading pattern of the physical conditions in Siak sub districts was occurring in all surround areas in Siak sub districts. In the beginning, the city spreading was centered in Siak sub districts and now the spreading was occurred following the road

path and Siak river such as the Suak Lanjut village, Kampung Rempak village, Langkai village and another village. The Kampung Rempak village has the significant spreading with the form of linear pattern. Linear pattern was the spreading following the road pattern while the areas near the road was faster than other areas, especially that has a radial pattern from main city (Yunus, 2001).

Based on primary and secondary data analysis, that be concluded three points related the effects of Tengku Agung Sultanah Latifah bridge existence, there were :

- a. There were occurred the development of the city spreading from the concentric patterns in the Kampung

Dalam village into the linear pattern follow the road path leads to the bridge in the Kampung Rempak Village.

- b. There were occurred land use change, when before the constructions built up land has large amount 1.474,98 Ha and non built up land amount 38.363,22 Ha. After the constructions, the built up land area has been increased in the amount of 10.736,54 Ha and the total were 12.211,52 Ha.
- c. The number of facilities and infrastructures has been increased after the construction. The kind of facilities that's been increased was housing, trade and services, education, health and places of worship and open space of social activities and the infrastructure were the increasing number of road network and drainage.

That was opposite with non built up land area, the total non built up land area after the constructions were 27.626,68 Ha.

Table 2. The Physical Development of Siak Sub Districts

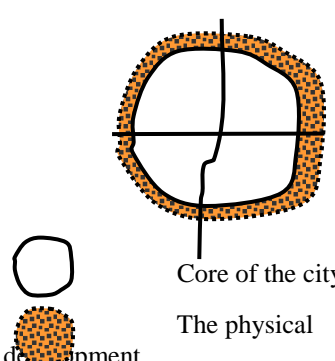
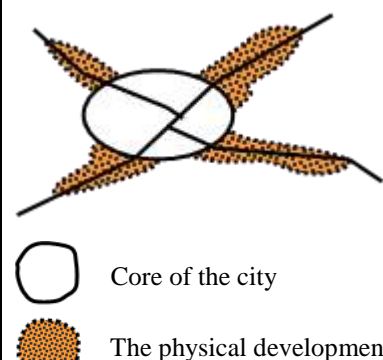
Variables	Before The Construction	After The Construction
The pattern of City Spreading	<p>The city spreading has concentric pattern and centered at Kampung Dalam Village.</p>  <p>Core of the city The physical development</p>	<p>The city spreading has linear pattern follows the road path and the physical development has been seen in another village that leads into the bridge (Kampung Rempak)</p>  <p>Core of the city The physical development</p>
Land Use	<p>Built up land area : 1.474,98 Non Built up land : 38.363,22 Total : 39.838,20</p>	<p>Built up land area : 27.626,68 Non Built up land : 12.211,52 Total : 39.838,20</p>
Facilities and Infrastructures	<p>Facilities :</p> <p>Housing : 4.914 Worship : 30 Education : 17 Health : 13</p> <p>Economic facilities : Trade and service has been focused on Kampung Dalam Village</p> <p>Open Space Facilities : sports field and city parks available in front of Siak Palace.</p>	<p>Facilities :</p> <p>Housing : 5.409 Worship : 42 Education : 32 Health : 30</p> <p>Economic facilities : Trade and service have been spreading to Kampung Rempak village and surrounding areas.</p> <p>Open Space Facilities : There is city parks near the bridge location.</p>
	<p>Infrastructures :</p> <p>Road network : The road hardening has been focused in the center of Siak sub</p>	<p>Infrastructures :</p> <p>Road network : The road hardening not longer focused in the center of</p>

Variables	Before The Construction	After The Construction
	<p>districts while the others road still encountered the road with the dirt and gravel road. Besides that, the main access still used ferry boat.</p> <p>Drainage : there were many drainages that not optimized yet.</p> <p>Electricity : there were electricity organized by PLN, but not in 24 hour service</p>	<p>Siak sub districts, but also focused in the other areas. That improvement has been seen in the areas near the bridge.</p> <p>Drainage : the permanent drainage has been established consisted of cement and concrete materials.</p> <p>Electricity : there were improvement related the service range and has been available in 24 hours.</p>

Source : *The Results Analysis*, 2013.

4. CONCLUSION

So the conclusion of this paper is drawn as follows :

- a. The basic development in Siak sub districts categorized as interstitial class, that means the areas and the height of the building fixed while the quantity of built up land increased.
- b. The pattern of the city spreading in Siak sub districts included in a linear pattern that follows the road network pattern.
- c. The facilities such as housing, trade and service, education, worship and open space has been improved in term of quantity and quality.
- d. The infrastructures have been improved, especially in term of road and drainage networks.

REFERENCES

- Bintarto, R. (1989). *Interaksi Desa-Kota dan Permasalahannya*. Jakarta : Ghalia Indonesia.
- Falina, Erna Dewi. (2009). *Pengaruh Keberadaan Jembatan Gadang – Bumiayu terhadap Perubahan Fisik Binaan Kelurahan Bumiayu*. Tugas Akhir, Fakultas Teknik Perencanaan Wilayah dan Kota, Universitas Brawijaya. Malang.
- Hidayah, Asmaul Chusnah. (2012). *Dampak Beroperasinya Jembatan Suramadu terhadap Perkembangan Wilayah Surabaya Dan Bangkalan*. Penelitian, Fakultas Ilmu Sosial Pendidikan Geografi, Universitas Negeri Surabaya.
- Hotijah, Siti. (2010). *Perkembangan Industri Dan Pendapatan Daerah Kabupaten Bangkalan Sebelum dan Sesudah Pembangunan Jembatan Suramadu*. Tugas Akhir, Program Studi Pendidikan Ekonomi Koperasi, Fakultas Ekonomi. Universitas Negeri Surabaya.
- Jayadinata. Johara. T. (1999). *Tata Guna Tanah dalam Perencanaan Pedesaan Perkotaan & Wilayah*. Penerbit : ITB Bandung.
- Marta, Ery. (2012). *Pengaruh Aktivitas Pariwisata terhadap Kondisi Lingkungan, Sosial dan Perekonomian Masyarakat (Studi Kasus: Istana Kerajaan Siak Kabupaten Siak)*. Tugas Akhir, Fakultas Teknik Perencanaan Wilayah dan Kota, Universitas Islam Riau. Pekanbaru.
- Rafi, Muhammad. (2011). *Identifikasi Faktor-Faktor Pendorong*

Perkembangan Fisik Kota Pekanbaru.
Tugas Akhir, Fakultas Teknik
Perencanaan Wilayah dan Kota,
Universitas Islam Riau. Pekanbaru.

Rohayati. (2013). *Pengaruh Pembangunan Jalan Siak-Buatan II terhadap Perkembangan Wilayah (Studi Kasus Kec. Koto Gasib & Kec. Mempura Kabupaten Siak).* Tugas Akhir, Fakultas Teknik Perencanaan Wilayah dan Kota, Universitas Islam Riau. Pekanbaru.

Sadyohutomo. Mulyono. (2008).
Manajemen Kota dan Wilayah.
Penerbit : PT. Bumi Aksara.

Yunus, Hadi Sabari. (2001). *Struktur Tata Ruang Kota.* Penerbit : Pustaka Pelajar

Zahnd. Markus. (2006). *Perancangan Kota secara Terpadu, Teori Perancangan Kota dan Penerapannya.* Penerbit : Kanisius

ANALYSIS OF FRAME LOSS POSITION INFLUENCE AND TYPE OF VIDEO CONTENT TO PERCEIVED VIDEO QUALITY

Yoanda Alim Syahbana¹, Memen Akbar²

^{1,2} Politeknik Caltex Riau, Indonesia

Email : yoanda@pcr.ac.id

Abstract

Video frame loss that is occurred due to low quality of internet stream influences perceived quality that is experienced by viewer. This research is focused to analyze how significant position of the frame loss in degrading the perceived quality on different characteristic of video content. Experiment has been conducted to vary Group of Picture (GOP) lost in three video contents i.e. head-and-shoulder video, fast moving object video, and video with printed words. 18 videos has been generated and showed to 47 assessors in video quality assessment based on ITU P.910 recommendation. Result of the experiment shows that lost of video frame in beginning, middle, and end of video degrades the perceived quality with average Mean Opinion Score (MOS) value 2.74. Based on the video content, video with fast moving object does not significantly influenced by position of frame loss (σ MOS=0.20). Result of the research can be used as knowledge base to implement strategy to stream the video. Therefore, optimum perceived video quality can be achieved in limited network resource. Further research can be designed to analyze other type of frame loss position, different kind of video content, and number of video quality assessor.

Keywords: *Video Quality, Video Frame Loss, ITU-P.910*

1. INTRODUCTION

Development of video service is supported by availability of internet access. The development triggers variety of video services such as video call, live video stream, IPTV, and Video on Demand (VoD). Service customer uses the service to communicate with other, to retrieve information, and to watch entertainment. Customer is also served with ease of access due to development of mobile technology.

With this advancement and feasibility, video service has become part of their everyday life.

One of the most popular video services is VoD that can be accessed from www.youtube.com site. In this service, service customer can independently select type of video content they want to watch and when to watch it. Service provider only acts as server of video content. Customer satisfaction for the service is mostly

influenced by perceived video quality (Winkler and Mohandas, 2008). The satisfaction will determine continuity of service access and in long term, the satisfaction will affect potential profit of service provider (Bautkauskas and Kajackas, 2010). Based on Winkler and Mohandas (2008), the perceived video quality is determined by quality of video frame. When quality of video frame is degraded, the perceived video quality will also degraded.

This publication presents result of research that analyzes how significant position of the frame loss in degrading the perceived quality. The result is presented in four sections including this introduction section. Second section provides research methodology that has been conducted. Result and its discussion are discussed in thisrd section. By the end of the publication, the fourth section conclude entire research finding.

2. METHODOLOGY

The experiment is designed for three phases as shown in Figure 1. Experiment is started by phase 1, preparation of video test material. This phase consist of two steps. In the first step, three video contents are downloaded from Consumer Digital Video Library (CDVL) as repository of research video content. Three videos represent general video content that is watched by the VoD customer. There are head-and-shoulder video, fast moving object video, and video with printed words. Each of these videos has 250 video frames. Figure 2 presents sample of the three video contents. All of the video is modified based on three pattern of video frame loss. The pattern is adopted from research by Vakili (2011) that deletes video frame based on three types of video frame (I/P/B) in one Group of Picture (GOP). The pattern is summarized in Table 1. The second step applies the pattern using FFMpeg software. This first phase generates 27 video test materials.

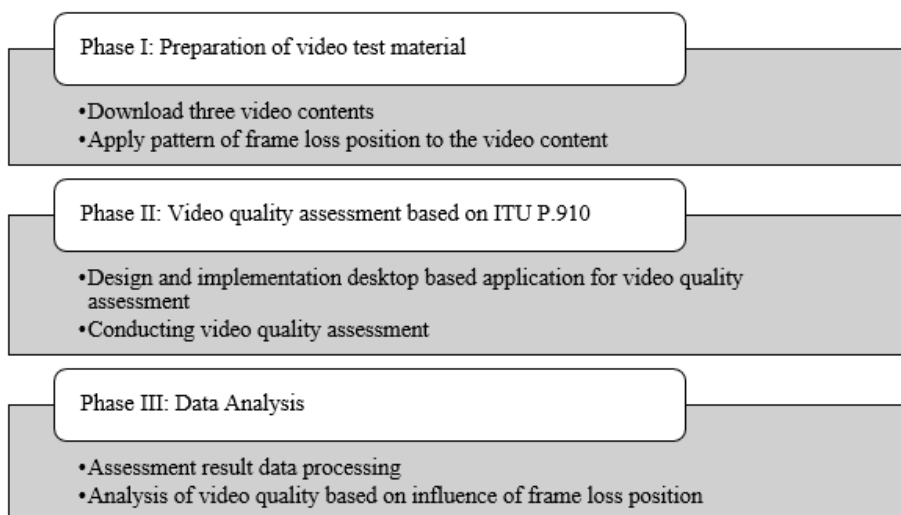

Figure 1. Research Phase

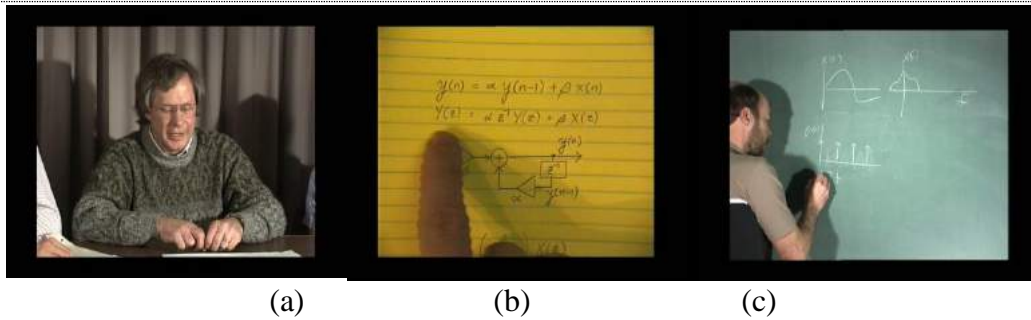

Figure 2. (a) head-and-shoulder video, (b) fast moving object video, (c) video with printed words

Table 1. Pattern of Frame Loss Position

Pattern ID	Position of Frame Loss	Type of Frame	Number of Frame Loss
1	Middle of stream	I-frame	10
2	Middle of stream	P-frame	14
3	Middle of stream	B-frame	15
4	Beginning and end of stream	I-frame	20
5	Beginning and end of stream	P-frame	28
6	Beginning and end of stream	B-frame	30
7	Beginning, middle, and end of stream	I-frame	30
8	Beginning, middle, and end of stream	P-frame	42
9	Beginning, middle, and end of stream	B-frame	45

The second phase is focused to design and to implement desktop based application to assess the video quality. The application design is referred to ITU P.910 Recommendation (ITU, 2008). Figure 3 shows interface of the developed application. Using the application, video quality assessment is performed based on assessment framework in ITU P.910

Recommendation. Illustration of the assessment framework is provided in Figure 4. 47 assessors have participated in this research. They are 18 to 22 years old and comprised of 29 male and 18 female. All of the assessor are university student of Politeknik Caltex Riau and among of them, only 26% that uses eyeglasses.

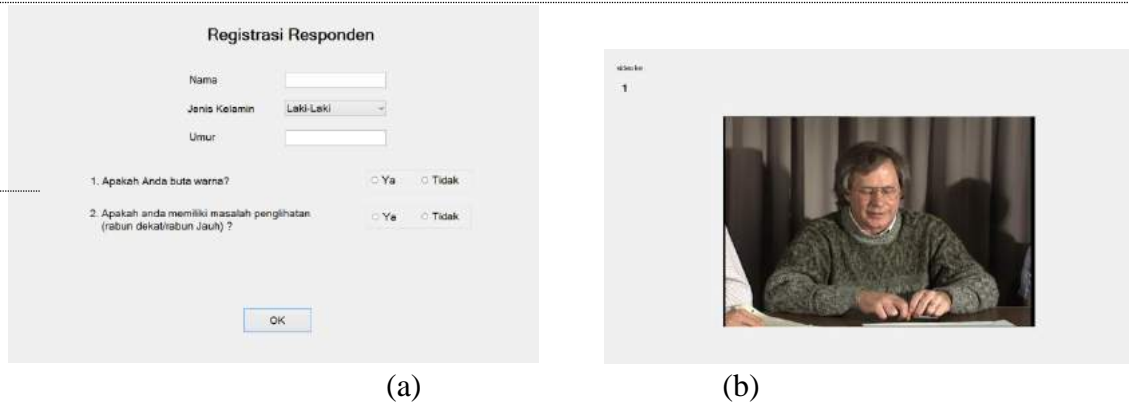

Figure 3. (a) Application interface for assessor information (b) Application interface for video test material

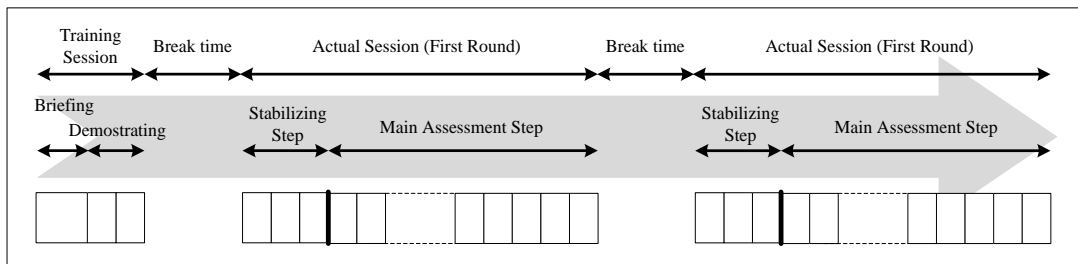

Figure 4. Video quality assessment framework

The third phase of the research is aimed to analyze result of the video quality assessment. The phase is divided into two steps i.e. result processing and analysis of video quality based on influence of frame loss position. Result of this phase is further discussed in the next section.

3. RESULT AND DISCUSSION

The assessment result is presented in Table 2. The result is organized based on frame loss position for each video content. Result of the assessment is calculated based on Mean Opinion Scale (MOS). The MOS is ranged from 1 to 5 that represents perceived quality of video from lowest to highest.

Table 2. Assessment Result

Frame Loss Position	Video Content	Type of Frame Loss	MOS Value
Middle	head-and-shoulder video	B-Frame	3.71
Middle	video with printed words	B-Frame	2.52
Middle	fast moving object video	B-Frame	3.35
Middle	head-and-shoulder video	P-Frame	2.90
Middle	video with printed words	P-Frame	2.99
Middle	fast moving object video	P-Frame	3.33

Frame Loss Position	Video Content	Type of Frame Loss	MOS Value
Middle	head-and-shoulder video	I-Frame	2.29
Middle	video with printed words	I-Frame	2.54
Middle	fast moving object video	I-Frame	3.32
Beginning & End	head-and-shoulder video	B-Frame	3.33
Beginning & End	video with printed words	B-Frame	2.78
Beginning & End	fast moving object video	B-Frame	3.70
Beginning & End	head-and-shoulder video	P-Frame	2.81
Beginning & End	video with printed words	P-Frame	2.22
Beginning & End	fast moving object video	P-Frame	3.61
Beginning & End	head-and-shoulder video	I-Frame	2.45
Beginning & End	video with printed words	I-Frame	2.06
Beginning & End	fast moving object video	I-Frame	3.50
Beginning-Middle-End	head-and-shoulder video	B-Frame	3.21
Beginning-Middle-End	video with printed words	B-Frame	2.30
Beginning-Middle-End	fast moving object video	B-Frame	2.84
Beginning-Middle-End	head-and-shoulder video	P-Frame	2.89
Beginning-Middle-End	video with printed words	P-Frame	2.54
Beginning-Middle-End	fast moving object video	P-Frame	2.98
Beginning-Middle-End	head-and-shoulder video	I-Frame	2.42
Beginning-Middle-End	video with printed words	I-Frame	2.57
Beginning-Middle-End	fast moving object video	I-Frame	2.92

Based on the result, average MOS for video with frame loss position in the middle is

2.99. On the other hand, average MOS for video with frame loss position in the beginning and end of video is 2.94.

Compared to these two averaged MOS result, video with frame loss position in the beginning-middle-end position experiences the most degraded quality with average

MOS of 2.74. If this result is further analyzed based on video content, the result is displayed as line chart as shown in Figure 5

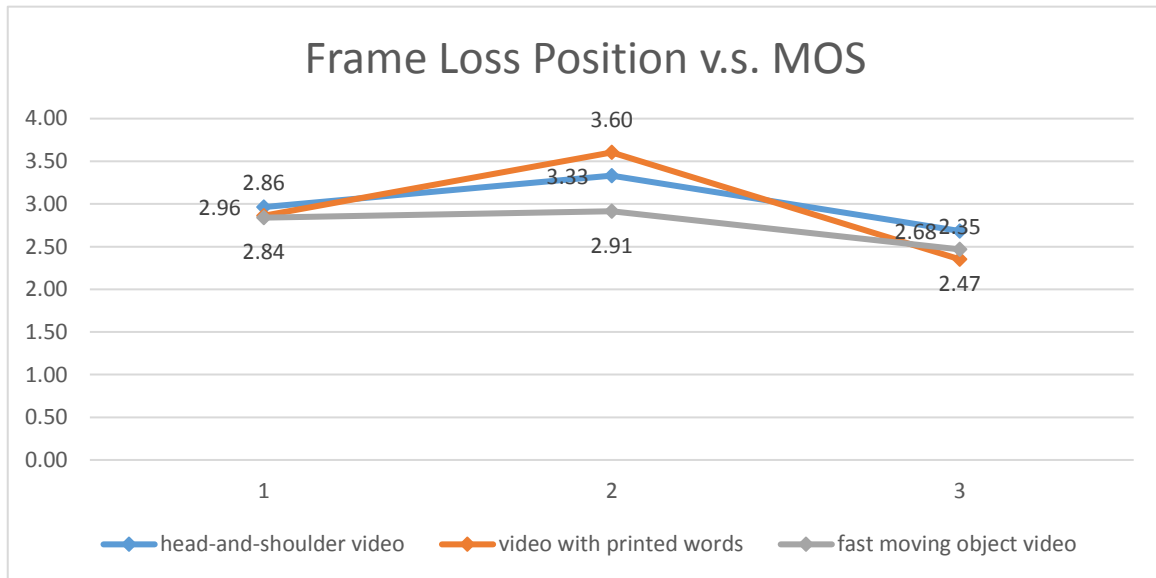

Figure 5. MOS value for three video contents and three frame loss position

The x axis represent frame loss position; 1 for frame loss in middle position, 2 for frame loss in beginning and end position, and 3 for frame loss in beginning-middle-end position. From Figure 5, head-and-shoulder video ($\sigma_{MOS}=0.27$) and video with printed word ($\sigma_{MOS}=0.51$) have mostly affected by variation of frame loss position. However, video with fast moving object has better quality in variation of frame loss position ($\sigma_{MOS}=0.20$).

4. CONCLUSION

Based on analysis of the experiment result, position of frame loss does affect perceived quality that is experienced by the service customer. While comparing result from video with frame loss position in the middle, in the beginning and end, and in the beginning-middle-end, the third one is assessed as the lowest quality by assessor of conducted video quality assessment. However, influence of frame loss position is

insignificant in video with fast moving object while compared to head-and-shoulder video and video with printed words. This research can be further studied to analyze different pattern of frame loss position for different video content and number of video quality assessor.

REFERENCES

- Batkauskas, V. dan Kajackas, A. (2010). Quality of Heterogeneous Mobile Data Services: Capabilities and End-user Achievements. *Electronics and Electrical Engineering*. -Kaunas: Technologija. 5(101), 43-46.
- <http://www.cdv1.org/>
- ITU. (2008). Recommendation P.910 - Subjective Video Quality Assessment Methods for Multimedia Applications. Geneva: International Telecommunication Union.
- Vakili, A. (2011). Impact of Frame Loss Position on Transmitted Video Quality:

Models and Improvement. *2011 Fifth FTRA International Conference on Multimedia and Ubiquitous Engineering*. Loutraki, 2011, pp.113-118.

Winkler, S. dan Mohandas, P. (2008). The Evolution of Video Quality Measurement: From PSNR to Hybrid Metrics. *IEEE Transactions on Broadcasting*. 54(3), 660 - 668. IEEE.

AN OVERVIEW OF FINGERPRINT TEMPLATE PROTECTION APPROACHES

Apri Siswanto,^{1,2} Norliza Katuk,¹ Ku Ruhana Ku-Mahamud,¹ and Evizal Abdul Kadir²

¹School of Computing, University Utara Malaysia, Malaysia

²Teknik Informatika, Fakultas Teknik, Universitas Islam Riau, Indonesia

Email: norliza@uum.edu.my, ruhana@uum.edu.my
aprisiswanto@eng.uir.ac.id, evizal@eng.uir.ac.id

Abstract

One possible attack in the biometric system is the template stored in the database. This attack can cause Biometric template information leakage, thus pose a serious privacy security threat. Most available template protection techniques fail to meet all the desired requirements of practical biometric systems such as diversity, revocability, security, and performance matching accuracy. This paper aims to review the various fingerprint template protection (ftp) approaches that have been proposed by researchers in recent decades. Some of the proposed schemes are standard encryption, biometric cryptosystem, template transformation, hybrid scheme and homomorphic encryption.

Keywords: *biometric system; fingerprint template protection; security, diversity, revocability*

1. INTRODUCTION

Biometric templates offer a reliable approach to user authentication issues in identity recognition systems. A wide range of biometric technologies are developed effectively that include fingerprint, iris, face, iris, palms, signature and hand geometry. Fingerprints are the most popular as they are easily captured, as well as low cost sensors and algorithms. The main purpose of using fingerprint biometric systems is to provide good authentication and can not be rejected. Authentication implies that only authorized users be able at access logical or physical resources protected by finger print systems and impostors are prohibited from accessing protected resources. From the user's perspective, there are two key requirements that fingerprint biometric

system must be fulfilled. First, legitimate users should have timely and reliable access to protected resources / services. Second, biometric systems and personal data stored on it should be used only for the intended functionality, which is It is controlling access to certain resources and not for other unintentional purposes [1].

However, adversary attacks can make the biometric system not functioning properly according to the above requirements. To overcome and protect the biometric template information both in the process of registration/enrollment and authentication in the stored database, some techniques have been proposed by the researchers include standard encryption, biometric cryptosystem, template

transformation, hybrid method and homomorphic encryption. This paper aims to summarize and present information on various fingerprint template protection techniques. The technique used is systematic literature review. The paper is organized in the following way. Section 2 of the paper discusses the attack on fingerprint template. Then, Section 3 presents desirable properties of fingerprint template protection. After that, Section 4 discusses fingerprint template protection approaches and Finally, Section 5 concludes the paper.

2. ATTACK ON FINGERPRINT TEMPLATE

The security ensured by the fingerprint biometric systems can itself be compromised. The general analysis of a fingerprint biometric system for vulnerability assessment determines the extent to which an imposter can compromise the security offered by the fingerprint biometric system. Many of the attacks are applicable to any information in fingerprint biometric system, the attacks can be using fake fingerprint biometrics and template modification are unique to biometric systems. According to Ratha, et al. [2] Biometric recognition system has some vulnerable point attacks. Attacks that may occur in the fingerprint verification system is as follows :

1. Attack at the sensor, A fake biometric sample can be presented in a sensor to gain access such as a fingerprint trace of an object touched by that person.
2. Replay Attack, There is a possibility of the adversary to interpret or obtain a digital copy of a stored biometric sample and replay this signal that passes through the biometric sensor.
3. Trojan horse attacks, The feature extractor can be replaced with a program that generates a set of desired features.
4. Spoofing the features, the features vector generated from biometric samples are replaced by a set of synthetic (fake) features created.
5. Attack on matcher, the matcher can also be subjected to Trojan horse attacks that always result in high or low match scores regardless of where the user presents the biometric on the sensor.
6. Attack on templates, the templates generated during the user enrollment can be stored locally or in network location that modify the saved template or replace it with a new template.
7. Attacks on communication channels, Data transferred through a communication channel can be intercepted for malicious reasons and modified and reinserted into the system.
8. Attack on the decision module, The final decision generated by the biometric system can be replaced by the Trojan horse program.

Biometric matching is usually only part of a larger information and information security management system. Thus the non-biometric module in the whole system can also introduce some security flaws. There are several techniques to disrupt attacks at various points. For example, sensing a finger conductivity or pulse can stop a simple attack on the sensor. Encrypted communication channel [3] can eliminate at least remote attack on synthesized feature factor and override final decision. The simplest way to stop attacks at override matcher, attacking the channel and modify template in database is to have the matcher and database reside in a secure location. Storing templates in a smartcard that a user brings with them to the point of service can also eliminate some attacks of type stored template [4].

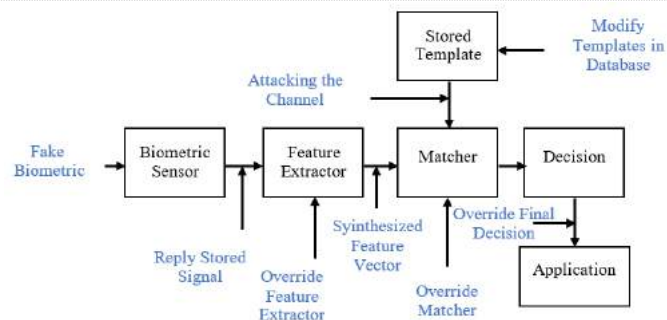

Fig. 1 Possible attack in fingerprint template protection

3. DESIRABLE PROPERTIES OF FINGERPRINT TEMPLATE PROTECTION (FTP)

The performance of biometric template protection systems can be evaluated by three categories namely, protection, operational and technical. Performance protection includes the irreversibility and diversity of biometric information. Operational performance can be evaluated with the independence of modality, interoperability, and Quality of Performance. Technical performance can be evaluated with accuracy, throughput, storage requirements [5]. There are four major requirements when a biometric template protection algorithm is designed: [6]

- A. Revocability: When the biometric template is compromised, it should be possible to revoke the compromised template and reissue a new template based on the biometric trait.
- B. Diversity: The cross-matching of secured templates should be ensured in such a manner that the privacy of the true owner of the template should be ensured.
- C. Security - It should be extremely difficult to generate the original biometric feature set from the protected biometric templates.
- D. Performance: The biometric template protection techniques developed should not decrease the accuracy of the recognition system.

4. FINGERPRINT TEMPLATE PROTECTION (FTP) APPROACHES

The major fingerprint template protection schemes can be categorized into standard encryption, biometrics cryptosystem, template transformation, hybrid methods, and homomorphic encryption such as shown in Figure 2. Each of these schemes will be discussed in detail in the following sections.

A. Standard Encryption

The easiest way to secure fingerprint templates is by encrypting them using standard cryptographic techniques like RSA, DES and AES. This is the methodology used in most commercial biometric systems. However, it must be emphasized that some acquisitions with the same biometric properties do not produce the same feature set. Typically, the standard encryption function is not a smooth function and a small difference in the feature set values extracted from raw biometric data will result in a huge difference in the resulting encrypted features. Consequently, one cannot perform biometric matching directly in an encrypted domain. Instead, the template should be decrypted to match the query feature. As a result, the original biometric feature is exposed during each authentication attempt, irrespective of

whether the authentication is eventually successful. Therefore, the encryption solution is secure revocable only under ideal conditions (key is kept secret and matching is done at a trusted location). If practical issues such as key management or

susceptibility to template theft during a matching attempt are taken into account, the standard encryption technique is not good enough for securing biometric templates [6, 7].

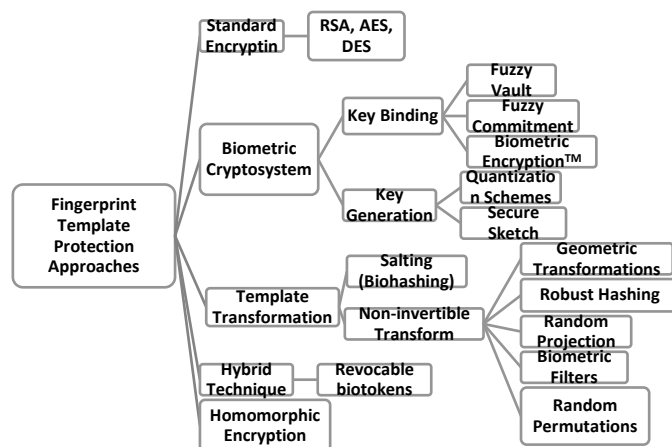

Fig. 2 A hierarchical taxonomy of FTP

B. Biometric Cryptosystem

In the biometric cryptosystems data information about the biometric template, called helper data, and stored in the database [8]. The data helper does not show important information about the original biometric template but is needed when matching the cryptographic key of the query biometric feature. Matching is done indirectly by verifying the truth of the extracted key. Error correction coding techniques are usually used to handle intra-user variations. Biometric cryptosystems offer high security but, not designed to provide diversity and revocability. Cryptosystem biometrics are grouped into key binding and key generation systems based on how the helper data is derived [6]. Some of the techniques in this category are fuzzy vault, biometric encryption and fuzzy commitments.

The first key binding fingerprint biometric cryptosystem was developed by [9], called Biometric Encryption™ (mytec2). This was an completed version of mytec1 [10]. This biometric encryption was not practical because of mismatch between accuracy and security. Then, the next key binding is fuzzy vault. Fuzzy vault is cryptography designed to work with biometric features that are represented as minutiae in fingerprints. The advantage of the fuzzy vault scheme is the ability to control the amount of security imparted to protected biometric templates by increasing the number of chaff points and consequently the difficulty of the polynomial reconstruction problem. Even though its popularity, analysis of the fuzzy vault scheme has indicated that this approach has several drawbacks. Chang, et al. [11] present observations to

differentiate minutiae from chaffpoints attacking fuzzy vaults based on fingerprints. Since the chaff points are made one by one, it created later tend reveal smaller empty surrounding areas which is verified experimentally, i.e., the security of a fuzzy vault highly relies on the methodology of generating chaff points.

Scheirer and Boulton [12] discussed the vulnerability of fuzzy vaults to three potential attacks, namely, surreptitious key-inversion (SKI) attacks, blended substitution attacks and attacks via record multiplicity (ARM). The authors suggest that a fuzzy vault is particularly vulnerable to ARM attacks, where access to two or more fuzzy vaults generated from the same biometric data, but with different keys and chaff points, would enable an adversary to easily identify the original points in the two vault and thus decode the vault.

Therefore, the fuzzy vault approaches does not gave diversity and revocability. This means that, if a fuzzy vault is compromised, a new vault cannot be created from the same biometric data by simply binding it with a different key. Furthermore, the vulnerability of fuzzy vaults to ARM attacks allows cross-matching of templates across different systems, thereby user privacy is not ensured [13]. In a stolen key-inversion attack, if an attacker is able to recover the secret key embedded in the fuzzy vault (for example, through snooping), the secret polynomial may be directly reconstructed; thereby, the unprotected biometric template can be easily separated from the chaff points. A blended substitution attack is straightforward if an adversary is able to modify an existing fuzzy vault. In this attack, an impostor takes advantage of the myriad chaff points existing in the fuzzy vault to substitute some of these random points with his or her own biometric data, in which case both the

legitimate user and the impostor would be able to be identified using the same fuzzy vault. Kholmatov and Yanikoglu [14] extended Scheirer and Boulton [12] presenting experimental evidence that confirms a fuzzy vault's vulnerability to record multiplicity (correlation) attacks.

Nandakumar, et al. [13] further mention the possibility of exploiting the non-uniform nature of biometric features to launch an attack on a fuzzy vault based on statistical analysis of points in the vault. The authors also note the vulnerability of a fuzzy vault to attacks during the authentication stage, where a genuine user's original template is temporarily exposed and therefore vulnerable to snooping [15].

Another liability of the fuzzy vault scheme is the considerable increase in biometric template size as a result of the addition of a large number of chaff points. This may be undesirable in recognition systems that require a small template size. Furthermore, recognition accuracy may be adversely affected as a result of the large number of false points or too few true points in the protected template. For example, Clancy, et al. [16] implementation of the fuzzy vault on minutiae fingerprint showed an unacceptably high FRR of 20-30%.

Furthermore, key binding Fuzzy commitment Simoens, et al. [5] is a biometric cryptosystem that can be used to secure biometric traits represented in the form of binary vectors. This characteristic of fuzzy commitment scheme makes it useful for applications biometric authentication systems, in which data is subject to random noise. Because the scheme is tolerant of error, it is capable of protecting biometric data such as conventional cryptographic techniques,

such as hash functions, are used to protect alphanumeric passwords [17].

In the key generation biometric cryptosystems, the helper data is generated only from biometric templates and cryptographic keys directly generated from helper data and query biometric features. The direct key generation of biometrics is an attractive template-protection approach that can be very useful in cryptographic applications. Nevertheless, it is problematic to generate a key that could fund at the same time high stability and entropy due to intra-user variation in the template. It's hard to develop a scheme that generates the same key for different templates of the same person and at the same time very different keys for different persons. E.g. quantization schemes and secure sketch.

In the quantization scheme method, helper data is quantized to obtain a stable key. This scheme takes feature vectors from multiple biometric samples and gets feature element intervals. The interval is encoded and then stored in helper data. Throughout authentication, biometric features are calculated and mapped to determined intervals. Several studies in this method such as [18] use the Divide and Conquer method for fingerprint images, and bio keys are generated using minutia set. Yang, et al. [19] proposed a fingerprint cryptosystem by modifying Voronoi Neighbor Structure (VNS). In the same year, Yang, et al. [20] focused on the using of "Delaunay Quadrangle-based fingerprint authentication system that uses topological code for local enrollment and security enhancements."

C. Template Transformation

In this approach, the transformation function algorithm (F) is applied to the biometric template (T) and the result is stored in the database. The transformation function parameter usually comes from a

random key (K) or password. The matching process is performed on the transformed domain. The feature transformation approach scheme can be further categorized as *salting* or *non-invertible transforms*. The security of salting schemes is based on the secrecy of the key or password. While, the security of non-invertible transformation techniques uses one way functions computationally difficult to invert, even if the key is known. Nevertheless, the disadvantage of these techniques is that security of the system is very difficult to verify due there is no foundation of mathematical to perform a robust security analysis and it is assumed that the distribution of uniform biometric features [21] and enemies may be able to utilize non-uniform biometric properties to launch attacks that may require less effort to compromise system security.

- Salting

Salting is a an approach used two-factor authentication scheme, in which an unprotected biometric template is transformed into a protected template via a function Specified by an external key or a user-specific keyword. Because transformations can be reversed for the most part, keys must be kept or remembered securely by the user and presented during authentication. The need for additional information is the key to improving entropy from biometric templates and therefore making it difficult for opponents to guess templates [6].

The limitations of the salting approach is that the security of this scheme depend on the secrecy of the key or password [15, 22]. As a result, effective key management procedures must be put into place, or else the user is obliged to memorise the secret key; however, relying on users' memory for the protection of complex secret keys re-

introduces the weakness of password-based schemes that we are trying to circumvent. Since matching is performed directly in the transformed domain, the salting functions must be designed such that they do not have an adverse effect on the recognition performance. This becomes especially important in the presence of large intra-user variations. Salting methods generally use quantization to deal with intra-user variability during matching in the transformed domain.

Several studies related to fingerprint salting approach will be discussed below. Teoh et al [23] introduced the bio phasor technique. This method is the pseudo-random number mixing iteration with the fingerprint feature. This work is considered a stolen key scenario. Then, Jin, et al. [24] proposed salting biohashing. The biohashing procedure was initially proposed for the fingerprint modality, and it consists of two stages. Firstly, the extracted fingerprint feature vector is transformed into a translation, rotation, and scale invariant feature set, employing the Wavelet Fourier-Mellin Transform (WFMT)². Secondly, the resulting data is discretised via an inner product computation between the invariant feature vector and a tokenised pseudorandom number sequence. The second stage of this process produces the protected biometric template vector, which is referred to as a BioHash.

The Biohashing procedure has been proven to be advantageous in several ways. Firstly, biohashing simultaneously provides high intra-class variation and extremely low inter-class correlation, which essentially leads to an Equal Error Rate (EER) of zero (when the legitimate token is used). This means that the occurrence of a False Accept is eliminated without a corresponding increase in the

FRR [25]. It has also been claimed that Biohashing has a high tolerance to data capture offsets, such that the same biometric trait acquired at different times will produce highly correlated bit strings (BioHashes) [24]. This is due to the invariance of the feature vector created during the first stage of the Biohashing process, as well as the subsequent discretization of the invariant feature vector in the second stage. Another advantage of Biohashing is that it addresses the problem of irrevocability of biometric features: a user's compromised BioHash can be easily revoked and replaced with a new one by using a different secret seed for enrolment. However, Biohashing schemes have weaknesses that have been presented by researchers. The most commonly analysed limitation of the Biohashing approach is the degradation in matching performance when an adversary has access to a user's secret key (seed) and uses the legitimate key with their own biometric features in order to fool the system into authenticating them [26].

Several researchers have presented methods for resolving performance degradation resulting from a stolen-token scenario, such as [27-29]. Because a salting approach is by nature invertible, almost no existing literary works focus on improving the non-invertibility property of Biohashing; however, there are two suggestions presented in [30, 31]. In fact, Biohashing on its own technically cannot be made to be noninvertible. A hybrid protection scheme, incorporating techniques other than salting, would be required; for example, applying Biohashing to a non-invertible template. Other salting techniques, which do not adopt Biohashing, are also available in the literature; such as [32, 33].

- *Non-Invertible Transform*

One-way functions applied to biometric data. To update biometric templates, function parameters must be changed. In case the transformed parameters are compromised the attacker can not reconstruct the original biometric template. Because of intra-class variations, transformations need to align biometric templates to perform effective comparisons and this leads to reduced authentication performance. A non-invertible transform shows the impossibility on obtaining the original biometric data from its transformed version. The parameters of the transformation function are specified by a key, but knowledge of the key and/or the transformed template does not facilitate recovery of the original biometric template [6, 34].

The major advantage of the non-invertible transform scheme approach compared to the salting approach, and it means that biometric templates that are protected using non-invertible transforms are generally more secure than those protected using the salting approach. Then, a related advantage of the non-invertible transform approach is that, unlike salting, it does not require storage of any secret information. The next positive aspect of non-invertible transforms is that they tend to leave the protected biometric template in the same feature space as its unprotected counterpart. In this case, intra-user variations in the transformed biometric templates can be robustly handled by using existing, sophisticated matchers, thereby reducing the error rates of the biometric system [35]. Furthermore, the matching scores obtained are proportional to those obtained in the original space, and thus can be used in the design of a secure multibiometric system through a scoreline-level fusion method.

The main limitation of the non-invertible transformation method lies in the difficulty of designing a good one-way function. The transformation function must ensure that the biometric features from the same user maintain a high similarity in the transformed space, while features from different users are completely unrelated after transformation. However, the transformation must also be non-invertible, so that an adversary is unable to collect any information about the original biometric template from its protected counterpart. There is a trade-off between discriminability and non-invertibility, since it is challenging to design transform functions that satisfy both requirements simultaneously.

Consequently, often the greater the amount of distortion applied to the original biometric data by the transformation, the worse the recognition performance among the protected biometric templates. This means that the non-invertible transform approach typically suffers from a security versus performance trade-off. Furthermore, the transformation function relies heavily on biometric features to be used in specific applications. This analysis makes evident a clear comparison between the salting and non-invertible transform approaches. While salting schemes (such as BioHashing) generally tend to either preserve or improve the recognition performance of the biometric system into which they are incorporated, non-invertible transforms often have the effect of degrading the recognition accuracy somewhat. On the other hand, non-invertible transforms tend to impart more security to the protected biometric templates compared to salting approaches, which are invertible with the revelation of the user-specific key.

In this scheme, the most influential researcher are Ratha, et al. [36]. They proposed and analyzed cancelable biometrics fingerprint using non-invertible transforms for generating fingerprint templates. The scheme of cancelable biometrics is to change the raw biometric templates by using either feature or signal domain transformations. Cartesian, polar and functional are the three functions of the transformation. These functions used to transform fingerprint minutiae data so that a minutiae matcher can still be applied to the transformed minutiae.

For the functional transformation, Ratha, et al. [37] used a mixture of 2D Gaussians and electric potential field in a 2D random charge distribution as a means to translate the minutia points. Research with the same technique is also done by Yang, et al. [38] who developed a non-invertible transformation for fingerprints by considering local and global features of minutia points. The distance between the minutiae pair is projected vertically to the circle. Later, Lee and Kim [39] proposed a new representation of the minutiae points of the fingerprint image made using bit strings. Minutia points of the fingerprint image are mapped to a 3D array that is divided into small cells. A string of bits is generated by finding which cells include minutiae points. Subsequent research conducted by Zhe and Jin [40], they proposed the protection of a fingerprint template obtained using a projected MVD feature at random. Ahmad, et al. [41] introduced a pair of polar relationships of minutiae. The correlation-based filter method using chip matching was proposed by Takahashi and Hirata [42]. Wang and Hu [43] proposed the Densely Infinite To One Mapping (DITOM) approach use of Correlation Invariant Random Filtering (CIRF). Das, et al. [44]

meant a method based on the Minimum Distance graph. The hashing algorithm is constructed using this graph and an appropriate search algorithm is used to match the resulting hash. Ferrara, et al. [45] making the non-invertible Cylinder Minutiae Code (pMCC) for fingerprints as a fingerprint enhancement enhancement fingerprint..

D. Hybrid Methods

Several fingerprint template protection schemes used combination of feature transformation and biometric cryptosystems. Usually it called hybrid methods. Several hybrid system examples are presented in the literature, some of which even incorporate traditional cryptographic hashing functions into the hybrid protection system. For Example hardening a fingerprint-based fuzzy vault with a user-specific password, combined key binding with salting [13]. An application-specific key release scheme that retrieves a cryptographic key bound to a BioHashed fingerprint, combined salting with key binding methods [46].

In addition, Several studies that have been done in fingerprint template protection based on hybrid scheme are Boulton, et al. [47] presented revocable biotokens for fingerprint biometrics. This technique divides data into two parts fractional and integer parts. The fractional part performs the transformation and the integer part is encrypted.. The fractional part does the transformation and integer part is encrypted. Then, Feng, et al. [48] also developed a three-step hybrid algorithm based on random projection, discriminability-preserving (DP) transform, and fuzzy commitment scheme. In similar way, Nagar, et al. [30] constructing a hybrid cryptosystem with minutiae descriptors for fingerprints. This work used both fuzzy vault and fuzzy commitment scheme to build the cryptosystem. The helper data extraction involves fuzzy vault encoding

and the ordinate values secured by fuzzy commitment.

Furthermore, Chin, et al. [49] proposed a hybrid system using fingerprint and palmprint features, then Sandhya and Prasad [50] constructed Delaunay triangles from fingerprint minutiae. The features are transformed and then a cryptosystem was built using fuzzy commitment scheme. Convolution code was used to generate the error correction code. Finally, Jin, et al. [51] proposed a long ECC free key-binding scheme with a cancelable transforms for minutia-based fingerprint biometrics. The minutiae information is secured by a strong noninvertible cancelable transform called modified Randomized Graph based Hamming Embedding. The advantage of hybrid protection schemes is that they can combine the high revocability and diversity properties characteristic of feature transformation approaches with the high security offered by biometric cryptosystems [6]. After the text edit has been completed, the paper is ready for the template. Duplicate the template file by using the Save As command, and use the naming convention prescribed by your conference for the name of your paper. In this newly created file, highlight all of the contents and import your prepared text file. You are now ready to style your paper; use the scroll down window on the left of the MS Word Formatting toolbar.

E. Homomorphic Encryption

Another alternative, apart from the above 4 methods is homomorphic encryption. This technique allows a limited subset of calculations on encrypted data. Combining Homomorphic Encryption with a biometric recognition system will meet the requirements of Biometric Template Protection without degrading the accuracy [52]. The fingerprint template protection study under the Homomorphic Encryption scheme was developed at Rane et al. [53] They presented the calculation of Hamming distance for fingerprint applications. Then,

Barni, et al. [54] shows distributed biometric systems by utilizing cryptosystems, homomorphic encryption on Fingercodes templates in a semi-honest model.

5. CONCLUSION AND FUTURE

WORK

This paper provides and summarizes information about research issues related to fingerprint template protection. Based on a survey of 54 papers conducted it can be concluded that there are 5 techniques that can be done to solve the problem of fingerprint template protection that is encryption standard, biometric cryptosystem, template transformation, hybrid methods and homomorphic encryption. Then there has not been the best approach to template protection that actually meets the main requirements of template security, revocability, diversity and performance matching accuracy. Application requirements and user-desired scenarios play a key role in the selection of template protection schemes.

REFERENCES

- [1] A. K. Jain, K. Nandakumar, and A. Nagar, "Fingerprint template protection: From theory to practice," in *Security and Privacy in Biometrics*, ed: Springer, 2013, pp. 187-214.
- [2] N. K. Ratha, J. H. Connell, and R. M. Bolle, "An analysis of minutiae matching strength," in *International Conference on Audio-and Video-Based Biometric Person Authentication*, 2001, pp. 223-228.
- [3] B. Schneier, "Security pitfalls in cryptography," 1998.

- [4] N. K. Ratha and R. Bolle, "IO SMARTCARD BASED AUTHENTICATION," *Biometrics: Personal Identification in Networked Society*, vol. 479, p. 369, 1999.
- [5] K. Simoens, B. Yang, X. Zhou, F. Beato, C. Busch, E. M. Newton, *et al.*, "Criteria towards metrics for benchmarking template protection algorithms," in *Biometrics (ICB), 2012 5th IAPR International Conference on*, 2012, pp. 498-505.
- [6] A. K. Jain, K. Nandakumar, and A. Nagar, "Biometric template security," *EURASIP Journal on Advances in Signal Processing*, vol. 2008, p. 113, 2008.
- [7] H. Al-Assam, H. Sellahewa, and S. Jassim, "A lightweight approach for biometric template protection," in *SPIE Defense, Security, and Sensing*, 2009, pp. 73510P-73510P-12.
- [8] A. Vetro and N. Memon, "Biometric system security," in *Tutorial presented at Second International Conference on Biometrics, Seoul, South Korea*, 2007.
- [9] C. Soutar, D. Roberge, A. Stoianov, R. Gilroy, and B. V. Kumar, "Biometric Encryption: enrollment and verification procedures," in *Aerospace/Defense Sensing and Controls*, 1998, pp. 24-35.
- [10] G. J. Tomko, C. Soutar, and G. J. Schmidt, "Fingerprint controlled public key cryptographic system," ed: Google Patents, 1996.
- [11] E.-C. Chang, R. Shen, and F. W. Teo, "Finding the original point set hidden among chaff," in *Proceedings of the 2006 ACM Symposium on Information, computer and communications security*, 2006, pp. 182-188.
- [12] W. J. Scheirer and T. E. Boulton, "Cracking fuzzy vaults and biometric encryption," in *Biometrics Symposium, 2007*, 2007, pp. 1-6.
- [13] K. Nandakumar, A. Nagar, and A. K. Jain, "Hardening fingerprint fuzzy vault using password," in *International conference on Biometrics*, 2007, pp. 927-937.
- [14] A. Kholmatov and B. Yanikoglu, "Realization of correlation attack against the fuzzy vault scheme," in *Proc. SPIE*, 2008, pp. 1-7.
- [15] D. Maltoni, D. Maio, A. Jain, and S. Prabhakar, *Handbook of fingerprint recognition*: Springer Science & Business Media, 2009.
- [16] T. C. Clancy, N. Kiyavash, and D. J. Lin, "Secure smartcardbased fingerprint authentication," in *Proceedings of the 2003 ACM SIGMM workshop on Biometrics methods and applications*, 2003, pp. 45-52.
- [17] A. Juels and M. Wattenberg, "A Fuzzy Commitment Scheme," 2013.
- [18] R. Ranjan and S. K. Singh, "Improved and innovative key generation algorithms for biometric cryptosystems," in *Advance Computing Conference (IACC), 2013 IEEE 3rd International*, 2013, pp. 943-946.
- [19] W. Yang, J. Hu, S. Wang, and M. Stojmenovic, "An alignment-free fingerprint bio-cryptosystem based on modified Voronoi neighbor

- structures," *Pattern Recognition*, vol. 47, pp. 1309-1320, 2014.
- [20] W. Yang, J. Hu, and S. Wang, "A Delaunay quadrangle-based fingerprint authentication system with template protection using topology code for local registration and security enhancement," *IEEE transactions on Information Forensics and Security*, vol. 9, pp. 1179-1192, 2014.
- [21] M. Kaur, S. Sofat, and D. Saraswat, "Template and database security in Biometrics systems: A challenging task," *International Journal of Computer Applications*, vol. 4, pp. 1-5, 2010.
- [22] L. Nanni and A. Lumini, "Cancellable biometrics: problems and solutions for improving accuracy," *Biometrics: Methods, Applications and Analyses*, 2010.
- [23] A. B. Teoh and D. C. Ngo, "Biophasor: Token supplemented cancellable biometrics," in *Control, Automation, Robotics and Vision, 2006. ICARCV'06. 9th International Conference on*, 2006, pp. 1-5.
- [24] A. T. B. Jin, D. N. C. Ling, and A. Goh, "Biohashing: two factor authentication featuring fingerprint data and tokenised random number," *Pattern recognition*, vol. 37, pp. 2245-2255, 2004.
- [25] A. Lumini and L. Nanni, "An improved biohashing for human authentication," *Pattern recognition*, vol. 40, pp. 1057-1065, 2007.
- [26] H. Al-Assam, H. Sellahewa, and S. Jassim, "Multi-Factor Biometrics for Authentication: A false sense of security," in *Proceedings of the 12th ACM Workshop on Multimedia and Security*, 2010, pp. 81-88.
- [27] D. Maio and L. Nanni, "Multihashing, human authentication featuring biometrics data and tokenized random number: A case study FVC2004," *Neurocomputing*, vol. 69, pp. 242-249, 2005.
- [28] A. B. Teoh, Y. W. Kuan, and S. Lee, "Cancellable biometrics and annotations on biohash," *Pattern recognition*, vol. 41, pp. 2034-2044, 2008.
- [29] A. B. J. Teoh and C. T. Yuang, "Cancelable biometrics realization with multispace random projections," *IEEE Transactions on Systems, Man, and Cybernetics, Part B (Cybernetics)*, vol. 37, pp. 1096-1106, 2007.
- [30] A. Nagar, K. Nandakumar, and A. K. Jain, "A hybrid biometric cryptosystem for securing fingerprint minutiae templates," *Pattern Recognition Letters*, vol. 31, pp. 733-741, 2010.
- [31] Y. Wang and K. Plataniotis, "Face based biometric authentication with changeable and privacy preservable templates," in *Biometrics Symposium, 2007*, 2007, pp. 1-6.
- [32] S. Hirata and K. Takahashi, "Cancelable biometrics with perfect secrecy for correlation-based matching," *Advances in Biometrics*, pp. 868-878, 2009.
- [33] M. Elmezain, A. Al-Hamadi, J. Appenrodt, and B. Michaelis, "A hidden markov model-based continuous gesture recognition system for hand motion trajectory,"

- in *Pattern Recognition, 2008. ICPR 2008. 19th International Conference on*, 2008, pp. 1-4.
- [34] D. Maltoni, D. Maio, A. K. Jain, and S. Prabhakar, "Securing Fingerprint Systems," *Handbook of Fingerprint Recognition*, pp. 371-416, 2009.
- [35] A. Nagar, K. Nandakumar, and A. K. Jain, "Biometric template transformation: a security analysis," in *IS&T/SPIE Electronic Imaging*, 2010, pp. 75410O-75410O-15.
- [36] N. K. Ratha, J. H. Connell, and R. M. Bolle, "Enhancing security and privacy in biometrics-based authentication systems," *IBM systems Journal*, vol. 40, pp. 614-634, 2001.
- [37] N. K. Ratha, S. Chikkerur, J. H. Connell, and R. M. Bolle, "Generating cancelable fingerprint templates," *IEEE Transactions on pattern analysis and machine intelligence*, vol. 29, 2007.
- [38] H. Yang, X. Jiang, and A. C. Kot, "Generating secure cancelable fingerprint templates using local and global features," in *Computer Science and Information Technology, 2009. ICCSIT 2009. 2nd IEEE International Conference on*, 2009, pp. 645-649.
- [39] C. Lee and J. Kim, "Cancelable fingerprint templates using minutiae-based bit-strings," *Journal of Network and Computer Applications*, vol. 33, pp. 236-246, 2010.
- [40] J. Zhe and A. T. B. Jin, "Fingerprint template protection with minutia vicinity decomposition," in *Biometrics (IJCB)*, 2011
- International Joint Conference on*, 2011, pp. 1-7.
- [41] T. Ahmad, J. Hu, and S. Wang, "Pair-polar coordinate-based cancelable fingerprint templates," *Pattern Recognition*, vol. 44, pp. 2555-2564, 2011.
- [42] K. Takahashi and S. Hirata, "Cancelable biometrics with provable security and its application to fingerprint verification," *IEICE transactions on fundamentals of electronics, communications and computer sciences*, vol. 94, pp. 233-244, 2011.
- [43] S. Wang and J. Hu, "Alignment-free cancelable fingerprint template design: A densely infinite-to-one mapping (DITOM) approach," *Pattern Recognition*, vol. 45, pp. 4129-4137, 2012.
- [44] P. Das, K. Karthik, and B. C. Garai, "A robust alignment-free fingerprint hashing algorithm based on minimum distance graphs," *Pattern Recognition*, vol. 45, pp. 3373-3388, 2012.
- [45] M. Ferrara, D. Maltoni, and R. Cappelli, "Noninvertible minutia cylinder-code representation," *IEEE Transactions on Information Forensics and Security*, vol. 7, pp. 1727-1737, 2012.
- [46] T. S. Ong, A. T. B. Jin, and D. C. L. Ngo, "Application-Specific Key Release Scheme from Biometrics," *IJ Network Security*, vol. 6, pp. 127-133, 2008.
- [47] T. E. Boulton, W. J. Scheirer, and R. Woodworth, "Revocable fingerprint biotokens: Accuracy and security analysis," in *Computer Vision and*

- Pattern Recognition*, 2007. CVPR'07. *IEEE Conference on*, 2007, pp. 1-8.
- [48] Y. C. Feng, P. C. Yuen, and A. K. Jain, "A hybrid approach for generating secure and discriminating face template," *IEEE transactions on information forensics and security*, vol. 5, pp. 103-117, 2010.
- [49] Y. J. Chin, T. S. Ong, A. B. J. Teoh, and K. Goh, "Integrated biometrics template protection technique based on fingerprint and palmprint feature-level fusion," *Information Fusion*, vol. 18, pp. 161-174, 2014.
- [50] M. Sandhya and M. V. Prasad, "Cancelable fingerprint cryptosystem based on convolution coding," in *Advances in Signal Processing and Intelligent Recognition Systems*, ed: Springer, 2016, pp. 145-157.
- [51] Z. Jin, A. B. J. Teoh, B.-M. Goi, and Y.-H. Tay, "Biometric cryptosystems: A new biometric key binding and its implementation for fingerprint minutiae-based representation," *Pattern Recognition*, vol. 56, pp. 50-62, 2016.
- [52] S. Ye, Y. Luo, J. Zhao, and S.-C. Cheung, "Anonymous biometric access control," *EURASIP Journal on Information Security*, vol. 2009, p. 865259, 2009.
- [53] S. D. Rane, W. Sun, and A. Vetro, "Secure distortion computation among untrusting parties using homomorphic encryption," in *Image Processing (ICIP), 2009 16th IEEE International Conference on*, 2009, pp. 1485-1488.
- [54] M. Barni, T. Bianchi, D. Catalano, M. Di Raimondo, R. D. Labati, P. Failla, *et al.*, "A privacy-compliant fingerprint recognition system based on homomorphic encryption and fingercode templates," in *Biometrics: theory applications and systems (BTAS), 2010 Fourth IEEE International Conference on*, 2010, pp. 1-7.

PRODUCTION OPTIMIZATION ESP-TO-GAS LIFT IN HIGH GOR CASE USING WELL SIMULATOR

Ariyon, M, Nugroho, R. S
Universitas Islam Riau

Abstract

Pressure depletion happens when the well is produced after a long time. This depletion will caused the increase of associated gas production. RSN field is well known field with high GOR. Electric Submersible Pump (ESP) is a kind of artificial lift which used in RSN field. Well performance in RSN field is decreased time to time because of increase of gas production. Gas production caused zero maag which disrupting performance of ESP. This gassy problem in RSN field can be solved by converting ESP to gas lift. Gas lift is an artificial lift which is suitable for high GOR field. Before converting to gas lift, field performance evaluation needs to be done for each wells (GOR, casing pressure, productivity index). After evaluation, optimization will be done by converting to gas lift. Gas lift design is generated by making sensitivity analysis with injection gas rate and well head pressure as variable. The last is economic analysis from the gas lift conversion. Based on the gas lift optimization in RSN#36, the previous oil rate is 4 bpd using ESP which is below the economic limit. The optimized oil rate is 13.1 bpd with 0.2 mmscf/d gas injection rate and 100 psi of well head pressure with the gas injection cost is 200\$/d. Pressure compression to reach 100 psi is 100\$/d. The result is cumulative oil production for 4 years is 17.27 mstb and net revenue is 125.84\$M.

Keywords : *Zero Maag, Injection Gas Rate , Gas Oil Ratio, Casing Pressure, Net Revenue*

1. INTRODUCTION

Rate which based on reservoir pressure is the first thing need to be concerned in oil production. Deliverability of productive formation is described from production rate. Reservoir fluid in pore mediums will flow if there is a pressure difference from side to

side. Reservoir deliverability also affect the completion design and artificial lift which is used (Guo, Boyun; Lyons, William; Ghalambor, 2007).

The increase of age of the field, there will be more pressure depletion at the field. This

depletion will cause associated gas produced to the surface. The selection of artificial lift is needed to solve this gassy case.

RSN field is well known high GOR field, but there's some field which still produce oil. Most of the wells in RSN field uses Electric Submersible Pump (ESP). RSN field average performance, which used ESP pump is decline time to time. This case also followed by the increase of associated gas production, which caused gas lock in ESP. This gas also cause zero maag which disrupting the performance of ESP.

ESP is sentrifuge pump, which run by electric motor. This motor designed to be submerged to the working fluid. The purpose is to avoid cavitation to the pump. This special designed pump used to several special cases, like to produce sludge and also to produce oil while drilling.

The gassy problem in RSN field need to be solved, the way is converting ESP to gas lift. Gas lift is the method used in high GOR

reservoir by injecting gas through wellbore to lift fluid to the surface, in this case also used to fix well performance, which has high Productivity Index (PI) by considering the ESP performance to be converted to gas lift. Gas lift design is needed to optimize RSN field.

Gas lift is the method to produce fluid to the surface by injecting gas through tubing-casing annulus in several pressure and temperature (Ebrahimi, 2010). The main purpose is to produce expected oil rate through the decrease of well flow pressure gradient in the tubing.

The purpose of this research is to analyze the performance of RSN field, which used ESP to be converted to gas lift and optimize the well. Economic analysis is needed to make sure the job is feasible to be run.

2. METHODOLOGY

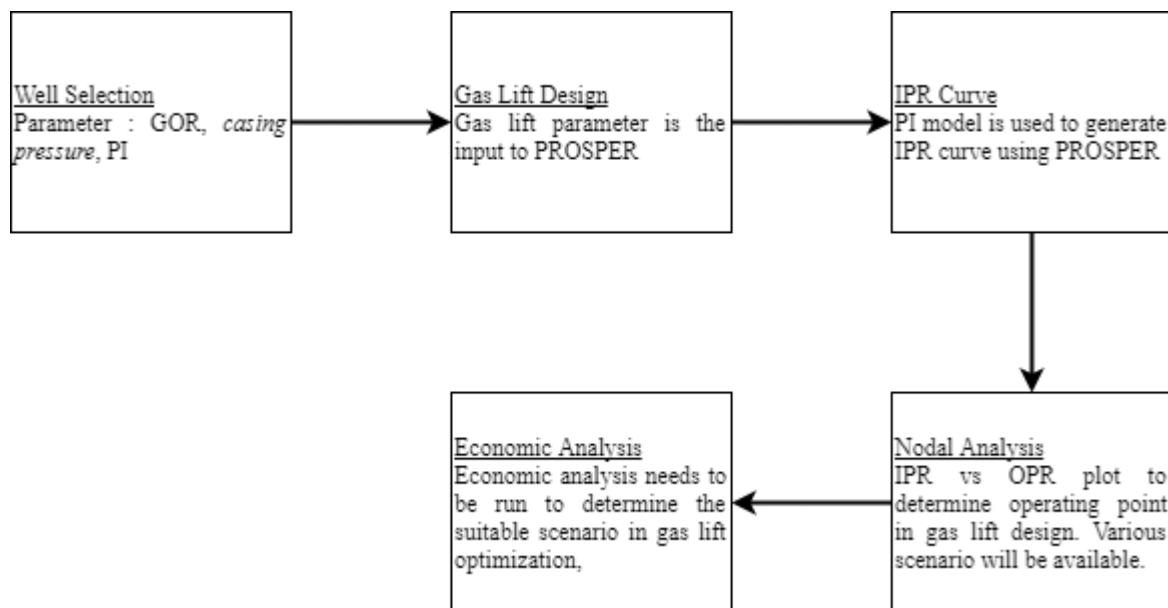

Figure 1 Research Methodology

3. RESULT AND DISCUSSION

RSN Field Performance Evaluation and Well Selection

GOR is the main parameter in evaluating each well in RSN field. This is caused by

RSN field has high average GOR which well known as high GOR field. One of well has 1190.3 scf/stb GOR. Figure 2 shown each GOR in several wells in RSN field

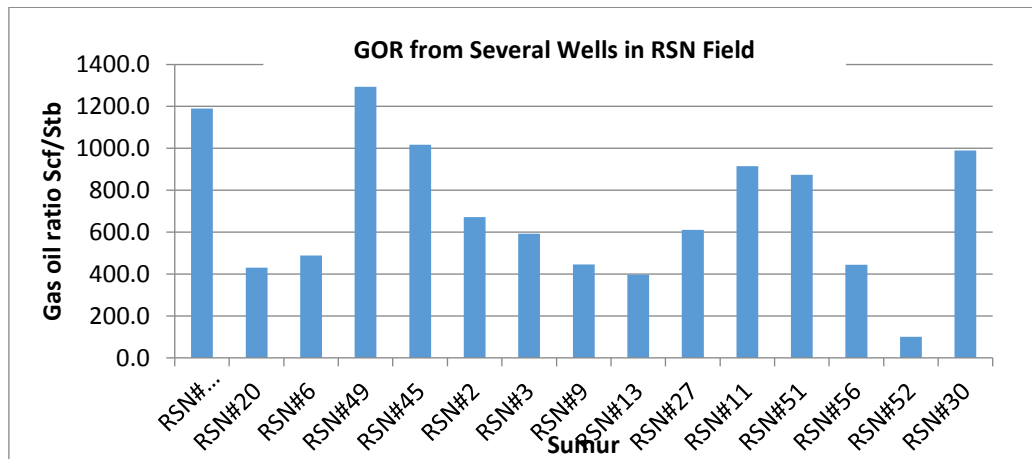

Figure 2 GOR in RSN Field

Can be seen that RSN#36 and RSN#49 has the highest GOR which is 1190.3 scf/stb and 1293.7 scf/stb. These wells can be made as candidate in ESP to gas lift conversion,

besides GOR, Productivity Index (PI) and casing pressure is needed as parameter to select the suitable well candidate in oil rate optimization using ESP to gas lift conversion

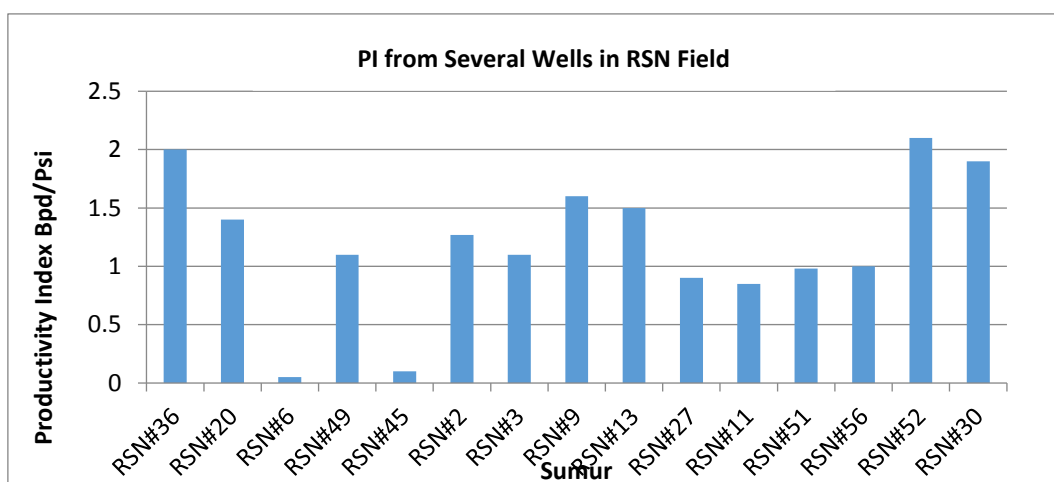

Figure 3 PI in RSN Field

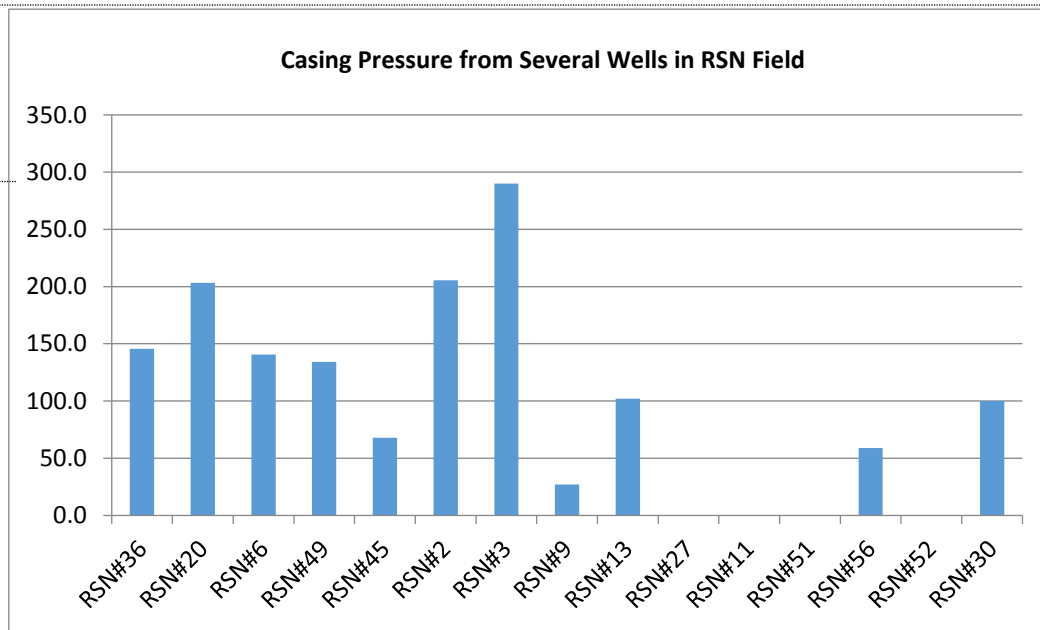

Figure 4 Casing Pressure in RSN Field

From these parameters (fig 2, 3, 4) RSN#36 is the suitable candidate to be converted from ESP to gas lift. This can be seen that RSN#36 has high GOR (1190.3 scf/stb), 2 bpd/psi of PI, and casing pressure is 145.6 psi. The high GOR and casing pressure will indicate associated gas when produced through ESP.

When there's many associated gas produced in ESP, it will disturb the performance of ESP. High PI will show there is a big potential in reservoir deliverability to produce high oil rate to the surface. Conversion ESP to gas lift will be effective because of the high existence of associated gas.

Production Analysis RSN#36

Table 1 Last Production Data RSN#36

Well	GOR (scf/stb)	Casing Pressure (psi)	Oil Rate (Bopd)	Gas Rate (Mcf/d)	PI (STB/Day)
RSN#36	1190.3	145.6	4	73.09	2.0

Before optimization, need to be known that RSN#36 has low oil rate, 4 bpd of oil rate is below average economic limit (5 bpd) but 73.93 mcf/d gas production which is high. This data can be seen in table 1. Comparing to economic limit 5 bpd, this well is not profit enough to be produced. From GOR, PI, and

casing pressure, this well has big potential to be optimized by converting from ESP to gas lift.

From amp chart, RSN#36 has high gas production so, when this well is still produced using ESP it will be disturbed by

associated gas and the oil rate will be depleted.

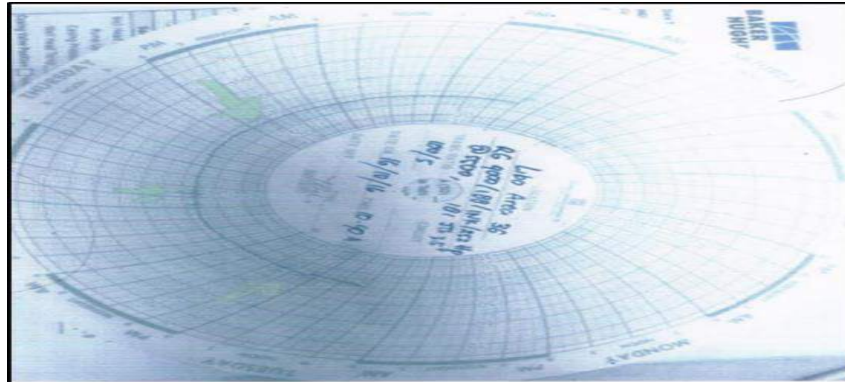

Figure 5 Amp Chart Result in RSN#36

Based on figure 5, the ampere which is obtained from troubleshooting. This figure shown there's a current regular current which

shown by arrow mark, this current formed circle which indicates gas production or gassy well (Roosa, S, 2011).

Gas Lift Design in RSN#36

Table 2 Gas Lift Input

Depth	5778	ft
QL	1500	Stb/h
Tubing Size	2.5"	Inch
Reservoir Pressure	2309	Psi
Well Head Pressure	246	Psi
Gas Liquid Ratio	800	Scf/Stb
Specific Gas Gravity	0.6	Sp Gravity
PKO	1000	Psi
PSO	900	Psi
Well Flow Pressure	2034	Psi
Well Flow Temperature	301.79	F
Surface Temperature	288	F

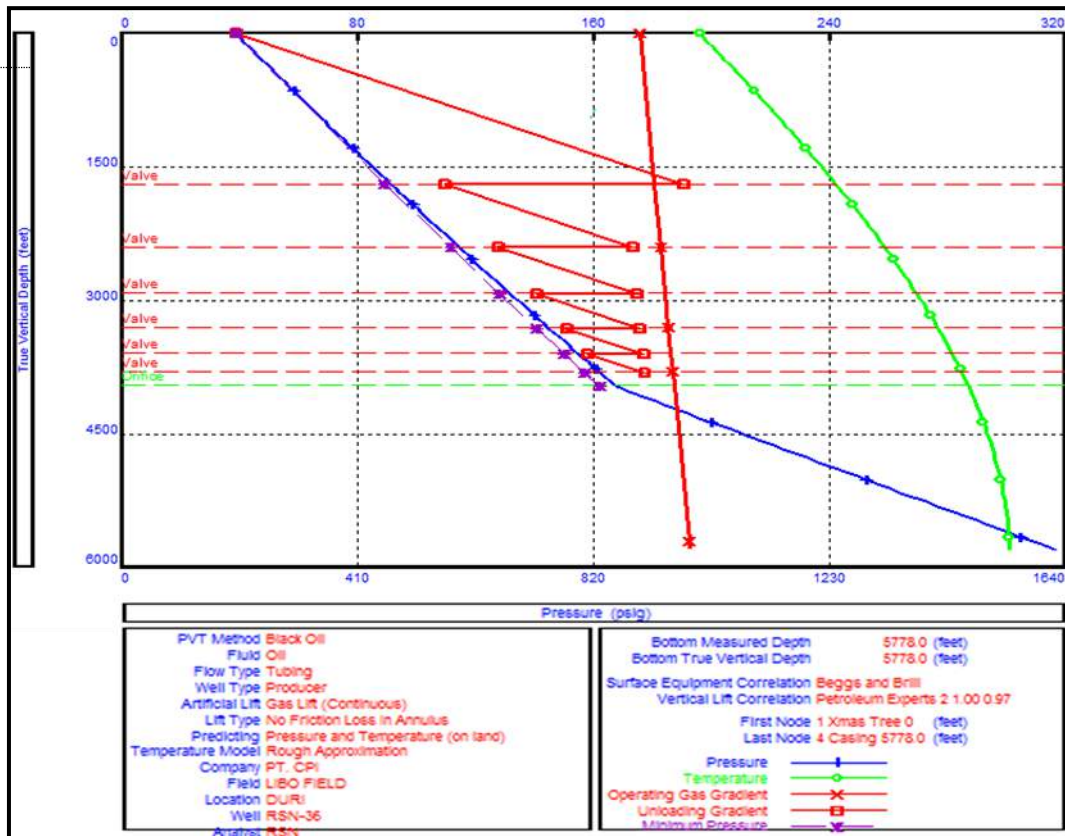

Table 2 is parameters in gas lift design. To convert ESP to gas lift, gas lift design needs to be done in RSN#36 using PROSPER

software. These parameters is the input to the software. This can be done when the PVT input already matched.

Figure 6 Gas Lift Design using Prosper in RSN#36

From figure 6 can be concluded that the depth of RSN#36 is 5778 ft. Using gas lift completion design, there are 7 injection valve

which can be seen in table 3. From the figure, the Point of Injection is 3947.61 ft.

Table 3 Injection Valve

Valve Type	Measured Depth (Ft)
Valve 1	1687,94
Valve 2	2394,06
Valve 3	2915,4
Valve 4	3300,33

Valve 5	3584,53
Valve 6	3794,36

After the completion design is done, IPR curve will be made to determine the operating point using nodal analysis. Nodal analysis is generated using IPR vs Outflow Performance Relationship (OPR) plot so, the sensitivity can be run with injection gas rate

and well head pressure as the variable. Various Scenario will be made based on these variables so, the optimum injection gas rate and well head pressure can be determined to produce optimum oil rate in gas lift.

Table 4 IPR Curve Input Data

Parameter	Value	Unit
Depth	5778	Ft
PI	2.0	STB/Psi
Static Pressure	2309.189	Psi
Well Flow Pressure	2034.667	Psi
Bubble Point Pressure	2176	Psi
Well Flow Temperature	301.7996	F
Separator Pressure	100	Psi

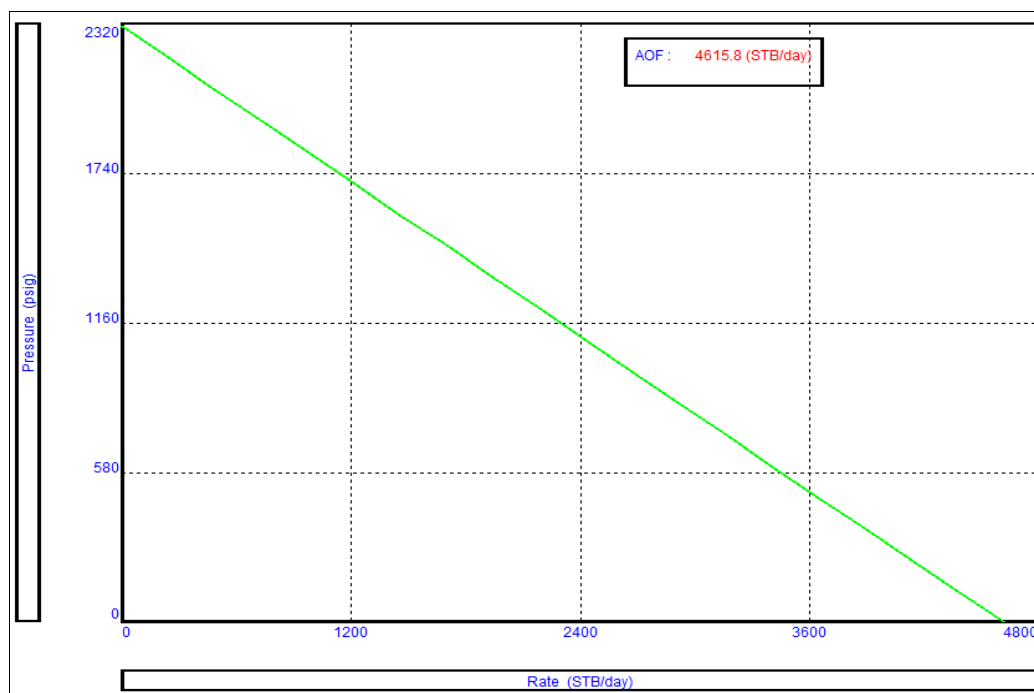

Figure 7 IPR Curve from RSN#36

IPR curve generated and simulated from table 4 data. After running, can be seen in figure 7 that Absolute Open Flow (AOF) is 4615.8 STB/day which shown the maximum fluid rate can be produced from RSN#36 is 4615.8 STB/day. To determine

optimum rate from RSN#36, nodal analysis needs to be done by seeing the intersection from IPR vs OPR curves with gas rate interval from 0 to 1 mmcf/d and well head pressures are 100 psi, 246 psi and 300 psi so, the sensitivity can be seen to the oil rate.

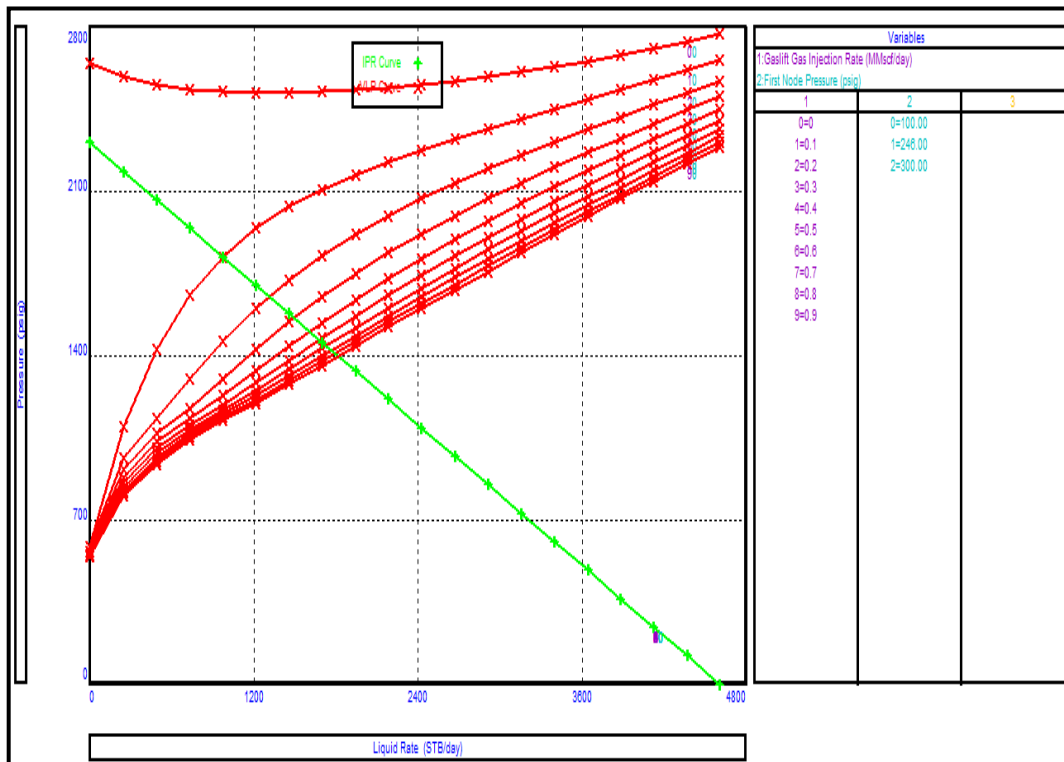

Figure 8 IPR vs OPR Curve in RSN#36

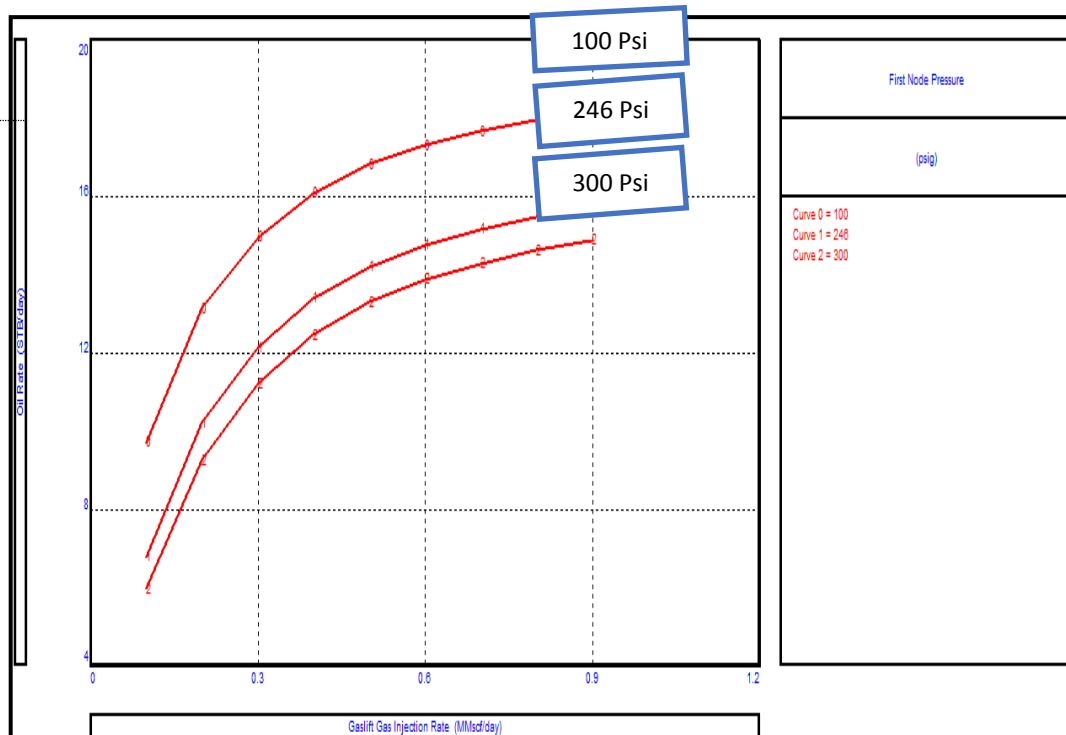

Figure 9 Well Head Sensitivity in RSN#36

Figure 8 and 9 shown nodal analysis from inflow and outflow from RSN#36 using gas lift. When the gas incetion rate is 0, there is no intersection with IPR curve (figure 8), so it cleared that RSN#36 need gas injection to optimize oil production. From sensitivity

whcich simulated in figure 9 can be concluded in table 5 for each well head pressure and gas injection rate will produce various oil rate for each scenario

Table 5 Oil Rate Based on Injected Gas and Well Head Pressure

Injection Gas (MMSCF/D)	Oil Rate (STB/D)		
	Pwh 100 (psi)	Pwh 246 (psi)	Pwh 300 (psi)
0	0	0	0
0.1	9.7	6.8	6
0.2	13.1	10.2	9.3
0.3	15	12.2	11.2
0.4	16.1	13.4	12.5
0.5	16.8	14.2	13.3
0.6	17.3	14.8	13.9
0.7	17.7	15.2	14.3
0.8	18	15.5	14.6
0.9	18.2	15.8	14.9

1	18.4	16	15.1
---	------	----	------

From table above can be seen that using 1 mmcfd gas and 100 psi of well head pressure will produce 18.4 STB/day of oil. This is the highest value from each scenario from sensitivity which is made. This opinion need to be strengthened using economic analysis if using 1 mmchd gas which produce 18.4 STB/day of oil is the most economical scenario

Economic Analysis from Gas Lift Scenarios in RSN#36

Using economic parameters, gas injection cost is 100\$/day and oil price is 50\$/bbl can be calculated net revenue and gross revenue for each scenario

Table 6 Economic Analysis from 100 Psi Scenario

Gas Injection (MMSCF)	Prod oil (STB/D)	Oil Sale Revenue (\$/d)	4 Years NP	Gross Revenue	Net Revenue (\$)
0.1	9.7	485	12.79	639.64	347.64
0.2	13.1	655	17.27	863.85	425.84
0.3	15	750	19.78	989.14	405.14
0.4	16.1	805	21.23	1061.67	331.67
0.5	16.8	840	22.15	1107.83	231.83
0.6	17.3	865	22.81	1140.80	118.80
0.7	17.7	885	23.34	1167.18	-0.814
0.8	18	900	23.73	1186.96	-127.03
0.9	18.2	910	24.00	1200.15	-259.84
1	18.4	920	24.26	1213.34	-392.65

Table 7 Economic Analysis from 246 Psi Scenario

Gas Injection (MMSCF)	Prod oil (STB/D)	Oil Sale Revenue (\$/d)	4 Years NP	Gross Revenue	Net Revenue (\$)
0.1	6.8	340	8.96	448.41	192.91
0.2	10.2	510	13.45	672.61	271.11
0.3	12.2	610	16.09	804.50	257.00
0.4	13.4	670	17.67	883.63	190.13
0.5	14.2	710	18.72	936.38	96.88
0.6	14.8	740	19.51	975.95	-9.54
0.7	15.2	760	20.04	1002.32	-129.17
0.8	15.5	775	20.44	1022.11	-255.38

Gas Injection (MMSCF)	Prod oil (STB/D)	Oil Sale Revenue (\$/d)	4 Years NP	Gross Revenue	Net Revenue (\$)
0.9	15.8	790	20.83	1041.89	-381.60
1	16	800	21.10	1055.08	-514.41

Table 8 Economic Analysis from 300 Psi Scenario

Gas Injection (MMSCF)	Prod oil (STB/D)	Oil Sale Revenue (\$/d)	4 Years NP	Gross Revenue	Net Revenue (\$)
0.1	6	300	7.91	395.65	176.65
0.2	9.3	465	12.26	613.26	248.26
0.3	11.2	560	14.77	738.55	227.55
0.4	12.5	625	16.48	824.28	167.28
0.5	13.3	665	17.54	877.03	74.03
0.6	13.9	695	18.33	916.60	-32.39
0.7	14.3	715	18.85	942.98	-152.01
0.8	14.6	730	19.25	962.76	-278.23
0.9	14.9	745	19.65	982.54	-404.45
1	15.1	755	19.91	995.73	-537.26

From 3 tables above can be seen that using 0.2 mmscfd gas injection rate will give the highest revenue, even 1 mmscfd of gas injection rate will give negative revenue.

From each scenario can be concluded in table 9 that using 0.2 mmscfd injection rate is the optimum gas injection rate with 100 psi well head pressure.

Table 9 Economic Analysis 0.2 mmscfd Scenario

Gas Injection(MMSCF/D)	Injeksi Gas 0.2 MMscf/D		
	Pwh 100 (psi)	Pwh 246 (psi)	Pwh 300 (psi)
Oil Sale Revenue (\$)	655	510	465
4 Years NP	17.27	13.45	12.26
Gross Revenue (M\$)	863.85	672.62	613.26
Net Revenue (M\$)	425.85	271.12	248.26

From table above, using 0.2 mmscfd gas injection rate and 100 psi well head pressure will give high oil sale revenue which is

655M\$ with net revenue is 425.85M\$ for 4 years.

ACKNOWLEDGEMENT

Authors want to thank Chevron Pacific Indonesia to the support in permitting authors to do this research. Authors also want to thank Petroleum Engineering Department in UIR for the full support of this research.

4. CONCLUSION

Based on the oil rate and ESP to gas lift conversion can be concluded:

1. RSN#36 has high GOR, 1190 scf/stb, 2 STB/d PI and 145.6 psi casing pressure. These parameters are important to prove this well is suitable for ESP to gas lift conversion with good PI.
2. From optimization ESP to gas lift conversion in RSN#36, the optimum operating point is 0.2 mmscfd gas injection rate and 100 psi well head will give 1314.4 STB/d liquid rate and 13.1 STB/d oil rate with the valve will be pointed at 1687.94 ft, 2394.06 ft, 2915.4 ft, 3300.33 ft, 3584.53 ft, 3794.36 ft, and the Point of Injection located at 3947.61 ft.
3. From economic analysis with oil price is 50\$/bbl, net revenue is 425.84M\$ from 0.2 mmscfd and 100 psi scenario.

REFERENCES

- Petroleum Experts Limited. *IPM PROSPER guide versi 7.0*. Petex House. Edinburgh, Skotlandia.
- Guo, Buyon; Lyons, William; Ghalambor, A. (2007). *Petroleum Production Engineer – A Computer Assisted Approach*. Louisiana: Elsevier Science & Technology Books.
- Ebrahimi.(2010). *Gas Lift Optimization in One of Iranian South Western Oil Fields presented SPE 133435 at Trinidad and Tobago Energy Resources Conference*
- Stuart, Roosa. (2011). *Submersible Pump Handbook Tenth Edition*. Oklahoma: Baker Hughes

ROCK MASS CLASSIFICATION SYSTEM USING ROCK MASS RATING (RMR) OF A CUT SLOPE IN RIAU – WEST SUMATRA ROAD

Dewandra Bagus Eka Putra¹, Yuniarti Yuskar¹, Catur Cahyaningsih¹, Seppia Khairani¹

¹ Department of Geological Engineering, Universitas Islam Riau, Pekanbaru, Riau, Indonesia

Email : dewandra.bagus@eng.uir.ac.id

Abstract

Slope failure periodically occurred in Riau-West Sumatra road that could disconnect and affecting the activities in this two important provinces. The study of rock mass classification system using rock mass rating (RMR) had been done to obtain the information about rock strength of a cut slope along the road particularly in Desa Tanjung Alai (KM 78-99). Six scanline with 10m each had been established to determine the RMR value of cut slope by observed some parameters. UCS value of the cut slope grouped into medium strong rock (20-50 MPa). RQD variation ranged from 9.4% to 78.7% caused by the difference of weathering grade. Similar discontinuity spacing and condition had been found in the cut slope with 200-600mm space, slightly rough surface, separation less than 1mm and slightly weathered wall. Absence of groundwater means the cut slope is in dry condition. Average RMR value is 58.5 therefore the cut slope classified as Class III (Fair Rock), which means the slope need some supporting method for potential failure prevention. Rock bolt and shotcrete were among the methods that had been recommended based on the rock mass analysis.

Keywords: *slope failure, Desa Tanjung Alai, rock mass classification system, rock mass rating*

1. INTRODUCTION

Slope failure is a geological disaster that often happened in Riau – West Sumatra road. As the main access that connected these two provinces, this event became a major problem and endangered not only the road users but also the resident around the area, especially when the rainy season has occurred. The purposed of this research is to determine the strength of cut slopes along the road in particular KM 78-99 (**Figure 1**) which is a part of Desa Tanjung Alai, Kampar Regency, Riau Province.

The research area was surrounded by several types of slope such as nearly level slope, moderately sloping, steep and very steep slope (Putra and Choanji, 2016). Slope instability induced by several factors that could be broadly categorize into preparatory factors, triggering factors and controlling factors (Saskar and Kanungo, 2008), these factors had been used to choosing the landslide stability analysis. Different rock mass classification systems for rock cuttings have been proposed with high risk to identify the potential failure so that the present preventive and

improvement methods could be defined (e.g. Bieniawski 1973; Barton 1974; Selby 1980; Haines and Terbrugge 1991; Hack et al. 2003; Liu and Chen 2007; Pantelidis 2010; Hajiazizi and Khatami 2013). Providing quantitative data and guidelines for engineering purposes that can improve the

geological formation is the primary objective of rock mass classification (Liu and Chen, 2007). Rock mass classification systems try to rate its quality by considering the most important aspects that affecting the rock mass (Tzamos and Sofianos, 2007).



Figure 1 Map of study area

2. METHODOLOGY

Rock Mass Rating (RMR) after Bieniawski (1989), had been used to determine the slope stability. This classification system concerning in rock structure and joint condition of the slope. Six scanlines, 10m each (Figure 2), had established to deciding the RMR value by calculating six parameters using the following equation:

$$RMR = R_1 + R_2 + R_3 + R_4 + R_5 + R_6 \dots (1)$$

where, R_1 is uniaxial compressive strength (UCS), R_2 is rock quality designation (RQD), R_3 is spacing of discontinuity, R_4 is condition of discontinuity, R_5 is condition of

groundwater and R_6 is orientation of discontinuities relative to the slope.

Uniaxial Compressive Strength value estimated in the field using geological hammer and being converted into UCS value using Index Classification of Rock Material by Hoek and Brown (1980).

RQD value can be calculated by field survey as core sample were not available (Bell, 2007). RQD value calculated using Palmstrom (1982) formula:

$$RQD = 115 - 3,3 J_v \dots (2)$$

where, J_v = joint per unit volume



Figure 1: General condition of scanline cut slope

3

• RESULT AND DISCUSSION

Similar UCS value had been estimated from the six scanline in range between 25-50MPa. Based on its value, the cut slope belonging to medium strong rock group and given the rating 4. RQD value of cut slope in the study area is in between 9.4 & to 78.7%. Scanline 6 has the smaller RQD value and rating because of the higher weathering grad that can be shown by the presence of soil. Each scanline has similar average spacing of discontinuity, 0.04-0.2m which given the rating 10. Some parameters of discontinuity condition had been measured:

- a. Persistence or discontinuity length ranged from 0.06-0.12m and given the rating 6.

- b. Scanline 1-4 has $< 0.1\text{mm}$ of aperture while scanline 5- 6 has none therefore rating 5 have been given to scanline 1-4 and rating 6 for scanline 5-6.
- c. Rough discontinuity surface had been found along the cut slope which given the rating 5.
- d. The absence of infilling material in discontinuity, gives the rating 6
- e. Weathering grade of scanline 1-5 is moderate (rating 3) meanwhile scanline 6 has higher weathering grade and lower rating.

There is no water that flowed out from the cut slope which mean it has dry condition and given the rating 15. Favourable condition of cut slope gives -5 rating adjustment to the RMR value.

Summary of RMR parameters shows in **Table 1**.

Table 1: Summary of RMR parameters

Scanline Number	Sc 1	Sc 2	Sc 3	Sc 4	Sc 5	Sc 6	
RQD (%)	78.7	29.2	68.8	39.1	49	9.4	
Spacing of discontinuity (m)	0.2	0.1	0.12	0.2	0.11	0.04	
Condition of discontinuity	Persistence (m)	0.12	0.1	0.12	0.07	0.07	0.06
	Separation (mm)	< 0.1	< 0.1	< 0.1	< 0.1	None	None
	Roughness	Rough	Rough	Rough	Rough	Rough	Rough
	Weathering	Moderate	Moderate	Moderate	Moderate	Moderate	High
Groudwater condition	Dry	Dry	Dry	Dry	Dry	Dry	

From the result of field survey, the RMR value can be calculated as shown in **Table 2**

Table 2: RMR value of cut slope

Scanline Number	Sc 1	Sc 2	Sc 3	Sc 4	Sc 5	Sc 6
UCS (MPa)	4	4	4	4	4	4
RQD (%)	17	8	13	8	8	3
Spacing of discontinuity (m)	10	10	10	10	10	10
Condition of discontinuity	25	25	25	25	26	24
Condition of groundwater	15	15	15	15	15	15
Orientation of discontinuity	-5	-5	-5	-5	-5	-5
Total RMR	66	57	62	57	58	51
RMR class	II	III	II	III	III	III
RMR description	Good	Fair	Good	Fair	Fair	Fair

Majority of the scanline grouped into Class III RMR (Fair Rock), only scanline 1 and 3 that classified as Class II (Good Rock). The average RMR value of cut slope in the study area is 58.5 therefore the cut slope categorized into Class III (Fair Rock), it

means the slope need some supporting methods in order to be stable and not endangering the surrounding area. According to Bieniawski (1989) rock bolt method with systematic bolts 4 m long, spaced 1.5-2 m in crown and walls with

wire mesh in crown and 50-10mm shotcrete in crown and 30mm in sides could be the solution.

4. CONCLUSION

UCS of rock slope in the study area has value in between 25-50MPa that classified as medium strong rock. Variation of RQD values in the study area resulting from the different weathering grade which in range from 9.4% to 78.7%. Discontinuity spacing and condition of each scanline has similar characterisation, 200-600mm space, slightly rough surface, separation less than 1mm and slightly weathered wall. According to the absent of water seepage from the cut slope, the groundwater condition categorize as dry condition. Average RMR value in the study area is 58.5 therefore the cut slope is classify as Class III (Fair Rock). This RMR class means the slope need some supporting methods as proposed by Bieniawski (1989), i.e., rock bolt (systematic bolts 4 m long, spaced 1.5-2 m in crown and walls with wire mesh in crown) and shotcrete (50-100 mm in crown, and 30 mm in sides).

ACKNOWLEDGEMENT

Author would say thanks to Kemenristek DIKTI and Lembaga Penelitian Universitas Islam Riau for giving grant to support this study.

REFERENCES

- Barton N. R., Lien, R. and Lunde J. (1974). Engineering classification of rock masses for the design of tunnel support, *Rock Mechanics and Rock Engineering*. 6, no. 4, 189–239.
- Bell, F.G. (2007) *Engineering Geology*. Second Edition, Elsevier, pp.61-68.
- Bieniawski, Z. T. (1973). Engineering classification of rock masses, *Transactions of the American Society of Civil Engineers*. 35, 311–324.
- Bieniawski, Z. T. (1989). Engineering rock mass classifications, New York: Wiley
- Hack, R., Price, D. and Rengers N. (2003). A new approach to rock slope stability—a probability classification (SSPC), *Bulletin of Engineering Geology and the Environment*. 62(2), 167–184.
- Haines, A. and Terbrugge, P. J. (1991). Preliminary estimation of rock slope stability using rock mass classification systems, In: Wittke, W. (Ed.), *Proc 7th Congr on Rock Mechanics 2, ISRM, Aachen, Germany*. Balkema, Rotterdam, 887–892.
- Hajiazizi, M. and Khatami R. S. (2013). Seismic analysis of the rock mass classification in the Q-system, *International Journal of Rock Mechanics and Mining Sciences*. 62, 123–130.
- Hoek, E. and Brown, E.T. 1980. Empirical strength criterion for rock masses. *J. Geotech. Engng Div., ASCE* 106(GT9), 1013-1035.
- Liu, Y. C., and Chen, C. S. (2007). A new approach for application of rock mass classification on rock slope stability assessment, *Engineering Geology*. 89, 129–143.
- Palmström, A. (1982) The volumetric joint count - a useful and simple measure of the degree of jointing; *Proc. IV Int. Congr. IAEG*, New Delhi, pp V.221-V.228.
- Pantelidis, L. (2010). An alternative rock mass classification system for rock slopes, *Bulletin of Engineering Geology and the Environment*. 69, 29–39.
- Putra, D., & Choanji, T. (2016). Preliminary Analysis of Slope Stability in Kuok and Surrounding Areas. *Journal Of Geoscience, Engineering,*

-
- Environment, And Technology*, 1(1), 41-44. doi:10.24273/jgeet.2016.11.5
- Sarkar, S and Kanungo, D.P., 2008. Landslide hazard mapping – A few techniques. *CBRI Diamond Jubilee Conf. on Landslide Management – Present Scenario and Future Directions*, 10-12 Feb. 2008, Roorkee, India.
- Selby, M. J. (1980). A rock mass strength classification for geomorphic purposes: with tests from Antarctica and New Zealand, *Zeitschrift fur Geomorphologie*, 23, 31–51.
- Tzamos, S. and Sofianos, A. I. (2007). A correlation of four rock mass classification systems through their fabric indices, *International Journal of Rock Mechanics & Mining Sciences*. 44, 477–495

SANDSTONE RESERVOIR CHARACTERISTIC BASED ON SURFICIAL GEOLOGICAL DATA OF SIHAPAS FORMATION IN BUKIT SULIGI AREA, SOUTHWEST CENTRAL SUMATRA BASIN

Yuniarti Yuskar¹, Dewandra Bagus Eka Putra¹, Tiggi Choanji¹, Ziadul Faiez¹, Muhammad Habibi²

¹ Department of Geological Engineering, Universitas Islam Riau, Pekanbaru, Riau, Indonesia

²PT. SPR Langgak, Riau, Indonesia

Email : dewandra.bagus@eng.uir.ac.id

Abstract

Sungai Kuning Village and surrounding area located in the eastern region of Bukit Suligi. Bukit Suligi and its surroundings are the exposed terrain of sandstone from the Sihapas Formation, which is the main reservoir in the Central Sumatra Basin. This study aims to get the sandstone analogy of surface geological data to be able to get better understanding of sand reservoir in the Central Sumatra Basin. Correlation of surface and subsurface geological data is done by identifying the characteristics of the lithology. The method used is field geological survey, laboratory analysis of petrography, micropaleontology, depositional environment and geological structure. Based on the characteristics of lithology, age, deposition environment, and geological cross sectional reconstruction, the Sihapas Formation has correlation with reservoir rock in oil and gas field in eastern of Bukit Suligi. Sihapas Formation consist of conglomerate, sandstone and shale.

Keywords: *sungai kuning, central sumatra basin, reservoir rock, oil and gas*

1. INTRODUCTION

Bukit Suligi is located in southwestern part of Riau province, trending from southeast - northwest. This hill extent in two districts of Rokan Hulu and Kampar Regency which include in Sumatra Fault System and Barisan Mountains. Research is focusing in some parts of Bukit Suligi area, especially at Sungai Kuning Village that exposing reservoir rock in the southwestern part of Central Sumatra Basin. The Central Sumatra Basin (CSB) that was formed during the Late Eocene (?) to Early Oligocene is the most prolific hydrocarbon basin in Indonesia. Sedimentation was controlled by the configuration of a

regionally southwestern ward gently sloping deposition surface (Cameron, 1983). The present day distribution of sedimentary and basement rocks can be related to the regional structure of Sumatra. The Barisan uplift and Sumatra Fault System (SFS) controlling the distribution of rock on the mountain front (Clarke, 1982). This paper describes the results of the fieldwork as they relate to the Sihapas Formation, the principal reservoir horizon of the Basin.

The objective of this study is to get analogies and provide a better understanding of reservoir from surficial geological data that can be correlated with subsurface reservoir. Petroleum geology studies of the Bukit Suligi area are mostly

based upon outcrop data (Fig. 1). Laboratory analyses and both surface and subsurface geological reconstruction giving

contribution to achieve the objective of this study (De Coster, 1974)

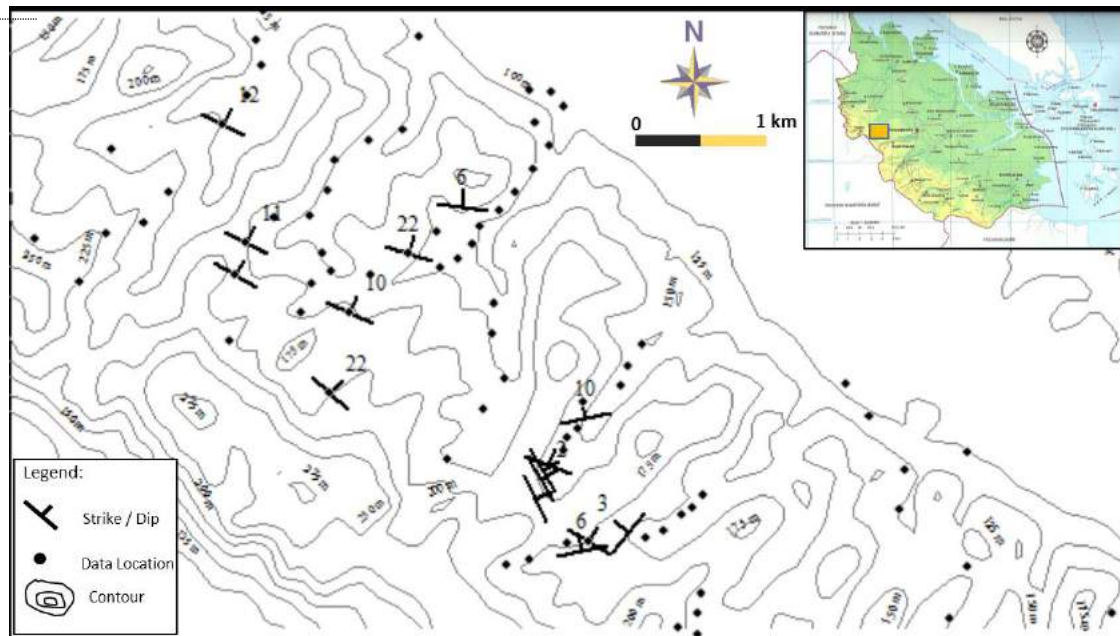

Fig. 1. Detail location samples and measurement of geological data.

1.1 Regional Geology

The Central Sumatra Basin consists of a succession of Tertiary sediments overlying a complex pre-Tertiary lithology, it is bounded on the west and southwest by the Barisan Mountains, on the east by the Malaysian Shield and on the north by the Asahan Arch. The Southern boundary of the Central Sumatra Basin is not well defined (Eubank and Makki, 1981). The traditionally accepted boundary is a geographic one drawn as a north-southwest line through the Kampar High and Tiga Puluh Mountains (Heidrick and Aulia, 1993).

A gradual southward thinning of Tertiary sediments, however, suggests the possible existence of a pre-Tertiary Basement high south of Pekanbaru (Kampar High). To the west lies the Barisan Mountains, where pre-Tertiary rocks and overlying Tertiary sediments outcrop along faults and uplifts.

The Sihapas Formation is early Miocene in age and represents the basal, clastic succession laid down in the CSB at the onset of the transgressive, Tertiary 2b Supergroup (Mertosono and Nayoan, 1974). This transgression culminated in the early middle Miocene with the regional deposition of the outer shelf to upper bathyal mudstones of the Telisa Formation (Mertosono and Nayoan, 1974).

During a period of emergence in pre-Miocene time, the general area was eroded to a nearly flat surface. All pre-Sihapas sediments were stripped off except in a local low in the middle of the present day structure (P., S.A, et al, 2013). These sediments are now preserved on the downthrown side of the east to the southeast part of the Bukit Suligi Area.

2.1 Stratigraphy

There is ambiguous stratigraphic terminology in the study area. The

Cenozoic rock-stratigraphic units in the Central Sumatra Basin include (oldest to youngest), the Pematang formation, Sihapas group, Telisa, Petani, and Minas formations (Eubank and Makki, 1981; Lee, 1982; Roezin, 1974). Sihapas Group consists of four formations. The formations are Menggala, Bangko, Bekasap and Duri formation. It is mainly reservoir in the Central Sumatra Basin.

The transgressive phase of the Neogene is represented by the Sihapas group and overlying partially diachronous Telisa formation. The lower portion of the Miocene Sihapas is represented by an upward fining conglomeratic, coarse to fine grained sandstone succession (Menggala Formation) that is capped by calcareous shale of the Bangko formation. A fluvio-deltaic depositional environment is suggested for the Menggala whereas the Bangko has a more intertidal to marine influence. The Upper Sihapas records a continuation of the early Miocene transgression with medium to coarse grained micaceous sandstone of the Bekasap representing marginal facies of the more basinal shales of the Telisa formation (Rozalli, et al, 2012). The lower to middle Miocene Telisa formation consists of a shale-dominated succession with interbeds of limestone and fine grained glauconitic sandstone. Depositional environments range from inner to outer littoral conditions with a more marine influence towards the top. The upper contact of the Telisa formation is marked by a distinct lithologic and faunal break corresponding to the middle Miocene regressive phase of the Neogene cycle (Duri event). The overlying sediments of the Petani formation constitute a monotonous sequence of shalemudstone containing minor sandstone and siltstone intercalations that show a progressive upwards shallowing and general waning of marine conditions (Lee, 1982).

Different nomenclature on Geological Map of The Pakanbaru Quadrangle, Sumatra (Wongsosantiko, 1976) used Sihapas formation not Sihapas Group. The simple stratigraphy of the study area into time based sedimentary rock units (Table 1) are Sihapas, Telisa and Petani Formation. This study is focused in Sihapas formation that exposed in Sungai Kuning Village and surrounding, Bukit Suligi area.

2. RESULT AND DISCUSSION

Based on geological field data, lithology at Sihapas Formation consist of sandstone, conglomerate and shalestone. It is dominated by sandstone with reddish yellow (weathered) and greyish yellow (fresh) color, fine - coarse grain size, rounded shape, good sorting, and closed fabric. Sedimentary structure such as cross bedding, ripple mark, and parallel lamination also present of nodule (Figure 2). Petrographic analysis showed mineral composition of quartz arenite sandstone with quartz (86%), Feldspar (3.5%), Rock Fragment (6%), opaque mineral and other minerals (4.5%).

In determining age and depositional environment, microfossil analysis was performed on calcareous claystone and resulting Sihapas Formation was deposited at Early Miocene. Depositional facies analysis shows that the Sihapas Formation was deposited on the estuarine and intertidal sandstone environments. Sandstone in the study area has an average trend N 325° E and the average dip of the layer is 10°.

By comparing surface geological data with oil well data on Petapahan Oil Field (Table 1), it shows that sandstone reservoir has similar characteristic to the sandstone found in the Sungai Kuning area, Bukit Suligi. The vertical log reconstruction describes the correlation between field data and subsurface data (Table 1).

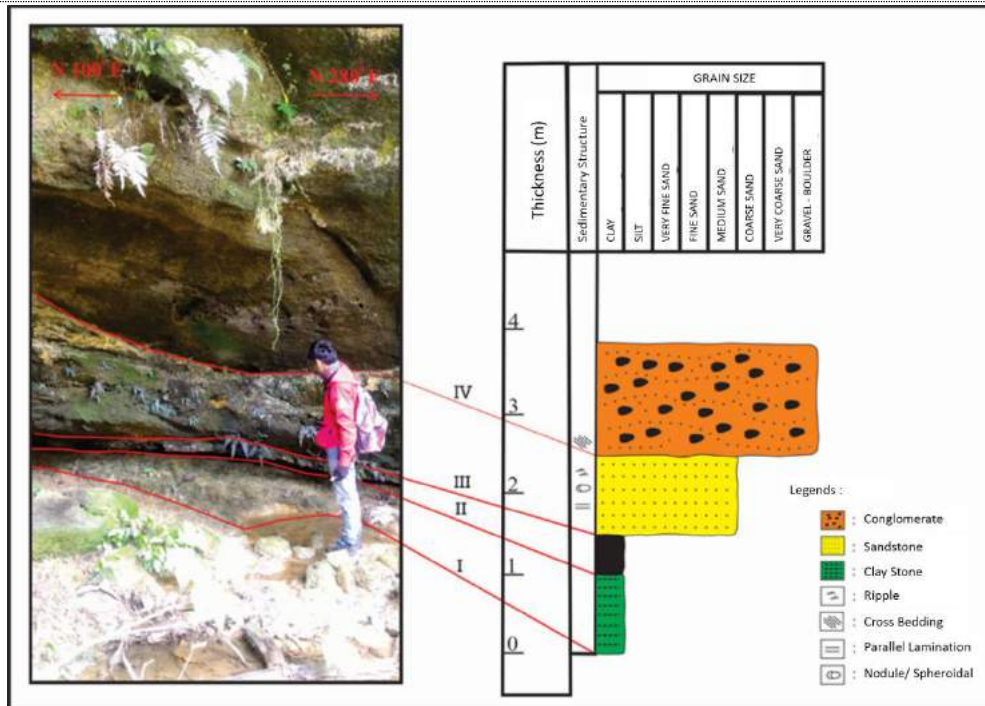

Fig. 2. Field outcrop and vertical log section of geological data at Bukit Suligi

Table 1. Comparison of Stratigraphic column between surficial geological data and Well Data from Petapahan Oil Field.

Age	Faunal Zone	Simbol of lithology	Surficial Geological Data			Well Data (Roizin, 1974)			
			Formation	Characteristic of Lithology	Facies Analysis	Formation	Characteristic of Lithology	Electrofacies	
Miocene	Late	[Green block with horizontal lines]	Petani Formation	Calcareous claystone, yellowish grey (weathered), blackish grey (fresh) color, masive, calcareous.	Shallow nentec to upper slope	Petani Formation	Consist of clayshale which grades downward into gray to brownish gray fossiliferous, silty and glauconitic shale	Very Shallow to Middle Neritic	
									N17
	Mid	[Green block with vertical lines]	Telisa Formation	Shale with yellowish grey (weathered), grey (fresh) color, laminated with nodule in some layer, calcareous	Shallow to Middle Neritic	Telisa Formation	Predominantly shale with thin sandstone interbeds	Open Marine Shallow - Deep Marine	
									N15
									N14
									N13
									N12
									N11
	Early	[Yellow block with dots]	Sihapas Formation	Consist of conglomerate, sandstone and shalestone. sandstone with characteristic reddish yellow (weathered) and greyish yellow (fresh) color, fine - coarse grain size, rounded shape, good sorting, closed fabric. cross bedding , ripple., and parallel lamination structure, with nodule, gentle hardness.	Estuarine and intertidal sandstone	Sihapas Formation	The reservoir unit, predominantly consist of porous quartzose sandstone with silt and shale interbeds	Open Marine - Marginal Marine	
									N9
N8									
N7									
N6									
N5									

From studying lithology characteristics of surface geological data, it will give the best analogy for interpreting the sandstone reservoir model in oil and gas field. Sandstone characteristic of Sihapas Formation that found in Bukit Suligi area predicted to have connectivity with the Bekasap Formation at several oil and gas fields in southwest Central Sumatra Basin. Although there is still lot data analysis needed to convinced the connectivity between surficial geological data and reservoir on subsurface, but from geological reconstruction trends and dips layer and also by combining typical description lithology, concluded that this reservoir is connected each other.

The issue that have been developed for this area was the occurrence of hydrodynamic control and slanted oil water contact towards southeast to south. So it still need further study to know the correlation and connectivity of this reservoir related to hydrodynamic control in the area.

3. CONCLUSION

From this study some conclusions could be defined:

1. Based on field geological data, Sihapas Formation consist of sandstone, conglomerate, claystone lithology. The main characteristics of sandstone are reddish yellow (weathered) and greyish yellow (fresh) color, fine - coarse grain size, rounded shape, good sorting, and closed fabric. Sedimentary structure such as cross bedding, ripple mark, and parallel lamination also present with minor nodule. This sandstone is interpreted to be deposited at Early Miocene on estuarine and intertidal depositional environment.
2. Comparison between characteristic lithology, mineralogy, and other description on geological surface data and reservoir data at oil well

field on south central Sumatra Basin, shows the similarity characteristic of each other.

3. There are possibilities to correlate the surface data and subsurface by further analysis to predict the hydrodynamic effect on oil field.

REFERENCES

- Cameron, N. R. The Stratigraphy of The Sihapas Formation in the Northwest of the Central Sumatra Basin. Indonesian Petroleum Association, Proceedings 12th Annual Convention, Jakarta, 1983, I, 43–66, (1983).
- Clarke, M. C. Geological Map of The Pakanbaru Quadrangle, Sumatra, PPPG, (1982).
- De Coster, G. L. The Geology of the Central and South Sumatra Basins. Proceedings Indonesian Petroleum Association, Third Annual Convention, 77–110, (1974).
- Eubank, R., & Makki, A. C. Structural Geology of The Central Sumatra Back-Arc Basin. Oil and Gas Journal, 79 (50), 200–206, (1981).
- Heidrick, T. L., & Aulia, K. A structural and tectonic model of the Coastal Plains Block, Central Sumatra Basin, Indonesia. Indonesian Petroleum Association, Proceedings 22nd Annual Convention, Jakarta, 1, 285–317, (1993).
- Mertosono, S., & Nayoan, G. A. S. The Tertiary basinal area of Central Sumatra. Indonesian Petroleum Association, Proceedings 3rd Annual Convention, Jakarta, 63–76, (1974).
- P., S. A., M., R., W., U., A., B., & A., B. Paleogene Sediment Character of Mountain Front Central Sumatra Basin Cekungan Sumatra Tengah.

-
- Indonesian Journal on Geoscience, 8 (3), 143–149, (2013).
- R.A. LEE. Petroleum Geology Of The Malacca Strait Contract Area (Central Sumatra Basin). In Proceedings Indonesian Petroleum Association Eleventh Annual Convention. (1982).
- Roezin, S. The Discovery and Development of the Petapahan oil field, Central Sumatra. Indonesian Petroleum Association, Proceedings 3rd Annual Convention, Jakarta, 111–128. (1974).
- Rozalli, M., Putra, A., Budiman, A., Utomo, W., Suandhi, P. A., & Bachtiar, A. New Insights Into the Petroleum Geology of the Mountain Front Area. Proceedings Indonesian Petroleum Association Thirty-Sixth Annual Convention & Exhibition, (2012).
- Wongsosantiko, A. Lower Miocene Duri Formation sands, Central Sumatra Basin. Indonesian Petroleum Association, Proceedings 5th Annual Convention Jakarta, I, 133–150. (1976).

EFFECT OF SAFETY FACTORS ON THE CALCULATED DEFLECTION OF 1-PILE ROW FULL SCALE NAILED-SLAB PAVEMENT SYSTEM RESTING ON SOFT CLAY DUE TO CONCENTRIC LOADINGS

Anas Puri

¹ Associate Professor Department of Civil Engineering, Universitas Islam Riau,
Email: anaspuri@eng.uir.ac.id

Abstract

The Nailed-slab Pavement System was proposed as an alternative improving for rigid pavement performance on soft soils. Puri, et.al. (2012a) proposed a new approach for practical purpose in designing where pile friction resistance is fully mobilized and the tolerable settlement is considered. The additional modulus of subgrade reaction due to pile installing is defined by using safety factor 2.5. Effect of variation in safety factors (SF) were not considered yet. In this paper, effect of SF variation due to slab deflection will be considered by using SF 1.0 to 3.0. The slab deflection will be calculated by using beam on elastic foundation theory. Analysis will use data of loading test on 1-pile row full scale Nailed-slab by Puri, et.al. (2013). Observed deflection data will be used to determine the additional modulus of subgrade reaction. Calculated deflection based on the additional modulus of subgrade reaction is compared to the observed deflection. Results show that SF variation affects the calculated deflections. Good results are obtained in the sense that the calculated settlement is in good agreement with observation. The SF = 1.0 is adequate for analysis. The Nailed-slab in the field will have extensive area and alot of number of installed pile under the slab. Hence, the performance of this system would be better due to reduction on the slab deflection.

Keywords: *Deflection, Nailed-Slab Pavement System, Safety Factor, Soft Clay, Subgrade Modulus*

1. INTRODUCTION

The Nailed-slab System was proposed as an alternative improving for rigid pavement performance on soft soils. It is also to gain the efficiency of construction implementation. The changing of the shell of *fondasi cakar ayam* (hen's claw foundation) by short-friction piles was proposed by Hardiyatmo (2008). The rigid pavement slab is nailed to the subgrade by installing the short piles underneath. The slab has double functions: as pavement structures and all at once as pile cap. The

composite system is developed which consist of slab, piles, and soils surrounding the piles and slab. The installed piles under the slab make the slab keeps contact with the soils and increase the slab stiffness (Puri, et.al., 2011a). Then the slab height can be decreased. The decreasing of slab height can reduce the weight of the structure and will be beneficial for soft soils (Hardiyatmo dan Suhendro, 2003).

Physical modeling of nailed-slab and it's analytical study have been conducted for soft soils (Hardiyatmo dan Suhendro, 2003;

Hardiyatmo, 2008, 2009, 2011; Nasibu, 2009; Dewi, 2009; Taa, 2010; Puri, et.al, 2011a, 2011b, 2012) and for sand (Somantri, 2013). Analysis of deflection of a nailed-slab by using equivalent modulus of subgrade reaction has been done by Hardiyatmo (2009, 2011), Puri, et.al. (2011b, 2012a, 2012b, 2013), Somantri (2013) and Puri (2015, 2017). This modular was also implemented in *cakar ayam* analysis (Puri & Ardiansyah, 2017; Afriliyani, et.al. 2017; Agustin, et.al. 2017).

The equivalent modulus of subgrade reaction is the cumulative of modulus of subgrade reaction from plate load test (k) and additional modulus of subgrade reaction due to pile installing ($\square k$). Hardiyatmo (2011) used the additional modulus of subgrade reaction based on the relative displacement between the pile and soils. The developing of formula was based on static theory. Puri, et.al. (2012a) proposed a new approach for practical purpose in designing Nailed-slab System where pile friction resistance is fully mobilized and the tolerable settlement is considered.

The proposed method of analysis is based on one row of pile. Practically, the Nailed-slab will be constructed by multiple rows of piles. This system will have higher capacity and stiffness. Hence, designing of the Nailed-slab System based on an analysis of the one row pile will produce a safe design (Puri, et.al. 2012a; Puri, 2015).

This paper is aimed to discuss the effects of safety factor in the additional modulus of subgrade reaction due to the prediction of deflection on nailed-slab under concentric loading. The experimental was conducted by full scale model test of one row pile nailed-slab system.

In designing the Nailed-slab, it is required an equivalent modulus of subgrade reaction due to pile bearing contribution (k'). The analytical approach of this moduli is determined by accumulating the modulus of

subgrade reaction from plate load test (k) and the additional modulus of subgrade reaction due to pile installing ($\square k$). The equivalent modulus of subgrade reaction (k') is given as follows (Hardiyatmo, 2011; Dewi, 2009; Puri, et.al., 2011b, 2012a):

$$k' = k + \Delta k \quad (1)$$

Where k is the modulus of subgrade reaction from plate load test (kN/m^3), $\square k$ is the additional modulus of subgrade reaction due to pile installing (kN/m^3).

The mobilisation of unit friction resistance of pile shaft is in elastic zone (Puri, et.al. 2012a). Safety factor 2.5 is usually used in practical of determining the pile allowable bearing capacity. Then the the additional modulus of subgrade reaction due to pile installing ($\square k$) can be defined as

$$\Delta k = \frac{f_s A_s}{2.5 \delta_a A_{ps}} \quad (2)$$

Where \square_a is the tolerable settlement of rigid pavement slab (m), f_s is the ultimate unit friction resistance of pile shaft (kN/m^2), A_s is the surface area of pile shaft (m^2), A_{ps} is the area of plate zone which supported by single pile (m^2), and 2.5 is the safety factor.

And the Equation (2) can be written as (Puri, 2015)

$$\Delta k = \frac{f_s A_s}{SF \delta_a A_{ps}} \quad (3)$$

The end bearing resistance of pile can be ignored for nailed-slab which resting on soft soils. Ultimate unit friction resistance of the pile shaft in saturated clay is expressed by

$$f_s = a_d c_u \quad (4)$$

Where a_d is the adhesion factor (non-dimensional), and c_u is the undrained cohesion of soil (kN/m^2).

The slab deflections due to the load acting on plate-supported piles can be calculated by theory of beams on elastic foundation

(BoEF) (Hardiyatmo, 2009, 2011; Taa, 2010; Puri, et.al., 2011b, 2012a, 2012b; Somantri, 2013; Puri, 2015, 2017). In this case, BoEF will use Roaks formulas according to Young dan Budynas (2002). The k is replaced by k' for analysis of nailed-slab system.

INVESTIGATED 1-PILE ROW FULL SCALE NAILED-SLAB PAVEMENT SYSTEM

Detail of the procedure on 1-pile row full scale Nailed-slab is presented in Puri, et.al. (2013) and briefly described in Puri, et.al. (2014). The 1-pile row full scale nailed-slab was constructed on soft clay. The soft clay properties are presented in Table 1. The slab and piles were reinforced concrete. The concrete strength characteristic of the slab and piles was 29.2 MPa and 17.4 MPa respectively. The flexural strength of the slab was 4,397.6 kPa.

Table 1 Soft clay properties (Puri, et.al. 2013)

Parameter	Unit	Average
Specific gravity, G_s	-	2.55
Consistency limits:		
- Liquid limit, LL	%	88.46
- Plastic limit, PL	%	28.48
- Shrinkage limit, SL	%	9.34
- Plasticity index, PI	%	59.98
- Liquidity index, LI	%	0.36
Water content, w	%	54.87
Clay content	%	92.93
Sand content	%	6.89
Bulk density, ρ	kN/m ³	16.32
Dry density, ρ_d	kN/m ³	10.90
Undrained shear strength, s_u	kN/m ²	20.14
CBR	%	0.83
Soil classification:		
- AASHTO	-	A-7-6
- USCS	-	CH

The Nailed-slab System Prototype dimension was 6.00 m × 3.54 m, 0.15 m in slab thickness, and the slab was reinforced by micro piles 0.20 m in diameter and 1.50 m in length. The spacing between piles was 1.20 m. This model was obtained by cutting the 600 cm × 354 cm × 15 cm Nailed-slab to 3 parts where each part consisted of one pile row. The tested 1 pile row Nailed-slab was the middle one with slab dimension 600 cm × 120 cm × 15 cm. All piles were installed under the slab and connected monolithically by using thickening slab

connectors (0.40 m × 0.40 m and 0.20 m in thickness). Each end of slab is equipped by the vertical concrete wall barrier. There was a 5 cm lean concrete thickness under the slab. The slab was loaded by compression loadings with different load positions. Loads were transferred to the slab surface by using a circular plate 30 cm in diameter (the plate represents the wheel load contact area). Then the instrumentations were recorded. Details about testing procedure is presented in Puri, et.al. (2013, 2014).

BoEF analysis will use the “BoEF.xls software version 1.4”. According to limitation of BoEF, some simplification have to be done (Puri, 2015). The pile-slab connector and vertical wall barrier were neglected. Lean concrete was also neglected. Comprehensive analysis procedure is presented in Puri, et.al (2013 and Puri (2015).

RESULT AND DISCUSSION

Modulus of Subgrade Reaction

The Eq. (3) was used to calculate the additional modulus of subgrade reaction due to one row pile installation under the slab; the results are shown in Table 2 by variation in safety factor. The tolerable settlements (δ_a) were taken by using maximum observed deflections. Equivalent moduli of subgrade reactions are included in Table 2. It seem that the Δk and k' tend to decrease by increasing the load because of the increasing in slab deflection. The Δk and k' tend to decrease also by increasing the safety factor.

Table 2 Modulus of subgrade reaction

Load (kN)	$\delta_a = \delta_s$ (mm)	Safety factor, SF	$\Delta k \times 10^3$ (kPa/m)	$k' \times 10^3$ (kPa/m)	Load (kN)	$\delta_a = \delta_s$ (mm)	Safety factor, SF	$\Delta k \times 10^3$ (kPa/m)	$k' \times 10^3$ (kPa/m)
5	0.27	1	149.32	152.62	40	0.93	1	16.06	19.36
		1.5	99.54	102.84			1.5	10.70	14.00
		2	74.66	77.96			2	8.03	11.33
		2.5	59.73	63.03			2.5	6.42	9.72
		3	49.77	53.07			3	5.35	8.65
10	0.27	1	55.30	58.60	80	2.06	1	7.25	10.55
		1.5	36.87	40.17			1.5	4.83	8.13
		2	27.65	30.95			2	3.62	6.92
		2.5	22.12	25.42			2.5	2.90	6.20
		3	18.43	21.73			3	2.42	5.72
20	0.41	1	36.42	39.72	150	4.52	1.0	3.30	6.60
		1.5	24.28	27.58			1.5	2.20	5.50
		2	18.21	21.51			2.0	1.65	4.95
		2.5	14.57	17.87			2.5	1.32	4.62
		3	12.14	15.44			3.0	1.10	4.40

Results of Deflection

Results of deflection analysis are shown in Fig. 1 and 2. Fig. 1 shows the $P-\Delta$ relationship on loading point of nailed-slab. Good results are obtained in the sense that the calculated settlement is in good agreement with observation. All calculated deflection based on variation of SF tend to

over-estimated. For $SF = 1.0$, the over-estimated about 68% for maximum load 150 kN. SF variation affects the calculated deflections. The over-estimated tends to increase by increasing in SF. It is also shown in Fig. 1 that $P-\Delta$ curves are in elastic zone as defined in the theory

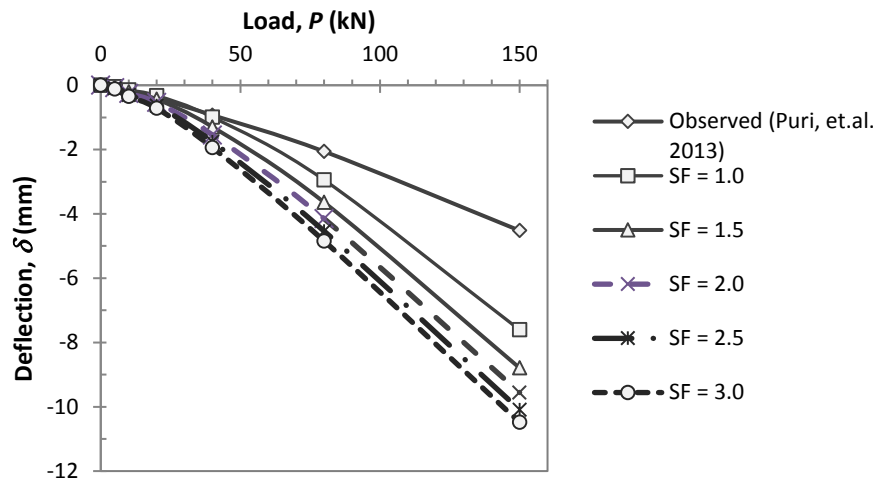

Fig. 1. P - δ relationship on loading point of nailed-slab.

Fig. 2 shows the distribution of calculated deflection along the slab of nailed-slab for load 40 kN. Good results are obtained in the sense that the calculated settlement is in good agreement with observation. Calculated deflections tend to over-estimated by increasing the SF and little bit uplift on the both ends of slab. These similar behaviour were also occurred for other

loads. The utilisation of the additional modulus of subgrade reaction (Δk) can well predict the deflections, despite of the Δk theory based on elastic condition (Puri, et.al. 2012, 2013; Puri, 2015, 2017). The Δk was developed based on elastic theory; however it can well predict the deflection in plastic zone

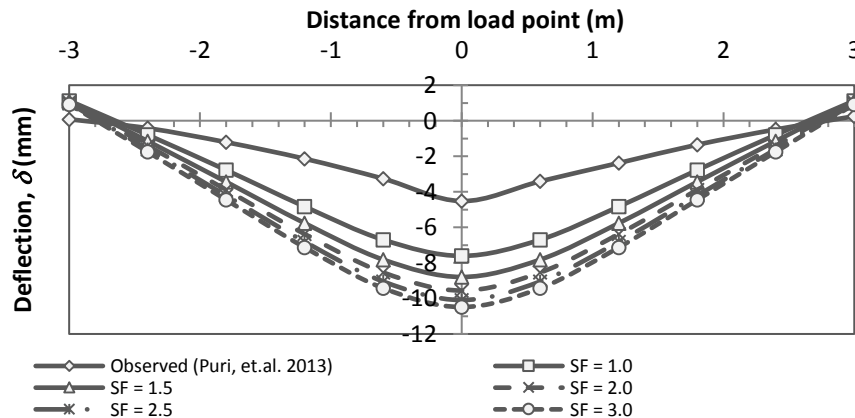

Fig. 2. Distribution of calculated deflection along the slab of nailed-slab for load 40 kN.

CONCLUSION

In this case, the additional subgrade reaction modulus (Δk) can be used for calculating the slab deflection of Nailed-slab Pavement System. SF variation affects the calculated deflections. Good results are obtained in the sense that the calculated

settlement is in good agreement with observation especially for $SF = 1.0$. It can be concluded that the $SF = 1.0$ is adequate for analysis. Since this system will be functioned as pavement in the field, the Nailed-slab will have extensive area and installed pile under the slab will also more and more to all directions. So the

performance of this system would be better due to bearing capacity and reduction on the slab deflection (Puri, et.al. 2014). Further research can be conducted for edge loadings of the Nailed-slab Pavement System.

ACKNOWLEDGEMENT

The author would like to express his gratitude to Ms. Dinda Rosita Agustin, S.T. the fellow researcher in Soil Mechanics Laboratory, Civil Engineering Department, Universitas Islam Riau for her help in running the BoEF.xls software.

REFERENCES

- Afriliyani, N., Puri, A., R. Ardiansyah. (2017). Penerapan Modulus Reaksi Subgrade Ekuivalen Metode Puri, dkk (2012) dalam Perhitungan Lendutan Pelat pada Perkerasan Sistem Cakar Ayam Modifikasi. In: *Prosiding Konferensi Nasional Teknik Sipil dan Perencanaan (KN-TSP) 2017*, Program Studi Teknik Sipil, Universitas Islam Riau, Pekanbaru, 9 Februari 2017, pp. 29-35.
- Agustin, D.R., Puri, A., R. Ardiansyah. (2017). Perhitungan Lendutan Perkerasan Jalan Sistem Cakar Ayam Modifikasi dengan Variasi Faktor Aman pada Tambahan Modulus Reaksi Subgrade. In: *Prosiding Konferensi Nasional Teknik Sipil dan Perencanaan (KN-TSP) 2017*, Program Studi Teknik Sipil, Universitas Islam Riau, Pekanbaru, 9 Februari 2017, pp. 76-84
- Dewi, D.A. (2009). Study on Effect of Single Pile Due to the Value of Equivalent Modulus of Subgrade Reaction from Full-scale Loading Tests. *Master Theses*. Post Graduate Program of Engineering, Universitas Gadjah Mada, Yogyakarta, Indonesia (in Indonesian).
- Hardiyatmo, H.C. (2008). Nailed-slab System for Reinforced Concrete Slab on Rigid Pavement. *Proc. of National Seminar on Appropriate Technology for Handling Infrastructures*, MPSP JTSL FT UGM., Yogyakarta, Indonesia, pp. M-1—M-7 (in Indonesian).
- Hardiyatmo, H.C. (2009). Method to Analyze the Slab Deflection by Using Equivalent Modulus of Subgrade Reaction for Flexible Slab Structure. *Dinamika Teknik Sipil*, Vol.9 No.2 (2009) 149-154 (in Indonesian).
- Hardiyatmo, H.C. (2011). Method to Analyze the Deflection of the Nailed Slab System, *IJCEE-IJENS*, Vol 11. No. 4 (2011) 22-28. <http://ijens.org/IJCEE%20Vol%2011%20Issue%2004.html>.
- Hardiyatmo, H.C., Suhendro, B. (2003). Pile Foundation with Thin Pile Cap as an Alternative to Solve Problems of Building on Soft Soils. *Report of Competitive Grant Research of Higher Education*, Institute for Research and Community Service, Gadjah Mada University, Yogyakarta, Indonesia (in Indonesian).
- Nasibu, R. (2009). Study on Modulus of Subgrade Reaction Due to Effect of Pile Attached Under Plate (Loading Test on Fullscale). *Master Theses*. Post Graduate Program of Engineering, Universitas Gadjah Mada, Yogyakarta, Indonesia (in Indonesian).
- Puri, A. (2015). Behavior of Pavement of Nailed-slab System on Soft Clay. *Dissertation*, Doctoral Program of Civil Engineering, Universitas Gadjah Mada, Yogyakarta, Indonesia.
- Puri, A. (2017). Developing the Curve of Displacement Factor for Determination The Additional Modulus of Subgrade Reaction on Nailed-slab Pavement System. *International Journal of Technology*, Vol. 8 No. 1 (2017) 124-133. ISSN 2086-9614. <http://ijtech.eng.ui.ac.id/article/view/232>.
- Puri, A., and Ardiansyah, R. (2017). Calculation The Edge of Slab Deflection of Modified Cakar Ayam System By

- Applying The Displacement Factor from Puri's Graph. *In: Proceeding the 15th International Symposium in QiR (Quality in Research)*, Nusa Dua, Bali, 24-27 July, Indonesia. DOI: <https://doi.org/10.14716/ijtech.v8i1.1688>
- Puri, A., Hardiyatmo, C. H., Suhendro, B., Rifa'i, A. (2011a). Experimental Study on Deflection of Slab which Reinforced by Short Friction Piles in Soft Clay. *In: Proc. of 14th Annual Scientific Meeting (PIT) HATTI*, HATTI, Yogyakarta, 10-11 February, pp. 317-321 (in Indonesian).
- Puri, A., Hardiyatmo, H.C., Suhendro, B., Rifa'i, A. (2011b). Contribution of Wall Barrier to Reduce the Deflection of Nailed-Slab System in Soft Clay. *In: Proc. of 9th Indonesian Geotech. Conf. and 15th Annual Scientific Meeting (KOGEI IX & PIT XV) HATTI*, HATTI, Jakarta, 7-8 December 2011, pp. 299-306 (in Indonesian).
- Puri, A., Hardiyatmo, H.C., Suhendro, B., Rifa'i, A. (2012a). Determining Additional Modulus of Subgrade Reaction Based on Tolerable Settlement for the Nailed-slab System Resting on Soft Clay, *IJCEE-IJENS*, Vol. 12 No. 3 (2012) 32-40. <http://ijens.org/IJCEE%20Vol%2012%20Issue%2003.html>.
- Puri, A., Hardiyatmo, H.C., Suhendro, B., Rifa'i, A. (2012b). Application of the Additional Modulus of Subgrade Reaction to Predict the Deflection of Nailed-slab System Resting on Soft Clay Due to Repetitive Loadings. *In: Proceedings of Pertemuan Ilmiah Tahunan ke-16 (PIT) HATTI*, Jakarta, 4 December, Indonesia, pp. 217-222.
- Puri, A., Hardiyatmo, H.C., Suhendro, B., Rifa'i, A. (2013). Application of the Method of Nailed-slab Deflection Analysis on Full Scale Model and Comparison to Loading Tests. *In: Proceedings of Konferensi Nasional Teknik Sipil ke-7 (KoNTekS7)*, Universitas Negeri Sebelas Maret. Surakarta, 24-26 October, Indonesia, pp. G201-G211.
- Puri, A., Hardiyatmo, H.C., Suhendro, B., Rifa'i, A. (2014). Behavior of Nailed-slab System on Soft Clay Due to Repetitive Loadings by Conducting Full Scale Test. *IJCEE-IJENS*, Vol. 14 No. 06 (2014) 24-30. <http://ijens.org/IJCEE%20Vol%2014%20Issue%2006.html>.
- Somantri, A.K. (2013). Kajian Lendutan Pelat Terpaku pada Tanah Pasir dengan Menggunakan Metode Beam on Elastic Foundation (BoEF) dan Metode Elemen Hingga. *Master's Thesis*. Post Graduate Program of Engineering, Universitas Gadjah Mada, Yogyakarta, Indonesia (in Indonesian).
- Taa, P.D.S. (2010). Effects of Installation of Group Pile Due to Slab Uplift of Nailed-slab Resting on Expansive Subgrade. *Master Theses*. Post Graduate Program of Engineering, Universitas Gadjah Mada, Yogyakarta, Indonesia (in Indonesian).
- Young, W.C., Budynas, R.G. (2002). *Roark's Formula for Stress and Strain*. 7th ed. New York: McGraw-Hill.

EFFECT OF MATURITY LEVEL OF COMPOST AND SHALLOT VARIETIES TO GROWTH AND YIELD IN PEAT SOIL

Raisa Baharuddin¹, Selvia Sutriana²

^{1,2} Agrotechnology Study Program, Faculty of Agriculture, Universitas Islam Riau
Jl. Kaharuddin Nasution, Marpoyan, Pekanbaru 28284
Riau, Indonesia

Email: raisabaharuddin@agr.uir.ac.id

Abstract

The use of compost fertilizer with the right maturity level can improve the characteristic of peat. Besides, the use of appropriate varieties on peat will increase plant production. Aim of this research was to determine the effect of maturity level of compost and shallot varieties to growth and yield of shallot in peat soil. The experiment was conducted from March to August 2017 at Experimental Farm, Faculty of Agriculture, Islamic University of Riau, Pekanbaru. The research used a completely randomized design with 3 replications. First factors is maturity level of compost consists of 4 levels ie no compost, 1 week, 3 weeks, and 5 weeks. The second factor is varieties which are Kampar, Medan, and Brebes. The results showed that compost maturity level 3 weeks gave the lowest C/N ratio (18.67) than the compost of 1 and 5 weeks. The compost also provides the highest nutrient content in N-total, P, K, Ca and Mg. The maturity level of compost gives different results on the growth and yield of each variety. The compost maturity level 1 week on Brebes variety gave the highest of wet weight bulb (42.51 g), dry weight bulb (36.83 g), and total yield of shallot (9.21 ton/ha).

Keywords: *Compost, Maturity Level, Peat, Shallot, Varieties*

1. INTRODUCTION

Shallot is one of superior vegetable commodities, that used as a complementary seasoning on various dishes to produce pleasant aromas and flavors (Kumar et al., 2010). Shallot is a vegetable commodity that has high economic value and can be developed in low land high land.

The production of shallot in Indonesia was fluctuating in some

provinces. It was due to fluctuations in environmental factors. Based on this, the availability of suitable varieties and high yield were factors affecting yield. The development of shallot in Riau was still relatively less, because based on data recorded in the Central Bureau of Statistics in Riau, shallot cultivation begins in 2013 with Kampar varieties. Riau, is the province with the largest peatland in Sumatera is \pm 3.87 million ha, but only about 19% of

peatlands are feasible for agriculture. Assess the potential that allows shallot to be developed in peat.

Peat soil is defined as an accumulation of the debris of plant, trunk and roots under the water logging condition (Mohamed et al., 2014; Adon et al., 2012). Soil on land or forest peat bogs derived of a pile of organic matter saturated water or flooded that the process decomposition are not going well. This condition caused it were poor in nutrients and low pH. Based on these problems required the improvement of physical and chemical soil characteristics. The way to improve the characteristics of the peat is using compost.

Composting is the controlled aerobic conversion of mixed organic material into a form that is suitable for addition to soil (Hubbe et al., 2010). The three most important factors for making good compost are the chemical makeup of the raw ingredients, the physical size and shape of the feedstocks and the porosity of the pile, and the population of microorganisms involved in the composting process (Cooperband 2000).

Compost maturity is one of the significant parameters to evaluate the quality of compost. Compost maturity plays an important role in distinguishing whether it can be used as a soil conditioner for physical, chemical and biological fertility benefits or for disease suppression in soil (Kutsanedzie et al., 2015). Many uses of compost require a mature product that will prevent nutrients that are present in the soil from being tied up or immobilized (Latifah et al., 2015). Therefore, mature compost is important because it will not adversely affect plant development due to reduced oxygen or nitrogen availability and/or the presence of phytotoxic compounds.

Assess the potential peat in Riau and by the provision of compost with proper maturity level expected to improve the production of shallot in Riau. This paper aims to determine the effect of maturity

level of compost and shallot varieties to growth and yield of shallot in peat soil.

2. METHODOLOGY

The experiment was conducted at Experimental Farm, Faculty of Agriculture, Islamic University of Riau, Pekanbaru from March to August 2017. Material used is shallot varieties Kampar, Medan, and Brebes, compost fertilizer from debris corn, NPK 16: 16: 16, label, insecticide, fungicide. An instrument used is a equipment cultivation, measuring unit, analytic scale, and stationery.

The research used a factorial completely randomized design with 3 replications. First factors is maturity level of compost consists of 4 levels ie no compost, 1 week, 3 weeks, and 5 weeks. The second factor is varieties consists of are Kampar, Medan, and Brebes. Plot size of 1 m x 1 m with planting distance of 20 x 20 cm. Weeding was done manually plants adapted to the circumstances of weed, while control of pest and disease were done by the observations every day.

Composting begins with enumeration of debris corn with a enumerators compost machine. Then the chopped plant was given an activator. The activator used was EM4 with a dose of 1 L per 1 ton of chopped plant. Activators dissolved into sugar solution. Chopped plant fragments that have been mixed with EM-4 solution, stirred evenly and then taken to the field to form composting pile. Stirring and reversal twice a week. Composting time is adjusted to the level of treatment.

Observation variables included plant height, age of harvest, weight of wet bulb per cluster, weight of dry bulb per cluster, and production. The data were analyzed by F-test, whereas between treatments were tested by Tukey test at the 5% significance level.

3. RESULT AND DISCUSSION

Compost Analysis

Based on the results of the analysis nutrients in compost showed that compost produced according to the standard of SNI 19-7030-2004, which is for N content (higher than 0.4 %), P₂O₅ (higher than 0.1 %) in compost maturity level 1, 3, and 5 weeks, and for K₂O content (larger than 0.2 % in compost maturity level 1 and 3 weeks. In addition to nutrient content, the important parameter for determining compost quality is the C / N ratio. This ratio is used to determine whether the compost is

sufficiently 'mature' or not. Table 1 also showed that the value of C / N ratio of the compost fulfill the SNI standard limit 10-20, except on the compost maturity level 1 week. The value of C/N ratio decline by increasing age compost. This is related to the decomposition process, with increasing age compost, the decomposition process run maximal, where the availability of carbon and nitrogen produced is used by microorganisms maximally and helps microorganisms to reorganize the organic material (Dewilda dan Apris, 2016)

Table 1. Result of Compost Analysis

Age of Maturity level	Nutrients					
	N (%)	P (%)	K (%)	Ca (%)	Mg (%)	C/N
1 Weeks	0.91	0.93	0.79	8.78	3.83	23.42
3 Weeks	1.33	3.15	5.45	9.67	4.01	18.67
5 Weeks	1.31	0.57	0.11	9.01	3.9	20.32

In general can be seen in Table 1, that the highest nutrients content (N, P, K, Ca and Mg) and the lowest C/N ratio have on compost 3 weeks. This caused by compost 3 weeks occurs high deficiency in C/N ratio so that composting process takes more quickly and effectively. According to Susanti (2015), compost derived from agricultural residue usually has a C/N ratio which is relatively close to C/N soil ratio so that the composting process tends to be easier and faster compared to composting of other materials.

According to Putro et al., (2016) the greater deficiency of the value of C / N and the faster the composting process, make better the composting process. Increasing the value of macro nutrients (N, P, K) is used as a parameter of compost quality. The greater the nutrient content of N, P, and K on the compost, the better the compost is when used against the plant. Compost has characteristic that vary depending on maturity level, composition of raw materials and composting process at the time of composting (Kusmiyarti, 2013).

The nutrient content produced by compost litter of maize is higher when compared with the compost of empty fruit bunches. According to Yunindanoval et al. (2013) that the total N content of EFB compost is above 1% but has lower P content is below 0.1% . It showed that the compost used is quite potential because it can produce high nutrient content.

Plant Growth

The growth of shallot has a significantly affect on the maturity level of compost and shallot varieties. Interaction of the maturity level of compost by shallot varieties did not have significant effect on plant height. Table 2 showed that compost maturity level 5 week increases plant height by 32.04 cm. Plant growth is influenced by nutrients delivery, in particular nitrogen. Based on nutrient content of compost, where compost maturity level 5 weeks have high value of N is 1.31%. Vegetative plant growth desperately needs nitrogen. This is because nitrogen is key in the production of nucleoside phosphate and amino acids that

the building blocks amino acids and protein (Taiz dan Zeiger, 2002).

In addition to nitrogen nutrients, a value of C/N ratio also had an influence on shallot height. The C/N value of compost 5 weeks, is still in extend standard limit that is 20 so that wouldn't cause nutrients

immobilization or N nutrient change form into a form that is not available for plant. The low C / N ratio caused absence of competition in obtaining N elements between plants and microbial decomposers, making it easier for plants to absorb nitrogen (Yunindanova et al., 2013).

Table 2. Maturity level of Compost and Shallot Varieties on Plant Height

Maturity Level of Compost	Shallot Varieties (cm)			Average
	Kampar	Medan	Brebes	
No Compost	27.89	25.44	32.78	28.70 c
1 Weeks	30.11	27.44	35.11	30.89 b
3 Weeks	30.33	28.11	36.00	31.48 ab
5 Weeks	32.56	27.56	36.00	32.04 a
Average	30.22 b	27.14 c	34.97 a	

Note: The numbers followed by the same letter on rows and columns are not significantly different based on the Tukey test ($\alpha = 0.05$).

The effect of shallot varieties on the plant height showed that Brebes variety produced the highest plant height is 34.97 cm. The lowest plant height was seen on Medan variety. The difference in growth parameters probably attributed to genetic variation among the varieties. Similar result was reported by Ademe et al. (2012) in that shallot growth parameters were affected by varieties. It also shows that the three varieties are able to adapt to peat soil, because the plant height still in accordance with descriptions of varieties of each plant.

The Harvest Age

Interaction of maturity level of compost and shallot varieties significantly affect the harvest age. The effect of combination of maturity level and shallot variety showed that varieties of Brebes and Kampar with compost maturity level 1-5 weeks gives the fastest harvest age of 61

day after plant (DAP) (Table 3). While the varieties of Medan give the longest harvest age of 68 DAP. Based on the decryption of varieties, the harvest age of three varieties is still in accordance with the description. This showed that the variables of harvest age are more influenced by the character of each variety so that harvest age is also different.

Table 3 also shows that in Kampar variety given compost application significantly accelerate age harvest on shallot. This is because the given organic material is able to provide nutrients to peat soils especially N and P which are indispensable for vegetative and generative growth. The nutrients contained in this compost will improve physical, chemical, and biology characteristic of peat, so that is available and assist the process of plant development (Armaini et al., 2012).

Table 3. Maturity Level of Compost and Shallot Varieties on Age of Harvest

Maturity Level of Compost	Shallot Varieties (DAP)			Average
	Kampar	Medan	Brebes	
No Compost	68.00 b	68.00 b	61.00 a	65.67 b
1 Weeks	61.00 a	68.00 b	61.00 a	63.33 a

3 Weeks	61.00 a	68.00 b	61.00 a	63.33 a
5 Weeks	61.00 a	68.00 b	61.00 a	63.33 a
Average	62.75 b	68.00 c	61.00 a	

Note: The numbers followed by the same letter on rows and columns are not significantly different based on the Tukey test ($\alpha = 0.05$).

Production of Shallot

Interaction of maturity level of compost and shallot varieties significantly affect the harvest age. The combination of compost maturity level with shallot varieties showed that 1 week and Brebes variety gave the highest wet weight, dry weight of bulb per cluster and total yield was 42.51 g, 36.83 g, and 9.21 ton/ha (Table 4). In contrast to local variety Kampar and Medan variety, compost maturity level 1 week significantly decreases wet weight, dry weight of bulb per cluster and

production per ha. This suggests that the varieties of Brebes can adapt to peat soils. In accordance with research Koswara (2007) that the varieties of Brebes is one variety that widely adaptation. Based on this it can be seen that by provision compost with low level of maturity (1 week), varieties of Brebes have been able to give optimal production. Bulb yield of Brebes varieties in this trial approaching with the bulb yield potential of Bima varieties ie 10-12 t/ha (Kusmana et al. 2009, Sofiari et al. 2009).

Table 4. Maturity Level of Compost and Shallot Varieties on Shallot Production

Maturity Level of Compost	Shallot Varieties			Average
	Kampar	Medan	Brebes	
Weight of wet bulb per cluster (g)				
No Compost	32.12 c	23.57 f	39.42 ab	31.70 b
1 Weeks	25.51 ef	16.10 g	42.51 a	28.04 c
3 Weeks	26.07 ef	26.38 def	30.08 cd	27.51 c
5 Weeks	37.91 b	28.35 de	41.16 ab	35.81 a
Average	30.40 b	23.60 c	38.29 a	
Weight of dry bulb per cluster (g)				
No Compost	27.70 b	21.77 c	35.10 a	28.19 b
1 Weeks	23.97 bc	11.37 d	36.83 a	24.06 c
3 Weeks	21.50 c	21.33 c	25.50 bc	22.78 c
5 Weeks	34.43 a	24.43 bc	35.67 a	31.51 a
Average	26.90 b	19.73 c	33.28 a	
Production per ha (ton/ha)				
No Compost	6.92 b	5.44 c	8.77 a	7.05 b
1 Weeks	5.99 bc	2.84 d	9.21 a	6.01 c
3 Weeks	5.37 c	5.33 c	6.37 bc	5.69 c
5 Weeks	8.61 a	6.11 bc	8.91 a	7.88 a
Average	6.72 c	4.93 b	8.32 a	

Note: The numbers followed by the same letter on rows and columns are not significantly different based on the Tukey test ($\alpha = 0.05$).

Different level of compost maturity produce different production. The proper maturity level of compost give higher yield. Based on the results, that compost maturity level 5 weeks give the highest wet weight and dry weight of bulb per cluster and production per hectare than other compost treatment and control. It was because at compost maturity level 5 weeks, the compost has been decomposed perfectly so that when applied to the soil or plant does not occur nutrient immobilization.

Use of compost can increase growth and shallot production (Table 4). This is because affected by the nutrients contained in compost. In the development of fruit, most important nutrients were N, P and K. According to Shanchez (1992), tuber plants are high phosphorus absorbers. Phosphorus is very important for the formation and development of bulbs. Potassium is also very important for onion plants. Potassium plays a role in the process of metabolism, nutrient absorption, transpiration, carbohydrate translocation, activation of a large number of enzymes essential for photosynthesis and respiration (Salisbury dan Ross, 1995). Shortage of potassium in onion plants will inhibit the growth of leaf that photosynthesis process also becomes inhibited and resulted in the size of the resulting small bulb of shallots. He et al. (2004) stated that the balance of nutrients in the soil, especially K plays an important role in the synthesis of carbohydrates and protein, so it helps enlarge bulb of shallots.

The availability of nutrients (N, P, K) contained in the compost, provides a positive response to bulb growth, which will be absorbed and translocated to leaves to be assimilated in the photosynthesis process. One result of this photosynthesis is fructan, where fructan is necessary for the formation of tuber (Yetti and Elitta, 2008). The Liliaceae plant stores the fructan in the bulb (Salisbury and Ross, 1995).

4. CONCLUSION

1. Compost maturity level 3 weeks gave the lowest C/N ratio (18.67) than the compost of 1 and 5 weeks. The compost also provides the highest nutrient content in N-total (1.33%), P₂O₅ (3.15%), K₂O (5.45%), Ca (9.67%) and Mg (4.01%).
2. The maturity level of compost gives different results on the growth and production of each variety. The compost maturity level 1 week on Brebes variety gave the highest of wet weight bulb (42.51 g), dry weight bulb (36.83 g), and total yield of shallot (9.21 ton/ha). In addition, the compost maturity level 5 week could increase the growth and production of Kampar and Medan varieties in peat soil.

REFERENCES

- Ademe, D., Belew D. and Tabor G. (2012). Influence of bulb topping and intra row spacing on yield and quality of some shallot (*Allium Cepa* Var. *Aggregatum*) varieties at Aneded woreda, western Amhara. *Afric. J. Plant Sci.*, 6(6): 190-202. September 30, 2017. <http://www.academicjournals.org/journal/AJPS/article-full-text-pdf/A6ABF5611842>
- Adon, R, Bakar I, Wijeyesekera D C, Zainorabidin A. (2012). Overview of the sustainable uses of peat soil in malaysia with some relevant geotechnical assessments. *International Journal of Integrated Engineering – Special Issue on ICONCEES*. 4 (3) :38-46. March 29, 2016. <http://penerbit.uthm.edu.my/ojs/index.php/ijie/article/view/584>
- Armaini, Erlida A., Sri Y., Edison A. (2012). Optimization of soybean production (*Glycine max* (L) Merrill) in palm oil plantation on peatland by application of some fertilizers and

- soil ameliorant. *J. Agrotek. Trop.* 1 (2): 11-15. September 20, 2017. [http://download.portalgaruda.org/article.php?article=315573&val=5123&title=Optimalisasi%20Produksi%20Kedelai%20\[Glycine%20max%20\(L\)%20Merril%20pada%20Kebun%20Kelapa%20Sawit%20di%20Lahan%20Gambut%20dengan%20Aplikasi%20Beberapa%20Komposisi%20Pupuk%20dan%20Pembenahan%20Tanah](http://download.portalgaruda.org/article.php?article=315573&val=5123&title=Optimalisasi%20Produksi%20Kedelai%20[Glycine%20max%20(L)%20Merril%20pada%20Kebun%20Kelapa%20Sawit%20di%20Lahan%20Gambut%20dengan%20Aplikasi%20Beberapa%20Komposisi%20Pupuk%20dan%20Pembenahan%20Tanah).
- Cooperband, L.R. (2000). Composting: art and science of organic waste conversion to a valuable soil resource. *Laboratory Medice.* 31(6): 283-290. March 26, 2016. <https://academic.oup.com/labmed/article-pdf/31/5/283/9676822/labmed31-0283.pdf>
- Dewilda, Y., Apris I. (2016). Study optimization of composting materials of organic waste with addition of load waste bioaktivator and water oil. *Proceedings of the National Seminar on Environmental Science and Technology*, Padang, 19 Oktober 2016: 95-100. September 30, 2017. http://lingkungan.ft.unand.ac.id/images/fileTL/SNSTL_II/full_paper_yomi_1.pdf.
- Hubbe, M A., Mousa N., Carmen S. (2010). Composting as a way to convert cellulosic biomass and organic waste into high value soil amendments: a review. *Bioresources*, 5(4) : 2808-2854. March 26, 2016. http://ojs.cnr.ncsu.edu/index.php/BioRes/article/view/BioRes_05_4_2808_Hubbe_NS_Composting_Review/781
- Kumar, K.P.S., D. Bhowmik, Chiranjib, Biswajitand Pankaj Tiwari. (2010). *Allium cepa*: a traditional medicinal herb and its health benefits. *J. Chem. Pharm. Res.*, 2(1): 283-291. March 20, 2016. <http://www.jocpr.com/articles/allium-cepa-a-traditional-medicinal-herb-and-its-health-benefits.pdf>.
- Kusmana, RS and H. Basuki Kurniawan. (2009). Adaptation test five varieties shallots origin highlands and medium lowlands ecosystem at Brebes. *Journal of Horticulture*, 19 (3), 281-286. September 29, 2017. http://hortikultura.litbang.pertanian.go.id/jurnal_pdf/193/kusmana_ada_ptasibwmerah.pdf
- Kusmiyarti, T.B. (2013). The quality of compost on various combinations of organic waste raw materials. *Agrotrop*, 3(1): 83-92. September 25, 2017. <http://download.portalgaruda.org/article.php?article=348888&val=924&title=Kualitas%20Kompos%20dari%20Berbagai%20Kombinasi%20Bahan%20Baku%20Limbah%20Organik>.
- Kutsanedzie, F., Ofori, V., K.S. Diaba. (2015). Maturity and safety of compost processed in HV and TW composting systems. *International Journal of Science, Technology and Society.* 3: 232-239. September 29, 2017. <http://www.sciencepublishinggroup.com/journal/paperinfo?journalid=183&doi=10.11648/j.ijsts.20150304.24>
- Latifah, O., Osumanu, H.A., Nik, M.A. (2015). Improving ammonium and nitrate release from urea using clinoptilolite zeolite and compost produced from agricultural wastes. *The Scientific World Journal*: 1-12. September 20, 2017. <https://www.hindawi.com/journals/tswj/2015/574201/>
- Mohamed, R.M.S.R., Chan, C.M., Senin, H., Kassim, A.H.M. (2014). Feasibility of the direct filtration over peat filter media for bathroom

- greywater treatment. *J. Mater. Environ. Sci.* 5 (6): 2021- 2029. March 21, 2016.
https://www.researchgate.net/publication/266149562_Feasibility_of_the_direct_filtration_over_peat_filter_media_for_bathroom_greywater_treatment
- Ningsih, R.D. and Noor, A. (2016). Appearance of varieties of shallot in tidal area of south kalimantan. *Proceedings of the National Seminar on Agricultural Technology Innovation*. Banjarbaru, 893-899. September 5, 2017.
http://kalsel.litbang.pertanian.go.id/ind/images/pdf/Semnas2016/110_rina_dirgahayu.pdf
- Putro, B.P., Walidaini, R.A., Ganjar S., Winardi, D.N. (2016). Increasing the quality of organic waste compost with NPK fertilizer enriched and urea. *Proceedings SNST 7th in 2016*: 17-22. September 5, 2017.
https://www.publikasiilmiah.unwah.ac.id/index.php/PROSIDING_SNST_FT/article/viewFile/1466/1550
- Salisbury, F.B., and Ross. (1995). *Plant physiology*. Bandung: ITB.
- Sofiari, E., and Kusmana, R.S. (2009). Evaluation of local cultivars shallots yield at Brebes. *Journal of Horticulture*, 19 (3), 257-280. September 25, 2017.
http://hortikultura.litbang.pertanian.go.id/jurnal_pdf/193/sofiari_bwmerah.pdf
- Susanti, D S. (2015). Application type of compostes on growth and yield of shallot (*Allium ascalonicum* L.) in enrekang regency. *Agricola*, 5 (1): 61-69. September 25, 2017.
<http://ejournal.unmus.ac.id/index.php/agricola/article/view/412>
- Taiz, L. and Zeiger, E. (2002). *Plant physiology*. 3rd Edition. Sunderland: Sinauer Associates.
- Yetti, Y. and Elitta, E. (2008). Use of organic fertilizer and KCl on shallot (*Allium ascalonicum* L). *SAGU*, 7 (1):113-18. September 25, 2017.
<https://ejournal.unri.ac.id/index.php/JSG/article/view/1097/1089>.
- Yunindanoval, M.B., Herdhata, A., and Dwi, A. (2013). The effect of maturity level of empty fruit bunch compost and mulch from palm oil waste to tomato productivity in ultisol soil. *J. Soil Science and Agroclimatology*, 10 (2) 2013. 91-100. September 15, 2017.
https://www.researchgate.net/publication/314780759_The_Effect_of_Maturity_Level_of_Empty_Fruit_Bunch_Compost_and_Mulch_from_Palm_Oil_Waste_to_Tomato_Productivity_in_Ultisol_Soil

FACTORS AFFECTING PRODUCTION OF COCONUT (*Cocos nucifera* Linn) IN GAUNG ANAK SERKA DISTRICT INDRAGIRI HILIR REGENCY, RIAU PROVINCE

Sisca Vaulina¹, Khairizal², Hajry Arief Wahyudy³

^{1,2,3} Department of Agribusiness, Faculty of Agriculture, Universitas Islam Riau
Jl. Kaharuddin Nasution, Marpoan, Pekanbaru 28284
Riau, Indonesia

Email: siscavaulina@agr.uir.ac.id

Abstract

While the rate of population growth in recent, shows that the need/demand will be higher the coconut is caused by the increasing oil consumption and some products from coconut cant substituted by other commodities, such as coconut milk coconut. Increasing growing needs of coconut, then the effort was undertaken to increase the production of coconut in it. As for the purpose of this research is to know the: (1) the income of farming of coconut in Indragiri Hilir regency, (2) the factors that affect the production of coconut in Indragiri Hilir Regency. This study used a survey method. The research was Gaung Anak Serka District (GAS), in four villages namely (1) Rambaian village; (2) Idaman village; (3) Iliran village; (4) Tanjung Harapan village. Each village taken samples as many as 15 people coconut farmers, so that the total sample as many as 60 people coconut farmers. The research was May 2017 until December 2017. The results showed that total fixed cost for per arable IDR 103,921.96 (2.94%) while for variable costs of IDR 3,427,514.77 (97.06%). Gross income received in coconut farmers amounted to IDR 8.608.363,29/harvest and a net income of IDR 5.076.926,56/harvest. The value of the coefficient of determination $R^2 = 0.693$; 69.30% means that the variation of production of coconut in Indragiri Hilir Regency is affected by all the variables (Xi) while the rest 30.70% influenced by variables other than the model. Partially, the variable land and the number of plants produce effect on production while labor, terusi, salt and pesticides have no effect against the production.

Keywords: *Coconut, Production, Income, Factors of Production*

1. INTRODUCTION

Coconut (*Cocos nucifera*) is the most widely planted crop and the palm is the most important. Coconut is an important commercial crop in tropical countries and contributed significantly to the economic

society (Philips, 1994). In Ghana, the coconut is a money plant (Abankwa, et al., 2010). In India, the coconut gives the life of more than 20 million people (Naik, 2016).

Potential plantation commodities in Riau Province consist of palm oil, coconut,

rubber, and sago. Coconut (*Cocos nucifera* Linn) is one of the very important plantation commodities national economy, as well as export commodities and producers of vegetable oils in needs of the community.

Riau Province is the largest producer of coconut in Indonesia. Indragiri Hilir Regency, as the largest producer of coconut in Riau Province and already known by the expanse of coconut an area of land 439,955 ha (85.11% of the total land area of Riau Province) with a total production of 359,372 tons (85.23% of total production of Riau Province) (BPS, 2015).

The suitability agroclimatology in most areas tends to dry in Indragiri Hilir. This is apparent from the spread of Palm plants

almost all districts in the regency. Coconut has been developed by hereditary and generally maintained traditionally, land tenure is limited, and most of the farmers are not using seeds. Traditionally management will have an impact on productivity resulting in coconut farmers. Vaulina and Elfi (2014), productivity resulting coconut in Indragiri Hilir less than one ton per hectare.

Coconut is one of the leading commodities Indragiri Hilir Regency. Almost throughout the Sub-district planted with coconut. Land area, production, productivity and the number of coconut based on sub district can be seen in Table 1.

Table 1. Land area, Production, Productivity and the Number of Farmer Plantations in Indragiri Hilir Regency, 2014

No.	Sub	Land Area (Ha)	Production (Kg)	Productivity (Ton/Ha)	Amount Of Farmers (People)
1	Keritang	26,967	25,868,850	0.959	5,503
2	Kemuning	19	16,996	0.894	24
3	Reteh	24,993	17,628,320	0.705	5,101
4	The River Rods	14,052	7,844,200	0.558	2,868
5	Enok	44,118	30,219,397	0.685	9,004
6	Tanah Merah	10,821	12,968,400	1.198	2,208
7	Kuala Indragiri	25,721	14,566,800	0.566	5,249
8	Concong	14,166	8,607,600	0.608	2,891
9	Tembilahan	9,092	9,606,660	1.057	1,856
10	Tembilahan Hulu	3,645	3,739,200	1.026	744
11	Tempuling	10,159	7,400,200	0.728	2,073
12	Kempas	6,100	5,323,200	0.872	1,245
13	Batang Tuaka	24,391	18,746,910	0.768	4,978
14	Echoes Of Older Serka	15,381	7,656,918	0.498	3,139
15	Mandah	55,216	45,439,200	0.823	11,374
16	Kateman	37,689	28,802,400	0.764	7,692
17	Pelangiran	15,728	15,860,304	1.008	3,210
18	Bay Of Belengkong	3,524	6,055,200	1.718	719
19	Bird Island	10,879	9,771,600	0.898	2,220
20	Echo	28,956	18,647,937	0.644	5,909
The total number of		381,617	566,755,865	1.485	78,007

Source: BPS Kabupaten Indragiri Hilir, 2015

Based on Table 1, as seen from the productivity of the coconut of GAS is the lowest value of productivity in this district namely 0.498 tons/ha. GAS Sub levels of productivity is much lower than average productivity level of Indragiri Hilir Regency (1.485 tons/ha), the number of farmers that there is GAS in district pretty much amounted to 3,139 people.

While the rate of population growth in recent, shows that the need/demand will be higher the coconut is caused by the increasing oil consumption and some products from coconut cant substituted by other commodities, such as coconut milk coconut. The growing needs of coconut, then the effort was undertaken to increase the production of coconut. In this case the author attempts to analyze the factors affecting production of coconut in Indragiri Hilir Regency. As for the purpose of this research is to know the: (1) the income of farming of coconut in Indragiri Hilir Regency, (2) the factors affecting production of coconut in Indragiri Hilir Regency.

2. METHODOLOGY

This study used a survey method. The research was Gaung Anak Serka District (GAS), in four villages namely (1) Rambaian village; (2) Idaman village; (3) Iliran village; (4) Tanjung Harapan village. The location of the research is determined by the consideration that the purposive in the village there is a coconut farmers have low productivity. Each village taken samples as many as 15 people coconut farmers, so that the total sample as many as 60 people in the coconut farmers. The research was in May 2017 until December 2017. In this study, data collection techniques are inuse include: observation, dokumentation, and interviews. The type of data used is secondary data and primary data.

Data Analysis

1. Farming In Plantations

To analyze the plantations in the quantitative approach will be explained. In detail can be outlined as follows:

a. The use of factors production

The use of production factors in this study is number of plants produce, labor, fertilizer and pesticides.

b. The cost

To calculate the total cost of farming used formula:

$$TC = FC + VC \quad (1)$$

Description:

TC = Total costs

FC = fixed costs

VC = variable costs

c. The Income of Farming

Farming income calculated based on gross income and net income. In detail can be seen as follows:

1. Gross Income

To calculate the gross income use the formula Soekartawi (2006):

$$TR = Y \cdot Py \quad (2)$$

Description:

TR = Total acceptance

Y = The production obtained in a coconut

Py = Prices of coconut

2. Net Income

Net income used to calculate the formula Soekartawi (2006):

$$Pd = TR - TC \quad (3)$$

Description:

PD = Coconut farming Income

TR = Total acceptance

TC = Total costs

d. The Efficiency

The efficiency is analyzed using the approach In *Return Cost Ratio* (RCR). Effendi and Oktariza (2006) in Ngamel (2012), explained that the analysis *Cost Revenue Ratio* (R/C ratio) is an analysis tool to view the relative advantage of a business within a year towards the cost of which are used in the activity such. The criteria used in the analysis of R/C ratio is as follows:

- If the value of R/C ratio > 1 feasible and profitable

- If the value of R/C ratio < 1 unfeasible and unprofitable
- If the value of R/C ratio = 1 break even (no profit and no loss).

By the following formula:

$$RCR = \frac{TR}{TC} \quad (4)$$

Description:

RCR = *Return Cost Ratio*

TR = gross income (grains/ha/crop)

TC = Total cost of production (grains/ha/crop)

With the criteria;

RCR > 1 profitable

RCR < 1 disadvantaged

RCR = 1 breakeven

2. The functions of the production of Cobb-Dougllass

The Cobb-Douglas function in this research is used to find out the factors affecting production of coconut. This model was selected based on the consideration that; (1) the Model function of Cobb-Douglas is a common model agricultural economics for its practical and easy to transformed into a linear form (Soekartawi, 2003); (2) according to Gujarati (2001) regression coefficient indicated by the production function Cobb-Douglas is the elasticity factors production and to provide information about the influence of the scale against the result (*return to scale*).

Basically the function is derived from the regression equation generally can be written as follows:

$$Y = f(x) \quad (5)$$

Explanation:

Y = variable that influenced (variable)

x = variable that affects (free variables)

While the function Cobb-Douglas production mathematically can be written as follows:

$$Y_i = \beta_0 \beta_1 \quad (6)$$

Equation (2), the exponential regression model with known with the form of the equation can be written as follows:

$$Y_i = \beta_0 \beta_1 X_1^{\beta_1} X_2^{\beta_2} \quad (7)$$

Explanation:

Y = Output

X₂ = Labor input

X₃ = Capital input

u = Stochastic disturbance term

β₁, β₂, β₃ = Parameters

i = 1, 2, 3

With the conditions, that when t-count greater than t-table, then the corresponding variable or very real tangible effect against Y (output) and when t-count smaller than the t-table, then the corresponding variable not the real effect on Y. Relationship between outputs and inputs that are involved in the production process is not linear, so it is difficult to be analyzed. Therefore it must be linearized such that the first by transforming in the form of the natural logarithm (ln or log) as follows:

$$\ln Y_i = \ln \beta_1 + \beta_2 \ln X_{2i} + \beta_3 \ln X_{3i} + u_i$$

$$\ln \beta = \beta_0 - \beta_2 \ln X_{2i} + \beta_3 \ln X_{3i} + u_i$$

(8)

Explanation: β₀ = lnβ₁

Equation (6) an expression of equation (5) is:

$$\ln Y_i = \ln \beta_1 + \beta_2 \ln X_i + u_i$$

(9)

Equation (9) can also be written in the form of the model:

$$\ln Y_i = \beta + \beta_2 \ln X_i + u_i$$

(10)

Explanation β = lnβ₁.

In order that the functions production Cobb-Douglas can being estimated by OLS method is then converted into the form of the natural logarithm as follows:

$$\ln Y = b + \ln a_1 \ln X_1 + b_2 \ln X_2 + b_{33} + \ln X$$

$$b_4 \ln X_4 + b_5 \ln X_5 + b_6 \ln X_6 + u.$$

(11)

Explanation:

Y = Coconut Production

X₁ = Land area (Ha)

X₂ = Labor (HOK)

X_3 = Number of Plants Produce (Trunk)

X_4 = Terusi (Kg)

X_5 = Salt (Kg)

X_6 = Pesticides (Litres)

Assuming that, $E(ui) = 0$, then $ei = Y$
(alleged)-Y (penduga)

Testing the hypothesis partially (t-test)

Partial testing using the test of t which is the test of significant influence the dependent variable against the independent variables individually. Significance test is a procedure in which a sample is used to determine the results of the decision to accept or reject H_0 based on values obtained from the statistical test data. The procedure of the test t is as follows (Widarjono, 2007):

1. Make the zero hypothesis (H_0) and an alternative hypothesis (H_a)
2. Calculate the t with the formula:

$$t_{hit} = \frac{b_1 - b}{sb} \quad (12)$$

Explanation:

b_i = Coefficient i

b = Value of the zero hypothesis

S_b = Standard deviation of free variables to- i

3. Find the critical t value from table t with $df = n-k$ and α that the particular
4. The decision to accept or reject H_0 is based on comparison of t-count and t-table (critical values).

If: t-count > t-table, H_0 denied and H_i received

t-count < t-table, H_0 accepted and H_i rejected

Simultaneous Hypothesis testing (test F)

Simultaneous testing using F Test. F test aims to test the influence of all the variables are independent of the dependent variables simultaneously. Test procedure the test is as follows:

1. Make the zero hypothesis (H_0) and an alternative hypothesis (H_a)
2. Calculate the value of f. calculate with the formula:

$$F = \frac{R^2/(k-1)}{(1-R^2)/(n-k)} \quad (13)$$

Explanation:

R^2 = coefficient of determination

k = the number of independent variables

n = number of samples

3. Find the critical value (Table F); DF ($k-1, n-k$).

Explanation: k = number of parameters including intercept.

4. The decision to accept or reject H_0 is based on comparison F-count and F-table.

If: F-count > F-table, then H_0 denied and H_i received

F-count < F-table, then H_0 accepted and H_i rejected.

The Coefficient Of Determination (R^2)

According to Gujarati (1995) the coefficient of determination is to find out how large a percentage of the donation free variables against a variable can be expressed in percentage. The influence of the percentage of all variables are independent of the dependent variable values can be known of the coefficient determination (R^2) regression equation. The coefficients of determination ranged from zero to one. Getting close to zero the magnitude of the coefficients of the regression equation is a determination, then the smaller the influence of all the variables are independent of the dependent variable. On the contrary, getting closer to one of magnitude determination coefficients of regression equations, then the greater the influence all variables are independent of the dependent variable (Algifari, 2000).

3. RESULT AND DISCUSSION

Coconut plantations are the most widely cultivated and grown by the local people (plantation). This is due to most of the land-the land planted with coconut already existed orally. Coconut is grown in gardens

addition belong to farmers also planted in the grounds-the grounds around their homes.

The Use of Factors Production

The use of production factors coconut farming starting from the widespread use of the land, seed, fertilizer, pesticides and labor.

1. Land area

One of the factors that affect the level of production is land area. Widespread use of the land to the farmers sampled quite a variety, between 1.10 ha to 14.60 ha and an average land area farmers 2.19 ha. The status of the land that used a proprietary part and part rent.

2. Seedling

The entire sample farmers have yet to use the quality seeds. Coconut seedlings are used are seedlings old and fall from the tree, and then allowed to grow into seedlings.

3. Fertilizers

The fertilizer used by farmers is terusi and salt. Fertilizer use each different farmers, generally pruning is done twice a year or as needed. When the coconut fruit bunches at a little more than the previous harvest, then give farmers fertilizer.

4. Pesticides

Farmer used pesticides are Gramoxone and Round-up. The awarding of the pesticides is conducted twice a year.

5. Labor

On coconut farming in Indragiri Hilir Regency is largely done by labor in the family, but there are farmers labor from outside the family. Usually the outside labor families do it because the owner of the garden is located outside the village.

3.1. Farming Plantations Coconut

Coconut harvesting using the hook. Hook a coconut is a tool like a scythe which is connected with a long bamboo. Coconut harvest period in a year picking is done at least 4 times (every three months) or a maximum of 6 times (every 2 months). The criteria of the fruit is ready to harvest are as follows: (1) generally ready cooked the harvest age 11-13 months; (2) served fruit skin (generally) or green; (3) indeed rocked by a loud bleeping water.

Farming In plantations in the study discussed about the cost, the gross income, net income, and RCR. In more detail can be seen as follows:

Cost

The costs consist of fixed costs and variable costs. Total fixed cost for per arable IDR 103,921.96 (2.94%) while for variable costs of IDR 3,427,514.77 (97.06%). For more details can be seen in Table 2.

Table 2. The Cost of Farming Plantations in Indragiri Hilir Regency, 2017

No.	Description	Cost Of Arable		The Cost Per Hectare	
		Cost (IDR)	(%)	Cost (IDR)	(%)
1	Fixed Costs (<i>Fixed Cost</i>)				
	- Depreciation of equipment	103,921.96	2.94	47,452.95	2.94
2	Variable Costs (<i>Variable Cost</i>)				
	- Seeds	1,178,057.14	33.36	537,925.64	33.36
	- Terusi	197,396.23	5.59	90,135.26	5.59
	- Salt	210,128.21	5.95	95,948.95	5.95
	- Pesticides	411,363.64	11.65	187,837.28	11.65
	- Labor	1,430,569.56	40.51	653,228.11	40.51
	The total number of	3,427,514.77	97.06	1,565,075.24	97.06
	The Total Cost Of	3,531,436.73	100.00	1,612,528.19	100.00

Based on Table 2, on farming, the greatest cost incurred are costs variable with the percentage 97.06%. Views of variable costs, the cost of labor is a cost incurred (40.51%). The magnitude of the labor costs incurred for the cleaning of the gardens/weeding, fertilizing, harvesting and hauling. Wage labor in the place of research, IDR 75.000/HKP and IDR 65,000/HKW.

Income

Coconut production, which provided the object in this research are the form of coconut. Based on the results, the median land area-averaged coconut farmers was 2.19 ha and the number of trees with tree 162-average production per production 2,847 Kg/harvest and flat-flat Palm trees cultivated in location of research already fruitful (productive).

Based on Table 3, gross income received Coconut farmers amounted to IDR 8.608.363,29/harvest and a net income of IDR 5.076.926,56/harvest or IDR 1.692.308,85/month. Vaulina and Saipul (2015), Coconut farmers income In Indragiri Hilir district belongs to low. Supadi and Nurmanaf (2006), low of earnings obtained from coconut farmers because have no capital to maintain an intensive garden, let alone manage the plantation as well as optimally cultivate result. Though so, Vaulina (2012), the

existence of coconut in the sector is still the base and provide the multiplier effect has the power to push the economic growth regions in Indragiri Hilir. Dongoran (2013), farming coconut has a very good economic opportunities to be developed in an attempt to increase people's economy.

Return Cost Ratio (RCR)

Based on Table 3, ratio between gross income and costs of farming production of coconut in 2.45. This means that if the IDR 1, the allocation of production costs will then be retrieved gross revenue of 2.45 or equivalent net income of 1.45 so coconut farming viable and profitable to develop.

3.2. The Factors Affecting the Coconut Production

The results of the analysis show that simultaneously all independent variables (Xi) influential real (highly significant) of the dependent variable. This is shown by the comparison between F-account (20.678) and F-table (2.045). The value of the coefficient of determination $R^2 = 0.693$; 69.30% means that the variation of production of coconut in Indragiri Hilir Regency is affected by all the variables (Xi) while the rest 30.70% influenced by variables other than the model.

a. Land (X₁)

Based on the results of the regression coefficient values research land area against the amount of coconut in the production of 0.588. Means that any addition of 1 per cent of arable land area will be followed by a rise in the number of production of 0.588 percent. The value t Sig for the use of land is 0.002. This indicates that the land area effect on total production. The more land area owned by the farmers, the more amount of the plant the coconut.

b. Labor (X₂)

The amount of use of labor on farmers have coconut in the value of the regression coefficient of 0.109 This means that the use of the workforce do not affect total production. The value t Sig for the use of labor by farmers is 0.109.

c. The Number Of Plants Produce (X₃)

The value of the coefficient of regression of the number of plants produce on coconut farming in of 0.442, This means that the number of plants produce influential positive against total production, where each crop improvement coconut by 1 percent, would increase the total production of 0.442 percent. The value t Sig for the use of the number of plants produce by farmers is 0.002, This means seed effect is very significant to the total production. Based on the observations in field of coconut farmers commonly plant coconuts are 74 stems per hectare. When referring to the recommendations issued by the Ministry Peron (2010), that needs the number of recommended plants totaled 106 up to 176 rods per acre. It is similar with research Lamusa (2005), number of plants producing influential real against the production of coconut.

d. Terusi (X₄)

The variable X₄ for terusi has the value regression of 0.512 this means that terusi does not affect total production. Terusi does

not affect total production due to use of continuous not done or seen from the needs of the coconut.

e. Salt (X₅)

The variable X₅ for salt has the value regression of 0.139 this means that the salt does not affect total production. Same is the case with terusi, salt also does not affect total production due to use of continuous not done or seen from the needs of the coconut.

f. Pesticides (X₆)

The variable X₆ for pesticides has the value regression of 0.876 this means that pesticides have no effect against total production.

4. CONCLUSION

1. Total fixed cost for per arable IDR 103,921.96 (2.94%) while for variable costs of IDR 3,427,514.77 (97.06%). Gross income received coconut farmers amounted to IDR 8.608.363, 29/harvest and a net income of IDR 5.076.926,56/harvest.
2. The value of the coefficient of determination R² = 0.693; 69.30% means that the variation of production of coconut in Indragiri Hilir Regency is affected by all the variables (X_i) while the rest 30.70% influenced by variables other than the model. Partially, the variable land and the number of plants produce effect on production while labor, terusi, salt and pesticides have no effect against the production.

REFERENCES

Abankwah, V., R. Aidoo and B. Tweneboah-Koduah. 2010. Margins and Economic Viability of Fresh Coconut Marketing in the Kumasi Metropolis of Ghana. The Journal of

- Development and Agricultural Economics, 2 (12); 432-440.
- Algifari. 2000. Regression Analysis, Second Edition. BPFE, Yogyakarta.
- Central Bureau Of Statistics. Indragiri Hilir 2015 in numbers. Indragiri Hilir. Tembilahan
- Dongoran, F. R. 2013. Analysis of Advantages of coconut Farmer in district Padangsidempuan Batunadua. Tabularasa PPS Unimed journal, 10 (2); 151-164.
- Gujarati. 2001. Basic Econometrics. Erlangga, Jakarta.
- Gujarati. 1995. The Basic Econometrics. Erlangga, Jakarta.
- Lamusa, a. 2005. Factors Affecting Production of Coconut in the Village of Labuan Lele Sub Tawaeli Donggala. J. Agroland, 12 (3): 254-260.
- Ministry Of Agriculture Of The Republic Of Indonesia. 2014. The Standard Coconut. <http://www.djpp.kemenumham.go.id>. Accessed February 22, 2016.
- Naik, P. 2016. Economic Analysis of Coconut and Arecanut Production System: A Review. International Journal of Development Research: 06 (08); 9175-9179.
- Ngamel, A. K. 2012. Financial Analysis of Cultivation of Seaweed and Value-added Karaginan Flour In Kei Kecil Subdistrict, Southeast Maluku District. Journal of applied science, 2 (1): 68 – 83
- Philips, L.R. 1994. Importance of coconut. The coconut facts sheet HS-40, April 1994. <http://www.Plantapalm.com/Vpe/misc/the-coconut.pdf>
- Soekartawi. 2006. The Analysis of Farming. UI Press, Jakarta.
- Soekartawi. 2003. Economic Theory Production with the Subject of the Analysis Function Cobb-Douglas. PT. Kingdom Grafido Persada, Jakarta.
- Supadi and AR Nurmanaf., 2006. Coconut Farmers Empowerment In An Effort To Increase Revenue. Journal Of Agricultural R & D. 26 Things.
- Vaulina, S. and Bahri, S. 2015. The Production and Income of Farmers in the Coconut (*Cocos Nucifera* Linn) of Indragiri Hilir Regency Riau Province. Proceedings of the National Seminar on the crystallization of the Paradigm of Sustainability in Economic Development and Higher Education. IPB-International Convention Center Of Bogor. 183-198.
- Vaulina, S. and Rahmi, E. 2014. Analysis of Productivity and Value Added in the Coconut (*Cocos Nucifera* Linn) of Indragiri Hilir Regency Riau Province. Proceedings of the National Seminar and Workshop on Agricultural College Communications Forum Indonesia (PKPTI) "Evokes Patriotism Farms". Andalas University Field. 297-307.
- Vaulina, S. 2012. Contribution of Plantation to Economy Region in Indragiri Hilir Regency, Riau Province. Journal Of Agribusiness. 5 (2): 9-22.
- Widarjono, A. 2007. Econometrics: Theory and Applications to Business and Economics 2nd Edition. Ekonisia Faculty Of Economics UII, Yogyakarta.

UTILIZATION OF PALM OIL WASTE WITH POLYPROPYLENE MATRIKS (PP) RECYCLING ON PARTICLE BOARD COMPOSITE

Dody Yulianto¹, Dedikarni², Kurnia Hastuti³, Juraiz Saputra⁴

^{1,2,3,4}Department of Mechanical Engineering, Faculty of Engineering, Universitas Islam Riau
Jl. Kaharuddin Nasution, Marpoyan, Pekanbaru 28284
Riau, Indonesia

Email : dody_yulianto@eng.uir.ac.id

Abstract

Oil palm plants that have reached the age of no longer productive at the age of approximately 25 years should be done rejuvenation (replanting). The plant will become a waste that can be utilized optimally as a particle board so it is not wasted in vain. Research conducted on particle board composites reinforced with fiber-shaped palm rods and particles arranged with a polypropylene (PP) matrix of waste plastic bottles. The research stages were started from the selection of fibers, particle size, mixing and addition of Adiptif Maleic Anhydride (MAH) ingredients by 5% by weight of matrix and Benzoyl Peroxide (BPO) by 15% of MAH weight and particle formation, up to the testing stage. Composite particle board is made by hot press method. The composite particle board consisting of fibers / particles with polypropylene matrix (PP) measured its composite mechanical properties against bending strength with variation of volume fraction of oil palm rod - polypropylene (PP) by 60% : 50%, 50% : 50%, and 40% : 60%. The specimens and bending testing procedures refer to the ASTM D 790-03 standard. Testing of mechanical properties tends to increase with increasing adhesive (matrix) levels. The highest bending strength on particle board composites with a 40% : 60 composition of 13.01 N / mm² is higher than that of composite particle board with a composition of 60% : 40%, 50% : 50% of 11.17 N / mm². This research has obtained the right composition on the manufacture of particleboard that meets the SNI 03-2105-1996 quality standard. The results of this research is one of the solutions in the utilization of waste oil palm and recycled plastics so as to have a favorable economic value for the community around the palm plantation.

Keywords: Particle Board, Palm Oil Rod, Polypropylene.

1. INTRODUCTION

1.1 Background

Increasing population growth makes human need for wood as construction of

building or furniture continue to increase while wood willingness as raw material continue to decrease. According to the directorate general of forestry production

development (Bakar 2003) that the last 5 years of timber production in the period of 2001 - 2005 ranged from 11 - 21 million m³ / year except in 2005 the production of logs reached 24 million m³. This indicates that the demand for timber is increasing every year.

With the depletion of wood availability, then one effort that can be developed is the manufacture of composite board. Namely the manufacture of composites by using recycled plastics. The manufacture of composites with recycled plastics can have a good impact because in addition to improving the efficiency of timber utilization, it can also reduce the loading of plastic waste. The advantages of this product include cheaper production costs, raw materials abundant, flexible in the process of making and have better properties.

Simultaneously, the potential for palm oil is increasing at this time, with the growing extent of oil palm plantations in Indonesia. The high waste generated at this time because the utilization of oil palm is limited to the utilization of fruit, fiber, bunches and palm stem. While on the stem is generally burned or let it accumulate into waste that can cause various impacts and environmental disturbances.

The palm oil rods consist of two main components, namely vascular bundles and parenchyma tissue. The result of chemical analysis showed that the level of palm oil starch was high (Bakar, 2003). This starch can inhibit the gluing process on the particle board manufacture. One way to reduce this starch is by soaking the particles before the particles are processed further. According to Hadi (1991) and Afandy (2007) the cold soaking and heat immersion treatment of the particles causes a decrease in particulate matter, so that the contaminants present on the cell wall can be removed.

Meanwhile, the high plastic waste in each year continues to increase and will cause problems in handling the

environment. Martaningtyas (2006) describes the plastic needs of the Indonesian community in 2002 around 1.9 million tons and then increased to 2.1 million tons in 2003, while plastic demand in 2004 was estimated at 2.3 million tons. This means that tens of tons of plastic have been produced and used by the community. Plastics have become an increasing number of life necessities that will impact the increase of environmental waste every year.

Polymers in general can increase the mechanical strength of composites. According to Jiang and Li 2017, the recorded statistics on particle board have identified the strength value of the optimum internal bond of 0.83 MPa representing the overall mechanical improvement of the particle board.

Polypropylene (PP), is one of the more rigid polymeric materials, has better tensile strength and clarity than Polyethylene and also low water vapor permeability and high Polypropylene melting point is 1700C. This material is widely used to make tools for everyday purposes, one of them on a glass of mineral water. Polypropylene is a recyclable plastic type that has the potential as a matrix in the manufacture of particle board composites because it is lightweight easily formed, resistant to chemicals.

Research conducted (Maryam Jamilah Lubis, et al 2009) on the use of waste oil palm stem and recycled plastic Polyethylene (PE) as plastic composite board stated that the addition of MAH and DCP additives on the composite board resulted in improved physical and board quality on the ratio of 70: 30 particles and plastic compositions. These results have met the JIS A 5908 (2003) standard but only on testing their physical properties while in mechanical tests have not met the standard.

So here the author wants to do the development of previous research that is expected to increase the value of mechanical strength. The difference of this study with the research conducted (Maryam

Jamilah Lubis, et al 2009) is to replace the matrix Polyethylene (PE) with a type of Polypropylene (PP) recycled plastic that has a tensile strength and clarity is better. Based on the above background, the authors want to conduct research with the title "Analysis of Bending Strength and Impact on Oil Palm Waste Trunk With Polypropylene Matrix (PP) Recycled On Particle Board Composite (particle board)".

2. METHODOLOGY

In this research and testing required some equipment and materials for workmanship as follows:

The equipment used in this study is as follows:

1. Test tool:

The bending test aims to determine the combination of the quality of a material due to tensile, tap and shear loads.

2. Hot press printing tool aims as a hot press tool to print the particle board into a sheet.

3. Measuring tools: digital scales are used to measure the weight of each composition.
4. Screen 16 mesh: 16 mesh screen is used to filter the fiber of oil palm rod so that get particle granules.
5. Fan: the fan is used to assist or accelerate the cooling when finished in the heat.
6. Other Helping Tools: gloves, screwdrivers, chisels, aluminum foil, scissors, knives etc.

The materials used in this study are as follows:

1. Fibers of oil palm stalks that have been done several stages of treatment so that it can be taken fiber to be a test sample Impact and Bending. In this test there are 2 samples that is rough fiber fiber and fiber bar (Particle), can be seen in figure 2.1.



Figure 2.2 Fibers of oil palm stems



Figure 2.2 Particles of oil palm rods

2. Recycled plastic, the type of bioplastic used is glass plastic mineral water pack as powder binder particles of palm fiber rod fibers are polypropylene (PP) type.



Figure 2.3 Polypropylene Plastics

3. Maleic Anhydride (MAH), As an additive on particle board useful as compatibilizer, mesenyawakan fiber material with adhesive (matrix).



Figure 2.4 Maleic Anhydride (MAH)

4. Benzoyl Peroxide (BPO), As an initiator of polymerization on the manufacture of styrene polymers and other resins, and plays an important role in the maleolation reaction between the PP chain and MAH.



Figure 2.5 Benzoyl Peroxide (BPO)

Volume Fraction Determination

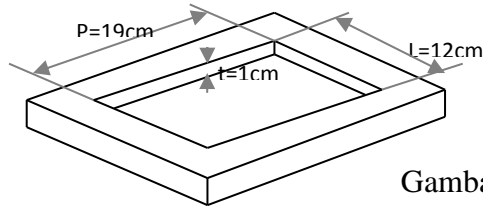

Gambar 2.6 Cetakan

Based on the size of the mold above the printed volume can be calculated as follows:

$$V = \text{Length} \times \text{Width} \times \text{Height} (\text{cm}^3) = 190 \text{ mm} \times 120 \text{ mm} \times 10 \text{ mm} = 228000 \text{ mm}^3 = 228 \text{ cm}^3$$

Table 2.1 composition of fiber and matrix raw materials

Fiber Trunk	Fiber levels (%)	Plastic levels(%)
Fiber	60	40
	50	50
	40	60
Particle	60	40
	50	50
	40	60

To calculate the weight percentage of palm fiber rod and the weight of the matrix that needs to be known is the volume of the mold. Printing equipment used in the manufacture of test specimens using printing presses located on a hot press machine whose size has been specified is $V = 228 \text{ cm}^3$, polypropylene $\rho = 0.887 \text{ gr / cm}^3$ matrix mass, and also the mass of palm fiber rod $\rho = 0.601 \text{ gr / cm}^3$.

From the above results we can calculate the weight of fiber without plastic:

$$\begin{aligned} \text{Mass} &= V \text{ mold} \times \rho_{\text{fiber}} \\ &= 228 \text{ cm}^3 \times 0.601 \text{ gr / cm}^3 \\ &= 137,028 \text{ gr} \end{aligned}$$

Weightless plastic plastics:

$$\begin{aligned} \text{Mass} &= V \text{ mold} \times \rho_{\text{plastic}} \\ &= 228 \text{ cm}^3 \times 0.887 \text{ gr / cm}^3 \\ &= 202.236 \text{ gr} \end{aligned}$$

So to get the desired variations need to be calculated as follows:

□ Specimen 1.

To obtain a specimen with a composition of 60% fiber and 40% plastic then:

Weight fiber 60% and 40% plastic, then:

$$\begin{aligned} \text{Fiber} &= 60\% \times 137,028 \text{ gr} \\ &= 82.22 \text{ gr} \\ \text{Plastic} &= 40\% \times 202,236 \text{ gr} \\ &= 80.90 \text{ gr} \end{aligned}$$

□ Specimen 2.

To get the specimen with the composition of 50% fiber and 50% plastic then:

50% fiber weight and 50% plastic, then:

$$\begin{aligned} \text{Fiber} &= 50\% \times 137,028 \text{ gr} \\ &= 68.51 \text{ gr} \\ \text{Plastic} &= 50\% \times 202,236 \text{ gr} \\ &= 101.12 \text{ gr} \end{aligned}$$

□ Specimen 3.

To get specimen with 40% fiber and 60% plastic composition then:

40% fiber weight and 60% plastic, then:

$$\begin{aligned} \text{Fiber} &= 40\% \times 137,028 \text{ gr} \\ &= 54.81 \text{ gr} \\ \text{Plastic} &= 60\% \times 202,236 \text{ gr} \\ &= 121.34 \text{ gr} \end{aligned}$$

Composition of MAH and BPO (additive)

The addition of additives is essential in making good quality composite boards,

adding additives of 5% by weight of Polypropylene to MAH, and to ODS by 15% by weight of maleic anhydride (MAH).

Then to get the desired composition can be calculated in the following way.

□ Use of Maleic Anhydrid (MAH) as much as 5% of plastic weight, then.

Plastic 40% = 80.90 gr x 5% = 4,045 gr
 Plastic 50% = 101.12 gr x 5% = 5,056 gr

gr
 Plastic 60% = 121,34 gr x 5% = 6,067 gr

□ Use of Benzoyl Peroxide (BPO) as much as 15% of MAH weight, hence

$$\text{MAH} = 4,045 \text{ gr} \times 15\% = 0,607 \text{ gr}$$

$$\text{MAH} = 5,056 \text{ gr} \times 15\% = 0,758 \text{ gr}$$

$$\text{MAH} = 6,067 \text{ gr} \times 15\% = 0,910 \text{ gr}$$

	Area (mm ²)	Yield Strength (N/mm ²)	Bending Strength (N/mm ²)
particle 60%	420.900	0.27	3.87
particle 50%	406.413	0.47	9.89
Particle 40%	380.117	0.50	11.17

Preparation of test samples



Figure 2.6 Sample impact test

specimen	Area (mm ²)	Yield Strength (N/mm ²)	Bending Strength (N/mm ²)
Fiber 60%	400.050	0.40	7.31
Fiber 50%	363.330	0.55	10.34
Fiber 40%	338.000	0.50	13.01

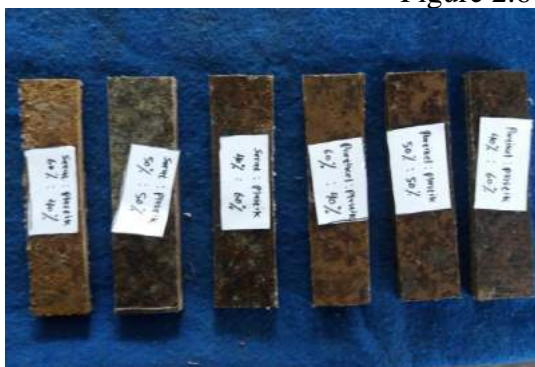

Figure 2.6 Bending test sample

Testing
Test Bending

Bending test standard used ASTM (America society of tenchical and Matherial) D-790-03 (Standard Test Method for Flexural Properties of Unreinforced and Reinforced Plastics and Electrical Insulating materials).

The method of bending test is done by Three Points of Bending method with the distance of 10 times thickness of specimen.

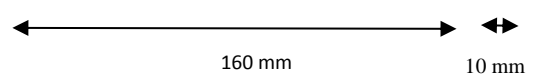

Figure of Bending test specimen size

3. TESTING AND PROCESSING DATA



Figure 3.1 specimens of fibers and particles after bending test

4. ANALYST AND DISCUSSION

Figure 4.1 Test Bending

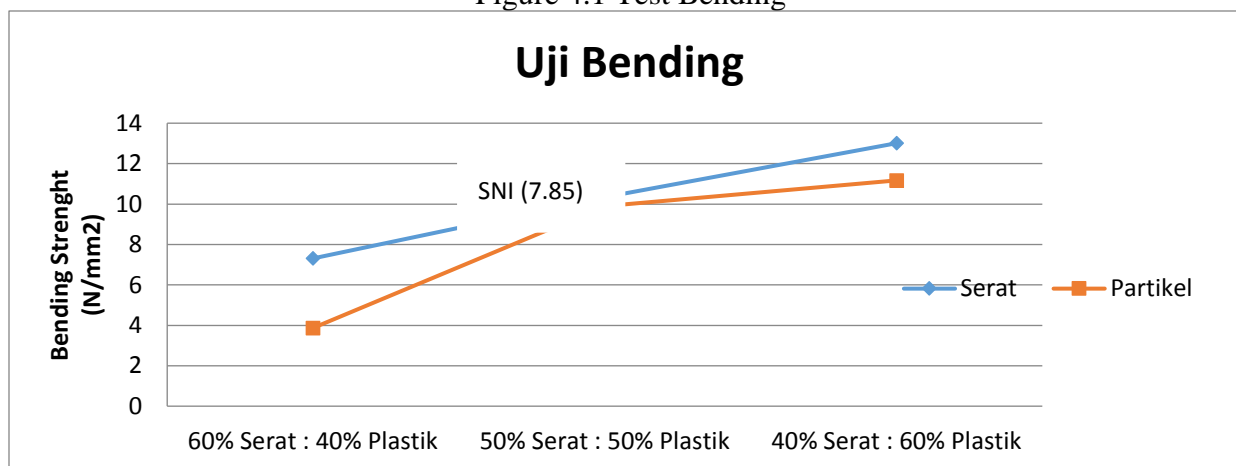

The graph above shows that the optimum particle bending strength of the particle board composite of palm fiber fibers is found in the fiber fraction: 40%: 60% matrix with Bending Strength 13.01, while the optimum value of the particle board composite of the oil palm stalk particles is in the fiber fraction : 40% matrix: 60% with Bending Strength value 11.17. From the graph above we can conclude that in Bending test of particle

board composite between fiber and particle material when viewed from the highest value bending strength particle board of palm fiber fiber is clearly stronger than particle board made from particle.

In boards made of fibers and particles we can see on the graph with increasing adhesive (matrix) then the strength of bending produced will be better this is because with the addition of adhesive (matrix) also means reducing the amount of fiber used, thus

reducing the area and volume of fiber that can covered adhesive (matrix). The denser and wider the area of contact between the fibers makes the use of adhesive (matrix) to be more effective which will produce a better bending strength of the board therefore with the increase of the matrix will result in improved bending of the particle board.

In the above diagram it can be seen also that on fibers starting from the composition of 50%: 50% already meets the SNI 03-2015-1996 standards, as well as on composition particles starting from 50%: 50% already meet the SNI standard. The bending strength value of SNI 7.85 N / mm² while the bending strength value on the particles of oil palm stems starting from the composition of 50%: 50% is (10.34 N / mm²) on the fiber and (9.89 N / mm²) on the particles.

4. CONCLUSION

1. 1.The bending test of particle board made of fiber material is stronger than particle board made of particle material with the highest bending strength value in fiber 13.01 N / mm² whereas on particle material 11.17 N / mm² lies in the same composition that is 40% fiber: 60% matrix.
2. 2. Addition of MAH and BPO additives on this particle board resulted in improved board quality with MAH composition of 5% by weight of plastic and BPO 15% of MAH weight.
3. On the strength of Bending particle board from palm oil stem waste both made of fiber and particles have fulfilled the requirements of SNI 03-2105-1996 standard, starting from the composition of 50% fiber: 50% matrix

REFERENCES

- Annual book of ASTM standar,1987 American society for testing material, piladelpia. Pa.*
- Bakar, E. S. 2003. Kayu Sawit Sebagai Substitusi Kayu Dari Hutan Alam. Forum Komunikasi dan Teknologi dan Industri Kayu 2 : 5-6. Bogor.
- Berglund, L, and R.M rowell, 2005 *wood composite*.
- Bondan T. Sofyan, 2010 “*Pengantar Material teknik*”, cetakan ke sepuluh, Yogyakarta.
- Billmeyer, 1984, Fried, W, *tektbook of polymer science*, Jhon wily and sons, new York.
- Cowd, MA, 1991 Terjemahan hery irawan, kimia polimer, Bandung.
- Fessenden, 1995 kimia organik, cetakan ketiga, jilid II, penerbit airlangga, Jakarta.
- http://id.wikipedia.org/wiki/Serat#Serat_ala_m
- <http://id.wikipedia.org/plastik>
- Jun Jiang, Xiaoning Lu. 2017. *Effect of blocked polyurethane prepolymer on properties of MUF-particleboard made from high moisture particles. International Journal of Adhesion and Adhesives. 78, Pages 189-194*
- Maryam Jamilah Lubis, 2009 Kualitas papan komposit dari limbah batang kelapa sawit (*elais guineensis jacq*) dan polyethylene (PE) daur ulang. *Jurnal komunikasi penelitian Universitas Sumatra Utara, Medan.*
- Karnani R.,krishan M., and Naraya R 1997 *Biofiber-reinforces polipropilena composit.*
- Robert L. Mott P, E, 2009 “*Elemen –Elemen Mesin dalam perancangan Mekanis*”penerjemah I Gusti Ketut Puja S.T M.T, Yogyakarta.

Robert L. Moot, P, E, 2009 “*Elemen Mesin Terpadu*”, penerjemah Ir. Rines MT, Yogyakarta.

Smallman, R.E. Bishop R.J; penterjemah Sriati Djaprie.1996 *Metalurgi fisik modern dan rekayasa material*, Jakarta: Erlangga

Standar Nasional Indonesia, *Mutu Papan Partikel*. SNI 07-2105-1996. Dewan Standar Nasional. Jakarta, 1996.

Triyono dan Diharjo, 2000. *Material teknik, buku pegangan kuliah*,

Van Vlack, L, H, 1985 “*Ilmu dan teknologi bahan*”Edisi kelima, Erlangga, Jakarta

PROFILE OF HABITS OF MIND STUDENT OF BIOLOGY EDUCATION PROGRAM ISLAMIC UNIVERSITY of RIAU

Tengku Idris^{1,a)}, Nurkhairo Hidayati^{2,b}

^{1,2} *Department of Biologi Education, Faculty of Education, Universitas Islam Riau
Jl. Kaharuddin Nasution, Marpoyan, Pekanbaru 28284
Riau, Indonesia*

Email : a) idrisbio@edu.uir.ac.id b) khairobio@edu.uir.ac.id

Abstract

Habits of mind are an intelligent behavior associated with actions to be taken when encountering problems and determining the most appropriate solution of the problem. Habits of mind have three aspects: self-regulation, critical thinking and creative thinking. Habits of mind become fundamental for students because when they attend classes and at work, students can find various problems that must be solved. Information about the habits of mind of students in Biology Education Program of Islamic University of Riau so far has never been known. Based on this, this study aims to find out the habits of mind profile of the student. The study was conducted in odd semester 2017/2018 with the number of participants as much as 263 students from 5th and 3rd semester. Obtaining habits of mind data using a questionnaire consisting of 3 aspects of self-regulation, critical thinking and creative thinking with the number of 60 item statements. Data analysis is done by counting percentages then interpreted into several categories. Based on the research, it can be concluded that the habit of thinking (habits of mind) of Biology Education Program students in the category is enough with the percentage of 69.85% with the highest percentage in self-regulation category followed by creative thinking and the lowest critical thinking category. While based on student habits of 2015 (semester 5) is better than the habits of the class of 2016 (semester 3) in all categories HoM. In addition, all students have received feedback with an average of 5 times / subject from lecturers and lecturers provide rules using 5 - 10 references in completing the course task.

Keywords: *Habits of mind, students, biological education program*

1. INTRODUCTION

Development of a nation is in need of human resources who have intelligence in thinking and acting, so as to be able to take the right decision. With the intelligence of thinking and acting, each individual is expected to be able to overcome various complex life problems in all aspects of his life. To achieve this, the learning process is not enough just a memorization. The process of learning is done in the form of analyzing and synthesizing the true meaning of knowledge. When students do not have a deep understanding of the knowledge learned, it can reduce their ability to think and solve complex problems (Rodzalan & Saat, 2015), preparing them with existing facts and solving problems (Cuoco et al, 1996).

Every individual in his life will definitely deal with the problem, both in the school, family and society. Sometimes small problems become big because of errors in addressing a problem. The problem occurs when a person does not know how to respond to a problem. The initial stage in the problem-solving process is thinking about the consequences of the problem being solved (Noreen et al., 2015). This means to solve the problem required intelligent behavior. Intelligent here not only deals with one's knowledge of information relating to the problem but also relates to how to act to solve the problem. This intelligent behavioral ability is called the habits of mind (Costa & Kalick, 2000a).

Some people have developed habits of mind through various studies. Among them are Costa and Kallick (2000b) and Carter et al., (2005) that divide the habits of mind into 16 indicators. Even Costa and Kallick claim the habits of mind as the most characteristic behavior of intelligent thinking to solve

problems and is an indicator of success in academic, occupational and social relationships. Habits of mind can be influenced by the learning process experienced by students. One of the factors affecting habits of mind is the provision of feedback. The result of Hidayati & Idris (2017) study found that the feedback in the portfolio assessment affected the habits of mind. Feedback can not only assists students in correcting errors but also play a role in sustaining their knowledge with low confidence (Finn et al., 2017).

Looking closely at previous Costa and Kallick statements, the habits of mind in the students really become the foundation of students in the course of a lesson. Students need to have good thinking habits to be able to respond to any problems that arise in learning. Student thinking habits at the time of learning become fundamental when they get a little problem and they must find the solution. Habit is a behavior that we show well in times of which appropriate and the behavior is done without consideration because the habit is a continuous repetition (Burgess, 2012).

Habits of mind is formed when responding to answers or questions or problems that the answer is not immediately known, so we can observe not only how students remember a knowledge but rather how students produce a knowledge (Costa & Callick, 2000a). Habits of mind is divided into three categories: self regulation, critical thinking and creative thinking (Marzano, 1993). Science For All Americans in Volkmann & Eichinger (2010) writes integrity, perseverance, justice, curiosity, openness to new ideas, skepticism and imagination as habits of mind that show humanity values in everyday life

Habits of mind is also very supportive of student performance in everyday life. Habits of mind is a mixture of many skills, attitudes, and experiences of the past. This means that there is a link between one pattern of thinking over another. Therefore, it implies that habits of mind should be used when making choices. This choice includes sensitivity to contextual cues to situations to determine the right pattern of decision making (Teachtaught, 2012)

Someone who is intelligent in thinking will be able and ready to face all the changing times. In college students, the lecture is a period in which an individual experiences a transition from adolescence to adulthood, including psychological development. The student has a duty to learn, but he must also start thinking about how his survival will be. According to ASCD (2009), a good starting point when introducing habits of mind by developing an in-depth understanding and appreciation of their own habits.

Given the urgency of habits of mind in determining the life of a person, it is necessary to know the habits of mind profile of students as stock in undergoing various problems in life. Information about the habit of minds of the students of Biology Education Program of the Islamic University of Riau so far is unknown

because no research has examined it. Based on this background, this study aims to find out the habits of mind profile of the students of Biology Education Program of the Islamic University of Riau

2. METHODOLOGY

The research was conducted on Biology Education Study Program of Islamic University of Riau and the data was taken in the odd semester of FY 2017/2018. The population in this study is all students of Biology Education Program of Islamic University of Riau. Sample selection was done by purposive sampling. In this sampling technique, the population is divided into several groups based on the force and GPA. The study was conducted in odd semester 2017/2018 with the number of participants as much as 263 students from 5th and 3rd semester.

The instrument used to obtain student habits of mind data is a questionnaire of habits of mind by Marzano (1993) which has been developed by Sriyati (2011). This questionnaire contains three aspects of habits of mind: self regulation, critical thinking and creative thinking. Clearly, the habits of mind questionnaire grid can be seen in Table 1.

Table 1. Habits of Mind Questionnaire Grille

Aspect	No	Indicator
<i>Self Regulation</i>	1	Realizing his own thoughts
	2	Make plans effectively
	3	Be aware and use the necessary information resources
	4	Sensitive to feedback
	5	Evaluate the effectiveness of the action
<i>Critical Thinking</i>	1	Accurate and look for accuracy
	2	Clear and looking for clarity
	3	Open
	4	Refrain from impulsive nature
	5	Being able to position yourself when there is a guarantee
	6	Sensitive and know the ability of knowledge of his friend

Aspect	No	Indicator
Creative Thinking	1	Can be involved in the task although the answer and the solution is not immediately apparent
	2	Make efforts to maximize the ability and knowledge
	3	Produce a new way of looking at a situation different from the usual way of prevailing in general

Data on student's habits of mind that have been collected through the next questionnaire are analyzed. For each item the statement on the questionnaire consists of four score options. Data analysis is done by calculating the percentage based on scores that have been selected by students for all items then interpretation into several categories. Very good category (86-100%), good category

(76-85%), enough category (60-75%), less category (55-59%) and less category once ($\leq 54\%$) (Purwanto, 2008).

3. RESULT AND DISCUSSION

Based on the research that has been done at the Islamic University of Riau Habit of Mind Students can be seen in Figure 1.

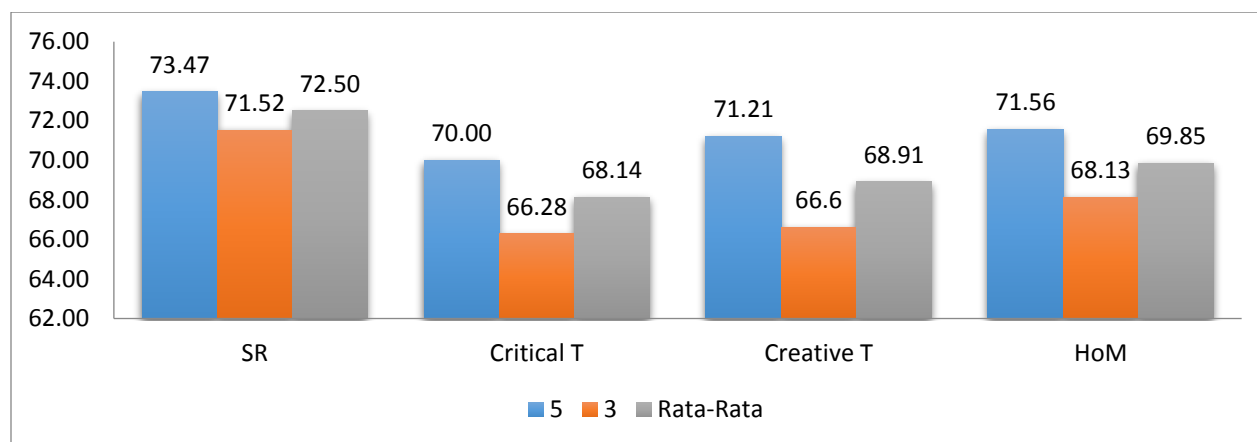

Figure 1. HoM Islamic University of Riau's Biology Education

Habit of Mind students in Islamic University of Riau Biology Education Program are in the sufficient category with a percentage of 69.85%, while for the highest category of self regulation (72.50%) followed by creative thinking (68.91%) and the lowest is the critical

thinking category of 68.14%. The data above shows that the higher level (semester) then the better habits of mind, 5th semester students have better habits compared to students of the 3rd semester.

Table 2. Self Regulation Category

Semester	1	2	3	4	5	Total
5th	72,05	73,30	76,23	64,91	80,88	73,47
3rd	69,11	71,02	75,19	64,16	78,12	71,52
Average	70,58	72,16	75,71	64,54	79,50	72,50

The data above is in line with previous data ie 5th semester students have better habits (self-regulation) compared to the 3rd semester. Students of Biology Education Program of Islamic University of Riau have good habit in evaluating their action (79,50%) and using the

necessary resources (75,71%) while to realize self-thinking of 5th semester student better than semester 3 with the most percentage low (70.58%) compared to other indicators.

Table 3. Critical Thinking Category

Semester	1	2	3	4	5	Total
5	74,97	68,84	67,36	66,75	72,07	70,00
3	72,04	63,78	64,02	61,48	70,08	66,26
Average	73,51	66,31	65,69	64,12	71,08	68,13

Critical thinking habits are the lowest category compared with other habits such as self-regulation and creative thinking. Overall the habit of critical thinking is in sufficient category with a percentage of 68.13%. All

indicators in this category with the highest percentage in the first indicator that is accurate and look for accuracy followed are sensitive and know the ability of friends.

Table 4. Creative Thinking Category

Semester	1	2	3	Total
5	71,36	69,63	72,67	71,22
3	72,04	63,78	64,02	66,61
Average	71,70	66,71	68,35	68,92

Creative thinking consists of 3 indicators, namely (1) trying to complete the task even though the answer is not yet know (2) doing business maximizing ability and knowledge and (3) generate new way to see situation

different from usual way generally. The second indicator is the lowest indicator of the three indicators with a percentage of 66.71% with sufficient category.

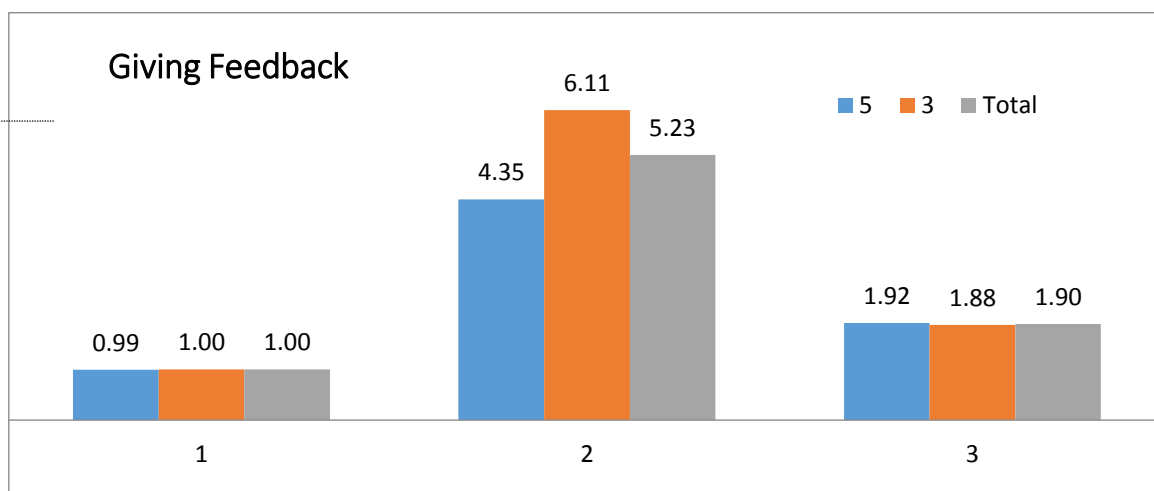

Picture 2. Recapitulation of Feedback on lectures

Based on Figure 2 above shows that all students both in the 3rd and 5th semesters have received feedback from lecturers related to the task he made but have different levels. In the 5th semester the average student get feedback as much as 4 times whereas in semester 3 the average student get feedback from the task of college as much as 6 times. This data indicates that there is an increase of feedback by lecturers from assignments in each semester. This proves that there is a positive trend of lecturers to provide feedback on the task in order to get the process and maximum results in the lecture. In addition, the average student gets the obligation to use at least 5 - 10 kinds of relevant references of the task created.

Habits of mind is a habit of thinking that can help a person in completing tasks and problems that will be in the future. The better a person is in managing himself the better they are in solving problems or tasks in the future. Based on the results of the study showed that students of UIR Biological Education Program Academic year 2017/2018 showed that HoM students in the category enough with a percentage of 69.85%. In addition, higher semesters (5)

showed higher habits compared to the lower semester (3) in all HoM categories. An attitude will turn into habits or Habits takes time and a long process is in line with research conducted Idris (2013) shows that to train habits it takes a longer time.

Of the three categories of habits of mind the self-regulation category has the highest percentage compared to other categories such as critical thinking and creative thinking. The results of this study are in line with almost all habits of mind research indicating the highest self-regulation category indicator (Sriyati (2011), Idris (2013), Hidayati and Idris (2015), Sriyati and Bidayati (2014)). Self-organizing habits are able to assist students in completing the tasks and problems they face. The better the student in managing herself the better the values in the lecture. This is in line with the statements of Morosanova and Fomina (2017) which states that self-regulation contributes significantly to student learning outcomes and self-regulation also acts in controlling the emotions, thoughts and actions of a person who will contribute to students' academic ignorance (Magi et al., 2016).

According to Ennis (2011) critical thinking is deciding what to believe and do with reasonable and reflective thinking. Based on Table 3. It shows that overall students' thinking habits in the category are sufficient with the criteria of more senior students having better habits (not significant because they are still in the same category) of junior students is in line with research conducted by Huber and Kuncel (2016) which states that college experiences have a positive impact on the development of critical thinking. Nevertheless, the data indicate that the habits of thinking at both levels of students are still in sufficient category, this indicates that habits are not only influenced by experiential factors but many other influencing factors such as academic achievement, background, gender and ethnicity (Giarcolo & Facione 2001).

The last category in habits of mind is creative thinking. According to Kaufman & Beghetto 2009 and Runco 2008 Creative thinking is the main skill needed in education to prepare a person in the face of future life. In the habits of mind there are 3 indicators of the creative thinking category (1) can involve themselves in the task even though the answer and the solution is not yet visible (2) to do business with the maximum ability and knowledge as well as (3) generate new ways of looking at different situations from the usual way of prevailing in general. Students of biology education program have creative thinking habit in category enough to mean some less lecturing activities provide container and exercise to student creative thinking. Students are more inclined given the task with some rules to be followed so that their creativity is not honed. Providing rules will actually strengthen student self-regulation but on the other hand can hamper student creativity.

4. CONCLUSION

Based on the research, it can be concluded that the habit of thinking (habits of mind) of Biology Education Program students in the category is enough with the percentage of 69.85% with the highest percentage in self-regulation category followed by creative thinking and the lowest critical thinking category. While based on student habits of 2015 (semester 5) is better than the habits of the class of 2016 (semester 3) in all categories HoM. In addition, all students have received feedback with an average of 5 times / subject from lecturers and lecturers provide rules using 5 - 10 references in completing the course task.

ACKNOWLEDGMENTS

We would like to acknowledge my institution, Islamic University of Riau, that's always support us to do some research. we are also acknowledge to Kemenristek Dikti who has provided grant funds so that this research can be implemented

REFERENCES

- ASCD. 2009. *Developing Habits of Mind in Elementary Schools*. Online. [www.ascd.org/ASCD/pdf/books/boyesAT2009_exploring_the_meaning, diakses 19 September 2017](http://www.ascd.org/ASCD/pdf/books/boyesAT2009_exploring_the_meaning_diakses_19_September_2017)
- Burgess, H. 2012. "The Impact of Teaching Thinking Skills as Habits of Mind to Young Children With Challenging Behaviours". *Journal Routledge Taylor & Francis Group-Emotional and Behavioural Difficulties*. [Online]: Vol 17 (1). Tersedia ; <http://dx.doi.org/10.1080/13632752.2012.652426>
- Costa, A.L. & Kallick, B. 2000a. *Describing 16 Habits of Mind. Habits of Mind: A developmental series*. Alexandria, VA. [Online]. Tersedia:

- http://www.ccsnh.edu/documents/CSNH_MLC_Habits_of_Mind_Costa_Kallick.
- Costa, A.L. & Kallick, B 2000b. *Assessing and Reporting on Habits of Mind*. Alexandria: Association For Supervision and Curriculum Development (ASCD).
- Cuoco, A., Goldenberg, E.P., Mark, J. 1996. Habits of Mind: An Organizing Principle for Mathematics Curricula. *Journal of Mathematical Behavior* 15, 375-40
- Finn, B., Thoman, R., Rawson, K.A. 2017. Learning More From Feedback: Elaborating Feedback with Examples Enhance Concept Learning. *Learning and Instruction* (2017), 1-10
- Marzano R. J., Pickering and Mc Rigue. 1993. *Assessing Student Outcomes. Performance Assessment Using the Dimension of Learning Model*. Alexandria, Virginia; Association for Supervision and Curriculum Development
- Noreen, S., Whyte, K.E., Dritschel, B. 2015. Investigating the role of future thinking in social problem solving. *J. Behav. Ther. & Exp. Psychiat*, 46 (2015), 78-84
- Purwanto. 2008. *Metodologi Penelitian Kuantitatif, Untuk Psikologi dan Pendidikan*. Yogyakarta. Pustaka Pelajar
- Rodzalana, S.A & Saat, M.M. 2015. The Perception of Critical Thinking and Problem Solving Skill among Malaysian Undergraduate Students. *Procedia - Social and Behavioral Sciences*, 172(2015), 725-732
- Sriyati, S. 2011. *Penerapan Asesmen Formatif Untuk Membentuk Habits of Mind Mahasiswa Biologi*. Disertasi Sekolah Pascasarjana UPI Bandung. tidak diterbitkan
- Stiggins, R. J. (1994). *Students centered-Classroom Assessment*. New York: Merrill Macmillan Colege Publishing Company.
- Teachtaught. 2012. **What Are The Habits Of Mind. Online.** <http://www.teachthought.com/pedagogy/what-are-the-habits-of-mind/>, diakses 19 September 2017)
- Volkman, M.J & Eichinger, D.C 2010. Habits of Mind: Integrating the Social and Personal Characteristics of Doing Science Into the Science Classroom. *School Science and Mathematics*, 99 (3), 141-147

IMPROVING FAMILY REVENUES THROUGH ROLE OF HOUSEHOLD MOTHER IN REJOTANGAN DISTRICT

Ida Syamsu Roidah¹, Dona Wahyuning Laily²

^{1,2} Post Graduate Student of Agricultural Science Brawijaya University Malang

Email : ida_syamsu@yahoo.co.id

Abstract

Strong food security starts from the smallest scope of the family in this case housewives who have a very important role in realizing food security in the family. Housewives farmer are human resources in development activities, so farmers housewives need to have the motivation, knowledge, education and skills that meet the needs and demands of development in increasing agricultural production through post-harvest in order to maintain the sustainability of household income. The purpose of writing is (1). Analyze the income of housewives in the presence of gender equality; (2) Analyze the role of housewives in increasing family income. The method used in this research is descriptive research conducted by field survey. The results of the study that the role of housewives in helping their husbands begin from their awareness of the necessities of life that is increasing so increase the family income is necessary and not depend on the income provided by the husband to meet daily needs. In addition, the use of the yard around the house by using pots or polybags, and directly planted with various kinds of plants (fruits and vegetables) has largely been understood but housewives have not been maximally in the management of their yard because it still assume that the size of the yard affects the difference of planting system which is conducted.

Keyword: *Housewife, Income Increase, Family*

1. INTRODUCTION

Food is a very important and strategic need for human sustainability. Fulfillment of food for every human being is a goal as well as a target of food security in the region and national, so that in realizing food security starts from the smallest scope of the household. One of them is the role of housewives who are big enough in making decisions and in terms of increasing income. According to Martianto (2015), the impact of agricultural programs on household food security is more evident when the activities involve women, diverse

cropping patterns (intercropping, overlapping), encouraging the development of small / home industries for product processing, increasing production and income without reducing the can be consumed by household members.

Development activities, especially in the field of agriculture demands the participation of all parties, especially the farmers and their families. One of the elements of the farm family is the wives of farmers or housewives who have a position as a companion or help her husband in managing farming. The role of housewives

in the development of farmers is quite large, not only visible in physical activity but also in making decisions and in terms of increasing income. In addition to the family's income, they do not have to work in the office but can also do their own work or work as farm laborers (onfarm), factory workers or work in the home industry, such as making various kinds of industrial products that can be sold to supplement income.

Development of housewives in the family, can not be separated from efforts to increase the role of women as an internal part in national development. Therefore, the guidance direction refers to the mandate of GBHN and the policy of the Minister of Women's Empowerment which stipulates that efforts to increase the role of women in the nation's development are based on harmonious partnership among men and women in harmony, harmonious and balanced with gender approach. The approach between men and women has equal rights, duties and positions in development in all fields, including social life, family, nation and state without leaving the natures, dignity and dignity as women.

The development of the age of women's role has not been considered, as is the case with rural women. Despite its large role in households both in family farming as managers, producers and workers. This means that the participation rate of housewife farmers is increasing from year to year. The roles and responsibilities of farmer housewives in some areas are very prominent, whereas the farmer's housewife strongly supports her role in raising family income by working outside the agricultural sector such as doing skills, trading, raising, sewing, or being a seasonal worker in the company or on the land of people other. It is also often seen that decision-making in terms of adoption of new technologies and the determination of the type of business of family activity is determined by women. Some of the obstacles that farmers'

housewives have, despite their great responsibilities and roles:

- a) Farmer housewives still lack the opportunity to participate in agricultural development.
- b) Farmer education is low.
- c) Farmers' housewives are not given access and various services in the agricultural sector.
- d) There is a gap in the wage structure between men and women in the agricultural sector and the lack of respect for women.

Efforts made by housewives in helping their husbands income begin their awareness of the necessities of life is increasing, for that awareness of housewives participate in supplementing family income is necessary. Thus they depend not only on the income that their husbands provide to meet their daily needs.

Objectives and Benefits of Research

The objectives of the study were (1) to analyze the income of housewives in the presence of gender equality; (2) to analyze the role of housewives in increasing income.

Benefits of research include (1) housewife knows role in increasing income in family; (2) to broaden knowledge horizons about the role of housewives in increasing income; (3) for consideration in conducting further research in the same field.

2. METHODOLOGY

Time and Location Research

The study was conducted in January - June 2016 by collecting primary data and secondary data at Rejotangan sub-district level which were sourced from reports and reviews from several research results, especially on the role of housewives in Rejotangan sub-district.

Types of Research

The type of this research is descriptive analysis with survey method

using questioner and questionnaire to respondent. This research is to explain systematically about the data or characteristics of a particular population or a particular field.

Data source

Primary data is data collected from respondents directly by using questionnaires (questionnaires) that have been prepared previously related to the activities of housewives in increasing revenue. Furthermore for secondary data is data collected by taking data related to research from other institution.

Sampling Technique

Sampling is done by simple random sampling method, which is a sample taken so that each research unit or elementary unit of population has equal opportunity to be selected as sample. Population of all housewives who follow Program Keluarga Harapan in Rejotangan district. The number of 975 samples, the sample determination using Slovin formula as follows:

$\frac{N}{1+N.e^2}$ so that the sample can be 91 people.

Method of Collecting Data

Technique of taking data using (a) observation / observation; (b) interviews; (c) Library Studies.

Data Analysis Technique

This research use free test of X (Chi Square) which is used to know relation of increase of family income with housewife activity of Chi Square Formula (X^2):

$$X^2 = \sqrt{\frac{(n_{ij} - e_{ij})}{e_{ij}}}$$

Where:

X^2 = Chi Square

n_{ij} = Number of observed

e_{ij} = expected

3. RESEARCH AND DISCUSSION

Contribution of Housewife Income to Husband's Income

Basically, women have equal rights, obligations and employment opportunities

with men to participate in development activities in accordance with those expressed in the Guidelines of State Policy. The differentiation of work between men and women in rural communities is quite clear but the working relationships of men and women in the production process are not determined by sex differences. But on the basis of the fact that we see that the status and role of women always change according to circumstances, for example if her husband dies, the woman's first duty of working as a maid of husband's income eventually turns into the main breadwinner in the household. With the current economic development is progress toward a pattern of increasingly sharp division of labor and the greater the variation. Thus, at the simplest level of the family economy there is still a division of labor between the members of the family itself and the main criteria for the division of labor is age and sex.

Based on research conducted that the contribution of housewife's income given to her family aims to alleviate the burden of the economy that is borne entirely by the head of the family (husband), this is done to increase family income. In fact, housewives have an obligation to regulate the welfare and the economy of their families. Types of work commonly done by housewives such as, cleaning up dirty household furniture, fixing the house, taking care of children and so forth. It's the kind of work that housewives routinely do every day, so that kind of work is called domestic sector work. With such a background then, there is a tendency to work outside the home in order to help the husband's income so that the welfare of his family is more fulfilled.

Another background that underlies the work of a housewife is because of the narrowness of land she owns. This affects the motivation to work. The narrowness of land is not possible to be planted with various types of commodities, so the farmers' families do not depend entirely on

the narrow land they own and added with the production produced only barely to be consumed by his family. In the study area, additional work by housewives of different kinds. But there is a tendency to work in the field of home industry engaged in the agribusiness sector that is making snacks in the form of fried foods sold every afternoon and making crackers based Gadung. This activity is done after resolving household affairs so as not to disrupt its domestic activities. In certain seasons on average each day can produce krupuk gadung about 5 - 7.5 kg with an average income of Rp 25,000 - Rp 37,500. While on a working day is not a full month but more or less for 15 days per month, but this time - time can change depending on the order, such as during the season around the community have a show or during the Eid season so that the number of requests so much weekdays also increase. To perform the activity usually starts at 08.00 am after completing the affairs in the kitchen.

Activities to make gadung crackers take a long time, such as peeling gadung, slicing then soak it, clean or remove the former immersion until steaming and drying it. In the immersion of the material used is grilled ash, this is done with the aim to eliminate toxins that exist in the yam yam so it will not cause poisoning after eating it. The results of interviews conducted with respondents can be seen that the average - every female worker can produce approximately 7.5 kg krupuk gadung that is in a state ready for consumption. From the description can be seen that the average income generated by each housewife per month there are reaching approximately Rp 700,000. But there are also housewives whose monthly income is only Rp 215,000. If it is projected between the amount of income of wife to husband, it can be seen that the contribution of wife earnings can reach 23,53% up to 93,33%. This shows how much influence the income contributed by housewives to her family.

The contribution of farmers' housewives income is used in addition to fulfilling their household needs such as buying kitchen needs and such, for the cost of their children's education and so on. This income generated by housewives can not be separated from the pen.

Contribution of Mother Household Income to Family Income

The contribution of farmers' housewives' income is seen as having an effect on all household needs. This can be seen from the need that usually can not be fulfilled become fulfilled because there is contribution of housewife's income. Like the small contribution of income that housewives provide to their families, it provides considerable benefits to family welfare. Indirectly the income generated can meet the needs that should be met properly.

The goal to be achieved in agricultural development is to increase the income and welfare of the family from time to time. An increase in the amount of income in rural households will provide job opportunities for the housewife to improve and improve the quality, quantity and variety of goods and services they will purchase. In addition, households that have increased revenues are expected to make their spending budgets according to their household needs. If the amount of income earned per household in the countryside is not as great as each other. This is due to the differences in:

1. Ownership of agricultural land.
2. Business capital.
3. Opportunity to obtain employment either in agriculture sector or outside agriculture sector.
4. Type of business undertaken.

The difference in income levels will clearly lead to differences in the patterns of household consumption and the control of capital (wealth) rather than land. For example, smallholder households or

agricultural laborers because of their relatively small incomes, can only afford basic necessities such as rice and side dishes. While large farmers, because the income is large, in addition to being able to buy staple goods such as rice and side dishes that are well nourished, also able to buy secondary goods such as household goods, transportation equipment, entertainment equipment (radio, television), and capital goods such as tractors, land or saving.

Expenditures to build or repair houses include the greatest expenditure compared to other expenses. Generally money to build a house, saved for years in the form of building materials not in the form of money. Today, wealthy farmers are able to follow the modern home model and meet the requirements of a decent home. Household expenses for household appliances comprise and expenditure on furniture (tables, chairs, cabinets and others), beds, kitchenware and entertainment equipment such as radio, tape and television. The household appliances most commonly owned by poor households only consist of basic household items such as beds and kitchen utensils such as plates and others. While the high-income household class in addition to having basic household appliances also have furniture and entertainment equipment such as tape recorder or television.

The average research area of the community uses private transportation such as motorcycles. Motorcycles are needed if housewives who have business trading such as opening a shop will go to the market to buy the needs - the need to be sold. Usually housewives who open a shop, go to the market at 02.00 am until return home around 05.30 pm then sell it again. The work done by this housewife is solely to meet the needs of the household properly to reach a prosperous family.

Based on the above data, it can be seen that the contribution of housewives to their families can reach between 19.05% to 47.17%. This indicates that the income of

housewife is high enough to income of family in whole (in this case income of husband and housewife). Based on data obtained from the field can be seen that the total amount between the income of housewives and husbands can reach between Rp 590.000 - Rp 1.700.000 per month. From this data it can be explained that if the income of a housewife combined with income, it would seem that the ratio between the income of the wife to the total income (wife and husband) is quite high, although the income generated is not up to 50% and the income of her husband every month. So have a side business and ultimately housewives no longer have difficulties in managing finances and even most can be saved, so that their child's education is fulfilled with evidence of many children continuing their education even though not all villagers have awareness of education.

4. CONCLUSION

1. The contribution of housewife's income to husband's income reaches around Rp 215,000 - 700,000 per month. If diprosentasekan between the amount of income compared to husband's wife, it can be seen that the contribution of wife's income to husband can reach 23.53% - 93.33%. So it can be concluded that the contribution of housewife income to her husband is quite large.
2. The contribution of income given by housewives to their family is relatively big, that is between 19,05% - 47,14%. In this case the family income can reach Rp 590.000 - Rp 1.700.000 per month.

REFERENCES

Elizabeth, Roosganda. *Woman Empowerment to Support Gender Mainstreaming in Rural Agricultural Development Policies*. Jurnal Forum

-
- Penelitian Agro Ekonomi. Vol 25(2):
126-135
- Fakih, M. 1996. *Analisis Gender dan Transformasi Sosial*. Pustaka Pelajar: Yogyakarta.
- Guhardja S, Puspitawati H, Hartoyo, Hastuti D. 1992. *Manajemen Sumberdaya Keluarga*. Diklat Departemen Gizi Masyarakat dan Sumberdaya Keluarga. Fakultas Pertanian, Institut Pertanian Bogor: Bogor
- Gusti Kanjeng Ratu Hemas. 1992. *Wanita Indonesia Suatu Konsepsi dan Obsesi*. Liberty: Jakarta
- Koswara, Jajah. 1995. *Tantangan dan Hambatan Bagi Ilmuwan Wanita*. Warta Studi Perempuan Vol 3: Jakarta
- Murniadi. 1993. *Perempuan Indonesia dan Pola Ketergantungan dalam Citra Wanita dan Kekuasaan*. Kanisius: Jakarta
- PPK-LIPI. 2004. *Ketahanan Pangan Rumah Tangga di Pedesaan: Konsep dan Ukuran*.
- Powel, Melanie and David, Ansic. 1997. *Gender Differences in Risk Behaviour in Financial Decision Making: An Experimental Analysis*. *Journal of Economic Psychology* Vol 18 (6):605-628
- Sayogya, Pudjiwati. 1995. *Peranan Wanita dalam Perkembangan Masyarakat Desa*. Rajawali: Jakarta
- Tjandraningsih, I. 1996. *Mengidentifikasi Persoalan Perempuan dalam Analisis Gender dalam Memahami Persoalan Perempuan*. *Jurnal Analisis Sosial*. Edisi 4 Nopember. AKATIGA. Bandung.
- Wibowo, Dwi Edi. 2011. *Peran Ganda Perempuan dan Kesetaraan Gender*. *Jurnal Muwazah* Vol 3(1): 356-364

STUDY OF CONCRETE ON RIGID PAVEMENT WITH ADDITION SCANFIBRE

Hermaini¹, Sugeng Wiyono², Anas Puri³

^{1,2,3} Department of Civil Engineering, Faculty of Engineering, Universitas Islam Riau
Jl. Kaharuddin Nasution, Marpoyan, Pekanbaru 28284 Riau, Indonesia

Email : wiyonouir@gmail.com

Abstract

Concrete is an important material and widely used in the construction world. One is the use of concrete rigid pavement (rigid pavement). In rigid pavement planning does not give priority to the compressive strength but which is preferred is the flexural strength. Because the rigid pavement is rigid in nature, it must be able to withstand the lapping of the vehicle wheel load. Hence the question arises how to increase the value of strong bending on rigid pavement? In this study used Scanfibre as a mixture of concrete.

This research uses experimental method with total of 240 test object. A total of 120 pieces for cylindrical compressive test specimens with a diameter of 15 cm and a height of 30 cm with variations of Scanfibre 0% (normal concrete), 0.1%, 0.2%, 0.3%, 0.4%, 0.6%, 0.8%, and 1.0 %. A total of 120 more for bending beam-shaped test specimens 15 x 15 x 60 cm with variation of Scanfibre 0% (normal concrete), 0.1%, 0.2%, 0.3%, 0.4%, 0.6%, 0.8%, and 1.0% tested at age 7, 28, and 56 days.

The results showed that the use of Scanfibre in various levels did not give a significant effect on the bending strength of concrete. These results are in line with the results of analyzes performed at ages 7, 28, and 56 days. The optimum bending strength of the concrete at the ages of 7, 28 and 56 days was 4.38 MPa, 4.71 MPa, 4.75 MPa. Based on the formula of $f_s = K (f_c)^{0.5}$, the relationship between the compressive strength and flexural strength at the age of 7, 28 and 56 days, the importance of the average value of the constant is 0.7345, 0.7687, and 0.7404 .

Keywords: Rigid Pavement, Scanfibre, Compressive Strength, Flexural Strength

1. INTRODUCTION

One way to improve the flexural strength of rigid pavement is to use fiber-added material. The addition of these flexible fibers the resulting strength will be better or

higher so effective in reducing cracks and can increase resistance to flexure.

One of the important properties of concrete is ductility. With the properties of the ducktail, the fibers are mixed into the concrete is expected to be used to improve the characteristics of concrete. Considering the condition of the increasing use of fiber-

added materials for concrete construction, we took Scanfibre form as our research material to find out the extent of the effect of adding the fibre to the strength of concrete bending.

1.2 Formulation of the problem

As the subject of this study is to compare Compressive strength and flexural strength of concrete using Scanfibre added material with normal or no fiber concrete. To give a clear scope about the problem to be discussed in the research, it is necessary to formulate the problem as follows:

1. How the optimum flexural strength resulting from the addition of scanfibre 0, 1%, 0, 2%, 0, 3%, 0, 4%, 0.6%, 0.8% and 1.0% Viewed from the weight of fresh concrete.
2. What influence flexural strength of the concrete after using Scanfiber added material.

1.3 Research Objectives

The purpose of this research is to:

1. Knowing the optimum flexural strength values resulting from the addition of scanfibre 0, 0, 1%, 0, 2%, 0, 3%, 0, 4%, 0.6%, 0.8% and 1.0%.
2. Knowing the influence of flexural strength of the concrete after using added material scanfibre.

1.4 Scope of problem

In this paper, the following problem limits are taken:

1. Aggregate used is derived from Pangkalan West Sumatra.
2. The cement used is Type I Semen Padang.
3. The added material is a Scanfibre.
4. Concrete Quality is used by Fc 35 MPa.

2 METHODOLOGY

2.1 General

The method applied in this research is the experimental method which is done

by conducting an experiment directly to get a data or the result of connecting between variables investigated. The experiment was conducted in the laboratory. Tests conducted in this research include testing of materials, flexural strength testing using a flexural strength test (*testing Bending Machine*).

2.2 Research Sites

The research was conducted at PT. Virajaya Riauputra located on the highway of Pekanbaru - Bangkinang KM 27.

2.3 Research Preparation

1. Material

Materials used in this study include:

- a. Rough aggregates (crushed stone) of raw materials obtained from Pangkalan - West Sumatera, the result of Stone Cruser from PT. Virajaya Riauputra located on the highway of Pekanbaru - Bangkinang KM 27.
- b. Fine Aggregate, raw material obtained from Lake Bingkuang.
- c. The cement used is Cement Type I.
- d. The added material is Scanfibre.
- e. Water

2. Equipment

This study uses the equipment located in the Laboratory of PT. Virajaya Riauputra, the equipment used in this research are:

- a. A set of standard ASTM sieve shaker.
- b. Oven completed with temperature control.
- c. Measuring cup.
- d. Triple beam scales with a precision of 0.1 grams.
- e. Digital scales with a precision of 0.001 grams.
- f. Conical mold to measure the state of fine aggregate SSDs.

- g. Los Angeles machine and steel balls for abrasive aggregate abrasion testing.
- h. Small pot for water container
- i. Mixer to mix
- j. A set of molds of 100 x 100 x 600 mm for flexural strength test and d: 150 mm t: 300 mm for compressive strength test.
- k. Abrams cone for slump testing.
- l. A set of concrete compressive strength test kits.
- m. A set of concrete bending strength test equipment.
- n. Supporting equipment such as hand shirts, masks, wrenches and screwdrivers.

2.4 Test objects

The test specimens in this study were cylindrical and beam with 5 test specimens for each treatment ie 0%, 0.1%, 0.2%, 0.3, 0.4%, 0.6%, 0.8% and 1.0% for Scanfibre for testing Compressive strength and flexural strength at 7 days, 28 days and 56 days.

2.5 Stages and Procedures Research

The implementation of this research conducted several stages from the selection of concrete materials, material testing, manufacture of test objects, test object testing, data analysis and conclusions from the results of research.

The research implementation is divided into several stages, namely:

1. Phase I, the preparation stage.
At this stage all materials and equipment needed in the research are prepared in advance for research to run smoothly.
2. Phase II, the material test stage.
At this stage, a study of concrete materials is made. This is done to determine the nature and characteristics of the material. In addition to know whether the material meets the requirements or not.

3. Stage III, the stage of making the specimen.

At this stage the work is done as follows:

- a. Determination of mix design of concrete.
- b. Concrete mixing.
- c. Check slump value.
- d. Creation of specimens.

4. Stage IV , the stage of treatment (curing).

At this stage the treatment of test specimens that have been made in stage III. Treatment is done by using the test specimen after being removed from the mold.

5. Stage V Called the testing phase.

At this stage, the test of compressive strength and bending strength. Flexural strength test was performed on 150x150x600 mm concrete beam samples, while the compressive strength test was performed with cylindrical sample with diameter 150 mm and height 300 mm.

6. Stage VI, the data analysis phase.

At this stage, the data obtained from the test results are analyzed to obtain a conclusion of the relationship between the variables studied in the study.

7. Stage VII Called the stage of conclusion.

At this stage, the data that has been analyzed made a conclusion related to the purpose of the study.

2.6 Experimental Variations

In this test variation testing is done:

In addition Scanfibre 0, 1%, 0, 2%, 0, 3%, 0, 4 %, 0,6%, 0,8%, and 1.0% in terms of the weight of fresh concrete.

2.7 Test Result Testing, Analysis and Conclusions

After testing is done, then the analysis of research results and take conclusions from the processing of data analysis.

3. RESULT AND DISCUSSION

3.1 Material Inspection Results

1. Agregate Inspection Result 2-3

The examination results on the characteristics of Agregate 2-3 produced from the production of Stone Crusher PT. Virajaya Riauputra is as follows:

Table 3.1 Agregate Inspection Result 2-3

No.	Checking type	Check up result	Unit
1.	Specific gravity :	2,538	(Gr / cc)
	• Dry Type Weight	2,555	(Gr / cc)
	• SSD Type Weight	2,582	(Gr / cc)
	• Pseudo Weight	0.659	%
	• Absorption		
2.	Abration	25.7	%
3.	Weight Release	1,356	(Kg / m3)

2. Results of Agregate Inspection 1-2

The examination results on the characteristics of Agregate 1-2 produced

from the production of Stone Crusher PT. Virajaya Riauputra is as follows:

Table 3.2 Results of Agregate Inspection

No.	Checking type	result	Unit
1.	Specific gravity :	2,474	(Gr / cc)
	• Dry Type Weight	2,513	(Gr / cc)
	• SSD Type Weight	2,574	(Gr / cc)
	• Pseudo Weight	1.576	%
	• Absorption		
2.	Abration	25.7	%
3.	Weight Release	1,397	(Gr / cc)

3. Results of Fine Aggregate Inspection (Sand)

The results of examination on the characteristics of Sand sourced from Danau Bingkuang are as follows:

Table 3.3 Results of Fine Aggregate Inspection (Sand)

No.	Checking type	Check up result	Unit
1.	Specific gravity :	2,675	(Gr / cc)
	• Dry Type Weight	2,704	(Gr / cc)
		2,755	(Gr / cc)

	<ul style="list-style-type: none"> • SSD Type Weight • Pseudo Weight • Absorption 	1.082	%
3.	Weight Release	1.508	(Gr / cc)

4. Mixed Concrete Mixture Design

Based on the design calculations mixture (Mix Design) obtained concrete mix material requirements for 1 m³ of concrete:

- Cement: 460 Kg
- Water: 184 Kg
- Broken Stone 2 - 3: 696,2 Kg
- Broken Stone 1 - 2: 522,1 Kg
- Sand: 522.1 Kg

Total Weight: 2,384.4 Kg

3.2 Concrete Test Result

1. Compressive Strength of Concrete

a. Compressive Strength of Concrete Age 7 Days

Testing is done at 7 days. The data of concrete compressive strength test with Scanfibre addition can be seen in Table 3.4 below.

Table 3.4 Compressive Strength of Concrete Age 7 Days

No	Scanfibre Percentage	Compressive Strength	
		(MPa)	% Against with Normal Concrete
1	0.00	31.25	100.00
2	0.10	31.93	102.18
3	0.20	28.93	92,58
4	0.30	30.84	98.69
5	0.40	28.25	90.39
6	0.60	27.98	89.52
7	0.80	28.11	89.96
8	1.00	32.48	103.93

Based on the data in Table 3.4 above shows that the compressive strength of concrete at the age of 7 days without added Scanfibre is 31.25 MPa. In the addition of Scanfibre of 0.1% there was an increase of 2.18%, on the addition of Scanfibre of 0.2% a decrease in compressive strength of 7.42%, in addition Scanfibre of 0.3% decreased compressive strength of 1.31%, the addition of Scanfibre of 0.4% was decreased compressive strength of 9.61%, Scanfibre addition of 0.6% decreased compressive strength of 10.48%, Scanfibre addition of 0.8% was decrease in compressive strength

10.04%, and 1.0% Scanfibre addition increased 3.93% compressive strength when compared to compressive strength value of concrete mixture without Scanfibre addition.

b. Compressive Strength Concrete at 28 Days

Tests were performed at 28 days. The data of concrete compressive strength test results with the addition of Scanfibre can be seen in Table 3.5 below.

Tabel 3.5 Compressive Strength at 28 Days

No	Scanfibre Percentage	Compressive Strength	
		(MPa)	% Against Normal Concrete
1	0%	35.07	100.00
2	0.10	38.49	109.75
3	0.20	31.73	90.48
4	0.30	38.90	110.92
5	0.40	35.48	101.69
6	0.60	34.39	98.06
7	0.80	29.14	83.09
8	1.00	33.44	95.35

Based on the data in Table 3.5 above shows that the compressive strength of concrete at 28 days without added Scanfibre is 35.07 MPa. In addition of Scanfibre 0.1% there was an increase in compressive strength of 9.75%, in addition of Scanfibre 0.2% a decrease in compressive strength of 9.52%, in addition Scanfibre of 0.3% Press of 10.92%, the addition of Scanfibre 0.4% increase in compressive strength of 1,69, Scanfibre addition of 0.6% increase in compressive strength of 1.94%, Scanfibre addition 0, 8% a decrease in compressive

strength of 63.91%, and the addition of Scanfibre by 1.0%, a decrease in compressive strength by 4.65% when compared with the value of compressive strength of concrete mixture without Scanfibre addition.

c. Compressive Strength Concrete 56 Days

The test is done at the age of 56 days. The result data of concrete compressive strength test with Scanfibre addition can be seen in Table 3.6 below

Table 3.6 Compressive Strength at 56 Days

No	Scanfibre Percentage	Compressive Strength at 56 Days	
		(MPa)	% Against Normal Concrete
1	0%	37.39	100.00
2	0.10	38.35	102.55
3	0.20	36.30	97.08
4	0.30	45.45	121,53
5	0.40	43.40	116.06
6	0.60	41.22	110.22
7	0.80	31.95	85.44
8	1.00	40.12	107.30

Based on the data in Table 3.6 above shows that the compressive strength of concrete at age 56 days without added Scanfibre is 37.39 MPa. In the addition of Scanfibre 0.1% there was an increase in compressive strength of 2.55%, in addition of Scanfibre 0.2% a decrease in compressive strength of 2.92%, in addition

Scanfibre fiber of 0.3% Press of 21.53%, in addition Scanfibre of 0.4% increase in compressive strength of 16.06%, Scanfibre addition of 0.6% increase in compressive strength of 10.22%, Scanfibre addition of 0, 8% a decrease in compressive strength of 14.56%, and the addition of Scanfibre of 1.0% increase in compressive strength of 7.30%

when compared with the compressive strength value of concrete mixture without Scanfibre addition.

d. Relationship between Concrete Compressive Strength and Concrete Age

The relationship between concrete compressive strength and concrete life can be seen in graph 3.1 below.

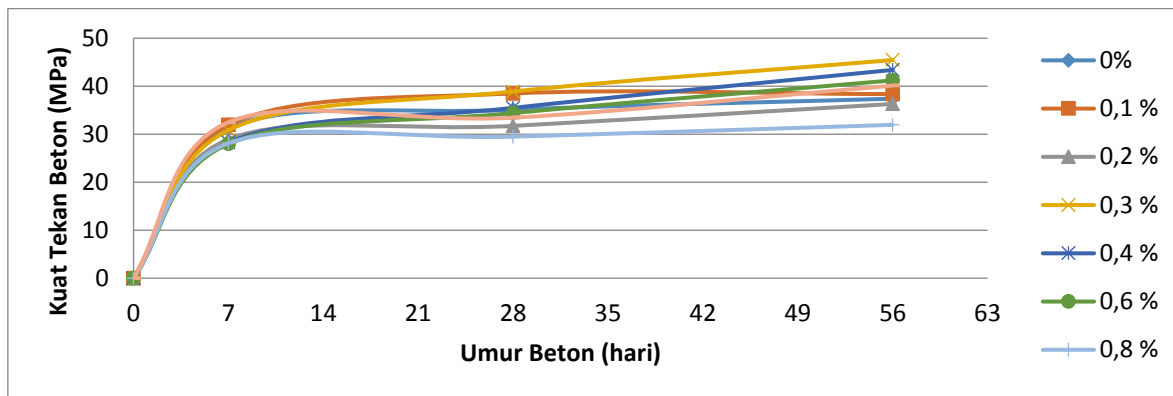

Figure 3.1. Relationship between Concrete

e. Compressive Strength Comparison at 7 Days, 28 Days, and 56 Days

Based on Figure 4.5 above shows that the average concrete compressive strength at the age of 7 days without more less compared with the compressive strength of the average concrete at the age of 28 days and 56 days. The average concrete strength

of concrete at 28 days was lower than the average concrete compressive strength at the age of 56 days.

2. Concrete Bending Strength

a. Strong Bending Concrete Age 7 Days

Testing is done at 7 days. The result data of the concrete bending strength of the concrete with the addition of Scanfibre can be seen in Table 3.7 below.

Table 3.7 the concrete bending strength

No	Scanfibre Percentage	the concrete bending strength 7 days	
		(MPa)	% Against Normal Concrete
1	0%	3.96	100.00
2	0.10	4.22	106.44
3	0.20	4.20	106.06
4	0.30	4.38	110.50
5	0.40	4.15	104.73
6	0.60	3.51	88.67
7	0.80	3.83	96.71
8	1.00	3.91	98.71

Based on the data in Table 3.7 above shows that the flexural compressive

strength at age 7 days without added Scanfibre is 3.96 MPa. In Scanfibre

addition of 0.1% there was a 6.1% increase in bending strength, in addition of Scanfibre of 0.2%, increased flexural strength by 6.06%, in addition to Scanfibre of 0.3% By 10,05%, the addition of Scanfibre by 0,4% there was increase of bending strength by 4,73%, Scanfibre addition by 0,6%, decrease of bending strength by 11,33%, Scanfibre addition 0,8% % There was a decrease in the flexural strength of 3.29%, and the addition of Scanfibre by 1.0%

decreased the bending strength by 1.29% when compared with the flexural strength of the concrete mixture without the addition of Scanfibre.

b. Concrete bending strength Age 28 Days

Tests were performed at 28 days. The result data of the concrete bending strength of the concrete with the addition of Scanfibre can be seen in Table 3.8 below.

Table 3.8 Concrete bending strength 28 days

No	Scanfibre Percentage	Strong Pressure Value Press	
		(MPa)	% Against Normal Concrete
1	0%	4.63	100.00
2	0.10	4.65	100,59
3	0.20	4.66	100.63
4	0.30	4.64	100.35
5	0.40	4.71	101.85
6	0.60	4.32	93.40
7	0.80	4.34	93.90
8	1.00	4.16	89.89

Based on the data in Table 3.8 above shows that the flexural strength of concrete at 28 days without added Scanfibre is 4.63 MPa. In the addition of Scanfibre of 0.1%, the increase of bending strength by 0.59%, in the addition of Scanfibre of 0.2%, increased the bending strength by 0.63%, the addition of Scanfibre of 0.3% Bending of 0.35%, in addition of Scanfibre of 0.4%, increased bending strength by 1.85%, Scanfibre addition by 0.6%, a decrease in bending strength by 6.60%, Scanfibre fiber addition of 0, 8% there was a decrease in the flexural strength of 6.10%, and the addition

of Scanfibre by 1.0% occurred a 10.11% reduction in the bending strength when compared with the flexural strength value of the concrete mixture without the addition of Scanfibre.

c. Concrete bending strength 56 Days

The test is done at the age of 56 days. The result data of the concrete bending strength of the concrete with the addition of Scanfibre can be seen in Table 3.9 below.

Table 3.9 Concrete bending strength 56 days

No	Scanfibre Percentage	Concrete bending strength 56 days	
		(MPa)	% Against Normal Concrete
1	0%	4.71	100.00
2	0.10	4.39	93.05
3	0.20	4.48	95.06
4	0.30	4.55	96,57
5	0.40	4.63	98.15
6	0.60	4.75	100.67
7	0.80	4.73	100.39
8	1.00	4.72	100.21

Based on the data in Table 3.9 above shows that the flexural strength of concrete at age 56 days without added Scanfibre is 4.71 MPa. In the addition of Scanfibre of 0.1% there was a decrease in the bending strength of 6.95%, in addition of Scanfibre of 0.2%, a decrease in the bending strength of 4.94%, in the addition of Scanfibre of 0.3% Bending of 3.43%, in addition of Scanfibre of 0.4%, a decrease in the bending strength of 1.85%, the addition of Scanfibre by 0.6%, the increase in the bending strength by 0.67%, the addition of

Scanfibre of 0, 8% there was a decrease in the flexural strength of 0.39%, and the addition of Scanfibre by 1.0% was increased in bending strength by 0.21% when compared to the flexural strength of the concrete mixture without the addition of Scanfibre.

d. Relationship between Concrete Bending Strength and Concrete Age
The relationship between concrete bending strength and concrete life can be seen in graph 3.2 below

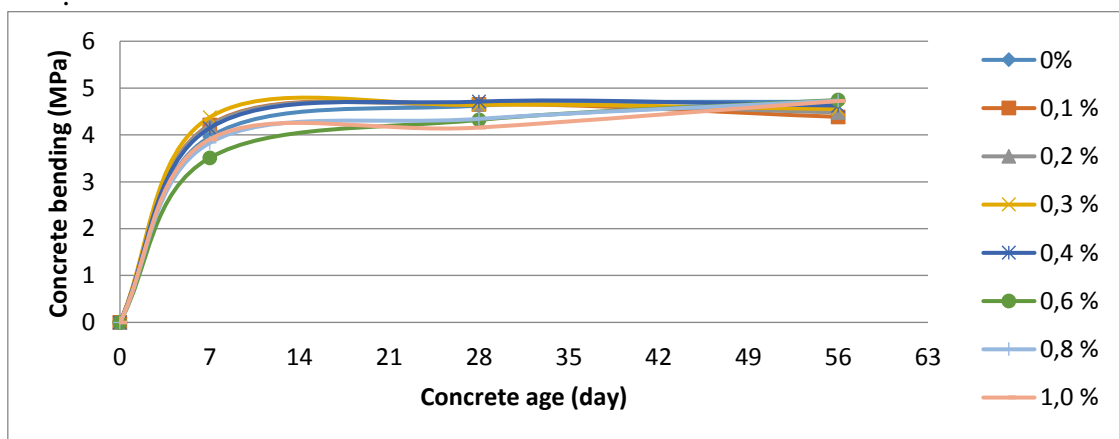

Figure 3.2 Graph Relation of Bending and Concrete Age

e. Strong Comparison Concrete Bending Age of 7 Days, 28 Days, and 56 Days

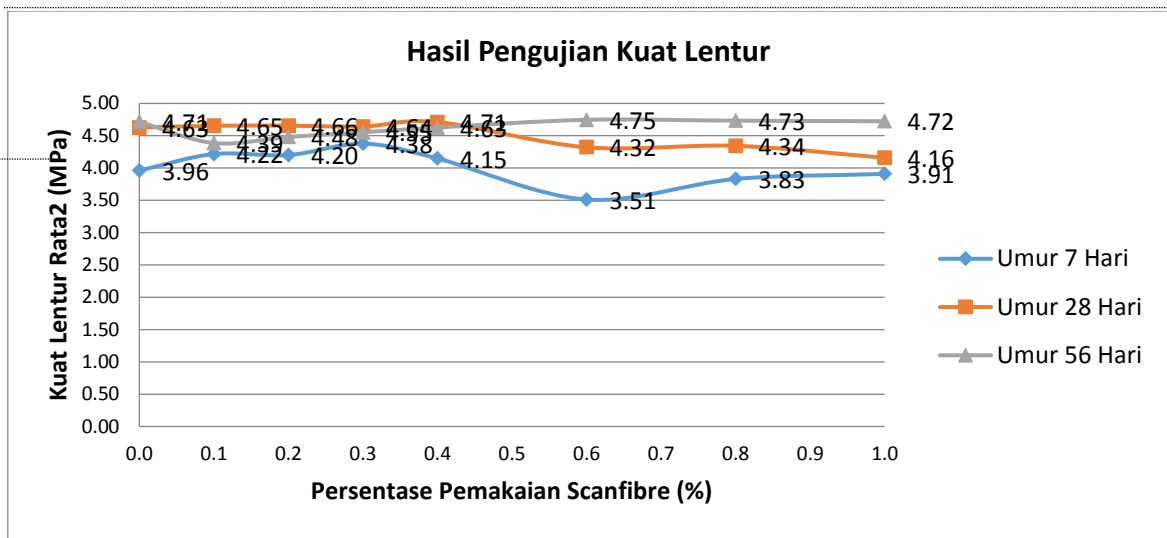

Figure 3.3 Comparison of concrete bending age 7 Days, 28 days, and 56 Days

Based on Figure 4.10 above shows that the average strength of concrete bending at the age of 7 days without lower than the compressive strength of the average concrete at the age of 28 days and 56 days. The average strength of concrete bending at the age of 28 days is lower than the average concrete compressive strength at the age of 56 days.

3.3 Discussion

1. The Effect of Adding Scanfibre in Concrete Mixes to Mechanical Properties of Concrete

The mechanical properties of concrete are concrete compressive strength and concrete bending strength is strongly influenced by concrete material (Mulyono, 2003).

Table 3.10 The Relationship between f_c & f_s

No	Use Scanfibre	Compressive Strength (f_c) (MPa)	Strong Bending (f_s) (MPa)	The relationship between f_s and
1.	0.0%	31.25	3.96	0.7085
2.	0.1%	31.93	4.22	0.7461
3.	0.2%	28.93	4.20	0.7811
4.	0.3%	30.84	4.38	0.7881
5.	0.4%	28.25	4.15	0.7805
6.	0.6%	27.98	3.51	0.664
7.	0.8%	28.11	3.83	0.7225
8.	1.0%	32.48	3.91	0.686

Table 3.10 The Relationship between f_c & f_s use of Scanfibre as an added ingredient in concrete mixture has no significant effect, either on the compressive strength of the

concrete or the strong bending of concrete. As mentioned earlier, In the addition of scanfibre of 0.1%, 0.3%, 0.4%, and 1.0% of concrete compressive strength

when compared with concrete compressive strength without Scanfibre fiber addition. In addition of Scanfibre 0.2%, 0.6%, 0.8% there was a decrease in the compressive

strength of concrete when compared to the compressive strength of the concrete without the addition of Scanfibre.

2. Relation Between f_c and f_s

No	Use Scanfibre	Compressive Strength (f_c) (MPa)	Strong Bending (f_s)(MPa)	The relationship between f_s and
1.	0.0%	35.07	4.63	0.7812
2.	0.1%	38.49	4.65	0.7501
3.	0.2%	31.73	4.66	0.8265
4.	0.3%	38.90	4.64	0.7444
5.	0.4%	35.48	4.71	0.7910
6.	0.6%	34.39	4.32	0.7368
7.	0.8%	29.48	4.34	0.8001
8.	1.0%	33.44	4.16	0.7192

From the calculation of compressive strength data and bending strength with variation of Scanfibre addition obtained a relationship between the flexural strength (F_s), and the root of compressive strength (F_c) concrete.

- a. Relationship Between Compressive Strength and Bending Strength Concrete at the age of 7 days
The calculation of the relationship between compressive strength and strength of concrete bending for the age of 7 days can be seen in the following table 4.10
Table 3.10 Relationship Between Compressive Strength and Bending Strength Concrete
From the correlation table between the compressive strength and the bending strengths above, then the average value of constant constants is 0.7345. This result is close to the value of the existing constants for the concrete using the broken aggregate is 0.75.
- b. Relationship Between Compressive Strength and Strong Bending Concrete at 28 days

The calculation of the relationship between compressive strength and strength of concrete bending for the age of 28 days can be seen in the following table 4.11.

From the correlation table between the compressive strength and bending strengths above, the average value of constant constants is 0.7687. This result is close to the value of the existing constants for the concrete using the broken aggregate is 0.75.

- c. Relationship Between Compressive Strength and flexural Strength Concrete at age 56 days
Calculation of the relationship between compressive strength and flexural strength for the age of 56 days can be seen in the following table 3.12.

Table 3.12 The Relationship between f_c & f_s

No	Use Scanfibre	Compressive Strength (f_c) (MPa)	Flexure strength (f_s) (MPa)	The relationship between f_s and
1.	0.0%	37.39	4.71	0.7710
2.	0.1%	38.35	4.39	0.7084
3.	0.2%	36.30	4.48	0.7438
4.	0.3%	45.45	4.55	0.6754
5.	0.4%	43.40	4.63	0.7024
6.	0.6%	41.22	4.75	0.7393
7.	0.8%	31.95	4.73	0.8373
8.	1.0%	40.12	4.72	0.7458

From the correlation table between the compressive strength and bending strengths above, the average value of constant constants is 0.7404. This result is close to the value of the existing constants for the concrete using the broken aggregate is 0.75.

3. Forms of Collapse Test

a. Forms of Test Material Collapse

The failure or collapse that occurred in the compressive strength testing occurs at the *interface zone* (zone between the surface) is the contact area between the cement paste to aggregate, where the bond is not perfect and not because of the outbreak of the aggregate. In mechanisms explored collapse press can also be seen that the pattern collapse occurs forming longitudinal pattern down, it is in accordance with the pattern of the concrete collapse in general. The pattern collapse occurs in all age concrete testing, both at the age of 7 days, 28 days and 56 days.

b. The collapse of the test specimen after testing the flexural strength

The collapse of the test specimen after testing the flexural strength can be seen in the picture below.

From the picture that be observed that the flexural testing largely collapse occurs also in the *interface zone* (zone between the surface). In flexural testing of concrete by

adding scanfibre seen that fiber scanfibre used as a mixture is not broken. This proves that the bond between the cement paste scanfibre not perfect. So therefore, the failure or collapse that occurred can be categorized by the collapse *over reinforced* with the understanding that no significant fiber function. This condition is also not ideal as the condition that occurs in over reinforced concrete slabs, because the *over-reinforced* conditions constantly while on this study only scanfibre are discontinuous.

4. CONCLUSION

Of all the tests and observations on concrete mix with the addition of Scanfibre be concluded as follows:

1. The use of Scanfibre in various levels is not a significant difference in the compressive strength of concrete. These results are in line with the analysis carried out at the age of 7, 28, and 56 days.

2. The average value of the flexural strength of concrete at 28 days 4,16 - 4,71 Mpa. From these results it can be concluded that there is no real difference between the flexural strength of the test specimen with the addition of Scanfibre.

Based on the formula of $f_s = K (f'c)^{0.5}$, an association between the compressive

strength and flexural strength at the age of 7, 28 and 56 days , then obtained a constant value (K) of the average is 0.7345, 0.7687, and 0 , 7404 .

REFERENCES

- Ariatama, A ,. (2007), "Effect of Fiber Wire Hooked On High Quality Concrete Strength v Based Fiber Diameter Optimasai", Diponegoro University, Semarang 2007.
- National Standardization Agency. 2008. *ISO 1969: 2008, Test Method Density and Water Absorption of Aggregate Coarse*. Bandung. National Standardization Agency. 2008. *ISO 1970: 2008, Test Method Density and Water Absorption of Aggregate Fine*. Bandung. National Standardization Agency. 2008. *ISO 2417: 2008, Test Method Wear of Aggregate With Los Angeles Abrasion Machine*. Bandung.
- Department of Public Works (2012), "General Specifications of Highways 2010 revision 3 ", the Public Works Department of Highways, Jakarta, in 2012.
- Dwicahyani, A ,. (2012), "Comparison of Compressive Strength and Strong Concrete Bending Machine Iron Against Waste Fiber Concrete Fiber Fabrication", Faculty of Engineering Department of Civil Engineering Universitas Sebelas Maret, Surakarta, 2012.
- Fiorentino, A ,. (2014), "The Influence of Utilization of Sand River Takuana With Addition of Waste Fiber Wire Bending Strong Against Concrete", Department of Civil Engineering Faculty of Engineering, University of Lancang Kuning, Pekanbaru, 2014.
- Gunawan, A ,. (2014), "Review of Compressive Strength, Strong Pull Shopping And Strong Flexible Concrete Using Tras Sand Jatiyoso As Substitute For Rigid Pavement (*Rigid Pavement*) ", Department of Civil Engineering Faculty of Engineering, Universitas Muhammadiyah Surakarta, 2014.
- Mustari, MI ,. (2011) , "Study of Concrete On Bending strength Rigid Pavement With Fiber Additions Fiberglass In Concrete Normal " , Article ILTEK, Volume 6, Number 12, 2011.
- Soroushian, P., and bayasi., Z., 1987, "*Concept of Fiber Reinforced Concrete*", Proceedings of the International Seminar on Fiber Reinforced Concrete, Michigan State University, Michigan, USA .
- Suhendro, B., 1991, Effect of Fiber Wire On Qualities Concrete, Seminar Mechanics of Materials in Various Aspects, Yogyakarta
- Tampubolon, H ,. (2014), "The Effect of Copper Cable Additions Against Waste Concrete Compressive Strength", Department of Civil Faculty of Engineering, University of Lancang Kuning, Pekanbaru, 2014.
- Tjokrodinuljo, K., 1996, "Concrete Technology", Publisher Naviri, Yogyakarta.
- Wiyono, S ,. (2009), "Materials and Material Path "Lecture Material Properties and Road Construction Materials in Civil Engineering Graduate Islamic University of Riau, Pekanbaru 2009.

ENERGY RESOURCE DEVELOPMENT STRATEGY AT INDRAGIRI HULU REGENCY RIAU PROVINCE

Muhammad Ariyon

*Department of Petroleum Engineering, Faculty of Engineering, Universitas Islam Riau
Jl. Kaharuddin Nasution, Marpoyan, Pekanbaru 28284
Riau, Indonesia*

Email : ariyon_pku@yahoo.com

Abstract

Indragiri Hulu Regency is blessed with great and varied natural resource riches, such as crude oil, coal, palm oil, sunlight, and peat. The many types of natural resources have become the support for development at Indragiri Hulu Regency for the purpose of reaching the well-being of the people. The use of the entire natural resources should be carried out as optimally as possible without reducing or eliminating the opportunity on the use of one or more types of resources. Therefore, a study on the strategy and priority on the use of energy resources should be conducted so that the conflict of land use due to the existence of more than one type of resource potentials may be avoided. The study of the priority on the use of energy resource was conducted on the framework of synchronizing policies between each sector of natural resource management, in order to come in contact with the relationship between each energy resource and fulfilling the principle of justification, continuity, optimality and environmentally friendly aspect. In principle, all of the resources should be able to be used as optimally as possible for much of the people's welfare and the acceleration of sustainable development of Indragiri Hulu. At present, only the wealth of energy resources that may be relied upon for improving the economy of Indragiri Hulu Regency in the future. With the presence of priority saving in funding, time and workforce necessary may be realized. Besides that, it may increase efficiency in terms of resource allocation. The priority usage of energy resource industry may also be considered as a guarantee for the investor candidates to invest safely in Indragiri Hulu Regency. The research provided the strategy and priority on the use of energy resources at Indragiri Hulu Regency. Priority was drawn from the judgement of competent people various in the management of natural resources using the method of Analytical Hierarchy Process (AHP). It also used SWOT analysis to formulate policy of energy resource development as research support method. Economic, environmental and technical aspects are the main factors which are used in AHP method. The main factors were divided into criteria and sub criteria which could represent the characteristics of each energy resource. Dominant energy resources as alternatives are crude oil, coal, oil palm plantation, sunlight and peat. The result of analysis shows that coal has the highest priority, whereas the priority of oil palm plantation, crude oil, sunlight, peat is second, third, fourth and fifth respectively. The development of Indragiri Hulu Regency as a reliable region aimed toward the region of Batam and to the area of Indonesia, Malaysia and Singapore Growth Triangle, demands great attention from the planners and executors of development. It is expected that the study may become an input for regional government in formulating strategies in the use of energy resources for sustainable development at Indragiri Hulu Regency.

Keywords: *energy resource, Analytical Hierarchy Process, Strategy, Priority, SWOT*

1. INTRODUCTION

This study goes from the often thought of a conflict of interest between each sector of natural resource and energy management.

Laws on the management of natural resources and energy work sectorally. Each type of natural resources and energy has its own laws, such as Law No. 44 of 1960 on Oil and Natural Gas which is then replaced by Law No. 22 of 2001, Law no. 11 of 1967 on Mining Principles, Law No. 5 of 1967 on the updated Forestry Principle No. 41 of 1999 on Forestry, Maritime Law, Geothermal Law, Fisheries Act (in the Draft Law) and so on . All of these Act are derivatives of the constitution by adopting a sectoral approach. This approach by itself does not touch the relationship between any kind of natural resources and energy. Therefore, overlaps can not be avoided. With the overlap, hopes to accelerate development are constrained.

Therefore, it is necessary to conduct a cross-sectoral assessment. If more than one natural and energy resource exists in one location then a priority assessment of natural resource and energy utilization should be undertaken. The overall utilization of natural resources and energy must be optimized without reducing or eliminating the opportunity to utilize one or more types of resources.

The priority determination of natural resources and energy will be faced with various complexities involving many aspects, such as economic aspects, social aspects, environmental aspects, technical aspects, and other aspects. For complex problem solving this requires a methodology of decision-making models that use methodological instruments that can accommodate multicomplex problems with so many related parties that each have different perceptions and interests. Based on the above reasoning, it is expected that AHP and SWOT Analysis methods can fulfill the applicative objectives as

supporting decision-making models in decision-making policy of prioritizing the utilization of natural resources in Indragiri Hulu Regency by accommodating all the interests of decision makers.

OBJECTIVE

- a) Identify the potential of energy resources in Indragiri Hulu Regency
- b) Prepare priority level of energy resource development in Indragiri Hulu Regency.
- c) Formulate energy resource development strategy in Indragiri Hulu Regency

2. METHODOLOGY

1. Identification of potential energy resources in Indragiri Hulu Regency.

The identification of energy resources is done using quantitative descriptive method where the collected data is calculated to obtain new amount or value, such as the amount of infrastructure, the area of oil palm plantation. Then the results of the analysis are explained back descriptively with the aim of identifying potential energy resources developed in Indragiri Hulu Regency.

2. Prepare priority level of energy resource development in Indragiri Hulu.

In the stage of preparing the priority level of energy resources development in Indragiri Hulu Regency using quantitative-qualitative descriptive methods, including sampling activities using analytical hierarchy process (AHP) questionnaire distributed to various departments related to this research, then questionnaires that have been disseminated to various offices is an input for the AHP analysis using expert choice software, processed to obtain values that describe the priority level of potential energy resources developed in

Indragiri Hulu Regency and then explained back descriptively.

3. Formulate efforts or strategies for developing energy resources in Indragiri Hulu.

In this effort to arrange energy development strategy or strategy in Indragiri Hulu Regency using descriptive method, based on local government policy then adjust to the preparation of priority level of

utilization and development of energy resources in Indragiri Hulu Regency for sustainable development.

3. RESULT AND DISCUSSIONS

1. Identification of Energy Resource Potential in Indragiri Hulu Regency

Results of identification of potential energy resources in Indragiri Hulu District as shown in Figure 1 and Table 1 below.

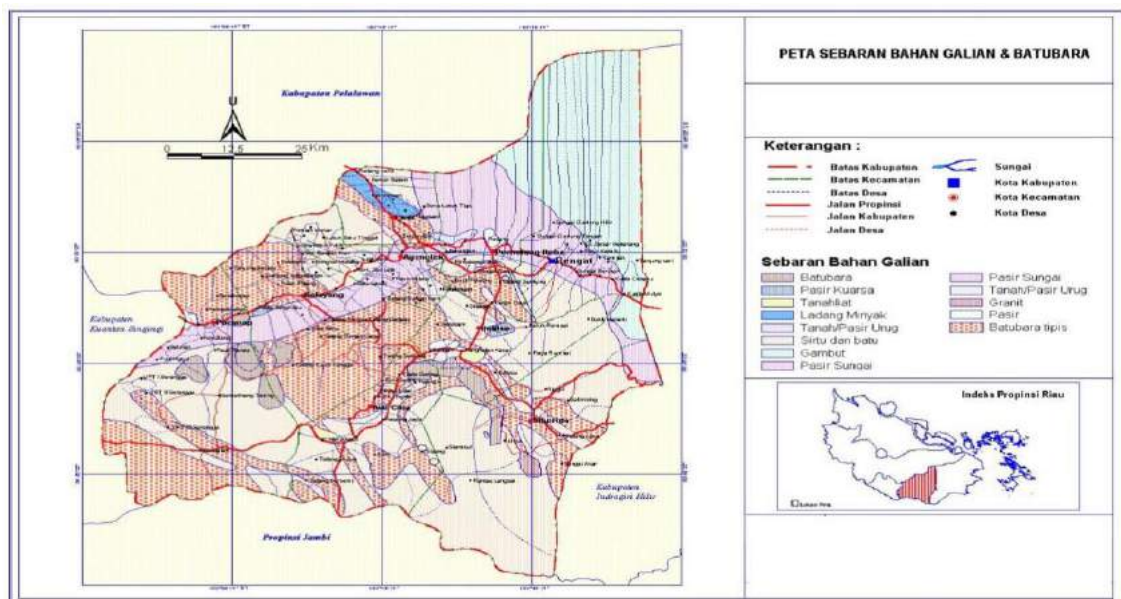

Picture 1 Map Distribution of Energy Resources of Indragiri Hulu Regency

Table 1 Potential of Energy Resources in Indragiri Hulu

No	Energy Resources	Information
1	Coal	Reserves: 392,302,048 tons (96% Riau coal); Calories: 5100 - 7100 Kcal; located in Peranap and Siberida Subdistricts
2	Crude oil	Lifting Minyak Earth 2015 by 18,969,324.91 bbls (2015); located in Lirik district
3	Palm Oil Waste	Production Capacity = 1.005 ton-tbs / hour; Potential Pome / day = 12.663 / day (ton). There are almost all of Indragiri Hulu Regency
4	Sunlight	All areas in Indragiri Hulu Regency get enough sunlight to be used as a source of solar energy
5	Peat	Peat area 375,067 Ha is located in Kuala Cenaku Subdistrict

2. Energy Resources Development Priority in Indragiri Hulu Regency

A. Structure of Hierarchy in the Development of Energy Resources

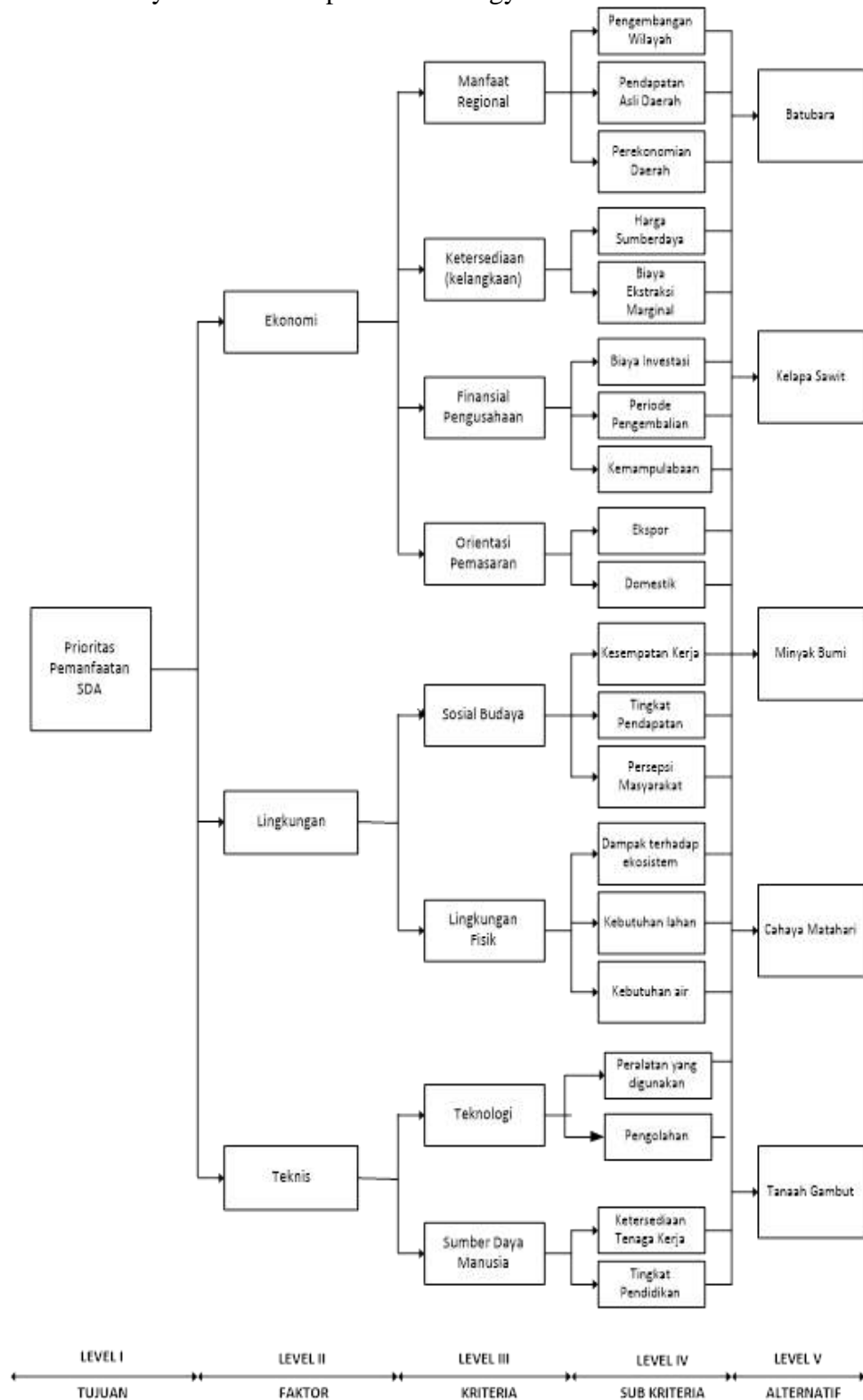

Picture 2. Structure of the Hierarchy in the Development of Energy Resources

b. Selection of Respondents

The resource persons are experts on the utilization of natural resources and energy in integrated systems (integrated and comprehensive - macro and micro conditions) whether practitioners, academics, or bureaucrats. Respondents in this study were 28 people, among others: from Department of local government Indragiri Hulu Regency, Bhdalda Indragiri Hulu Regency, Bawasda Indragiri Hulu Regency, Mining and Energy Office of Riau Province and Indragiri Hulu Regency, Fishery and Marine Office of Riau Province, Department of Food Crops of Holtikultura and Fisheries Regency of Indragiri Hulu, Regional Revenue Service of Indragiri Hulu Regency,

Industry and Cooperative Office of Indragiri Hulu Regency, and Association of young entrepreneurs Riau and Academics. The selection of respondents is based on the consideration that their level of recognition and expertise on the priority assessment of the utilization of natural resources and energy for sustainable development in Indragiri Hulu is considered to answer / solve this problem. Assessment by the respondents is based on the ability of perceptions, reasoning, insight and instinct that relies on their experience in development in Indragiri Hulu on an ongoing basis.

a. Pengolahan Data AHP

1. Penentuan Bobot Faktor Utama Terhadap *Goal*

Tabel 2 Bobot Faktor Utama Terhadap Goal

No	Factor	Weight		Ranking
		Local	Global	
1.	Economy	0.363	0.363	2
2.	Environment	0.398	0.398	1
3.	Technical	0.239	0.239	3
	TOTAL	1	1	
	Inconsistency Ratio = 0.00			

2. Determination of Criteria Weight and Sub Criteria

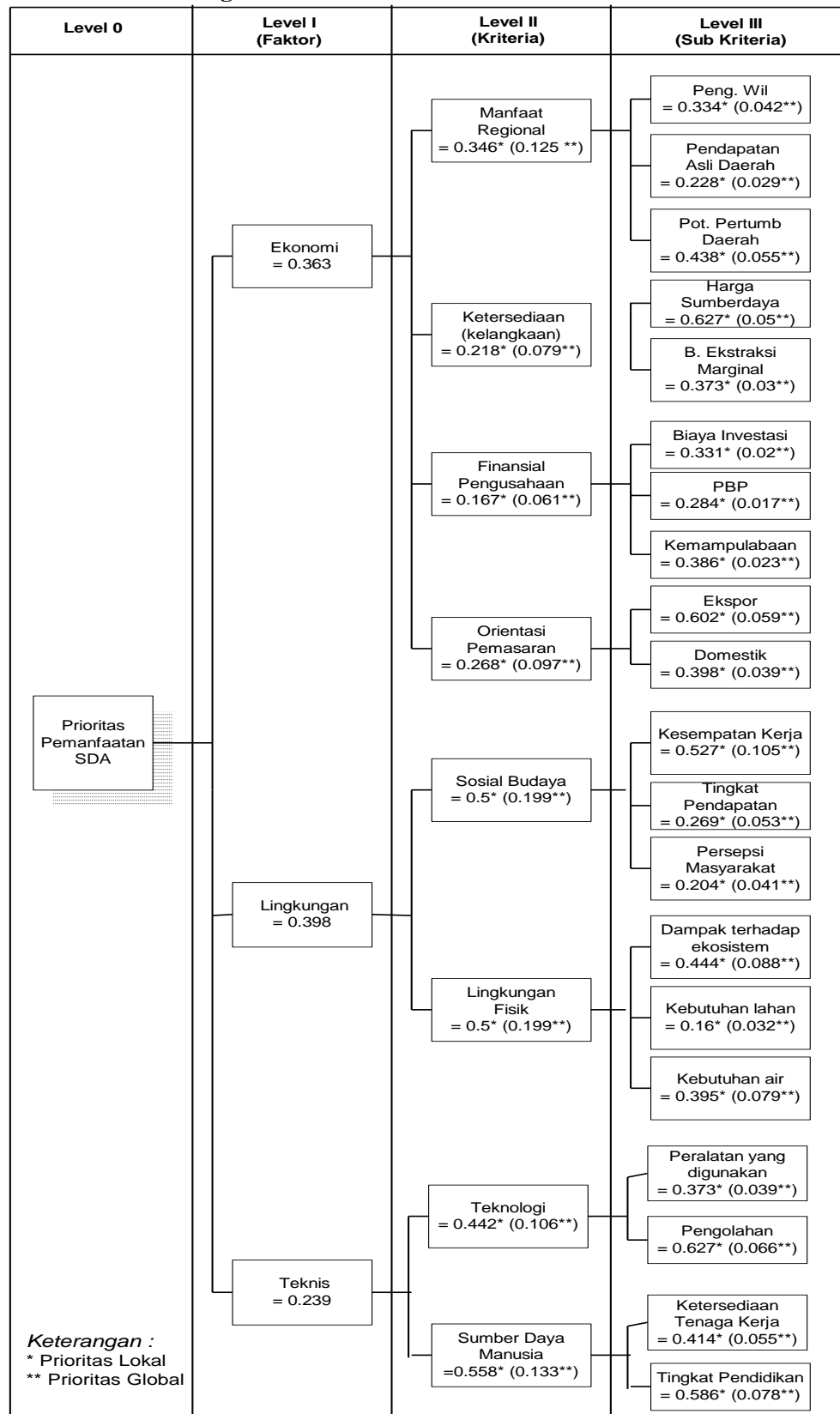

Keterangan :
 * Prioritas Lokal
 ** Prioritas Global

Picture 3 Local Priorities and Global Factors, Criteria and Sub Criteria

Determination of SDAE Alternative Weight

Table 3 Local Priorities and Alternative Global SDAE

Weight Sub Criteria	Alternative Local Weight of SDAE Alternative Natural Weight of SDAE					Alternative Local Weight of SDAE Alternative Natural Weight of SDAE				
	A	B	C	D	E	A	B	C	D	E
Area Development	.253	.229	.213	.139	.166	.011	.010	.009	.006	.007
Economic growth	.283	.269	.157	.168	.122	.016	.015	.009	.009	.007
Potential PAD	.297	.026	.134	.187	.114	.008	.008	.004	.005	.003
Resource Price	.344	.232	.141	.166	.116	.017	.012	.007	.008	.006
B. Marginal Extraction	.400	.207	.126	.159	.108	.012	.006	.004	.005	.003
Investment Cost	.111	.151	.286	.147	.305	.002	.003	.006	.003	.006
Pay Back Period	.125	.129	.300	.124	.323	.002	.002	.005	.002	.006
Profit (Profit)	.366	.246	.108	.175	.105	.009	.006	.003	.004	.002
Export Market	.303	.298	.105	.195	.099	.018	.017	.006	.011	.006
Domestic Market	.140	.148	.271	.155	.285	.005	.006	.011	.006	.011
Employment Opportunity	.197	.288	.225	.140	.150	.021	.030	.024	.015	.016
Degree of Pendaptan	.334	.292	.117	.158	.099	.018	.016	.006	.008	.005
Public Perception	.228	.300	.185	.147	.140	.009	.012	.008	.006	.006
Ecosystem Impacts	.098	.133	.307	.119	.343	.009	.012	.027	.010	.030
Land requirements	.292	.102	.184	.120	.303	.009	.003	.006	.004	.010
Water Requirement	.379	.132	.138	.224	.129	.030	.010	.011	.018	.010
Tool	.371	.243	.120	.168	.098	.015	.010	.005	.007	.004
Processing Technology	.301	.322	.143	.128	.107	.020	.021	.009	.008	.007
Availability of Manpower	.174	.153	.271	.184	.217	.010	.008	.015 e	.010	.012
Level of education	.113	.218	.254	.130	.285	.009	.017	.002	.010	.022
Total Alternative Global Weight of SDAE						.242	.233	.191	.179	.155

3. SDAE Priority Determination

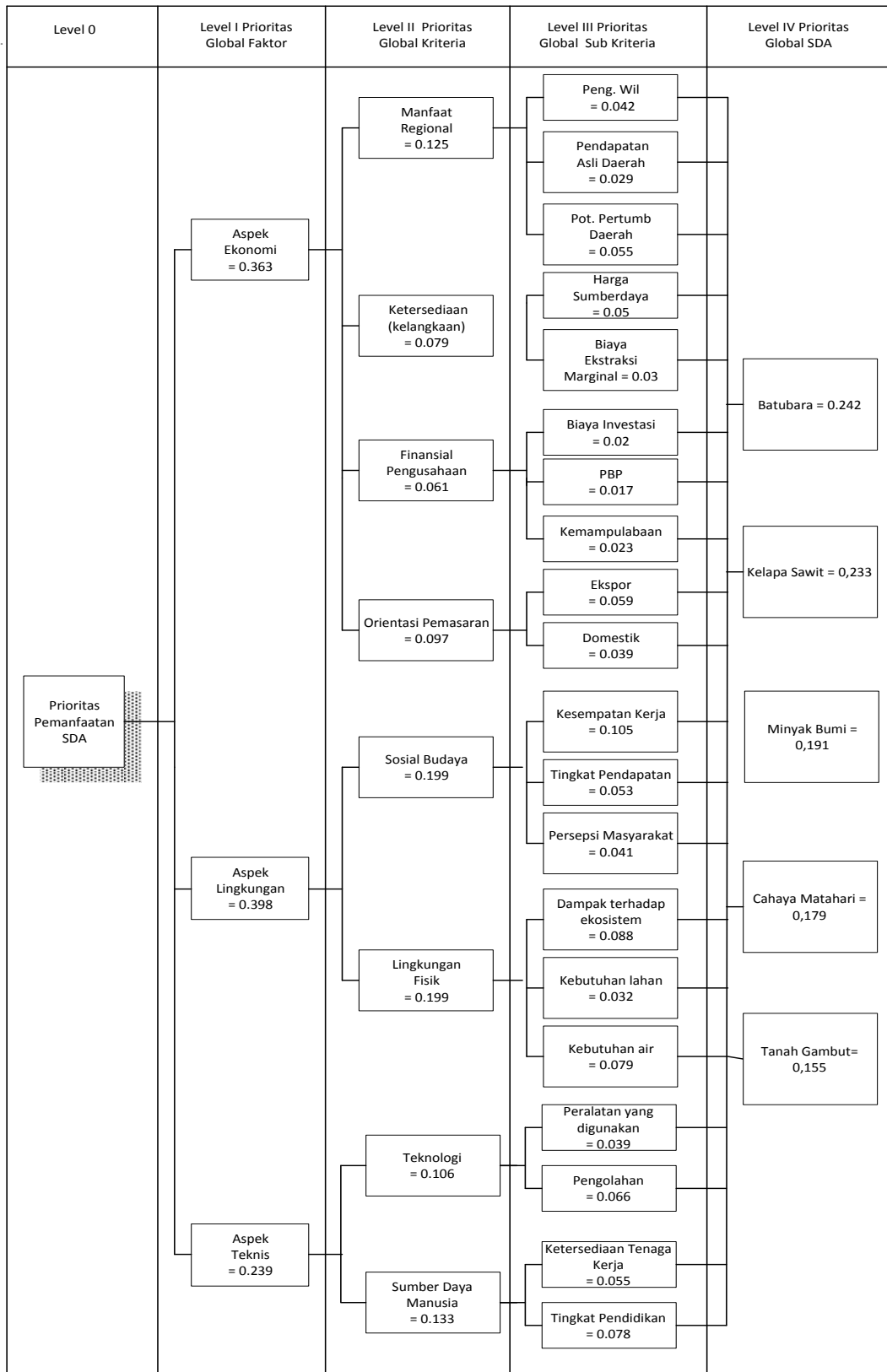

Picture 4 Priority of SDAE Utilization for Sustainable Development in Indragiri Hulu

Table 4 Weight (likelihood total) and Inter-Alternative Priority Utilization Natural resources and energy

Alternative	Weight	Priority Order
Coal	0.242	1
Palm Oil Waste	0.233	2
Crude oil	0.191	3
Sunlight	0.179	4
Peat	0.155	5
Inconsistency Ratio = 0.00		

3. Strategy of Development of Energy Resources in Indragiri Hulu Regency

Strength (S)

- 1) the potential of energy resources in Indragiri Hulu Regency both renewable and non-renewable are very large, such as petroleum, coal, biomass, peat, and sunlight
- 2) Has experience and infrastructure in the process of exploiting and processing petroleum energy resources
- 3) Coal potential is spread in Indragiri Hulu Regency with large reserves (96% of coal in Riau Province is in Indragiri Hulu Regency).
- 4) The extent of agricultural land and plantations in Indragiri Hulu Regency is a source for biomass development
- 5) Geographical position of Indragiri Hulu Regency is strategic
- 6) the area of Indragiri Hulu Regency that is still sufficient in the development of energy resources

Weakness(W)

- 1) not all energy resources can be exploited because of their varying quality and quantity

- 2) infrastructure that is not sufficient to support the energy resources development
- 3) Declining oil and gas production
- 4) The absence of standards that support the process of developing energy resources from the beginning of the process to the public
- 5) Inadequate transportation routes
- 6) KThe quality of human resources is still low
- 7) BSome energy resources can produce pollution in the processing process.

Opportunity (O)

- 1) Support from the Minister of ESDM through the National Energy Policy (KEN) and National Energy Management (PEN)
- 2) Indonesia is a potential investment land
- 3) Renewable energy sources can reach remote areas
- 4) Subregional economic cooperation
- 5) The opening of coordination of energy management at district / city, provincial, central and ASEAN level
- 6) Preduction of fuel subsidies

Threat (T)

- 1) degradation of environmental quality
- 2) Land conflicts with the community higher energy consumption
- 3) the energy purchasing power of consumers is still low
- 4) the uncertainty of investment law

Therefore, based on the results of the analysis that has been conducted and based on the priority objectives of energy resources development in Indragiri Hulu Regency, the effort to develop energy resources is described below:

1. Development of energy resources in Indragiri Hulu Regency that is environmentally and sustainably
2. Optimization and control in the development of energy resources both existing and which will be developed
3. The development of basic infrastructure that supports the development of energy resources
4. Research and training of human resources based on the development of energy resources
5. Preparation of a clear legal framework of energy resources development in Indragiri Hulu Regency
6. Improved technology used in the development and utilization of energy resources
7. Increasing the efficiency of existing fossil energy resources
8. Increased utilization of new renewable energy resources and alternative energy
9. Development of electric energy generation by using the potential of energy resources in Indragiri Hulu Regency
10. Improved access and equity of population services to energy

11. Community empowerment in the development of energy resources
12. The partnership of Indragiri Hulu Regency government with the business world in developing energy resources

5. CONCLUSION

1. Potential of energy resources in Indragiri Hulu Regency are: Petroleum, Coal, Waste Palm (Biomass), Sunlight and Peat Land
2. Priority of energy resource development in Indragiri Hulu Regency based on weighting using AHP method is (1) Coal (0.242); (2) Palm Oil Waste (0.233); (3) Petroleum (0.191); Sunlight (0.179); Peatland (0.155)
3. Activity of utilization of energy resources needs to be handled professionally by keeping the principles of economics so that the government and local people can enjoy their natural wealth.
4. Should be done guidance and participation in the utilization of the SDE, by looking at the uniqueness and potential of each region combined with business activities as a whole.
5. To be able to compete in the era of globalization, the region needs to learn tactical and strategic actions to be ready later as a partner in the energy resource development industry

ACKNOWLEDGEMENT

Thanks to the Research Institute of the Islamic University of Riau (LP UIR) which has provided financial support for research activities and also to the Government of Indragiri Hulu Regency which has given permission to conduct research as well as all sources of research

REFERENCES

- Bappeda dan Badan Pusat Statistik Kabupaten Indragiri Hulu, *Indragiri Hulu Dalam Angka 2015*, Pematang Reba, 2015
- Bappeda Provinsi Riau, *Neraca Sumber Daya Energi Provinsi Riau*, Pekanbaru, 2016
- Badan Promosi dan Investasi Provinsi Riau, *Riau Province Regional Profile and Investment Opportunities*, Pekanbaru, 2015
- Badan Penanaman Modal Daerah Kabupaten Indragiri Hulu, *Profil Investasi di Kabupaten Indragiri Hulu*, Pematang Reba, 2015
- Djajadiningrat, Surna T., M Suparmoko, M Ratnaningsih, *Natural Resource Accounting for Sustainable Development*, Ministry of Environment and EMDI, 1992
- Dunn, N. William., *Pengantar Analisis Kebijakan Publik*, Gadjah Mada University Press, Yogyakarta, 2000.
- Laporan Analisis Mengenai Dampak Lingkungan Rencana Penambangan Batubara Daerah Peranap, Kabupaten Indragiri Hulu*, PT Tambang Batubara Bukit Asam, 1999
- Laporan Studi Kelayakan Perkebunan Kelapa Sawit (Kebun Plasma Pola-KKPA)*, PT Perkebunan Nusantara V, Pekanbaru, 2012
- Pangaribuan Mangisi, *Studi Penentuan Prioritas Pengembangan Jenis Industri di Pulau Batam*, Tugas Akhir, Jurusan Planologi ITB, Bandung, 1992
- Saaty, L. Thomas., *Decision Making for Leaders – The Analytical Hierarchy Process for Decision in Complex World*, University of Pittsburgh, Pittsburgh, 1986
- Saaty, L. Thomas., dan Luis G. Vargas, *The Logic of Priorities*, Kluwer. Nijhoff Publishing, University of Pittsburgh, Pittsburgh, 1982
- Saaty, L. Thomas., *Decision Making With Dependence And Feedback The Analytic Network Process*, RWS Publications, Pittsburgh, 1996
- Sudradjat, Adjat., *Teknologi dan Manajemen Sumberdaya Mineral*, ITB, Bandung, 1999.
- Suryadi, Kadarsah., *Sistem Pendukung Keputusan*, Rosda, Bandung,
- Wiramsya Agus., *Penetapan Prioritas Penyediaan Energi Primer Komersial di Indonesia Berdasarkan Pendekatan AHP*, Tesis Magister ITB, 1999

GIVING *CHLORELLA SP* WITH DIFFERENT AMOUNT FOR DEVELOPMENT *MOINA SP*

Rosyadi¹, Agusnimar², Abdul Fatah Rasidi³

^{1,2,3} Faculty of Agriculture, Universitas Islam Riau
Jl. Kaharuddin Nasution, Marpoyan, Pekanbaru 28284
Riau, Indonesia

Email: rosyadi@agr.uir.ac.id

Abstract

The study aimed to obtain the best amount of *Chlorella sp* for growth and breeding of *Moina sp*. The research was conducted in a natural food culture laboratory at Fish Seed Center Faculty of Agriculture Islamic University of Riau Pekanbaru. The test material used by *Moina sp* and as feed was used *Chlorella sp*. The research design used was a complete randomized design of one factor with four treatments and three repetitions. The amount of *Chlorella sp* used in each treatment was 75x10⁴ cells / L, 100x10⁴ cells / L, 125x10⁴ cells / L and 150x10⁴ cells / L. The result of the research showed that the highest density of *Moina sp* was 8,992 ind / L with *Chlorella sp* 150x10⁴ cell / mL, with peak population on day 14, and lowest density 1,942 ind / L on *Chlorella sp* 75x10⁴ cell / L, with peak population on the 12th day. The highest growth rate of *Moina sp* population in treatment of *Chlorella sp* as much as 150x10⁴ cells / L was 5.12 (ind.2x10⁻³xhari⁻¹), and the lowest value was 75x10⁴ cells / L of 3.58 (ind.2x10⁻³xday⁻¹). The water quality of culture media during the study was still supportive for the growth and breeding of *Moina sp*.

Keywords: *Chlorella sp*, Growth Rate, *Moina sp*

1. INTRODUCTION

Riau region has aquatic resources large enough to be developed as aquaculture business, both fish farming in ponds and cultivation in floating net bags (KJA). To meet the needs of such cultivation, fish seeds are required in quantity and quality and sustainable. The production of fish seed produced from government-managed fish stock (BBI) and from the community hatchery unit (UPR) is still low. This is due to the high mortality rate of larvae / fish seeds after the egg yolk has been exhausted. This

problem is caused by the unavailability of natural feed which suitable with age and size of fish mouth opening.

For larvae feed farmers usually use natural food type *Artemia sp*, which feed is not available in all places and the price is expensive. Therefore, there should be alternative natural feeds that fit the needs of fish larvae / seeds, such as Cladocera (water flea) type *Moina sp*.

Moina sp as a seed feed has advantages among others; *Moina sp* size is very suitable for the size of mouth opening of larvae / fish seeds, the nature of *Moina sp* that always move actively will attract the seed to

prey *Moina* sp. *Moina* sp has nutrient content consisting of 37,38% protein, fat 13,29%, and coarse 0,00%, ash 11,0% and water content 99,60% (Marine and Fishery Research Agency, 2006 in Wijayanti, 2010).

Moina sp belongs to the zooplankton group and if given to the larvae / seed the fish will provide the stimulation to eat it, because the organism has a slow movement. To grow *Moina* sp as feed of larvae / fish seed, first must be done culture of feed. In the waters of *Moina* sp food consists of herbs and detritus (the remnants of dissolved organic matter), among the plants are microalgae (*Chlorella* sp). By culturing *Chlorella* sp purely, it can be determined the amount of feed that will be required by *Moina* sp for its growth and proliferation.

The resulting *moina* spin can be used as alternative feed for *Tubifex* worms in the form of frozen or fresh, on the hatchery of Siamese catfish, jelawat, gurami and mas. In addition *Moina* sp fresh also used as a starter to grow natural feed in the pond. Thus *Moina* sp has an enormous opportunity to replace the *Tubifex* worm as a fish larvae feed (Rianasari, 2009).

Utilization of *Chlorella* sp as zooplankton food has been done by other researchers for the type of Rotifera (*Brachionus* sp). Hirayama et al., In Dahril (1996), states there are two types of algae namely *Synechococcus elongates* and *Chlorella* sp can be the best food for Rotifer. From his research the optimal cell density required for *Chlorella* sp type is 150×10^4 cells / ml. Then from the results of research conducted Hirayana and Ogawa (1972) in Dahril (1996), suggests that *Chlorella* sp with a density of 213×10^4 cells / ml in culture media, is the best density for Rotifer.

Referring to the study, researchers conducted the administration of *Chlorella* sp with different amounts for growth and breeding of *Moina* sp. The purpose of the study to determine the best results of different amounts of *Chlorella* sp for the growth and breeding of *Moina* sp. While the benefits of research make *Moina* sp as an alternative natural food for larvae / fish and shrimp seeds.

2. METHODOLOGY

The material used in this research is *Moina* sp, which comes from the pond around the fish seed hall of the Faculty of Agriculture of the Islamic University of Riau Perhentian Marpoyan Pekanbaru. Inokulum *Chlorella* sp from labor Dahril, liquid organic fertilizer from the composting process of central market waste Pekanbaru, chicken manure. As a culture medium of *Chlorella* sp and *Moina* sp, used mineral water (gallon) and drilling well water.

Tools used include shelves of culture of *Chlorella* sp and *Moina* sp, 5 liters of water gallon bottles, 5 liter plastic jars, aerators, aeration hoses, aeration stones, plankton net, measuring cups, petridish saucers, measuring pipettes, haemocytometers, lux glass, handy caunter, bucket, basin and binocular microscope with the equipment, 40 watt fluorescent lamps and a computer set.

To measure water quality parameters used equipment such as mercury thermometer to measure temperature, litmus paper to measure the degree of acidity (pH) of water, then spectrophotometer to measure the content of phosphor and nitrogen elements.

The design of the study was a complete randomized design (RAL) with four treatments and three repetitions, the four treatments were: (P1) *Chlorella* sp administration with amount of 75×10^4 cells / L, (P2) *Chlorella* sp giving 100×10^4 cells / L, (P3) Administration of *Chlorella* sp with the amount of 125×10^4 cells / L and (P4)

Administration of *Chlorella* sp with the amount of 150x10⁴ cells / L.

To calculate the number of *Chlorella* sp used haemocytometer, and calculate the population density of *Moina* sp is done water culture media retrieval by filtering by using scop net. Then taken 5 mL and so on again taken 1 mL and placed in a petridish plate. Then do the calculation by using handy counter, counting done as much as three times iteration. The value taken for the next analysis is the average value of each research container. The observation of *Moina* sp development is done every 2 days for 16 days. This is based on the length of life *Moina* sp can survive for 30 days (Mudjiman, 1985). Water quality parameters measured

include water temperature of culture media and acidity (pH) of water. Water quality measurement is done every 2 days during the research.

3. RESULT AND DISCUSSION

The growth of *Moina* sp

Observations made during the study on the growth and proliferation of *Moina* sp populations can be seen in Table 1.

Table 1. Average Increase of Number of Individuals *Moina* sp Population At Each Treatment During Research (ind / L)..

Day of Observation to-	Treatment (ind/L)			
	P1	P2	P3	P4
0	30	30	30	30
2	217	392	475	725
4	358	467	667	925
6	525	625	867	1225
8	850	1108	1392	1650
10	1225	2467*	1875	2292
12	1942*	1758	4442*	4958
14	783	925	1667	8992*
16	192	617	1083	2750

Description: (*): Peak population *Moina* sp

Table 1 shows the population increase of *Moina* sp, according to treatment and the day of observation of population increase is not the same. Then the density of *Moina* sp in each treatment, peak population on certain days, and then density will decrease.

At the peak phase, the proliferation of *Moina* sp occurs when feeding is in the form of *Chlorella* sp, in balance with the need for breeding of *Moina* sp. Then on maintenance the next day *Moina* sp density began to decline, as *Moina* sp began to experience death. In this phase of death the availability of food in the form

of *Chlorella* sp is not sufficient for the growth and breeding of *Moina* sp.

For the administration of *Chlorella* sp as much as 150x10⁴ cells / L, the increase in *Moina* sp density was faster than that of *Chlorella* sp as much as 125x10⁴ cells / L, as well as lower amount of administration. This is because if the availability of feed enough, then *Moina* sp will grow quickly. Radiopoetro (1983) in Zuhidah et al., (2012), says that in sufficient feed conditions, young *Daphnia* sp. (Juvenil) will grow and change skin to adult individuals and reproduce in parthenogenesis, resulting in the addition of individuals being several-fold.

For treatment of *Chlorella* sp as much as 75x10⁴ cells / L obtained peak population *Moina* sp on day-12 with density as much as 1942 ind / L. Then 100x10⁴ cells / L obtained peak population on day 10 with *Moina* sp density of 2467 ind / L, and 125x10⁴ cell / L obtained peak population on day 12 with density of *Moina* sp as much as 4442 ind / L, then for 150x10⁴ cell / L treatment obtained peak population on day 14 with density of *Moina* sp as much as 8992 ind / L.

The peak population of *Moina* sp in each treatment during the study, began to occur on days 10 to 14. This peak population can be caused by the number of feed given is not optimal. So for growth and breeding takes a relatively long time. Mudjiman (1985), explains that *Moina* sp well maintained will reach the peak of growth and breeding on day 8 and 9.

From Rosyadi's research (2005), by giving Plankton Catalyst the highest density of *Moina* sp at dose 15 mg / L, 2,232.6 ind / L and peak of *Moina* sp on 10th, and lowest dose 20 mg / L 970 ind / L with the peak of the population on the 12th day. Furthermore, Rosyadi (2013), adding with the provision of complete liquid organic fertilizer (POCL) ACI dose

of 1 ppm obtained density of *Moina* sp as much as 2,069.4 ind / L with peak population *Moina* sp on day 8.

When compared with the study of *Chlorella* sp, the population density of *Moina* sp was higher. This is caused by the application of Catalyst plankton fertilizer and liquid organic fertilizer Super ACI, a type of plankton that grows not one species and also can not be sure the type of plankton that grows and develops. So the type of feed needed by *Moina* sp has not been confirmed.

Then Muhasdika et al., (2015), in the study of bokashi fertilizer on household wastewater as culture medium, peak of *Moina* sp population occurred on day 8, with density of 13400 ind / L. While treatment without bokashi fertilizer, peak population *Moina* sp occurred on day-to-6, with a density of 4260 ind / L.

This can be due to the wastewater of many households containing the remains of organic matter (detritus) which is the food of *Moina* sp. According to Mudjiman (1985), *Moina* sp commonly lives in contaminated waters of organic matter, such as in ponds and swamps, many waters contain rotten wood and animal dung. To see the development of *Moina* sp is presented in Figure 1.

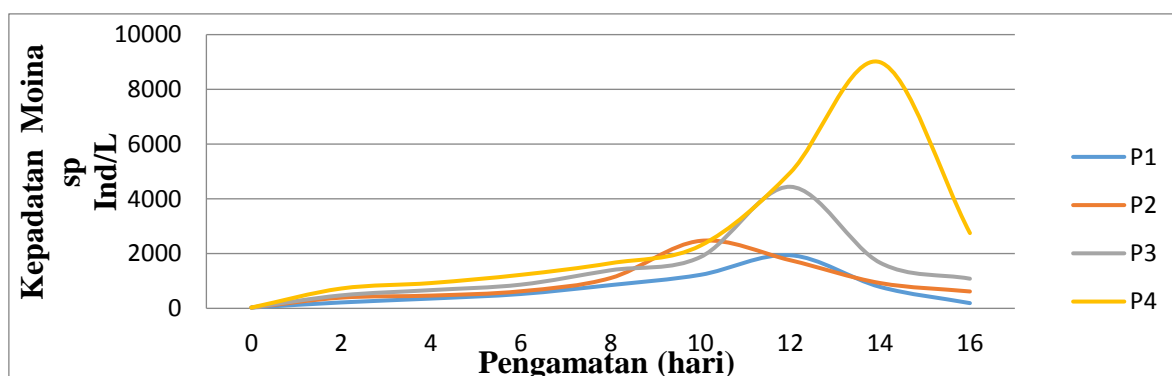

Figure 1. Average Graph of Increasing Number of Individuals *Moina* Population sp Every Treatment During Research (ind / L)

Figure 1 shows the growth graph of *Moina* sp on the 2nd day until the 8th day

is still low, at which time *Moina* sp is still in the adaptation phase or adjustment to the

environment. Then on the 10th day *Moina* sp showed faster growth. This indicates that *Moina* sp has been able to utilize *Chlorella* sp as optimal feed. Suwignyo et al., (2005), says the food of *Moina* sp is composed of phytoplankton, organic matter detritus (detritus), and small animals (zooplankton).

Next Hara (2007) in Rianasari (2009), *Moina* sp food in nature consists of phytoplankton, particles of organic matter, and bacteria. While Mudjiman (1985), said the type of food is good for its growth is bacteria and phytoplankton. Then Odum (1971), explains the fluctuations in population development can occur due to changes in the physical environment or interaction between individuals in getting food.

For the administration of *Chlorella* sp as much as 150×10^4 cells / L, there was a decrease in *Moina* sp density from 8,992 ind / L to 2,750 ind / L. In contrast to other treatments the decrease in population density of *Moina* sp is not dractically significant. Decreased *Moina* sp density, caused because *Moina* sp started to die.

Moina sp death due to the availability of *Chlorella* sp food is not proportional to the total population of *Moina* sp. Where as

the number of population of *Moina* sp increases, while the number of available *Chlorella* sp same in each treatment, so *Moina* sp began to experience death.

According to Purwantini (2009) in Darmawan (2014), the increase in population growth of *Daphnia* sp occurs because at the time before reaching the peak, the concentration of feed contained in the media is more than the maintenance requirement (the amount of feed that has no effect on growth) from *Daphnia* sp.

Furthermore, Noerdjito (2004) in Darmawan (2014), *Daphnia* sp growth pattern is influenced by several factors, such as physical condition of waters, feed type, and feed concentration. When these three factors are favorable, the growth rate of *Daphnia* sp will take place more rapidly and result in a higher population peak. Then Freshwater Cultivation Center (1984), *Daphnia* sp population decreases when available feed is not sufficient, this occurs due to competition of feed.

The result of variance analysis shows that the administration of *Chlorella* sp with different amounts gives a different effect. Further test results of BNT *Moina* density sp are presented in Table 2.

Table 2. Advanced BNT Test Results Population Density *Moina* sp

Treatment	Population density of <i>Moina</i> sp
P1 (<i>Chlorella</i> sp with total 75×10^4 sel/L)	191.66 b
P2 (<i>Chlorella</i> sp with total 100×10^4 sel/L)	616.66 b
P3 (<i>Chlorella</i> sp with total 125×10^4 sel/L)	1083.33 b
P4 (<i>Chlorella</i> sp with total 150×10^4 sel/L)	2750 a

Based on the results of further test of BNT density of *Moina* sp in the above table, showed that treatment of P4 gave very significant different result to treatment of P1, P2 and P3 at 99% confidence level.

To see the relationship between the number of maintenance days of *Moina* sp density during maintenance, can be explained by the regression equation in the graph of Fig. 2.

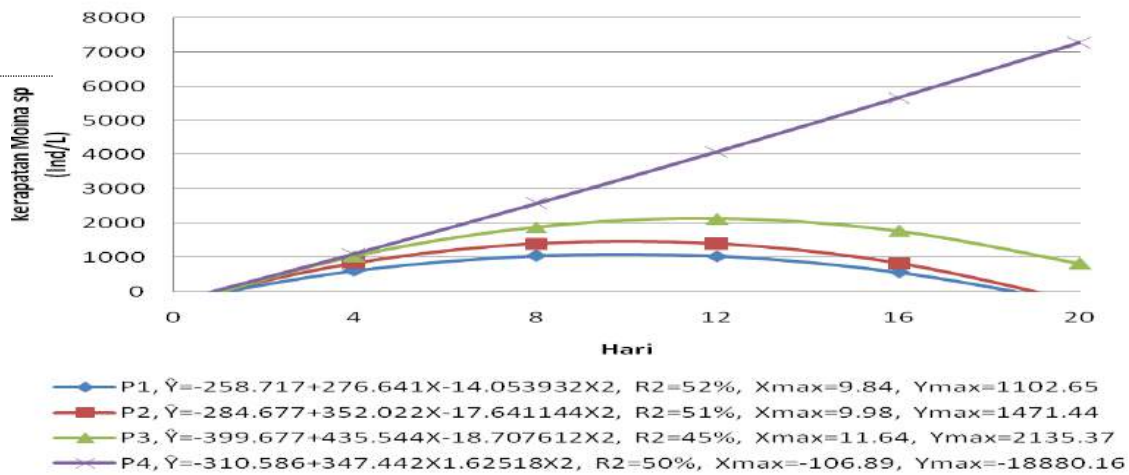

Figure 2. Graph of Relationship Between the Number of Days Maintenance Against Moina Density During Maintenance (ind / L)

FIG. 2 illustrates that, by administering *Chlorella* sp as much as 75×10^4 cells / L, the maximum density of *Moina* sp occurred after 9.84 days, for 100×10^4 cell / L of maximum density after 9.98 days and *Chlorella* sp 125×10^4 cell / L maximum density after 11.64 days. As for the provision of *Chlorella* sp 150×10^4

cells / L maximum density of *Moina* sp can occur after 106.89 days.

Population Growth Rate of *Moina* sp

From the result of data analysis of population increase of *Moina* sp, got population growth rate of *Moina* sp. To see data of population growth rate of *Moina* sp during observation is presented in Table 3.

Table 3. Mean Population Growth Rate of *Moina* sp of Each Treatment During the Study (ind. $\times 10^{-3}$ day $^{-1}$)

Day of Observation to-	Treatment / Growth Rate			
	P1	P2	P3	P4
2	0.99	1.28	1.38	1.59
4	0.62	0.69	0.78	0.86
6	0.48	0.51	0.56	0.62
8	0.42	0.45	0.48	0.50
10	0.37	0.44	0.41	0.43
12	0.35	0.34	0.42	0.43
14	0.23	0.24	0.29	0.41
16	0.12	0.19	0.22	0.28
Total	3.58	4.14	4.54	5.12
Mean	0.447	0.517	0.567	0.640

In Table 3 shows that during the observation of the rate of growth of the

Moina sp population at each treatment, the highest growth rate was observed on day 2.

However, on the same day observations, for treatment of *Chlorella* sp as much as 75×10^4 cells / L, population growth rate was lower when compared with the treatment of giving *Chlorella* sp with more number. This is because the availability of food for *Moina* sp is not sufficient for its growth rate.

According to Priyambodo (2004), in culturing *Moina* sp availability of feed is very decisive to the rate of population growth, if there is a lack of nutrients or nutrients in the media material can cause a decrease in the rate of growth. Cahyaningsih (2006) states that the growth of *Brachionus plicatilis* relies heavily on nutrients or elements of both

macro and micro nutrients contained in the culture medium.

Table 3 also shows that, overall, the rate of population growth of *Moina* sp at all treatments, decreased during observation time, which began on the 4th day until the 16th.

However, the results of the total population growth rate, showed different results from each treatment of *Chlorella* sp from lowest to highest (P1-P4). The highest population growth rate was obtained in the amount of *Chlorella* sp of 150×10^4 cells / L of $5.12 \text{ ind.} \times 2 \times 10^{-3} \times \text{days}^{-1}$, while the lowest was 75×10^4 cells / L of $3.58 \text{ ind.} \times 2 \times 10^{-3} \times \text{day}^{-1}$. More details of population growth rate of *Moina* sp can be seen in Figure 3.

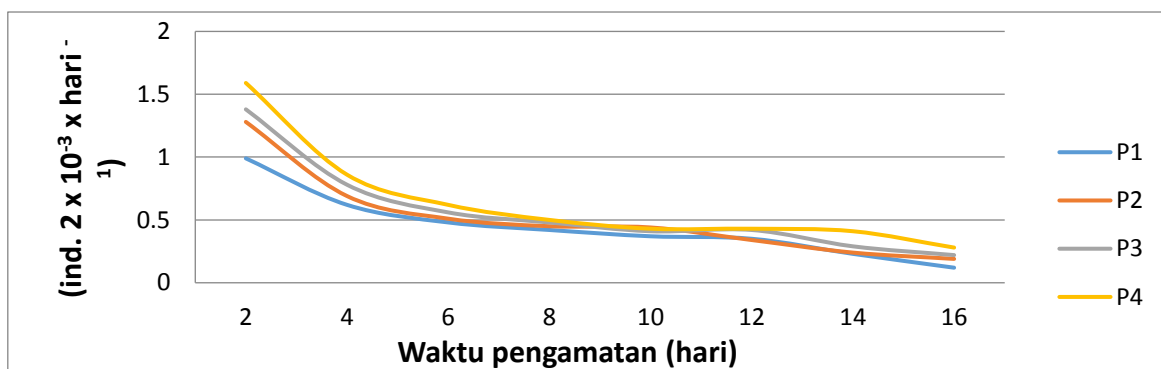

Figure 3. Graph of Population Growth Rate of *Moina* sp at Each Treatment During Observation (% / day)

Figure 3 shows the rate of population growth of *Moina* sp after the 2nd day observation, the population growth rate decreased. Where in the measurement of day 2 the rate of population growth of *Moina* sp is quite high, because the food supply is still sufficient for the needs of growth and breeding. But on the next day's observations until the 16th day, the rate of growth of the *Moina* sp population was lower. This is because the food supply continues to decrease as the population of *Moina* sp increases, while the amount of *chlorella* sp administered remains the same during the study for each treatment.

Mudjiman (1985), said that in culturing *Moina* sp availability of feed is very decisive to the rate of population growth. If there is a lack of nutrients in the media material can cause a decrease in the rate of growth of the population of *Moina* sp or even experience mass death.

Quality of Water

During the research measurement of water quality parameters, the parameters observed are listed in Table 4.

Table 4. Measurement of Water Quality Parameters on Culture Media Each Treatment During Research

No	Quality of Water	Treatment			
		P0	P1	P2	P3
1	Temperature (°C)	25-28	25-28	25-28	25-28
2	pH	6,0-6,5	6,0-6,5	6,0-6,5	6,0-6,5

The culture medium temperature at each treatment ranged from 25-28 oC. The temperature difference during the study took place at 3 oC, where the temperature range of culture media was still relatively small. *Moina* sp develops into adulthood for 5 days at ambient temperature 21-31oC. Mudjiman (1985), said the good temperature range for *Moina* sp's maintenance business ranges from 27-31oC. Next Priyambodo (2004), describes the temperature for maintenance of *Moina* sp cultivated constant in the range of 27-30oC.

From the measurement results of acidity (pH) water culture media during the study ranged from 6.0-6.5. In the waters of *Moina* sp commonly found in aquatic conditions that have a pH of water above 6.0. So *Moina* sp is not and rarely found in aquatic environments with acidity (pH) of water below 6. Djarijah (1995), said that *Moina* sp can live well in the water pH range between 6.5-7.4. Then Pennak (1989) in Darmawan (2014), explains Cladocera sp requires a slightly alkaline pH of between 6.5 and 8.5. Furthermore Leung (2009), adding that the optimum pH for growth of *Daphnia* sp is pH 7.0 - 8.2. *Daphnia* sp and *Moina* sp belong to one cluster ie Cladocera or water flea, and have similar environmental conditions.

4. CONCLUSION

From the results of research that has been done, can be drawn conclusion as follows:

1. Giving *Chlorella* sp with different amounts very significant effect on the growth and breeding of *Moina* sp.
2. *Moina* sp highest density of 8,992 ind / L with *Chlorella* sp 150x10⁴ cell / mL, with peak population on day 14.
3. The lowest density of *Moina* sp. 1,942 ind / L with *Chlorella* sp 75x10⁴ cells / L, with peak population on day 12.

REFERENCES

- Balai Budidaya Air Tawar. 1984. Kultur Pakan Alami (*Daphnia* sp). Direktorat Jenderal Perikanan, Balai Budidaya Air Tawar. Sukabumi. 4 halaman
- Cahyaningsih, S. 2006. Petunjuk Teknis Produksi pakan Alami. Departemen Kelautan dan Perikanan Dirjen Perikanan Budidaya. Balai Budidaya air Payau Situbondo. 25 halaman.
- Dahril, T. 1996. Rotifer Biologi dan Pemanfaatannya. UnriPress. 93 halaman
- Darmawan, J. 2014. Pertumbuhan Populasi *Daphnia* sp Pada Media Budidaya Dengan Penambahan Air Buangan Budidaya Ikan Lele Dumbo (*Clarias gariepinus* BURCHELL, 1822). Berita Biologi. 13 (1): 57-63

- Djarajah. 1995. Pakan Ikan Alami. Kanisius. Yogyakarta. 86 halaman.
- Leung, Y. F. J. 2009. Reproduction of the Zooplankton, *Daphnia carinata* and *Moina australiensis*: Implication as Live Food for Aquaculture and Utilization of Nutrient Loads in Effluent. School of Agriculture, Food, Wine - The University of Adelaide. Adelaide. 189 p
- Mudjiman, A. 1985. Makanan Ikan. Penebar Swadaya. Jakarta. 190 halaman.
- Odum, E.P. 1971. Fundamental Ecology. 3-rd ed W.B Sounder Co. Toronto. 574 p.
- Muhasdika, C., Rosyadi dan T.I. Johan. 2015. Pemberian Pupuk Bokashi Dengan Dosis Berbeda Pada Media Air Limbah Rumah Tangga Terhadap Perkembangan Populasi *Moina* sp. Jurnal Dinamika Pertanian. Vol.XXX (1): 69-75
- Priyambodo, K. 2004. Budidaya Pakan Alami Untuk Ikan. Penebar Swadaya. Jakarta. 63 halaman.
- Rianasari., T.S.A. Nugroho dan M.A. Hamid. 2009. Budidaya Massal *Moina* sp Dengan Media *Chlorella* sp Sebagai Alternatif Pengganti Cacing *Tubifex*
- Rosyadi. 2005. Uji Penggunaan Plankton Catalyst Terhadap Perkembangan *Moina* sp. Jurnal Dinamika Pertanian. Vol. XX (1):
- Rosyadi. 2013. Pemberian Pupuk Organik Cair Lengkap (POCL) Super ACI Dengan Dosis Berbeda Terhadap Perkembangbiakan *Moina* sp. Jurnal Dinamika Pertanian .Vol. XXVIII (2): 153 - 160
- Suwignyo, S., B. Widigdo., Ardianto, dan M. Krisanti. 2005. Avertebrata Air Jilid 2. Penebar Swadaya. Jakarta. 188 halaman.
- Wijayanti, K. 2010. Pengaruh Pemberian Pakan Alami Yang Berbeda Terhadap Sintasan dan Pertumbuhan Benih Ikan Palmas (*Polypterus senegalus* Cuvier, 1829). Fakultas Matematika dan Ilmu Pengetahuan Alam Departemen Biologi Akuakultur. Depok. 48 halaman.
- Zuhidah., W. Gunawan dan U. Subhan. 2012. Pertumbuhan Populasi *Daphnia* sp Yang Diberi Pupuk Limbah Budidaya Karamba Jaring Apung (KJA) Di waduk Cirata Yang Telah Difermentasi EM4. Jurnal Akuatika. Vol. III (1): 84-94

ANALYSIS OF THE COMPETITIVENESS OF FARMING OIL PALM PEOPLE BENGKALIS REGENCY IN MANDAU

Sri Ayu Kurniati¹, Welly Sampurno²

^{1,2} Department of Agribusiness, Faculty of Agriculture, Universitas Islam Riau
Jl. Kaharuddin Nasution, Marpoyan, Pekanbaru 28284 Riau, Indonesia

Email : sriayukurniati@agr.uir.ac.id

Abstract

World market outlook is good for palm-based products and is believed to increase farmers' productivity, open employment opportunities, and increase the purchasing power of rural communities as well as an overview of economic efficiency and financial efficiency of farm input allocations and the best policy directions formulated by the government. The purpose of this research is to: 1) identify the characteristics of farmers, 2) analyze the financial and economic benefits, 3) analyze the competitiveness of oil palm farming, and 4) analyze the impact of government policy on competitiveness. This research used a survey method in the Mandau Sub-district of Bengkalis Regency with sample number 90 people. Data analysis using descriptive method and quantitative analysis of the Policy Analysis Matrix (PAM). The results of research on the characteristics of farmers stated that the average age of farmers 45 years, low educated, 14 years of farming experience, and the average number of family members 3 souls. Palm oil farming benefits financially and economically as well as has a competitive and comparative advantage owing to more than one PCR and DRCR scores. The Government's policy on output causes domestic output prices to be higher than international prices while the Government's protection against inputs and producers receives subsidies so they can buy at low prices. The policy on input-output has not been fully effective in protecting oil palm farmers, in Sub-district Mandau, Bengkalis District.

Keywords: *Competitiveness, Oil Palm, PAM, Input-Output Analysis*

1. INTRODUCTION

Agriculture as one of the dominant sector in the improvement of people's income is also a flagship sector work opportunities, expanding markets both at home and abroad,

improve and increase yield, diversify the quality of the production, processing and ultimately as a contributor to the country's foreign exchange from the sector's non oil and

gas. Special sub plantation sector, Indonesia has oil palm crop commodities, where the development program and the development of palm oil increased and prospects the world market for Palm oil-based products are quite good, encouraging Governments to develop oil

palm plantation acreage . Large of acreage, the number of production and productivity of oil palm in Indonesia in the past year 2011-2015 continues to increase, including a look at the following table:

Table 1.Extensive Acreage, production and productivity of oil palm in Indonesia

Years	Wide area (ha)	Production (tonnes)	Productivity (kg/ha)	Growth (%)
2011	8,992,824	23,096,541	3,526	-
2012	9,572,715	26,015,518	3,722	0.05
2013	10,465,020	27,728,004	3,536	-0.05
2014	10,754,801	29,278,189	3,601	0.02
2015	11,300,370	31,284,306	3,679	0.02

Source: Directorate General of plantations, 2016

Based on table 1 an increase in acreage, number of vast production, in the form of palm oil (CPO), and the resulting productivity year caused by topography, moisture, and fertile soil for the growth of oil palm plant, the increase of farmers 'income increase due to the prestige, as well as the power to choose the relatively still higher when compared with the substitution products such as coconut oil, soybean oil, corn oil, sunflower seed oil even.

Riau as one province famous for its palm oil plantations are known to have the largest acreage, spacious in Indonesia, namely during the years 2012 covering an area of 6,384.54 hectares, the year 2013 m2 6,647 hectares, and the year 2014 m2 7,037.64 hectares. Broadly this area gathered from area plantations across Regency/city in Riau Province. Bengkalis Regency, although only has an area of 7.6% of the total area of plantations in Riau Province contribute to the extensive acreage and increase the amount of production. Sub Mandau has the largest production i.e. 812,927.8 tonnes TBS or 48.94% of total production of the Regency of Bengkalis (Department of Forestry plantations and the Regency of Bengkalis, 2015).

The development of oil palm plantations the people of in the Mandau is an opportunity in the improvement of the economy of the community. This relates to the existence of support from local authorities against palm oil plantation business people and the emergence of some industries that use raw materials from oil palm production results. Perpetrators of farming oil palm in the Mandau is plantation, where among other issues facing the low productivity and the quality of its results that cause the price farmers received fluctuate, technology the production applied in farming is still simple starting from nursery up to the handling of his crop. The use of input farming are generally provided by farmers and became one of the factors that make productivity has not been optimal. Palm oil plantations were cultivated by the people in District Government believed the Mandau can help alleviate poverty because it can increase the productivity of farmers, open up employment opportunities, and improve the purchasing power of the community the countryside, as well as the image of economic efficiency and the efficiency of the use of appropriations against the financial input of farming and the

direction of the best policy formulated by the Government. Based on the background so the purpose of this study is to: 1) Knowing the characteristics of farmers, 2) Analyze profit (profitability) is financially and economically, 3) Analyze power competitiveness of farming Palm oil, and 4) Analyze impact Government policy towards the competitiveness of farming oil palm

METHODOLOGY

This research using survey method in Bengkalis Regency Mandau, arguing that this region has the largest oil palm productivity levels in Bengkalis and farmers who cultivate oil palm plantations are typically the peasant folk. The population in this study are all farmers who cultivate oil palm crops as staple jobs. Sample farmers deliberately dictated on farmers who have plant oil palm yield (TM) and age of the plant more than 10 years that came from the village of Internal Batuah, new hope, Chamfer, and Pamesi, with the total sample was 90 people are farmers.

Data collection consisted of primary data and secondary data (Kuncoro, 2003). Primary data obtained through surveys in the field through direct interviews with sample peasant to based on a detailed questionnaire, including variable production inputs (seeds, fertilizers, pesticides, labor, and equipment), the price of inputs, the number of production, and data other related research. While secondary data include a general overview of the area, population, area, production, acreage and productivity of palm oil, which is obtained from the relevant agencies, such as the Office of the district, BPS, and Office of the estate

RESULT AND DISCUSSION

1. The characteristics of the oil palm Growers

Descriptive statistical methods used, i.e. methods to collect, summarize, presenting, and describes the data so as to provide useful information (Nisfiannoor, 2009), include old age, education, experience, effort and number of members family,

Method for analyze the financial and economic advantages, competitiveness, and the impact of government policies is the *Policy Analysis Matrix* (PAM). Some steps needs to be done, namely:

- a. Identify the input in farming oil palm in full
- b. Assignment of the input components to *tradable* inputs (input are traded in international markets, either import or export) and *non tradable* inputs (input generated in the domestic market and not traded International).
- c. Determination of shadow prices of inputs and outputs.

1. Shadow price of inputs, the same as the financial price i.e. land, seeds, fertilizers, pesticides, and labor. Shadow price of land and seeds are in price that applies in the area of research. The price of urea fertilizers shadows refer to price FOB because urea is already produced in Indonesia even exported, while fertilizer TSP, ZA, and NPK refers to the price CIF as it still imported. Shadow price of labor based on wages in place of research.

2. The output shadow price, with the CPO as its output, is determined by FOB at the nearest port. CPO output shadow pricing is influenced by the exchange rate so that the price of currency exchange shadow by standard conversion factors (SCF) according to Gittinger (1986) is needed: $SER = \frac{OER}{SCF}$

Where :

SER = Shadow Exchange Rate

OER = Official Exchange Rate

SCF = Standard Conversion Rate
 Conversion factor value is ratio of import and export value plus tax, can be determined as follows:

$$SCF_t = \frac{Xt+Mt}{(Xt-TXt)+(Mt+TMt)}$$

Information:

Xt = Indonesian export value year t (Rp)

Mt = Indonesian import value year t (Rp)

TXt = t year export tax (Rp)

TMt = t year import tax (Rp)

1. Tabulations and analyses the indicators matrix of policy

The complete tabulations matrix PAM is as follows:

Table 2. PAM Matrix Constituents Component (*Policy Analysis Matrix*)

Component	Acceptance	The Cost Of Factors Of Production		Advantage
		Tradable	Non Tradable	
Private price	A	B	C	D = A – B – C
The price of the social	E	F	G	H = E – F-G
Deviation	I = A – E	J = B – F	K = C-G	L = I – J – K

Source: Pearson et al (2005)

Description:

A = Acceptance *Private*

B = The Cost Of *Tradable Private*

C = Cost Of *Non Tradable Private*

D = Profit *Private*

E = Social Acceptance

F = Cost Of *Tradable Input Social*

G = Cost Input Of *Non Tradable Social*

H = Social Benefit

I = Transfer Output

J = Transfer Of *Tradable Input*

K = Transfer Factor

L = Net Transfer

- b. Social Benefits/ *Social Profitability*(H) = E – F – G

It is the difference between the receipts with the rest of the cost calculated using the prices of the shadow. If the value of H > 0 means perfect competition market condition, the commodities business activities economically profitable.

2. Analysis of Financial and Economic Benefits

- a. Advantage *Private/ Private Profitability*(D) = A – B – C

is the difference between acceptance and all costs incurred and is calculated using market rates. D value > 0 means a commodity that is financially feasible to be organized on the conditions of the existence of government intervention.

3. Analysis of the competitiveness of

- a. Analysis of competitive advantage

The private cost ratio (*Private Cost Ratio*) is an indicator of the competitiveness of the competitive advantage that illustrates the financial efficiency of a commodity. If the value of PCR < 1, then the commodity system capable of financing its domestic factors on price. The smaller the PCR then these commodities increasingly have competitiveness. Formula **PCR = C/A-B**

- b. Analysis of comparative advantage

Cost ratio domestic resource (*Domestic Resource Cost Ratio*) describes the economic efficiency as an indicator of comparative advantage which shows the

number of the domestic resources that can be saved to make one unit of foreign exchange. If the $DRCR < 1$ means economically efficiency and can be more efficient when it is produced in the country compared with the import (for commodity import substitution) or a high export opportunities (for commodity export orientation). The Formula Of The **DRCR** = $G/E-F$

4. Analysis of the impact of Government policy

Policy Impact Analysis Output

- a. Transfer The Output/ *Output Transfer*(**I**)

$$= A - E$$

It is the difference between the value of acceptance based on the price of financial and social acceptance based on price. Positive output transfer values reflect the magnitude of the transfer from the public to the manufacturer because the public buys the output at a price above the price should be. While the negative output transfer value indicates that the applicable policy resulted in output prices manufacturers received is lower than the price should be.

- b. Output protection Coefficient nominal/ *Nominal Protection's on Output* is the ratio between the reception and the acceptance of financial prices based upon a social price. If the value of $NPCO > 1$ means government policy resulted in output prices in the local market higher than the price on the world market. Formula **NPCO** = A/E

Policy Impact Analysis Inputs

- a. Transfer input/ *Input Transfer*(**J**) = $B-F$ indicates that the input policy expected in *tradable* inputs caused the difference between the input costs *privately tradable* and *tradable* input

costs. A positive value of $J (J > 0)$ shows the social price of foreign input. As a result the producers paying more expensive inputs. Conversely, if $J < 0$ shows government subsidies towards foreign input, so that farmers do not pay full social korbanan that should have paid.

- b. input nominal protection Coefficient/ *Nominal Protection's on Input* an indicator that shows the level of Government protection against domestic input prices. If the value of $NPCI < 1$ then Government policies are protective of the input and the input producers receive subsidies over foreign *tradable* so that manufacturers can buy with lower prices. If the value of $NPCI > 1$ then there is protection against foreign producers of *tradable* input, which causes the sectors using these inputs will be adversely affected by the high cost of production. Formula **NPCI** = B/F
- c. Transfer factor (**K**) is an indicator used to analyze the impact of the Government's policy against the non tradable inputs. If K is positive means there is a Government policy which is to protect domestic input producers. The Formula **K** = $C-G$

Policy Impact Analysis Input-Output

- a. the NET Transfer (**L**) is the difference between the net profit actually accepted the manufacturer with its social net profit, whether adverse or favorable to the farmers. The value $L > 0$ the surplus informed that additional manufacturers caused by the existence of a Government policy against input and output. **L** = $D - H$
- b. effective protection Coefficient (*Effective Protection's*) is an indicator

of the overall impact of policy inputs and outputs of the system of production of commodities in the country. The value of the EPC describing the extent to which government policies are to protect or inhibit domestic production. The value 1 means > EPC policies protecting domestic manufacturers effectively. Formula $EPC = A-B/E-F$

- c. Profit Coefficients (*Profitability's*) describes the overall influence of the policies that led to the private profit in contrast to social benefits. If the value of the PC > 1 then the Government policy of making profits received by producers is smaller when compared with no policy. Formula $PC = D/H$
- d. the ratio of the Value of subsidies for producers (*Ratio of Subsidies to Producers*) indicate the level of addition and subtraction of acceptance due to Government policy. The value of the SRP < 0 means government policies caused the manufacturer pulled out

production costs are greater than social costs to produce. The Formula Of The $SRP = L/A-B$

1. The Characteristics Of The Oil Palm Growers

- a. Age , describe the level of maturity of the attitude of each individual and affect the way of thinking and the ability of the power of the individual to work. Usually younger farmers will be stronger and enterprising work if compared to the farmers who are old, beside that young farmers will also receive faster innovation and more dynamic. But sometimes less young farmers can control the emotions when faced with problems in farming, this often makes young farmers taking decisions in a hurry. For more details the characteristics of the farmer according to age groups can be seen in the following table:

Table 3.characteristics of the Farmer according to age groups

Age (years)	The number of farmers (soul)	Percentage (%)
25-34	11	12.22
35-44	33	36.67
45-54	29	32.22
55-64	16	17.78
65-74	1	1.11
The total number of	90	100.00

Based On Table 3 Note that the aged farmer most range between 35-44 year i.e. 36.67 % of total sample with an average age overall was 4 5.67 years . The sample included farmers age categories age productive so farmers work productivity is high enough. When one is in the age of productive results obtained more work and income increased.

- b. Long Education , having regard to the power of reason , the attitude of the , and the behavior of farmers . As high education then managed efforts tend to be more rational to take advantage of educational societies, either obtained a formal or non formal. Long education that traveled every farmer here's what affects and distinguishes the mindset of every farmer, as in the following table:

Table 4. characteristics of the Farmer according to Long Education

Duration (years)	The number of farmers (soul)	Percentage (%)
0-4	24	26.67
5-9	48	53.33
10-14	18	20.00
The total number of	90	100.00

Based On Table 4 it can be explained that most of the farmers have only a low education level, i.e. JUNIOR HIGH SCHOOL graduates about 53.33%. The high education of farmers have indicated to the inability to give a decision as to whether it works or not in order to improve the standard of living of the family. The low level of education of the farmers shows that the quality of human resources of farmers is not adequate in the development of agribusiness and access job opportunities outside agriculture.

c. Experience farmer business, closely related to the level of skill and the ability of farmers in managing his oil palm farming and ability to adopt technology that developed aquaculture as well as the rate of speed in accessing the market as well as the ability to handle and manage farmer business. Based on the research note that the farmers owned farming experience varies. For more details can be seen in the following table:

Table 5. characteristics of the Farmer according to Experience Business farmer

Business experience (years)	The number of farmers (soul)	Percentage (%)
5-11	32	35.56
12-18	40	44.44
19-25	14	15.56
26-32	4	4.44
The total number of	90	100.00

Based On Table 5 it is known that in General farming experience ranges from 12 -18 years as much as 44.44% or an average of 14,07 years. It turns out farmers simply have experience in running a business activity of the Palm so it has a good knowledge of against the process of cultivation and the survival of his business.

d. The number of members of the family, from wife, children, and other family members who live together and be a family dependents. The number of family members can be a burden for families and can also be a source of labor to increase family income. Big nothingness family dependants is closely related to family income. Large of land farmer who usually relatively fixed so magnitude of family dependents becomes a factor that will influence the level of well-being of the farming family. The distribution of the number of family members, in this case including the head of the family farmer, seen in the following table:

Table 6. characteristics of the Farmers according to the number of family members

The number of family members (persons)	The number of farmers (soul)	Percentage (%)
1-3	55	61.11
4-6	34	37.78
> 6	1	1.11
The total number of	90	100.00

Table 6 shows that the number of members of the family farmers who are among the most dominant 1-3 the soul which is around 61.11 % or an average of 3 soul. The greater number of members of family who became dependents family then it will lower the capita income, because as members of the family will lead to ever increasing expenses. It leads to difficult to farmers out of poverty.

2. Analysis of Financial and Economic Benefits

Data reception, costs and profits at the next table used to calculate the values that become indicators of competitiveness and the impact of Government policy towards the competitiveness of farming oil palm in Bengkalis Regency Mandau .

Table 7. The results of the analysis PAM Farming oil palm in Bengkalis Regency, Mandau, 2017

Component	Acceptance	The Cost Of Factors Of Production		Advantage
		<i>Tradable</i>	<i>Non Tradable</i>	
Private price	91,996.0	1,432.2	936.3	89,627.2
The price of social	34,748.0	1,690.0	1,105.2	31,952.8
Divergence	57,248.0	-257.8	-168.6	56,821.6

Based on Table 7 Note that Palm farming in the Mandau is profitable, both financially as well as economy. This can be seen from the advantages of private and social benefits were positive. Selling price of production at the level of farmers join in influencing the value of acceptance, where the prices prevailing at the time the research is \$1,840/kg TBS. private Profit is positive indicative of government intervention in farming in oil palm Mandau Sub district. However, farmers still pulled out the high cost of production for farming especially for fertilizer and labor wages. Besides the

resulting oil palm productivity is still below the potential production plus the applicable prices constantly fluctuate. Although there have been interventions from the Government in terms of granting subsidies for fertilizer, but still required policies that provide greater impact for production of farming oil palm farmers. The average profit earned by farmers on farming oil palm in the Mandau Rp 57,248/hectare. This value indicates that the absence of Government policy then farmers will take advantage of that value. The high value of profits caused by the high value of the acceptance of the farmer, and this value is far

greater than the social benefits are issued. The magnitude of the social acceptance because of the shadow price of palm oil is much higher than the actual price. Shadow price is higher than the actual prices shows that the price of palm oil in foreign countries is higher than in the country.

4.3 analysis of the competitiveness of

Previous calculations have been performed against the value of the currency conversion. Conversion value gained 1.18 dollars to the value of current research at Rp 13,436 so shadow prices obtained by the exchange rate of Rp 11,385.19. The results of the analysis of competitiveness can be seen in the following table:

Table 8. Analysis of the competitiveness of farming oil palm in Bengkalis Regency Mandau, 2017

No.	Indicator	The value of the	Private profit (USD/ha)	Social benefits (\$/ha)
1	PCR	0.01	89,627.2	-
2	DRCR	0.03	-	31,952.8

Based on the results of research on Table 8 Note that PCR value of farming oil palm in place research is 0.044 upon the advantages of private price of Rp 85,085,693. The value of PCR positive and it is smaller than one. These values indicate that in order to get the added value output of one unit at the price of extra required private fee on domestic factors less than one unit of 0.01 or as much as a unit.

While the value of the DRCR of 0.03 indicated that domestic resource allocation on a Palm farming in the Mandau has reached economically efficiency so as to have a comparative value. This means that domestic factors are needed to increase the added value of palm oil in relatively smaller Mandau i.e. amounting to 0.03 units. The value of the social benefits / hectare as his shadow prices i.e. prices that are not government intervention when compared with the advantages of a private show that Palm farming is still in need of Government policy in improve production results.

Overall the results of the analysis of competitiveness shows that Government policies on oil palm farming in the Mandau is able to enhance competitive advantage but an increase in the use of *tradable* input containing Import component in an increasingly intensive farming led to comparative advantage has decreased.

3. Analysis of the impact of Government policy

Impact Of Policy Outputs

Data on the magnitude of the Transfer of the Output (TO) and Nominal Output Protection Coefficient (NPCO) as an indicator of the impact of government policies can be seen in the following table:

Table 9. The result of the Transfer of the Output and Output Nominal Protection Coefficient of farming oil palm in Bengkalis Regency Mandau, 2016

No.	Indicator	The value of the
1	To (\$/ha)	57,248
2	NPCO	2.65

The transfer of the output is the difference between the calculated over the acceptance of private prices with acceptance at a price socially, whereas NPCO is acceptance ratio is calculated based on the price of private and social price. Based on Table 4.4.1 value TO note that it has a positive and greater than one NPCO. This means that the magnitude of the transfer from the public to the manufacturer was Rp 57,248 /hectare or society purchasing output with rates above the price should be. Value TO offset value NPCO also positive and

more than one, meaning with the presence of Government policy resulted in the price of output in the local market higher than the price on the world market.

Impact Of Policy Input

The magnitude of the impact of the Government's policy against oil palm farming inputs in the Mandau is shown by the value of the Input (it) Transfer, a Nominal Input Protection Coefficient (NPCI), and Transfer Factor (TF), as shown in the following table:

Table 10. The result of the Transfer of the Input, the Input Nominal Protection Coefficient, and Transfer Factor of farming oil palm in Bengkalis Regency Mandau, 2016

No.	Indicator	The value of the
1	TI (USD/ha)	-257.8
2	NPCI	0.85
3	TF (USD/ha)	-168.6

Based on Table 10 Transfer of Input values to see that (it) is negative or less than zero. This is shows government subsidies towards foreign input, so that farmers do not pay full social victim that should have paid. NPCI Ratio of less than one indicates the presence of protection against the input and the input producers receive subsidies over foreign *tradable* so that manufacturers can buy with lower prices. Offset Transfer value again with factors (TF) negative value indicating the presence of implicit tax or transfer (intensive) of the domestic input producers because oil palm farmers in domestic input prices receive the Mandau is more expensive rather than a social price. Some implicit tax policy include

Tax of Earth and building (PBB) and value added tax (VAT).

Input-Output Policy Impact

Impact of policy composite can be seen from the NET Transfer indicators (TB), an efficient Protection Coefficient (EPC), the coefficient of Profit (PC), and the Ratio of Producer Subsidy (SRP), as shown in the following table:

Table 11. The results of the analysis of the Transfer of clean, Efficient Protection Coefficient, Coefficient gain, and the Ratio of farming Subsidies, the producers of palm oil in the Bengkalis Regency Mandau, 2016

No.	Indicator	The value of the
1	TB (\$/ha)	57,674.4
2	EPC	2.74
3	PC	2.80
4	SRP	0.63

Table 11 shows the value of positive TB informs that the existence of additional surpluses of manufacturers that are caused by the existence of a Government policy against input and output. The value EPC is positive and more than one, meaning the Government's policy against the prevailing input-output oil palm farmers protect effectively. The value of the coefficient of profit (PC) worth more than one, this means the existence of more favourable protection when in the absence of protection. Government policy towards private profit causes output of farming oil palm is higher than the profit that is supposed to received if there is no Government policy (social benefits). While the value of the SRP is more than zero indicate that the prevailing government policy during this causes oil palm farmers income experienced a slight increase

CONCLUSION

- 1) The characteristics of the oil palm growers include the average age of 45.67 years, average education level is a JUNIOR HIGH SCHOOL graduate, the experience of the average farming is 14.07 years, the number of members of the family generally is 3 people.
- 2) Farming oil palm in Bengkalis Regency Mandau benefit financially and economically, evidenced by the value of the private benefits and social

benefits has a positive and greater than zero.

- 3) The results of the analysis of the competitiveness of farming oil palm in the Mandau shows that farming on site research have competitiveness, good competitive advantages of comparative. This is apparent from the value of PCR (0.01) and the DRCCR (0.03) positive and smaller than one.
- 4) The output shows the value TO policy and positive NPCO and more from a single, meaningful Government policies resulted in the price of output in the local market higher than the price on the world market. Policy inputs provide value negative IT shows government subsidies towards foreign input, so that farmers do not pay full social victim that should have paid. NPCI ratio of less than one indicates the presence of protection against input and producers receive subsidies over foreign tradable inputs so that manufacturers can buy with lower prices. While the value of TF negative indicates the implicit tax or transfer (intensive) of the domestic input producers because oil palm farmers in domestic input prices receive the Mandau is more expensive than the social price. Input-output policy showed the value of positive TB informs the existence of additional surpluses of manufacturers that are

caused by the existence of a Government policy against input and output. The value EPC is positive and more than one, meaning the Government's policy against the prevailing input-output oil palm farmers protect effectively. The value of more than one PC, this means the existence of more favourable protection when in the absence of protection. While the value of the SRP is more than zero indicate that the prevailing government policy during this causes oil palm farmers income experienced a slight increase.

SUGESSTION

- a) To research further, keep in mind how the function of the demand for the subsidies and how to influence change towards the production of inputs so that the need to use production function
- b) For government purchasing efforts, the output of farming oil palm fermented with a higher price is a form of stimulus that can increase the productivity of farmers in making TBS. Next, export tax policy to accelerate the industrial growth of the State of the estate should not be made a top priority.
- c) For farmers, farmer groups activities should be improved. This is in addition to improving the *bargaining position* of the farmer at the time of marketing, can also decrease the use of manpower for example at the time of spraying pests/diseases. Next, farmers group activities can also serve as a vehicle for sharing information and experience as well as a medium that can facilitate the entry of Government assistance to farmers in the area of oil palm production center.

REFERENCES

- Aprizal, 2013. Analisis Daya Saing Usahatani Kelapa Sawit di kecamatan Mukomuko. Tesis Program Studi Magister Agribisnis Fakultas Pertanian Universitas Bengkulu
- Arfah Sri Yuliati Chansa. 2016. Pengaruh Kebijakan Pemerintah Terhadap daya Saing Komoditas Kakao di Sulawesi Tengah. Tesis Sekolah Pascasarjana Institut Pertanian Bogor
- Azh Arindra Fazlur dan Suhantini. 2016. Analisis Keunggulan Komparatif Usahatani Tebu (Studi di Desa Wates Kecamatan Ranuyoso kabupaten Lumajang). Jurnal Habitat. Volume 27 Nomor 1 Hal. 25-36. Universitas Brawijaya Malang
- Bandrang Tirsia Neyatri, Ronnie Natawidjaya, Maman Karmana. 2015. Analisis Daya Saing dan Dampak Kebijakan Terhadap Beras Organik Ekspor (Kasus Studi di Gapoktan Simpatik Kabupaten Tasikmalaya). Jurnal Ilmu Pertanian dan Peternakan. Volume 3 Nomor 1 hal. 33-46. Program Magister Ekonomi Universitas Padjadjaran Bandung
- BPS Propinsi Riau. 2015. Luas Areal Perkebunan Kelapa Sawit Kabupaten Kota. Pekanbaru
- Dinas Perkebunan dan Kehutanan. 2015. Luas Areal Tanaman Kelapa Sawit di Kabupaten Bengkalis. Bengkalis
- Direktorat Jenderal Perkebunan. 2015. Luas Areal, Jumlah Produksi, dan Produktivitas Kelapa Sawit Propinsi Riau. Jakarta
- Direktorat Jenderal Perkebunan. 2016. Luas Areal, Jumlah Produksi, dan Produktivitas Kelapa Sawit di Indonesia tahun 2011-2015. Jakarta
- Fauzi Yan, Yustina Erna Widyastuti, Iman Satyawibawa, Rudi Hartono. 2008.

- Kelapa Sawit Budidaya, Pemanfaatan Hasil dan Limbah, Analisis Usaha dan Pemasaran. Penebar Swadaya. Jakarta
- Gittinger. J.P. 1986. Analisis Ekonomi Proyek-proyek Pertanian. Edisi Kedua. Terjemahan. Universitas Indonesia Press. Jakarta.
- Halwani R.H. 2002. Ekonomi Internasional dan Globalisasi Ekonomi. Penerbit Ghalia. Indonesai. Jakarta.
- Hermayanti Ni Wayan, Zainal Abidin, Hurip Santoso. 2013. Analisis Daya Saing Usahatani Kelapa Sawit Di Kecamatan Waway Karya Kabupaten Lampung Timur. Jurnal II A, Volume 1. No.1. Januari 2013. Program Studi Agribisnis, Fakultas Pertanian, Universitas Lampung.
- Kadariah dan C. Gray. 1978. Pengantar Evaluasi proyek. Lembaga Penerbitan Ekonomi Universitas Indonesia, Jakarta.
- Kecamatan Mandau dalam Angka. 2015. Luas Areal, Produksi, dan Produktivitas Kelapa Sawit di Kecamatan Mandau. Bengkalis
- Kuncoro Mudrajat. 2003. Metode Riset untuk Bisnis dan Ekonomi. Erlangga. Jakarta
- Kurniawan, A.Y. 2011. Analisis Daya Saing Usahatani Jagung pada Lahan Kering Di Kabupaten Tanah Laut Kalimantan Selatan. Jurnal Agribisnis Perdesaan. Vol. 1. No 2
- Monke, E. A. and E. S. Pearson. 2005. *The Policy Analysis Matrix for Agricultural Development*. Cornell University Press, London.
- Masters A. William. 1995. *Guidelines On National Comparative Advantage and Agricultural Trade*. APAP III No 4001. Purdue University. USA
- Nisfianoor. 2009. Pengantar Statistik. Salemba Humanika. Jakarta
- Pahan, I . 2008. Panduan Lengkap Kelapa Sawit. Penebar Swadaya. Jakarta.
- Pahan, I. 2011. Panduan Lengkap Kelapa Sawit Manajemen Agribisnis dari Hulu hingga Hilir. Penebar Swadaya. Jakarta
- Salvatore, 1997. Ekonomi Internasional. Erlangga .Jakarta
- Simatupang dan Sudaryanto. 1990. Pengembangan Agribisnis Suatu Catatan Kerangka Analisis. Pusat Penelitian dan Pengembangan Sosial Ekonomi Pertanian. Bogor
- Sunarko. 2007. Budidaya dan Kelapa Sawit. Agromedia. Jakarta
- Tim Bina Karya Tani. 2009. Tanaman Kelapa Sawit, Yrama Widya. Jakarta
- Zulkifli. 2014. Daya Saing Komoditas Sektor Pertanian Propinsi Sulawesi Selatan Menuju Asean Economic Community. Makassar

ATTACHMENT**Attachment 1 . Analysis of Advantages of farming oil palm People in Bengkalis Regency, Mandau, 2017**

No.	Description	Values (\$/ha)
1	Variable Costs:	
	Fertilizer	8,805,278
	Pesticides	445,430
	TKLK 21.6 HOK	1,727,833
	The total number of	14,938,668
2	Fixed Costs:	
	TKDK 29.8 HOK	2,232,294
	Depreciation of tools	322,762
	The total number of	2,555,056
3	The Total Cost Of	17,493,724
4	Acceptance:	
	Production 49,998 kg Price Usd 1,840/kg	91,996,320
5	Advantage	74,502,596
6	R/C	5.26

Attachment 2 . Calculation Standards Conversion Factor and the Shadow Price of Exchange Rate, 2017

Description	Value (Usd Billion)
The Total Value Of Exports (Xt)	144,444,770
The Total Value Of Imports (Mt)	129,008,234
The Acceptance Of Export Taxes (TXt)	12,053,000
Receipt Of Import Tax ('s Tmt)	37,204,000
OER (US \$)	13,436
SCF	1.18
SER	11,385.19

Attachment 3 . The allocation of Tradable Input Usage and Non Tradable

Description	The total number of	Percentage (%)	
		Tradable	Non Tradable
Urea Fertilizer	331 kg	62	38
TSP Fertilizer	480 kg	62	38
KCl Fertilizer	537 kg	62	38
Fertilizer ZA	114 kg	62	38
Pesticides	848 litres	62	38
Labor	51.4 HOK	0	100
Depreciation	7.37 unit	0	100

LEARNING OUTCOME COMPARISON IN BIOLOGY SUBJECT BETWEEN PROBLEM BASED LEARNING (PBL) METHOD APPLIED AND GUIDED DISCOVERY LEARNING (GDL) METHOD APPLIED AT CLASS XI SMAN PEKANBARU ACADEMIC YEAR 2016/2017

Suryanti¹, Sepita Ferazona²

^{1,2} Department of Biology Education, Faculty of Education, Universitas Islam Riau
Jl. Kaharuddin Nasution, Marpoyan, Pekanbaru 28284 Riau, Indonesia
E-mail: suryantibio@edu.uir.ac.id, sepitabio@edu.uir.ac.id

Abstract

This research aims to find the differences of learning outcome for biology subject between classes that applied problems based learning (PBL) method and guided discovery learning (GDL) method to student of Class XI IPA SMAN Pekanbaru in academic year 2016/2017, with type of research is quasi-experiment. The data obtained analyzed by using quantitative data analysis and the learning outcome that measured was student' cognitive and psychomotor on excretion system study material. Data retrieval took place on January to April 2017. The result of comparative research on PPK value between 9 schools of SMA Negeri Pekanbaru shows SMAN 5 score the highest at 88.99 with a very good category for experiment class-1 which applied PBL method and experiment class-2 which applied GDL method score 86,24 with a very good category. In the comparative result for psychomotor within 9 school of SMA Negeri Pekanbaru, the highest score for experiment class-1 was SMAN 5 which scored 92.54, and experiment class-2 scored by SMAN 2 with 89,49, both schools are in very good category. From t-test data analysis result is discovered that SMAN 5 Pekanbaru which has the highest result on post-test among other school show that $t_{count} > t_{table} = 15,33 > 2,00$; indicated that H1 accepted and H0 rejected and there are significant contrast at biology study learning outcome in experiment class-1 and experiment class-2; In other hand, SMAN 4 Pekanbaru which has the lowest result on post-test shows $t_{count} > t_{table} = 3,60 > 2,00$, indicated that H1 accepted and H0 rejected which mean there are significant contrast at biology study learning outcome between experiment class-1 and experiment class-2. Overall, as seen from t-test value of post-test on whole school shows h1 accepted and h0 rejected and concluded that there are significant difference learning outcome between Problem Based Learning (PBL) Method Applied class And Guided Discovery Learning (GDL) Method Applied class with excretion system study material at student in class XI SMA Negeri Pekanbaru academic year 2016/2017.

Keywords : *Problem Based Learning (PBL), Guided Discovery Learning (GDL), Learning outcome*

1. INTRODUCTION

Education that capable to support future development is an education that beable to help expand of learner's potentials, so the learner able to face and solve the problem of life. Education has to touch learner's conscience and competence potential. In harmony with Buchori in Trianto (2011:5), show that an excellence education is an education that not only prepares the learner to a neither profession nor position, but also help them to their daily case. Thus it known that an ideal state of education not only oriented toward past and present but also should a whole process that anticipated and talk about the future. Creating qualified HR through education start by training the thinking process.

However, the main problem of learning in education nowadays is the low absorption from learners. This is noticeably seen from average of student's learning outcome that quite alarming. This achievement is the result of learning condition that still conventional and not reaches the learner's dimension on how learning is actually. Substantially, the learning process until today still gives teacher a dominant role and denied access for student to develop independently through their thinking process. In accordance to Sanjaya (2010:1) on learning process, students encouraged less to develop their thinking process. The learning process during the class directed to student's ability to memorize information; students' brain pushed to remember and store up information without demand to understand the information and connected to their daily life. As result, when the student graduate, they are theoretically smart but minim applications.

Based on the result of observation and interview with biology's teacher at SMAN Pekanbaru, researcher obtained information about problems on learning achievement as follows: 1) At the learning process, teacher tend to using lecturing method and/or form a

small/big group discussion (consist of 8-10 people per group) occasionally. Eventually, the level of interest and participation student on learning process relatively low and affected their learning outcomes; 2) Most student tend to act passive during the lessons, student listens and write what teacher instruct to record; 3) Questions rarely arise from student, all the same if teacher asked a question; 4) Mostly students find learning biology is boring because varies of latin words / terminology that difficult to memorize and understand; 5) Until the end of class, learning outcomes of student meet undesirable result.

Preliminary research by Handayani (2015), shows that Problem Based Learning (PBL) learning method and Guided Discovery Learning (GDL) relatively effective to improve biology students' competencies. The learning method able to build student knowledge from teacher case study, then connected it to material concept, as result, learning becomes more attractive.

Problem Based Learning (PBL) learning method, as a method that use real case problem as context for student to think and skilled on solving problem (Rusman 2012:241), in other hand Guided Discovery Learning (GDL) learning method is a learning method that maximize students' ability to search and find something (objects, human, or occasions) systematically, critical, logic, and analytic, so they can formulize their own discovery with full confidence. Moreover, discovery learning also have feature point to make student more active during lesson. Students understand the study material with their own discovered answers. The result of this research aims to find differences of learning outcome between classes that applied and guided discovery-learning (GDL) method to student of Class

XI IPA SMAN Pekanbaru in academic year 2016/2017.

1. METHODOLOGY

This research held in class XI IPA of SMAN 2, 4, 5, 6, 7, 10, 11, 14, 15 Pekanbaru. The data retrieval took place on January to April 2017. Population on this research is all student class XI IPA at SMAN Pekanbaru on academic year 2016/2017 consist of 9 schools with 18 sample classes and 673 students in total. In each school of SMAN there are 2 sample classes. Data retrieval using homogeneity test, which average pre-test value of all population, then based on the pre-test result 2 homogeny classes selected. After that, those 2 classes drawn using coin to decide which one out of two learning method will apply.

Simple Random Sampling technique used to determined the sample, this technique took sample from population using random system regardless the strata on population which considered homogeneous (Riduwan, 2015:12). This research is a partial experiment that close to quasi experiment with human as the research subject (Darmadi, 2011:36). The Research design is using Nonrandomized Control Group Pretest-Postest Design.

RESULT AND DISCUSSION

1. Learning Outcomes Comparison Between Experiment Class-1 With Problem Based Learning Method Applied And Experiment Class-2 With Guided Discovery Learning Method Applied

a. Learning Outcomes Comparison on Understanding Conceptual Knowledge (PPK)

The score of PPK of experiment class-1 and experiment class-2 obtained from combination of LKPD, quizzes, homework, and UB. Cognitive value can be seen on graph 1 as below:

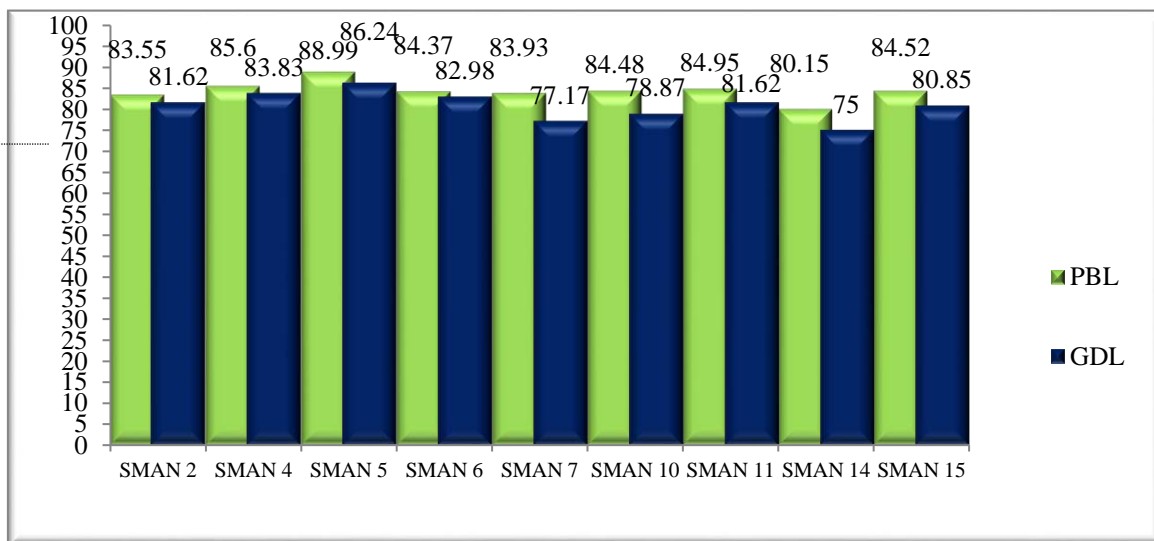

Figure 1. Students' PPK learning outcome comparison between experiment class-1 and experiment class-2

Based on Figure 1, shows PPK score on experiment class-1 (PBL) in SMAN 5 is the highest with 88,99 in score and a very good category; the lowest scored by SMAN 14 with 80,15 in a very good category. Meanwhile, in experiment class-2 (GDL) the highest score is SMAN 14 in 86,42 and the lowest 75,00 classified as good category.

b. Psychometric Learning Outcomes Comparison

The psychomotor score of experiment class-1 and experiment class-2 obtained from combination of portfolio score and performance score. Cognitive value can be seen on graph 2 as below:

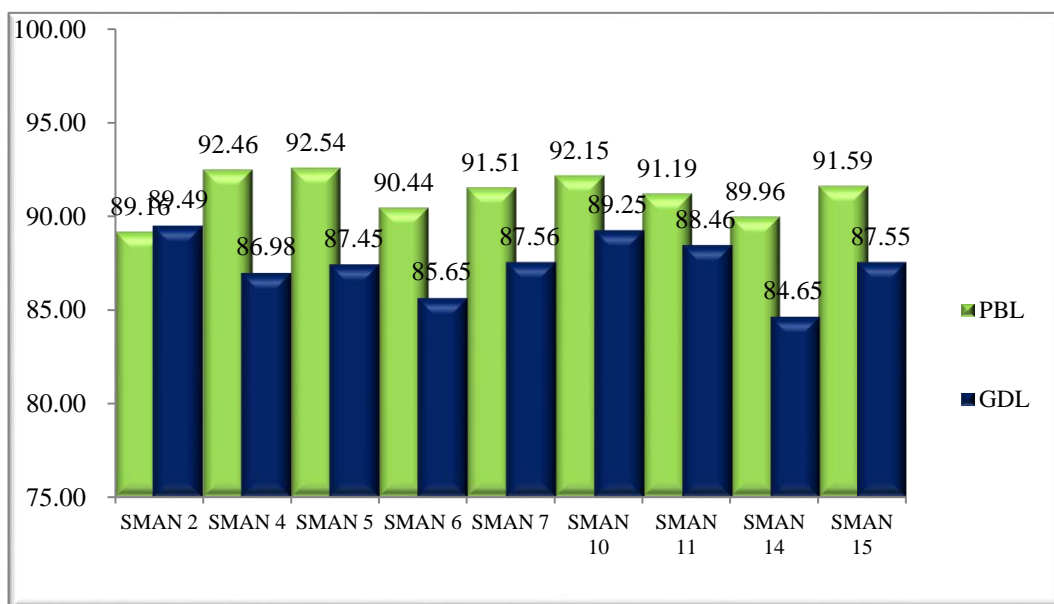

Figure 2. Students' psychomotor learning outcome comparison between experiment class-1 and experiment class-2

Based on Figure 2, shows psychomotor score on experiment class-1 (PBL) in SMAN 5 is the highest with 92,54 in score and a very good category; the lowest scored by SMAN 2 with 89,16 in a very good category. Meanwhile, in experiment class-2 (GDL) the highest score is SMAN 2 in 84,65 with good category.

2. Research Hypothesis Test (Inferential Analysis)

a. Pre-Test Data

Based on data analysis using t-test, obtained the inferential analysis of pre-test score on experiment class-1 and experiment class-2, can be seen that SMAN 14 Pekanbaru have the highest pre-test score that $F_{hitung} < F_{tabel} = 1,45 < 1,82$, as H_0 accepted and H_1 rejected which mean experiment class-1 and experiment class-2 are homogeneous or have similar varians. And the lowest pre-test score happen in SMAN 6 Pekanbaru $F_{hitung} < F_{tabel} = 1,00 < 1,84$, as H_0 accepted and H_1 rejected which mean experiment class-1 and experiment class-2 are homogeneous or have similar varians.

b. T-test Post-Test Data

Analysis result from post test score between experiment class-1 and experiment class-2, obtained as follows ; SMAN 5 Pekanbaru have the highest post-test score compared to other school that $t_{hitung} > t_{tabel} = 15,33 > 2,00$, as H_1 accepted and H_0 rejected which mean there were significant differences on biology learning

outcome between experiment class-1 and experiment class-2.

DISCUSSION

The highest score of understanding conceptual knowledge (PPK) on experiment class-1 (PBL) obtained by SMAN 5 with 88,24 and a very good category. It is because during research process, students really excited and serious to follow the class, so they can focus and understands the material that being discussed, also can answer the quiz related to excretion system material. After that, followed with students' activeness to work on LKPD, where students can pour their enthusiast and ideas creating the subject problem, formulate the problem and offer solutions to answer question that they create on formulation, and students are not face any obstacles during the process. This condition also supported by how teacher create the class atmosphere which tend to be flexible and oriented on how student discovery. In line with (Trianto, 2013:92), on Problem Based Learning (PBL), learning process begins by present real case problem and solution that offered students teamwork. During this type of method, teacher to guide student create outlines of problem solving to activities steps; teachers create flexible atmosphere and oriented on student work. In other hand, SMAN 14 scored the lowest in 80,15 with good category. It is because during the research process students find difficulties to analysis and solving given questions. However, on PBL syntax, student driven to analyze question of given concept. This indicates lack of personal result on score affected the group score. Aside from that, from interview obtained that student interest on reading is poor, this is cause student find difficulty on understanding and finding problem also hard to connecting between taught concept to answer the question. In line with Putra (2013:73) where PBL require the student to

explore the problem, observe and also do some experiment.

On the experiment class-2 (GDL), SMAN 5 obtained the highest score by 86,24 with a very good category. This is because student active to follow the learning process using LKPD, even though they rarely ask a question, but this condition does not affected their cognitive ability because student supported by teacher's guidance as in GDL syntax, teacher play the role as student's guide during learning process. This is in accordance to Roestiyah (2008:20), GDL has advantages to help student learning by guiding them to develop and master the cognitive skill. Meanwhile, the lowest score obtained by SMAN 14 which scored 75,00 and group as good category. This is because the student lack of seriousness during learning process as it takes place during daytime. The class interrupted by breaks time cause student's concentration dissolves and make student hard to understanding the material. In line with Syah (2008:132), the result of learning affected by several factors, internally and externally (student factors), ie. environmental conditions around the student and breaks their concentration.

On psychomotor score, experiment class-1 (PBL) the highest score obtained by SMAN 5 with 92,54 with very good category. This condition occurs because during lesson in class, the student more active and proactive to understand the material, these raises many question and create good discussion atmosphere actively. Aside from that, during practicum, the teamwork within student group is really good, supported by their curiosity and excitement at the subject make the experiment about excretion system by glucose test in urine more fun. After that, their excellence skill on connecting concept and material can be seen on presentation of their practicum report. In line with Putra (2013:82-84), problem based learning method involve the student to actively

solving problem and create higher thinking skill, student need to understand taught concept because they are the one who conclude the concept. In other hand, the lowest score is come from SMAN 2 with 89,16 and grouped as very good category. This is because the student less active and less confidence during group discussion. Makes only a few students bravely asking questions. Other than class discussion, during the practicum they tend to work individually and less teamwork within the group. In addition, the time slot after break time makes them less concentrate to the class. In accordance to Saefudin and Berdiati (2014:53), that PBL have to wrapped with good teamwork, collaboration within team member to build atmosphere that encourage the experiment, shared argument and developed thinking skills with various social skills.

At experiment class-2 (GDL) the highest scorer is SMAN 2 with 89,49 and predicated as very good category, because during the research, the student more active and curious to ask question to discover the problem which marked higher than average. In addition, the class takes place in morning slots make the learning atmosphere more conducive. In line with Rusman (2012:241), state that all student need a capability to seek and found a problem and they can formulate their own discovery full with confidence and enthusiast. The lowest score obtained by SMAN 14 with SMAN 14 with 84,65 and grouped as good category. During discussion and presentation smarter student tend to be more dominant to ask question but get less precisely answers from fellow student, and also some of teacher's question ignored by student who less active during discussion time. The daytime time slot and break time for Dzuhur pray also makes student less prepared mentally, this is affected their discovery process and problem solving using problem's paper, also student can not connecting the concept and study material. In line with Roestiyah

(2008:20), that student need preparation and mentally prepared to get study using guided discovery learning method approach. Student need to be brace and curious to observe the surrounding.

With data analysis using t-test, obtained inferential analysis of pre-test score between experiment class-1 and experiment class-2 at SMAN Pekanbaru, SMAN 14 Pekanbaru earn highest pre-test score $F_{hitung} < F_{tabel} = 1,45 < 1,82$, as H_0 accepted and H_1 rejected which mean experiment class-1 and experiment class-2 are homogeneous or have similar varians. This is because lecture method and discussion group often used on teaching process in the past, the material taken as pre-test is about animal and plant cells, the question given during pre-test taught by LCD media with lecture method. The teacher cooperative makes student more excited and antusiast during the class, supported by student that actively asking questions. While the lowest score occurred at SMAN 6 Pekanbaru $F_{hitung} < F_{tabel} = 1,00 < 1,84$, as H_0 accepted and H_1 rejected which mean experiment class-1 and experiment class-2 are homogeneous or have similar varians. This is obtained because the material that taken during the pre-test data is material about animal and plant cells, the method that usually used by teacher is lecture and rarely using discussion group method, this kind of method makes student lost interest and bored during the class, supported with cloudy weather and rain.

From discussion above, it can be seen that generally, teacher using lecture method during lesson time. This is triggering low score outcome in pre-test. In line with Slamant (2013:65), state that less decent teaching method that teacher applied affected how student learn. The less decent teaching method can be caused by less prepared or less understand to learning material, and how teacher deliver the material unclear or bad attitude during

delivery make student unhappy to both teacher or material.

In post-test outcome between experiment class-1 and experiment class-2 at SMAN Pekanbaru, obtained that SMAN 5 Pekanbaru get the highest score within whole school, $t_{hitung} > t_{tabel} = 15,33 > 2,00$, as H_1 accepted and H_0 rejected, it means there were significant differences on biology learning outcome between experimetn class-1 and experiment class-2, because on the class that applied PBL method on the experiment class 1, the learning process happen in 1st and 2nd term time slot which started at 07.30-09.00 and GDL method applied, on experiment class-2, study start on 3rd and 4th time slot at 09.00-10.45, student really enthusiast on discussion and quite serious on doing their LKPD task and quizzes, their active attitude make them easier to understand the material, the post-test include that have been taught during research which is excretion system.

In other hand, post-test outcome between experiment class-1 and experiment class-2 at SMAN 4 Pekanbaru have the lowest score, $t_{hitung} > t_{tabel} = 3,60 > 2,00$, H_1 accepted and H_0 rejected, it means there were significant differences on biology learning outcome between experimetn class-1 and experiment class-2. This is strenghened by PBL method applied in experiment class-1, study start on 3rd and 4th time slot at 09.00-10.45, and class that applied GDL method in experiment class-2, study start on 5th and 6th time slot at 10.45-12.15, the method used during this study poorly understood in syntax causing class not condussive, less enthusiast and not seriously discussing. GDL class begin after break time causes poor result. Then, when student is less likely to understand the material , also causes the post-test in this research is low.

The post-test score is higher that pre-test score before. Because new teaching

method have been applied. Accordance to Trianto (2011:12), state that inovative – progressif teaching method is a learning concept that help teacher connecting teaching material to student’s real situation and assist tudent to make connection between their knowledge and application on daily life, as expected become more meaningful to student.

To support the research result by handayani and friends (2015), this research intended to aims comparison on learning biology between classes with Problem Based Learning (PBL) method applied and Guided Discovery Learning (GDL) method applied. The data that taken for research is learning outcome from pre-test and post test. After analyzed by two party test, obtained the combined standard deviation (SP2) value = 13,02, and nilai t_{hitung} = 9,56 with t_{tabel} 1,96 for significant level 5%. Based on those two-party test, obtained that $t_{hitung} > t_{tabel}$ 9,56 > 1,96, it means that hypothesis accepted. With this hypothesis acceptance, there are a difference post-test score between problem based learning method applied class and guided discovery learning method applied class at SMA Negeri Pekanbaru in 2016/2017.

Conclusion

Based on research result that has been held, the conclusion is : There are differences in learning outcome In biology subject between problem based learning (PBL) Method Applied And Guided Discovery Learning (GDL) Method Applied At Class XI SMAN Pekanbaru Academic Year 2016/2017.

REFERENCES

- Amri, S., &Ahmadi I, K. 2010. *Proses Pembelajaran Inovatif dan Kreatif di dalam Kelas*. Jakarta: PT Prestasi Pustaka raya.
- Aunurrahman. 2008. *Belajar dan Pembelajaran (Memadukan Teori-Teori Klasik dan Pandangan-pandangan Kontemporer*. Bandung: Alfabeta.
- Darmadi, H. 2011. *Metode Penelitian Pendidikan*. Bandung: Alfabeta.
- Depdiknas.2006. *Standar Kompetensi dan Kompetensi Dasar SMA/MA*. Jakarta: Badan Standar Nasional Pendidikan.
- Elfis. 2010. Teknik dan Instrumen Penilaian Hasil Belajar. Tersedia di: <http://elfisuir.blogspot.com/2010/01/teknik-dan-instrumen-penilaian-hasil.html>. Januari 2010 (Diakses tanggal 28 Januari 2017).
- Farichah, C. Raharjo dan Beni, S. 2016. *Peningkatan Keterampilan Berpikir Kritis Siswa Melalui Model Pembelajaran Penemuan Terbimbing Pada Materi Kalor dan Perpindahannya*. Diambil dari: <http://ejournal.unesa.ac.id/index.php/pensa/articel/view/17156>. Jurnal Pendidikan Sains Vol. 4. No. 03 (2016). Universitas Negeri Surabaya. Diakses 28 November 2016.
- Hamiyah, N., &Jaurah M. 2014. *Strategi Belajar Mengajar di Kelas*. Jakarta: Prestasi Pustakaraya.
- Handayani, F., D. 2015. Perbandingan Kompetensi Biologi Siswa XI Mia Antara Model Pembelajaran *Guided Discovery Learning* dan *Problem Based Learning* Pada Materi Sistem Pencernaan Di SMAN 1 Sungai Tarab. *Abstrak Hasil Penelitian UNP*. Padang: Lembaga Penelitian UNP.
- Huda, M. 2013. *Model-model Pengajaran dan Pembelajaran: Isu-isu metodis dan paradigmatis*. Yogyakarta: Pustaka Pelajar.

- Istarani. 2012. 58 *Model Pembelajaran Inovatif*. Medan: Media Persada.
- Jacobsen, D.A, Eggen, P. & Kauchak, D. 2009. *Methods for Teaching I (metode-metode pengajaran meningkatkan belajarsiswa TK-SMA)*. Penerjemah: Achmad Fawaid & Khoirul Anam. Yogyakarta: Pustaka Pelajar.
- Kunandar. 2013. *Penilaian Autentik (penilaian nhasil belajar peserta didik berdasarkan kurikulum 2013)*. Jakarta: Rajawali Press.
- Purwanto. 2011. *Evaluasi Hasil Belajar*. Yogyakarta: Pustaka Pelajar.
- Purwanto, N. 1992. *Psikologi Pendidikan*. Bandung: Remaja Rosdakarya Offset.
- Putra, S., R. 2013. *Desain Belajar Mengajar Kreatif Berbasis Sains*. Yogyakarta: Diva Press.
- Pribadi, B., A. 2010. *Model Desain Sistem Pembelajaran*. Jakarta: PT Dian Rakyat.
- Riyanto, Y. 2012. *Paradigma Baru Pembelajaran*. Jakarta: Kencana
- Riduwan, M.B.A. 2008. *Dasar-dasar Statistika*. Bandung: Alfabeta.
- Riduwan. 2015. *Dasar-Dasar Statistika. ed. rev.* Bandung : Alfabeta.
- Rusman. 2012. *Model-Model Pembelajaran: Mengembangkan Profesionalisme Guru Edisi Kedua*. Jakarta: Raja Garfindo Persada

MEASUREMENT OF ELECTRIC GRID TRANSMISSION LINES AS THE SUPPORTING OF NATIONAL ENERGY PROGRAM IN WEST SUMATERA AREA, INDONESIA THROUGH GEOLOGICAL MAPPING AND ASSESSMENT

Husnul Kausarian¹, Batara¹, Dewandra Bagus Eka Putra¹, Adi Suryadi¹
Evizal Abdul Kadir²

¹Department of Geological Engineering, Faculty of Engineering, Universitas Islam Riau

²Department of Information Technology, Faculty of Engineering, Universitas Islam Riau

Email : husnulkausarian@eng.uir.ac.id, evizal@eng.uir.ac.id

Abstract

The need for energy in Indonesia continues to increase and the Indonesian government is keen to realize the development of electricity transmission network in Alam Pauh Duo, Alam Pauh Duo Subdistrict, Solok Selatan District. The topography of this region consists of Geomorphology Units of the Hills and High Geomorphological Units with an altitude of about 900-500m (meters) with lithology composed of volcanic rock lithology and breakthroughs of granite and granodiorite. The method used in the review survey (reconnaissance) is road sweeping or tracking using a handheld GPS. The results of this mapping and assessment are the coordinate values of the markers or dividing marks that are already available and scattered in each location point. The final result is a map that has a description of the location of Land Power plant and Transmission Tower. There are 15 transmission towers planned for the builders as well as power plant (GI). The required land area of each transmission tower is about 15x15 m (meters) up to 20x20 m and the land area for 3ha (hectare) power plant (GI) development. Then the distance between each tower of transmission approximately 30 meters.

Keywords: *Power Plant, Transmission Line, Alam Pauh Duo, Geological Mapping, Geological Assessment*

1. INTRODUCTION

The need for energy in Indonesia increase continuously in line with the growth rate of the industry and the number of residents and the Indonesian government is currently keen to realize this infrastructure, one of which is to build electricity transmission network. One source of this electrical energy is geothermal. Regency of Solok Selatan is one of the areas in Indonesia that have the potential of natural resources that is geothermal energy because Solok Selatan region has a geological condition that

supports the formation of hot springs, indirect utilization developed for geothermal power generation (Dickson et al., 2013). So with the existence of geothermal sources that can generate electricity is very potential to be built electric transmission lines that are around this area (Knott, 2012).

Geothermal energy is a relatively environment-friendly energy source because it comes from the inner heat of the earth. Water that is pumped into the earth by humans or natural causes (rain) is collected

to the surface of the earth in the form of steam, which can be used to drive turbines to produce electricity. The cost of exploration, as well as the capital cost of geothermal power plants, is higher than other power plants that use fossil fuels. However, once it starts operating, its production costs are low compared to fossil fuel power plants. Power Transmission Is a process of distributing electricity (Ding et al., 2011, Gao et al., 2007, Huang et al., 2016) from power plant to power distribution lines (power plant distribution)

so that it can be distributed up to consumer electric users (Sheng et al., 2013).

STUDY AREA

The Study site is located in Alam Pauh Duo, Kecamatan Alam Pauh Duo, District Solok Selatan, Geographically at 01°36'17.635'' - 01°37'26.464'' S dan 101°8'37.704'' - 101°7'44.508'' N. Landform at the study site is an area of hills and there are also local community plantations (Figure 1).

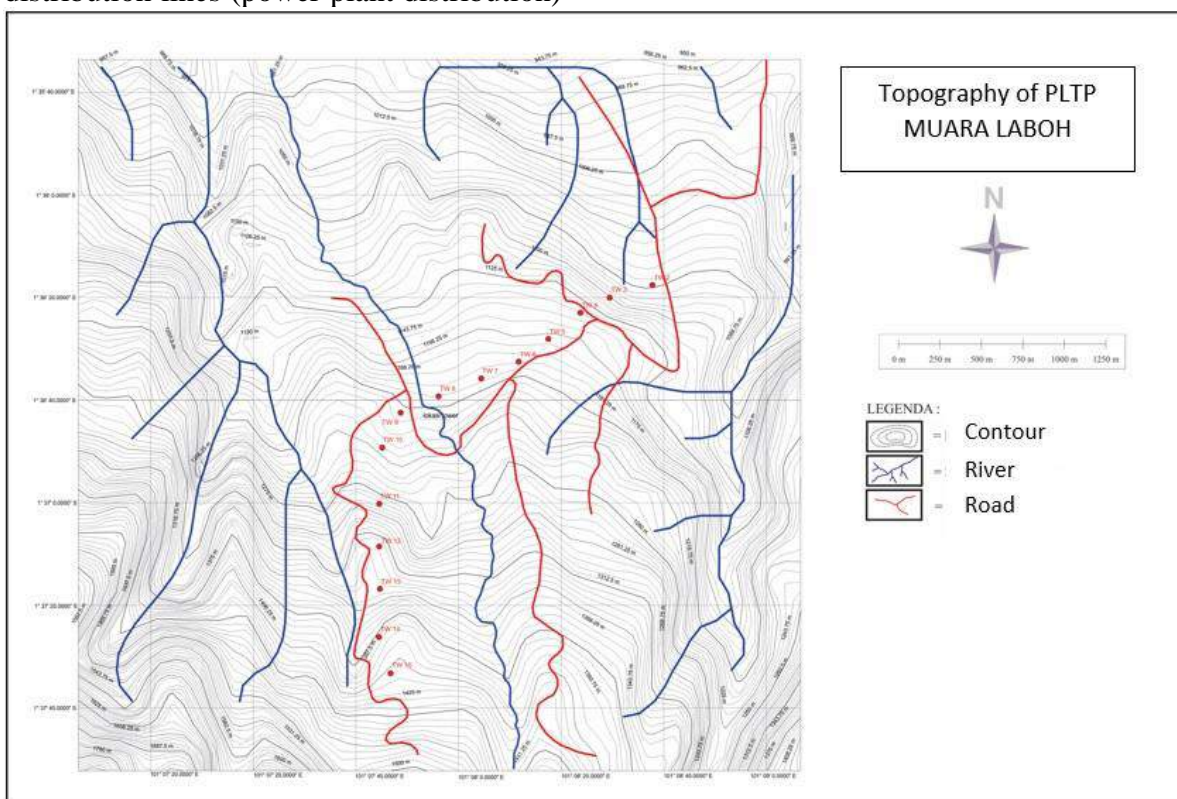

Figure 1. The map of survey line area.

Geothermal In the area of South Solok, or more precisely in the Muara Laboh, most of the hot springs associated with Muara Labuh located in a river valley Suliti, the basin tectonics (tectonic basin) along the 30 km and a width of 2-3 km at an altitude of 450 meters above the sea level. The tectonic basin in the North Muara Labuh. From the start of the southern end of the basin, topography continues to climb and the hot springs discovered at a distance of more than 3 km from the Mount Sikapa (656m) to

Sapan Malulong (850m). Areas to the south are called Sikapa Hill South Muara Labuh.

The survey area has a landscape classified into Geomorphology Hills unit and Geomorphology High Hills Unit with a height of about 900-500m (meters). Lithology contained in the research area is volcanic rock and breakthroughs of granite and granodiorite. Potential energy in this area is geothermal energy because that area has many hot springs.

In general, the survey area included in stratigraphic from young to old is composed of: Paleozoic metamorphic rocks (bedrock) (Perm-Carbon): composed by metamorphic rocks, metasediment and Pre-Tertiary volcanic rocks; Mesozoikum metasediment- rocks (Triassic-Jurassic): Members Batusabak and Shale (Formation Tuhur), Member of limestone's Kuantan Formation and sedimentary and volcanic rocks (Formation Sigunyor); Tertiary rocks consisting of: a group of sedimentary rocks and volcanic rocks group. Group volcanic rocks are divided into two age groups, namely groups of Eocene volcanic rocks (Formation Bandan) and Oligo-Miocene volcanic rocks (Formation Painan). Pre-Mesozoic rocks in the Mesozoic-break through the granite-diorite (Jura-Cretaceous). Tertiary rocks intruded by granodiorite and diabase rocks (Miocene). Quaternary volcanic precipitate mainly covered the top rock of the groups. Surface

sediment consists of alluvium, lacustrine and swamp sediment (Resen)

Structures that affect this area is the Sumatra Fault: Dextral strike-slip fault and the normal fault has direction northwest-eastwest. Fault growing in this area: a normal fault and strike-slip fault. Normal faults generally the northwest-southeast direction of the Fault Semangko. While fault that has direction east-west allegedly closely associated with diabase intrusive rocks. Faults developed in the rock group Painan Oligo-Miocene formations. Fault limit there lithological contact between intrusive rocks diabase (Tdb) and integral volcanic rocks (Qou). Strike-slip Fault relative has north-south direction cut in several places on normal faults. In some locations, this fault is estimated as controlling the course of the hydrothermal solution and lithological contacts (figure 2).

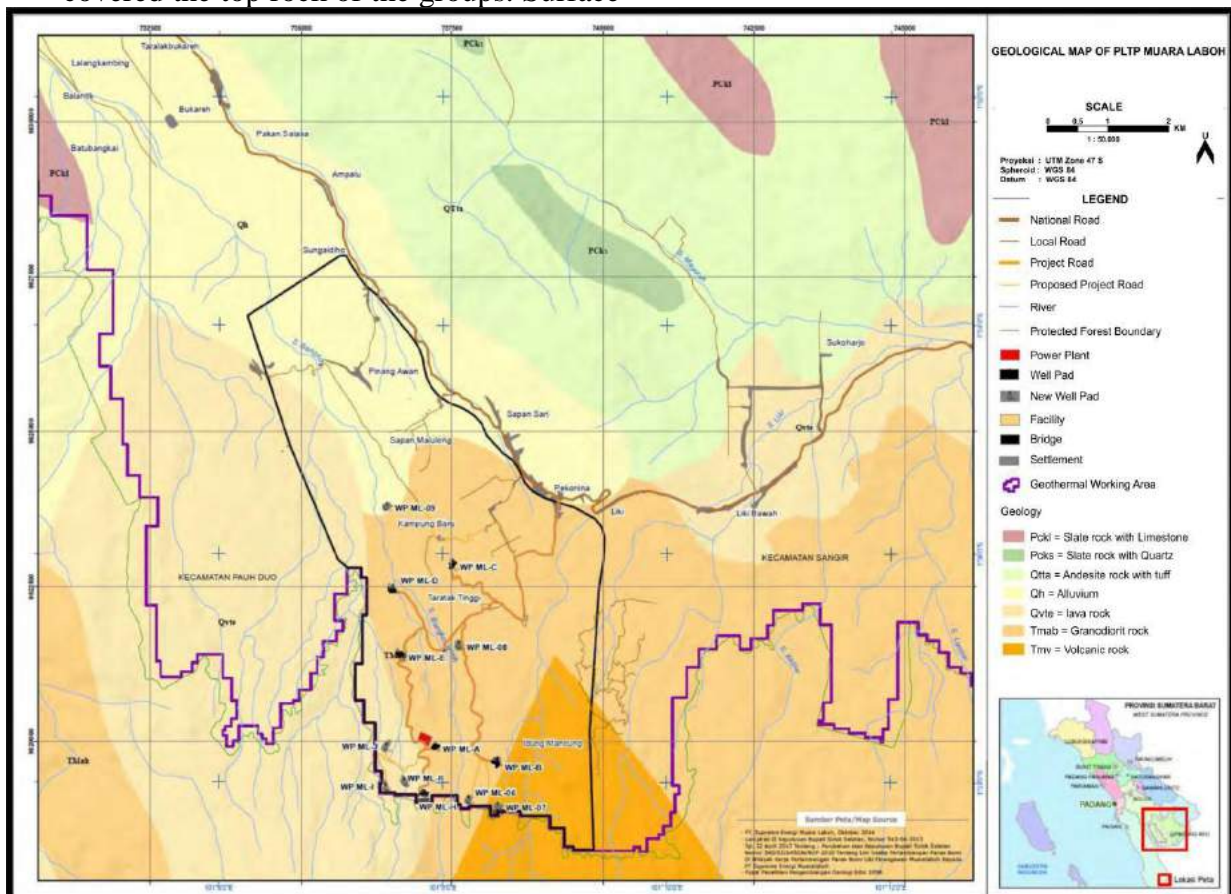

Figure 2. Geology Regional Map of Survey Area.

METHODOLOGY

The survey (reconnaissance) used in Alam Pauh Duo, District Alam Pauh Duo, South Solok. The method used in reviewing survey (reconnaissance) is sweeping the street or track using GPS handheld (Kausarian et al., 2014, 2016, 2017, O'Rourke, 1996).

The goal in reviewing survey (reconnaissance) is looking for a peg or re-check the presence of the power plant and the transmission tower (Li et al., 2012, Mei et al., 2012) that based on reports from the initial survey. And to investigate the geological conditions in the field include lithological characteristics and access path between each power plant and the tower destination point (Svacina, 1992, Wheeler, 1964).

The transmission can be airways and underground conduits, but generally in the form of the airways. Electrical energy is channeled through aerial transmission line generally use bare wire that relies on air as the insulating medium between the wires. And to refute / stretching wires with the height and distance are safe for humans and the surrounding environment, the conductor wires mounted on a sturdy building construction, commonly called the tower. Inter/ electric tower and wires insulated by an insulator.

RESULT AND DISCUSSION

The form of the survey data taken in the form of the coordinate value of stakes or pins barrier already available and distributed at each site listed in Figure 1 are indicated by red dots. The existence of a limiting peg or mark to be close to the peak location of injection wells drilling geothermal power plant in Muara Laboh, up toward the power plant (GI) under adjacent to the Main Office PT.Supreme Energy (Figure 3).

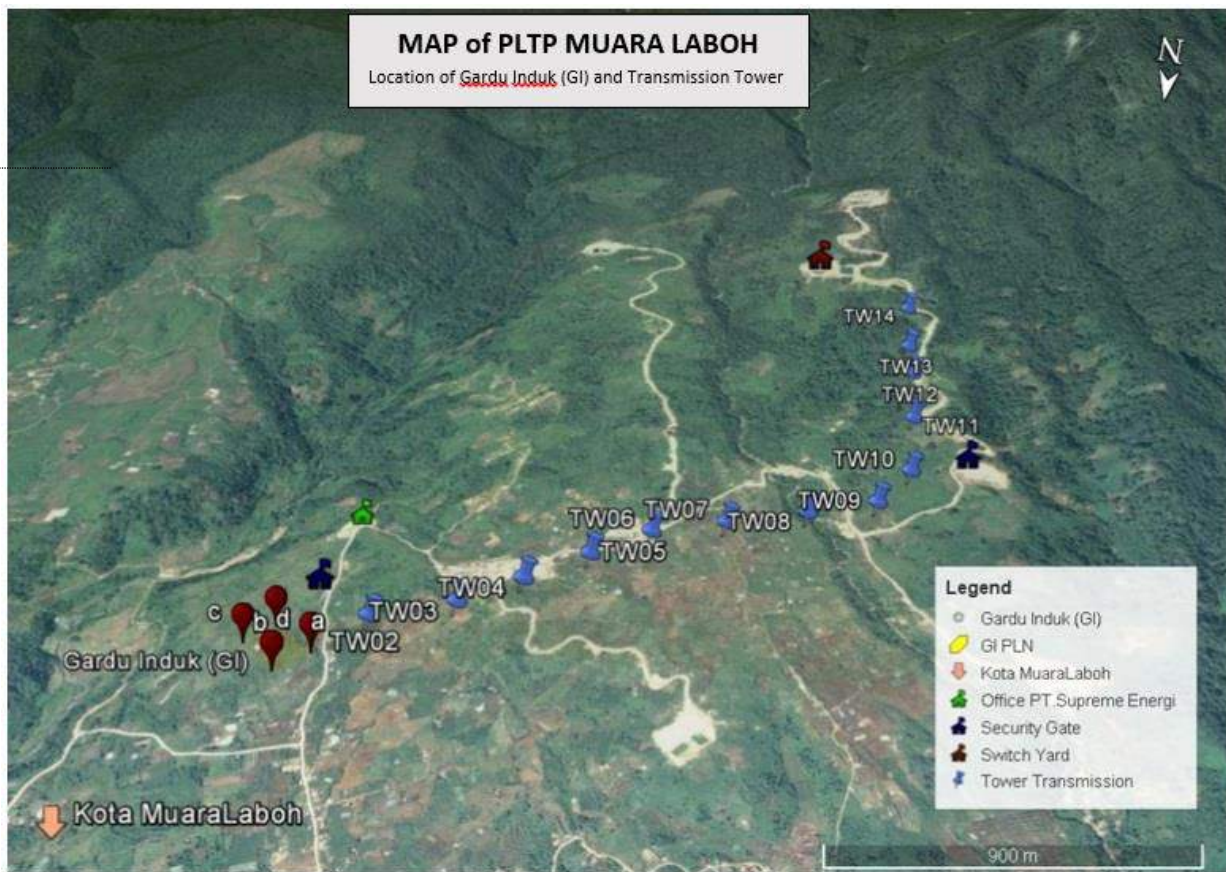

Figure 3. Locations of the power plant and the transmission tower (modified from googleearth).

Based on survey data that has been obtained then produced a map that has a description field site power plant and transmission tower. There are 15 planned develop transmission tower and Power plant (GI). The land area required for each transmission tower around 15x15 m (meters) up to 20x20 m and the area of land for the construction of the Power plant (GI) 3HA (hectares). Then the distance between each transmission towers approximately 230 meters.

Electrical energy is stream through aerial transmission lines rely on air as the

insulating medium between the wire conductor with the surrounding objects. To refute / span wires with the height and distance are safe for humans and the surrounding environment, the conductor wires mounted on a sturdy building construction, commonly called the tower. There is a 15 point locations potential to build a transmission tower (Figure 3), marking the point of this site in the form of stakes barrier. Here are images of locations around the pegs of the transmission tower (Figure 4).

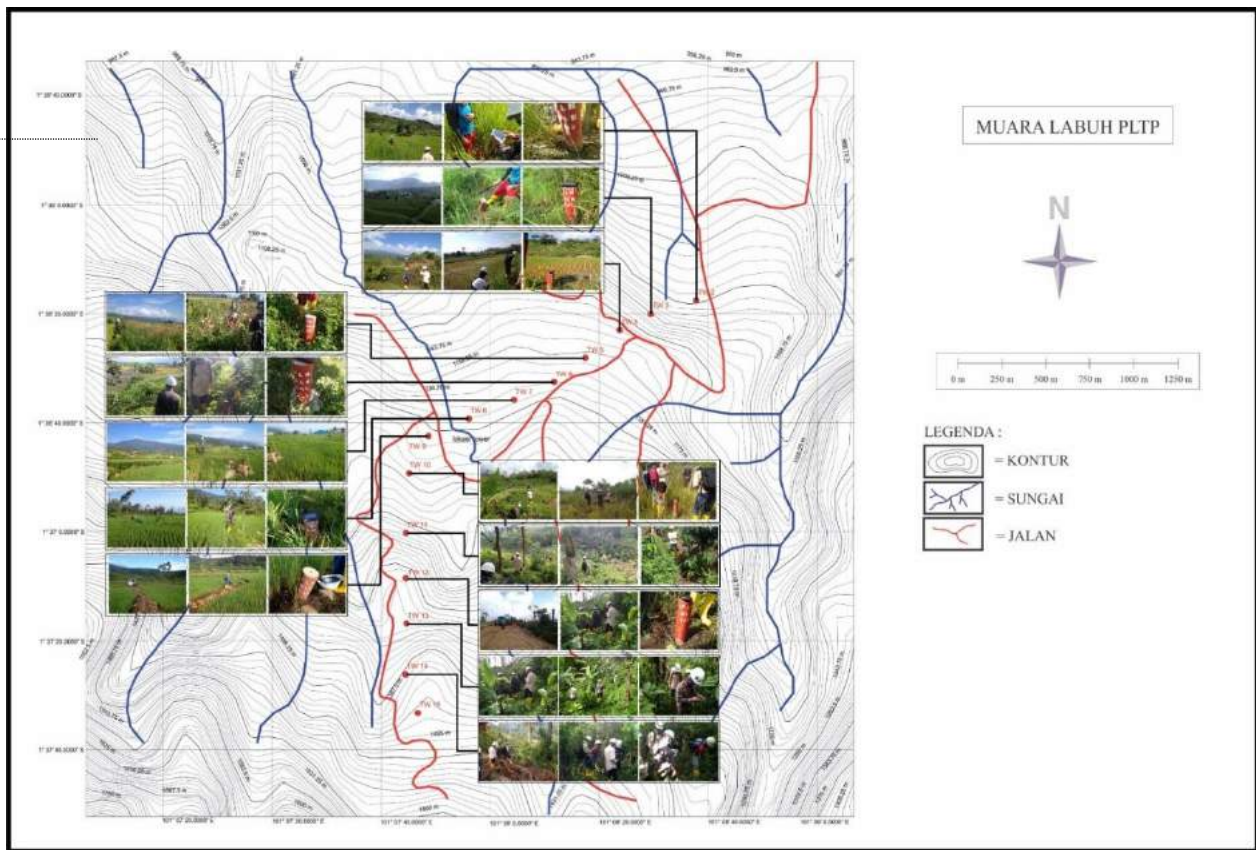

Figure 4. The Distribution Map Field Conditions in Every Transmission tower.

The results of field observations, field conditions are growing areas of local residents, the stakes are also several locations in the valley or the outskirts of the hill (see figure 3). Trails road is the only main access. For the location of transmission towers, peg 1 and 15 will be determined once the location of the power plant and Switchyard has been determined. Some points of the tower mounting location as a representation of the overall location shows this region in accordance become transmission lines.

There are 13 spots locations, including transmission 2 tower's locations is in the villagers' rice fields and access roads to get there a path that is usually passed by the farmers. Access from the main road leading to the location about 100 meters. Transmission 3 tower's locations are in villagers' rice fields and access roads to get there a path that is usually passed by the

farmers. Access from peg 2 to the location of the tower is about 200 meters. Condition transmission 4 tower's locations are in the villagers' rice fields and access roads to get there a path that is usually passed by the farmers. Access from peg 3 to the location of the tower about 220 meters. transmission 5 tower's locations as well as in the villagers' rice fields there are shrubs and the access road to get there is a path that is usually passed by the farmers. Access tower peg 4 to a location about 210 meters. Transmission 6 tower's locations as well as in the villagers' rice fields there are shrubs and the access road to get there is a path that is usually passed by farmers and residents. Access peg 5 to the location of the tower about 210 meters.

transmission 7 tower's locations as well as in the villagers' rice fields and there are shrubs and the access road to get there is a path that is usually passed by farmers and residents. There was no stakes marker.

Access tower peg 7 to a location approximately 180 meters. Transmission 8 tower's locations as well as in the villagers' rice fields and there are shrubs and the access road to get there is a path that is usually passed by farmers and residents. Access tower peg 7 to a location approximately 200 meters. Transmission 9 tower's locations are in the villagers' rice fields, there are shrubs and the access road to get there is a path that is usually passed by farmers and residents. The Access for peg 8 tower to a location approximately 200 meters. Transmission 10 tower's locations are in the villagers' rice fields, there are shrubs and the access road to get there is a path that is usually passed by farmers and residents. Access tower peg 9 to a location approximately 200 meters.

Transmission 11 tower's locations are in community garden and there's shrubs and

the access road to get there is a path, and located alongside a hill. Access tower peg 10 to a location about 200 meters. transmission 12 tower's locations are in shrubs and the access road to get there is a path, and located alongside a road project. Access tower peg 11 to a location approximately 200 meters. transmission 13 tower's locations are in shrubs and the access road to get there is a path, and located alongside a road project. Access tower peg 12 to a location approximately 200 meters. transmission 14 tower's locations are shrubs and the access road to get there is a path, and located alongside a road project. Access tower peg 12 to a location approximately 200 meters.

In general, it can be described the appropriate location to build power transmission lines using the tower as in Figure 5.

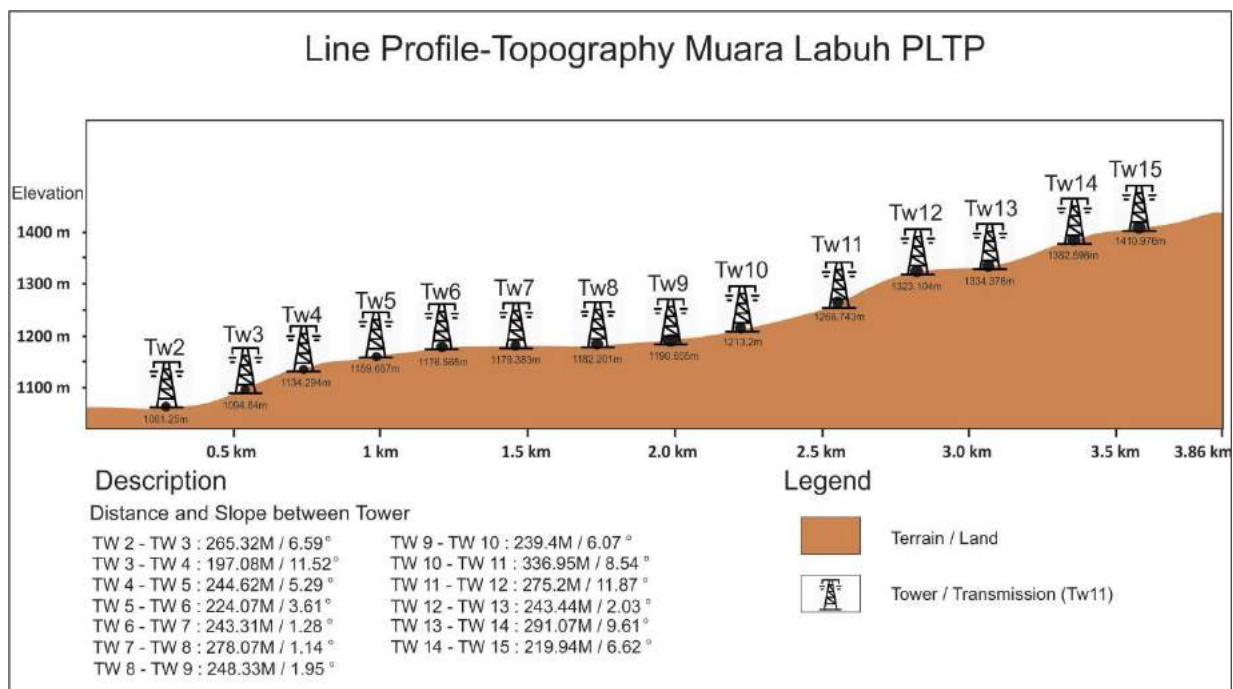

Figure 5. Final Result of the Profile of Topography Survey Location for the Transmission Tower Recommendation.

CONCLUSION

The development of Power Plant located on Alam Pauh Duo, Kecamatan Alam Pauh Duo, Solok Selatan is a potential area to build. This area has Geothermal In the area

of South Solok, or more precisely in the Muara Laboh, most of the hot springs associated with Muara Laboh located in a river valley Suliti, the basin tectonics (tectonic basin) along the 30 km and a width

of 2-3 km at an altitude of 450 meters above the sea level. The survey area has a landscape classified into Geomorphology Hills unit and Geomorphology High Hills Unit with a height of about 900-500m (meters). Based on survey data that has been obtained then produced a map that has a description field site power plant and transmission tower, this area has a potential to build 15 towers as the transmission line to distribute the electricity.

REFERENCES

- Dickson, M. H., & Fanelli, M. (2013). *Geothermal energy: utilization and technology*. Routledge.
- DING, Y., LIU, H., WAN, M., & XIAO, S. (2011). Three-Dimensional Digitalization Transfer of Ningdong-Shandong±660kV DC Power Transmission Pilot Project [J]. *Electric Power Construction*, 2, 010.
- Kausarian, H., Sumantyo, J. T. S., Kuze, H., Karya, D., & Panggabean, G. F. (2016). Silica Sand Identification using ALOS PALSAR Full Polarimetry on The Northern Coastline of Rupert Island, Indonesia. *International Journal on Advanced Science, Engineering and Information Technology*, 6(5), 568-573.
- Kausarian, H., Sri Sumantyo, J. T., Kuze, H., Aminuddin, J., & Waqar, M. M. (2017). Analysis of Polarimetric Decomposition, Backscattering Coefficient, and Sample Properties for Identification and Layer Thickness Estimation of Silica Sand Distribution Using L-Band Synthetic Aperture Radar. *Canadian Journal of Remote Sensing*, 43(2), 95-108.
- GAO, Y., YUAN, J. Z., MA, Z. W., & WAN, M. Z. (2007). Development and Application of Helava Technique Based 3D Digital Simulative System for Construction Management of Transmission Lines [J]. *Power System Technology*, 21, 016.
- Huang, P., Liu, R., Mo, J., & Fang, Z. (2016). Design of digital information share system in power distribution network. In *Information Science and Control Engineering (ICISCE), 2016 3rd International Conference on* (pp. 938-942). IEEE.
- Kausarian, H. Abdul Rahim Shamsudin, Yuniarti Yuskar. 2014. Geotechnical and Rock Mass Characterization Using Seismic Refraction Method At Kajang Rock Quarry, Semenyih, Selangor Darul Ehsan. *Journal of Ocean, Mechanical and Aerospace-Science and Engineering*, 13.
- Knott, E. F. (2012). *Radar cross section measurements*. Springer Science & Business Media.
- LI, Y. J., LI, B., & LI, S. S. (2012). Discussion on Application of the Power plant Three Dimensional Design. *China Electric Power (Technology Edition)*, 4, 012.
- MEI, N., CHEN, D., DU, X., YANG, Y., WANG, Z., & CHENG, W. (2012). Three-Dimensional Digitalization Transfer of Qinghai-Tibet±400 kV DC Interconnection Project [J]. *Electric Power Construction*, 5, 008.
- O'Rourke, T. D., & Palmer, M. C. (1996). Earthquake performance of gas transmission pipelines. *Earthquake Spectra*, 12(3), 493-527.

SHENG, D., QIE, X., HU, J., WU, Z., & QI, L. (2013). Conducting Research and Development of Grid Information Model (GIM) Technology and Constructing the Sharing Platform of Smart Grid Technology Information. *Electric Power Construction*, 8, 004.

Svacina, J. (1992). Analysis of multilayer microstrip lines by a conformal mapping method. *IEEE transactions on microwave theory and techniques*, 40(4), 769-772.

Wheeler, H. A. (1964). Transmission-line properties of parallel wide strips by a conformal-mapping approximation. *IEEE Transactions on Microwave Theory and Techniques*, 12(3), 280-289.

RELATIONSHIP BETWEEN ADOLESCENT CHARACTERISTIC AND BULLYING INCIDENTS AT PRIVATE JUNIOR HIGH SCHOOL IN PEKANBARU

Fathra Annis Nauli¹, Jumaini, Diva de Laura²

^{1,2}Department of Nursing, Faculty Of Nursing Universitas Riau

Abstract

Bullying is one of the most serious school violence for educators, parents, and the public. According to KPAI, bullying behavior increases every year, by 2015 bullies increased by 39%. The aim of this research was to identify the relationship between adolescent characteristic and bullying incidents at Private Junior High School in Pekanbaru. The data was conducted by 208 students. The univariate analysis was conducted to show respondent tcharacteristic and bivariate analysis was conducted by chi-square test. The result showshere was a relationship between ages and incidents of being an offender of bullying with p value $(0.036) < (0.05)$, but there is no relationship between ages and incidents of being a victim of bullying with p value $(0.064) > (0.05)$, gender and incidents of being an offender of bullying with p value $(0.384 > 0.05)$, gender and incidents of being a victim of bullying with p value $(0.438 > 0.05)$, and gender and bullying category with p value $(0.870 > 0.05)$. This research further can be a reference for schools to develop anti-bullying school in dealing with bullying

Keywords: *Adolescent Characteristic, Bullying, Bullying Incidents, Junior High School*

1. INTRODUCTION

The practice of bullying is one form of violence that occurs in schools who very apprehensive for educators, parents, and society. Schools should be a place for children to gain knowledge and form a positive personal character turned out to be a place of the growing of bullying practices (Wiyani, 2013). Currently bullying is recognized as a serious problem in the lives of children. Many children reported that they have been mocked, belittled, or victimized by other repeatedly by bullies at school (King, 2010). Bullying is a long-standing behavior that threatens all aspects of life,

socially unacceptable and also an abnormal and unhealthy behavior (Yayasan Semai Jiwa Amini, 2008; Rudi, 2010).

The phenomenon of bullying cases occurring in Indonesia was increasing every year, the incidence of bullying cases in schools from KPAI shows that children's violence in schools has increased by 4% from 2014 to 2015 by 461 cases to 478 cases. Furthermore, students who become perpetrators of bullying also increased by 39% in 2015 (KPAI, 2016). The Indonesian Child Protection Commission (KPAI) recorded 2,178 cases in 2011, 3,512 cases in 2012, 4,311 cases in 2013 and 5.066 cases in 2014 (Setyawan, 2015). KPAI also recorded 79 cases of children as bullying perpetrators in

schools throughout 2015. This case increased when compared to the previous year, which is as many as 67 cases throughout 2014 (Putera, 2015). For Pekanbaru through the Integrated Service Center for Women and Children Empowerment (P2TP2A) noted that in 2015 there were 98 cases of violence against children and women, of which 70% were cases of violence against children from bullying behavior (P2TP2A, 2016).

Due to the increasing cases of bullying in education, President Jokowi plans to publish a presidential regulation on anti-bullying in schools (Metro TV, 2015). This is a sad fact because the government (central and local) and the community are not able to prevent the recurrence of cases of violence, bullying in schools considering such acts violations of child rights have been protected by Law No. 23 of 2002 on Protection Children who have been renewed through Law 35 of 2014.

The Minister of Education and Culture (Kemendikbud) has issued Ministerial Regulation on Anti Bullying in the activity of new student orientation through Permendikbud Number 55 Year 2014 and Circular Letter Number 59389/ MPK/ PD/ 2015. However, the implementation is not as expect, bullying was still common forms of violence in the school orientation activities. Violence in MOS/ MOPD activities that ultimately lead to continuous bullying in a school.

Bullying behavior can occur because of several risk factors that can trigger the behavior, the trigger can comes from within the child, family, peers, and the environment. American Association of School Administrators (AASA) in 2009 revealed that these factors can occur singly or simultaneously.

Individual factors that can trigger bullying include: 1) Sex; 2) Have a history of being bullied; 3) Behave manipulative, impulsive, and aggressive; 4) lack of empathy; 5) Physically stronger than the victim; 6) Insufficient ability of children to solve problems constructively (AASA, 2009).

Characteristics commonly found in child who being victims of bullying include: 1) have low self-esteem; 2) absenteeism in high school; 3) look frightened at the time of going home and going to school; 4) cry often; 5) there are bruises that can't be described; 6) withdraw from social activities; 7) lose confidence; 8) often feel helpless; 9) shows signs of depression (AASA, 2009; Weston, 2010).

From the data, the researchers were interested in conducting research about relationship between adolescents characteristic and incidents of bullying. The incidents include the incidents of being an offender and a victim of bullying.

The purpose of this study was to identified the relationship between adolescent characteristic and bullying incidents at private junior high school in Pekanbaru. With that, research will provide benefits for government /school/ community/ stakeholder as an information about relationship between adolescent characteristic and bullying incidents, as a reference to the next research about bullying incidents and as basic data to implement the policy/ discipline about schooll anti bullying based on adolescent characteristic.

2. METHODOLOGY

This research uses descriptive correlative research design with cross sectional approach involving 208 respondents. Sampling obtained by purposive sampling in accordance with the inclusion criteria such as: high school students, students in schools that have the potential to experience bullying, healthy physical and spiritual, and willing to be a volunteer respondent.

The univariate analysis and bivariate analysis was conducted by chi-square test to show a relationship between respondent characteristics and incidents of being an offender or being a victim of bullying.

3. RESULT AND DISCUSSION

A. Univariate Analysis

Univariate analysis is used to obtain data on respondent characteristics including age and gender. Univariate analysis result shows:

Table 1: The frequency distribution of respondents based on the characteristics of respondents (students)

Characteristics	Total (n=208)	
	N	%
Age		
13 years	45	21.6
14 years	88	42.3
15 years	54	26.0
16 years	20	9.6
17 years	1	0.5
Total	208	100
Gender		
Male	99	47.6
Female/	108	52.4
Total	208	100

The results of the analysis in the table shows that from 208 respondents, the most age of the respondents was 14 years as many as 88 respondents (42.3%), while most of the

respondents are female as many as 108 respondents (52.4%).

B. Bivariate Analysis

1. Relationship between age and bullying incidents

Table 2: Relationship between ages and incidents of being an offender of bullying

Age (Years old)	Bullying Offender				Total		<i>p value</i>
	Yes		No		n	%	
	n	%	n	%			
13	4	8.9	41	91.1	45	100	0.036
14	13	14.8	75	85.2	88	100	
15	6	11.1	48	88.9	54	100	
16	11	55.0	9	45.0	20	100	
17	0	0.0	1	100.0	1	100	

Table 2 shows the most incidents of being an offender of bullying were happened on age 14 years old as much as 13 respondents (14.8%), following by age 16 years old as

much as 11 respondents (55.0%). Statistic shows p value 0.036 which means there was a relationship between ages and incidents of being an offender of bullying

Table 3 : Relationship between ages and incidents of being a victim of bullying.

Age (Years old)	Bullying Victim				Total		<i>p value</i>
	Yes		Tno		n	%	
	n	%	n	%			
13	12	26.7	33	73.3	45	100	0.064
14	22	25.0	66	75.0	88	100	

Age (Years old)	Bullying Victim				Total		<i>p value</i>
	Yes		Tno		n	%	
	n	%	n	%			
15	25	46.3	29	53.7	54	100	
16	8	40.0	12	60.0	20	100	
17	0	0.0	1	100	1	100	

From the table above, the most incident of being a victim of bullying happen in age 15 years old as much as 25 respondents, following by age 14 years old as much as 22 respondents. Result shows that p value was

0.064 which means there is no relationship between ages and incidents of being an victim of bullying

2. Relationship between gender and incidents of bullying

Table 4: Relationship between gender and incidents of being an offender of bullying

Gender	Bullying Offender				Total		<i>p value</i>
	Yes		No		n	%	
	n	%	n	%			
Male	19	19.2	80	80.8	99	100	0.384
Female	15	13.8	94	86.2	109	100	

Table 4 shows as much as 19 respondents (19.2 %) were male and being an offender of bullying when 80 other male respondents (80.8%) were not, and as much as 15 respondents (13.8 %) were female who being an offender of bullying when 94 other

female respondents (86.2 %) were not. Statistic shows p value was 0.384 which means there was no relationship between gender and incidents of being an offender of bullying.

Table 5: Relationship between gender and incidents of being a victim of bullying

Gender	Bullying Victim				Total		<i>p value</i>
	Yes		No		n	%	
	n	%	n	%			
Male	35	35.4	64	67.1	99	100	0.438
Female	32	29.4	77	70.6	109	100	

Table 5 shows as much as 35 respondents (35.4%) were male and being a victim of bullying when 64 other male respondents (67.1%) were not, and as much as 32 respondents (29.4%) were female and being a victim of bullying when

77 other female respondents (70.6%) were not. Statistic shows p value was 0.438 which means there was no relationship between gender and incidents of being a victim of bullying

Table 6: The difference of total incidents of bullying offender and victim based on gender

Gender	Offender				Victim				Total	
	Do		Don't		Do		Don't		n	%
	n	%	n	%	n	%	n	%		
Male	19	19.2	80	80.8	35	35.4	64	67.1	99	100
Female	15	13.8	94	86.2	32	29.4	77	70.6	109	100

From the table, the most offender of bullying was male as much as 19 respondents (19.2%) while female only as much as 15 respondents (13.8%). The

most victim of bullying also male as much as 35 respondents (35.4%) while female as much as 32 respondents (29.4%).

Table 7: Relationship between gender and bullying categories

Gender	Bullying Categories				Total		<i>p value</i>
	Low		Moderate		n	%	
	n	%	n	%			
Male	93	93.9	6	6.1	99	100	0.870
Female	104	95.4	5	4.6	109	100	

Table 7 shows as much as 93 respondents (93.9%) were male and were on low bullying categories when 6 other male respondents (6.1%) were on moderate category, and as much as 104 respondents (95.4 %) were female and were on low bullying categories when 5 other female respondents (4.6%) were on moderate category. Statistic shows p value was 0.870 which means there is no relationship between gender and bullying categories.

The result shows the most incidents of being an offender of bullying were happened on age 14 years old as much as 13 respondents (14.8%), following by age 16 years old as much as 11 respondents (55.0%). Statistic shows p value 0.036 which means there was a relationship between ages and incidents of being an offender of bullying. This research in line with Widoretno, Bektı, & Lailatul (2015) that shows there is a relation between age factors and bullying behavior in adolescent with p value (0.000)

Rigby (2010), stating that the incidence of bullying starts to increase in the final years of elementary school and reaches its peak when children enter high school. Bullying behavior events will begin to diminish with age. The age range of 12-16 years is believed to be more susceptible to bullying behavior, because at this age the bullying behavior of

children will begin to emerge (Slonje and Smith, 2007).

The most incident of being a victim of bullying happen in age 15 years old as much as 25 respondents, following by age 14 years old as much as 22 respondents. Result shows that p value was 0.064 which means there is no relationship between ages and incidents of being an victim of bullying

According to Puspitasari, Zaenal and Dian (2010) at the age of 15 years began to show the onset of bullying behavior in terms of the number of victims of bullying that initially only as many as 40 people (23.95%), then reached the peak at the age of 16 years where the number of victims of bullying increased by 56 people (33.53%) and 17 years old fell to as many as 41 people (24.55%). Targeted bullying children usually have internal characteristics such as having low self-esteem and self-esteem that make them easy targets for bullying (Perry, 2014).

As much as 19 respondents (19.2 %) were male and being an offender of bullying when 80 other male respondents (80.8%) were not, and as much as 15 respondents (13.8 %) were female who being an offender of bullying when 94 other female respondents (86.2 %) were not. Statistic shows p value was 0.384 which means there was no relationship between gender and incidents of being an offender of bullying.

This study is not in line with research conducted Susan (2013) in his research on bullying in the United States reported that there is a relationship on the occurrence of bullying in both sexes. Male gender occupied the higher level of the treatment of bullying to other students as much as 6% compared to female gender which only 4-5%. Fika's study (2012) on the relationship between the characteristics of primary school-aged children and bullying also explained that there was a significant relationship between sex and the occurrence of bullying and the results showed that boys were 5 times more likely to experience bullying than girls ($p = 0.011 < 0.05$).

As much as 35 respondents (35.4%) were male and being a victim of bullying when 64 other male respondents (67.1%) were not, and as much as 32 respondents (29.4%) were female and being a victim of bullying when 77 other female respondents (70.6%) were not. Statistic shows p value was 0.438 which means there was no relationship between gender and incidents of being a victim of bullying. Rohman's research (2016) obtained the results of crosstabulation test between sex with the tendency of being bullied victims from 81 respondents got the result that the tendency of victim of bullying is more found in male gender as much as 22 people (60%) than from female gender only 14 people (32%).

The most offender of bullying was male as much as 19 respondents (19.2%) while female only as much as 15 respondents (13.8%). The most victim of bullying also male as much as 35 respondents (35.4%) while female as much as 32 respondents (29.4%).

Sex differences are recognized as one of the risk factors that encourage bullying behavior (National Crime Prevention Center Canada, 2008). The results of this study indicate that boys are more likely to receive bullying because boys tend to behave physically aggressively, while

boys show more acceptance of bullying behaviors and are more often involved in bullying (AASA, 2009). Previous research conducted by Ediana (2013) on the analysis of factors affecting bullying behavior showed that bullying behaviors are more prevalent in men than women with 17.29 bullying on average more than women 16.04.

As much as 93 respondents (93.9%) were male and were on low bullying categories when 6 other male respondents (6.1%) were on moderate category, and as much as 104 respondents (95.4 %) were female and were on low bullying categories when 5 other female respondents (4.6%) were on moderate category. Statistic shows p value was 0.870 which means there is no relationship between gender and bullying categories. Lee's research (2009) shows that gender is not a dominant factor that relates to bullying behavior because sex is more decisive in the relationship between sex and bullying behaviors, the more sex the role plays in determining the type of bullying. Women are more likely to perform psychological bullying types than men and men are more likely to do physical bullying types than women

Boys although found to be more likely to use physical oppression than girls, but girls are more dominant using more verbal suppression than boys. This difference is more related to the socialization of men and women in our culture than with physical courage and size (Abdullah, 2013). Viewed from the characters based on male gender has masculine characters such as rational, assertive, competition, arrogant, orientation domination, calculation, aggressive, objective and physical. While the female characters are more feminine like emotional, flexible, cooperation, always succumb, orientation in relationships, using instinct, passive, nurturing and fussy (Rostyaningsih, 2010).

Based on the theory and related research described above it can be

concluded that men have tendency to behave bullying, especially physical contact than women, due to the masculine

4. CONCLUSION

The result shows there was a relationship between ages and incidents of being an offender of bullying with p value (0.036) < (0.05), but there is no relationship between ages and incidents of being a victim of bullying with p value (0.064) > (0.05), gender and incidents of being an offender of bullying with p value (0.384 > 0.05), gender and incidents of being a victim of bullying with p value (0.438 > 0.05), and gender and bullying category with p value (0.870 > 0.05).

SUGGESTION

For the nursing world, this research can be used as knowledge and insight for nurses and students about relationship between adolescents characteristic and incidents of bullying. For the world of education this research can be a reference about incidents of bullying. For the community this research can be information and knowledge about bullying behavior which still occur either in home environment or school so the society will be aware of bullying case around them. For later researchers this can be a reference for continuing research about incidents of bullying.

REFERENCES

Book:

- Abdullah, N. (2013). *Meminimalisasi bullying di sekolah*. Klaten: UNWIDHA.
- Sejiwa. (2008). *Bullying: mengatasi kekerasan di sekolah dan lingkungan sekitar anak*. Jakarta: Grasindo
- Wiyani, N. A. (2012). *Save our children from school bullying*. Jokjakarta: Ar-Ruzz Media.

character and aggression of adolescent boys.

Journal:

Lee, E. (2009). The relationship of aggression and bullying to social preference: differences in gender and types of aggression. *International Journal of Behavioral Development*. Accessed on 20 Oct 2016 <http://journals.sagepub.com/doi/abs/10.1177/0165025408098028>

Puspitasari, Y.P; Zaenal. A & Dian R. S. (2010). Hubungan Antara Dukungan Sosial Teman Sebaya dengan Kecemasan Menjelang Ujian Nasional (UN) pada siswa Kelas XII Reguler SMA Negeri 1 Surakarta. *Jurnal Penelitian Fakultas Psikologi Universitas Diponegoro*. Semarang: Universitas Diponegoro.

Rohman, M. Z. (2016). Hubungan antara usia, tingkatan kelas, dan jenis kelamin dengan kecenderungan menjadi korban bullying. *The 3rd University Research Qolloquium 2016*. Accessed on 19 Oct 2017 <https://publikasiilmiah.ums.ac.id/bitstream/handle/11617/6824/60.%20Moh%20Zainol%20Rohman.pdf?sequence=1>

Slonje, R. & Smith, P.K. (2007). Cyberbullying: another main type of bullying? *Scandinavian Journal of Psychology*. Accessed on 20 Oct 2017 <http://onlinelibrary.wiley.com/doi/10.1111/j.1467-9450.2007.00611.x/abstract>

Weston, F. (2010). Working with childer who have bullied. *British journal of school nursing*. Accessed on 20 Oct 2017 <http://www.westonps.org/uploaded/Policies/5000/5131.911.pdf>

Document of Agency:

- American Association of School Administrators. (2009). Bullying at school and online. Education.com Holding, Inc. Accessed at 19 Oct 2017 <http://www.aasa.org/content.aspx?id=218>
- Ediana, A. (2013). Analisis faktor-faktor yang memperngaruhi perilaku bullying pada peserta didik anak usia mi/sd: Jakarta: Lembaga Penelitian dan Pengabdian Masyarakat UIN Syarif Hidayatullah.
- Fika. (2012). Hubungan karakteristik anak usia sekolah dengan kejadian bullying di Sekolah Dasar X di Bogor. Accessed on 20 Oct 2017 http://lib.ui.ac.id/file?file=digital/20313561-S43718-Hubungan%20_karakteristik.pdf
- Komisi Perlindungan Anak Indonesia (KPAI). (2015). KPAI: Kasus kekerasan terhadap anak tiap tahun meningkat. Accessed on 27 Aug 2017 <http://www.kpai.go.id/berita/kpai-pelaku-kekerasan-terhadap-anak-tiap-tahun-meningkat/>

GREEN BEANS PLANT RESPONSE (*VIGNA RADIATA* L) ON LIQUID ORGANIC FERTILIZER (LOF) NASA AND NPK COMPOUND FERTILIZER

Ernita, M. Noer, Sidik Arif Irawan

Department of Agrotechnology Faculty of Agriculture Universitas Islam Riau

Email: ernitaur@agr.uir.ac.id

Abstract

The purpose of research is to know the effect of interaction and each of the main factors on growth and yield of Green Bean (*Vigna radiata*, L.) and determine the best response treatment. The research was conducted in experimental garden of Agriculture Faculty of Islamic University of Riau from November to February 2017. The research design used was a Factorial Randomized Complete Design consisting of 2 factors. The first factor is: LOF Nasa (P) concentration consisting of 4 levels: 0 cc / 1 water (P0), 2 cc / 1 water (P1), 4 cc / 1 water (P2) and 6 cc / 1 water P3) The second factor is: NPK Compound Fertilizer consisting of 5 levels ie: without NPK (N0), NPK Mutiara 16:16:16 18 g / plot (N1), NPK Mutiara 16:16:16 36 g / plot (N2), NPK Grower 18 g / plot (N3) and NPK Grower 36 g / plot (N4). The parameters observed were plant height, number of primary branch, number of effective root nodule, flowering age, harvest age, number of plant pods, percentage of pods, 100 dry seed weight and dry seed weight. The data were analyzed statistically and tested further with advanced test of real honest difference (BNJ) at 5% level. The results showed that interaction of LOF Nasa and NPK compound fertilizer had significant effect on: plant height, flowering age, number of pods, weight of 100 dry seeds and dry seed weight. The best response treatment is LOF Nasa 4 cc / 1 water and NPK Mutiara compound fertilizer 18 g / plot (P2N1). The main effects of LOF were significant on plant height, number of primary branches and number of effective root nodules, flowering age, weight of 100 dry seeds and dry seed weight per plant. The best response treatment was LOF concentration of 4 cc / 1 water (P2). The main effects of NPK compound fertilizer were significantly on plant height, number of primary branches, number of root nodules, flowering age, harvest age, number of plant pods, percentage of pods, 100 dry seed weight and dry seed weight. The best response treatment is NPK Grower 36 g / plot (N4) compound fertilizer.

Keywords: *LOF Nasa, NPK Compound Fertilizer, Green Bean (*Vigna radiata* L)*

1. INTRODUCTION

Green beans (*Vigna radiata* L) is one of the beans that have important nutritional and economic value after peanut and soybean crops. Nutritional content of green beans is beneficial in eye health, bones and teeth, reduces koleosterol, smooths blood flow, prevents colon cancer, anti-oxidants, improves the nervous system and helps in the formation of cells in the body (Anonimus, 2013).

According to Mustakim (2012), the nutritional content per 100 grams of green bean seeds consists of 345 calories, 62.9 g of carbohydrates, 22 g protein, 1.2 g fat, 125 mg of calcium, 320 mg of phosphorus, 6.7 mg of iron, 157 mg of vitamin A, 0.64 mg of vitamin B1, 0, 6 g of vitamin C and 10 g of water. Although green beans have many benefits and are agronomically advantaged compared to peanut and soybean crops where green bean plants have advantages such as more maturity, more drought tolerance, and relatively stable prices but green bean plants are less attention in their cultivation.

When viewed in terms of climate and land conditions owned, Indonesia is one of the countries that have the opportunity to export green beans. But until now domestic production is still low and has not been able to meet domestic needs. According to Anonimus (2015), the production of green beans in Riau in 2013 with harvested area reaches 585 ha with 619 tons production, in 2014 with harvested area reaching 598 Ha with production of 645 tons, then in 2015 with harvested area of 595 Ha with production of 619 tons (1.04 tons / ha).

The low production of green beans is partly due to low soil fertility and unbalanced fertilization. Solutions that can be done in overcoming these problems can be done with the provision of organic and inorganic

fertilizer (chemical). The use of compound fertilizers is an appropriate alternative in providing nutrients in a balanced state. Many types of compound fertilizers in the market include NPK Mutiara 16:16:16 and NPK Grower.

NPK Mutiara Fertilizer 16:16:16 is a compound fertilizer containing macro and micro nutrients that can be used for all types of plants as well as various conditions of land, climate and environment. This fertilizer is perfect for basic fertilization or follow-up and can also provide good nutrient balance for plant growth so it can support the plant to grow and develop properly. According to Anonimus, (2016), NPK Mutiara yaramila content is 16% N, 16% P₂O₅, 1% K₂O, 5% CaO and 1.5% MgO. Moses research results, (2016) showed that the use of NPK Mutiara with a dose of 300 kg / Ha can increase the growth and yield of green beans.

NPK Grower Fertilizer is a compound fertilizer containing macro and micro nutrients that plants need. According to Anonimus (2003), NPK grower fertilizer content is: 15% N, 9% P₂O₅ and 20% K₂O. In addition, NPK grower fertilizer contains 2% MgO, 3.80% S, 0.015% B, 0.020% Mn and 0.020% Zn. NPK Grower fertilizer can be used as basic fertilizer or fertilizer. Heruli research results, (2016) showed the use of NPK Grower fertilizer with the best dose of 300 kg / Ha in increasing the growth and production of green beans.

Excessive use of chemical fertilizers has a negative impact on the soil such as degradation of soil fertility, soil becomes acid, aggregate of soil becomes hard and solid. One alternative to maintain and maintain soil fertility and increase the yield of green pea plants is chemical fertilization must be accompanied by the provision of organic fertilizer either solid or liquid fertilizer.

Liquid organic fertilizer (LOF) is a solution of decomposition of organic materials derived from plant residues, animal waste that contain more than one element of the ingredients. The advantages of liquid organic fertilizer is able to overcome nutrient deficiency quickly because it can be absorbed quickly. Organic fertilizers generally do not damage soil and plants even though they are used as often as possible. In addition, LOF also has a binder so that the solution can be directly utilized fertilizer (Hadisuwito, 2012).

Nasa organic liquid fertilizer is one type of fertilizer that can be given to the leaves and soil, containing macro and micro nutrients, can reduce the use of Urea, SP-36 and KCl reach 12.5% - 25%, NOC nutrient content Nasa is N 0.12%, P₂O₅ 0.03%, K 0.31%, Ca 60.4 ppm, Mn 2.46 ppm (Anonymous, 2005). In addition LOF Nasa contains organic hormones such as auksin, cytokines, gibberellins that promote growth, rooting, flowering and fertilization in plants. The recommended concentrations in food crops and horticulture 2.5 - 3.0 cc / l water. While the results of research Barus, Khair and Anshar Siregar (2014), menunjukkan that the concentration of 4.0 cc / l of water is best in increasing the growth and production of green beans. Based on the above is expected with the provision of LOF nasa can reduce the need for NPK fertilizer and can determine the type of NPK compound fertilizer is best in improving the growth and production of green beans.

METHODOLOGY

The experiment was conducted in experimental garden of Agricultural Faculty of Islamic University of Riau for four months starting from November 2016 until February 2017. The materials used in this research were Vima-1 Varieties. LOF Nasa, NPK Mutiara 16:16:16 Yaramila, NPK Grower, Dithane M-45, Decis 25 EC, zinc

plate, wood and nail. While the tool used in this research is hoe, machetes, saws, hammer, meter, analytical scale, bucket, gembor, rakes, cameras and stationery.

This research uses Factorial Design 4 x 5 which is arranged in Completely Random with 3 replications. The first factor was the concentration of LOF Nasa (P) with 4 levels ie 0 cc / l water (PO), 2.0 cc / l water (P1), 4.0 cc / l water (P2) and 6.0 cc / l water (P4). The second factor is NPK compound fertilizer (N) consists of 5 levels, namely: Without compound fertilizer (NO), NPK Mutiara yaramila 18 g / plot (N1), NPK Mutiara yaramila 36 g / plot (N2), NPK Grower 18 g / plot (N3) and NPK Grower 36 g / plot (N4) to obtain 60 experimental units. Each experimental unit consists of 15 plants and 3 plants as sample plants. The observed data were analyzed statistically. If F arithmetic is bigger than F. The table then continued with a real test of honest difference (BNJ) at 5% level.

The field of research is cleaned and then done the processing of soil with a depth of 0-20 cm and the plot with the size of 1.2 x 1.0 meters as much as 60 plots, the distance between plots 50 cm.

The seeds to be planted are first inoculated with green bean soil with a ratio of 100 grams of soil / 0.5 kg of seeds, by wetting the seeds with a little water and then stirring evenly with soil. Inoculated seeds are then planted in a planting hole as much as 2 seeds per hole with a distance of 40 cm x 20 cm.

LOF Nasa was administered 4 times, giving the first one week before planting by splashing to soil and stirring evenly with dose of 600 ml / plot (50 liter / 100 m²). Subsequent administration by watering the soil on the crop line 3 times starting at 7 days with 10 days interval with wet criterion (age 7 days, 17 days and 27 days) as much as 600 ml / plot each giving so the LOF dose during the study as much as 2, 4 liters / plot.

The concentration used is adjusted for the treatment.

The giving of NPK Mutiara 16:16:16 and NPK Grower is done when planting by way of run with distance 7 cm distance from line of plant. The dose was adjusted for each treatment ie without NPK, NPK yaramila 18 g / plot (150 kg / ha), NPK yaramila 36 g / plot (300 kg / ha), NPK Grower 18 g / plot (150 kg / ha) and 36 g / plot (300 kg / ha).

Plant maintenance includes watering done 2 times a day ie in the morning and evening, except when it rains. After the plant is 4 weeks watering done 1 times a day. Thinning of plants is done by leaving one plant in each planting hole done at the time of the plant is a week after planting. Weeding and weeding is done first one week after planting next one week interval until completion of research. Furthermore, for pest control is sprayed Decis 25 EC with concentration 2 cc / 1 water and disease control used Dithane M-45 with dose 3 g / 1 water. The first spraying is done at the time of plant 1 week after planting, then done interval 2 weeks until plant age two weeks before harvest.

Parameters observed in the study included: plant height (cm), number of primary branches (fruit), number of effective root nodules (fruit), flowering age (day), harvest age (day), number of plant pods, (%), weight of 100 dry seeds (g), and dry seed weight of crop (g).

RESULT AND DISCUSSION

Plant height

The observation result of high green bean plants after the analysis of variance showed that in interaction of LOF Nasa and compound Fertilizer as well as their respective real major effect on green bean plant height. The average observation of green beans after being tested further with BNJ at 5% level can be seen in Table 1.

Table 1 shows that LOF Nasa and NPK Compound interacted gave significant different effect to plant height. The highest plant was found in LOF Nasa 4 cc / 1 water treatment and NPK Mutiara 18 g (P2N1) and LOF Nasa 6 cc / 1 water and NPK Mutiara 18 g (P3N1) with plant height 55.11 cm but no different from other treatments except with treatment of P1N0, P3N0, P3N2, P0N2, and P0N0.

The higher plant with LOF treatment caused LOF Nasa can improve the soil conditions that cause the growth of rooting of green beans plants well. LOF Nasa contains macro and micro nutrients, as well as humat acid and acid that can dissat dissolve chemical fertilizers in the soil so that the soil becomes more fertile and loose so that the roots growth goes well.

Good rooting and high availability of soil nutrients cause nutrient uptake to increase so as to improve the process of photosynthesis of green beans and then assimilate the results of photosynthesis can be utilized to spur plant growth. In addition, LOF Nasa also contains Auxin Growth Regulators, Giberelin and Cytokinins that can spur plant growth.

Table 1. The High Mean of Green Beans on the Treatment of LOF Nasa and NPK Compound Fertilizer (cm)

LOF Nasa (cc/l water)	NPK Compound fertilizer (g/plot)					Average
	0 (N0)	Mutiara 18 (N1)	Mutiara 36 (N2)	Grower 18 (N3)	Grower 36 (N4)	
0 (P0)	51, 99bc	53.11 abc	52.33 bc	51.66 c	52, 89abc	52.40 c
2 (P1)	51.89 bc	54.88 a	52.89 abc	53.44 abc	53, 11abc	53, 24b aircraft
4 (P2)	abc 53.33	55, 11a	54.89 a	54, 88a	55.22 a	54.69 a
6 (P3)	51.88 bc	55.11 a	52.33 bc	53.11 abc	54, 22ab	53.33 b
Average	52.27 c	54.55 a	53.11 bc	53, 27b	53, 86ab	

KK = 9.40% BNJ P = 0.78 BNJ N = 0.93 BNJ PN = 2.48

Figures on columns and rows followed by the same lower case are not significantly different according to BNJ at the 5%

According to Sampit (2012), in addition to ZPT other content of Nasa liquid organic fertilizer is humic acid and acid that can disat dissolve chemical fertilizers in the soil so that the soil will become loose. In addition it can be as a phosphorus solvent, helps stabilize pH, regulates movement and distribution of nutrients in the soil that creates an environment suitable for the proliferation of soil microorganisms that are beneficial to the plant.

Higher plant in LOF treatment 4 cc / l and NPK Mutiara 18 g / plot (P2N1) and LOF Nasa 6 cc / l water and NPK Mutiara 18 g / plo (P3N1) compared with other treatment. This is due to the treatment of Mutiara NPK 16:16:16 able to meet the nutrient needs, especially N needed by plants in the process of plant height growth in green beans. NPK compound Mutiara compound 16:16:16 is an inorganic fertilizer containing macro nutrients with a ratio of 16:16:16 can provide a good balance of nutrients for plants and can stimulate vegetative growth of plants. Given the NPK Mutiara 16:16:16 with a dose of 18 g / plot provides better nutrient requirements compared with other treatments. N nutrient content of NPK

Mutiara compared with NPK Grower is higher that is 16% while in NPK Grower 15%. This is why the plant height in the treatment of NPK Mutiara is higher than that of NPK Grower treatment.

NPK Mutiara Fertilizer 16:16:16 is a compound fertilizer containing main nutrient N (16%), P (16%), K (16%). The main role of nitrogen (N) for plants is to stimulate overall growth, especially branches, stems and leaves. Nitrogen also plays an important role in the formation of green leaves that are very useful in the process of photosynthesis. Another function is to form proteins, fats and various organic compounds (Marsono, 2011).

The better the conditions and the availability of soil nutrients so that photosynthesis will take place well that can be utilized properly in supporting the high growth of plants (Sandra, 2012).

Number of Primary Branches

The result of observation on the number of primer branches of green bean plants after the analysis of variance showed that the main influence of LOF Nasa and Majalah

Fertilizer respectively real to the number of primer branch of green bean plants. The average observation on the number of primer branches of green bean plants after further testing with BNJ at 5% level can be seen in Table 2.

Table 2 shows that the main effect of LOF Nasa and Compound Fertilizer is significantly different from the number of primer branches of green bean plants. Treatment of LOF that produces the most

number of primary branches found at concentration 4 cc / water (P2). This is because the treatment is the right concentration of LOF Nasa in improving the physical properties of soil chemistry and biology as well as improving the root system in plants. A good root system can cause the nutrient absorption process to run smoothly. In addition, LOF contains macro and micro nutrients that plants need in their growth including growth of primary branches.

Table 2. Number of Prime Branches of Green Beans on Treatment of LOF Nasa and NPK Compound (piece)

LOF Nasa (cc/l water)	NPK Compound Fertilizer					Average
	0 (N0)	Mutiara 18 (N1)	36 Mutiara s (N2)	Grower 18 (N3)	Grower 36 (N4)	
0 (P0)	3.77	4.11	3.77	3.53	4.33	3.90 c
2 (P1)	3.77	4.33	+ 4.55	4.00	4.66	4.26 b
4 (P2)	3.89	5.33	5.33	4.89	5.33	4.95 a
6 (P3)	3.77	4.44	4.00	3.89	5.00	4.22 bc
Average	3.80 d	+ 4.55 ab	4.41 bc	4.08 cd	+ 4.83 a	
KK = 8.10% BNJ P = 0.34 BNJ N = 0.41						

The numbers on rows and columns followed by the same lowercase letters show no significant difference according to the Advanced Test of Honest Real Difference (BNJ) at the 5% level.

The provision of compound fertilizers differed significantly with the number of primary branches where the most primary branches were found in NPK Grower 36 g / plot (N3) NPK fertilizer did not differ significantly from the treatment of Mutiara 16:16:16 of 18 g / plot. This is because NPK Grower and NPK Mutiara fertilizers provide the nutrients N needs in plant growth vegetative growth. According to

Reka (2012) that the number of branches formed in plants affected by varieties, plant spacing and soil fertility.

NPK Grower fertilizer contains N by 15% while NPK Mutiara fertilizer contains N 16%. Nutrient nutrients, especially N, cause the vegetative growth process of the plant to run well including the formation of primary branches.

Number of Effective Root

The result of observation of effective root nodule after variance analysis showed that NASA LOF interaction and compound Fertilizer had no significant effect, but each significant influence on the number of root nodules. Average observation of effective root nodule of green beans after being tested further with BNJ at 5% level can be seen in Table 3.

Table 3 shows that the main treatments of LOF Nasa and compound fertilizers each have a significant effect on the number of effective root nodules. The concentration of LOF Nasa differed significantly from the effective number of root nodules. The highest number of root nodules was treated

with LOF 4 cc / l water (P2) of 10.20 fruits different from other treatments while the lowest number of root nodules in treatment without LOF administration This is because LOF Nasa plays an important role in improving soil physical properties, can cause the soil is more friable. LOF Nasa also increases the availability of nutrients so that the soil becomes more fertile which causes better root growth. LOF Nasa at the right concentration of 4 cc / l of water that is able to increase the development of micro organism in soil that is useful for plant growth including Rhizobium bacteria found in root of green bean plant. Rhizobium bacteria bersimbiosis with roots of green beans with the better rooting of plants hence the symbiosis of rhizobium bacteria with roots can run well.

Table 3. Number of Effective Root Root of Green Bean Age Plant 28 Days At Treat of LOF Nasa and Compound Fertilizer NPK (piece)

LOF Nasa (cc/l water)	NPK Compound fertilizer (g/plot)					Average
	0 (N0)	Mutiara 18 (N1)	36 Mutiaras (N2)	Grower 18 (N3)	Grower 36 (N4)	
0 (P0)	6.33	9.00	7.00	is. ..	7.00	c is. ..
2 (P1)	7.67	10.00	9.00	7.00	8.67	8.47 b
4 (P2)	7.67	11.00	10.33	11.00	11.00	at 10 a
6 (P3)	is. ..	10.33	9.33	7.67	9.33	8.67 b
Average	7.09 c	at 10 a	8.92 ab	8.09 bc	9.00 ab	

KK = 3.90% BNJ P = 1.03 BNJ N = 1.23

The numbers on rows and columns followed by the same lowercase letters show no significant difference according to the Advanced Test of Honest Real Difference (BNJ) at the 5% level.

Nasa is a natural liquid organic fertilizer extract from natural ingredients besides containing macro and micro nutrients also comes with humat and fulfat acid that helps

stabilize the pH, regulate the movement and distribution of nutrients in the soil, will also create an environment suitable for the

proliferation of soil microorganisms that are useful for soil and plants (Anonimus, 2016).

The main effect of NPK compound fertilizer was significantly different from the number of effective root nodules. The highest number of root nodules was found in the NPK 18 p / plot (N1) NPK treatment although not significantly different from the NPK Mutiara 36 g / plot (N2) treatment and the NPK Grower 36 g / plot (N4) fertilizer while the lowest number of root nodules was treated without NPK but not significantly different with NPK Grower treatment 18 g / plot (N3).

Nitrogen present in NPK Mutiara and NPK Grower plays an important role in the formation of green leaf which is very useful in photosynthesis process. Another function is to form proteins, fats and various other organic compounds. In the roots of plant nuts, carbohydrate compounds, proteins and other compounds can be utilized bacteria for life (Anonimus, 2014).

Age Flowering

The observation of flowering age of green bean plants after the analysis of variance showed that interaction of LOF Nasa and compound fertilizer as well as their respective significant effect on flowering

age of green bean plants. The average observation of flowering age of green bean plants after further testing with BNJ at 5% level can be seen in Table 4.

In Table 4, it can be seen that LOF Nasa and NPK Compound interacted significantly different effect on flowering age of green bean plants. The fastest flowering plant is found in LOF Nasa 2 cc / l water treatment with NPK Mutiara 18 g (P1N1) and LOF Nasa 4 cc / l water with NPK Mutiara 18 g (P2N1) and LOF Nasa 4 cc / l water with NPK Mutiara 36 g / plot (P2N2). ie 30.33 hari. Lebih plant with LOF treatment 2-4 cc / water and NPK Mutiara 18-36 g / plot caused LOF Nasa can improve the soil conditions that cause the growth of rooting of green beans plants take place well because LOF Nasa contains nutrients macro and micro, as well as humat acid and acid that can dissat dissolve chemical fertilizers in the soil so that the soil becomes more fertile and loose so that the roots growth goes well. Good rooting and high availability of soil nutrients cause nutrient uptake to increase so as to improve the process of photosynthesis of green beans and then assimilate the results of photosynthesis can be utilized to spur plant growth.

Table 4. Flowering Age of Green Beans on Treatment of LOF Nasa and NPK Compound Fertilizer (days)

LOF Nasa (cc/l water)	NPK Compound fertilizer (g/plot)				Average	
	0 (N0)	Mutiara 18 (N1)	Mutiara 36 (N2)	Grower 18 (N3)	Grower 36 (N4)	
0 (P0)	c 33.00	31.67 abc	c 33.00	32.67 bc	32.67 bc	32.60 c
2 (P1)	32.00 abc	30.33 a	32.33 abc	32.67 bc	32.33 abc	31.93 b
4 (P2)	31.00 abc	30.33 a	30.33 a	30.67 ab	30.67 ab	30.60 a
6 (P3)	32.67 bc	31.00 abc	32.33 abc	32.33 abc	31.33 abc	31.93 b
Average	32.17 b	a 30.83	32.00 b	32.09 b	31.75 b	

KK = 2.10% BNJ P = 0.65 BNJ N = 0.77 BNJ PN = 2.06

The numbers on the rows and columns followed by the same lowercase letters show no significant difference according to the Advanced Test of Honest Real Difference (BNJ) at the 5%

NPK Mutiara 16:16:16 contains a phosphorus (P) element that can meet the nutrient needs of plants in the flowering process. Lingga and Marsono (2009), states that phosphorus for plants is useful for root growth, especially root seeds and young plants. Phosphorus serves as a raw material for the formation of certain proteins, assists assimilation and respiration, and accelerates flowering, ripening of seeds and fruit.

Suriatna (1987), suggests that in addition to Ca and Mg elements needed in the development of plants, phosphorus elements also play an important role in spurring root growth. A good root system causes the absorption of more nutrients smoothly, thus affecting the flowering process.

Harvest Age

The observation of the age of green bean crop after the analysis of variance showed that only the main influence of NPK compound fertilizer was real to the age of green bean crop harvest. The average observation on the age of green beans crop

after being tested further with BNJ at 5% level can be seen in Table 5.

Table 5 shows that compound NPK fertilizers differ significantly in the age of green bean harvest where the fastest harvest age was found in treatment of NPK Mutiara dose 16 g / plot (N1) 53,33 days although not significantly different with NPK Mutiara fertilizer treatment 36 g / N2) and NPK Grower fertilizer treatment 36 g / plot (N4) whereas the oldest harvest age was found without NPK fertilizer. This is due to phosphorus (P) contained in both types of fertilizers have been able to meet the nutrient needs of plants in the process of flowering and fertilization.

Lingga and Marsono, (2009) stated that the phosphorus element for plants is useful for root growth, especially root seeds and young plants. Phosphorus serves as a raw material for the formation of certain proteins, assists assimilation and respiration, and accelerates flowering, ripening of seeds and fruit

Table 5. Harvest Age of Green Beans On Treatment of LOF Nasa and NPK Compound Fertilizer (days)

LOF Nasa (cc/l water)	NPK Compound fertilizer (g/plot)					Average
	0 (N0)	Mutiara 18 (N1)	36 Mutiaras (N2)	Grower 18 (N3)	Grower 36 (N4)	
0 (P0)	at \$54.00	53.33	at \$54.00	at \$54.00	53.33	53.73
2 (P1)	54.33	53.33	54 RP	54.67	53.67	at \$54.00
4 (P2)	54.67	53.33	53.67	53.33	53.67	53.73

LOF Nasa (cc/l water)	NPK Compound fertilizer (g/plot)					Average
	0 (N0)	Mutiara 18 (N1)	36 Mutiaras (N2)	Grower 18 (N3)	Grower 36 (N4)	
6 (P3)	54.33	53.33	53.67	54.67	53.67	53.93
Average	54.33 c	53.33 a	53.84 ab c	54.17 b c	53.59 a b	
KK = 1.10% BNJ N = 0.74						

The numbers in the columns followed by the same lowercase letters show no significant difference according to the Advanced Test of Honest Real Difference (BNJ) at the 5%

Number of pods per plant (piece)

The result of observation of green bean plant pod number after the analysis of variance showed that interaction of LOF Nasa and compound NPK compound as

well as the real main effect to the number of green beans planting pods. The average observation of green bean pod number after further test with BNJ at 5% level can be seen in Table 6.

Table 6. Number of Green Beans Planted Peas at Treatment of LOF Nasa and Compound Fertilizer NPK (piece)

LOF Nasa (cc/l water)	NPK Compound fertilizer (g/plot)					Average
	0 (N0)	Mutiara 18 (N1)	36 Mutiaras (N2)	Grower 18 (N3)	Grower 36 (N4)	
0 (P0)	17.44 c	21.00 abc	21.00 abc	at 21:44abc	22.22 abc	20.62
2 (P1)	18.11 c	21.66 abc	22.55 abc	22.66 abc	24.55 a	21.91
4 (P2)	18.77 bc	24.77 a	20.88 abc	23:11 abc	23.00 abc	22:11
6 (P3)	at 19 abc	19.88 abc	24.78 a	21.00 abc	24.11 ab	21.84
Average	18.44 b	21.83 a	22.30 a	at 22 a	23:47 a	
KK = 8.6% BNJ P = 1.81 BNJ N = 2.16 BNJ PN = 5.73						

The numbers on rows and columns followed by the same lowercase letters show no significant difference according to the Advanced Test of Honest Real Difference (BNJ) at the 5% level.

Table 6 shows that LOF Nasa and NPK compound fertilizers interacted differently

in their effect on the number of green pea pods per plant. The highest number of pods

was found in LOF 4 cc / l water treatment with NPK Mutiara 16 g / plot (P2N1), P3N2 and P1N4. This is due to the complete nutrient obtained by plants resulting from the fertilizer of LOF Nasa and with the provision of NPK Mutiara 16:16:16 and NPK Grower containing elements of P and Ca so as to give effect to the formation of the number of pods.

LOF Nasa contains ZPT that can help the process of formation of the plant, accelerate the growth of plants, stimulate flowering and fruiting plants and prevent or reduce the level of loss of flowers and fruits in plants (Sampit, 2012).

Novizan (2005), suggests that a plant can produce well if the nutrient needs for plants are in a state of being fulfilled. NPK Compound Fertilizer meets the needs of plant nutrients especially P that plants need in the growth and development of plants. Proper and balanced nutrient fulfillment will result in the growth and development of vegetative crops well that will support the growth and development of generative plants including pod formation.

Percentage of Base Pod (%)

The result of observation of percentage of green bean plant pods after variation analysis showed only the main influence of NPK compound fertilizer significantly on the percentage of green bean planted pods. The average of observed percentage of pods

after being tested further with BNJ at 5% level can be seen in Table 7.

Table 7 shows that NPK compound fertilizers differ significantly on the percentage of green pea pods. The highest percentage of pods was found in the treatment of NPK Mutiara 18 g / plot and NPK Grower 36 g / plot was not significantly different with NPK Grower 18 g / plot and without NPK but significantly different with NPK Mutiara treatment 36 g / plot This was caused by compound fertilizer NPK contains Pospor, Ca, and Mg which play a role in seed formation.

Phosphorus contained in NPK fertilizer capable of absorbing green beans as a source of energy for the growth and development of plants that many are in development in the form of nucleotides that function as a compiler of RNA and DNA that play a role in the development of plant cells and as an enzyme activator. Phosphorus also plays a role in stimulating generative growth such as the formation of flowers, fruits and seed filling. NPK fertilization with the right dosage can cause the number of pods that contain increasing and will affect the percentage of pods.

The results of a variety can not be separated by adaptation or stability of appearance in the growing environment. The ability to produce number of packed pods is also determined by the varieties of plants. Vima 1 vaitas green bean plant is a superior variety that has the ability to produce good pods, including producing a number of pods.

Table 7. Percentage of Green Beans Planted Beans Pod in NOC LOF and NPK Compound Fertilizer (%)

LOF Nasa (cc / l air)	Pupuk Majemuk NPK (g/plot)				Rerata
	0 (N0)	Mutiara 18 (N1)	Mutiara 36 (N2)	Grower 18 (N3)	

0 (P0)	77,71	83,16	81,41	85,46	86,55	82,86
2 (P1)	86,06	89,68	72,77	80,47	88,67	83,53
4 (P2)	89,34	88,86	84,48	83,58	86,42	86,54
6 (P3)	90,03	91,10	73,50	88,46	88,97	86,41
Rerata	85,79 ab	88,20 a	79,04 b	84,49 ab	87,65 a	

KK= 6,74 % BNJ N = 6,67

The numbers on rows and columns followed by the same lowercase letters show no significant difference according to the Advanced Test of Honest Real Difference (BNJ) at the 5% level.

Weight 100 Dry Seeds

The observation result of weight of 100 dry beans of green bean plants after the analysis of variance showed that interaction of LOF Nasa and NPK Compound Fertilizer compound as well as the real major influence to the weight amount of 100 seeds of green beans. The average observation result of weight of 100 dry beans after further test with BNJ at 5% level can be seen in Table 8.

Table 8 shows that LOF Nasa and NPK compound fertilizers interacted significantly for the weight of 100 green beans seeds. The 100 heaviest seeds were found in LOF Nasa 4 cc / l water with NPK Mutiara 16 g / plot (P2N1). This is due to the benefits of LOF Nasa fertilizer that can increase the availability of macro and micro nutrients that plants need and improve the rooting and nutrient uptake so that the physiological process of the plant runs smoothly. In addition LOF Nasa contains

growth hormone regulator that is auksin, giberelin and cytokinin which can improve fertilization and seed formation. Nutrients N, P, K and other nutrients in a precise and balanced state contained NPK Mutiara compound are available in appropriate amounts so that plant growth takes place optimally, including in the formation of seeds and weight increase of seeds in this case the weight of 100 seeds of peanut plant green.

Dry Seed Weight Per Plant

The result of observation of dry bean weight of green bean planting after the analysis of variance showed that interaction of LOF Nasa and NPK Compound Fertilizer were compound and also the main influence on dry seed weight of green bean crop. The average of observation result of dry seed weight of cultivation after further test with BNJ at 5% level can be seen in Table 9.

Table 8. Weight of 100 Dry Seeds of Green Bean On Treatment of LOF Nasa and NPK Compound Fertilizer (g)

LOF Nasa	Pupuk Majemuk NPK (g/plot)				Rerata
(cc/l air)	0 (N0)	Mutiara	Mutiara	Grower	Grower
		16 (N1)	36 (N2)	16 (N3)	36 (N4)

0 (P0)	6,30f	6,27 f	6.33 f	6.40 ef	6.63 abcdef	6.39 c
2 (P1)	6,40 ef	6,90 abcde	6.73abcdef	6.50 def	6.90 abcde	6.69 b
4 (P2)	6,53cdef	7,10 a	6.87 ab	6.87abcde	7.03abc	6.88 a
6 (P3)	6,7 f	7,00abcd	6.30 f	6.57bcdef	6.97 abcd	6.62 b
Rerata	6,38 c	6,82 a	6,56 b	6,59 b	6.88 a	

KK = 2,40 % BNJ P = 0,15 BNJ N = 0,18 BNJ PN = 0,51

The numbers on rows and columns followed by the same lowercase letters show no significant difference according to the Advanced Test of Honest Real Difference (BNJ) at the 5% level.

Table 9. Dry seed weight of green beans on NOC LOF and NPK Compound Fertilizer (g)

LOF Nasa (cc/l)	Pupuk Majemuk NPK (g/plot)					Rerata
	0 (N0)	Mutiara 18 (N1)	Mutiara 36 (N2)	Grower 18 (N3)	Grower 36 (N4)	
0 (P0)	12.11 g	14.77efg	14.88 defg	15.44 defg	17.22abcde f	14.88 c
2 (P1)	14.78 efg	14.22 fg	16.22 bcdef	16.78abcde f	17.33abcde f	15.87 c
4 (P2)	15.44 def g	19.99 a	18.33 abc	17.33abcde f	19.44 ab	18.11a
6 (P3)	16.22bcde f	18.22 abcd	17.22abcde f	15.78 cdef	17.66 abcd e	17.02 b
Rerata	16,64 c	16,80 ab	16,66 b	16,33 b	17,91 a	
KK = 6,70 % BNJ P = BNJ N = 1,29 BNJ PN = 3,42						

The numbers on rows and columns followed by the same lowercase letters show no significant difference according to the Advanced Test of Honest Real Difference (BNJ) at the 5% level.

Table 9 shows that POC Nasa and NPK compound fertilizers interacted significantly for the weight of dry seeds per plant where the heaviest dry seed weight was found in POC Nasa 4 cc / l water with NPK Mutiara 16 g / plot (P2N1). This is due to the effect of nutrient availability found in the optimal POC Nasa on green bean plants so that the increase of photosynthesis and assimilat produced in the form of carbohydrates, proteins and amino acids needed in the formation of pods and seeds. In addition, the content of ZPT contained POC Nasa can reduce the loss of flowers and fruits.

The production of dry beans is closely related to the number of planting pods where the number and weight of the seeds is one of the components of the yield. The more number of pods and the weight of the seeds, the weight of dry beans per plant is also increasing. Sandra (2012), states that the high number of good crop production can be determined by the number of seeds of pith and weight. If the amount and weight of high seeds will cause the weight increase of dry seeds of plants and will affect the production of crops and vice versa if the number and weight is low then the production is

lower. Wijayanti, Purwanti and Adie, (2014) also stated that plant height, number of pods, seed weight have direct effect and have strong correlation to crop production, with high variability and heritability value.

When converted to crop production per Ha by Treat POC 4 cc / l and, 18 m Mutiaras of plot / plot of about 2.50 tonnes is not different from NPK Mutiara 36 g / plot with production of 2.29 tons. While the provision of POC 4 cc / l water and NPK Grower 36 g / plot 2.43 tons and not different with the provision of POC 4 cc / l water and NPK Grower 18 g / plot of 2.17 tons / ha. This proves by giving POC Nasa 4 cc / l water can save the use of NPK Compound fertilizer by 50%.

CONCLUSION AND SUGGESTION

Conclusion

Based on the results of this study can be concluded as follows:

1. The interaction of POC Nasa and NPK compound fertilizer has significant effect on

plant height, flowering age, number of plant pods, weight of 100 dry seeds and dry seed weight of the plant. The best responding treatment is POC Nasa 4 cc / l water and compound fertilizer NPK Mutiara 18 g / plot (P2N1)

2. The main effect of POC real to the plant height, the number of primary branches, the number of root nodules, the flowering age, the weight of 100 dry seeds and the weight of dry beans per plant. The best responding treatment was the concentration of POC 4 cc / l water (P2)

3. The main effect of NPK compound fertilizer significantly on plant height, number of primary branches, number of root nodules, flowering age, harvest age, number of plant pods, percentage of pods, weight of 100 seeds and dry seed weight of the crop. The best response treatment is NPK Grower 36 g / plot (N4) compound fertilizer.

Suggestion

Based on the results of this study to improve the growth and yield of green beans recommended the use of POC Nasa 4 cc / l water with the use of compound fertilizer NPK Mutiara with a dose of 150 kg / ha.

REFERENCES

- Admin. 2010. Bagaimana penggunaan pupuk organik cair nasa. <http://www.produknatural.com/tag/penggunaan-poc-nasa/>. Diakses tanggal 20 Februari 2016.
- Anonimus. 1994. Pupuk NPK Mutiara 16:16:16. PT. Meroke tetap jaya. Indonesia.
- Anonimus. 2003. Kandungan NPK Grower. Yaramila Internasional
- Anonimus. 2011. Pupuk Organik Cir Nasa (Pupuk Organik Cair Nusantara Subur Alami). <http://networkedblogs.com/q8Zmz?a=share>. Diakses tanggal 10 Oktober 2016.
- Anonimus. 2014. Mamfaat Kacang Hijau Untuk Kesehatan Sehat Alami. www.blogspot.com. Diakses 10 Oktober 2016.
- Anonimus. 2016. Formulasi dan Dosis Penggunaan Pupuk NPK Yang

- Tepat. www.kebunpediacom. Diakses 10 Oktober 2016.
- Anonimus, 2015. Luas panen, produksi dan rata-rata produksi kacang hijau tahun 2012-2015. Badan Pusat Statistik Nasional. 2015 URL: <http://www.bps.go.id/tmnmpgn.php?kat=3>. [2 Desember 2015].
- Anonimus, 2016. Mari Mengenal Fungsi Utama POC Nasa. Blogspot com. Diakses 5 April 2017.
- Barus, W. A., Hadriman K, H. dan Muhammad, A, S 2014. Respon Pertumbuhan Dan Produksi Kacang Hijau Akibat Penggunaan POC Dan Pupuk TSP. Fakultas Pertanian UMSU Medan. Jurnal Agrium. 19 (1): 1-11.
- Damari C, 2012. Toko online pupuk organik organik nasa natural nusantara cirebon. <http://pupuknasaonline.blogspot.com/2011/11/Poc-Nasa.html>. Diakses tanggal 10 Oktober 2016.
- Ernita, Maruli dan Gultom, 2012. Pengaruh Pemberian NPK Grower dan Kompos Terhadap Pertumbuhan dan Produksi Tanaman Cabe Rawit (*Capsicum frutescens* L) Jurnal Dinamika Pertanian XXVII (3) : 149-155
- Ernita, Khairizal dan Maruli, 2015. Aplikasi NPK Grower Pada Beberapa Varitas Kedelai . Faperta Universitas Islam Riau. Pekanbaru.
- Hadisuwito, S. 2012. Membuat Pupuk Organik Cair. Agromedia Pustaka. Jakarta.
- Irawan, S.A, 2017. Pengaruh POC Nasa dan NPK Mutiara Terhadap Pertumbuhan dan Hasil Tanaman Kacang Hijau (*Vigna radiata* L). Skripsi Faakultas Pertanian Universitas Islam Riau. Pekanbaru
- Heruli, T, 2016. Aplikasi NPK Grower dan Hormon Tanaman Unggul Pada Tanaman Kacang Hijau (*Vigna radiata* L)
- Hidayatullah. 2013. Pengaruh Jarak Tanam dan Pemberian Pupuk NPK Mutiara Terhadap Pertumbuhan dan Produksi Kacang Tanah (*Arachis hypogea* L.). Skripsi Fakultas Pertanian Universitas Islam Riau. Pekanbaru.
- Lingga dan Marsono, 2009. Petunjuk Penggunaan Pupuk. Penebar Swadaya. Jakarta.

- Marzuki, R. dan H.S. Soeprapto, 2004. Bertanam Kacang Hijau. Penebar Swadaya. Jakarta.
- Musa, A.R, 2016. Pengaruh Pemberian Limbah Ikan dan Pupuk NPK Mutiara (16 :16 : 16) Terhadap Pertumbuhan dan Hasil Kacang Hijau. Skripsi Fakultas Pertanian Universitas Islam Riau. Pekanbaru
- Novizan. 2005. Petunjuk Pemupukan Yang Efektif. Agro Media Pustaka. Jakarta.
- Nurahmi, E., Har dan Mulyani, S. 2010. Pertumbuhan dan hasil kubis bunga akibat pemberian pupuk organik cair nasa dan zat pengatur tumbuh hormonik. Fakultas Pertanian Universitas Syiah Kuala. Banda Aceh. Jurnal Agrista. 14 (1): 1-7.
- Pasaribu, S., Barus, A. Dan Kurnianto, H. 2011. Pengaruh Konsentrasi Dan Interval Waktu Pemberian Pupuk Organik Cair (POC) Nasa Terhadap Pertumbuhan Dan Produksi Jagung Manis. Fakultas Pertanian Universitas Muhammadiyah Sumatera Utara. Jurnal Agrium. 17 (1): 1-8.
- Purwono dan Hartanto, R. 2005. Kacang Hijau. Penebar Swadaya. Jakarta.
- Purwono dan Purnamawati. 2007. Budidaya 8 Jenis Tanaman Pangan Unggul. Penebar Swadaya. Jakarta
- Rukmana, R. 2004. Usaha Tani Tanaman Pangan Unggul. Penebar Swadaya. Jakarta.
- Sampit A, 2012. Petaniku dan Nasa, <http://wongtaniku.wordpress.com/tanya-jawab/>. Diakses tanggal 10 April 2017.
- Sandra, E. 2012. Hubungan unsur hara dan tanaman. Penerbit Rineka Cipta. Yogyakarta.
- Suryadi. 2010. Kandungan Pupuk Organik Cair Nasa. <http://wongtaniku.wordpress.com/2010/05/04/kandungan-pupuk-organik-nasa/>. Diakses tanggal 20 Oktober 2016.
- Sutisman, 2012. POC NASA (Pupuk Organik Cair Nusantara Subur Alami). <http://pupuknasaonline.blogspot.com/2011/11/poc-nasa.html>. Diakses tanggal 10 Oktober 2016.
- Wijayanti R,Y, S. Parwanti dan Adie M. M, 2014. Hubungan Hasil dan Komponen Hasil Kedelai (*Glycine max* L. Merril) Populasi F 5. Jurnal Vegetalika 3(4): 88-97.

ANALYSIS OF HUMAN RESOURCES WORK IN PRODUCTION ACTIVITY HYDROPONIC VEGETABLES COMMODITY (CASE STUDY: TECHNICAL IMPLEMENTATION UNIT OF AGRO GARDEN IN ISLAMIC UNIVERSITY of RIAU)

Darus¹, Hajry Arief Wahyudy²

1,2 Faculty of Agriculture, Universitas Islam Riau
Jl. Kaharuddin Nasution, Marpoyan, Pekanbaru 28284
Riau, Indonesia

Email: darus@agr.uir.ac.id

Abstract

Workload analysis needs to be done on hydroponic vegetable farming in Technical implementation Unit of Agro Garden in Islamic University of Riau to determine how many workers needed in completing the stage of work especially in the production process and how the right burden is delegated to one worker. The method used in this research is descriptive quantitative. Workloads are analyzed using Full Time Equivalent (FTE) calculations. The results of the identification of the stages of work on hydroponic vegetable farming in the Technical implementation Unit of Agro Garden in Islamic University of Riau consists of five stages, namely the preparation stage of planting, nursery, transplanting, maintenance, harvest and post harvest. Each stage has a specific description that has been adapted to the cultivation technology. FTE value obtained from the calculation that is equal to 0.01377 which indicates that the workload of employees are under under conditions. Solutions that can be recommended so that this business run effectively and efficiently is the application of Job Enrichment and Job Enlargement.

Keywords: *Full Time Equivalent, Workload, Hydroponics*

1. INTRODUCTION

1.1. Research Background

Technological advances have influenced various activities including production activities of goods or services at various companies engaged in various sectors, including agricultural companies. Agricultural barriers that constantly change as weather and natural resources is increasingly limited as agricultural land and raw materials to make the company should be more creative, effective and efficient in carrying out its production activities. So to face these barriers and keep productivity high, the company needs resources that are effective and efficient and responsive to change. Therefore, to produce effective and efficient resources the company needs to do the right target human resource planning to encourage the achievement of the company's vision and mission.

According to Edison (2010), Human Resource Planning (HR) is a process done systematically in order to prepare the availability of competent and qualified human resources in the field, and has a strong competitiveness in accordance with the direction of corporate goals. One of the companies that need to do the HR planning is the Technical implementation Unit of Agro Garden in Islamic University of Riau .

Technical implementation Unit of Agro Garden in Islamic University of Riau is a company that develops agribusiness model (agribusiness) with hydroponics Nutrien Film Technique (NFT) system. The resulting products are green lettuce vegetables, romaine, pakchoy, butterhead and kailan. Several varieties are marketed to several modern markets such as hyper mart and fruit market in Pekanbaru area. Company data shows that the average monthly production of vegetables reaches 300 kg per 462 m². The amount has not been able to meet the needs of the market that reached 1-1.5 tons / month in a sustainable manner. The big business opportunity owned by the Technical implementation Unit of Agro

Garden in Islamic University of Riau is hampered by the limited product produced, so in an effort to increase alternative production that can be done by companies such as by extending the planting land.

The expansion of new planting land would require the employees of the garden as the managers and the additional cost to pay their wages. Meanwhile, wages are the highest expenditure among other operational costs that must be issued by the company every month. Therefore, to avoid the occurrence of cost inefficiency then needed a better HR planning to fit the needs of the company as well as effective and efficient in helping the realization of corporate goals.

According to Marwansyah (2010), workload analysis is a process to establish the number of man-hours required to complete the workload within a certain time. Workload analysis aims to determine how many workers are needed to complete a job and how much appropriate burden is assigned to one worker.

Workload analysis is done through Full Time Equivalent (FTE) calculation. Human Resource Planning on Technical Implementation Unit Islamic University of Riau Agro Garden is still in the stage of improvement and development. In the Technical implementation Unit of Agro Garden in Islamic University of Riau has also not done the previous workload analysis, it is expected with the analysis of workload of resource management, Technical implementation Unit of Agro Garden in Islamic University of Riau can be better. Proper division of labor and appropriate employee placement in terms of both quantity and competence, is expected to influence and encourage productivity Technical implementation Unit of Agro Garden in Islamic University of Riau to be higher with cost efficient.

1.2. Problem Statement

As a new company developing a hydroponic farming system, the Technical implementation Unit of Agro Garden in Islamic University of Riau still has not been able to meet all market demand, although this business has been running for almost 3 years and the total area of the garden owned now reaches 7.5 Ha. Production limitations Technical implementation Unit of Agro Garden in Islamic University of Riau is influenced by several factors, including those related to the limited human resources owned. So to overcome these problems and to improve productivity required better human resource planning for existing human resources performance can be managed more effectively and efficiently.

One part of HR planning that can be done is workload analysis. Workload analysis aims to determine how many workers are needed to complete a job and how much appropriate burden is assigned to one worker (Marwansyah 2010).

1.3. Objective

To answer the problem, this research is done with purpose, that is: (1) Identifying work phase of Labor in producing hydroponics vegetables in echnical implementation Unit of Agro Garden in Islamic University of Riau (2) Analyzing work time in production activity of hydroponic vegetable commodity based on workload analysis through FTE calculation.

1.4. Benefits of Research

The benefits of this research include: (1) enriching science in the field of hydroponic agriculture, (2) development for other science, (3) adding hydroponic insight for practitioners.

2. RESEARCH METHODOLOGY

2.1 Method Place and Time Research

This study uses case study method on the Technical implementation Unit of Agro Garden Islamic University of Riau in Village Kubang Raya, Siak Hulu Subdistrict, Kampar District. Consideration of choosing the location of this research

because in the Technical implementation Unit Islamic University of Riau Agro Garden has never done analysis of workload before, it is expected with the analysis of workload of resource management, Technical implementation Unit Islamic University of Riau Agro Garden can be better

This research has been conducted for four months from December to April 2017. With activities including proposal making, proposal improvement, proposal seminar, field observation, data retrieval, analyzing data and writing final report..

2.2 Determination Method of Respondents

The determination of respondents was done purposively (sampling sampling) on organic vegetable farming in Technical implementation Unit Islamic University of Riau Agro Garden. Respondents consist of production and marketing managers who are expected to provide information in accordance with the needs of research.

2.3 Method of collecting data

The data collected in this research is primary data and secondary data. Primary data was obtained through direct observation and interviewing the garden manager using a prepared questionnaire, ie data and information related to the management of the hydroponics vegetable farm at Agro Garden in Islamic University of Riau.

Types of primary data collected include: production activities calculated based on the length of the work process or the stages of vegetable cultivation in Technical implementation Unit Islamic Agro Garden in University of Riau. Secondary data is complementary data sourced from related relevant literature.

2.4 Analyst of Data

Analysis of data to be used in this study can be explained as follows.

2.5 Identification of Stages of Labor Work on Hydroponics Vegetable Farming In Technical implementation Unit of Agro Garden in Islamic University of Riau.

To identify the job description of Hydroponics Vegetable Farming in Technical implementation Unit of Agro Garden in Islamic University of Riau, will use qualitative descriptive analysis through explanation of series of effective work stages observed in accordance with technology of vegetable cultivation in hydroponics NFT.

2.6 Workload Analysis Activity Production of vegetable commodities hydroponics at Technical implementation Unit of Agro Garden in Islamic University of Riau

To analyze the workload of hydroponic vegetable commodity production activity In the Technical implementation Unit of Islamic University of Riau Agro Garden, will use quantitative descriptive analysis through Full Time Equivalent (FTE) calculation.

Information:

F = Frequency of activity performed

WA = time allocated to complete the work

WPT = the amount of time used to complete the job

FTE = Full Time Equivalent

Employee needs can be calculated after the completion of the task is determined. The number of personnel needs is calculated by dividing the total number of task completion times by effective working time and then multiplied by one person.

3. RESULT AND DISCUSSION

3.1. Result of Identification Job Description of Labor on Hydroponics Vegetable Farm Of Technical implementation Unit of Agro Garden in Islamic University of Riau

To identify the job description on hydroponic vegetable farming in Technical implementation Unit of Agro Garden in Islamic University of Riau, it is necessary to explain about hydroponic vegetable cultivation technique as applied to the farm.

3.1.1. Cultivation Technique

Technically, the cultivation of hydroponics vegetables in Agro Garden Islamic University of Riau using Nutrien Film Technique (NFT) method. This method has not been used by farmers in general, therefore the translation of this technique is expected to be a feasible guide to benefit hydroponic farming.

a. Preparation of Planting Media

Planting media used in the cultivation of hydroponic vegetables at Agro Garden in Islamic University of Riau is cocopeat or coconut powder.



Figure 3. Media Cocopeat, Netpot and Netpot Tray.

As a place of planting medium used netpot with height 6 cm and diameter of 5 cm filled media garden with weight 0,40 kg, besides also used netpot tray as netpot place which has been filled with planting medium and seed for breeding. Netpot tray has a width of 35 cm and 70 cm long, in a netpot tray can be filled as much as 40 netpot.

b. Seed Selection

Selection of seeds in the cultivation of hydroponic vegetables is very important because as a benchmark high low productivity of hydroponic cultivation. Seeds used in the cultivation of hydroponic vegetables in Agro Garden Islamic University of Riau are mostly still using imported seeds. The selection of seeds in the study was in accordance with the opinion of Haryanto (2007), which states that the selection of seed is very important because the productivity of the plant depends on the benefits of selected seed

c. Seedling Seed

Seedlings for small seeds are done by placing the seeds above the netpot that has been filled with the planting medium. For green lettuce, red lettuce, butterhead and mustard pakcoy the seeds used in the netpot are only 1 seed per netpot. After finishing the seedbed the seeds are stored in a green house, before the netpot tray is covered with black plastic tarpaulin / plastic first watered using clean water. Closure using plastic / black tarpaulin is done for 2-3 days until the seeds germinate.



Figure 4 Seedling Technique of Vegetable Hydroponics NFT.

d. Nurseries

After the seeds 2-3 cm in size then given nutrients 1.5 cc every day for 10 days. Provision of nutrients is done every day so that when the seeds have reached the age to be transferred to the greenhouse treatment, the seeds can absorb nutrients so that the seeds can grow well.



Figure 5. Ten-day Hydroponics Vegetable Seeds

e. Transplanting

Before transferring the 2-week-old seedlings to the greenhouse the treatment is firstly selected for seedlings that already have roots that come out of the netpot 1-2 cm long, this is done so that the plants that have been transferred to the greenhouse

treatments can absorb nutrients well. Before moving the vegetable seeds, fill the container of water and give nutrition as much as 1.5 cc. Transfer the seeds from the nursery greenhouse by bringing the netpot tray to the treatment greenhouse and inserting the netpot into each gutter. Gutter is used as a hydroponic vegetable treatment plant that has been removed from the nursery, where the gutter has a length of 6 meters and has a hole netpot of 28 holes. In 1 rack gutters can be filled with 6 gutters along the 12 meters means that in 1 rack gutters have a hole netpot as much as 336 holes.

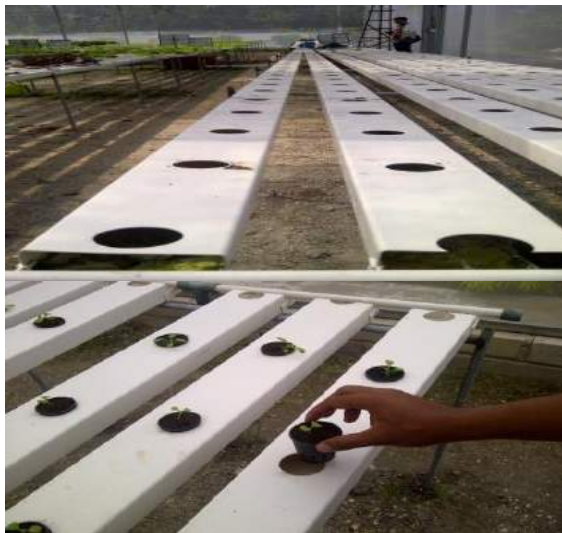

Figure 6. Gutters and Seed Transfer Process

f. Giving Nutrition

Nutrition is essential for the development of NFT hydroponics vegetables. Nutrition used consists of two groups, namely nutrition wiraagro A and wiraagro B. Nutrition wiraagro A with $\text{Ca}(\text{NO}_3)_2 \cdot 4\text{H}_2\text{O}$, $(\text{CH}_2\text{N}(\text{CH}_2\text{COO})_2)_2$ and wiraagro B with KNO_3 , KH_2PO_4 , MgSO_4 content. $7\text{H}_2\text{O}$, $\text{MnSO}_4 \cdot \text{H}_2\text{O}$, H_3BO_3 , $\text{CuSO}_4 \cdot 5\text{H}_2\text{O}$, $(\text{NH}_4)_6\text{Mo}_7\text{O}_{24} \cdot 4\text{H}_2\text{O}$. Both nutrients A and B are each thawed in a vat containing 100 liters of water for a sack of wiraagro nutrients. Nutrition wiraagro A and B are given with the same dose.

Nutrition is done daily with different doses according to the age of the plant.

Nutrition dose with 1 week of plant age is 1.5 cc 2 weeks age is 1.8 cc 3 weeks age is 2 cc, and age 4 weeks until harvest as much as 2.5 cc. The nutrient solution has EC 1.5mS / cm in the 2-week NFT hydroponic vegetable crop while the nutrient solution for the 3-week-old plant to panaan has an EC 2.5-3 mS / cm



Figure 7. Nutrition and Nutrition Delivery Process

g. Treatment Plant

The treatment of hydroponic NFT vegetables is done with special attention. Hydroponic plants are particularly vulnerable if water and nutrient content are not circulated perfectly, causing the plants to die. Treatments include: checking the nutrient content in the water reservoir, checking the pH of water, checking the water pipes to avoid clogging with dirt, cleaning the water container once every 10 days to avoid bacteria that can interfere with hydroponic vegetable crops, the selection of plants contaminated by disease so as not to spread to other

plants and clean the weeds that grow under the rack gutters.



Picture 8. Checking the pH of Water and Hydroponics Equipment NFT

h. Harvest and Post Harvest

Harvesting is done at the age of 28-30 day hydroponic vegetables by selecting qualified hydroponic vegetables. Harvesting using a knife or scissors by cutting the stem of the plant. Harvesting is done when the vegetables will be sent to the consumer, this is done so that hydroponic vegetables remain in a fresh state.

The marketing of hydroponic vegetables is heavily influenced by post-harvest treatment. After the hydroponic vegetables are cut then weighed using electric scales then in packing using clear plastic labeled Islamic University of Riau and pressed to be protected and easy in marketing.

3.1.2 Results of Workplace Stage Identification

Based on the observations, it can be identified the stages of work in the process of producing hydroponic vegetables as follows:

Table 3 Identification of Occupational Stages in the process of producing hydroponic vegetables

No	Steps	Description Stage
1	Preparation of planting	<ul style="list-style-type: none"> - Preparing the media cocopeat - Cleaned the remaining cocopeat on the netpot and the previous nursery tray - Enter cocopeat into netpot - Clean gutter and sink - Checking the performance of water pump machines and electrical installations - Sterilized greenhouse from pest by spraying insecticide
2	Seedlings and nurseries	<ul style="list-style-type: none"> - Choosing a quality seed - Plant the seeds into the netpot that has been prepared on each tray - Watering the nursery - Close the seedbed with plastic / black tarpaulin to accelerate the growth of sprouts - Perform routine maintenance (nutrition and anticipation of pests and diseases) - Doing embroidery (replacing dead plants with new ones) - Selecting plant seeds to be moved into the gutter rack

No	Steps	Description Stage
3	<i>Transplanting (transfer phase from pre nursery to main nursery)</i>	<ul style="list-style-type: none"> - Fill the water reservoir - Submit nutrients in shelter - Measure the concentration of the solution as needed - Measuring the pH of water - Transfer the seeds that are 2 weeks old to the greenhouse and placed on each plant hole on the gutter
4	Maintenance	<ul style="list-style-type: none"> - check the nutrient content in the water reservoir, - check the pH of water, - checking the water pipes to keep them from getting clogged with dirt, - clean a water container on 10 days to avoid bacteria that can interfere with hydroponic vegetable crops, - Selecting the plants contaminated by the disease so as not to spread to other plants - Clean the weeds that grow under the rack of gutters.
5	Harvest and post harvest	<ul style="list-style-type: none"> - Cutting plants that can already be harvested - Standardize and grading vegetables of similar size and quality - Ready the weight of vegetables as per packing requirement - Packing vegetables with labeled plastic - Making a plastic packing pressing - Deliver vegetables to the destination markets.

The results of identification of the stages of work on hydroponic vegetable farming in the Technical implementation Unit Islamic University of Riau Agro Garden shows that there are five stages to be done, namely from the preparation of planting media to post-harvest. This activity is routinely done every production period that is for more or less 45 working days.

3.2. Workload on Production Activities of Hydroponics Vegetable Commodity at Technical implementation Unit of Agro Garden In Islamic University of Riau

In agricultural activities, effective timing differs from the effective timing of other activities. This is because human resources such as farmers do a series of work every day. Technical implementation Unit of Agro Garden in Islamic University of Riau is a business engaged in agriculture, namely hydroponic agriculture with the main product of vegetables that perform daily production activities.

Based on observations and interviews, the number of working days in a year is 365 days, then minus the day of the week per year that is 52 days, national holiday 18 days, leave 14 days to get the number of working days is 281 working days in a year. Working time in one day ie for 8 hours. So in a year produces effective working time of 2,248 hours per year with an average efficiency factor of 87.5% or 118,020 minutes/year.

3.2.1. Productive Working Time

What is meant by productive activities are all activities related to the main tasks and job descriptions of employees, so it can be said that apart from it is an activity that is not productive. Based on the concept, the productive working time in hydroponic vegetable farming in Technical implementation Unit of Agro Garden in Islamic University of Riau is the time used only to perform the stages of work as described earlier.

Observation result of productive working time employed by employees in hydroponics vegetable farming in Technical

implementation Unit of Agro Garden in Islamic University of Riau can be seen in Table 4.

Table 4. Productive Working Time Per Production Process at Stages of Hydroponics Vegetables Work in Technical Implementation Unit of Agro Garden In Islamic University of Riau

No	Job Stage	Productive Time	
		Minutes	Percent
1	Preparation of planting	2.520	25,85
2	Seedlings and nurseries	1.650	16,92
3	Transplanting	420	4,31
4	Maintenance	4.320	44,31
5	Harvest and post harvest	840	8,62
	Total	9.750	100,00

In Table 4.2 it can be explained that the highest use of productive work time is at the stage of plant care of 44.31%. Based on the observation, it is known that the stages of work is an activity of vegetable production process that is very important and requires special attention and accuracy in the process, such as checking the nutrient content in the water reservoir, checking the water ph, check the water pipe so as not clogged by dirt, water on every 10 days to avoid bacteria that can interfere with hydroponic vegetable crops, selecting plants contaminated with the disease so as not to spread to other plants, to clean weeds that grow under the gutters.

Furthermore, the lowest productive working time is at the stage of transplanting plants from pre nursery to main nursery of 4.31%. Based on the observation, it is known that the job activity is a one-time work activity in the production process, such as filling the water reservoir, dissolving the nutrients in the storage basin, measuring the concentration of the solution as needed, measuring the pH of water, transferring the seeds that are 2 weeks old greenhouse and placed on each plant hole on the gutter.

Based on the explanation of the use of productive working time, it can be calculated also how much work time that

has not been productive in order to be utilized by the management in managing hydroponics vegetable farming in Technical implementation Unit of Agro Garden in Islamic University of Riau to be more efficient.

If it is assumed that the duration of work in one production process is 45 working days, one working day is calculated for 8 hours, then the available time is 21,600 minutes. In addition, based on the previous calculation, it is known that productive working time is 9,750 minutes. So that the working time is not productive as much as 11,850 minutes. This indicates that there is time left for the management to empower the workforce (employee) on other productive activities so that the allocation of labor usage can be optimized.

3.2.2. Work Time Optimization Through Calculation Full Time Equivalent (FTE)

The method of calculating workload with FTE is the time calculation method used to complete various jobs compared to the effective working time available. FTE aims to simplify work measurements by changing hours of workload to the number of people needed to complete a particular job. Table 5 shows the calculation of

workload and FTE for employees Technical implementation Unit of Agro unit in Islamic University of Riau.

Table 5. Workload and FTE calculations for employees Technical implementation Unit of Agro Garden in Islamic University of Riau

No	Activity	F	WA	WPT	FTE
		(times / year)	minutes	minutes	Mins/year
1	Preparation Planting	6	2520	420	0,00356
	Preparing the media cocopeat	6	240	40	0,00034
	Clean up the remaining cocopeat on the netpot and the previous nursery tray	6	960	160	0,00136
	Insert the cocopeat into the netpot	6	480	80	0,00068
	Cleaning gutter and reservoir	6	480	80	0,00068
	Check the performance of the water pump machine and electrical installation	6	120	20	0,00017
	Sterilization of greenhouse from pest by spraying insecticide	6	240	40	0,00034
2	Seedlings and nurseries	6	1650	275	0,00233
	Choosing a quality seed	6	60	10	0,00008
	Plant the seeds into the prepared netpot on each tray	6	120	20	0,00017
	Watering the nursery	6	60	10	0,00008
	Closed the seedbed with plastic / black tarpaulin to accelerate the growth of sprouts	6	30	5	0,00004
	Perform routine maintenance (nutrition and anticipation of pests and diseases)	6	1200	200	0,00169
	Perform stitching (replacing dead plants with new ones)	6	60	10	0,00008
	Selecting plant seeds to be moved into the gutter rack	6	120	20	0,00017
3	Transplanting	6	420	70	0,00059
	Filling the water reservoir	6	60	10	0,00008
	Dissolving nutrients in a reservoir	6	60	10	0,00008
	Measure concentration of solution as needed	6	30	5	0,00004
	Measure water pH	6	30	5	0,00004
	Transfer the seeds that are 2 weeks old to the greenhouse and placed on each plant hole on the gutter	6	240	40	0,00034

No	Activity	F	WA	WPT	FTE
		(times / year)	minutes	minutes	Mins/year
4	Maintenance	6	4320	720	0,00610
	checking the nutrient content in the water reservoir,	6	900	150	0,00127
	checking the pH of water,	6	900	150	0,00127
	checking the water pipeline so as not to be clogged by dirt,	6	900	150	0,00127
	cleaning the water container once every 10 days to avoid bacteria that can interfere with hydroponic vegetable crops,	18	360	20	0,00017
	Dissecting plants contaminated by the disease so as not to spread to other plants	6	900	150	0,00127
	Clean the weeds that grow under the gutters rack.	6	360	60	0,00051
5	Harvest and Post-harvest	6	840	140	0,00119
	Cut plants that can be harvested	6	240	40	0,00034
	Standardize and grading vegetables of similar size and quality	6	120	20	0,00017
	Weighing vegetables according to packing needs	12	60	5	0,00004
	Packing vegetables with labeled plastic	6	120	20	0,00017
	Perform plastic packing pressing	6	60	10	0,00008
	Deliver vegetables to the destination markets	6	240	40	0,00034
FTE Total					0,01377

Information:

F = Frequency of activity performed

WA = time allocated to complete the

WPT = the amount of time used to

FTE = Full Time Equivalent

work

complete the job

Dewi and Satrya (2012) reveal the implication of FTE value is divided into 3 types namely overload, normal, and underload. Based on the workload analysis guidelines issued by the State Personnel Board in 2010, the total FTE index value above the 1.28 value is considered overload, between 1 to 1.28 is considered normal whereas if the FTE index value is between 0 up to 0.99 is considered underload or workload is still lacking. Therefore, based on the calculation results obtained FTE value on hydroponic vegetable farming in Technical implementation Unit Islamic University of Riau Agro Garden of 0.01377 which indicates that the workload of employees are under under conditions.

In the collection of hydroponic vegetable production activities, there are activities that can be done together with

other activities. At the maintenance stage there is activity of checking nutrient content in water reservoir, water pH, pipeline. The activity can be done in conjunction with the activity of sowing plants contaminated with the disease so as not to spread to other plants and to clean the weeds that grow under the gutters. Likewise with other activities that can be combined because the process is the same time.

Activities that can be eliminated or done simultaneously can change the working time to be more effective, so that the necessary improvement on hydroponic vegetable production activities that enable to make these activities more effective. In most cases, improvements are made with the addition of technology. Therefore, the improvement of technology to be one recommendation that can be given to the

business of hydroponics vegetables in the Technical implementation Unit of Agro Garden in Islamic University of Riau.

3.2.3. Number of Manpower Requirements

Workload analysis and employee requirement calculation are basic of HR planning in Technical implementation Unit of Agro Garden in Islamic University of Riau. Human resource planning is a key function that must be implemented within the organization, to ensure that the right workforce is available to occupy the right positions, positions and jobs at the right time. All of that is in order to achieve the goals and targets that have been and will be determined (Sutrisno 2010). Mistakes in human resource planning can have a negative impact on business because they can lead to major organizational inefficiencies related to labor financing.

The result of the research indicates that the number of manpower available has less workload (under load). The current number of workers is three, consisting of one manager, one administration and one technical executive. Therefore, if labor reduction policy can not be done, there are some solutions that can be recommended so that this business can run effectively and efficiently.

First, Job Enrichment. Job Enrichment is a fundamental change in the content and obligations of a work that gives a greater challenge to employees (Mondy 2008). Job Enrichment can be applied to off farm activities.

Second, Job Enlargement. Job Enlargement is an increase in the number of tasks an employee has to perform, where all the tasks are at the same level of responsibility (Mondy 2008). If the current HR administration only doing financially and marketing only, then the job enlargement of human resources administration can also do activities related to the production process.

4. CONCLUSION

1. The identification of stages of work on hydroponic vegetable farming in Technical implementation Unit Islamic University of Riau Agro Garden consists of five stages, namely the preparation stage of planting, nursery, transplanting, maintenance, harvest and postharvest. Each stage has a specific description that has been adapted to the cultivation technology.
2. FTE value on hydroponic vegetable farming in Technical implementation Unit Islamic University of Riau Agro Garden of 0.01377 indicating that the workload of employees are under under conditions.

5. SUGGESTION

Mistakes in HR planning can have a negative impact on business because it will lead to the inefficiency of major organizations related to labor financing. If labor reduction policy can not be done, then the recommended solution for this effort to run effectively and efficiently is the application of Job Enrichment and Job Enlargement.

REFERENCES

- Adawiyah, W. dan Sukmawati, A. 2013. Analisis Beban Kerja Sumber Daya Manusia dalam Aktivitas Produksi Komoditi Sayuran Selada (Studi Kasus: CV Spirit Wira Utama). *Jurnal Manajemen dan Organisasi* Vol IV, No. 2. Hal 129-143.
- Dewi, U. dan Satrya, A. 2012. Analisis Kebutuhan Tenaga Kerja Berdasarkan Beban Kerja Karyawan Pada PT PLN (Persero) Distribusi Jakarta Raya dan Tangerang Bidang Sumber Daya Manusia dan Organisasi. Jurusan Manajemen SDM Fakultas Ekonomi Universitas Indonesia:
<http://www.aisi.or.id/statistic/>

- diakses pada tanggal 9 September 2013.
- Edison, E. 2010. *Human Resource Development* Pengembangan Sumber Daya Manusia. Alfabeta, Bandung.
- Haryanto, W, T. Suhartini dan E, rahayu. 2007. Teknik Penanaman Sawi dan Selada Secara Hidroponik. Penebar Swadaya.
- Kementerian Pendayagunaan Aparatur Negara Republik Indonesia. 2004. Pedoman Perhitungan Kebutuhan Pegawai Berdasarkan Beban Kerja dalam Rangka Penyusunan Formasi Pegawai Negeri Sipil (Kep. Men.PAN Nomor: KEP/75/M.PAN/2004). Kementerian Pendayagunaan Aparatur Negara Republik Indonesia.
- Marwansyah. 2010. Manajemen Sumber Daya Manusia Edisi Kedua. Alfabeta, Bandung.
- Mondy RW. 2008. Manajemen Sumber Daya Manusia, Jilid 1 Edisi 10. Jakarta (ID): Erlangga.
- Oesman, O. 2012 Penerapan Penggunaan FTE RACI dan *Head Count Analysis* dalam Pengelolaan SDM. Pengelolaan SDM Dalam Rangka Modernisasi Layanan
- Suleman, W., Andaki. J.A. dan Rarung. L.K. 2015. Analisis Beban Kerja Produksi Perusahaan Pembekuan Ikan (Studi Kasus CV. Muara Mina Kelurahan Girian Bawah Kecamatan Girian Kota Bitung). Jurnal AKULTURASI : Vol. III No.6 Hal 171-176.
- Sutrisno E. 2010. Manajemen Sumber Daya Manusia. Jakarta (ID): Kencana Prenada Media Group
- Tim Karya Tani Mandiri. 2010. Pedoman Budidaya Secara Hidroponik NFT. Nuansa Aulia, Bandung.
- Tridoyo dan Sriyanto. Analisis Beban Kerja Dengan Metode Full Time Equivalent Untuk Mengoptimalkan Kinerja Karyawan Pada Pt Astra International Tbk-Honda Sales Operation Region Semarang. Industrial Engineering Online Journal. Vol. 3 No. 2.
- Untung, O. 2001. Hidroponik Sayuran Sistem NFT (Nutrient Flim Technique). Penebar Swadaya, Jakarta

Certificate Number: 045/Certificate/ICoSET/2017



YAYASAN LEMBAGA PENDIDIKAN ISLAM (YLPI) RIAU
UNIVERSITAS ISLAM RIAU

UIR INTERNATIONAL CONFERENCE 2017

ICOSET

INTERNATIONAL CONFERENCE ON SCIENCE, ENGINEERING AND TECHNOLOGY

CERTIFICATE

This is to certify that

DEDI KARNI

has participated in International Conference on Science, Engineering and Technology (ICOSET)
"Sustainable Development in Developing Country" as

PRESENTER

held by Lembaga Penelitian dan Pengabdian Masyarakat (LPPM) Universitas Islam Riau, Indonesia

Pekanbaru, 8-10 November 2017

University Partners:



Prof. Dr. H. Syafrinaldi, SH., M.C.L
Rector of Universitas Islam Riau



Dr. Evizal Abdul Kadir, M. Eng
Conference Chair