

Full Length Research Paper

Hydrogen as clean fuel via continuous fermentation by anaerobic photosynthetic bacteria, *Rhodospirillum rubrum*

Ghasem Najafpour*, Ku Syahidah Ku Ismail, Habibollah Younesi, Abdul Rahman Mohamed and Azlina Harun Kamaruddin

School of Chemical Engineering, Universiti Sains Malaysia, Penang, Malaysia.

Accepted 10 September, 2004

Hydrogen has been considered a potential fuel for the future since it is carbon-free and oxidized to water as a combustion product. Bioconversion of synthesis gas to hydrogen was demonstrated in a continuous fermentation utilizing malate as a carbon source. *Rhodospirillum rubrum*, an anaerobic photosynthetic bacterium catalyzed water gas shift reaction which was used in this research. The synthesis gas (CO) was used as a source of energy along with tungsten light supplied for growth and bioconversion of the photosynthetic bacteria. The microbial process in fermentation media was carried out in continuous culture to observe the effect of light intensity, agitation and liquid dilution rate on hydrogen production. The maximum hydrogen yield at 500 rpm was 0.65 mmol H₂/mmol CO. Desired media flow rate was preferable for high hydrogen production. At 0.65 ml/min media, hydrogen was produced at 7.2 mmol/h. This new approach, use of biocatalyst, can be considered as an alternative method to the conventional Fischer Tropsch synthetic reactions, which were able to convert synthesis gas into hydrogen.

Key words: Hydrogen, syngas, continuous bioreactor, *Rhodospirillum rubrum*, light intensity, agitation rate and flow rate.

INTRODUCTION

Pollution of the air resulting from the consumption of fossil fuels has been so widely discussed and it is important to note that as fossil fuels become depleted, their costs will certainly escalate. At present, application of catalysts at high temperature and pressure, Fischer-Tropsch (FT) synthesis has been discovered as a revolution in the natural gas industry to produce fuel. It was found that the synthesis undergone is not economically feasible in the postwar world II anymore. Moreover fossil fuels are not renewable and they also emit pollutants such as CO, CO₂, C_nH_m, SO_x, NO_x, radioactivity and ashes (Momirlan, and Veziroglu, 2002).

As an alternative, hydrogen is a carbon-free fuel, which oxidizes to water as a combustion product. It can be produced through bioconversion of synthesis gas via water-gas shift reaction. The idea of converting the waste gas or synthesis gas to fuels and chemicals is not new and has been developed in the past few decades.

In principle, synthesis gas (syngas) may be generated from any hydrocarbon feedstock. This is reflected in industrial practice, which includes large-scale syngas production from a wide variety of materials that includes natural gas, naphta, residual oil, petroleum coke and coal. The syngas composition from gasification processes is manipulated to control the H₂/CO ratio (Wilhelm et al., 2001). The predominant commercial technology for syngas was steam methane reforming, in

*Corresponding author. E-Mail: najafpour8@yahoo.com.

which methane and steam are catalytically and endothermically converted to hydrogen and carbon monoxide.

Photosynthetic bacteria represent a futuristic approach with appreciable extent of light-conversion efficiency. The conversion of synthesis gas via biological route is favourable since microorganisms can also be used to convert synthesis gas components into fuels and chemicals. It has been reported that although biological processes are generally slower than chemical reactions, there are several advantages over catalytic processes, such as higher yields and specificity as well as generally greater resistance to catalysts poisoning. Biological processes also occur at ambient temperatures and pressures, thus minimum energy requirements and low cost is needed for the process (Klasson et al., 1992).

Two species of purple nonsulfur bacteria, *Rhodospseudomonas gelatinosa* and *Rhodospirillum rubrum* are known to perform the water-gas shift reaction to produce hydrogen (Klasson et al., 1990).

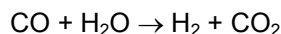

The reaction is important in shifting gas from CO-rich to H₂-rich gas, since synthesis gas is typically deficient in H₂ if chemicals production is desired (Cowger et al., 1992). Comparing the two species, *R. rubrum* grows faster and reaches higher cell concentration, showing that it can uptake CO more rapidly (Klasson et al., 1990; Cowger et al., 1992). It has been reported that nitrogenase is responsible for the release of hydrogen; it is main catalysts of hydrogen production by the photosynthetic bacteria (Kallsson et al., 1990; Barbosa et al., 2001).

There is good reason to believe that this proposed and future gas to liquid facilities is substantially less costly than the very expensive predecessors. In large scale operation, such cost reductions is attributable to improvements in Fisher Tropsch catalyst and reactor design, the most significant of which have been pioneered by Sasol Plants (Miyake et al., 1982).

MATERIALS AND METHODS

Microorganism

Pure culture of *R. rubrum* was obtained from the American Type Culture Collection (ATCC), 10801, University Boulevard, Manassas, Virginia, 20110-2209 USA. It was grown anaerobically in an enriched ATCC media at 30°C under tungsten light. The Transmission Electronic Microscope (TEM, Philips CM12, Netherlands) of single bacteria, *R. rubrum* with slightly bended shape at magnification of 800 is shown in Figure 1.

Growth Medium

Malic acid (2.5 g) neutralized with NaOH at pH 6.9, yeast extract (1 g), (NH₄)₂SO₄ (1.25 g), MgSO₄·7H₂O (0.2 g), CaCl₂·2H₂O (0.07 g), Ferric Citrate (0.01 g), EDTA (0.02 g), KH₂PO₄ (0.6 g), K₂HPO₄ (0.9 g). Trace metal solution (1 ml) [ZnSO₄·7H₂O (0.01 g), MgSO₄·H₂O

90.02 g], H₃BO₃ (0.01 g), Ferric Citrate (3 g), CuSO₄·5H₂O (0.01 g), EDTA (0.5 g), (NH₄)₆Mo₇O₂₄·2H₂O (0.02 g), CaCl₂·2H₂O (0.2 g) in 1 liter distilled water]. B-Vitamin Solution (7.5 ml) [Nicotinamide (90.2 g), Thiamine-HCl (90.4 g), Nicotinic acid (0.2 g), Biotin (0.008 g) in 1 liter distilled water] added with distilled water to 1 liter.

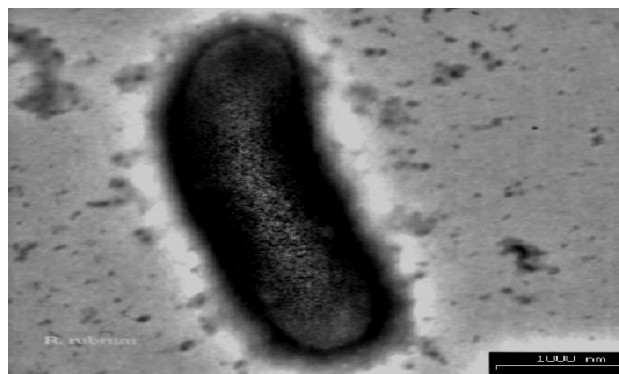

Figure 1. *R. rubrum* under TEM with magnification of 800.

Continuous Experiment

The experiments were carried out in a 2 liter fermenter, Biostat A, B Braun under anaerobic condition with continuous supply of synthesis gas (55% CO, 20% H₂, 15% Ar and 10% CO₂) provided by Sitt Tatt (Penang, Malaysia) and concentrated liquid media. It was equipped with pH, temperature, dissolved oxygen and level sensor. Figure 2 shows the schematic diagram of the experimental setup. Working volume of the bioreactor was 2 liters. A 5% inoculum was used to eliminate the log phase. Two tungsten lamps (40 W) were provided from two sides of the fermenter for light illumination at average of 1500 lux. The light intensity was measured by a luxmeter (Sper Scientific, Taiwan).

The optimum pH (6.3) was controlled by adding 0.2 M HCl and base 0.2 M NaOH solutions using peristaltic pumps. Syngas flow rate was adjusted to be constant at 10 ml/min by a digital flow meter (Brooks) which bubbled through a sparger. The liquid media flow rate was controlled by an external peristaltic pump (Cole Parmer) at various flow rates (0.65 – 2 ml/min). Liquid effluent was controlled by the level controller through the liquid outlet stream into the waste container. Agitation was provided by two sets of turbine impeller was kept at 500 rpm throughout the experiment.

Sampling of the outlet gas composition was routinely carried out using a gas tight syringe through a gas trap. Liquid samples for analysis and cell density measurements were withdrawn from the reactor through an immersed tube ending in a septum on top of the fermenter using a sterile syringe. To maintain anaerobic condition, the system was purged with purified

Analysis

The cell concentration was determined by optical density measurement using a spectrophotometer (Cecil 1000 series) at 400 nm. It was then converted to cell dry weight using a calibration curve. Gas compositions were determined by a gas chromatography (Perkin Elmer Autosystem XL) equipped with thermal conductivity detector (TCD) and Carboxene 1000 (Supelco) column. Oven temperature was initially maintained at 40°C, after 3.5 min, the temperature was programmed with a rate of 20°C/min until reached

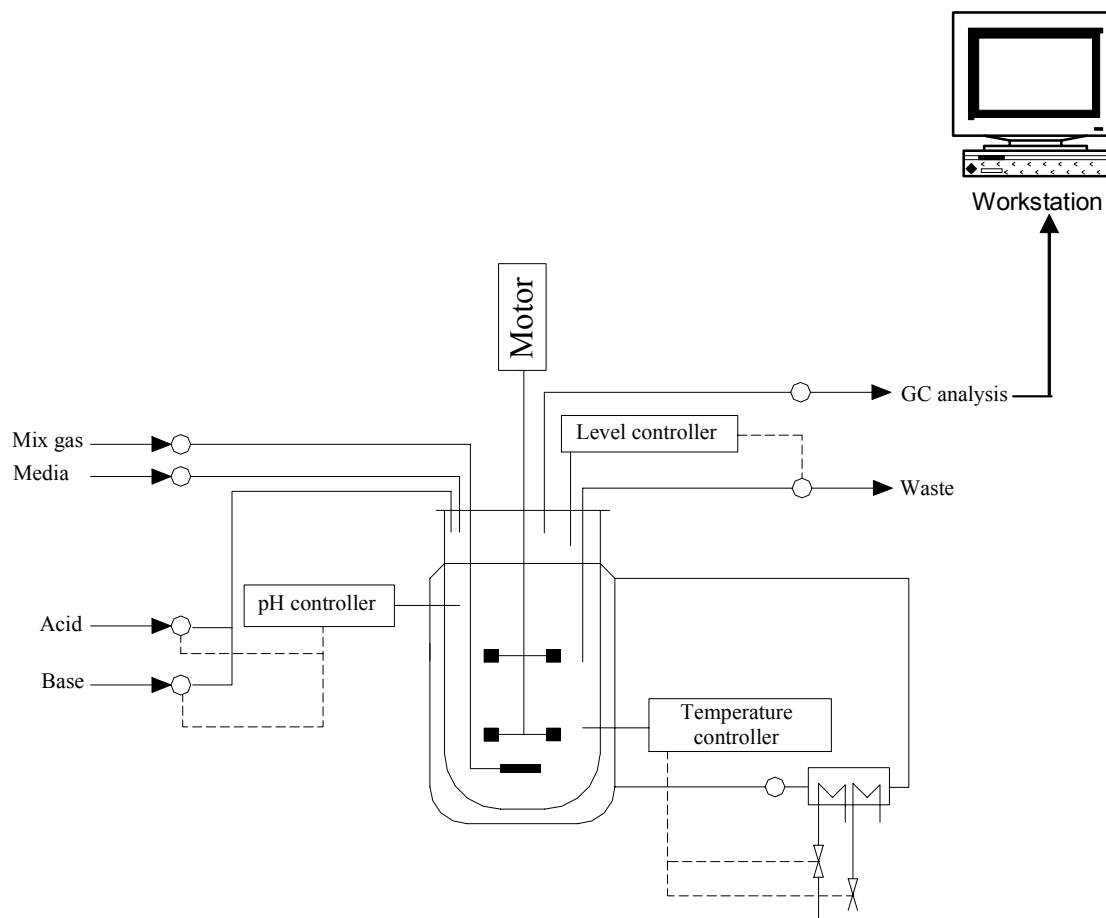

Figure 2. Schematic diagram of Fermentation Vessel and Associated units in laboratory set-up.

to 180°C. Detector and injector temperatures were 200 and 150°C respectively. The flow rate of carrier gas, helium was 30 ml/min. Argon was used as an internal standard. Calculations for composition of gases were accomplished using the Total Chrome software.

RESULTS AND DISCUSSION

Several runs of experiments were conducted to observe the effect of agitation and flow rate on hydrogen production and cell growth. For effect of agitation, a range of impeller speeds were chosen, 350 and 500 rpm. Variables that were kept constant were gas flow rate, 10 ml/min, light intensity average 1500 lux and liquid flow rate 0.65 ml/min. Figure 3 shows that agitation rate at 500 rpm resulted in a higher yield of hydrogen than 350 rpm. The higher agitation rate has provided higher mass transfer coefficient. The hydrogen production remained constant through out 7 days of continuous fermentation with an average yield of 0.6 to 0.7 mmole H₂/mmole CO. The cell density was also higher at high agitation rate. It was maintained at a constant value of 0.15 mg/l at 600 rpm, compared to 0.1 mg/l at 350 rpm. The cell

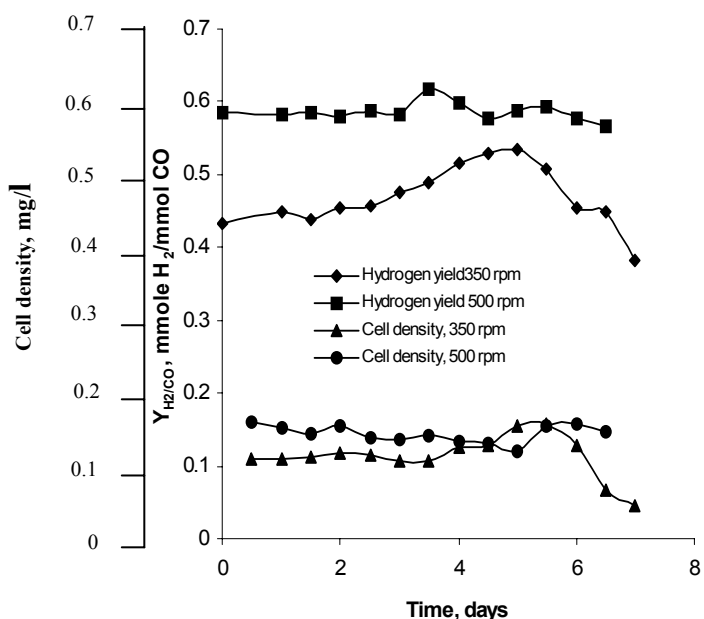

Figure 3. Effect of agitation rate on cell density and hydrogen production in continuous fermentation

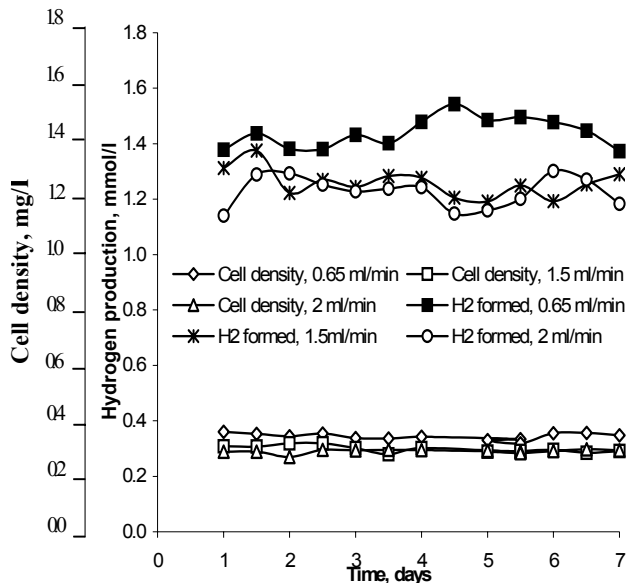

Figure 4. Effect of fresh media flow rate on hydrogen production and cell density in continuous fermentation.

concentration at low agitation tends to fluctuate and finally decreased before reaching to the end of one-week continuous hydrogen production. During bioconversion of CO, the bioreactor was very stable and steady for the whole course of continuous operation. The decrease in cell density resulted in the decrease of hydrogen yield. The main reason for this fact is that at higher agitation rate resulted higher mass transfer. Higher mass transfer means higher rate of CO being converted to hydrogen by the microorganism.

Figure 4 presents the effect of fresh liquid media flow rate on hydrogen production and cell density. The lowest flow rate, 0.65 ml/min, gives higher cell density, 0.38 mg/l, compared to the other two flow rates, 1.5 and 2 ml/min even though the value is almost the same, average of 0.30 mg/L. The maximum hydrogen was produced at 7.2 mmol/h using fresh media flow rate of 0.65 ml/min even though the values were fluctuated for the first four days. At flow rate of 1.5 and 2.0 ml/min, there was not much difference in hydrogen production but still produced hydrogen at an average concentration of 7 mmol/h in continuous fermentation for duration of 7 days. The high cell density was due to the long retention time of *R. rubrum* in the fermenter with the low flow rate of fresh media. This means that the photosynthetic anaerobic bacterium, *R. rubrum*, catalyzed the water-gas shift reaction with higher cell concentration at lower flow rate of fresh media. Light intensity was an important process parameter affected on growth of photosynthetic bacteria. The intensity range of 1500, 2700 and 4000 lux were chosen based on previous conducted experiments. The light was supplied to culture vessel from two opposite

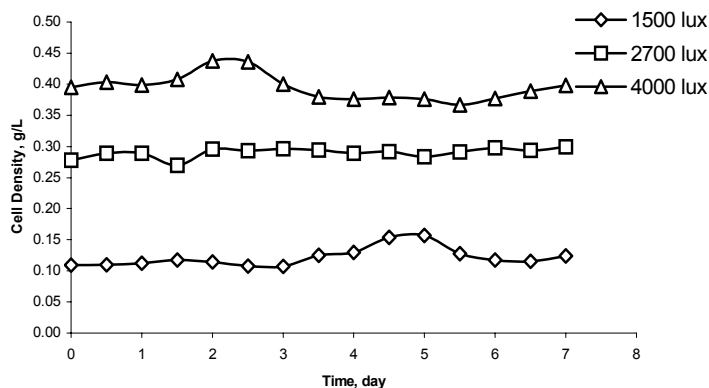

Figure 5. Effect of light intensity on cell density in continuous fermentation

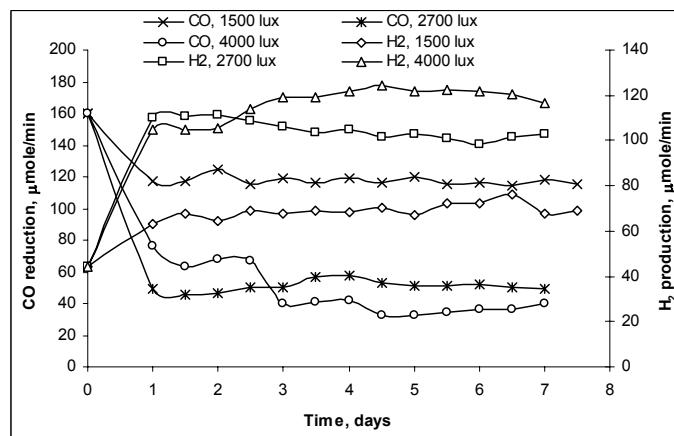

Figure 6. Effect of light intensity on H₂ production and CO reduction with continuous culture.

direction. The tungsten lights were adjusted based on distance of light sources to fermentation vessel and the intensities were measured by a luxmeter. Other process variables such as agitation (500 rpm), gas flow rate (7 ml/min) and fresh media dilution rate (0.02 h⁻¹) were kept constant. The selected condition was based on optimum condition defined in previous results. The effect of light intensities was illustrated in Figure 5. As the light intensity was increased from 1500 to 4000 lux, the cell densities were increased from nearly 0.1 to about 0.4 g/l. From the obtained results, it was concluded that the microorganism growth was light dependent.

While the cell growth with variation of light intensities was monitored, the hydrogen production and CO bioconversion were measured. Figure 6 shows hydrogen production and CO reduction were also affected by light intensity. The hydrogen production was stable. At steady

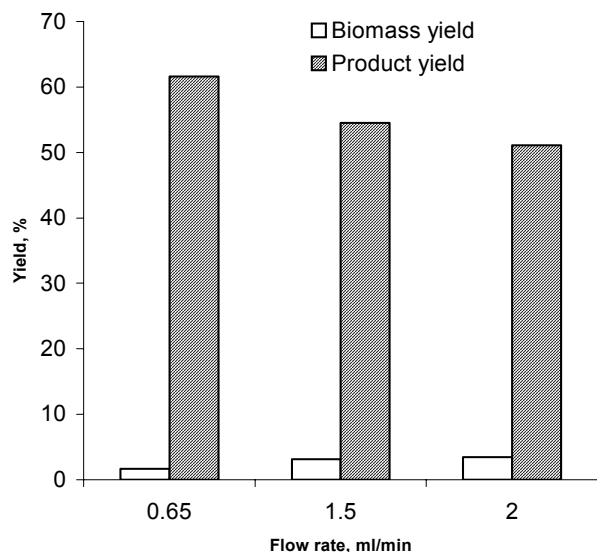

Figure 7. Effect of fresh media flow rate on biomass and product yield in continuous fermentation.

state condition, with maximum light intensity, a constant hydrogen production rate of about 7.2 mmol/h was obtained. The lowest CO bioconversion was related with lowest light intensity of 1500 lux.

Figure 7 represents the yield of biomass and production of hydrogen at the various flow rates of fresh media. The low biomass yield resulted in higher product yield. This was due to the cells tending to use CO gas as substrate and convert it to hydrogen. At higher biomass yield, the cells use malate as carbon source and less CO gas was resulted in lower hydrogen yield. Maximum yield of hydrogen production in continuous fermentation was about 70%.

Hydrogen is an excellent replacement for fossil fuels in avoiding global warming, used as clean fuel, free of any air pollution and it's an eco-friendly technology. It was observed that higher agitation rate yielded higher hydrogen as well as cell density. The production was

successfully kept constant for the whole week of continuous operation at 0.65 mmole H₂/mmole of CO at 500 rpm. Lower flow rate was better for the CO conversion due to the long retention time.

ACKNOWLEDGEMENTS

The present research was made possible through an IRPA grant No. 03-02-05-9016, by Universiti Sains Malaysia and Ministry of Science, Technology and Innovations (MOSTI). The authors wish to thank Research Creativity and Management Office (RCMO), University Science Malaysia and MOSTI for their financial support.

REFERENCES

- Barbosa MJ, Rocha J M S, Tramper J, Wijffels RH. (2001). Acetate as a carbon source for hydrogen production by photosynthetic bacteria. *J. Biotechnol.* 85 (1):25-33.
- Cowger JP, Klasson KT, Ackerson MD, Clausen EC, Gaddy JL, (1992). Mass transfer and kinetic aspects in continuous bioreactors using *Rhodospirillum rubrum*. *Appl. Biochem. Biotechnol.* 34/35:613-624.
- Klasson KT, Ackerson MD, Clausen EC, Gaddy JL (1992). Bioconversion of Synthesis Gas into Liquid or Gaseous Fuels. *Enz. Microb. Technol.* 14:602-608.
- Klasson, KT, Cowger JP, KO CW, Vega JL, Clausen EC, Gaddy JL (1990). Methane production of synthesis gas using a mixed culture of *R. rubrum*, *M. barkeri* and *M. formicum*" *Appl. Biochem Biotechnol.* 24/25: 2273-2289.
- Miyake J, Tomizuka N, Kamibayashi A (1982). Prolonged photo-hydrogen production by *Rhodospirillum rubrum*. *J. Fermentation Technol.* 60(3):199-203.
- Momirlan M, Veziroglu T (2002). Recent directions of world hydrogen production. *Renewable and Sustainable Energy Reviews* 6: 141-179.
- Wilhelm DJ, Simbeck DR, Karp AD, Dickenson RL (2001). Syngas production for gas-to-liquid applications: Technologies, Issues and Outlook. *Fuel Processing Technol.* 71: 39-148.