

A stochastic framework for secure reconfiguration of active distribution networks

Seyed-Alireza Ahmadi¹ | Vahid Vahidinasab^{1,2}  | Mohammad Sadegh Ghazizadeh¹ |
Damian Giaouris³

¹ Faculty of Electrical Engineering, Shahid Beheshti University, Tehran, Iran

² Department of Engineering, School of Science and Technology, Nottingham Trent University, Nottingham, UK

³ School of Engineering, Newcastle University, Newcastle upon Tyne, UK

Correspondence

Vahid Vahidinasab, Faculty of Electrical Engineering, Shahid Beheshti University, Tehran, Iran
Email: vahid.vahidinasab@ieece.org

Abstract

Automatic reconfiguration is one of the key actions in self-healing distribution networks. In these networks, after detecting and isolating the faulted portion, an automatic reconfiguration procedure is performed to restore the maximum possible affected loads without further interruptions during repair operations. This procedure becomes more complicated in the networks with integrated distributed generation units as they can bring security challenges for the reconfigured network after a fault event. To overcome these challenges, a stochastic framework is proposed here. In this framework, the reconfiguration procedure is conducted with a fast and reliable method which is based on the graph theory. Besides, the security challenges of utilizing distributed generations after an event are highlighted. Then, since a faulted network is more prone to subsequent faults, different actions of changing the distribution generations output power, preventing the insecure increment of short circuit capacity, and also considering the loadability improvement are proposed in the reconfiguration framework. Then in the final stage, the vulnerability of the distribution system to the uncertainties of load demand is resolved through a chance-constrained programming-based approach. To see the performance of the proposed stochastic framework, it is tested on a standard test system and the results prove its goodness and applicability for real distribution networks.

1 | INTRODUCTION

A self-healing capability is considered one of the most important features of smart distribution networks. In such networks when a fault occurs, its location is very quickly detected and the faulted area is isolated from the rest of the network. After that, the configuration of the network is changed to feed the affected customers from a new path and reduce the power outage time. The electricity demand along with economic and social development is increasing over time [1]. This increase exists in both quantity and quality, meaning consumers expect to have electrical energy with high reliability and good quality [2].

The distribution network has a direct connection with consumers and if a power outage occurs, it can have a big impact on daily life and economic activities. The most important part

of a self-healing smart distribution network is reconfiguring the network to reduce or eliminate the interruptions without human intervention [3]. In this regard, remote control switches play an important role in performing automatic network reconfiguration. In the distribution network, there are two types of switches, most of which are the normally closed switches and a small amount of them are normally open tie switches. By intelligently changing the switches' status, the network structure is reconfigured and loads are transferred to the other lines. This network reconfiguration is performed for different purposes.

One category of these purposes is to obtain better operation conditions by reducing network losses [4–6], improving network reliability [7–9], enhancing voltage profile [10], and decreasing total operation costs [11–13]. On the other hand, performing automatic reconfiguration after the outage of a part

This is an open access article under the terms of the [Creative Commons Attribution](https://creativecommons.org/licenses/by/4.0/) License, which permits use, distribution and reproduction in any medium, provided the original work is properly cited.

© 2021 The Authors. *IET Generation, Transmission & Distribution* published by John Wiley & Sons Ltd on behalf of The Institution of Engineering and Technology

of a network to retrieve a consumer's power supply very quickly with an optimal performance [14–16] is also another goal of network reconfiguration. This is for self-healing applications and is more challenging than the other ones.

For this application, valuable approaches have been proposed in the literature. In [16], the optimal informed search algorithm is proposed to solve the network reconfiguration problem required during an outage recovery. Reducing the switching actions and network loss are the main objectives of the optimization problem. In [17], an algorithm is proposed to solve the network reconfiguration problem after an unplanned outage of a line. This algorithm aims to maximize the number of connected customers and minimize power loss. In [18], a multi-agent control system is designed to correct voltage violations, coordinate the operation of reactive power control devices, and reconfigure the network.

In [15], a centralized self-healing scheme consisting of two stages is proposed. This scheme conducts a bi-level optimization procedure to determine both binary and continuous variables. The binary variables like switch status and continuous ones like required load shedding in nodes are obtained through solving mixed-integer linear programming (MILP) and non-linear programming (NLP) problems. In [19], to perform optimum self-healing control actions in a distribution network, an operational framework is proposed. In this framework, using DGs, the distribution network is divided into a set of micro-grids. Then, using the pre-determined load demands and considering total energy loss and supplied loads, an optimal self-healing strategy is planned.

Similar to the previous researches, this paper proposes a stochastic framework based on graph theory for network reconfiguration. In most of the published work for self-healing, distributed generation challenges and the possibility of using them for performance enhancement of the network have not been considered. It should be noted that distributed generation could threaten the system's stable condition after the network reconfiguration is subsequently performed after an event. In such conditions, distributed generation increases the short circuit capacity of the network and raises the risk of circuit breakers' failure.

It is well known that a faulted network is more prone to face another fault and therefore the reconfigured network should be able to break the possible upcoming fault currents. For this, the short circuit capacity is considered in the network reconfiguration procedure of this paper. It will be proven that when the short circuit capacity is considered in the reconfiguration procedure, in case of load increment, the risk of system failure due to voltage collapse becomes high. Also, the condition of not having lines due to the previously occurred fault worsens the problem. Therefore, for preventing such phenomena, loadability improvement is also considered in the reconfiguration procedure of this paper.

Since the network reconfiguration performed for self-healing application is a remedial action, to the best of authors' knowledge, in all of the previous researches, load demands of end-users are considered to be fixed and equal to the amount of the load at the time of the self-healing system's request for net-

work reconfiguration. In such conditions, a remedial reconfigured network is considered to be temporary to only minimize the outages.

In the next step, when the faulted equipment is repaired and the faulted area is able to be connected to the rest of the network, another reconfiguration is applied to obtain the optimal topology of the network. This philosophy is challenged in this paper since the repairing time is not always very quick. Even for a simple line failure in the distribution network, approximately 4 h is needed to do repair operations [7]. Now if the load demand variations and uncertainties are not considered, the wounded network which is not operating with all of its lines and infrastructures available becomes vulnerable to unexpected changes in the load demand and the risk of a system collapse becomes very high. Therefore, to cover such uncertainties, an approach based on chance-constrained programming is proposed. Finally, to evaluate the performance of the proposed stochastic framework, different test studies are conducted on a 33-bus radial distribution network. The main contributions of this paper can be summarized as follows:

- For fast and reliable network reconfiguration, a new method based on graph theory is proposed.
- The possibility of threatening the network's security due to the power production of distributed generation assets is highlighted.
- To prevent insecure operation of distribution system after network reconfiguration, two solutions are proposed in the reconfiguration procedure: (1) changing distributed generations' output power, and (2) decreasing short circuit capacity and improving loadability.
- Load-related uncertainties are considered through a chance-constrained programming approach to resolve the vulnerability of the distribution system for load demand variations.

2 | THE PROPOSED SECURE RECONFIGURATION FRAMEWORK

The structure of the distribution networks (in contrast to the transmission networks which are loop-based for the sake of increasing reliability) is radial. This radial structure simplifies the control and coordination of protective equipment.

Switches in the distribution networks are very important for both short circuit protection and network management through reconfiguration. Accordingly, the distribution network's switches can be divided into two categories: (1) sectionalizing switches, and (2) tie switches. In normal operating conditions, sectionalizing switches are closed while the tie switches are opened.

In a self-healing network, just after a fault occurrence, its location is founded and the faulted area is opened by using sectionalizing switches. In this case, some parts of the network will face a power outage. Then, for reducing the interruption time, by using tie switches, network reconfiguration is performed and

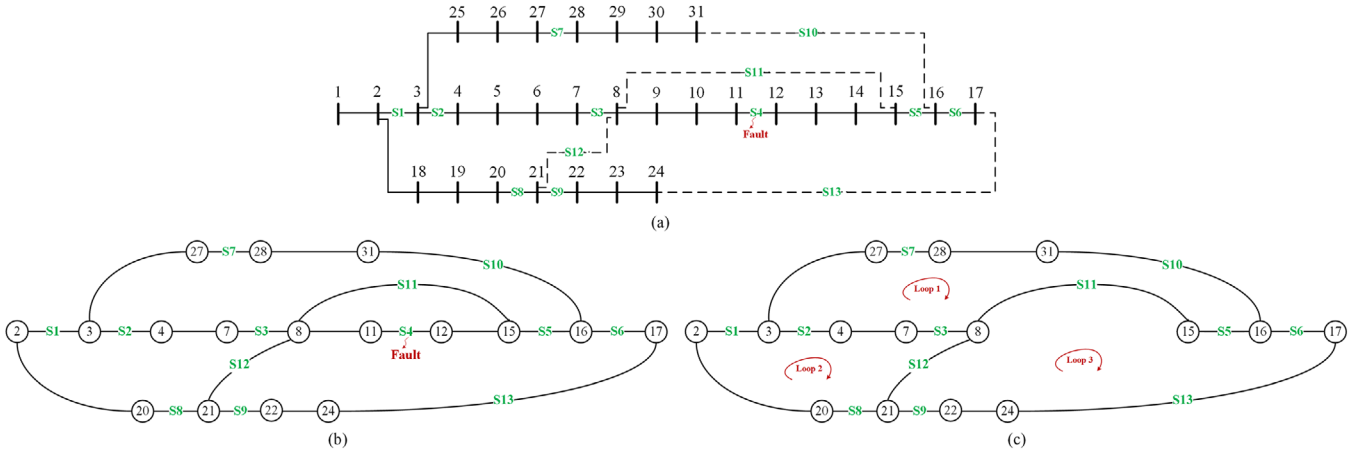

FIGURE 1 Reconfiguration method example: (a) main network, (b) reduced graph of the network, (c) reduced graph of the network after faulted line area removal

the distribution network becomes available for maximum possible loads. To perform such remedial action, a fast and reliable reconfiguration method is needed. Besides, during reconfiguration procedure, some other considerations are taken into account to enhance the network operation condition. In the following, the reconfiguration method and the main considerations required for secure and optimal operation of the active distribution network is proposed.

2.1 | Reconfiguration method

To perform network reconfiguration, graph theory is used [24]. Each network topology can be considered as a graph of $G(N,E)$ in which the busses are its nodes $N(G)$ and the lines are representing its edges $E(G)$. With this consideration, the reconfiguration method is applied by performing the following steps:

Step 1) First consider that all the switches are closed. Since only the lines with controllable switches can perform the reconfiguration process in a self-healing distribution system, the network graph is reduced by merging the lines and busses having the following conditions:

1. No controllable switches exist in these two busses and between them
2. No bus with more than two feeders (one incoming and one outgoing) exists between two busses. Doing so, a reduced graph $Gr(Nr,Er)$ is obtained in which its nodes $Nr(Gr)$ are representing the area between two controllable switches, and its edges $Er(Gr)$ are representing the controllable switches.

Step 2) The area in which the faulted line or equipment is located is eliminated from the reduced graph.

Step 3) Since the distribution network structure should be radial, from the mathematical point of view, the reduced graph should be a spanning tree. In graph theory, a spanning tree is a graph in which all of its nodes are connected with minimum

possible edges [20, 21]. In such a graph, no loops exist. The reconfiguration problem can be considered as the finding of optimal spanning tree $T(N_{opt}, E_{opt})$ with several objective functions and constraints described in the rest of the paper. To find possible T structures, it is first considered that all edges are connected. In this case, multiple loops are formed. Then from each loop, one particular edge with a controllable switch should be selected to be removed by these constraints that (1) from each loop, at least one switch should be opened, and (2) a number of opened switches should be the same as the number of loops [24]. In this way, different network topologies or more precisely spanning trees are created. The optimal configuration is the one having the minimum objective function value.

To explain the reconfiguration method more, consider the network depicted in Figure 1a. This network consists of 13 switches and after reducing in step 1 of the method becomes in the form of Figure 1b. Then in step 2, the fault is isolated from both sides using switch S_4 , and the reduced network by removing the area of fault is shown in Figure 1c. Now in step 3, the search for possible spanning trees is performed. To do so, by considering the conditions mentioned before, one switch from each loop should be selected to be opened. The available switches in each loop are as follows:

$$Loop_1 = \{S_2, S_3, S_5, S_7, S_{10}, S_{11}\} \quad (1)$$

$$Loop_2 = \{S_1, S_2, S_3, S_8, S_{12}\} \quad (2)$$

$$Loop_3 = \{S_5, S_6, S_9, S_{11}, S_{12}, S_{13}\} \quad (3)$$

One possible spanning tree and the solution of the reconfiguration method can be obtained by opening the following switches:

$$Open\ Switches = \{S_7, S_{12}, S_5\} \quad (4)$$

2.2 | Short circuit capacity consideration

Increasing the penetration of distributed generations and capacity of power generation and also growing the integrity of the electrical network increase the short circuit current in the distribution network. This leads to an increase in heat due to the high inductive flow through the generators, transformers, and other equipment, and causes the reduction of network reliability. Therefore, passing such flow through the network requires equipment that can withstand it. Besides, to cut this flow, we need strong circuit breakers that impose heavy costs on the system. Hence, minimizing short circuit capacity, especially in the distribution system, directly affects the cost associated with the fault current. Also, in a self-healing distribution network, after reconfiguration, the network should be able to withstand and isolate aftermath events. This is because a faulted network is more prone to face another fault and so the reconfigured network should be able to withstand the probable upcoming faults currents. Besides, existing distributed generation assets worsen the problem due to their power injection. To overcome this problem, fault current limiter devices are used in some distribution networks. Since the use of these devices brings more challenges and imposes additional costs to the network, simultaneous network reconfiguration and changing the output power of distributed generations is proposed. To do so, the following actions are considered in the reconfiguration scheme to decrease the short circuit current:

1. Resizing the output power of the distributed generations.
2. Considering the minimization of network short circuit capacity in the overall framework objective function of network reconfiguration through the approach given in the resume.

At each bus in the distribution network such as the i -th bus, the short circuit capacity can be calculated as follows:

$$SCC_i = V_i^2 / Z_i, \quad (5)$$

where, V_i is the voltage of the i -th bus before occurring the short circuit fault, and Z_i is the Thevenin impedance seen from the i -th bus. It should be noted that all values are in pu.

As in the problem of this article, the relative increase of short circuit capacity is important, the following index is proposed to consider the minimization of network short circuit capacity in the overall framework objective function:

$$OF_{SCC} = \sum_{i=1}^n \left| SCC_i^{new} / SCC_i^{old} \right| + \left| \max \left(SCC_i^{new} / SCC_i^{old} \right) \right|, \quad (6)$$

where, SCC_i^{new} and SCC_i^{old} are the short circuit capacity of i -th bus for new and previous topologies (after and before reconfiguration), respectively. n is the total number of busses in the distribution network. It should be noted

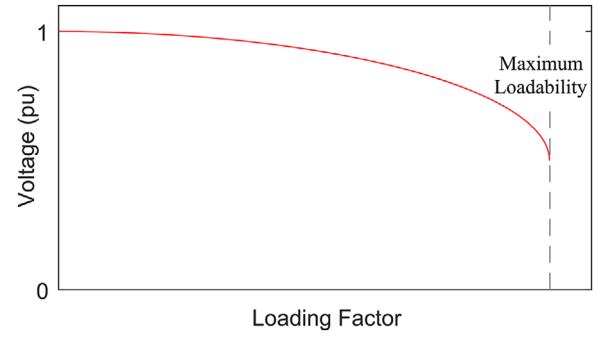

FIGURE 2 Loadability curve (voltage amplitude versus loading factor)

that all short circuit calculations are based on IEC 60909 standard.

2.3 | Voltage profile consideration

From (6), it can be seen that for decreasing the short circuit capacity, the bus voltage should be decreased or the Thevenin equivalent impedance should be increased. It is obvious that if the Thevenin impedance increases, the voltage will be decreased. Therefore, if the short circuit capacity decreases, the voltage will be consequently decreased. Generally, it can be concluded that there should be a compromise between voltage amplitude and short circuit capacity. To prevent voltage drop for decreasing short circuit capacity, voltage profile improvement is considered in the overall framework objective function by minimizing the following index:

$$OF_{VP} = \sum_{i=1}^n ||V_i| - 1| \quad (7)$$

2.4 | Loadability consideration

To decrease the short circuit capacity, the Thevenin impedance should be increased. In this case, the bus voltage will be very sensitive to load demand. It means that for a load increase in such conditions, the risk of voltage drop becomes unacceptably high. To prevent such conditions from occurring, loadability improvement is also considered in the overall framework objective function.

In a power system with a specified topology structure and reactive power sources, if electrical loads of the busses increase according to a particular pattern, the system will naturally encounter a voltage drop of the busses. This voltage drop can be compensated by injecting reactive power, but if after injection of all available reactive power sources, the load increases, the system will reach a point that any increment in the electric load will lead to voltage collapse. The load corresponding to this point is the so-called system's maximum loadability limit. Figure 2 shows the voltage amplitude versus the loading factor.

Since in this procedure it is assumed that the maximum loadability limit is obtained for very gradual load changes, the dynamics governing the behaviour of the system are still the load flow equations. For electrical load more than the maximum loadability limit, the load flow equations are not accurate and the load flow program will not converge. Therefore, the maximum loadability could be obtained by increasing the load demand of all busses in the network through the following approach and checking the convergence of the load flow equations:

$$P_k + jQ_k = \lambda_k (P_{k-1} + jQ_{k-1}), \quad (8)$$

$$\lambda_k = 1 + k \times \Delta\lambda, \quad (9)$$

where P_k and Q_k are the active and reactive power at k -th step. λ_k is the loading factor at k -th step and $\Delta\lambda$ is the increment step size which is considered 1% here. λ_{\max} is the maximum loadability limit which is the corresponding loading factor in the final step where for the next step, load flow equations will not converge.

To consider loadability improvement in the overall objective function, the following index is minimized:

$$OF_{LA} = 1/\lambda_{\max} \quad (10)$$

2.5 | Operation costs consideration

The cost of network operation is one of the most important factors for network managers. The use of cheaper power generation technologies and increasing the efficiency of the power network are the things that can be done to reduce system operation costs. To reflect the importance of this issue in network utilization, the cost of production of distributed generation units along with the cost of upstream power generation is considered to prevent the selection of conditions that, although fulfilling the above objectives, impose a high cost on the network. Here, it is assumed that the distributed generation units are in the control of utility and each of them has a different generation cost. In practice, it is expected that the cost of upstream generated power becomes less than that of distributed generators, which is included in the modelling of this article. The cost of power generation with regard to supplying customers' demand for optimization of this article is as follows:

$$OF_{oc} = S_g \times P_g + \sum_{i=1}^{NDG} S_{DG_i} \times P_{DG_i}, \quad (11)$$

where, S_g and S_{DG_i} are the price of power generation for the upstream grid and i -th distributed generation unit, respectively. P_g and P_{DG_i} are the output generated power of the upstream network and i -th distributed generation unit.

2.6 | Power loss consideration

Electrical energy flows through the transmission and distribution networks to the consumers. In this way, some energy is

lost. While studies on power loss minimization are as old as the age of the electricity industry, its high economic impact makes it still an important issue to be taken into account by network designers/operators. Therefore, the necessity of studying power loss minimization in the electrical engineering community is inevitable. Power losses are proportional to the amount of load demand, and in peak hours, will be much higher than off-peak hours. This means that in the most difficult conditions, that is, peak times, we also have the highest power losses. By examining distribution networks, it is determined that by performing some improvement actions, power losses can be greatly reduced. Network reconfiguration is one of these actions which is highlighted by previous work [4–6] and is also used in this article by minimizing the following objective function [22].

$$OF_{loss} = \sum_{i=1}^{N_l} R_i \times I_i^2, \quad (12)$$

where, N_l , R_i and I_i are the total number of lines, resistance and current magnitude of the i -th line.

3 | THE PROPOSED STOCHASTIC FRAMEWORK

In the previous section, a deterministic framework for secure reconfiguration of active distribution networks has been proposed. Implementing short circuit capacity and loadability considerations help to use the maximum capacity of distributed generations in the network. Besides, some other objective functions have been proposed to enhance the operation condition of the reconfigured network. Finally, the overall framework objective function in a deterministic manner is as follows:

$$OF_{Overall} = w_1 \times OF_{SCC} + w_2 \times OF_{VP} + w_3 \times OF_{LA} + w_4 \times OF_{oc} + w_5 \times OF_{loss}, \quad (12.1)$$

where, w is the weighting factor of each objective function. The detailed version of it can be achieved by opening the sub-objective functions as follows:

$$\begin{aligned} OF_{Overall} = & w_1 \times \left(\sum_{i=1}^n \left| SCC_i^{new} / SCC_i^{old} \right| + \left| \max \left(SCC_i^{new} / SCC_i^{old} \right) \right| \right) \\ & + w_2 \times \left(\sum_{i=1}^n ||V_i| - 1| \right) \\ & + w_3 \times (1/\lambda_{\max}) \\ & + w_4 \times \left(S_g \times P_g + \sum_{i=1}^{NDG} S_{DG_i} \times P_{DG_i} \right) \\ & + w_5 \times \left(\sum_{i=1}^{N_l} R_i \times I_i^2 \right) \end{aligned} \quad (12.2)$$

Finding the optimal solution of the above objective function is the core of the proposed framework. The procedure of the proposed framework is given in Figure 3.

Result: Finding open switches and DERs' output powers
Data: Initial network configuration, Fault location, maximum output power of DERs, and GA parameters
Initialization:
 1) Remove the faulted section by available switches.
 2) Determine the existing loops in the revised network structure
Begin GA optimization:
 Generate a population
while *Termination criteria are not met* **do**
 for *Each chromosome in population* **do**
 Objective function evaluation
 Selection
 Crossover
 Mutation
 end
 Store the chromosome with best objective function
end
 Send required commands to the network switches and DERs based on the selected chromosome

FIGURE 3 The procedure of the proposed framework

3.1 | Load-related uncertainties

As mentioned in the introduction, all of the researches conducted on network reconfiguration for self-healing application, load demands of end-users are considered to be fixed and equal to the exact amount of it at the time of self-healing system's request for network reconfiguration. This is due to the fact that, for self-healing application, the network reconfiguration is performed as a remedial action and the load is considered not to change within the self-healing actions, and to have a close to optimal operation of the distribution network, after repairing the faulted equipment, another reconfiguration is performed.

Here, this assumption is challenged. The reason for this claim is that the load demand at the time of network reconfiguration for self-healing application is known, but it will not be fixed for the repairing period in the faulted area. The faulted area may have been lost due to the outage of its equipment such as transformers, circuit breakers, lines etc. or also a short circuit event occurring. In all possible scenarios, it takes an uncertain, but within a specific range, repair time to have all of the network's lines available for the next network reconfiguration which is done for operating the network in an optimal manner (not as a remedial action). Besides, if the load demand variations and uncertainties are not considered, the wounded network, which is not operating with all of its lines and infrastructures available, becomes vulnerable to unexpected changes in load demand. During this time, which is for example approximately 4 h for a line outage, and 168 h for a transformer outage [7], the distribution network should also be operated optimally. One solution is considering the worst condition which is the maximum load demand during the repair period, similar to various researches that studied the network reconfiguration [5–13], but the network configuration obtained through this consideration is not the optimal one. In a real situation, these loads are changing continually. Therefore, here, to cover such uncertainties of load demand, it is considered that the load is changing

and an approach based on chance-constrained programming is used to cover the load uncertainties.

3.2 | Proposed chance-constrained programming approach

Chance constrained programming is one of the stochastic programming methods in which the problem objective function and constraints are accompanied by stochastic parameters, such as load, price, and renewable energy generations. The optimal point that is obtained through this method satisfies the limitations of constraints which are themselves consisting of stochastic parameters. Typically, a chance-constrained programming problem is defined as follows:

$$\min \bar{f} \quad (13)$$

Such that:

$$P_r \{f(x, \xi) \leq \bar{f}\} \geq \beta \quad (14)$$

$$P_r \{g_j(x, \xi) \leq 0, j = 1, 2, \dots, k\} \geq \alpha, \quad (15)$$

where $x \in R^n$ is the vector of decision variable, ξ is the stochastic vector with defined probability distribution function of $\varphi(\xi)$. $f(x, \xi)$ and $g_j(x, \xi)$ are the objective function and j -th random constraint, respectively. Also, $P_r\{0\}$ is the probability of occurring $\{0\}$ event, α and β are the confidence levels of objective function and constraints, respectively.

Previous techniques for solving the aforementioned chance-constrained programming problem are based on changing the stochastic constraints to corresponding equivalent deterministic constraints according to a predefined confidence level.

Unfortunately, these techniques are not suitable for solving the complicated problem studied in this article. Therefore, similar to some researches [23, 24], a method based on Monte-Carlo simulation is used instead. To do so, N stochastic independent vectors $(\xi_1, \xi_2, \dots, \xi_N)$ from the probability distribution function $\varphi(\xi)$ should be generated. Let the number of cases which satisfy the constraints be equal to \bar{N} . With this consideration, relative percentages of the cases which satisfy the constraints are approximately equal to \bar{N}/N . This means that the stochastic constraint in (15) is satisfied if and only if $\bar{N}/N \geq \alpha$. Similarly, for a given vector of X , the Monte-Carlo simulation could be used to calculate the maximum value of \bar{N} that can satisfy the (14) constraint. From N generated stochastic independent vectors $(\xi_1, \xi_2, \dots, \xi_N)$, one set of objective function evaluations (f_1, f_2, \dots, f_N) where $f_i = f(x, \xi_i)$ could be obtained. If \bar{N} be equal to the absolute value of $(1 - \beta)N$, according to the elementary theories of probability, it can be concluded that the \bar{N} -th value in (f_1, f_2, \dots, f_N) set can be a good approximation for \bar{f} which satisfies the constraints of (14) and (15).

The aforementioned method is used for modelling load uncertainties in the optimization problem of this article. It is considered that the load demand of each bus is a stochastic

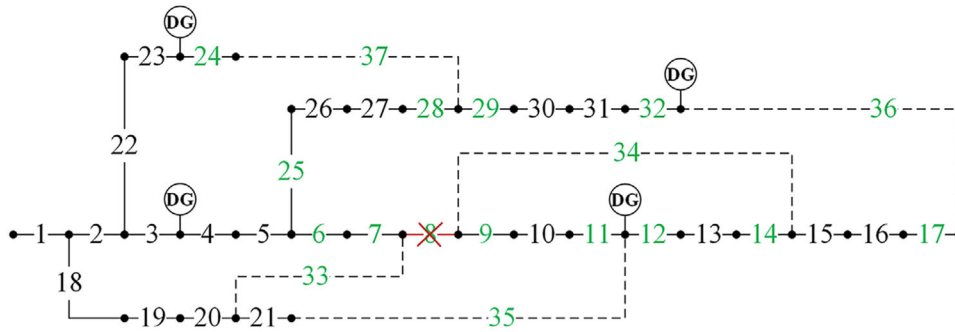

FIGURE 4 Schematic of the understudy test system

variable with a given probability distribution function. Now that the problem objective functions in both deterministic and stochastic conditions are expressed, a method for solving the optimization problem is needed. Here, after appropriately weighting the objective functions, genetic algorithms (GA) are used to optimize the overall objective function.

4 | SIMULATION RESULTS AND DISCUSSION

In this section, the proposed stochastic network reconfiguration framework is tested to see its performance for self-healing applications in the distribution networks. To do so, different test studies with IEEE 33-bus distribution network and 83-bus distribution network of Taiwan Power Company (TPC) are conducted.

Initial studies are conducted on IEEE 33-bus distribution network, depicted in Figure 4, with 18 switches shown in green colour. The network data can be founded in [7]. Four distributed generations with a maximum active power generation capacity of 300 kW are installed on busses 4, 12, 24, and 33. The distributed generation assets are in power factor control mode and the reference power factor is equal to 0.95. For optimization, the GA toolbox of MATLAB with a population size of 150 and maximum generations of 100 is used. The other parameters of the GA are kept to their default values.

The higher the number of controllable switches, the more flexible the system could be reconfigured. The ideal network is the one where all of its lines that have controllable switches. This consideration is not real for the nowadays distribution systems, but the increasing trend of installing controllable switches shows that in the future such a condition is not unrealistic. The reconfiguration under such conditions is more flexible and the possible causes for choosing a new topology increase. Nevertheless, the optimization procedure will face more challenges for finding global optima. In the test studies of this section, 18 optimal places are found and equipped with controllable switches which can be controlled by the automation system.

For initial studies, it is considered that a fault occurs in the network and line number 8 is isolated by opening the available switches to remove the faulted area from the network. Then, a

network reconfiguration is requested by the self-healing system to reduce the power outage and supply as many loads as possible, until the fault nature is completely removed by the repair crews.

The test studies are performed for the following scenarios:

Case 1:	Pre-fault normal operating condition
Case 2:	Insecure network reconfiguration condition
Case 3:	Performing network reconfiguration with the proposed framework in deterministic form without including the short circuit capacity and loadability objective functions in the procedure.
Case 4:	Performing network reconfiguration with the proposed framework in a deterministic form
Case 5:	Performing network reconfiguration with the proposed stochastic framework

4.1 | Deterministic studies

For the studies of this subsection, the load demand is considered to be deterministic. As discussed before, distribution networks have several tie lines that are out of service under the normal operating condition in case 1 of the test studies. These lines play an important role in re-establishing electric services in abnormal situations. For example, in the event of a permanent short circuit fault in the system, a part of the network encounters a power outage. By opening and closing some switches and separation of the faulted area, the power outage can be minimized until the fault is eliminated. The network reconfiguration for such application should be able to transfer heavy loads to lighter feeders, balancing the load on feeders, and improving voltage profile or at least preventing voltage insecurity. Now if the performance of the reconfiguration approach was not acceptable, hazardous situations may be created and the network will be completely unavailable.

To illustrate an example of such hazardous conditions, a second case study is designed. In case 2, the proposed framework is not utilized and inappropriate network topology is selected by a simple reconfiguration methodology after the opening of

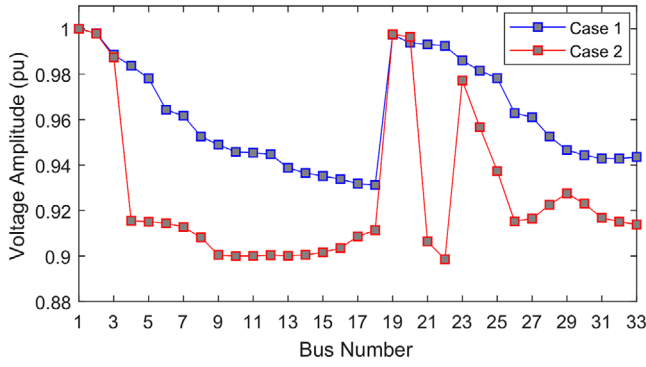

FIGURE 5 Comparison of the voltage amplitudes in cases 1 and 2

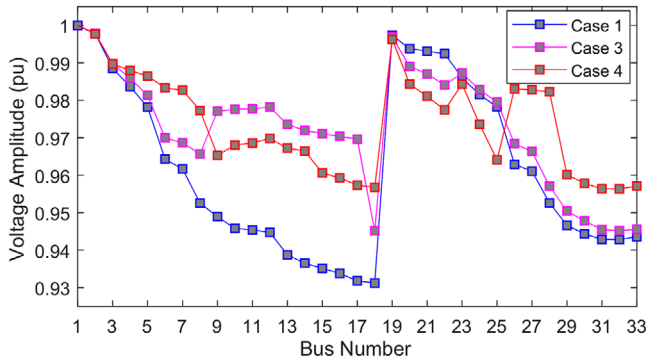

FIGURE 6 Comparison of voltage amplitudes in deterministic test studies

the line between busses 8 and 9 and requesting the self-healing system for network reconfiguration. Figure 5 shows the voltage profile of the under-study test system for case 2 of the studies in comparison to the normal condition of the network in case 1.

As it can be observed, in case 2, most of the busses have voltage amplitudes lower than 0.92 per unit, which is not acceptable. Therefore, if a good network reconfiguration methodology is not used, the system becomes vulnerable to the aftermath events and it may encounter security problems. It should be noted that the distributed generations in both cases are generating their maximum power (300 kW), but in case 2, they cannot help the system to improve voltage profile.

Consider the next cases of the test studies (cases 3 and 4). In these case studies, the proposed framework with different considerations under deterministic conditions is used. In case 3, short circuit capacity and loadability considerations (Sections 2.2 and 2.4) as well as load uncertainties are not included in the network reconfiguration procedure. In case 4, the deterministic form of the proposed framework containing all considerations presented in Section 2 is used for network reconfiguration, but still, the load uncertainties are not included.

Figure 6 shows the comparison of voltage amplitudes for the mentioned case studies. As it can be observed in case 3 since the voltage profile improvement is considered in the reconfiguration procedure, the voltages of most busses are improved, but there are some busses with low voltage amplitudes which may become vulnerable in case of the load increment. In case 4, the

TABLE 1 Results of deterministic test studies

	Case 1	Case 3	Case 4
Open switches	33-34-35-36-37	17-33-34-37	7-14-28-36
P_{DG1} (kW)	300	300	10.06
P_{DG2} (kW)	300	300	299.98
P_{DG3} (kW)	300	300	298.59
P_{DG4} (kW)	300	300	300
P_{loss} (kW)	107.54	88.08	84.25
SCC index	5762.45	6017.41	5735.84
λ_{max}	4.30	5.04	6.18
V_{min} (pu)	0.931	0.945	0.956

voltage amplitudes are in a very good range and since the mentioned security constraints are considered, no bus is sacrificed in the optimization procedure to have upper voltage amplitudes in the other busses.

Table 1 shows the results of the optimization algorithm for the mentioned case studies which are under deterministic condition. As it can be observed, in case 4 where all of the considerations in the framework is included in the problem, maximum loadability is improved and the loss is decreased. Besides, the minimum voltage of network busses (V_{min}) in that case is upper than the pre-fault normal condition network. From Table 1, it can be observed that when the short circuit capacity consideration is not included in the problem, it will rise and in some cases, DG power generation worsens this condition. Considering short circuit capacity minimization and loadability improvement in the reconfiguration procedure, increase the security of the network aftermath of a fault event in the network.

4.2 | Stochastic studies

The previous studies were conducted with the consideration of deterministic load demand. Now consider the next studies which consider load uncertainties. In case 5, the complete stochastic framework is used to perform a reliable and fast network reconfiguration for the required application in self-healing scheme. To see an example of the obtained scenarios of the load demand profile corresponding to the generated stochastic vectors, 10 load demand scenarios are shown in Figure 7. As it can be observed in this figure, generated load scenarios can cover the uncertainties associated with the load demand of end-users.

Figure 8 shows the comparison of voltage profiles in cases 1, 4, and 5 for a stochastic generated load. As it can be observed, using the proposed stochastic framework improves the voltage profile of the network even after removing a faulted area. Results of the optimization algorithm for this case can be found in Table 2. From this table, it can be observed that by using the proposed stochastic framework for network reconfiguration after the request of the self-healing system, not only the system's short circuit capacity is maintained in an appropriate range, but also the voltages and loadability of the system are improved.

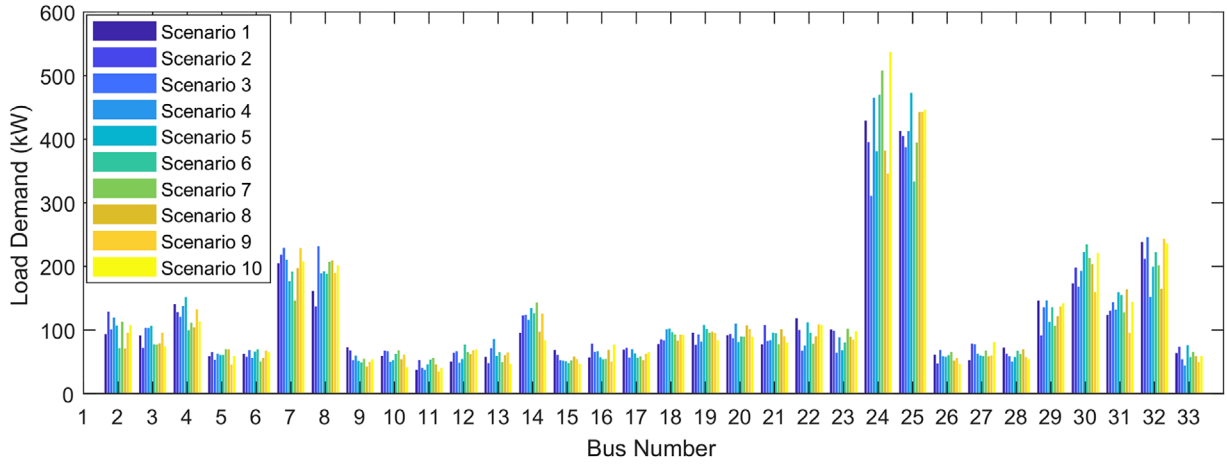

FIGURE 7 Different load scenarios for stochastic test studies

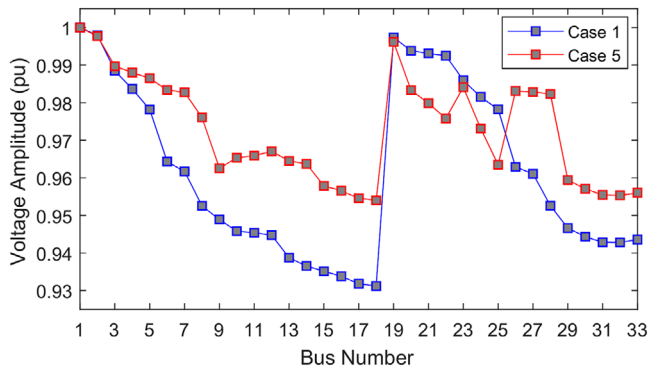

FIGURE 8 Comparison of the voltage amplitudes in stochastic test studies

TABLE 2 Results of stochastic test studies

	Case 1	Case 4	Case 5
Open switches	33-34-35-36-37	7-14-28-36	7-14-28-36
P_{DG1} (kW)	300	10.06	49.77
P_{DG2} (kW)	300	299.98	236.84
P_{DG3} (kW)	300	298.59	279.92
P_{DG4} (kW)	300	300	280.33
P_{loss} (kW)	117.36	94.08	88.77
SCC index	5796.35	5753	5738.08
λ_{max}	4.30	6.05	6.10
V_{min} (pu)	0.931	0.947	0.954

4.3 | Tests on 83-bus distribution network of TPC

To evaluate the performance of the proposed method for larger practical distribution networks, other studies are carried out on 83-bus distribution network of TPC, depicted in Figure 9. This network is an 11.4 kV system with 11 feeders. In this network,

TABLE 3 Results of the tests on 83-bus distribution network of TPC

	Case 1	Case 4	Case 5
Open switches	84-85-86-87-88-89-90-91-92-93-94-95-96	7-13-33-37-42-62-82-84-86-87-89-90-92	7-13-33-37-42-62-82-84-86-87-89-90-92
P_{DG1} (kW)	500	415	495
P_{DG2} (kW)	500	485	474
P_{DG3} (kW)	500	483	492
P_{DG4} (kW)	500	397	497
P_{DG5} (kW)	500	489	499
P_{DG6} (kW)	500	487	482
P_{DG7} (kW)	500	498	500
P_{DG8} (kW)	500	497	500
P_{DG9} (kW)	500	500	499
P_{DG10} (kW)	500	500	499
P_{loss} (kW)	407.65	380.05	376.33
SCC index	8655.80	8441.92	8456.14
λ_{max}	4.5	5.01	5.01
V_{min} (pu)	0.937	0.948	0.948

it is assumed that all lines have sectionalising switches; so there are 83 sectionalising switches, and 13 tie switches in the network. Totally, 10 DERs on the busses 5, 7, 12, 20, 28, 39, 53, 60, 76, and 83 with a maximum power capacity of 500 kW are considered in this network. Other data for this network such as its line and load data could be found in [24].

To conduct the proposed method and see its performance, it is considered that two simultaneous faults occur in the network on lines 13 and 86. These faulted lines are isolated by opening the available switches in the network. Then, a network reconfiguration is requested by the self-healing system to reduce the power outage and supply as many loads as possible, until the fault nature is completely removed by the repair crews. Table 3 shows the results of the optimization algorithm

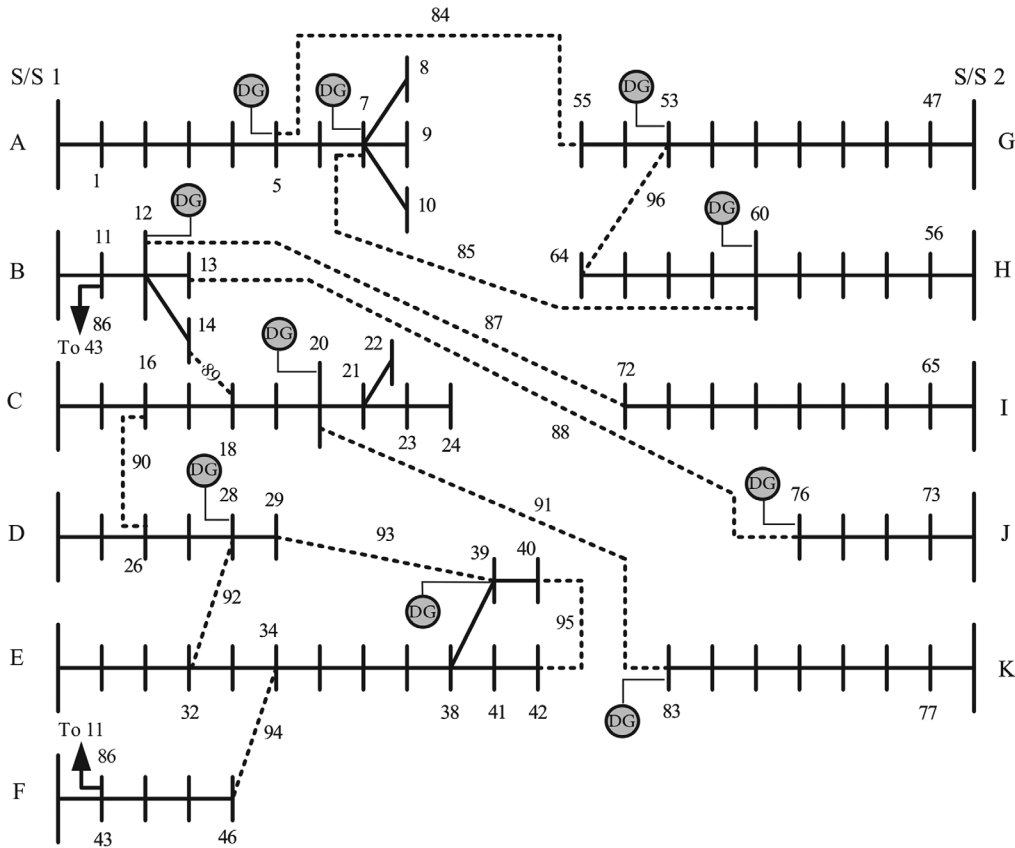

FIGURE 9 83-bus distribution network of TPC with DERs locations [24]

for the mentioned studies under both deterministic and stochastic conditions. As it can be observed, in both cases, the network parameters are improved which prove the applicability of proposed framework for real-world large-scale distribution networks.

5 | CONCLUSION

With the increasing dependence of social life on the electrical energy, reliability of the electric networks and service continuity is highly expected by the electricity customers. Implementing a secure, reliable, and efficient distribution network necessitates moving toward the smart grids. Self-healing capabilities are considered as one of the most important features of the smart distribution networks. In these networks, to reduce the power outages, after the fault isolation through opening the breakers, the network is reconfigured. For such an application, a stochastic framework for the network reconfiguration was proposed and tested in this article that led to the following concluding remarks:

- As the faulted network is more prone to face another fault, to be sure of the capability of switches to break the possible upcoming fault currents, an index has been proposed to prevent the insecure increase of the short circuit capacity and its performance successfully examined.

- It was shown that when the DGs actively produce power in the distribution network while short circuit capacity is considered in the reconfiguration procedure, the risk of system failure due to the voltage collapse becomes high, especially in case of a load increment in a wounded network where some lines and equipment do not exist. Therefore, loadability and voltage profile improvement have been also considered in the reconfiguration procedure.
- Fix load demand consideration in the previous studies has been challenged in this article and for covering their uncertainties, an approach based on chance-constrained programming has been proposed. It was proved that the proposed stochastic framework increases the security of the network while improving the operating condition.

To continue this research direction, considering the stochastic generation of renewable energy resources in the formulations and proposing a method to cover generation uncertainties are suggested as future works.

FUNDING

None.

CONFLICT OF INTEREST

The authors declare that there is no conflict of interest

DATA AVAILABILITY STATEMENT

The data that support the findings of this study are available in [7].

ORCID

Vahid Vahidinasab  <https://orcid.org/0000-0002-0779-8727>

REFERENCES

- Baharvandi, A., Aghaei, J., Nikoobakht, A., Niknam, T., Vahidinasab, V., Giaouris, D., Taylor, P.: Linearized hybrid stochastic/robust scheduling of active distribution networks encompassing PVs. *IEEE Trans. Smart Grid* 11(1), 357–367 (2020) <https://doi.org/10.1109/TSG.2019.2922355>
- Moradi, S., Vahidinasab, V., Kia, M., Dehghanian, P.: A mathematical framework for reliability-centered maintenance in microgrids. *Int. Trans. Electr. Energy Syst.* 29(1), 1–21 (2019)
- Al Owaifeer, M., Al-Muhaini, M.: MILP-based technique for smart self-healing grids. *IET Gener. Transm. Distrib.* 12(10), 2307–2316 (2018)
- Takenobu, Y., Yasuda, N., Kawano, S., Minato, S.-I., Hayashi, Y.: Evaluation of annual energy loss reduction based on reconfiguration scheduling. *IEEE Trans. Smart Grid* 9(3), 1986–1996 (2018)
- Huang, S., Wu, Q., Cheng, L., Liu, Z.: Optimal reconfiguration-based dynamic tariff for congestion management and line loss reduction in distribution networks. *IEEE Trans. Smart Grid* 7(3), 1295–1303, (2016)
- Arasteh, H., Sepasian, M.S., Vahidinasab, V.: An aggregated model for coordinated planning and reconfiguration of electric distribution networks. *Energy* 94, 1 (2016)
- Amanulla, B., Chakrabarti, S., Singh, S.: Reconfiguration of power distribution systems considering reliability and power loss. *IEEE Trans. Power Deliv.* 27(2), 918–926 (2012)
- López, J.C., Rider, M.J., Lavorato, M., Franco, J.F.: Robust optimization applied to the reconfiguration of distribution systems with reliability constraints. *IET Gener. Transm. Distrib.* 10(4), 917–927 (2016)
- Mendoza, J.E., López, E.A., López, M.E., Coello Coello, C.A.: Microgenetic multiobjective reconfiguration algorithm considering power losses and reliability indices for medium voltage distribution network. *IET Gener. Transm. Distrib.* 3(9), 825–840 (2009)
- Bahadoorsingh, S., Milanovic, J.V., Zhang, Y., Gupta, C.P., Dragovic, J.: Minimization of voltage sag costs by optimal reconfiguration of distribution network using genetic algorithms. *IEEE Trans. Power Deliv.* 22, (4), 2271–2278 (2007)
- Kianmehr, E., Nikkha, S., Vahidinasab, V., Giaouris, D., Taylor, P.: A resilience-based architecture for joint distributed energy resources allocation and hourly network reconfiguration. *IEEE Trans. Ind. Inform.* 15(10), 5444–5455 (2019)
- Arias-Albornoz, M., Sanhueza-Hardy, H.: Distribution network configuration for minimum energy supply cost. *IEEE Trans. Power Syst.* 19(1), 538–542 (2004)
- Zhou, Q., Shirmohammadi, D., Liu, W.-H.E.: Distribution feeder reconfiguration for operation cost reduction. *IEEE Trans. Power Syst.* 12(2), 730–735 (1997)
- Srivastava, S.K., Butler-Purry, K.L.: Probability-based predictive self-healing reconfiguration for shipboard power systems. *IET Gener. Transm. Distrib.* 1(3), 405 (2007)
- Cavalcante, P.L., et al.: Centralized self-healing scheme for electrical distribution systems. *IEEE Trans. Smart Grid* 7(1), 145–155 (2016)
- Botea, A., Rintanen, J., Banerjee, D.: Optimal Reconfiguration for supply restoration with informed A* search. *IEEE Trans. Smart Grid* 3(2), 583–593 (2012)
- Diestel, R.: *Graph Theory*, 4th ed. Springer, Berlin (2010)
- Fournier, J.-C.: *Graph Theory and Applications*. ISTE Ltd and John Wiley, New York (2009)
- Odetayo, B., MacCormack, J., Rosehart, W., Zareipour, H.: A chance constrained programming approach to integrated planning of distributed power generation and natural gas network. *Electr. Power Syst. Res.* 151, 197–207 (2017)
- Yang, N., Yu, C., Wen, F., Chung, C.: An investigation of reactive power planning based on chance-constrained programming. *Int. J. Elect. Power Energy Syst.* 29(9), 650–656 (2007)
- Johnathon, C., Kennedy, J.: A proposed algorithm for the self-healing of power distribution networks. In: 2018 IEEE Innovative Smart Grid Technologies - Asia (ISGT Asia), pp. 816–821 (2018)
- Elmitwally, A., Elsaid, M., Elgamal, M., Chen, Z.: A fuzzy-multiagent self-healing scheme for a distribution system with distributed generations. *IEEE Trans. Power Syst.* 30(5), 2612–2622 (2015)
- Cavalcante, P.L., et al.: Centralized self-healing scheme for electrical distribution systems. *IEEE Trans. Smart Grid* 7(1), 145–155 (2016)
- Ahmadi, S.A., Vahidinasab, V., Ghazizadeh, M.S., Mehran, K., Giaouris, D., Taylor, P.: Co-optimizing distribution network adequacy and security by simultaneous utilization of network reconfiguration and distributed energy resources. *IET Gener. Transm. Distrib.* 13, 20 (2019)

How to cite this article: Ahmadi S.-A., Vahidinasab V., Ghazizadeh M.S., Giaouris D. A stochastic framework for secure reconfiguration of active distribution networks stochastic framework for secure reconfiguration. *IET Gener. Transm. Distrib.* 1–11 (2021) <https://doi.org/10.1049/gtd2.12303>.