

SPONSORED PROJECT TERMINATION/CLOSEOUT SHEET

Date 12/5/84

Project No. A-3728 ~~XXXX~~ School/Lab STL

Includes Subproject No.(s) N/A

Project Director(s) R. B. Cotton GTRC/ ~~GTX~~

Sponsor Hill AFB, Utah

Title L Band Guidance Antenna

Effective Completion Date: 12/23/83 (Performance) 6/29/84 (Reports)

Grant/Contract Closeout Actions Remaining:

- None
- Final Invoice or Final Fiscal Report
- Closing Documents
- Final Report of Inventions Patent Questionnaire sent to Project Director,
- Govt. Property Inventory & Related Certificate
- Classified Material Certificate
- Other _____

Continues Project No. _____ Continued by Project No. _____

COPIES TO:

Project Director
 Research Administrative Network
 Research Property Management
 Accounting
 Procurement/EES Supply Services
 Research Security Services
 Reports Coordinator (OCA)
 Legal Services

Library
 GTRI
 Research Communications (2)
 Project File
 Other Mildred Heyser; A. Jones

ENGINEERING EXPERIMENT STATION

Georgia Institute of Technology

A Unit of the University System of Georgia

Atlanta, Georgia 30332

21 February 1984



Special Activities
Ogden ALC/PM(2)
Building 1225
Hill AFB, UT 84056

Attention: Rex Smith

Subject: Project A-3728 Monthly Status Report #2
February 1984

Reference: Contract No. F42650-83-C-3078

Gentlemen:

All hardware ordered during the month of January has arrived with the exception of the antenna. It was shipped from Ainslie on 14 February and should arrive this week. The feed was matched this month. The worst case VSWR was 2.0:1, and this occurred only once at the center of the band. The feed support has been finished and now only awaits painting. The feed stem and support will be sealed with RTV to prevent water leakage and galvanic corrosion.

Once the antenna arrives from Ainslie, everything will be ready for pattern measurements. These measurements will proceed when the antenna range is available, provided Jay Nerby has informed us of additional frequencies at which gain measurements are to be made other than the lower edge, middle, and upper edge of the band. We are currently on schedule without any anticipated delays.

Respectfully submitted,

Rickey B. Cotton
A-3728 Project Director

xc: Jay Nerby

RBC/kmp

A 3728

ENGINEERING EXPERIMENT STATION



Georgia Institute of Technology

A Unit of the University System of Georgia

Atlanta, Georgia 30332

26 March 1984

Special Activities
Ogden ALC 1 PM(2)
Building 1225
Hill AFB, UT 84056

ATTENTION: Rex Smith

SUBJECT: Project A-3728 Monthly Status Report #3, March 1984

REFERENCE: Contract No. F42650-83-C-3078

Gentlemen:

After a telephone conversation with Jay Nerby at the first of March, the feedstem for the MGS antenna was retuned by his request, to provide better return loss from 1200 to 1250 MHz. The lowest return loss achieved over this frequency range varied from 13 dB to 15 dB which corresponds to a VSWR between 1.60:1 and 1.45:1. With this present configuration, the antenna operates with better than a 2.0:1 VSWR from 1090 MHz to 1400 MHz.

The antenna is currently ready for far-field testing but the antenna range will not be available until approximately April 10 due to weather delays affecting another project. We have asked for a no-cost extension of one month to allow time for testing. If this extension is granted, we intend to high power test the feedstem during this time. We intend to use a Ratheon Type 5J26 coaxial magnetron which is tunable from 1220 MHz to 1350 MHz with a maximum peak power output of 550 KW. We will only test up to 230 KW since this is the peak power rating of the coax, and beyond that we will be destructively testing the feed.

We may have to ask Mr. Jay Nerby to help support us with some coaxial parts temporarily for high power testing if we can't borrow them locally.

Respectfully submitted,

Rickey B. Cotton

RBC:gjp

Enclosure

xc: Jay Nerby

RETURN LOSS

HELIX

3/20/84 RKP

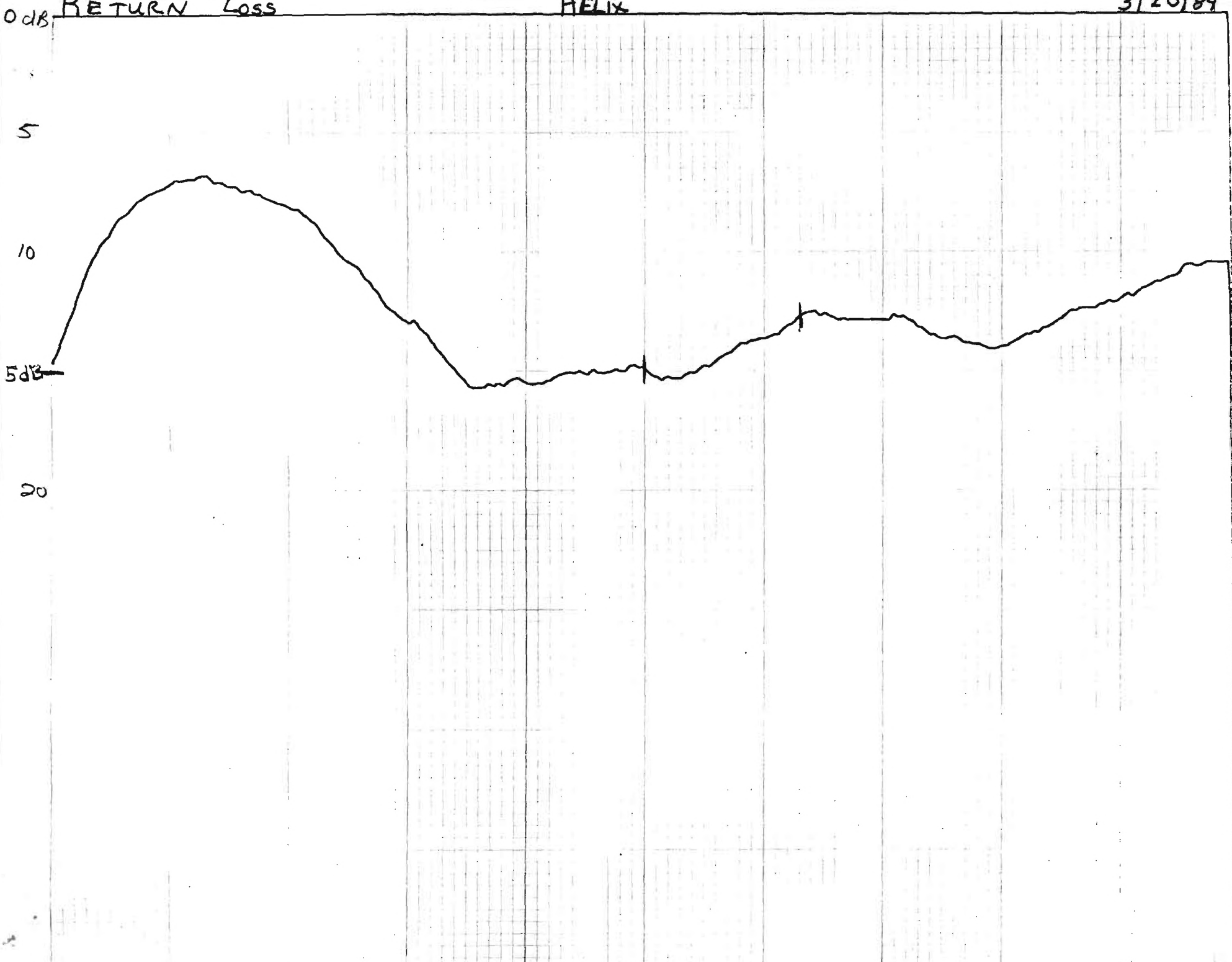

ENGINEERING EXPERIMENT STATION

Georgia Institute of Technology

A Unit of the University System of Georgia

Atlanta, Georgia 30332

24 April 1984

Special Activities
Ogden ALC/PM(2)
Building 1225
Hill AFB, UT 84056

Attention: Rex Smith

Subject: Project A-3728 Monthly Status Report #4
April 1984

Reference: Contract No. F42650-83-C-3078

Gentlemen:

During the month of April, the far-field antenna range was not available. This time was used to organize for the high-power testing. We obtained the coaxial magnetron and constructed a test enclosure for the feedstem. We are currently testing our modulator in preparation for our final testing. Any remaining time was spent preparing for the antenna range measurements. A mounting fixture has been prepared, the source antenna has been assembled and standard gain horns have been obtained for making gain measurements.

The current schedule for the month of May has been planned. During the first week of May, one day will be spent performing an initial high-power test on the feedstem. For the remainder of that week the antenna will be tested on the far-field range. The sponsor will then be invited to observe a second high-power test the following week. Once this has been performed, the feedstem will be shortened and the antenna will be packaged for shipping. During this final period, the Final Report will be assembled along with test data and blue prints for delivery.

Respectfully submitted,

Rickey-B. Cotton
A-3728 Project Director

xc: Jay Nerby

RBC/kmp



ENGINEERING EXPERIMENT STATION
Georgia Institute of Technology
A Unit of the University System of Georgia
Atlanta, Georgia 30332

7 June 1984

Special Activities
Ogden ALC/PM(2)
Building 1225
Hill AFB, UT 84056

Attention: Rex Smith

Subject: Project A-3728 Monthly Status Report #5
May 1984

Reference: Contract No. F42650-83-C-3078

Gentlemen:

During the month of May, the far-field antenna measurements were completed. The worst case axial ratio measured was 1.4 dB. This represents a significant improvement over the previous axial ratio of 2.0 dB. Also during this month, I filed for a contract extension of one month. I received verification of this Tuesday, May 29. Due to this, the progress report for May is slightly delayed. As of June 1, the magnetron has not arrived. We have currently stopped all work until the magnetron arrives. This should prevent any cost overruns and once the magnetron arrives, we will resume work.

Respectfully submitted,

Rickey B. Cotton
A-3728 Project Director

xc: Jay Nerby

RBC/kmp

DOCUMENTATION
AND
DATA
FOR
AN
L-BAND ANTENNA

**DOCUMENTATION AND DATA
FOR A L-BAND ANTENNA**

**Prepared for
AIR FORCE
SPECIAL ACTIVITIES
HILL AFB , UT.
UNDER
CONTRACT F42650-83-C-3078**

**by
Rickey Cotton**

EES/GIT Project A-3728

JUNE 1984

**ENGINEERING EXPERIMENT STATION
Georgia Institute of Technology
Atlanta, Georgia 30332**

1.0 L-Band Antenna

The L-Band antenna consists of a rear-fed paraboloidal reflector (914-mm diameter and 368-mm focal length) with a thin-wall radome as illustrated in Figure 1.0. The radiating portion of the feed stem is a backward-wave helix. The right-hand winding of the helix produces a LHC (left-hand circular) polarization to illuminate the paraboloidal reflector. After reflection, the far-field beam has a RHC (right-hand circular) polarization.

The principal components, other than the paraboloidal reflector, are the coaxial feed stem and the radome.

1.1 Coaxial Feed Stem

The coaxial feed stem is shown schematically in Figure 1.1. It is constructed from a section of 1 5/8 inch rigid coax. This rigid coax has a characteristic impedance of 50 ohms, whereas helices have impedances of about 140 ohms. Thus a two-stage quarter-wave transformer and a special coax-to-twinlead balun were employed to match the helix over the required 20 percent bandwidth.

The backward-wave helix requires no splash-plate at the end of the helix to illuminate the reflector. The last turn of the helix has a tapered pitch to reduce the overall length of the feed stem. A shorting stub near the end of the helix serves two purposes: (1) it improves (by virtue of its position) the impedance match across the frequency band, and (2) it gives mechanical support to the end of the helix.

1.2. Radome

The radome has a hemispherical shape and is provided to protect the feed stem from the outside environment. It is constructed of fiberglass with a 0.30-cm thick wall. This wall thickness is only about 0.02 wavelength, so it is electrically thin and has essentially no effect on the transmitted beam.

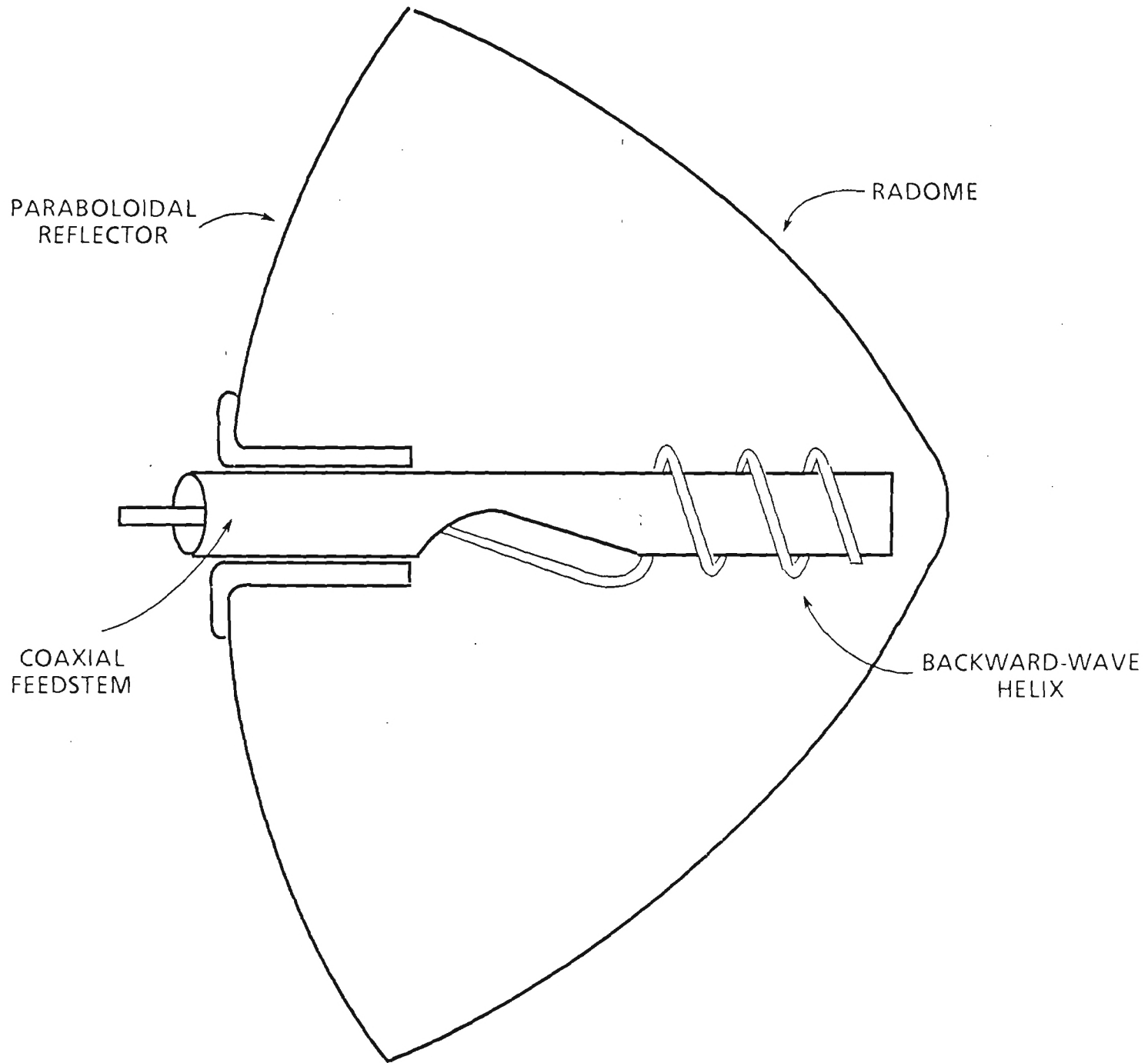

FIGURE 1.0. SCHEMATIC SKETCH OF L-BAND ANTENNA SHOWING PRIMARY COMPONENTS

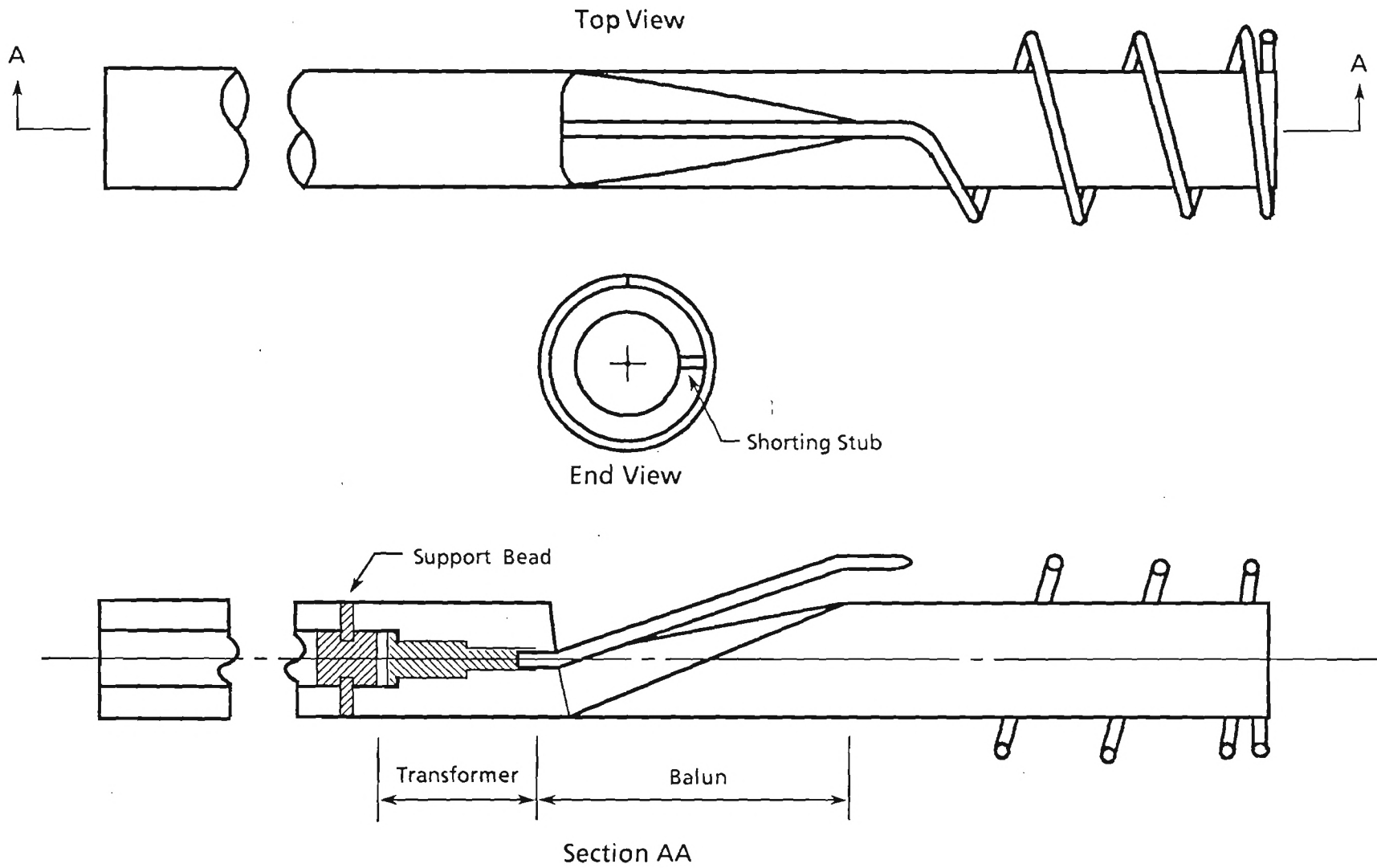

Figure 1.1. Sketch of the Backfire Helical Feed.

2.0 L-Band Antenna Maintenance

As described in section 1.0, The L-Band antenna consists of: a rear fed paraboloidal antenna, feed stem, thin wall radome, and a series of connectors and coax to interface with the L-Band transmitter. Because of its design and construction, the L-Band antenna should be relatively maintenance free unless it incurs physical abuse or some natural disaster. The antenna should be visually inspected in detail whenever the L-Band transmitter fails to operate due to a VSWR fault indication. The disassembly, inspection, and corrective maintenance are described below.

2.1. Radome

The radome, which has a hemispherical shape, is provided to protect the feed stem from the environment. It is constructed of fiberglass approximately .30-cm thick and is virtually invisible to the rf energy of the antenna. The radome is held in place by a series of bolts (56) located at the circumference of the paraboloidal reflector. All of the bolts must be removed to remove the radome. The radome should only be removed to visually inspect the feed or reflector, to replace the feed, or to repair the radome. The radome should be replaced if for some reason the skin has become ruptured or severely cracked. A spare radome should be available for this purpose. If one is not available, repair as a last alternative.

The radome may be repaired using standard fiberglass working techniques as long as the thickness of the radome repair is uniform in thickness. (not exceeding .30-cm), and the structural shape is not modified. Whenever the radome is removed and then replaced, all (56) bolts must be installed tightly with none left out.

2.2 Feed Inspection

The feed stem consists of a coaxial tube, a two-step transformer and a backward-wave helix as shown in Figure 1.1. A visual inspection of the antenna should include observing the reflector surface for warps or dents (on

the order of one inch or larger in diameter) and if any are found, the reflector should be replaced. The visual inspection should also include :

- 1) Inspecting the feed stem to observe whether the turns are all concentric with the coaxial tube.
- 2) The spacing between the turns (excluding the last turn) are equally spaced with a pitch (turn to turn spacing) of 1.9 inches.
- 3) To observe that the transition from the center conductor of the coax as it emerges into the helical windings is small with the spacing from the conductor walls being uniform.

If no damage or structural problems are noted, the radome should be re-installed.

An alternate method involves the removal of the feed stem for inspection and repair without removing the radome. The feed stem and feed support may be removed from the rear of the antenna by the following procedure:

- 1) Disconnect the coaxial cable from the EIA Field Flange.
- 2) Remove the entire assembly (feed stem, locking assembly and feed support) from the back of the antenna by removing the twelve bolts holding the feed support to the reflector and gently pulling out the feed assembly, being careful not to damage the helix.
- 3) Remove the EIA field flange and inner connector from the coaxial feed assembly. A small amount of twisting and pulling may be required, but care should be taken not to destroy the shape of the helix. Note the inner connector was tacked in place using epoxy.
- 4) Remove the Seal Plate from the back of the feed support. It is RTV'd in place to form a moisture barrier to prevent galvanic corrosion. A bead of RTV is also added at the front of the feed support near the helix as a moisture barrier. (Note: During reassembly, the RTV must be replaced to maintain the moisture barrier.)

- 5) Observe that the feed stem is held in the feed support by a locking assembly that has nine locking bolts. Loosen the bolts sufficiently, to allow the feed to slide out of the feed support. A small amount of twisting and pulling may be required, but care should be taken not to deform or destroy the helix.

The feed stem may also be removed from the front of the antenna if the radome has been removed, by following steps 1, 3, 4, and 5 above and by pulling the feed stem (from the front) out of the feed support.

Reassembly is accomplished by reversing the disassembly procedure with the following additions. Note that the feed support has a locating pin at its interface with the parabolic dish; this allows it to be installed in only one position. If the feed stem has been removed from the feed support, care should be exercised so that the feed stem is installed correctly when the feed support is bolted in place. The feed is correctly positioned when the opening in the coax (transition from the coax to the helix) is pointing toward the ground. Note also that the helical feed must be positioned properly, axially, so that the antenna remains focused.

2.3 Connectors

Provided the antenna feed connectors remain waterproof, no maintenance should be needed except for periodic inspection to make sure all nuts and bolts are tight. The connector located on the rear of the reflector inside the hollow super structure is an EIA field flange, which is clamped to the outer conductor of the of the feed stem and is removable. The inner connector is also included with the field flange. The inner connector has been modified to prevent the captured contact. This allows the coax to be separated easily from the transmitter cable to prevent deforming the helix. The inner connector has been epoxied to the EIA field flange in three spot locations.

3.0 Construction

Photographs have been provided during assembly to allow inspection of the components and how they are assembled.

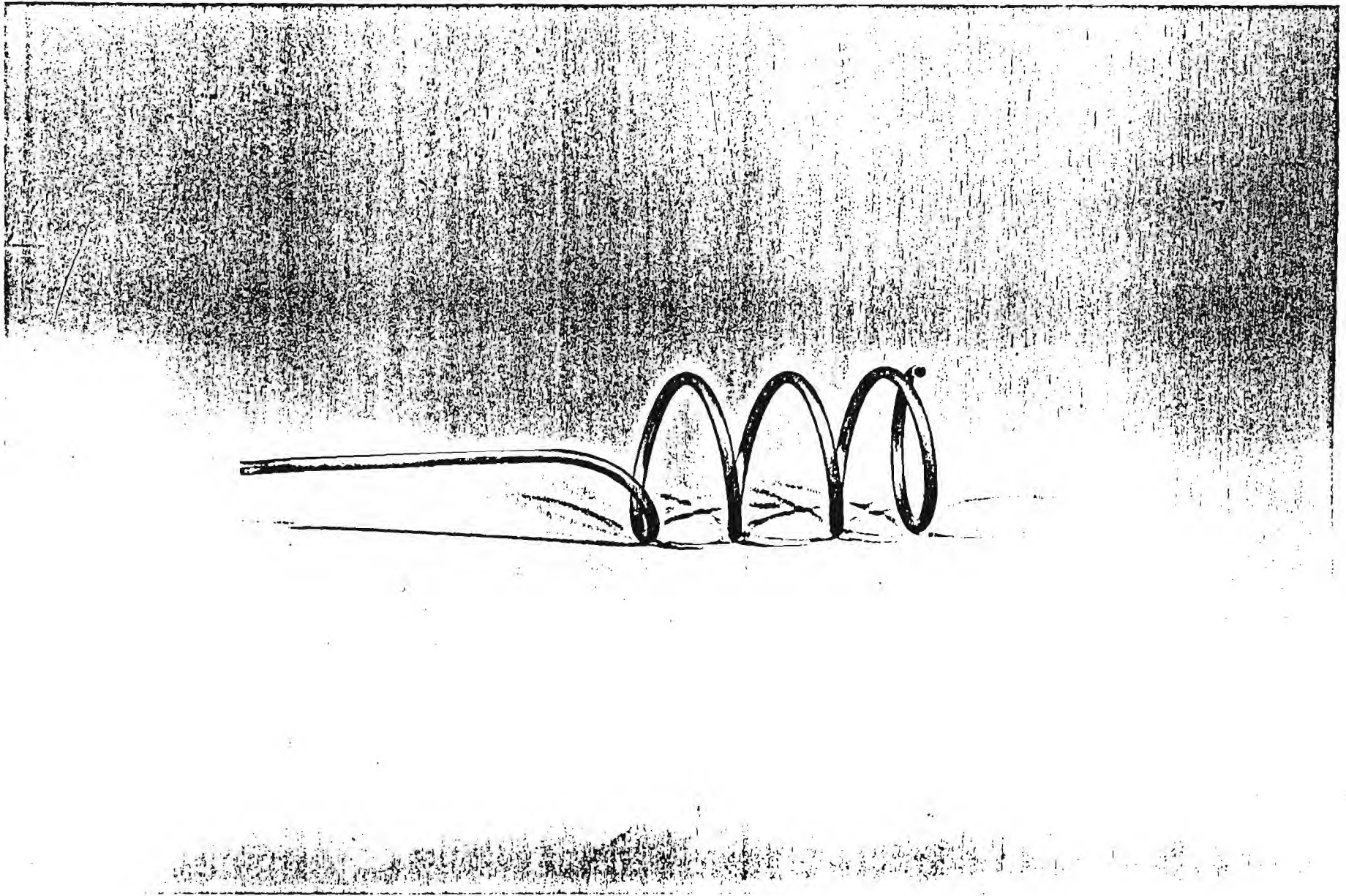



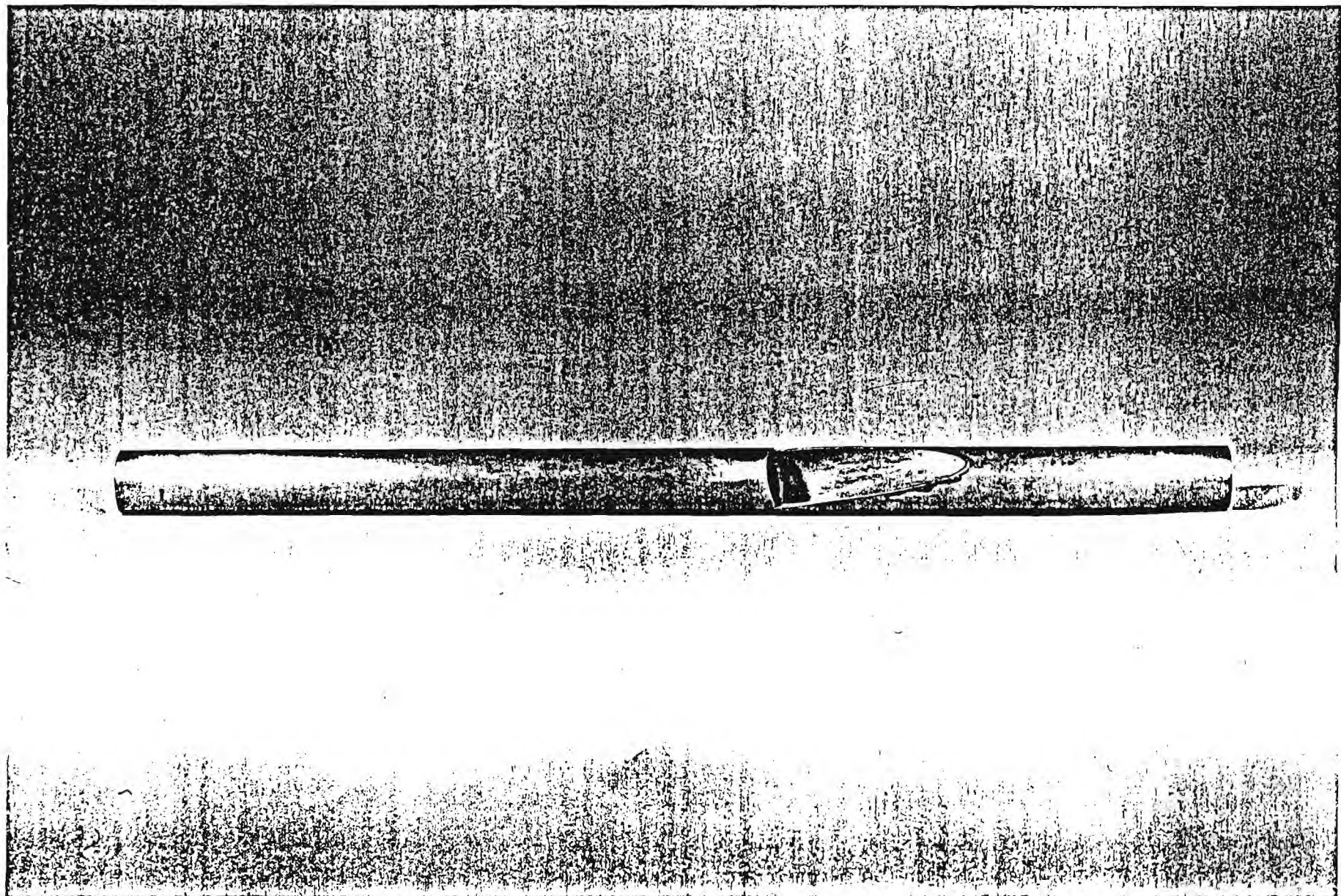

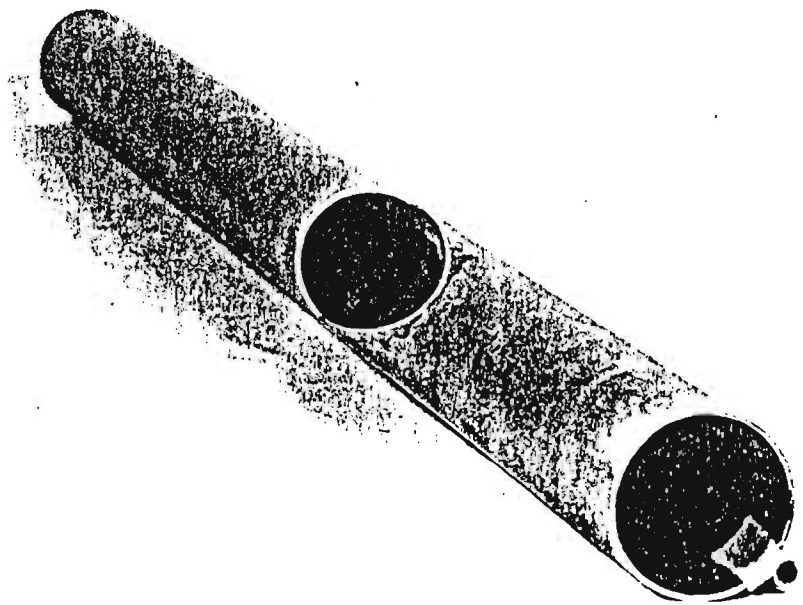

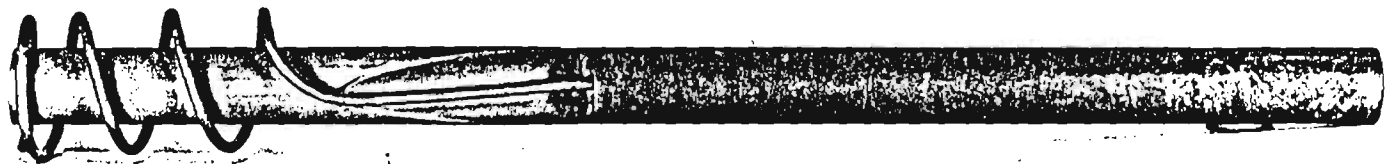

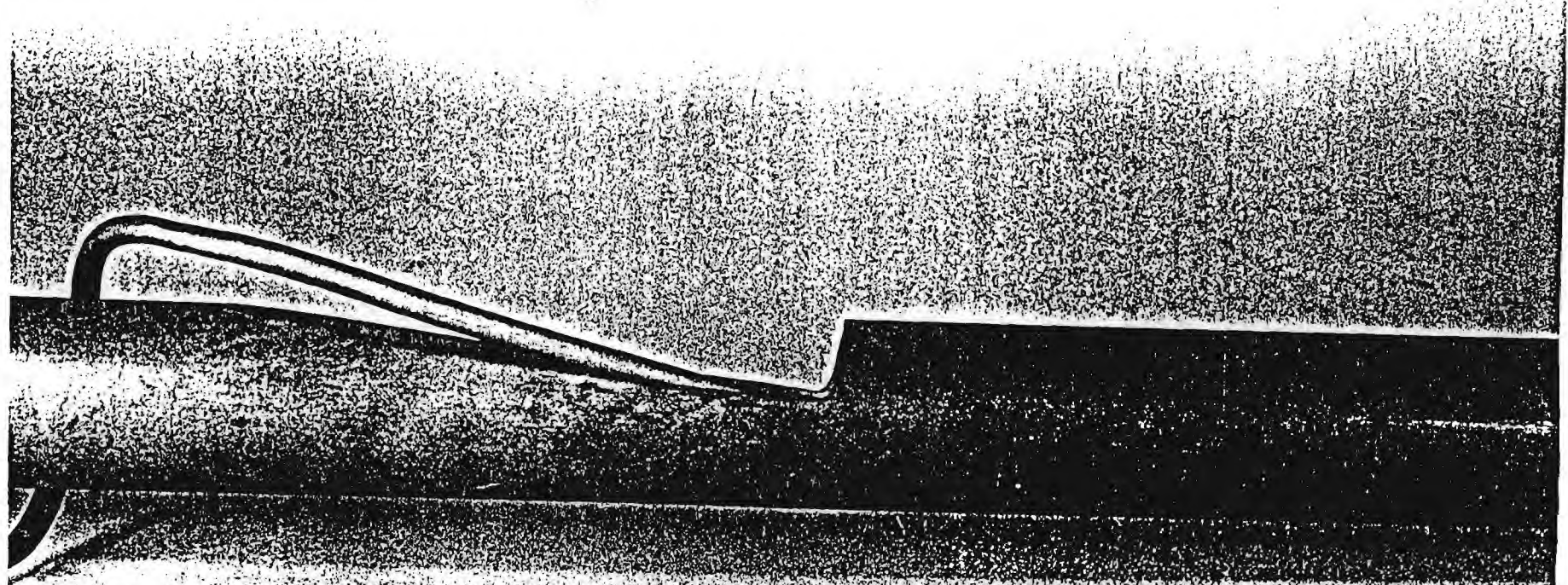

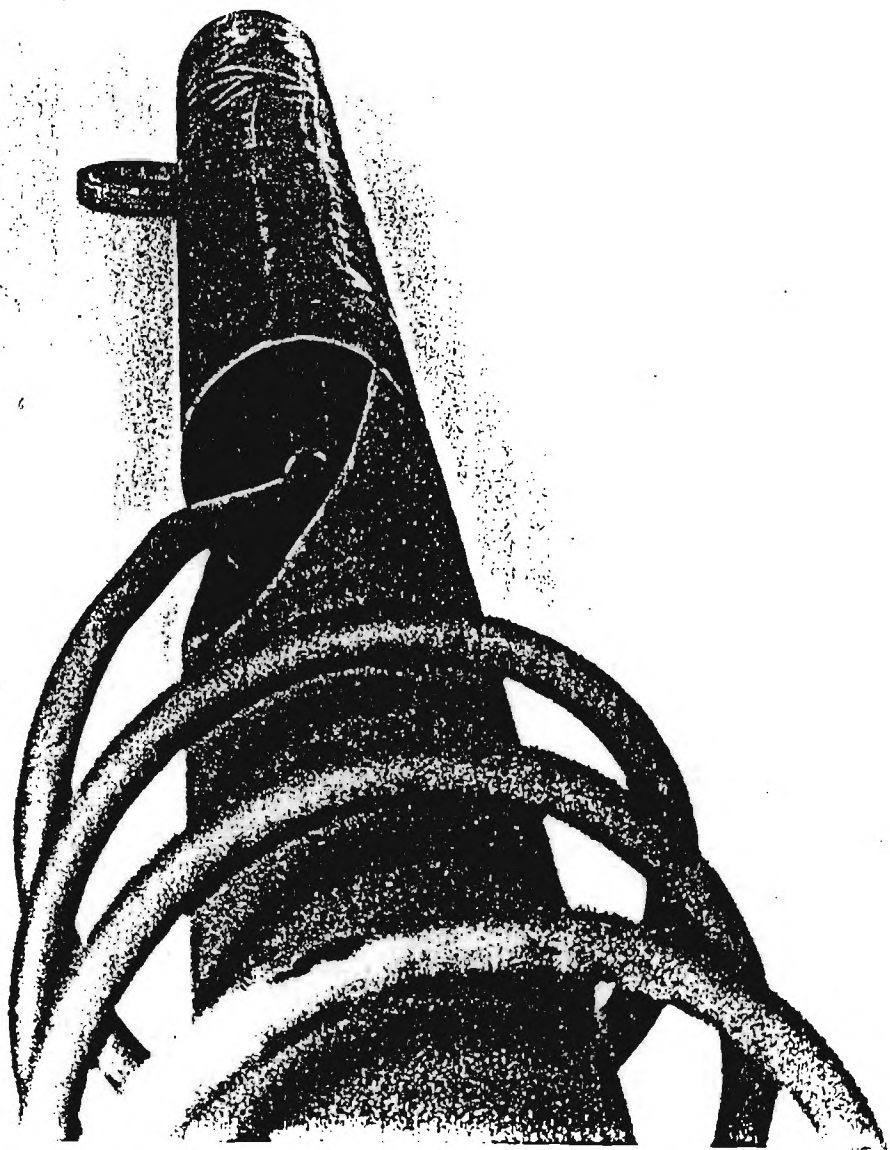

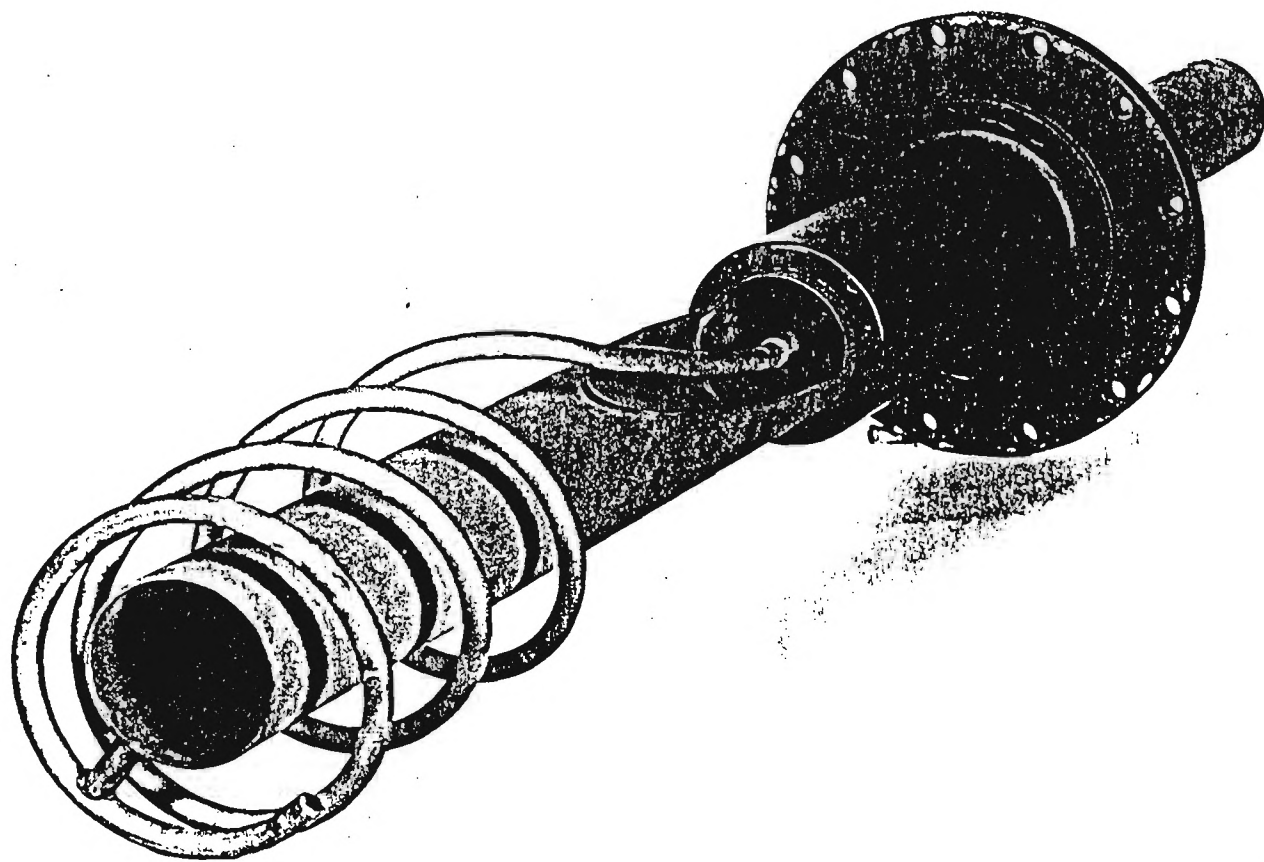

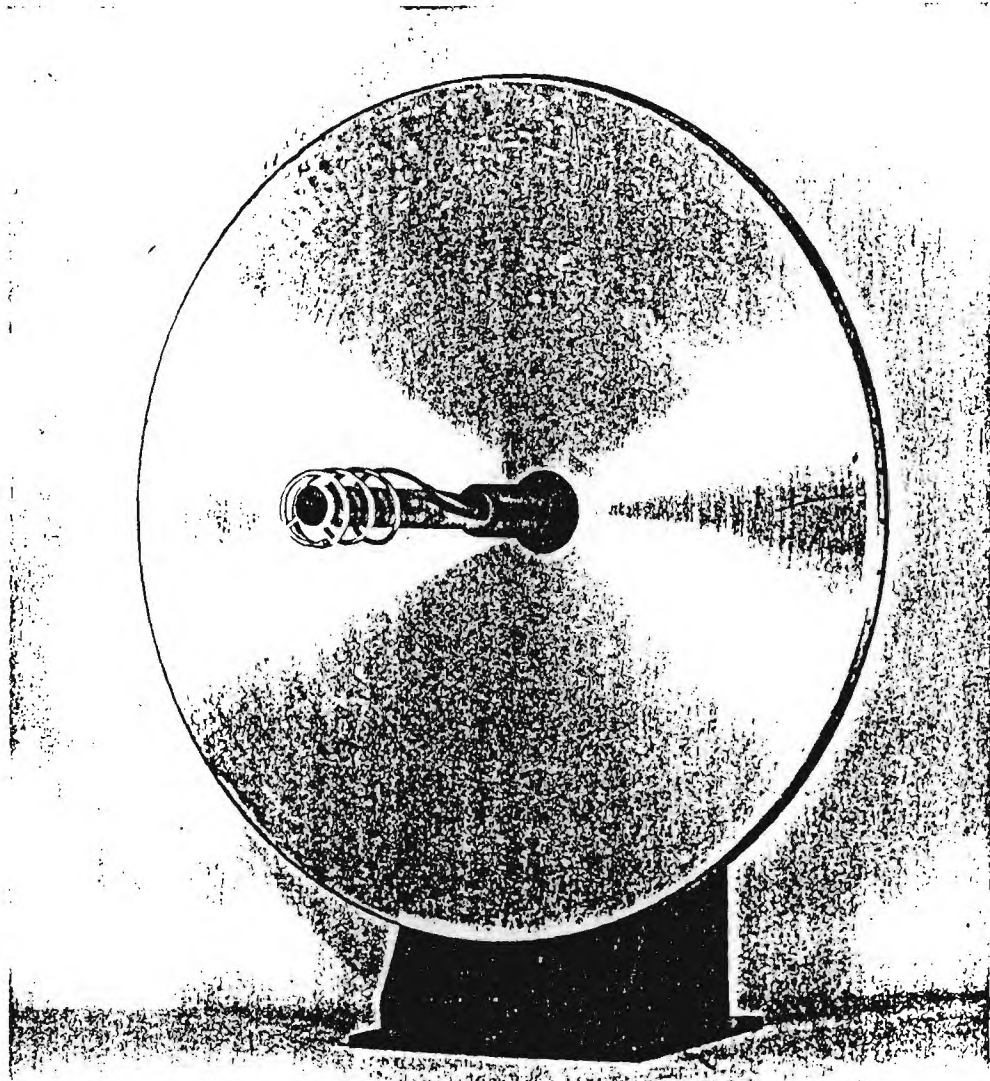

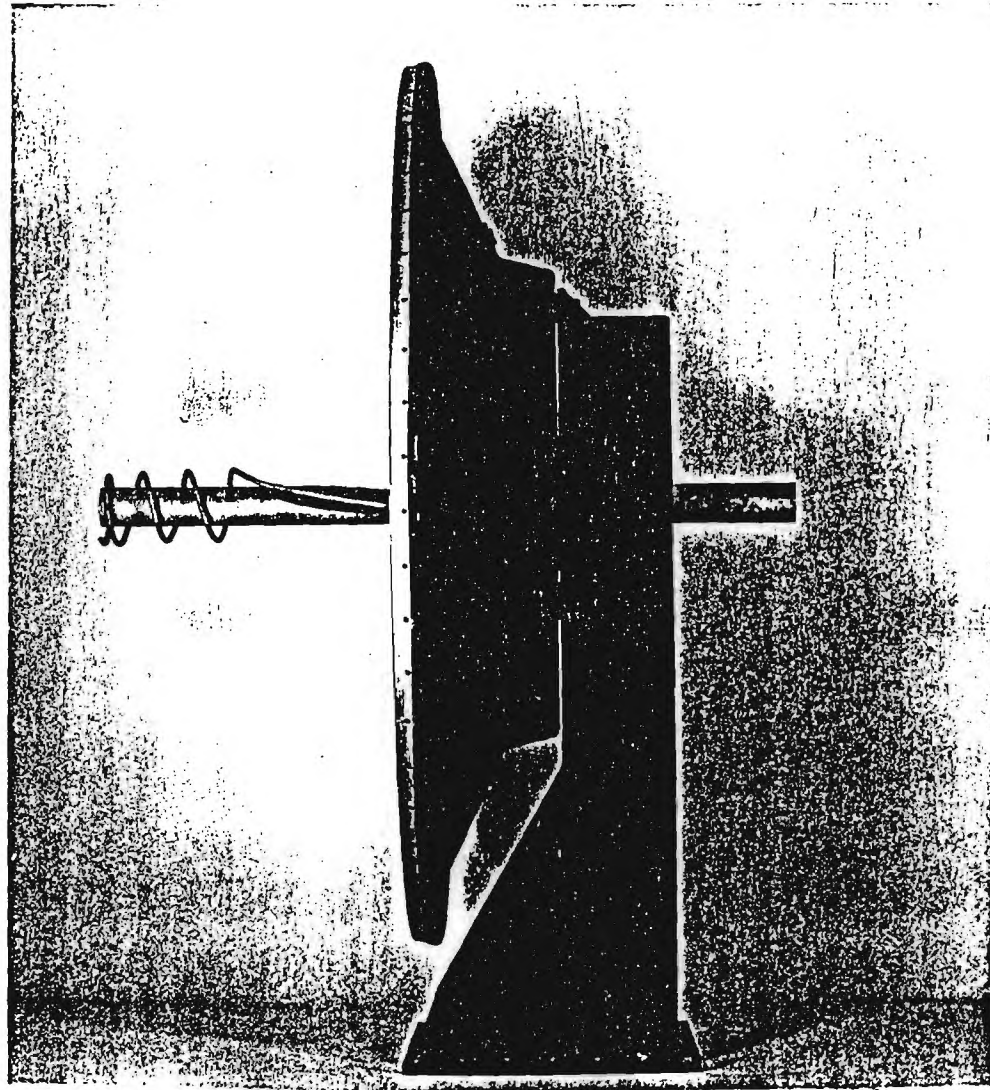

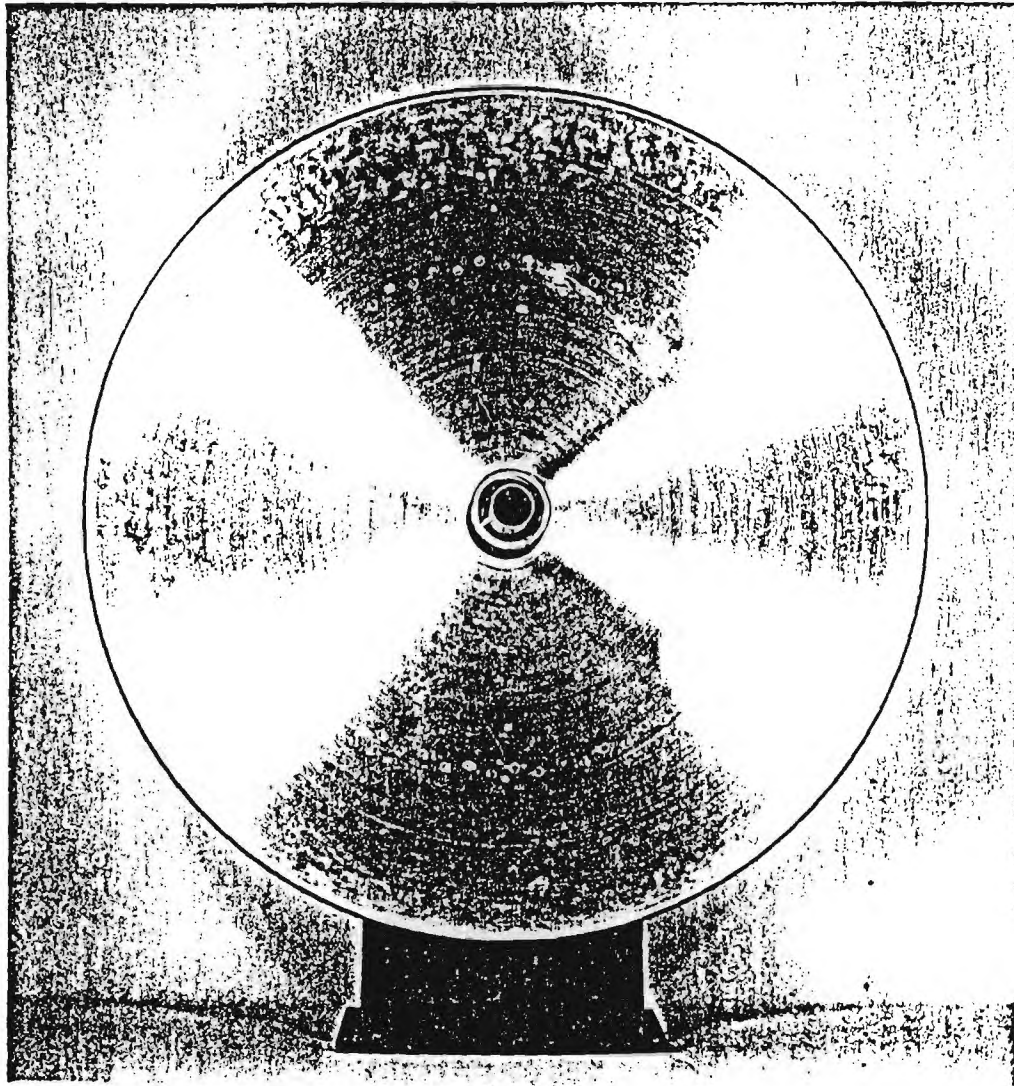

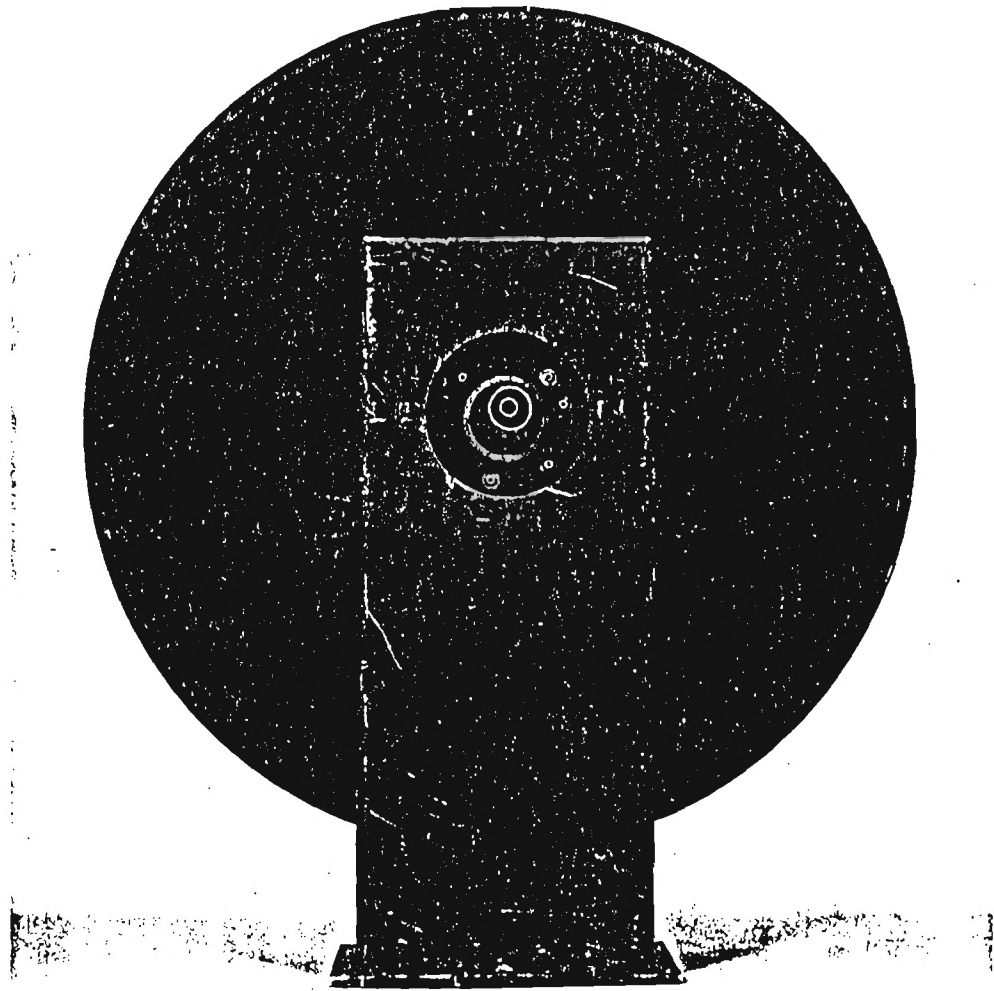

4.0 L-BAND ANTENNA MEASUREMENTS

The L-Band Antenna patterns were measured on the elevated range located at the Georgia Tech campus. This elevated outdoor range shown in figure 4.1 consist of a source antenna (SA) tower located on the roof of the Baker Building and a receive end located atop the eight story Howey Physics Building for the antenna under test (AUT). The length of this range is approximately 1000 feet.

The configuration of equipment for both the source and receive end is shown in Figure 4.2. The source end consisted of a HP-8672A Frequency Synthesizer whose output was connected via coax to a four foot dish. This set-up was used to illuminate the receive end. The majority of the equipment used on the receive end was manufactured by Scientific Atlanta, the positioner being an azimuth-over-elevation-over-azimuth pedestal. Also included was an SA-1783 precision three channel receiver (phase and amplitude) being phase locked by a reference antenna. Connected to the receiver was a phase and amplitude pattern recorder model SA-1580 which has been used to record the patterns which follow in this report.

Also included in this section are the measured patterns and tabulated results.

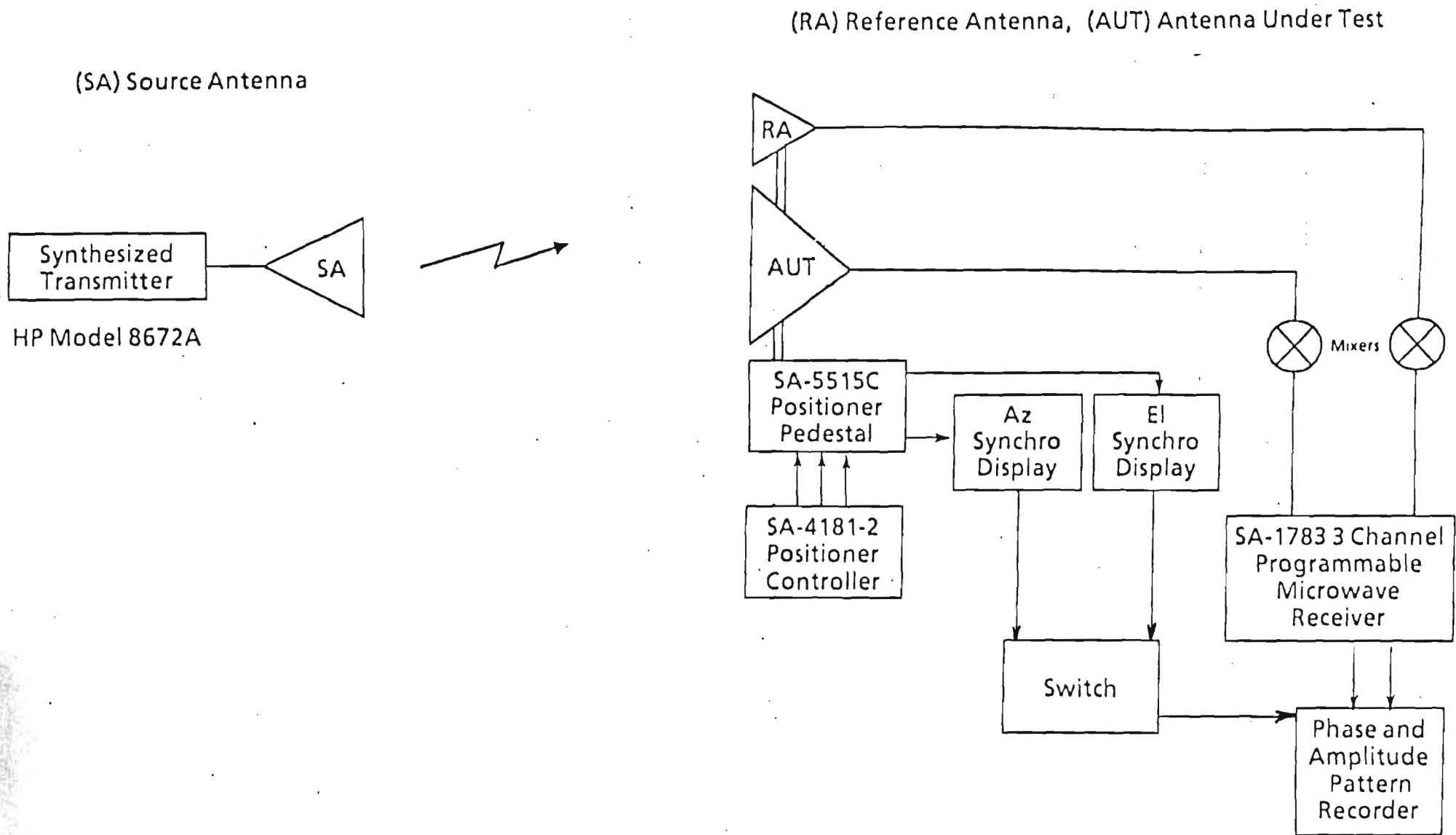

Figure 4.1 Measurement Equipment Configuration

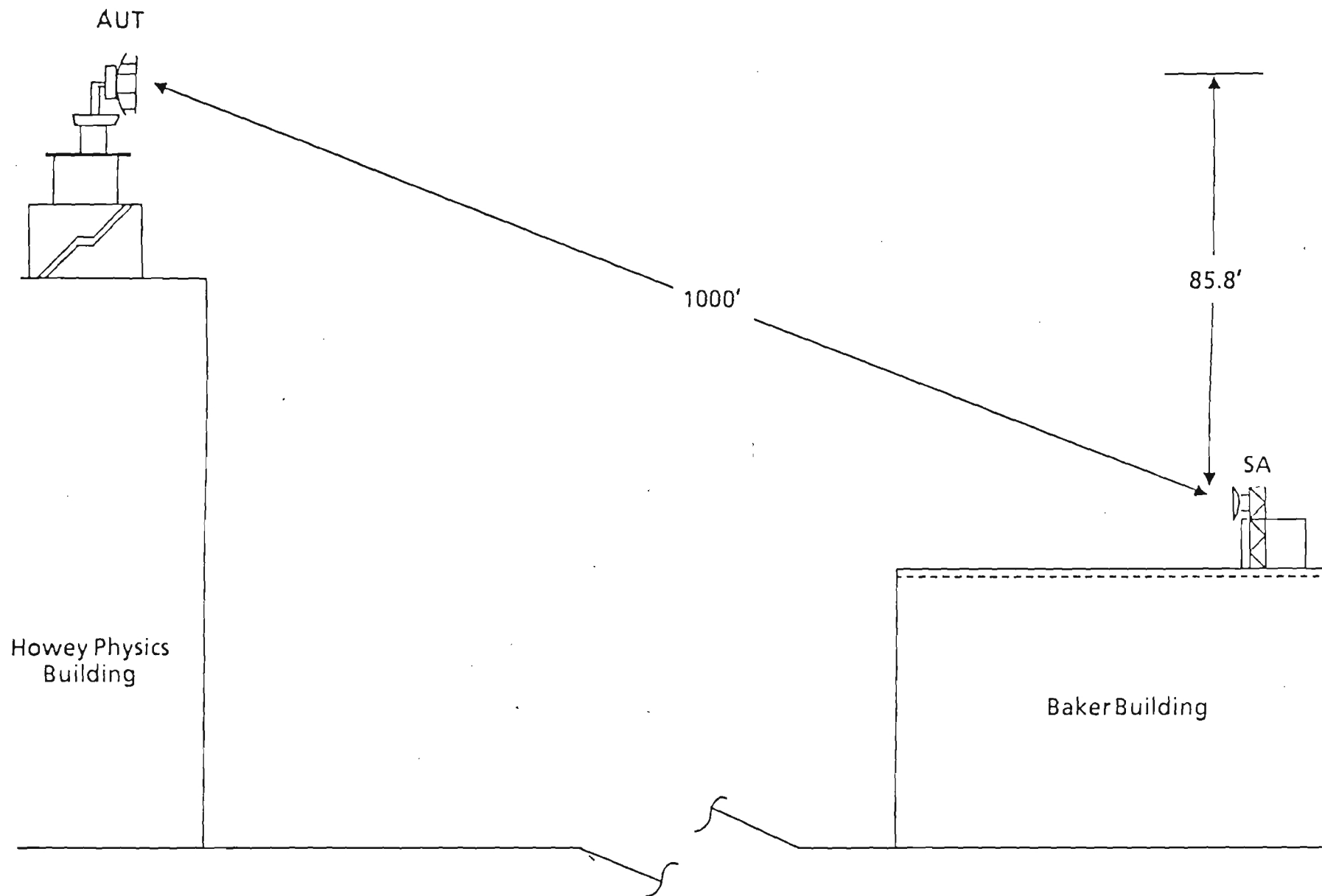
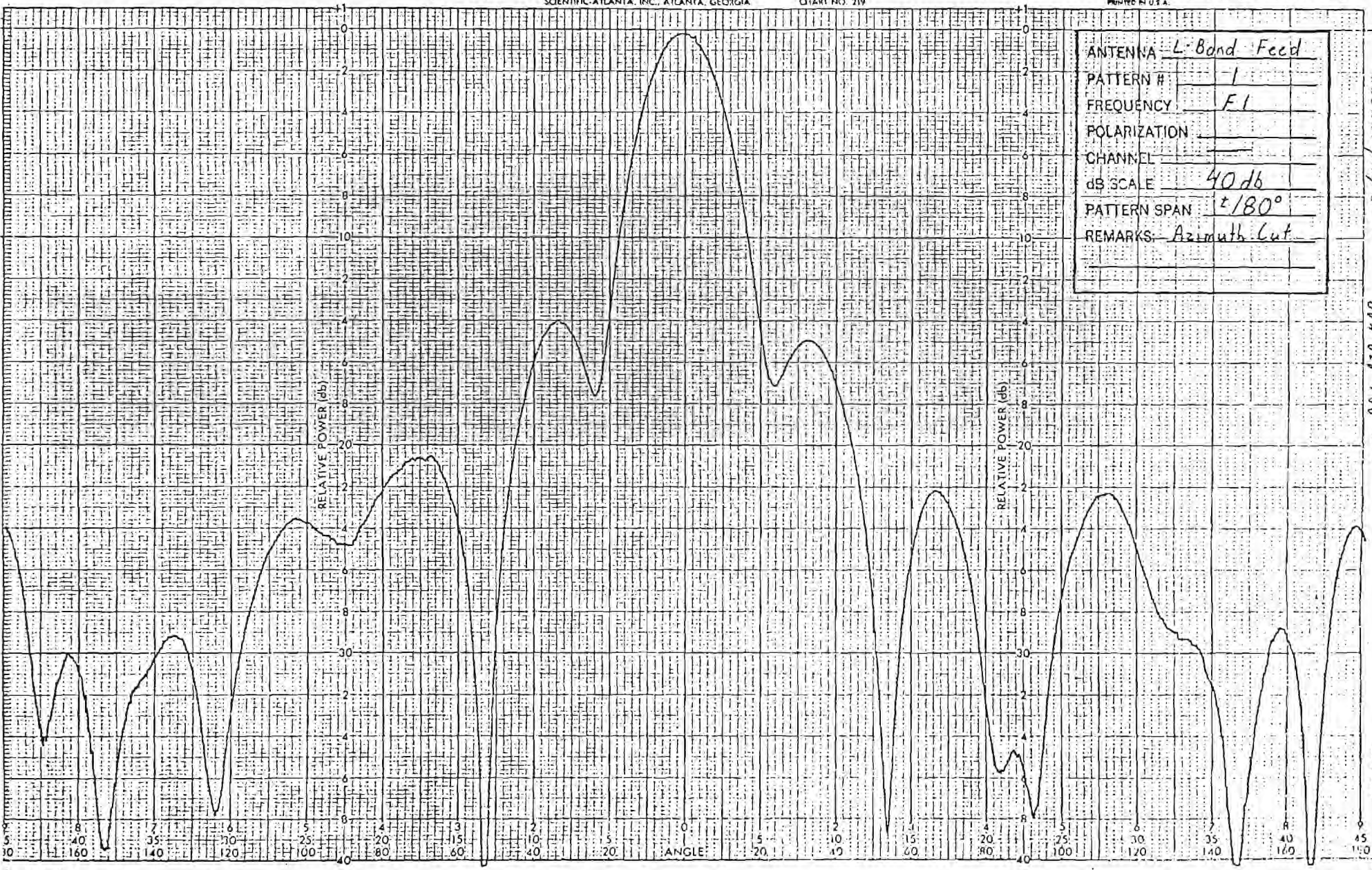

Figure 4.2 Antenna Range (side view)

ANTENNA	L-Band Feed
PATTERN #	1
FREQUENCY	F1
POLARIZATION	
CHANNEL	
dB SCALE	40db
PATTERN SPAN	$\pm 180^\circ$
REMARKS	Azimuth Cut



DATE 5/1/89 0539G
ENGR ROG, ASD, MAO

PROJECT
REMARKS

ANTENNA L-Band Feed
 PATTERN # 2
 FREQUENCY F1
 POLARIZATION _____
 CHANNEL _____
 dB SCALE 40db
 PATTERN SPAN ± 45°
 REMARKS: Azimuth Cut

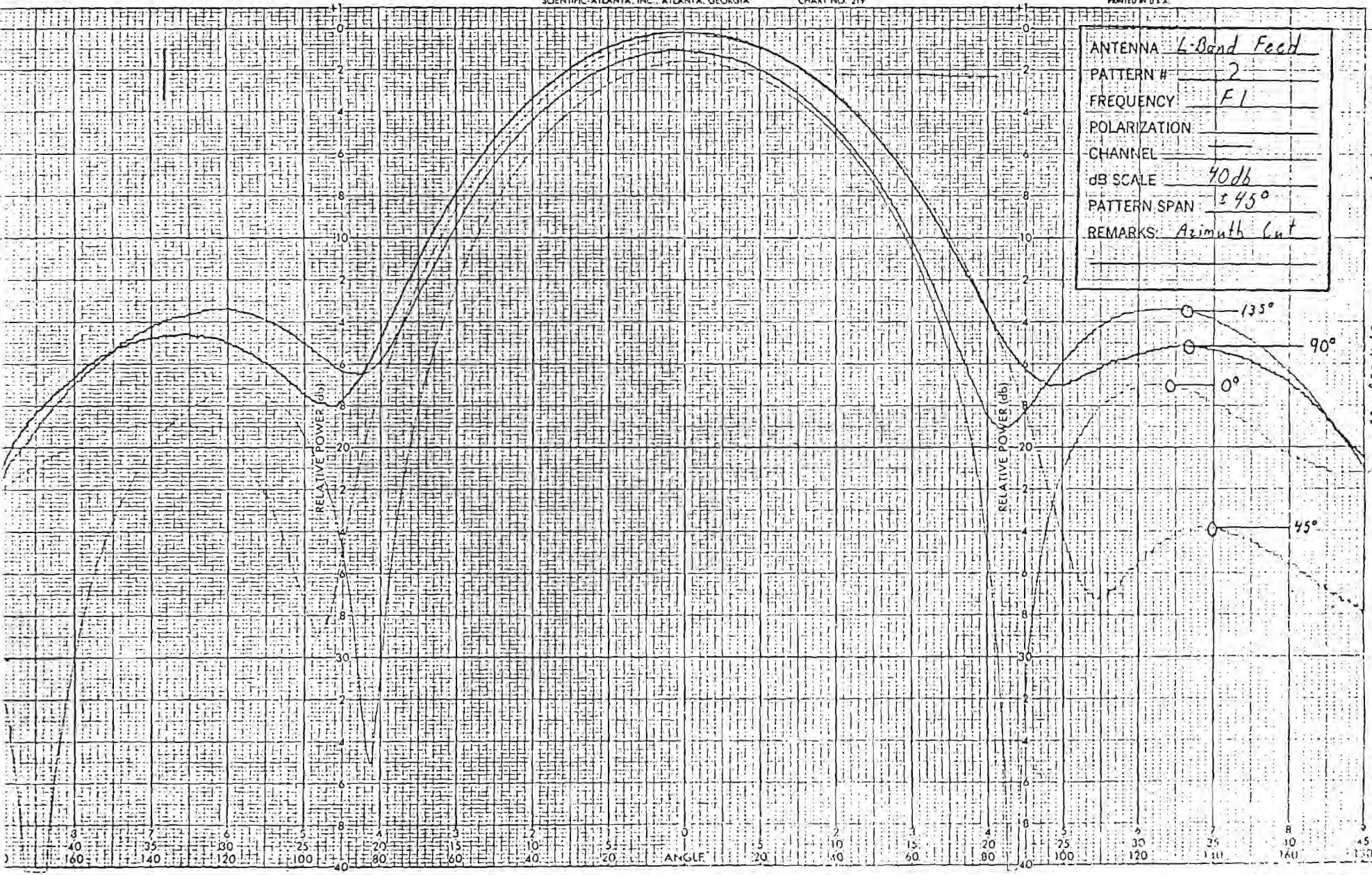

DATE 5/11/84 105357

PROJECT ENG'R B.C. R.J.D. X10

REMARKS

ANTENNA L-Band Feed
PATTERN # 3
FREQUENCY F1
POLARIZATION _____
CHANNEL _____
dB SCALE 40 db
PATTERN SPAN ±45°
REMARKS: Elevation Cut

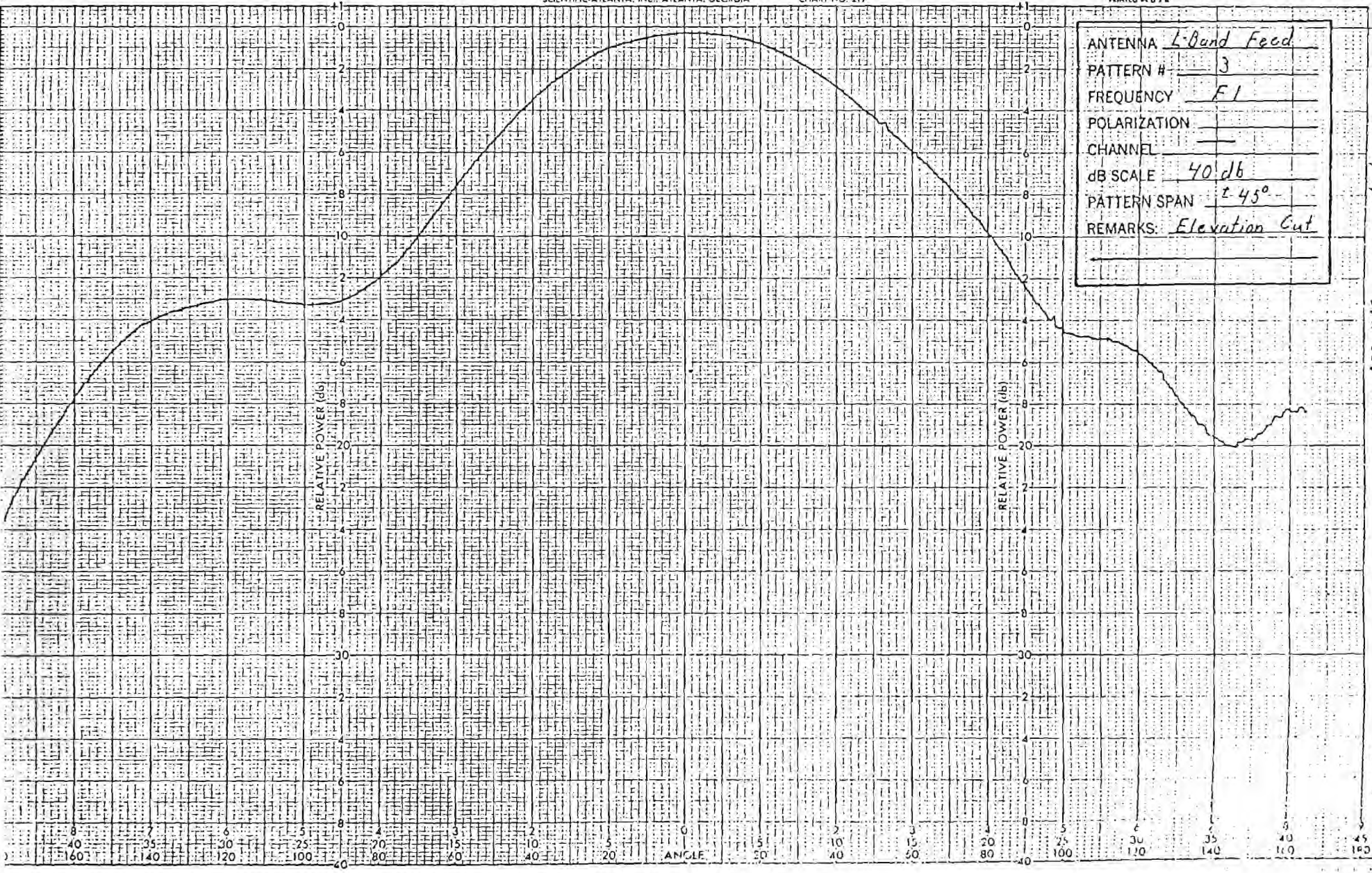

ENGR AOC, AJO, XAO DATE 5/11/74 105397

PROJECT REMARKS

ANTENNA	<i>L-Band Feed</i>
PATTERN #	<i>4</i>
FREQUENCY	<i>F2</i>
POLARIZATION	
CHANNEL	
dB SCALE	<i>40db</i>
PATTERN SPAN	<i>±180°</i>
REMARKS	<i>Azimuth Cut</i>

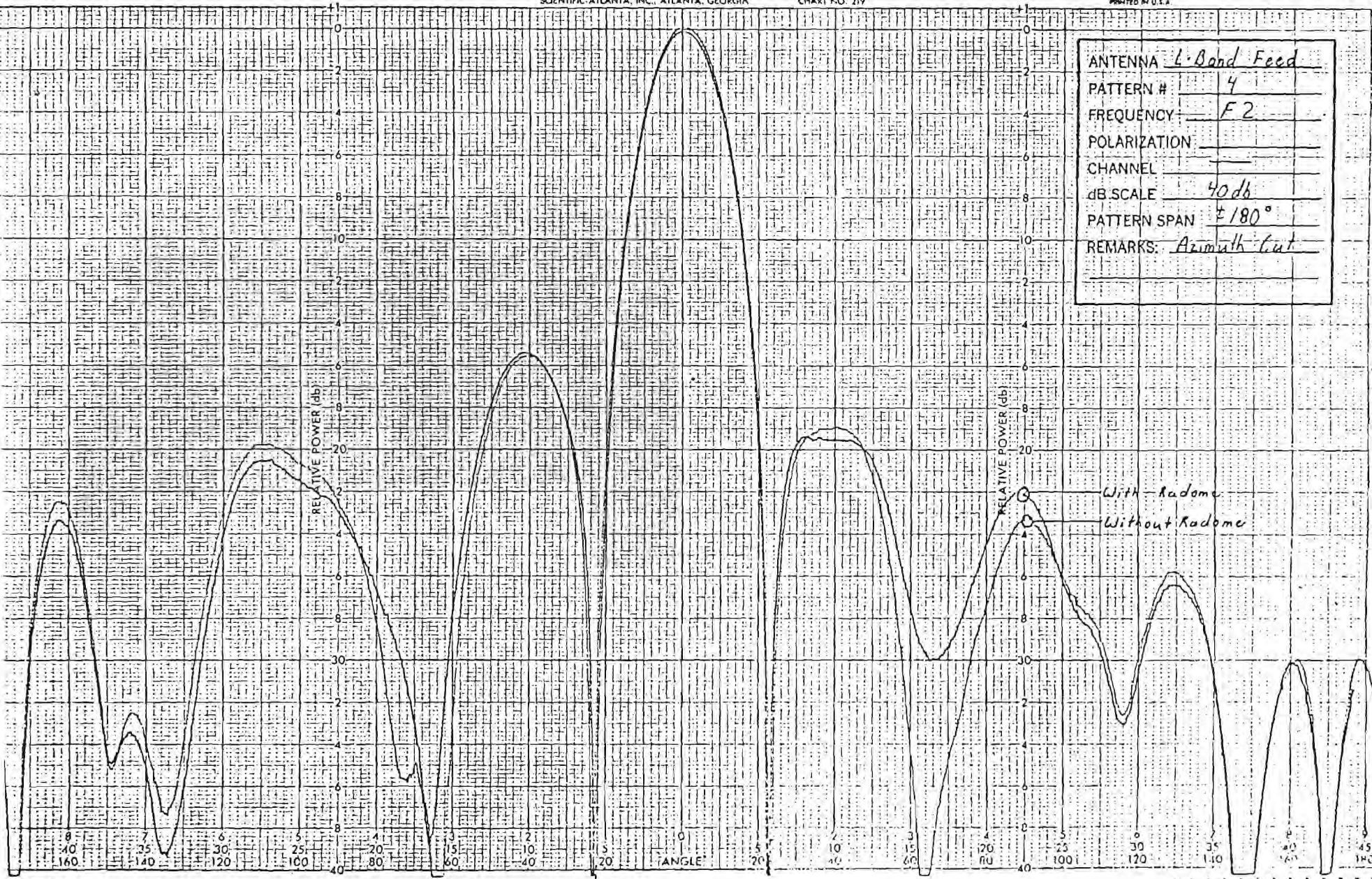

ENGR ABC, RJD, KMO DATE 5/11/71 105399

PROJECT REMARKS

ANTENNA	<i>L-Band Feed</i>
PATTERN #	<i>5</i>
FREQUENCY	<i>F2</i>
POLARIZATION	
CHANNEL	
dB SCALE	<i>40 db</i>
PATTERN SPAN	<i>±45°</i>
REMARKS	<i>Azimuth Cut</i>

DATE *5/11/84* 105356
 ENGR *ABC, AJB, MAO*

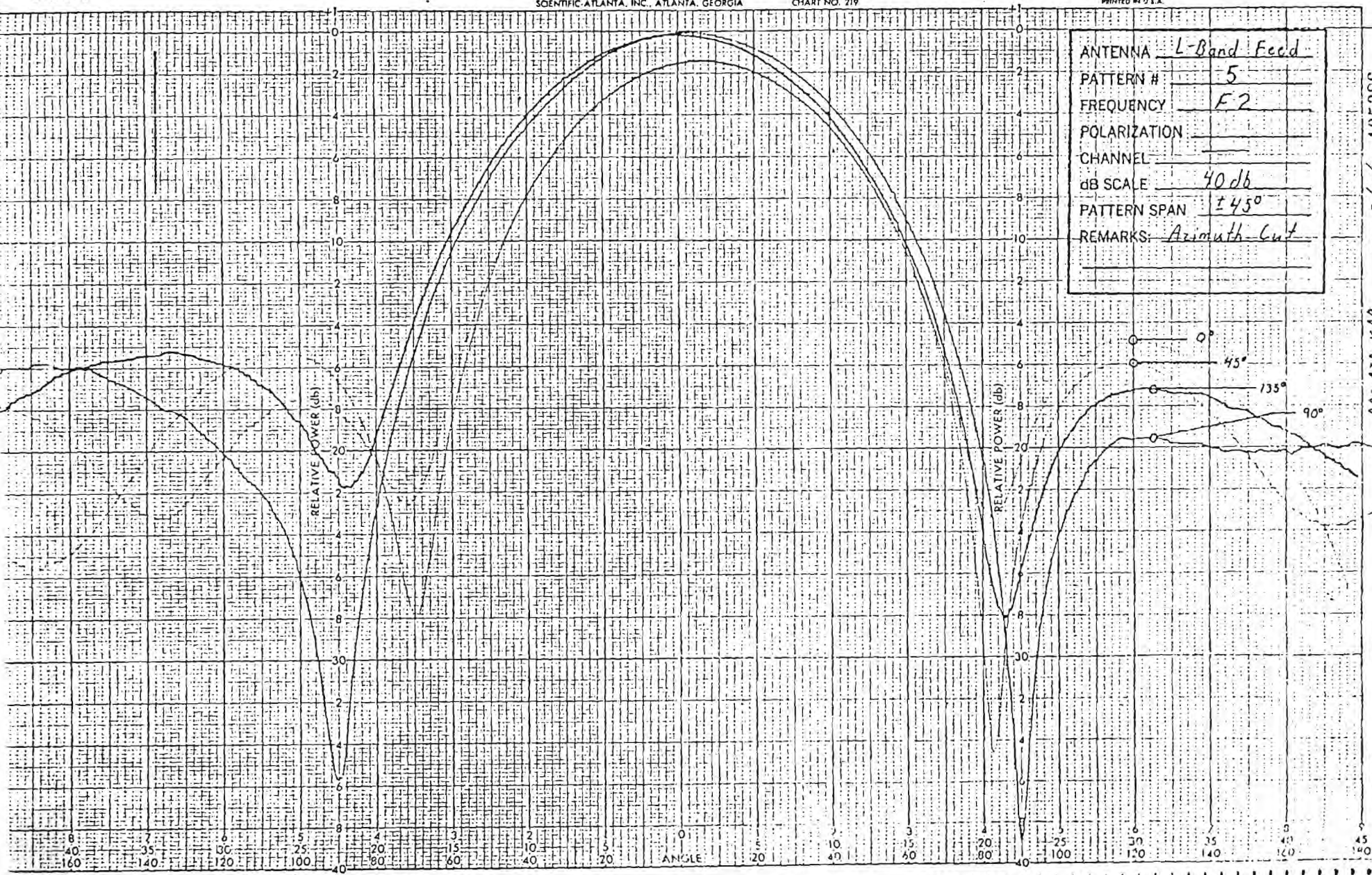

PROJECT
REMARKS

ANTENNA	<u>L-Band Feed</u>
PATTERN #	<u>6</u>
FREQUENCY	<u>F2</u>
POLARIZATION	<u> </u>
CHANNEL	<u> </u>
dB SCALE	<u>40dB</u>
PATTERN SPAN	<u>±45°</u>
REMARKS	<u>Elevation Cut</u>

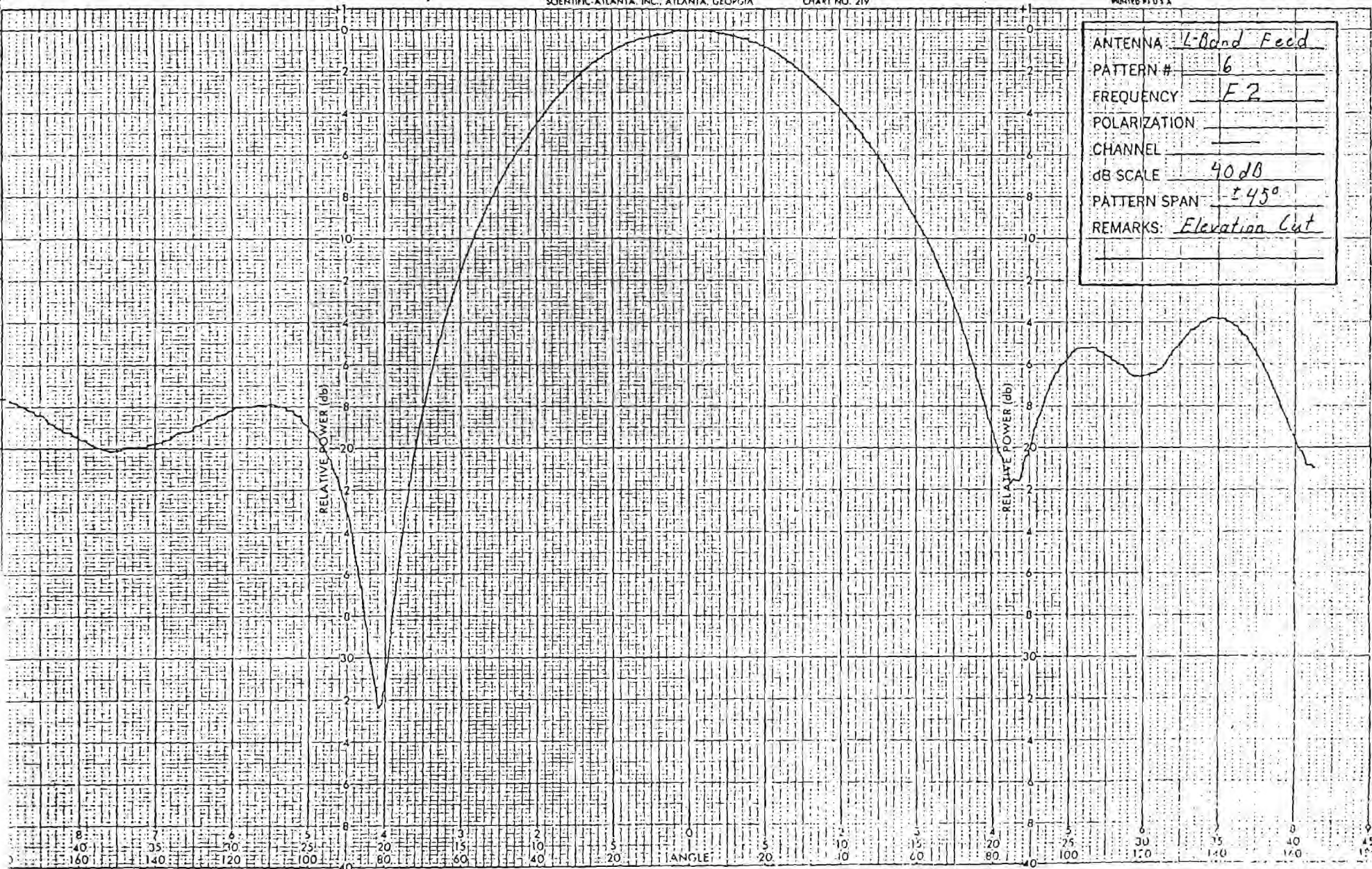

DATE 5/11/84 105395

ENGR/BC, ASO, KAO

PROJECT
REMARKS

ANTENNA L Band Feed
 PATTERN # 7
 FREQUENCY F. 3
 POLARIZATION _____
 CHANNEL _____
 dB SCALE 40 dB
 PATTERN SPAN ±180°
 REMARKS Azimuth Cut

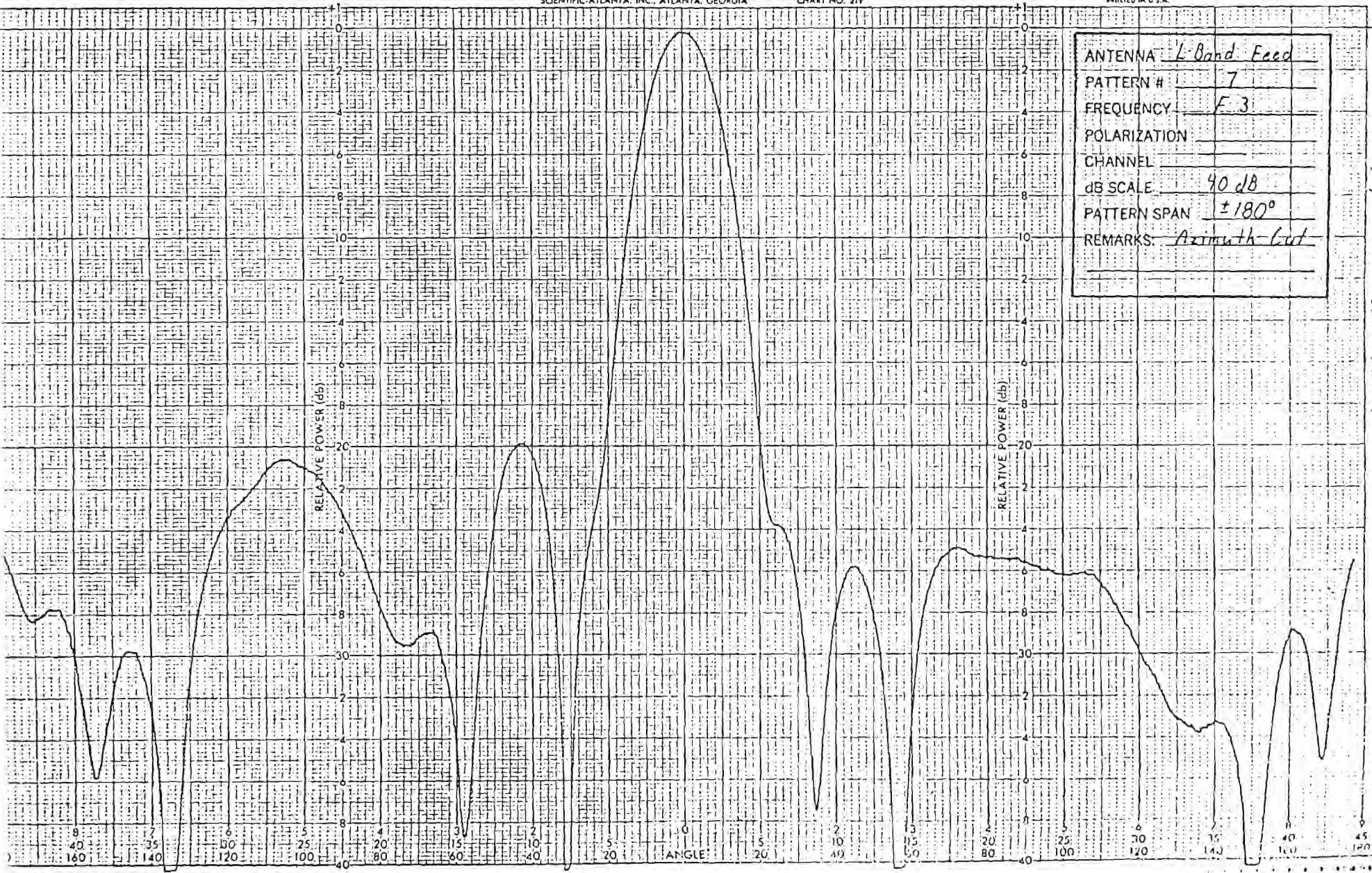

ENGR. ABC, R30, K10 DATE 5/11/84 105394

PROJECT REMAPS

ANTENNA L-Band Feed
 PATTERN # 8
 FREQUENCY F3
 POLARIZATION _____
 CHANNEL _____
 dB SCALE 40dB
 PATTERN SPAN ±45°
 REMARKS: Azimuth-Cut

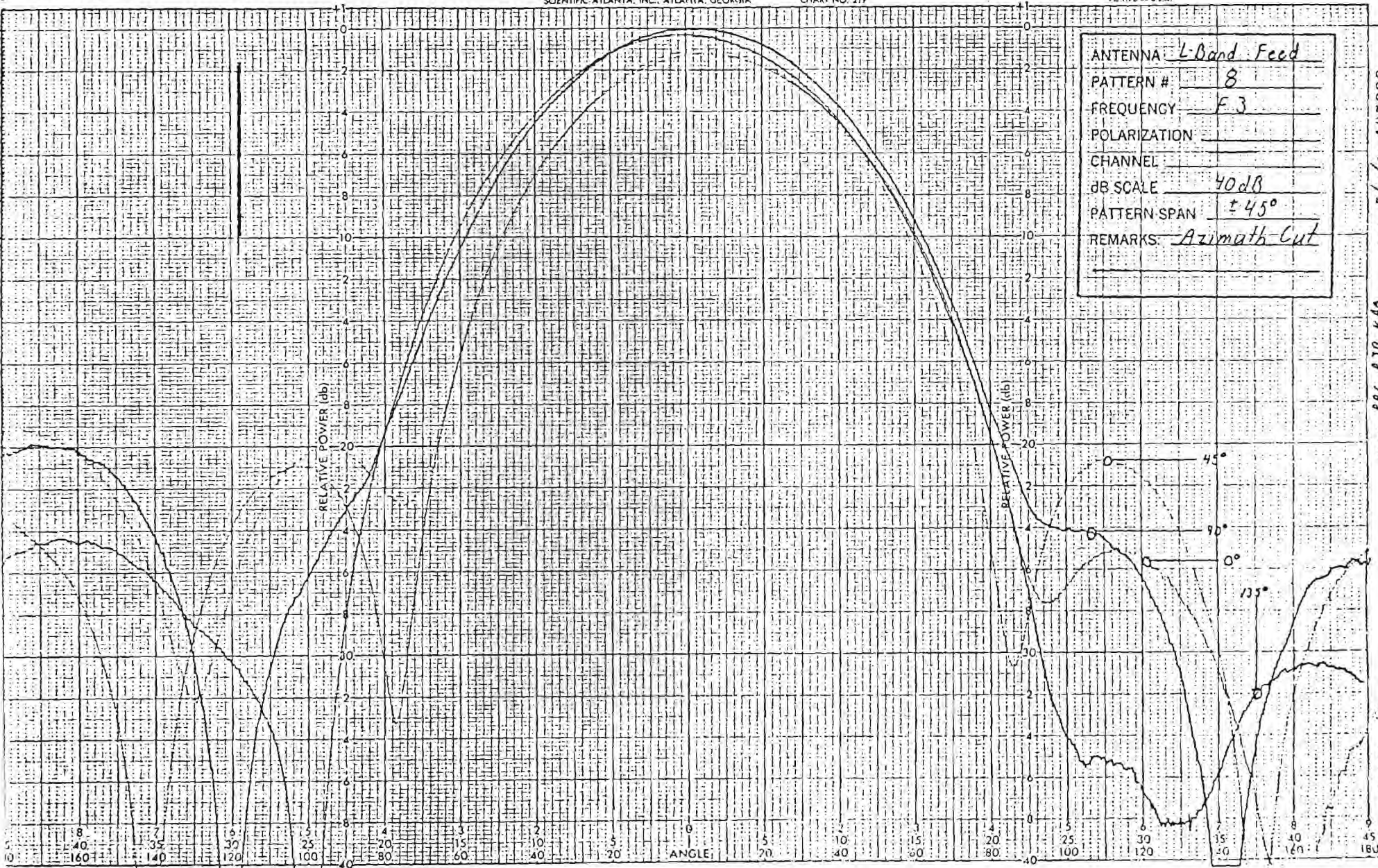

DATE 5/11/84 105390

ENGR. RBC, RJB, KAO

PROJECT REMARKS

ANTENNA	<i>L-Band Feed</i>
PATTERN #	<i>9</i>
FREQUENCY	<i>F 3</i>
POLARIZATION	
CHANNEL	
dB SCALE	<i>40 dB</i>
PATTERN SPAN	<i>±45°</i>
REMARKS	<i>Elevation Cut</i>

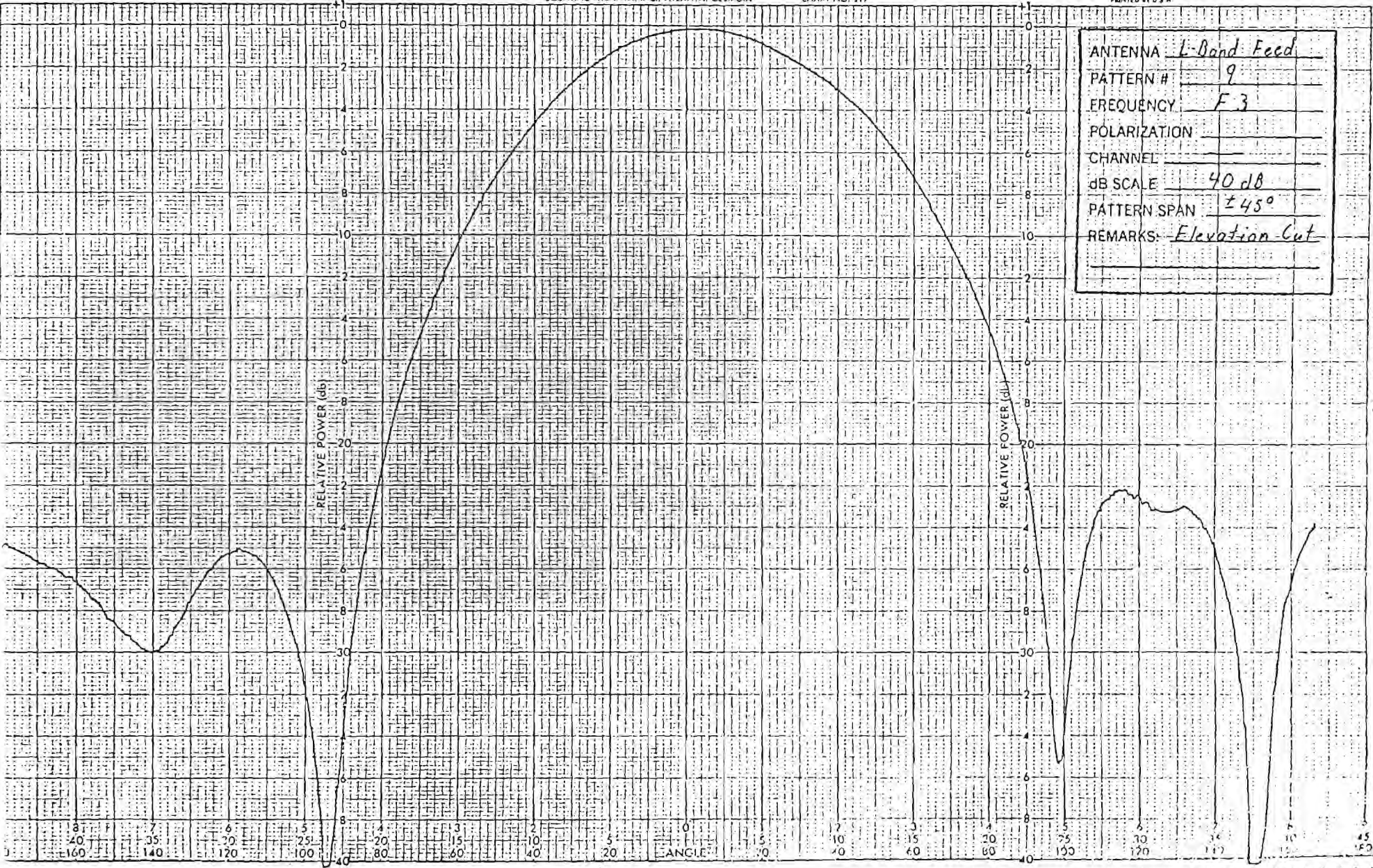

DATE 5/11/84 105395

ENGR ABC, RJB, MAD

PROJECT REMARKS

ANTENNA	<u>L-Band Feed</u>
PATTERN #	<u>10</u>
FREQUENCY	<u>F4</u>
POLARIZATION	<u> </u>
CHANNEL	<u> </u>
dB SCALE	<u>40dB</u>
PATTERN SPAN	<u>±180°</u>
REMARKS:	<u>Azimuth Cut</u>

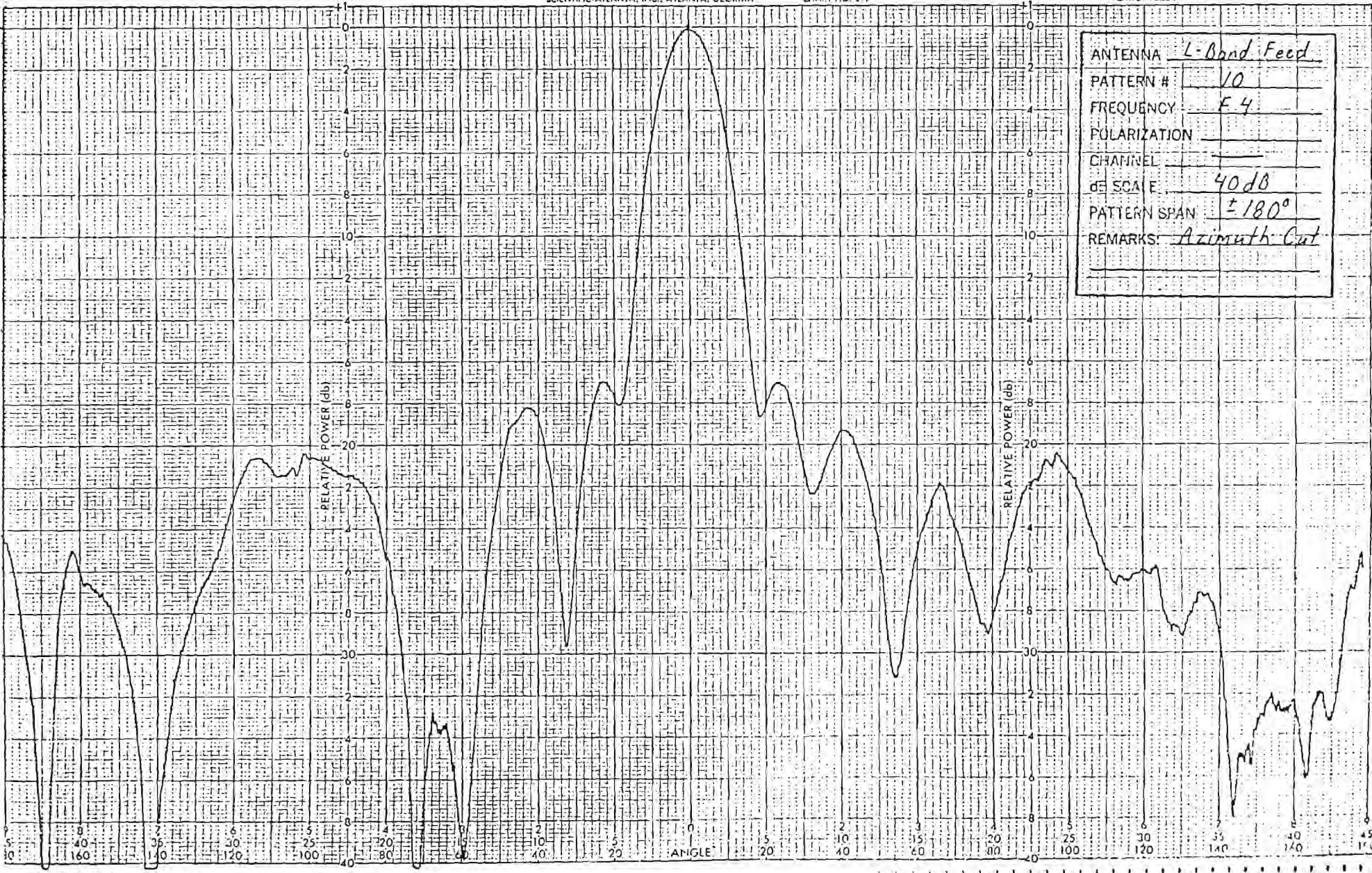

DATE 5/11/84 105392

ENGR RCG, RJD, MAO

PROJECT
REMARKS

ANTENNA	<i>L-Band Feed</i>
PATTERN #	<i>11</i>
FREQUENCY	<i>F.4</i>
POLARIZATION	_____
CHANNEL	_____
dB SCALE	<i>40 dB</i>
PATTERN SPAN	<i>± 45°</i>
REMARKS	<i>Azimuth Cut</i>

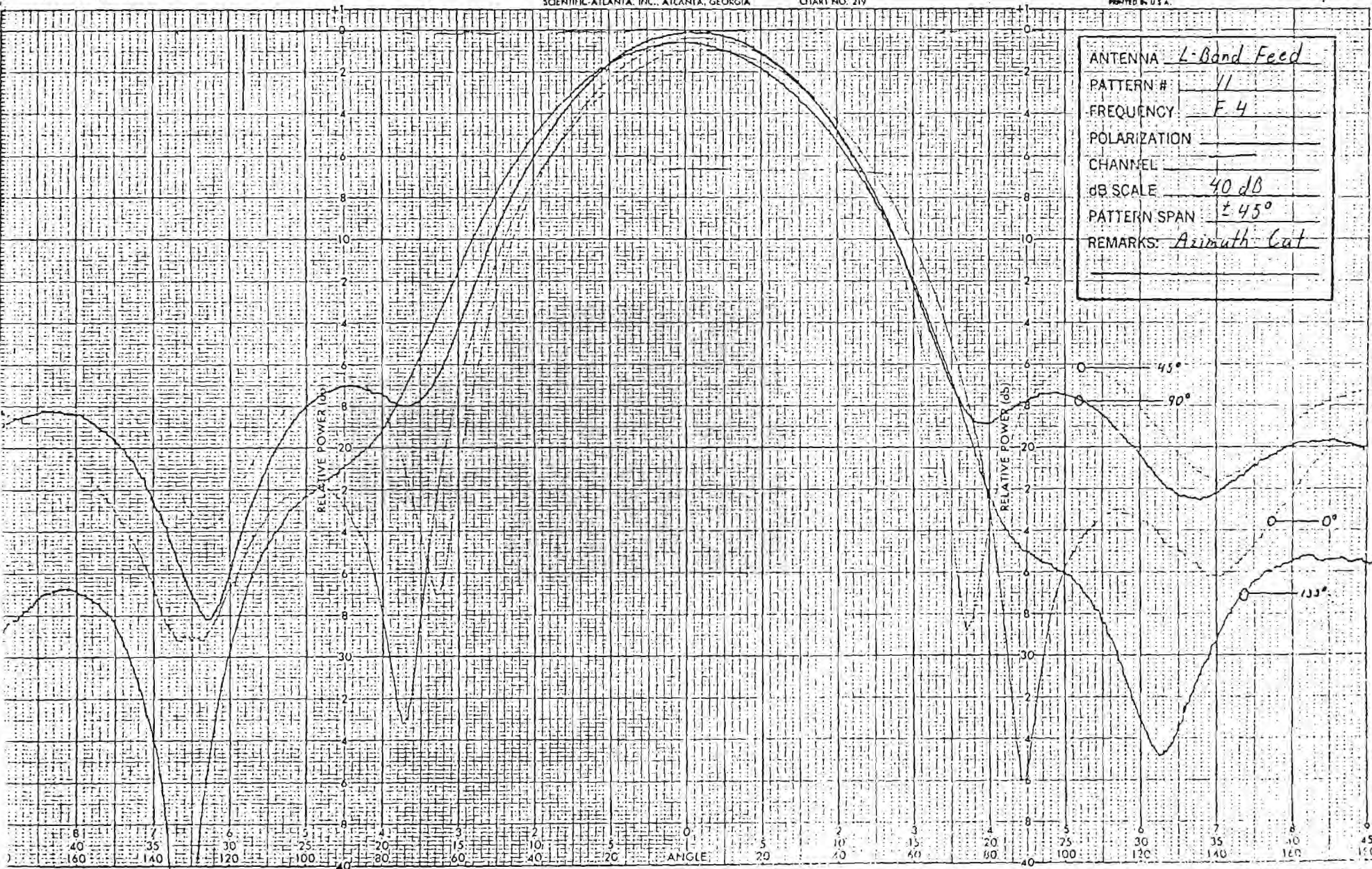

DATE 5/11/84 1053S9

ENGR 18C, RJB, MAO

PROJECT REMARKS

ANTENNA L-Band Feed
 PATTERN # 12
 FREQUENCY F4
 POLARIZATION _____
 CHANNEL _____
 dB SCALE 40 dB
 PATTERN SPAN ± 45°
 REMARKS: Elevation cut

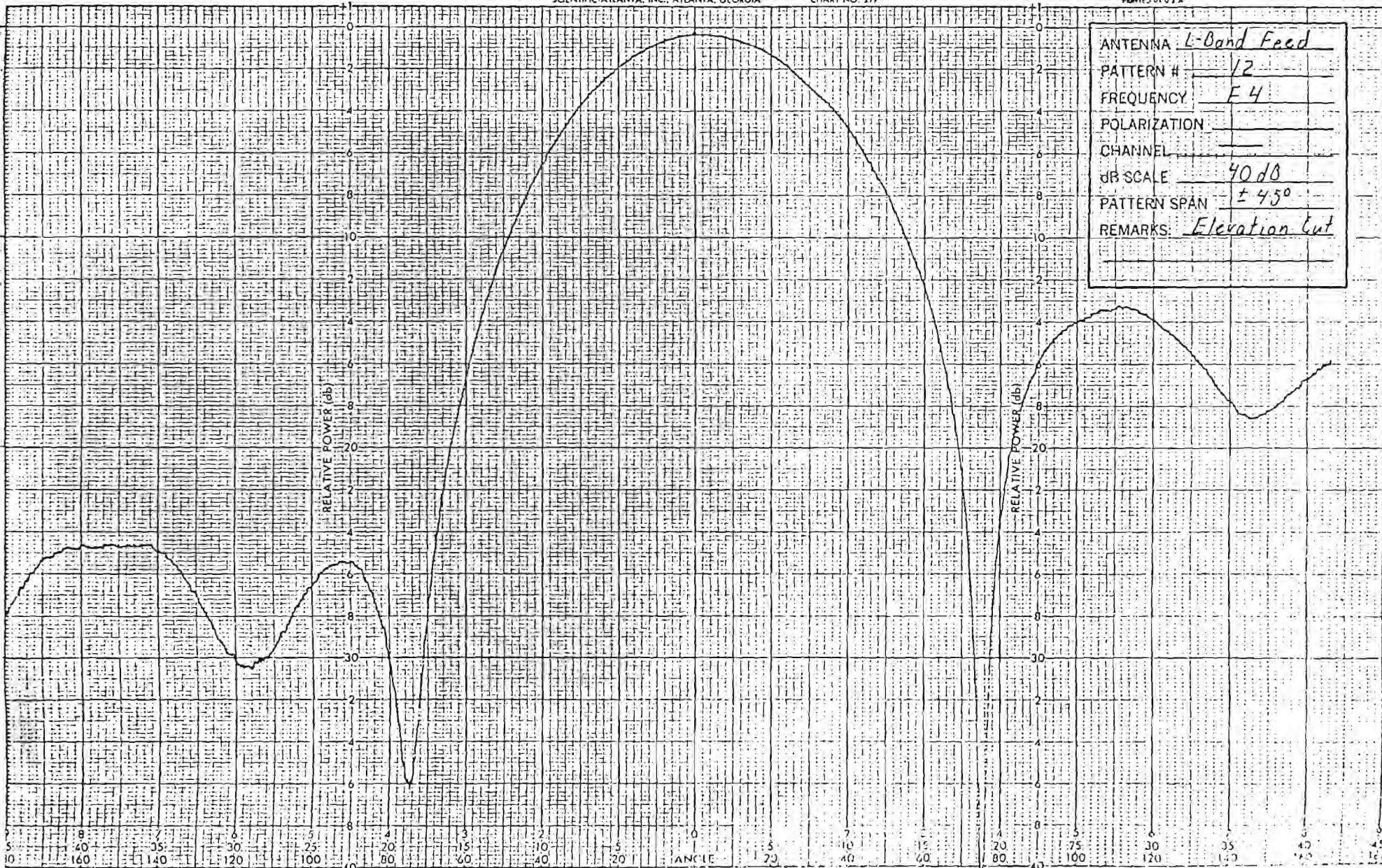

DATE 5/11/84 105393

ENGR R06, AJO, MAO

PROJECT REMARKS

L-BAND ANTENNA

MEASURED DATA

<u>Frequency</u>	<u>Average Gain</u>	<u>Axial Ratio</u>	<u>Sidelobe Level</u>	<u>Beamwidth</u>
F ₁	16.6 dB	1.4 dB	-14 dB	19°
F ₂	18.2 dB	1 dB	-15.4 dB	18°
F ₃	19.0 dB	0.8 dB	-20.0 dB	17.5°
F ₄	18.5 dB	0.8 dB	-17.0 dB	16.0°

ANTENNA GAIN VERSUS POLARIZATION ANGLE
FOR VARIOUS OPERATING FREQUENCIES

FREQ.	POLARIZATION			
	0° (V)	45°	90° (H)	135°
F ₁	16.6 dB	17.8 dB	18.0 dB	17.2 dB
F ₂	17.7 dB	17.7 dB	18.7 dB	18.7 dB
F ₃	18.6 dB	18.6 dB	19.6 dB	19.4 dB
F ₄	18.0 dB	18.6 dB	18.8 dB	18.4 dB

NOTE: 0° IS CONSIDERED AS VERTICAL OR PERPENDICULAR WITH RESPECT TO THE HORIZON, AND THE INCREASING POLARIZATION ANGLE IS ROTATING CLOCKWISE WHEN VIEWED FROM THE REAR OF THE ANTENNA.

5.0 RETURN LOSS MEASUREMENTS

The return loss measurements of the L-Band Antenna were performed using the equipment illustrated in Figure 5.1. This includes: HP-8755 Scalar Network Analyzer, 8750A Storage Normalizer, an HP-8350 Sweeper with a 83592A plug-in, X-Y Recorder, and a Wiltron bridge model number 60A50. The Storage Normalizer was used to normalize return loss errors due to the connectors. The sweeper was set to sweep between end limits of F_1 and F_4 . The results are as shown in Figure 5.2 .

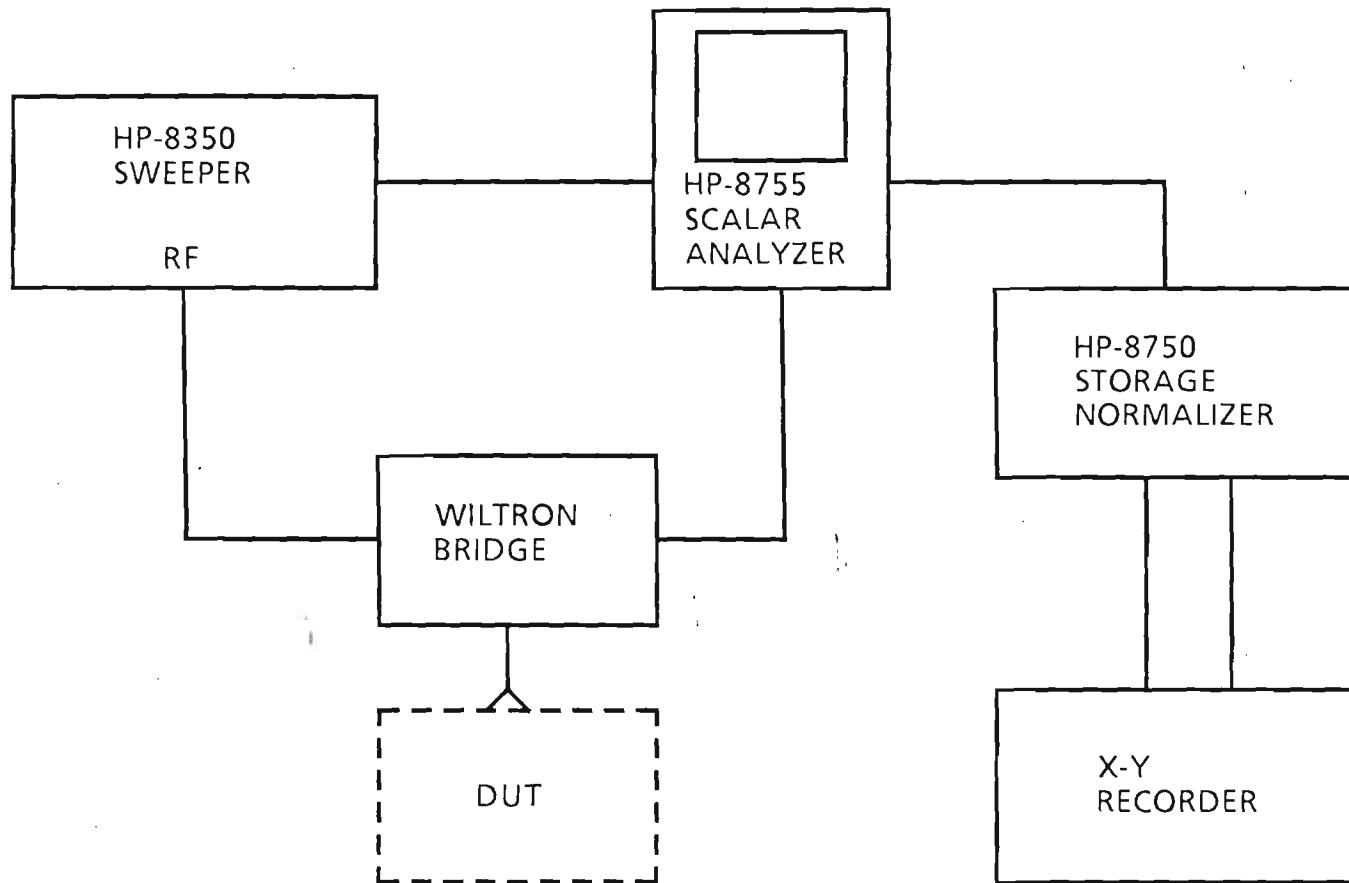

FIGURE 5.1 RETURN LOSS MEASUREMENT SET-UP

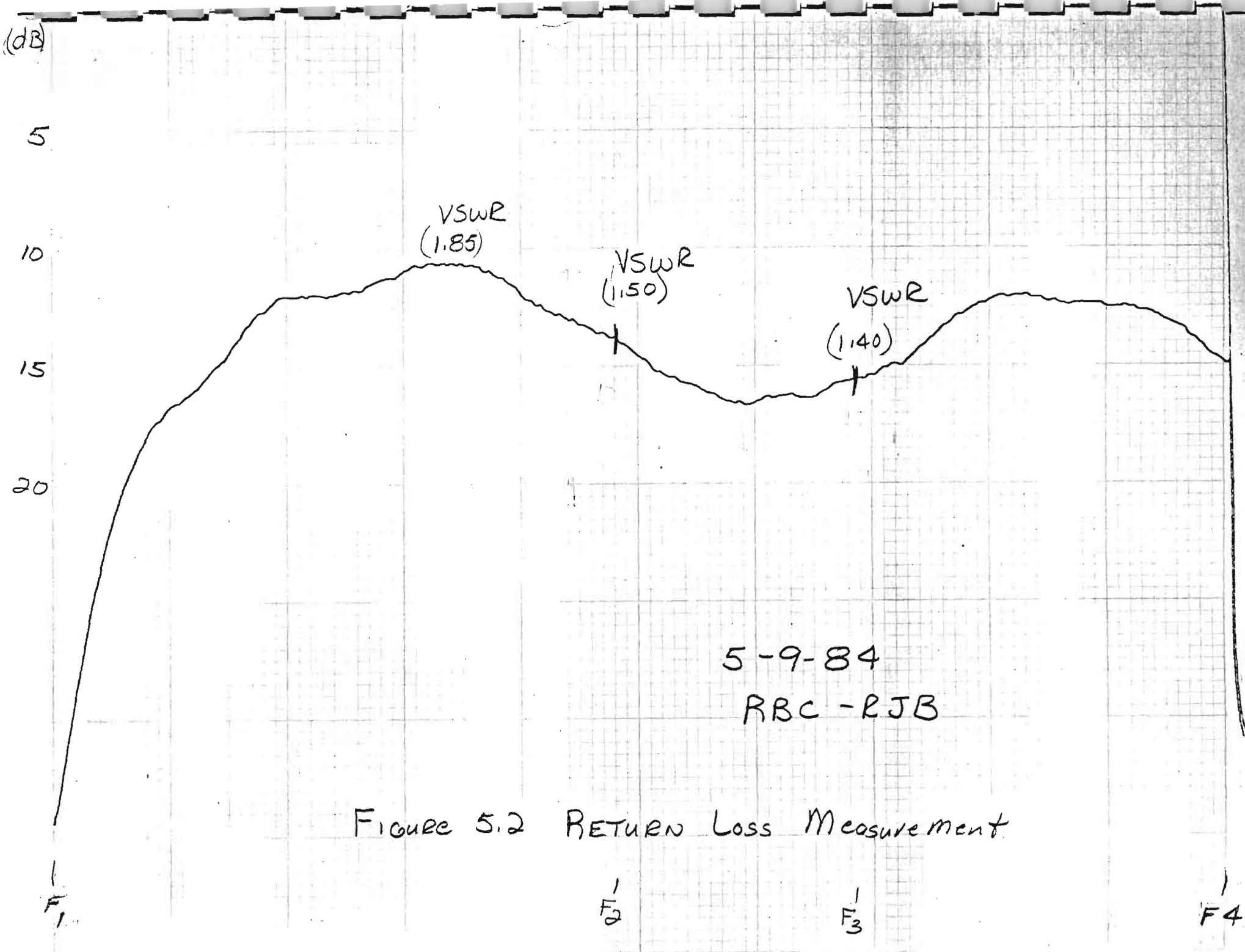

Figure 5.2 RETURN Loss Measurement

6.0 HIGH POWER TEST

The L-Band feed was high-power tested up to 200 kW peak power. It passed this test with no arching while tuning across the frequency band of the magnetron. Figure 6.1 illustrates the test set-up. A Raytheon coaxial magnetron was used to perform the test. The modulator used to drive the magnetron had a selected pulse width of 1.75 μ sec and a pulse repetition frequency of 550 HZ.

HIGH POWER TEST ASSEMBLY

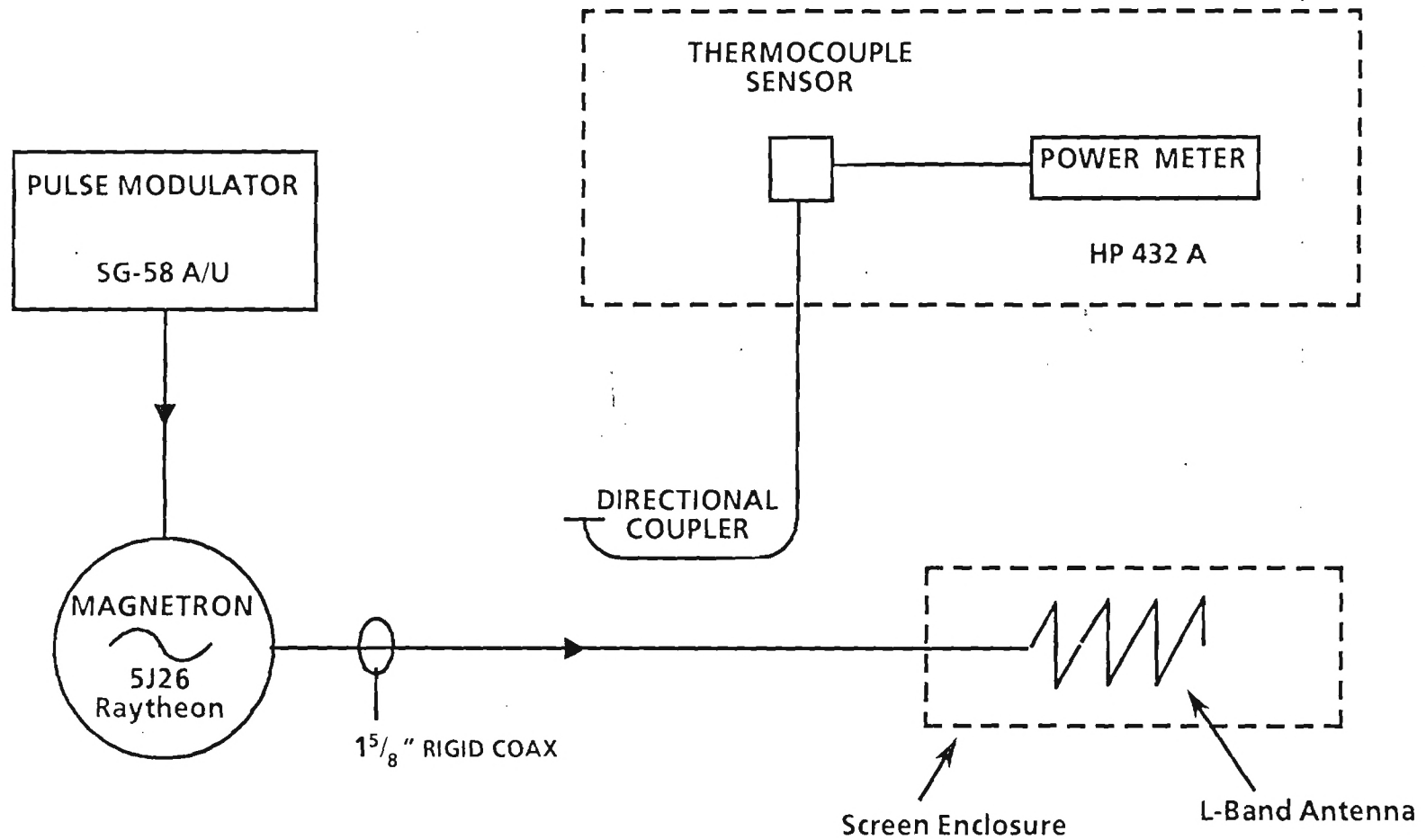

FIGURE 6.1