

Proceedings from 2021 Vehicle Dynamics seminar

version modified 2021-08-17 11:34

editors:

Fredrik Bruzelius fredrik.bruzelius@vti.se;

Lars Drugge larsd@kth.se;

Bengt Jacobson bengt.jacobson@chalmers.se

The contents of these proceedings include both **presentations and poster material** and are published at <https://research.chalmers.se/publication/524553>. It will also be available at <https://kth.diva-portal.org/> and <https://www.sveafordon.com/>.

The seminar was arranged by Vehicle Dynamics Competence Area and Swedish Vehicular Engineering Association (SVEA, <https://www.sveafordon.com/>).

The seminar was very appreciated and held remotely via “zoom”. There were 82 registered participants from around 10 organisations, 10 presentations, and 3 poster presentations from master thesis students from KTH and Chalmers.



Contents

Contents

Announcement of the Seminar

Registered participations

Presentation: Stability envelopes for autonomous drivetrain induced braking functions, Jolle Ijkema, Scania

Presentation: *Optimal design and control of high capacity transport*, Toheed Ghandriz, Volvo Technology & Chalmers

Presentation: *High Capacity Transport in Sweden*, Jesper Sandin, VTI

Presentation: *Remote driving operation*, Lin Zhao, KTH

Presentation: *Automated Comfortable Docking at Bus Stops*, Amal Elawad, Volvo Buses/Chalmers

Presentation: Alternative Input Devices for Steer-by-Wire Systems, Matthijs Klomp, VCC

Presentation: Front seat Passenger experience of ride comfort in passenger cars, Xiaojuan Wang, CEVT & Chalmers

Presentation: *Motion Sickness in Autonomous Vehicles*, Ilhan Yunus, VCC & KTH

Presentation: *New Mobility Engineering master programme*, Erik Hulthén and Giulio Bianchi Piccinini, Chalmers

Presentation: Vehicle Engineering master programme, Mikael Nybacka, KTH

Poster: *Improving Vehicle Dynamics Development Process by combining simulation and motion platform simulator*, Lidong Wang, Chalmers

Poster: *Propelled and steered converter dolly for more efficient shunting of semi-trailers on goods terminals*, Neel Kachhawah and Clive Rahul Misquith, Chalmers

Poster: *Evaluation of Active Rear Steering through Multi Body simulation*, Gabriele Bertoli and Matteo Rossi, KTH

Note that the pdf file is generated with these “headings as pdf bookmarks”, so you can also navigate via the “bookmark pane” in your pdf reader.

Announcement of the Seminar

Seminars

2021 Vehicle Dynamics for future mobility (2021-05-26 09:00)

Seminarie: 2021 Vehicle Dynamics for future mobility



Vehicle Dynamics for Future Mobility ...and not only Lateral

Wednesday May 26, 2021

Virtual seminar: Link to a zoom meeting will be sent out to participants registered with e-mail.

Purpose with the seminar

- Present and discuss interesting issues within and challenges for **Future Mobility**
- Develop and increase competence
- Create understanding and interest for vehicle dynamics
- Networking between Engineers and Organisations and Students

SVEAs objectives

- To make vehicular technology's voice heard in an increasingly more challenging debate among different vehicle types and transport modes both domestically and globally.
- To build a network for efficient distribution of technological information
- To attract the next generation of Swedish vehicular engineers

Agenda

[Times stated are in Swedish time]

09:00-09:15 Registration and coffee & Poster session

09:15-09:30 Intro:

- *Welcome from SVEA and Vehicle Dynamics Competence Area, Bengt Jacobson*

Moderator: Lars-Gustaf Hauptmann

09:30-11:30 Lecture session 1: Heavy vehicles

09:30-11:30 Lecture session 1. heavy vehicles

- *Stability envelopes for autonomous drivetrain induced braking functions*, Jolle Ijkema, Scania
- *Optimal design and control of high capacity transport*, Toheed Ghandriz, Volvo Technology & Chalmers
- *High Capacity Transport in Sweden*, Jesper Sandin, VTI
- *Remote driving operation*, Lin Zhao, KTH

11:30-13:00 Lunch & Poster session

- 11:30-11:35 Introduction of posters
- Lunch. Optional to stay in zoom for mingel at a "virtually common lunch"
- 12:00-13:00 Poster sessions in break-out rooms

13:00-14:00 Lecture session 2

- *Automated Comfortable Docking to Bus Stop*, Amal Elawad, Volvo Buses/Chalmers
- *Alternative Input Devices for Steer-by-Wire Systems*, Matthijs Klomp, VCC

14:00-14:30 Coffee & Poster session

14:30-15:30 Lecture session 3

- *Front seat Passenger experience of ride comfort in passenger cars*, Xiaojuan Wang, CEVT & Chalmers
- *Motion Sickness in Autonomous Vehicles*, Ilhan Yunus, VCC & KTH

15:30-16:15 Vehicle Engineering Education at Swedish Universities

- *New Mobility Engineering master programme*, Erik Hulthén and Giulio Bianchi Piccinini, Chalmers
- *Vehicle Engineering master programme*, Mikael Nybacka, KTH
- Discussion

16:15-16:30 Outro

- Wrap-up
- Link to material and participation list from today will be sent out
- Next seminar 2022

Poster exhibition

There will be an exhibition of posters. It can be, e.g., master thesis or PhD thesis projects, both concluded and almost concluded such. Please contact Lars Drugge <larsd@kth.se>; or Bengt Jacobson <bengt.jacobson@chalmers.se> if you would like to propose a poster.

Present list of posters:

- *Improving Vehicle Dynamics Development Process by combining simulation and motion platform simulator*, Lidong Wang, Chalmers
- *Propelled and steered converter dolly for more efficient shunting of semi-trailers on goods terminals*, Neel Kachhawah and Clive Rahul Misquith, Chalmers
- *Evaluation of Active Rear Steering through Multi Body simulation*, Gabriele Bertoli and Matteo Rossi, KTH

Proceedings

There will be proceedings from the seminar this year. This means that the presenters, including poster presenters, are welcome with a paper, or at least a public version of their presentation material. The proceedings will be available as a Chalmers and/or KTH report on the web.

Registration

Remote participation: Free if registration via www.sveafordon.com. List of registered will be sent out to all after seminar.

We want registration latest Monday 2021-05-24, 23:59, to send out link in time.

Member fee in SVEA is 200 SEK/year (free for "junior 26-", 100 SEK for "senior 65+").

Membership application through: <http://www.sveafordon.com/bli-medlem/vill-du-bli-medlem/medlemsansokan>

Questions via e-mail to: info@sveafordon.com

representatives from:

- AstaZero
- CEVT
- Chalmers
- KTH
- VTI
- NEVS
- AFRY Automotive
- Scania
- Volvo Cars
- Volvo GTT



VDCA Swedish Vehicle Dynamics Competence Area

Plats	Virtual on zoom meeting
Pris (medlem)	0 kr
Pris (junior/senior)	1 kr
Pris (ej medlem)	0 kr
Start	2021-05-26 09:00
Slut	2021-05-26 16:30

Anmälan

	<input type="text" value="För- och Efternamn"/>
	<input type="text" value="Postadress"/>
	<input type="text" value="Postnummer"/>
	<input type="text" value="Stad"/>
	<input type="text" value="Land"/>
	<input type="text" value="Telefonnummer"/>
	<input type="text" value="bengt.jacobson@chalmers.se"/>

Jag vill bli medlem

Anmäl dig till seminarie

c/o L-G Hauptmann
Färåsvägen 14
428 37 KÅLLERED

Tel 031-169985
info@sveafordon.com

Registered participations

82 registered

Name	Affiliation	e-mail
Adam Brandt	CEVT, Chalmers	john.adam.brandt@gmail.com
Ajit Kumar Madhava Prakash	Chalmers	ajitkumarm@outlook.com
Amal Elwad	Chalmers, Volvo Buses	elawad@chalmers.se; amal.elawad@chalmers.se
Anders Ahlström	Scania	anders.ahlstrom@scania.com
Anders Andersson	VTI	anders.andersson@vti.se
Andreas Andersson	Volvo Cars	andreas.eo.andersson@volvocars.com
Anton Albinsson	Volvo Cars	antonalbinsson@hotmail.com
Aparnasri Sekar	Volvo Cars	aparnasri.sekar@volvocars.com
Bengt J H Jacobson	Chalmers	bengt.jacobson@chalmers.se
Britta Berg	Volvo Cars	britta.berg@volvocars.com
Bruno Augusto	VTI	bruno.augusto@vti.se
Clive Rahul Misquith	Chalmers	misquith@student.chalmers.se
Daniel Korhonen	Scania	daniel.korhonen@scania.com
David Berggren	Dept CE42250, TCB11	david.berggren@volvo.com
Dinesh Ramachandran	KTH	dineshr@kth.se
Dragan Sekulic	Chalmers	dragan.sekulic@chalmers.se
Egbert Bakker	Volvo Cars	egbert.bakker@volvocars.com
Emil Lundgren	Scania	emil_x.lundgren@scania.com
Erik Hulthén	Chalmers	erik.hulthen@chalmers.se
filip andersson	Scania	filip.andersson@scania.com
Fredrik Bruzelius	VTI, Chalmers	fredrik.bruzelius@vti.se
Gabriele Bertoli	KTH	gbertoli@kth.se
Georgios Papaioannou	KTH	papaioa@kth.se
Giulio Bianchi Piccinini	Chalmers	giulio.piccinini@chalmers.se
Goran Vasilevski	Volvo Cars	goran.vasilevski@volvocars.com
Gustavo Martioli	Scania	gustavo.martioli@scania.com
Henrik Selmemo	Hexagon	henrik.selmemo@hexagon.com
Ilhan Yunus	Volvo Cars, KTH	ilhan.yunus@volvocars.com
Ingemar Johansson	Chalmers, SVEA	ingemarj55@gmail.com
Jesper Sandin	VTI	jesper.sandin@vti.se
Joakim Eriksson	Scania	joakim.y.eriksson@scania.com
Joakim Jonsson	Volvo Buses	joakim.jonsson.2@consultant.volvo.com
Joel Bergstedt	Scania	joel.bergstedt@scania.com
Jolle Ijkema	Scania	jolle.ijkema@scania.com

Jonas Hagsjö	Scania	jonas.hagsjo@scania.com
Jonas Qadoumi	Scania	jonas.qadoumi@scania.com
Jonny Genzel	VTI	jonny.genzel@vti.se
Juliette Torinsson	Volvo Cars, Chalmers	juliette.torinsson@volvocars.com
Koudilyan Srinivasan	Volvo Cars	koudilyan.srinivasan@volvocars.com
Lars Drugge	KTH	larsd@kth.se
Lars-Gustaf Hauptmann	SVEA	lgh.fordonsutv@gmail.com; lg@hauptmann.se
Laszlo Kupi	Scania	laszlo.kupi@scania.com
Leo Laine	Volvo Group Trucks Technology, O2	leo.laine@volvo.com
Leon Henderson	Volvo Trucks	leon.henderson@volvo.com
Lidong Wang	Chalmers	lidongw@student.chalmers.se
Lin Zhao	KTH	linzhao@kth.se
Lisa Ydrefors	VTI, KTH	lisa.ydrefors@vti.se
Luigi Romano	Chalmers	luigi.romano@chalmers.se
Maliheh Sadeghi Kati	Chalmers	maliheh.sadeghi.kati@chalmers.se
Malte Rothhämel	Scania	m.rothhaemel@posteo.de
Manikanta Venkatesh	Chalmers	manven@student.chalmers.se
Markus Agebro	Scania	markus.agebro@scania.com
Martin Bergqvist	Scania	martin.bergqvist@scania.com
Martin Distner	Volvo Cars	martin.distner@volvocars.com
Mats Jonasson	Chalmers	mats.jonasson@chalmers.se
Matteo Rossi	KTH	mrossi@kth.se
Matthijs Klomp	Volvo Cars, Chalmers	matthijs.klomp@volvocars.com
Melina Makris	Chalmers	melina.makris@chalmers.se
Mikael Karlgren	Scania	mikael.karlgren@scania.com
Mikael Nybacka	KTH	mnybacka@kth.se
Neel Kachhawah	Chalmers	neelk@student.chalmers.se
Niklas Fröjd	Volvo Trucks	frojd.niklas@volvo.com
Niklas Nilsson	Scania	niklas.y.nilsson@scania.com
Nikolce Murgovski	Chalmers	nikolce.murgovski@chalmers.se
Pramod Sivaramakrishnan	Chalmers	prasiv@student.chalmers.se
Rolf Johansson	Astus	rolf@astus.se
Sachin Janardhanan	Volvo Trucks	sachin.janardhanan@chalmer.se
Shashwat Joshi	Scania	shashwat.joshi@scania.com
Shilan Parsaeian	Volvo Cars	s.parsaeian@gmail.com
Shiva Kumar	Scania	shiva.kumar.p@scania.com
Shon K.L	Scania	shon.lonappan@scania.com
Sogol Kharrazi	VTI	sogol.kharrazi@vti.se

Stefan Kojchev	Chalmers	kojchev@chalmers.se
suresh kumar pandian	Volvo Trucks	suresh.pandian@volvo.com
Tejaswini Priyanka Ravi Kumar	Volvo Cars	travikum@volvocars.com
Thomas Leckström	AFRY	thomas.leckstrom@afry.com
Toheed Ghandriz	Volvo Technology, Chalmers	toheed.ghandriz@chalmers.se
Vijay Singh	Scania	vijay.vikram.singh@scania.com
Wenliang Zhang	KTH	zhang.wenliang@outlook.com
Xiaojuan Wang	CEVT, Chalmers	xiaojuan.wang1@cevt.se; jannywangxiaojuan@gmail.com
Xin Li	Volvo Cars	xin.li.11@volvocars.com
yansong huang	Volvo Cars, Chalmers	hys740089785@outlook.com

**Presentation: Stability envelopes for
autonomous drivetrain induced braking
functions, Jolle Ijkema, Scania**

JOLLE IJKEMA

STABILITY ENVELOPES FOR AUTONOMOUS DRIVETRA INDUCED BRAKING FUNCT

Who's speaking?

- Jolle IJkema
- TU Delft
- Technical Manager Handling & Steering
- Scania since 1995
- Vehicle Dynamics in many aspects



Today's topic



12 May 2021

Info class public RTCD / Jolle IJkema / Stability envelopes

Autonomous drivetrain induced brake functions

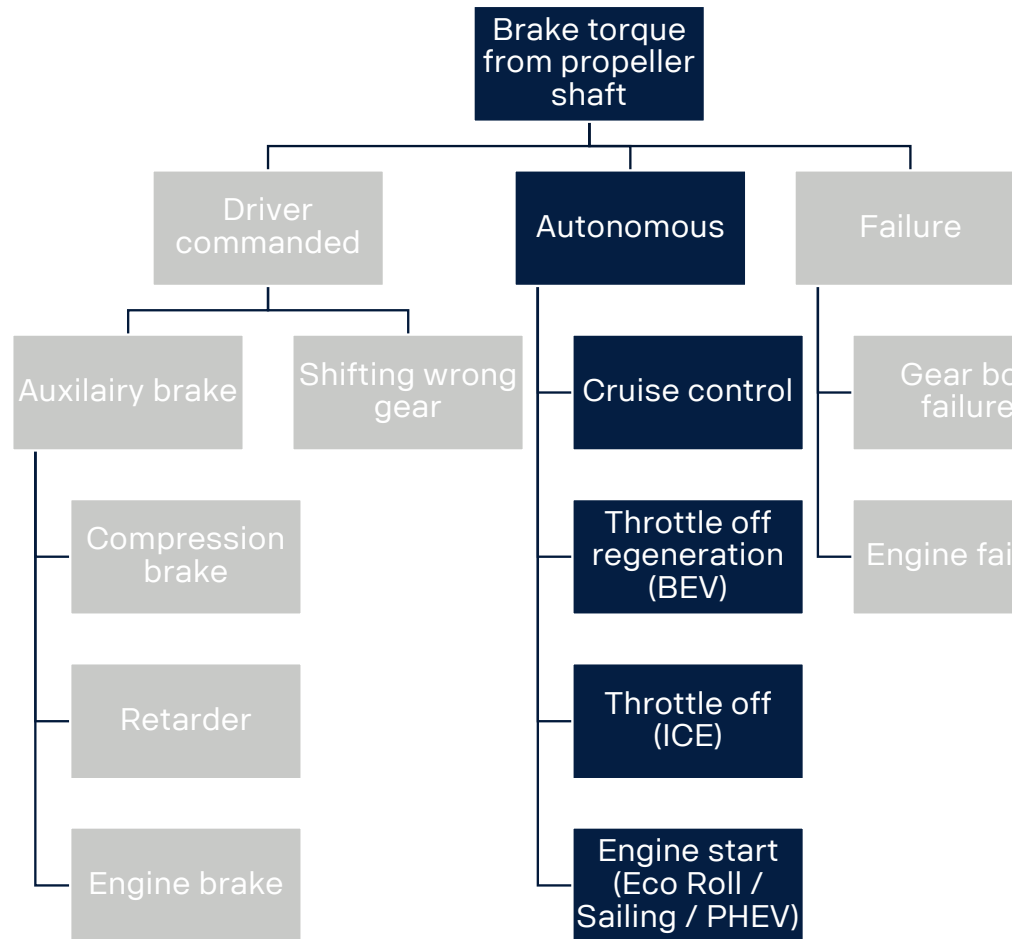

Maximizing battery range

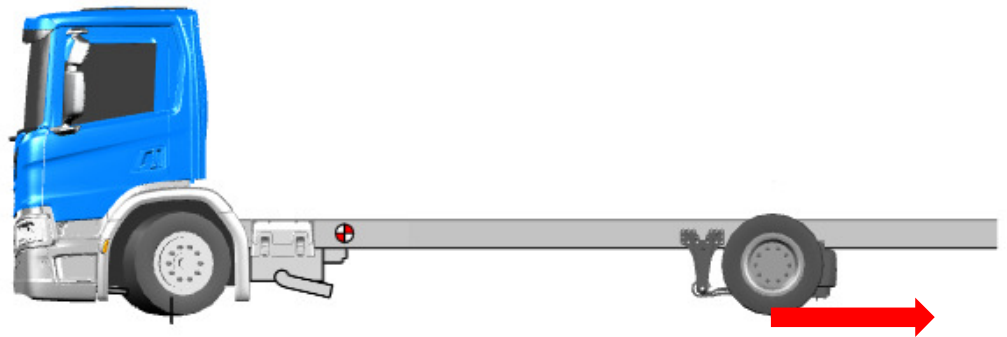

How much energy can we

When it sometimes is slippery?

When the vehicle sometimes is empty

When we're not going straight ahead

Friction ellipse

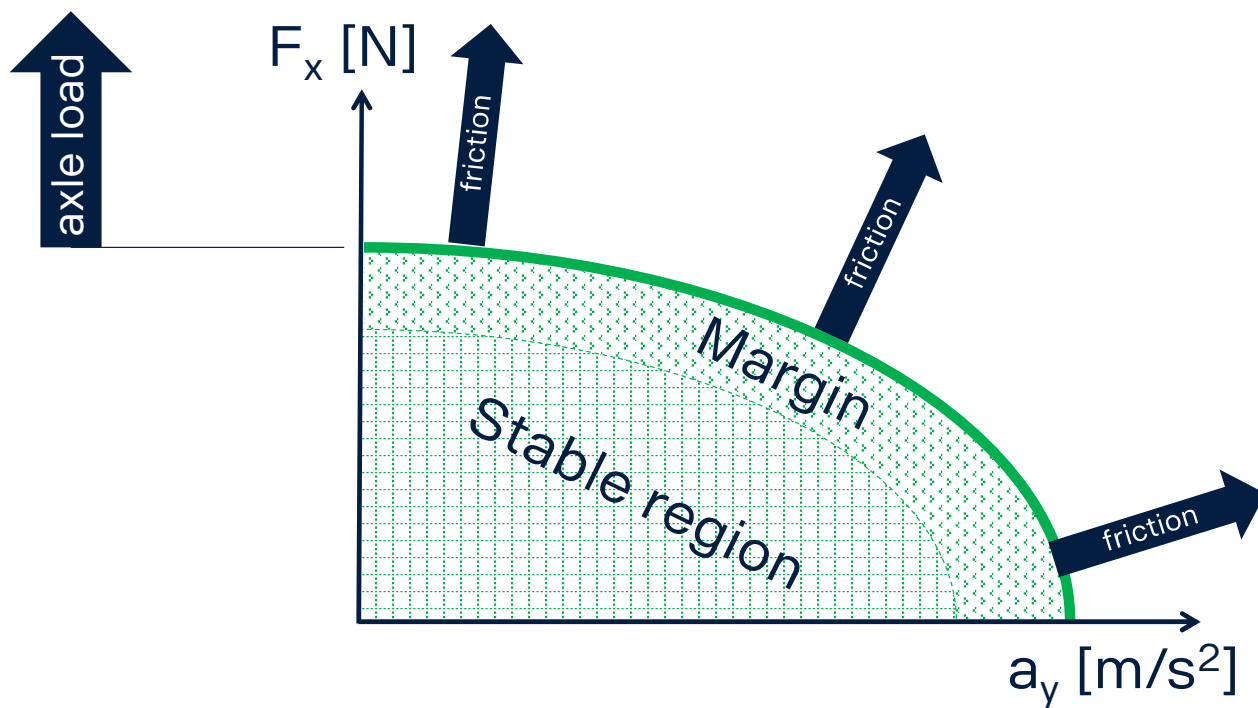

Test principle

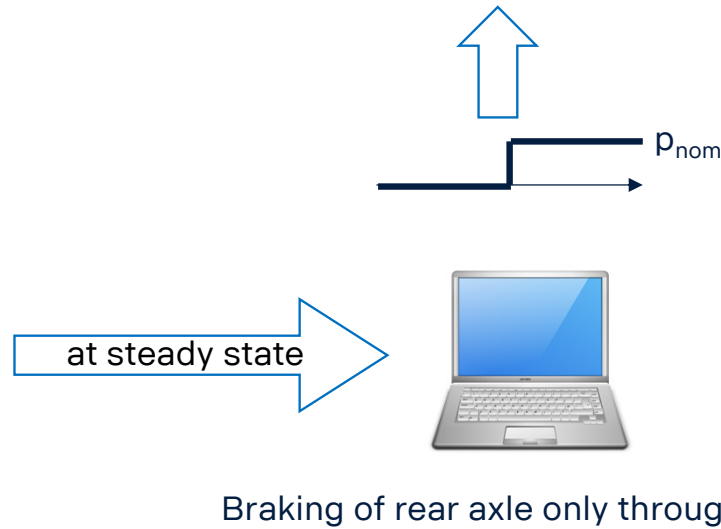
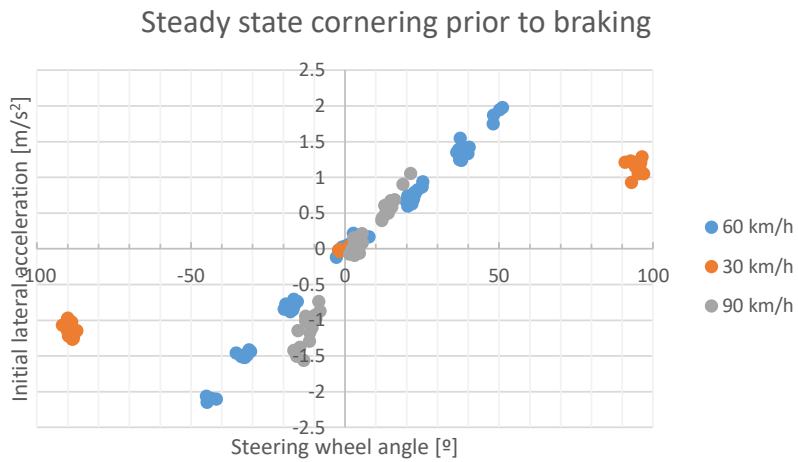

Proof of concept

Rear axle braking with ABS $F_{z, \text{rear}} = 53$

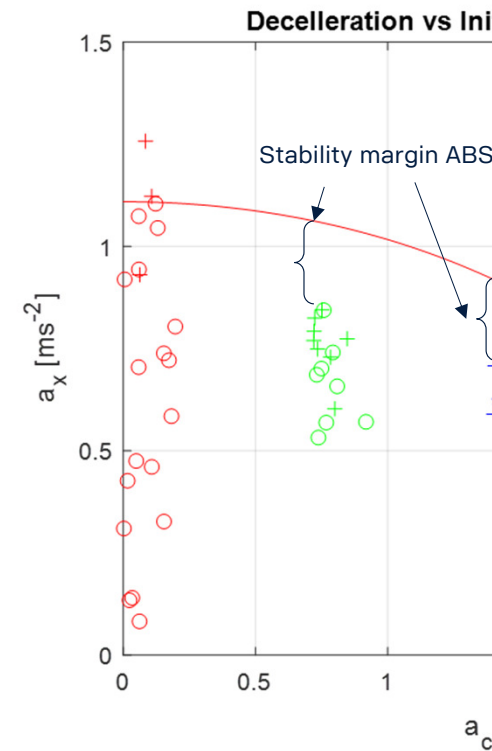
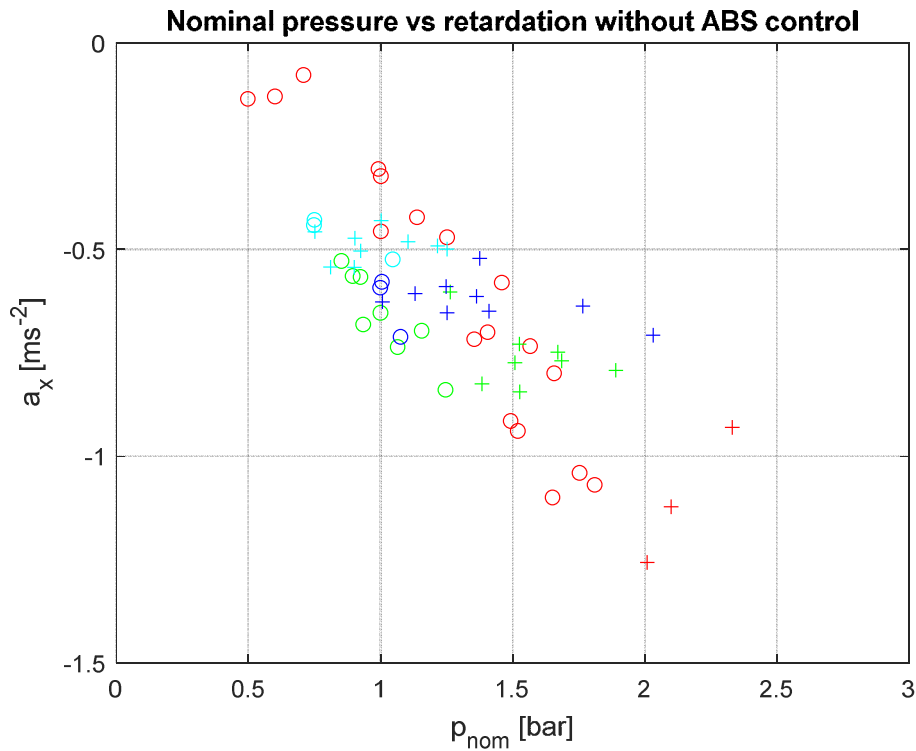

Proof of concept

Retarder braking, $F_{z,\text{rear}} = 53 \text{ kN}$

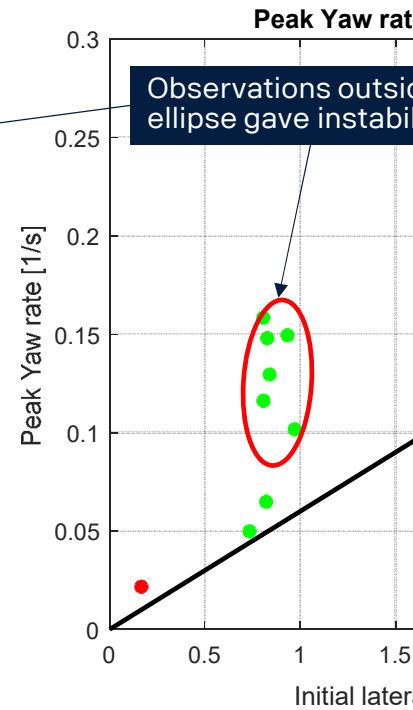
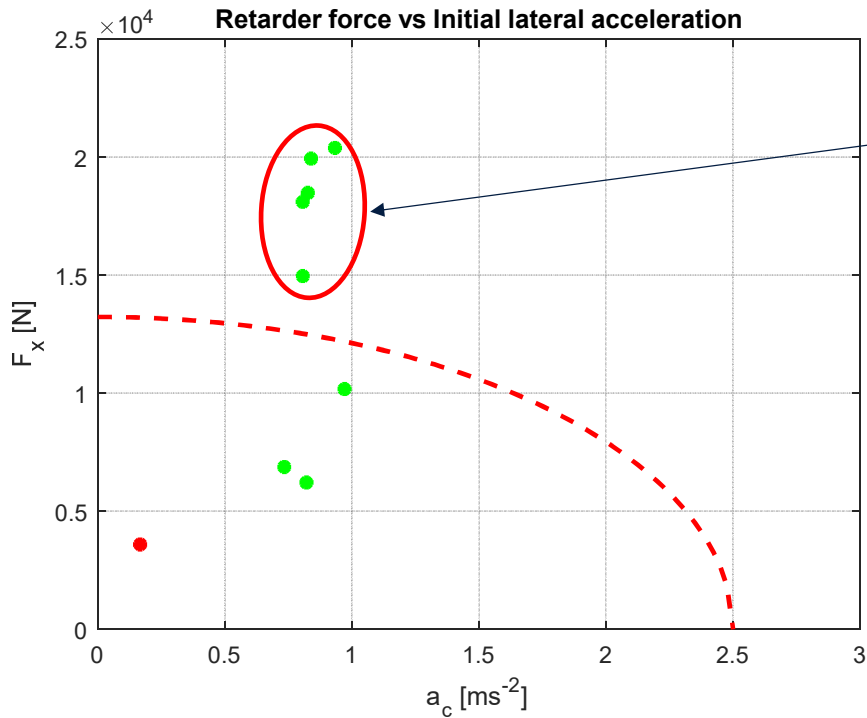

Stability envelope

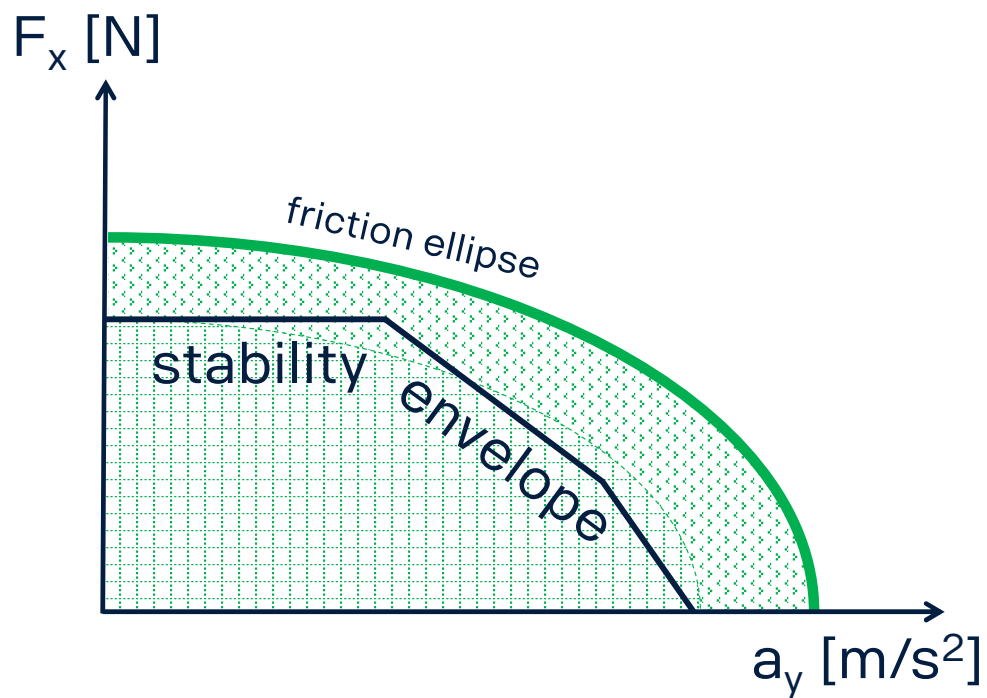

How to implement the stability envelope?

Flow chart: maximum force on driv

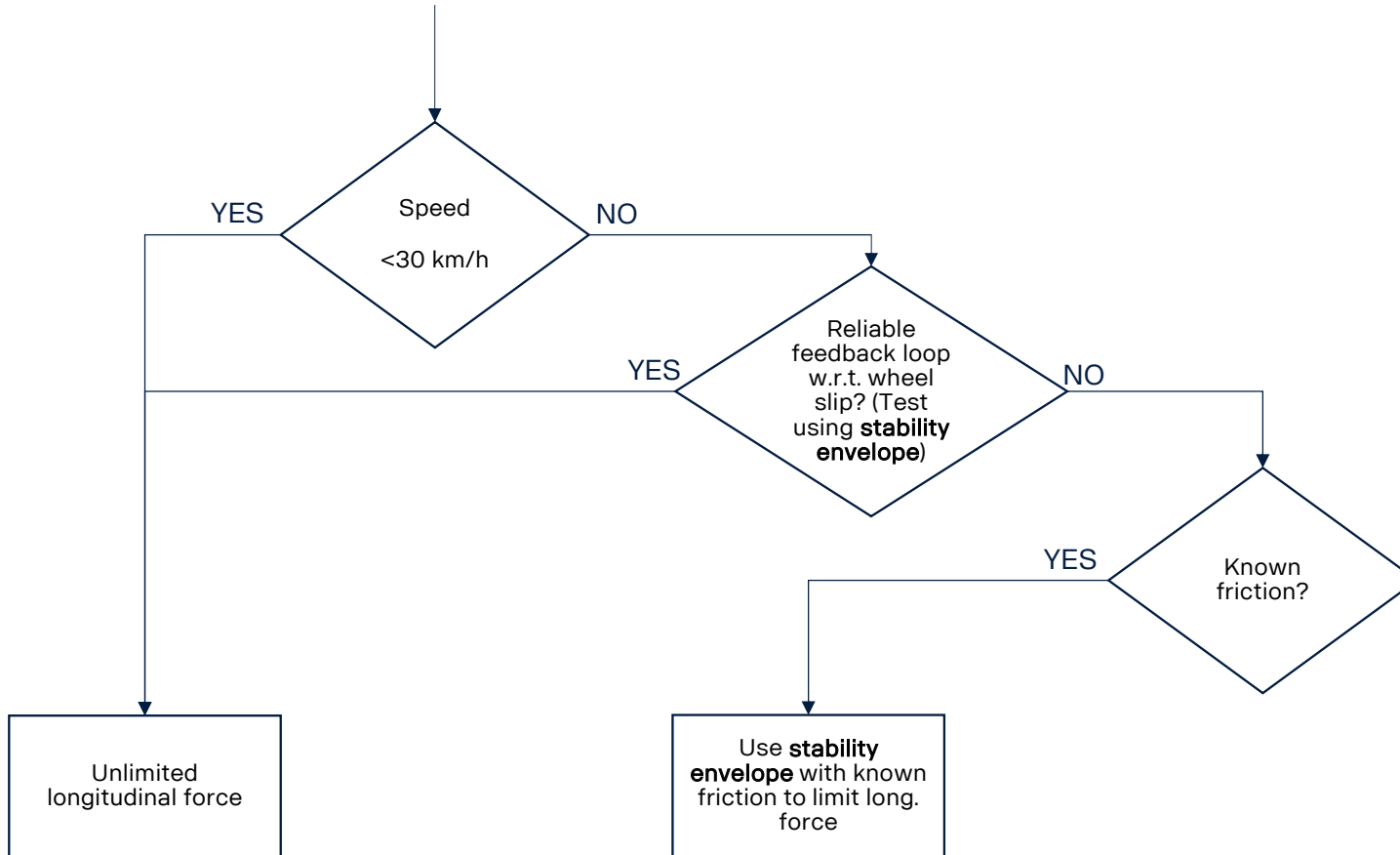

Scania BEV



SPECIFICATION

WHEEL CONFIGURATION

4x2, 6x2, 6x2*4

AXLE DISTANCE

3950 – 5750 mm

CAB OPTIONS

P, L

PROPULSION

Permanent magnet electric machine with oil spray cooling.

~295 kW 2,200 Nm (peak)

~230 kW 1,300 Nm (continuous)

60 kW electric Power Take-off

BA

9 Lithiu
distan
300 kW

5 Lithiu
distan
165 kW

CHARG
CCS ty
DC cha

GTW
Max 29

Use case example



BEV
4x2
swa
5-p
tyre
315



Use case example

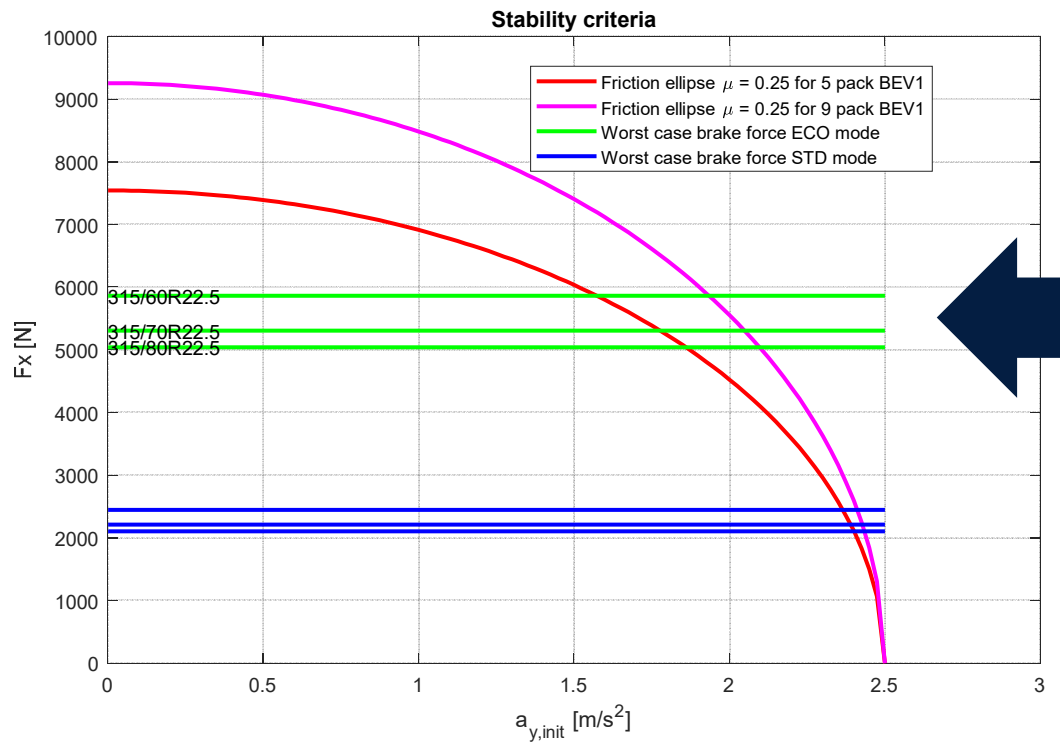

Summary

- **Keep it simple**
 - stick to physics: friction ellipse
 - not everyone understands vehicle dynamics
 - wheel slip control is tricky
- **Concept of stability envelope**
 - useful for product verification
 - HARA controllability criteria
 - future implementation
- **Need for Friction estimation (the holy grail)**
 - can bring more performance to our products

**Presentation: *Optimal design and control of high capacity transport*, Toheed Ghandriz,
Volvo Technology & Chalmers**

Optimal design and control of high-capacity road transport

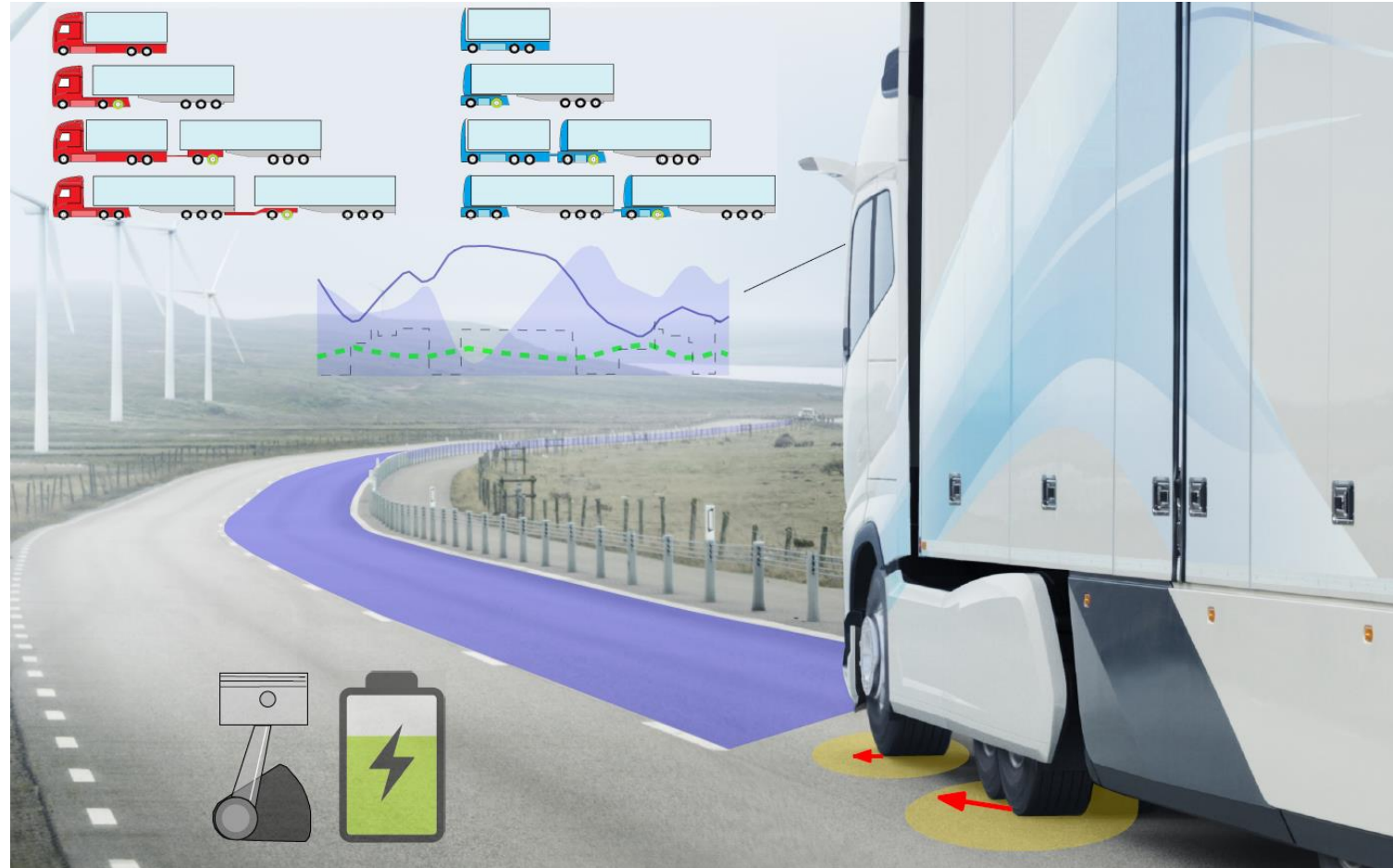

Toheed Ghandriz

Volvo Group Trucks Technology

Main questions:

- How can the road freight transportation efficiency and productivity be increased by electrification and automation?
- How can the longitudinal and lateral motion be controlled in an optimal manner, considering the minimum energy usage and safety?



▪ Fleet total cost of ownership (TCO)

The yearly operational cost:

- diesel fuel
- electric energy
- driver
- vehicle maintenance
- taxes and insurance
- discount rate (or interest)
- transportation mission management system (TMMS)

TCO also includes the economic lifetime, rest (or resale) value, and the battery rest value considering battery health.

The depreciation of purchase price:

- vehicle chassis and powertrain components
- infrastructure

Integrated vehicle-infrastructure design

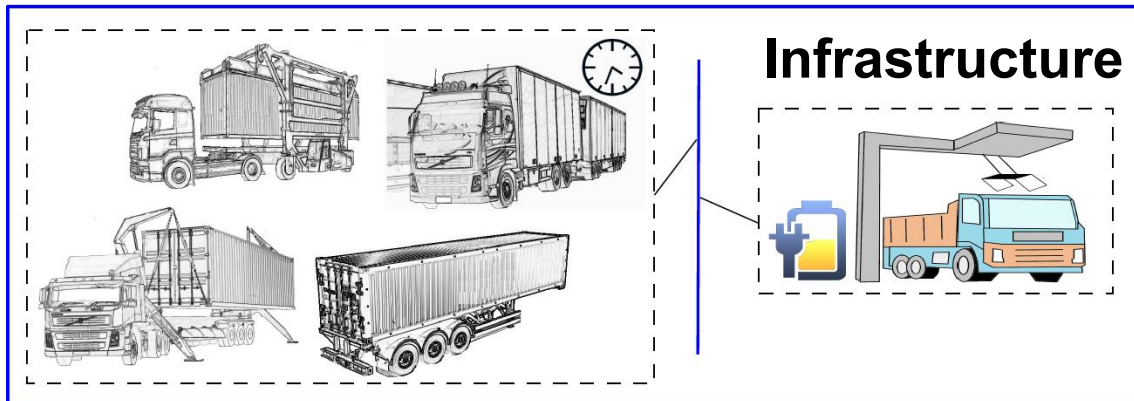
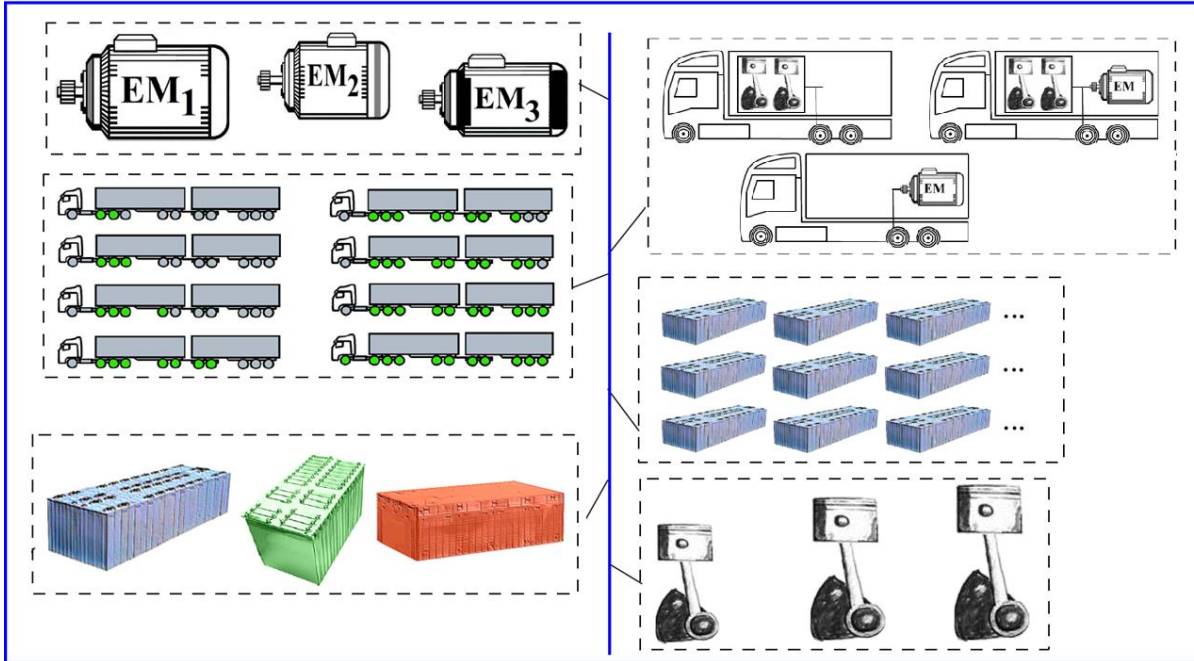

Find vehicle components and infrastructure
to minimize TCO
subject to
vehicle model constraints
performance constraints
transportation task constraints

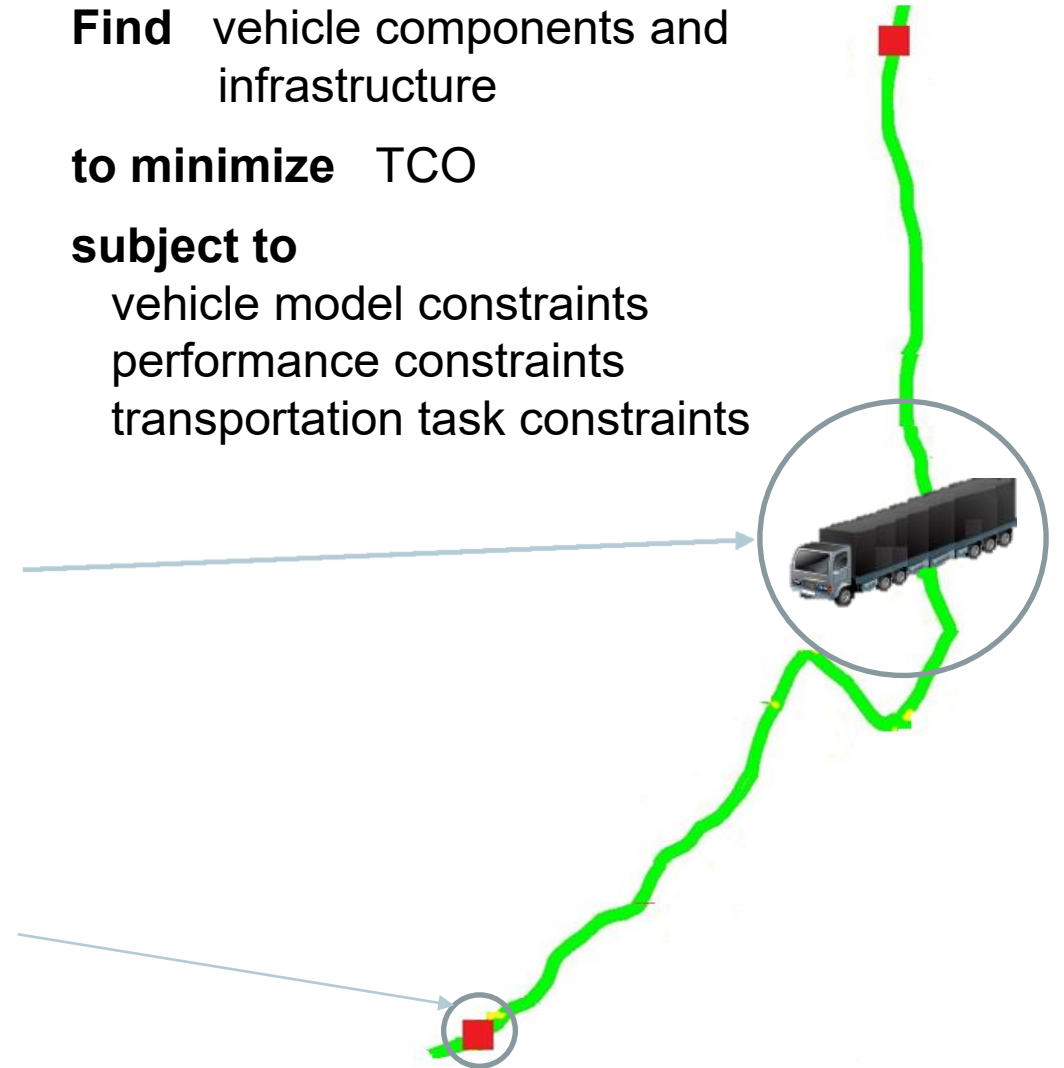

Integrated vehicle-infrastructure design

Why longer heavier vehicles?

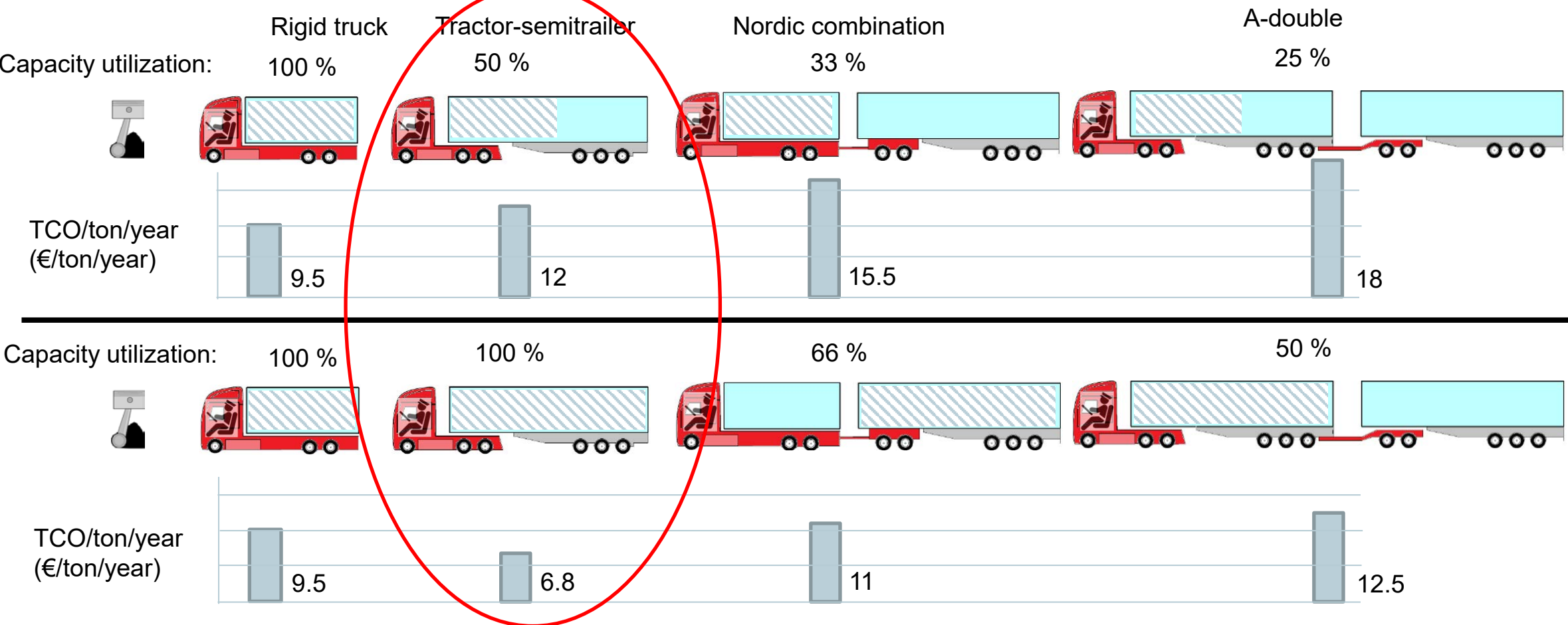

Integrated vehicle-infrastructure design

Why longer heavier vehicles?

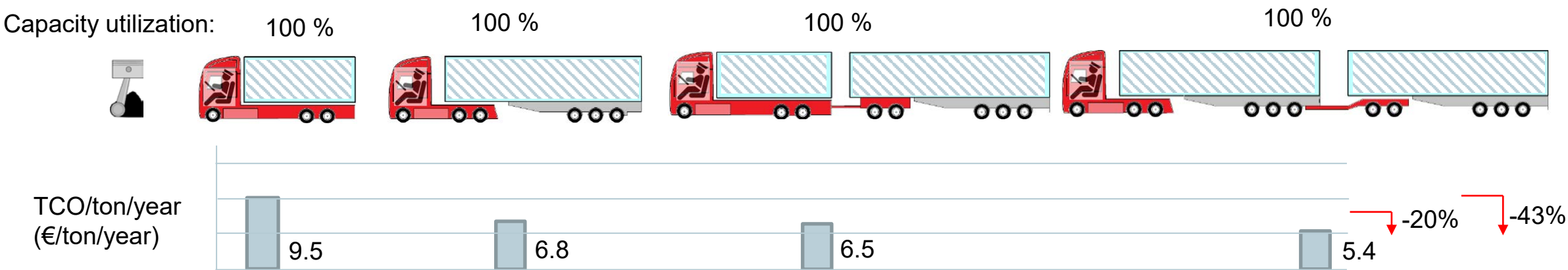
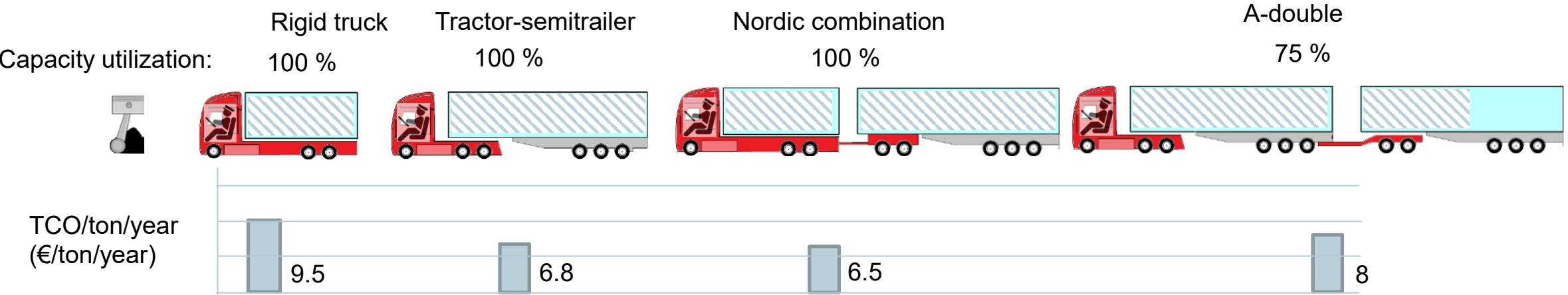

Integrated vehicle-infrastructure design

Why longer heavier vehicles?

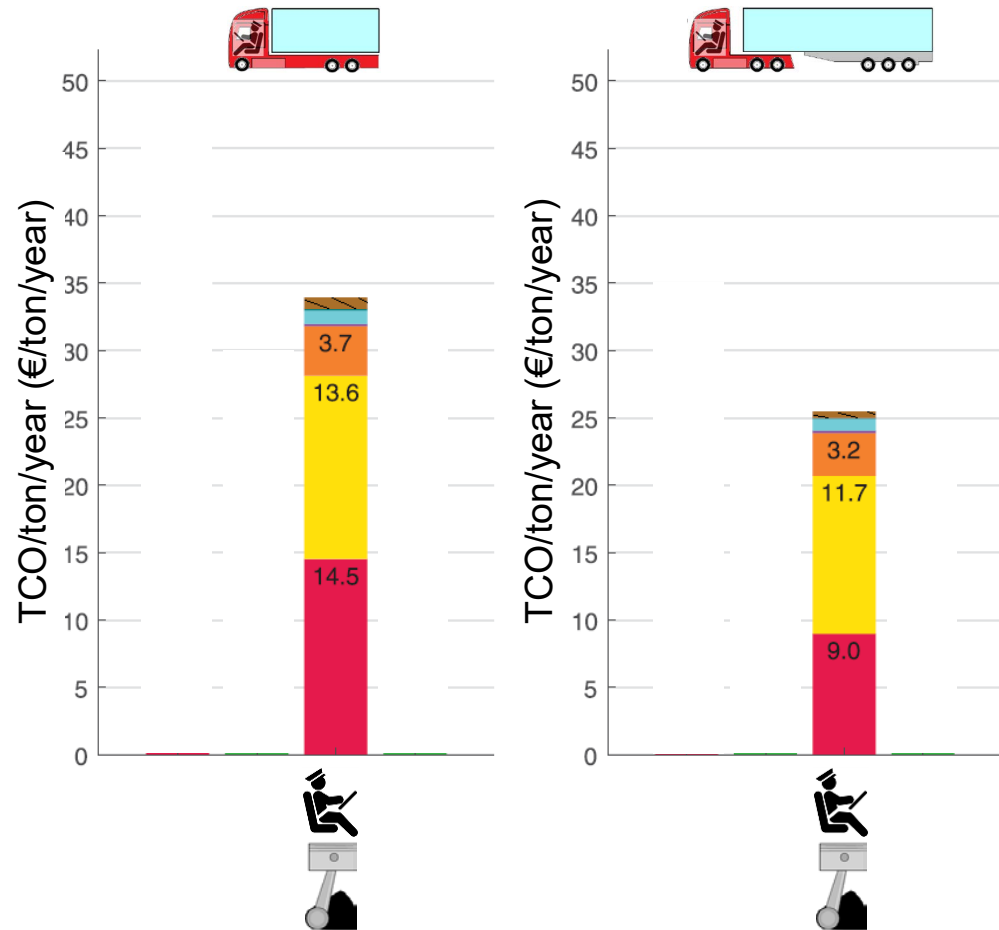

Predominantly flat road, 320 km, 100% utilization

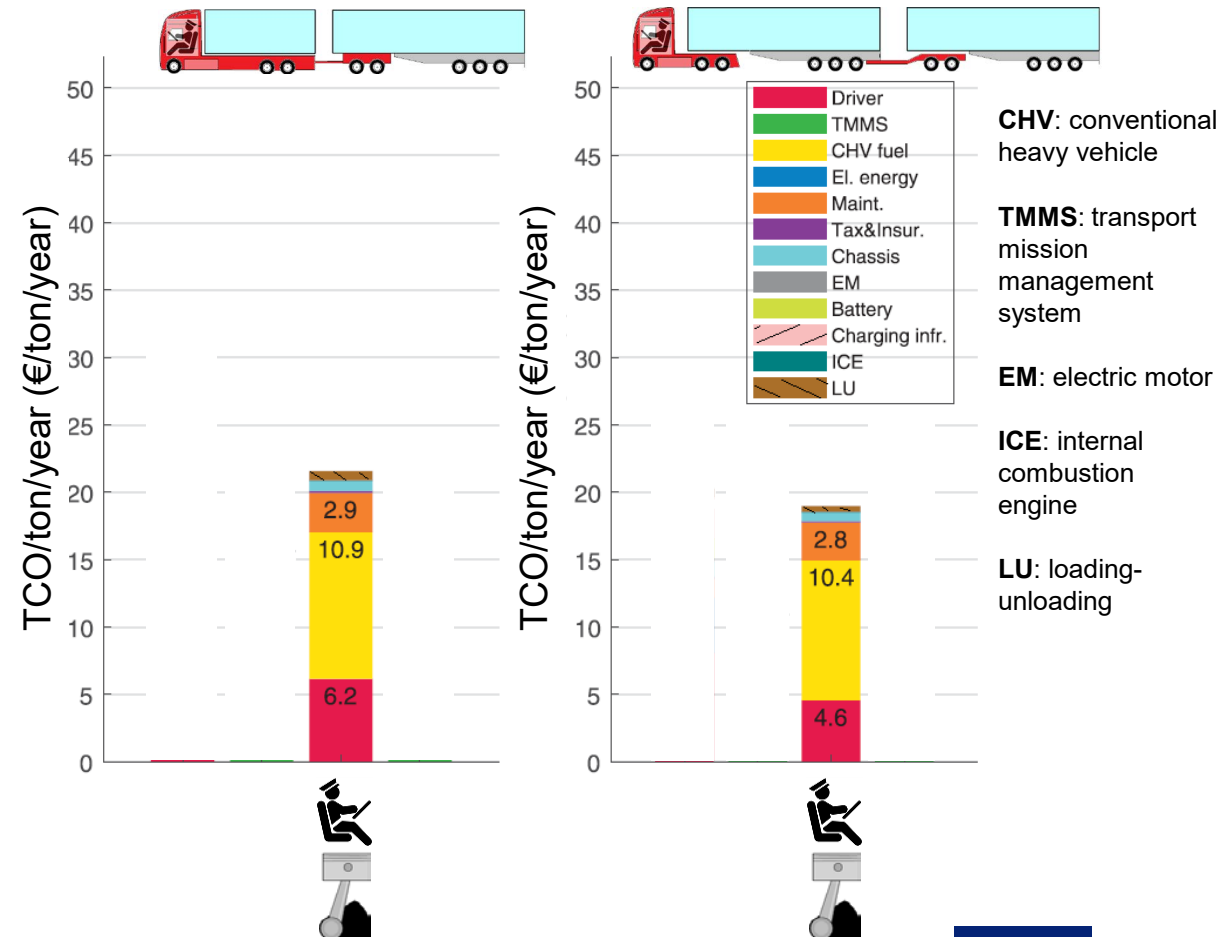

- CHV:** conventional heavy vehicle
- TMMS:** transport mission management system
- EM:** electric motor
- ICE:** internal combustion engine
- LU:** loading-unloading

Integrated vehicle-infrastructure design

Why electrification?

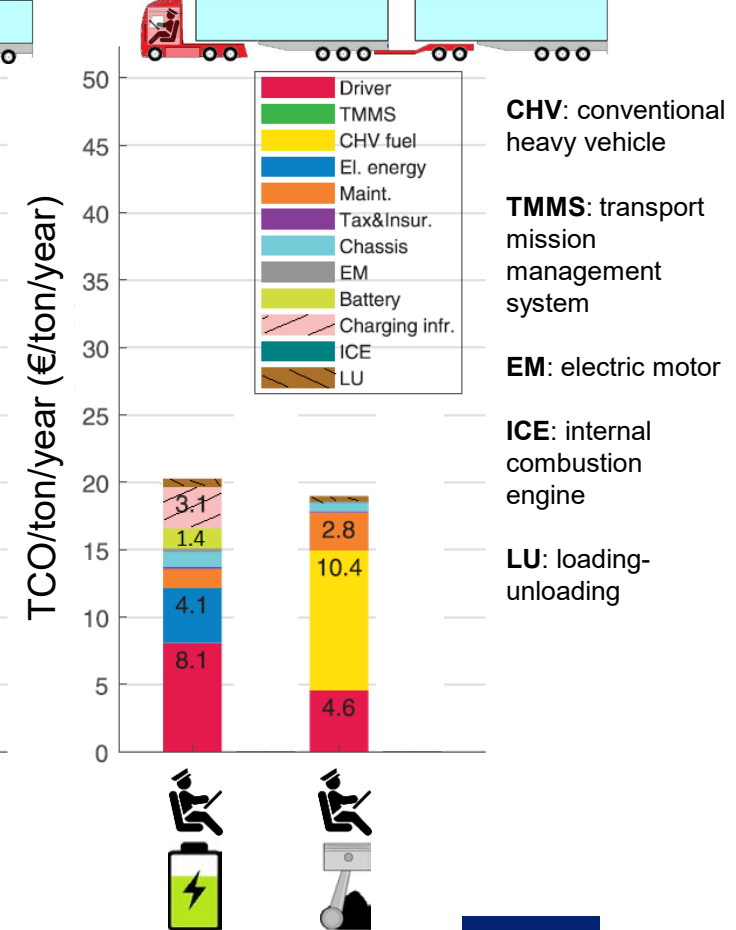
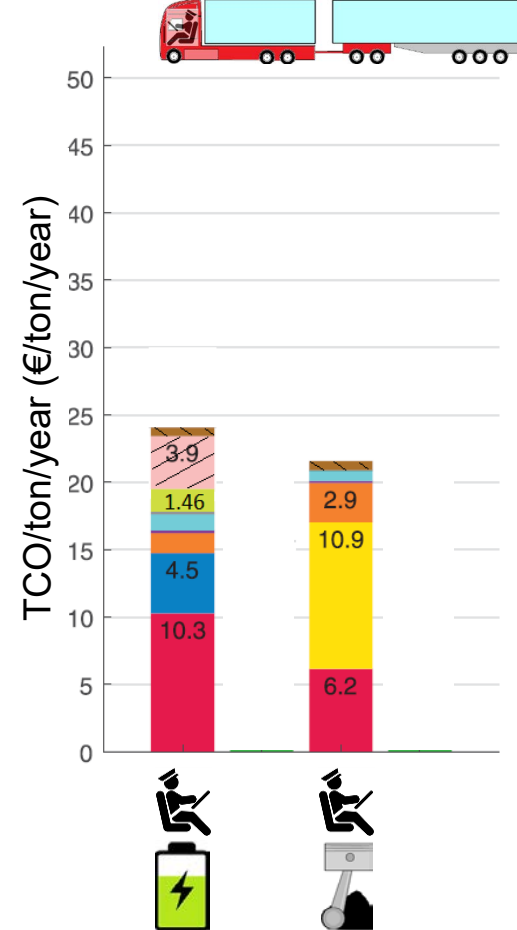
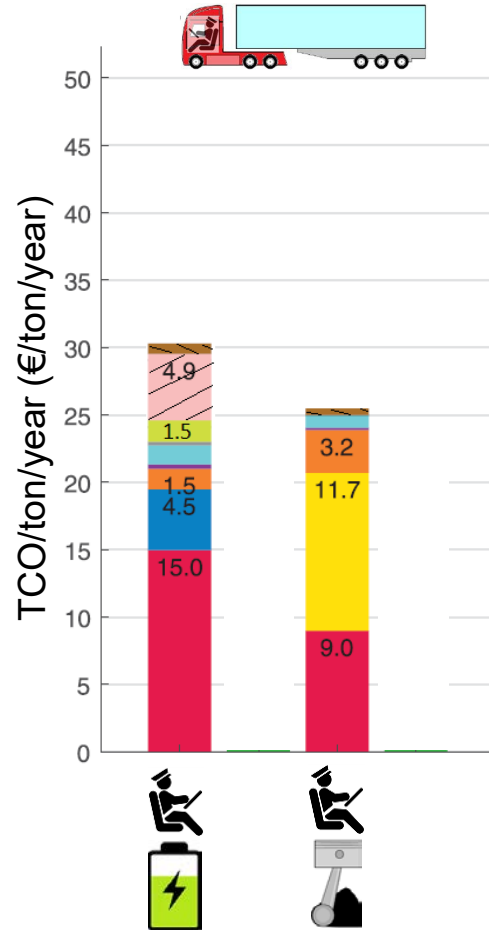
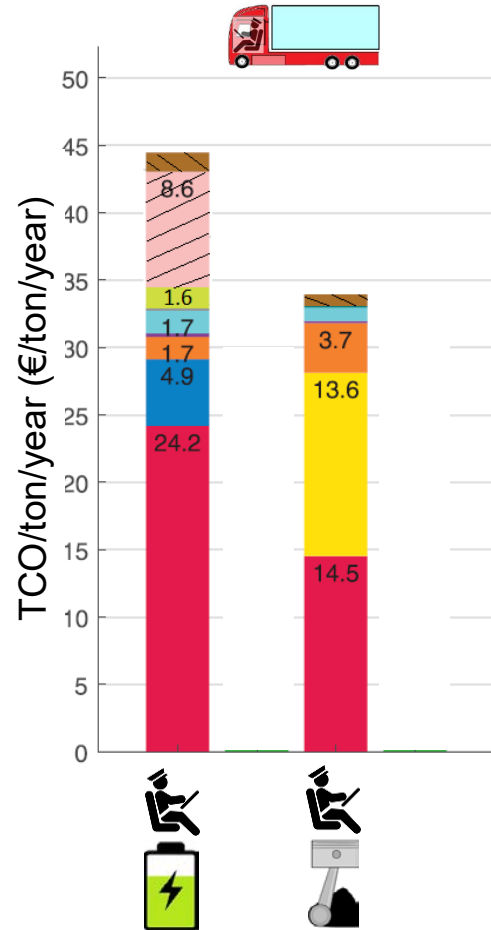

- CHV:** conventional heavy vehicle
- TMMS:** transport mission management system
- EM:** electric motor
- ICE:** internal combustion engine
- LU:** loading-unloading

Integrated vehicle-infrastructure design

Why automation?

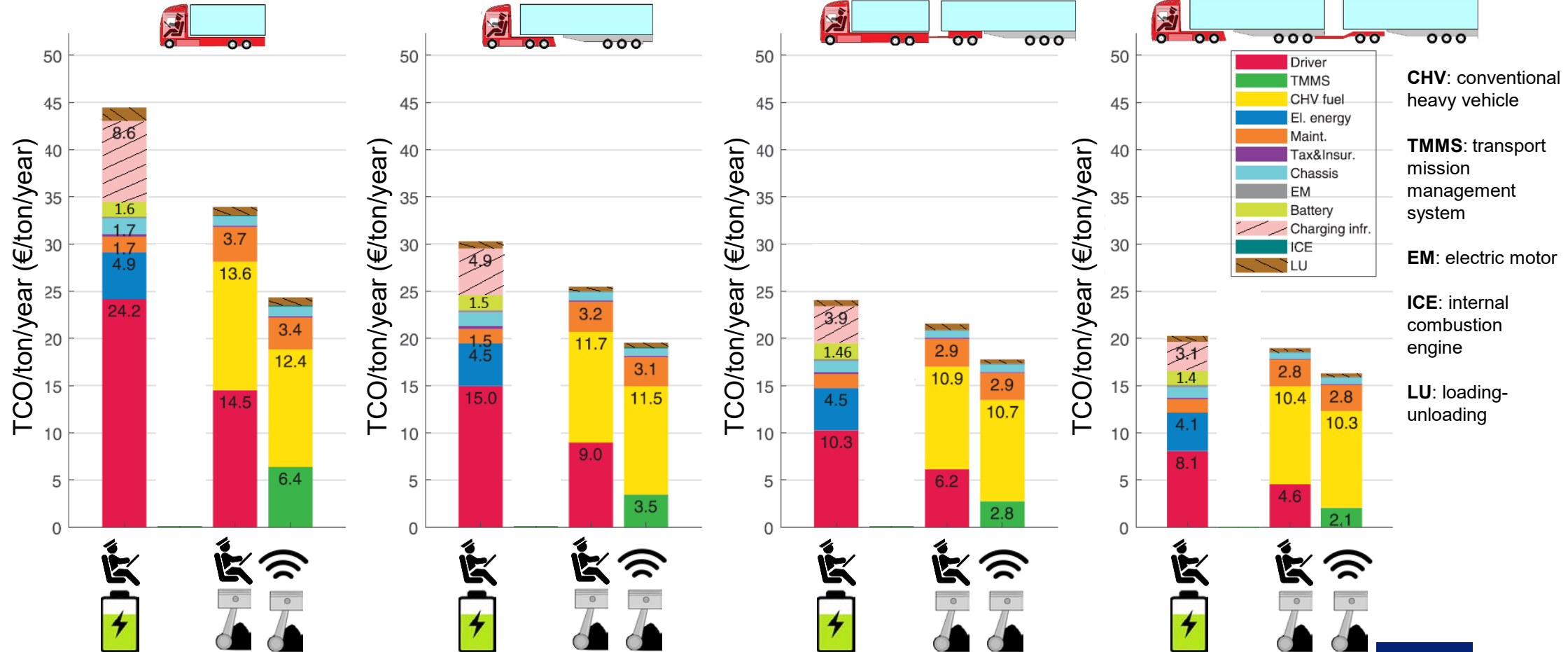

Integrated vehicle-infrastructure design

Why electrification and automation?

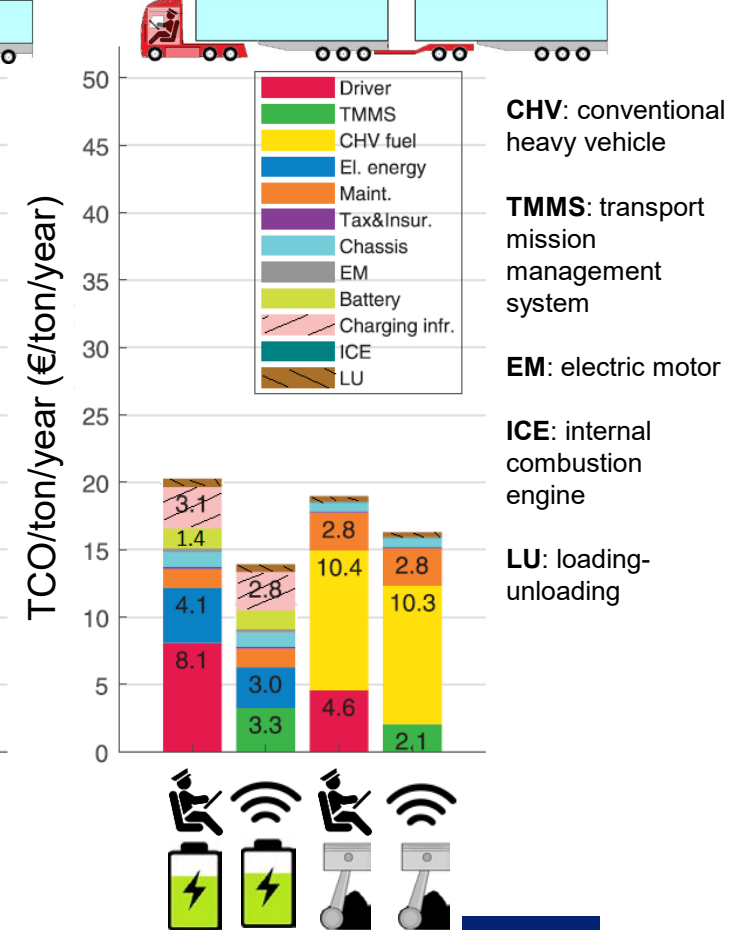
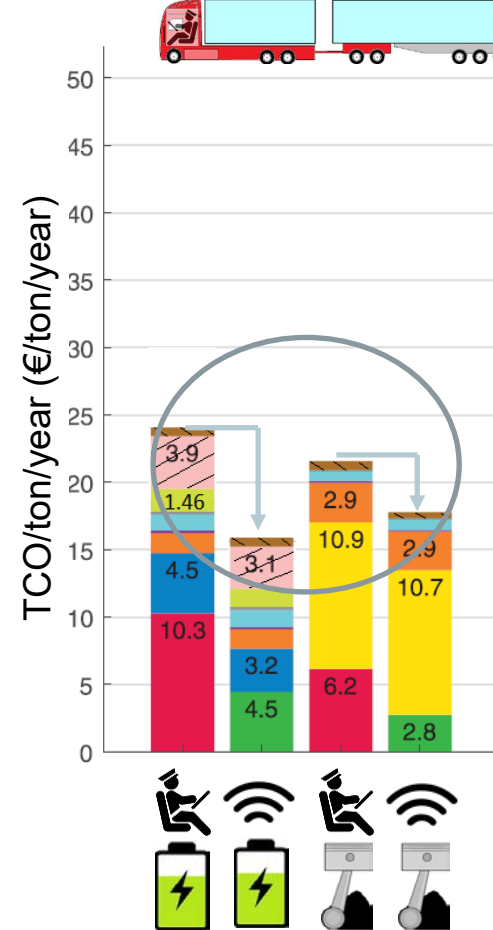
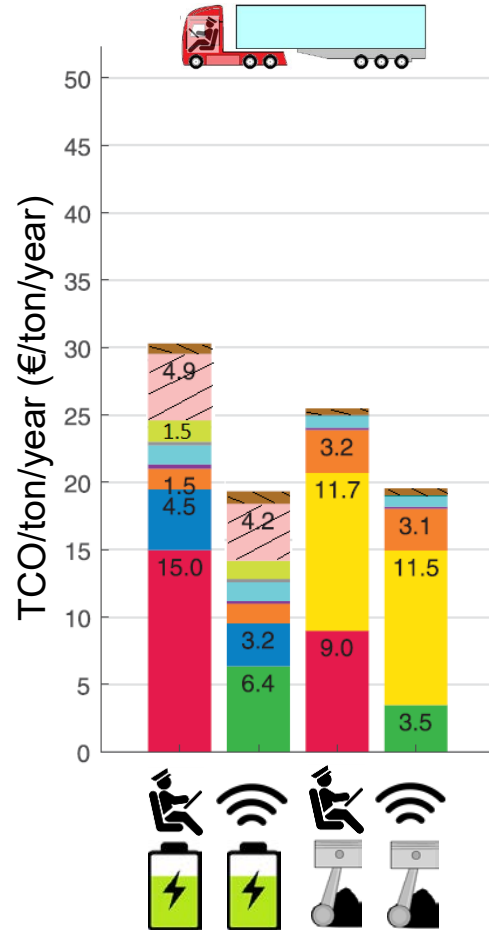
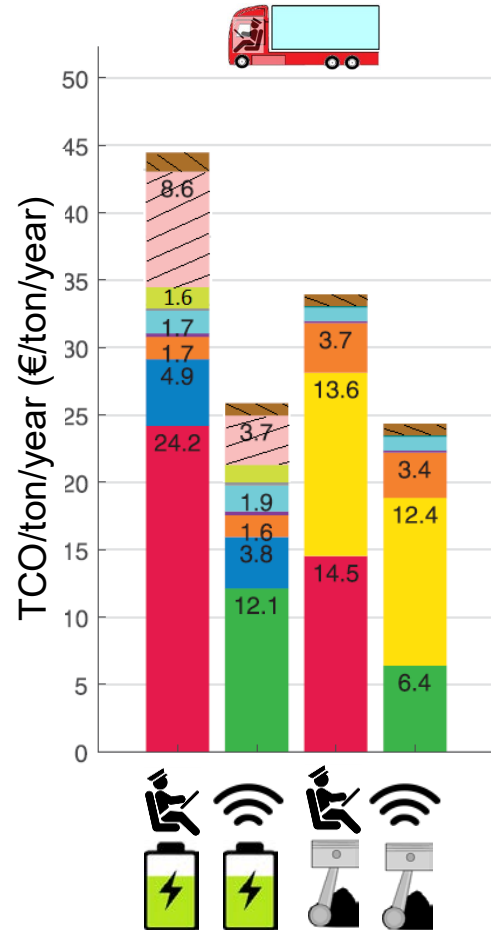

- CHV:** conventional heavy vehicle
- TMMS:** transport mission management system
- EM:** electric motor
- ICE:** internal combustion engine
- LU:** loading-unloading

Integrated vehicle-infrastructure design

An example of sensitivity analysis:

Predominantly flat road, 320 km, tractor-semitrailer

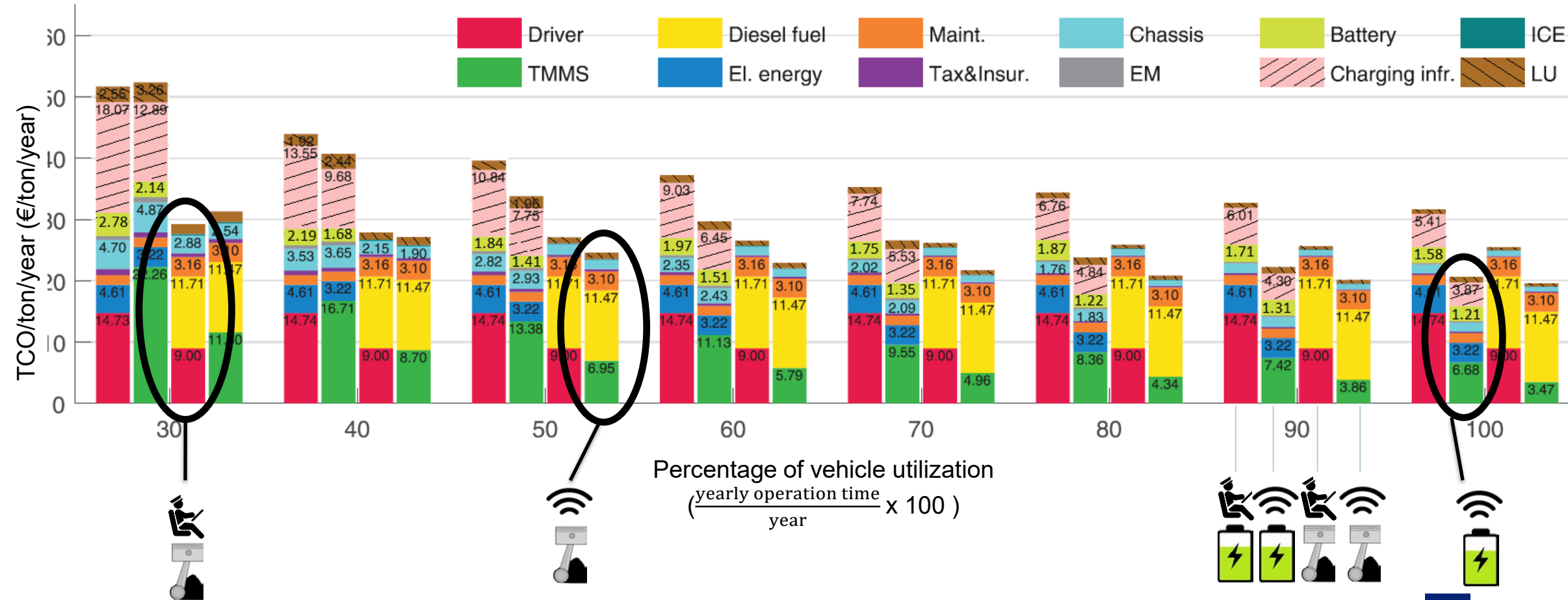

Predictive energy management and motion control

As the result of vehicle-infrastructure optimization vehicles with distributed propulsion on different axles may appear.

Their energy optimality and safe operation on roads must be assured.

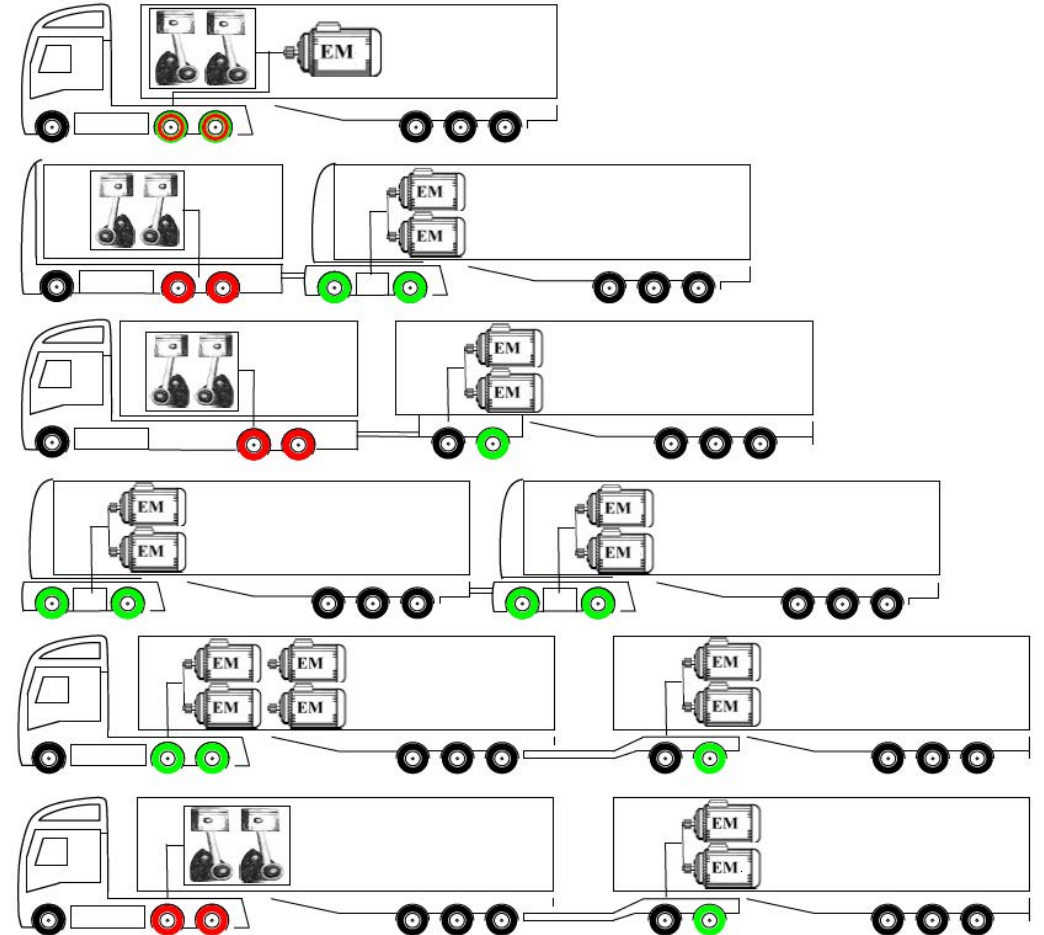

- Increasing road safety

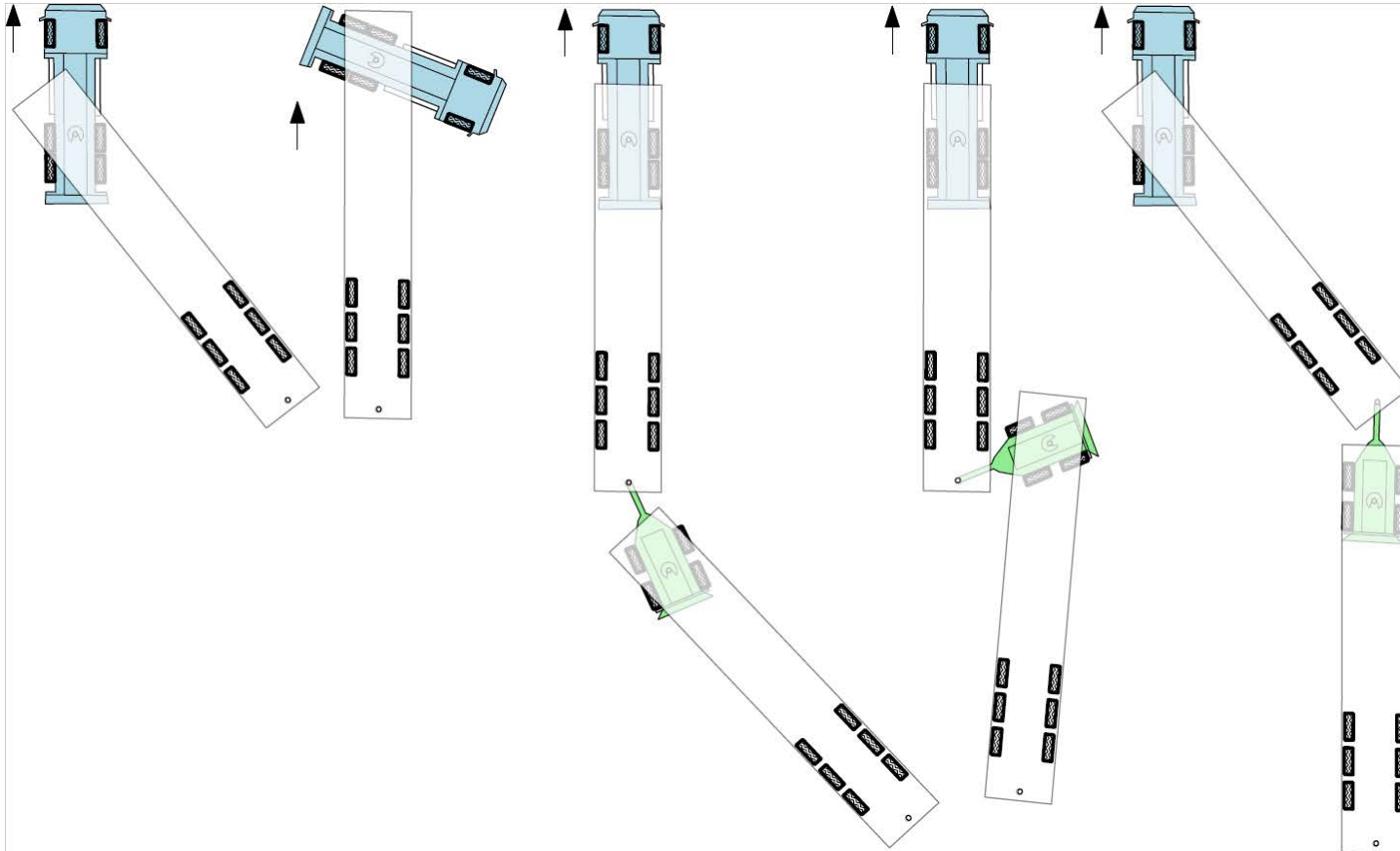

animation

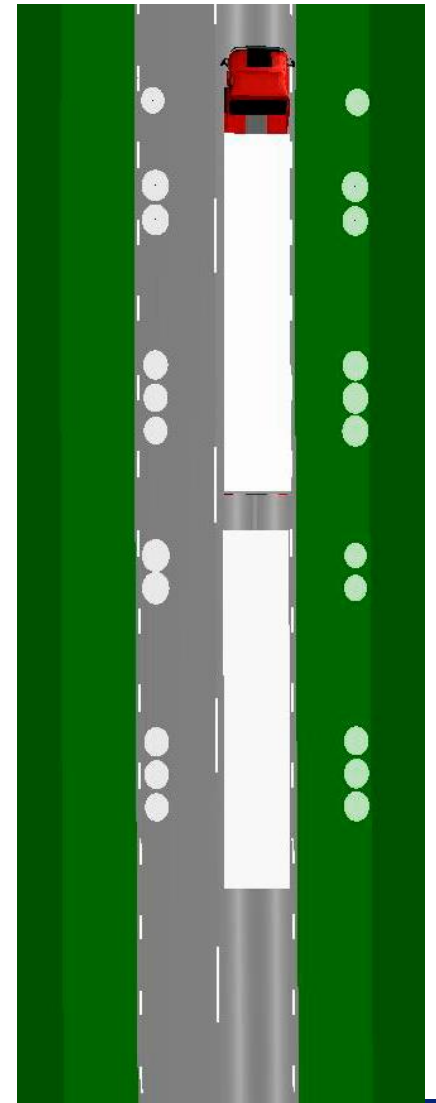

Mathematical models and optimization methods

Predictive energy management and motion control

Nonlinear optimal control problems:

Find

$$u(s)$$

to minimize

$$C_t(x(s_f), s_f) + \int_{s_0}^{s_f} L(x(s), u(s), s) ds$$

subject to

$$g(x(s), \frac{dx(s)}{ds}, u(s), s) = 0$$

$$h(x(s), \frac{dx(s)}{ds}, u(s), s) \leq 0$$

$$x(0) = \hat{x}$$

Powers of engine and electric motors, transmission ratios, forces on different axles, steering angles, ...

fuel consumption, electric energy, energy losses, battery degradation, engine on/off, deviation from a desired path, ...

system dynamic, powertrain limits, trip time, ...

- s : position
- $u(s)$: unknown trajectories
- $x(s)$: dynamic states
- C_t : terminal cost
- L : stage cost
- s_0 : start position
- s_f : final position
- g : system dynamic DAE
- h : inequality constraints
- \hat{x} : initial (or estimated) states

Mathematical models and optimization methods

Vehicle dynamic motion

Yaw plane motion with load transfer, one- and two-track models, coupled lateral and longitudinal dynamics, nonlinear combined slip tire model, with experimental validation.

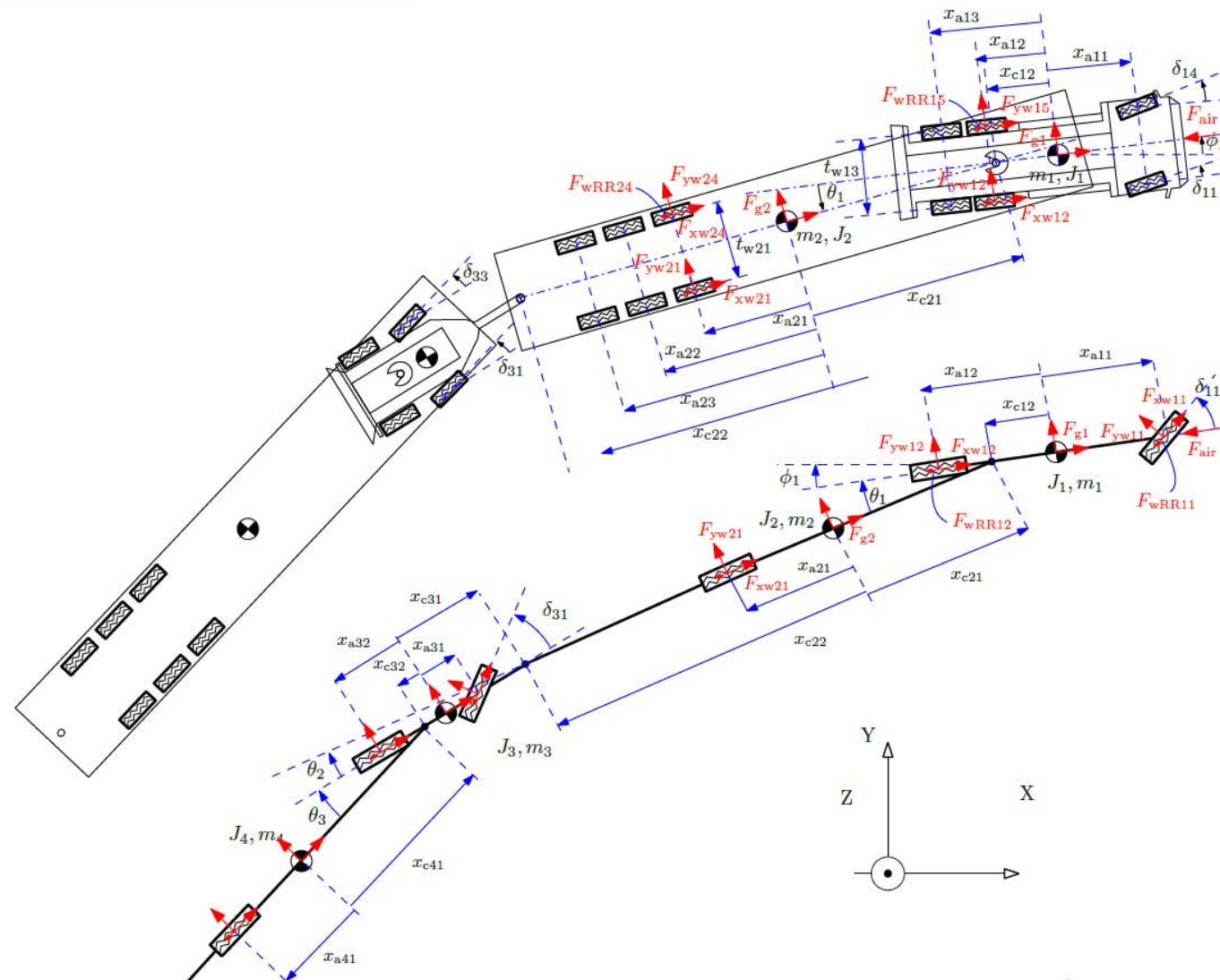

Mathematical models and optimization methods

■ Vehicle dynamic motion

Experimental verification



Yaw rate (YR), brake in curve maneuver

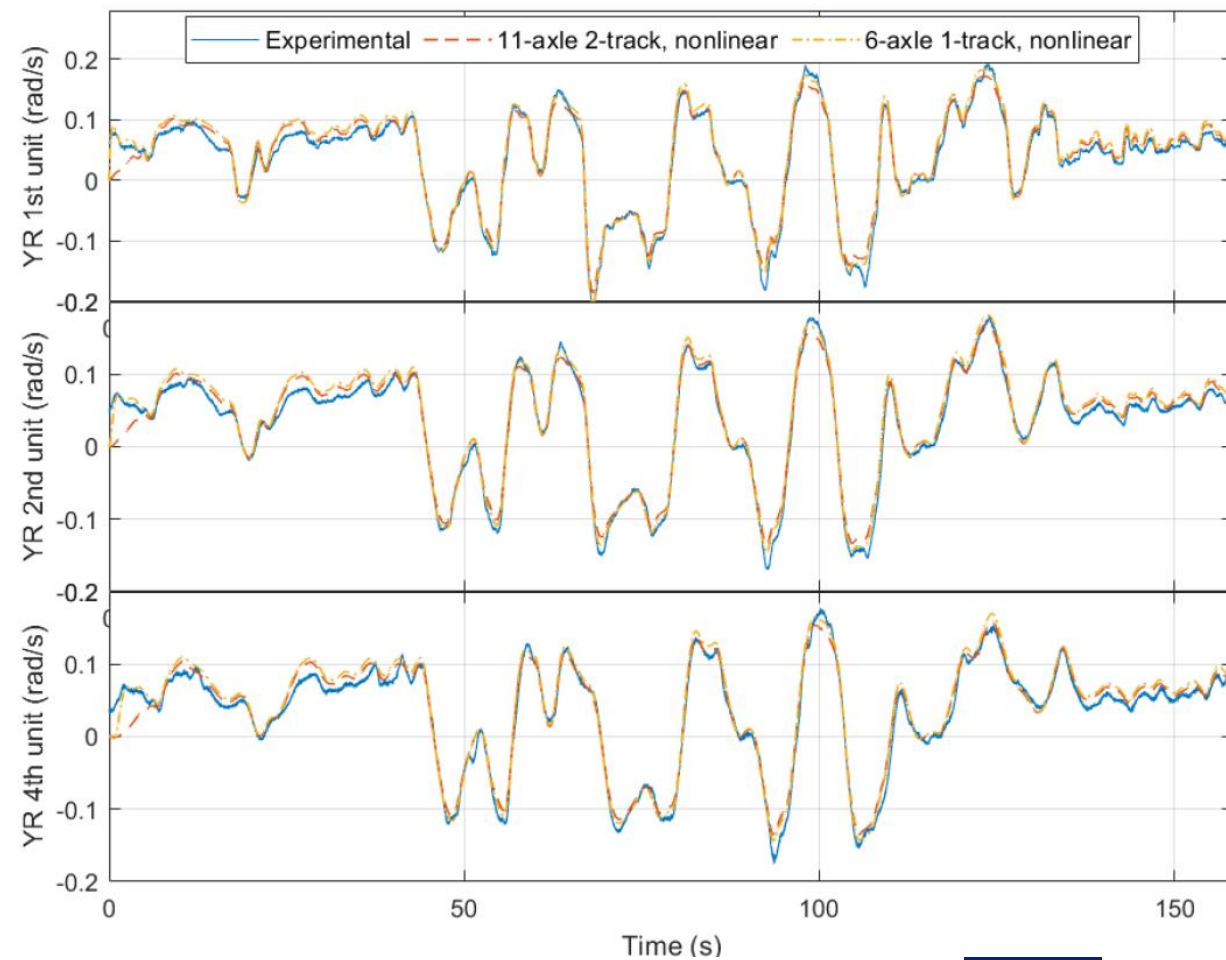

Mathematical models and optimization methods

Powertrain modeling

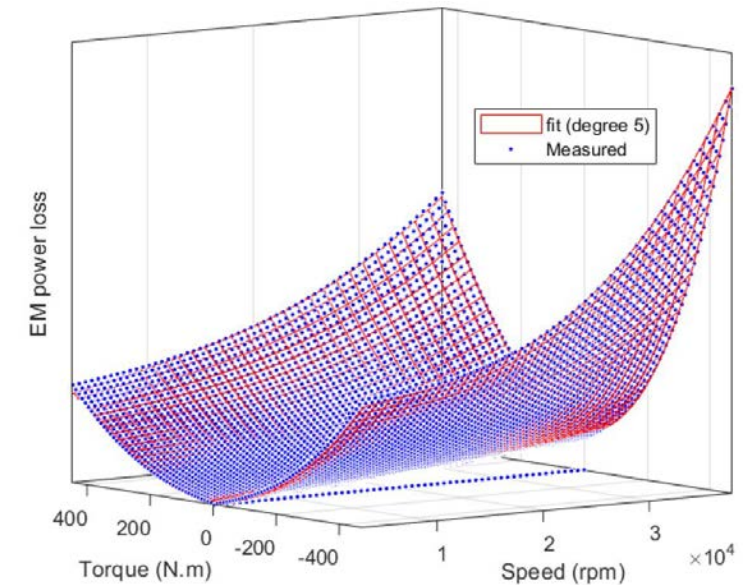
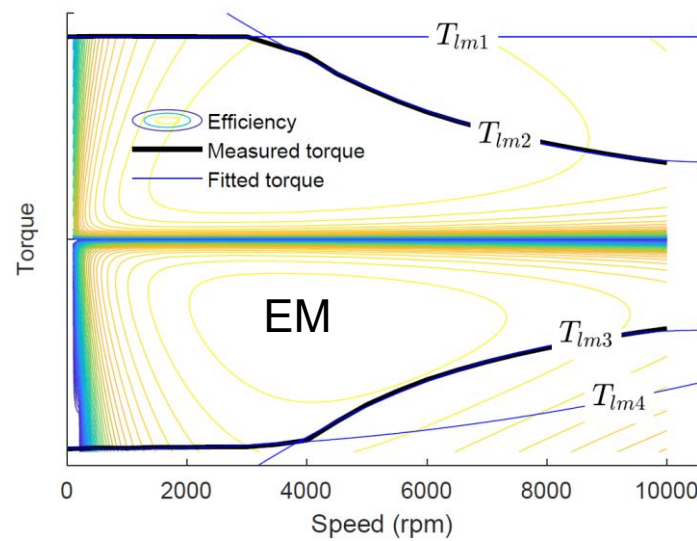
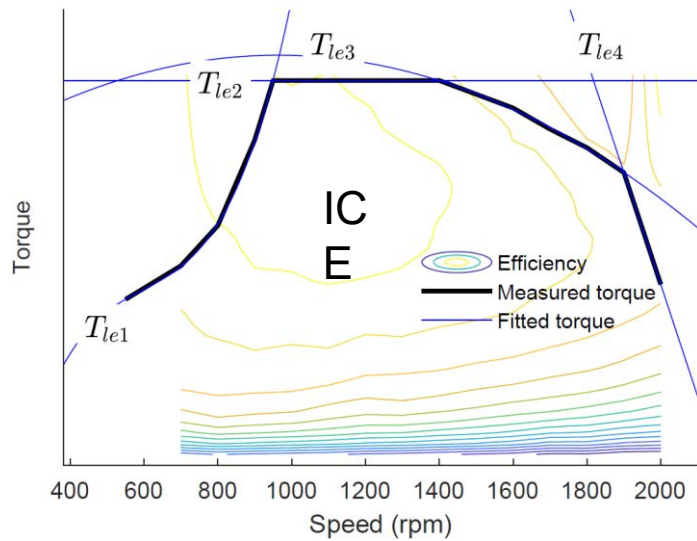
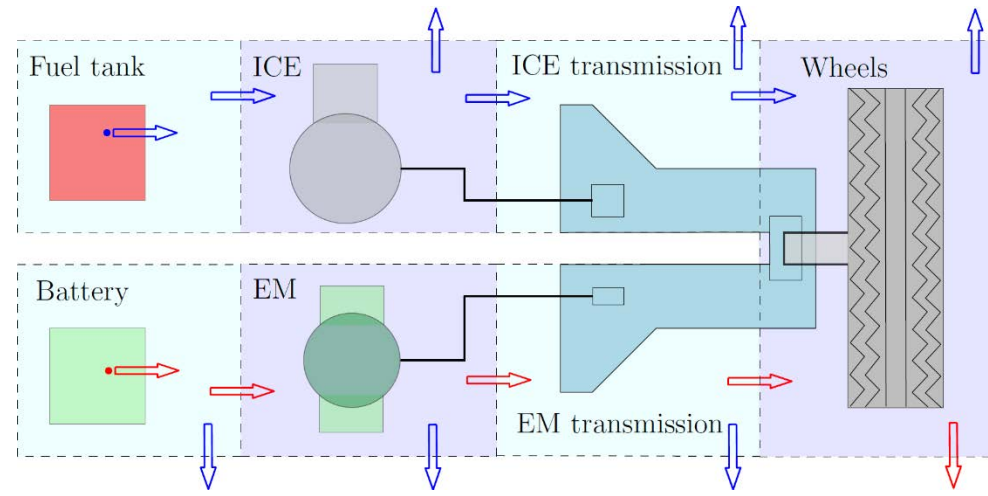

Mathematical models and optimization methods

Operational environment and operating cycles

Transportation network road map

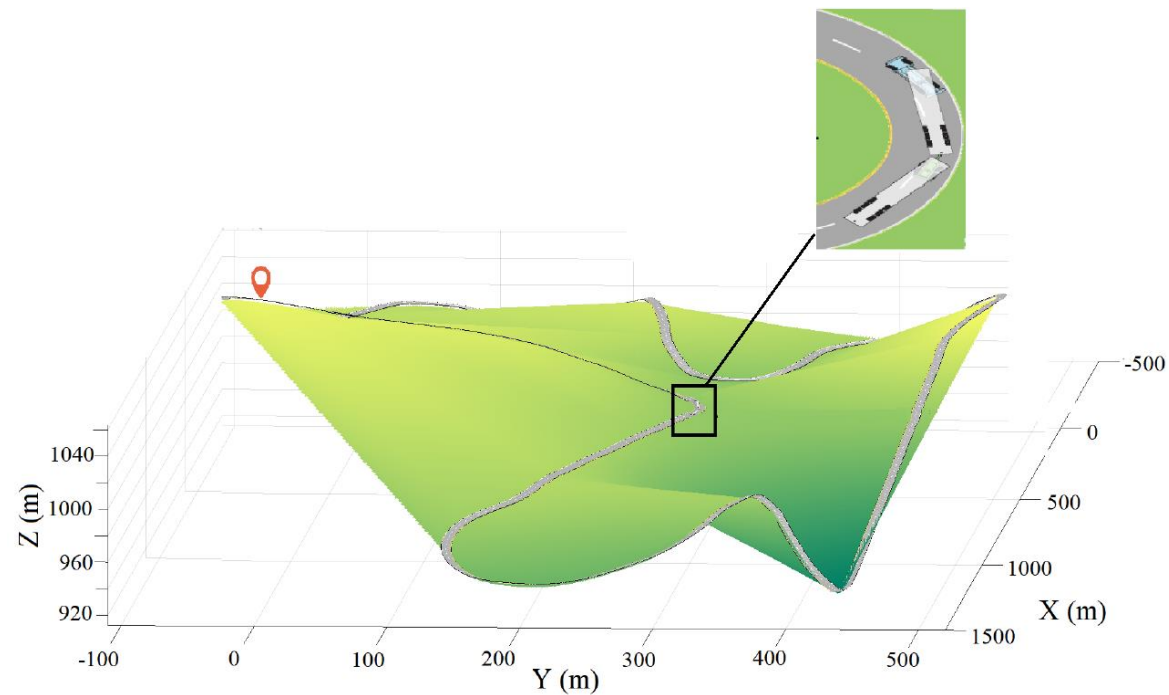
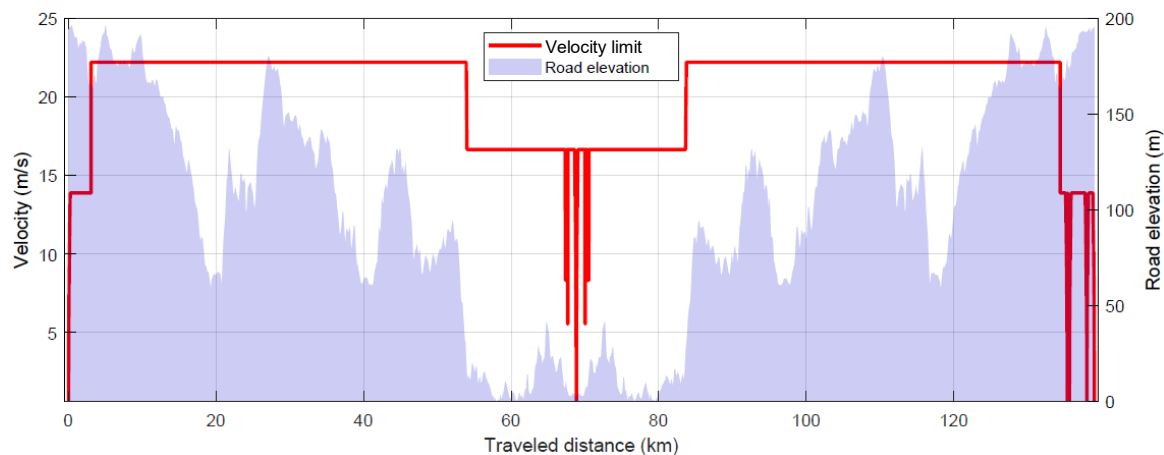
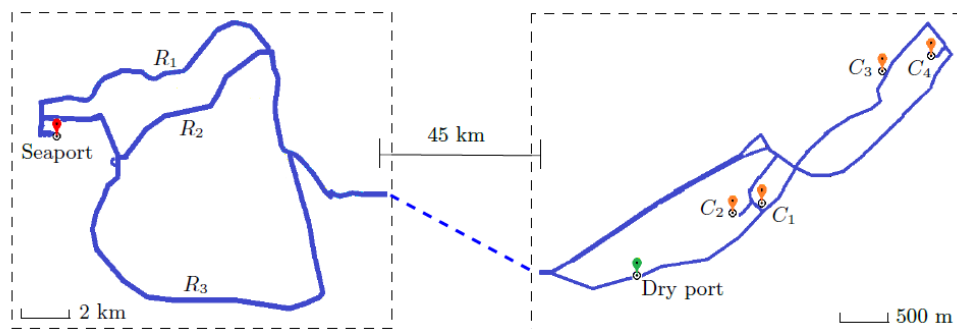

Predictive energy management and motion control

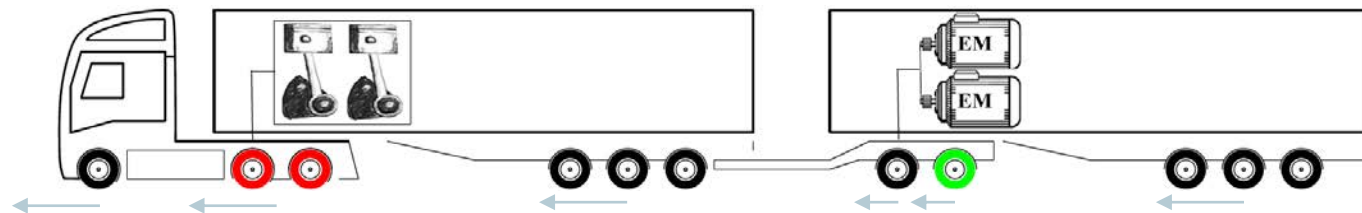

A-double motion (animation)



Predictive energy management and motion control

A-double motion, braking the dolly's 2nd axle (animations)

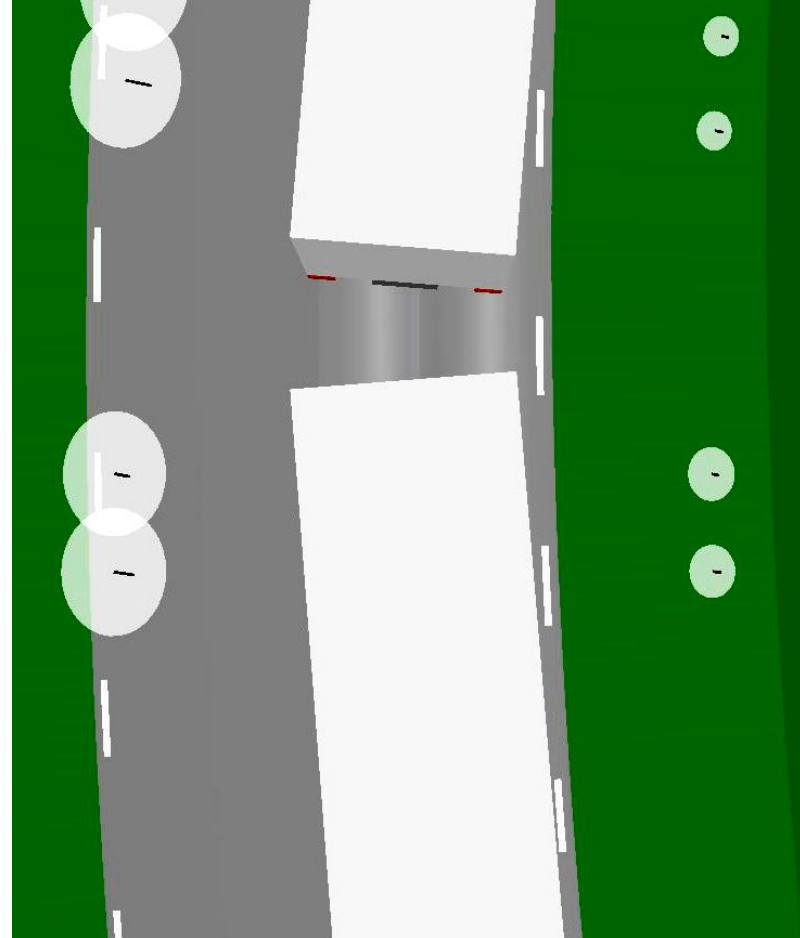
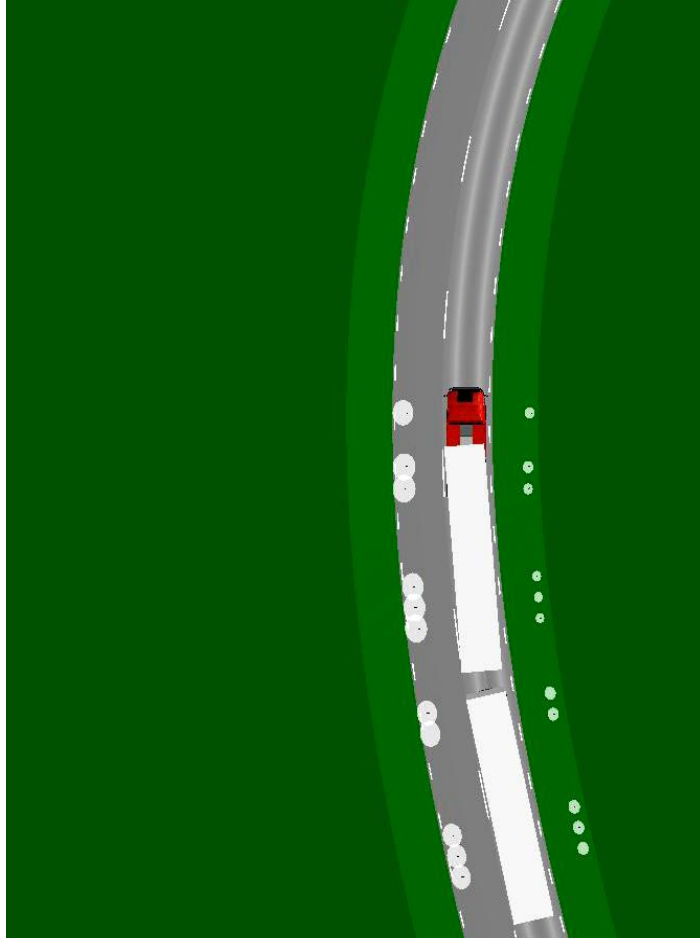

Predictive energy management and motion control

Combined tire slip model and multitrailer dynamic motion also need to be taken into account.

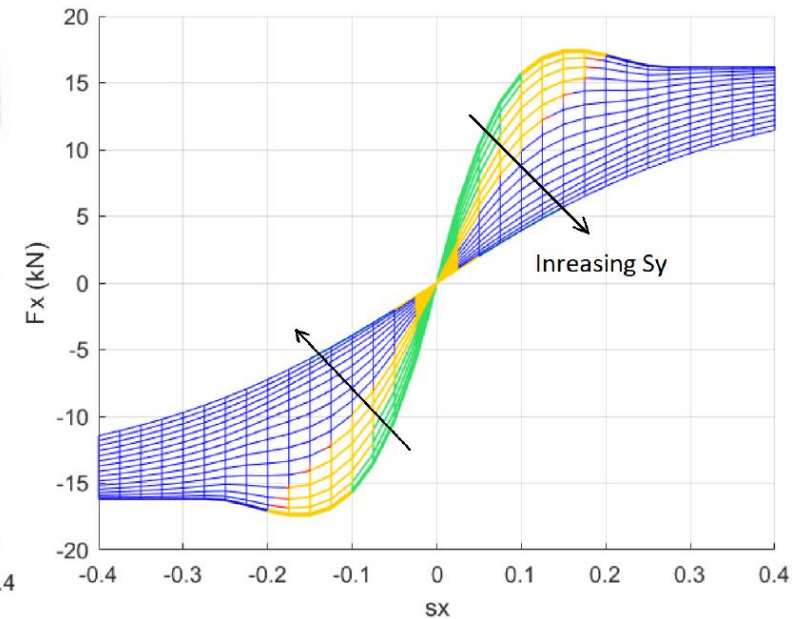
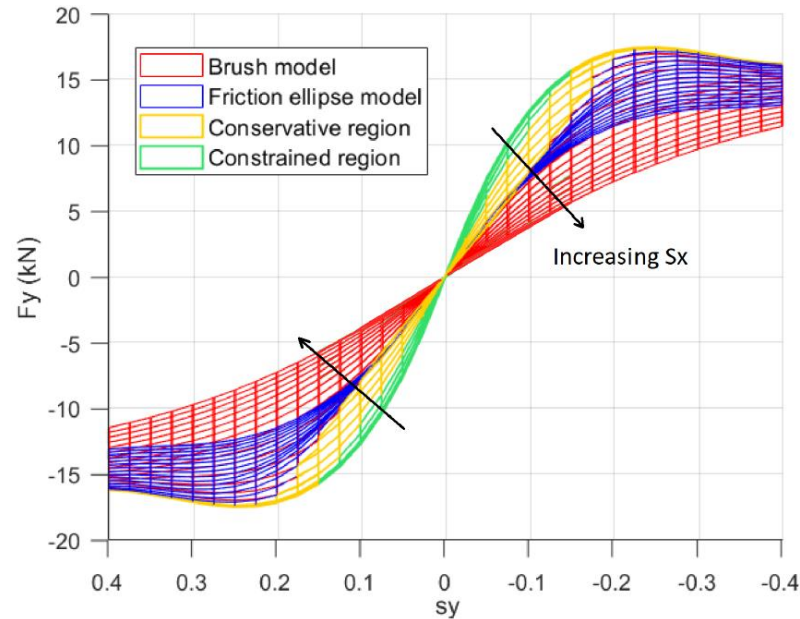
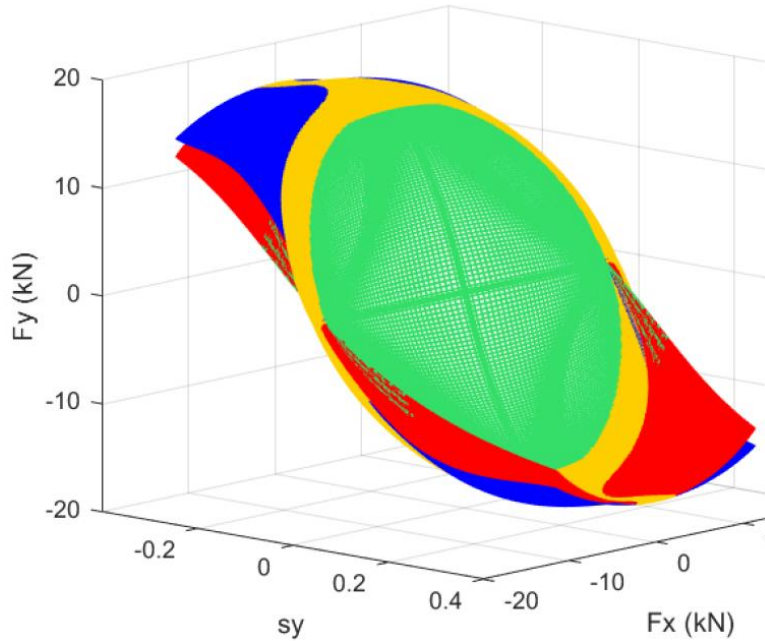

Predictive energy management and motion control



Optimally controlled A-double motion (animations)

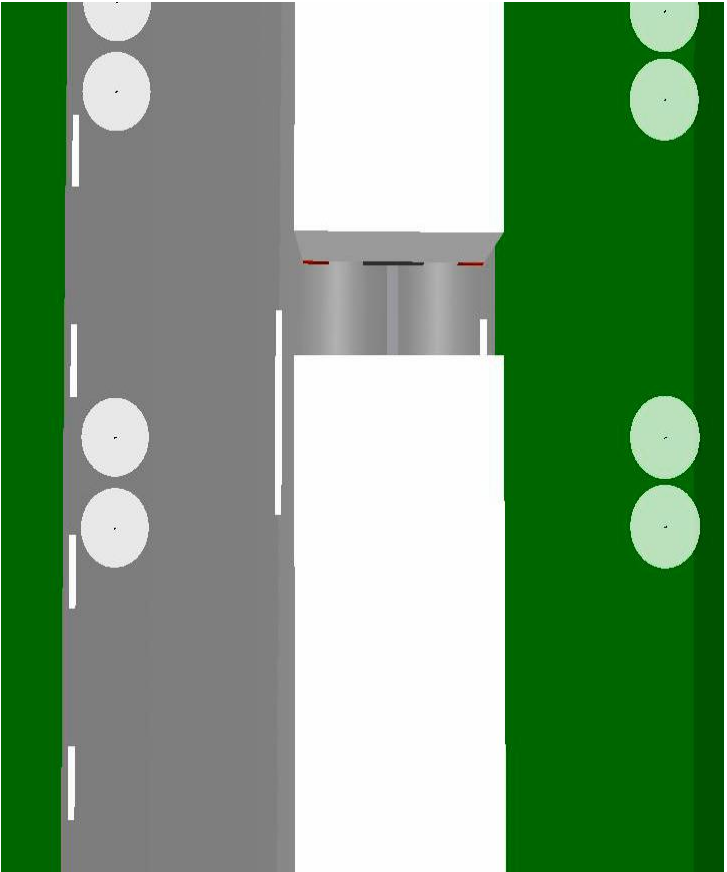
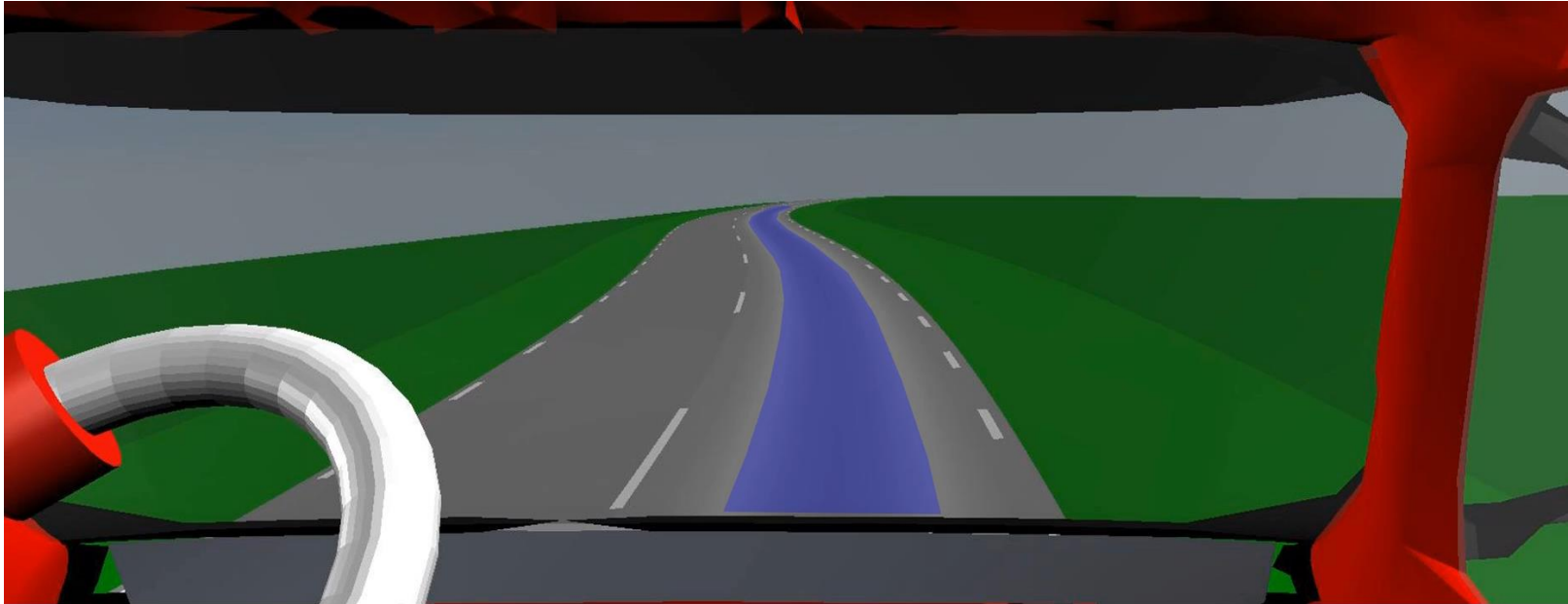

Predictive energy management and motion control

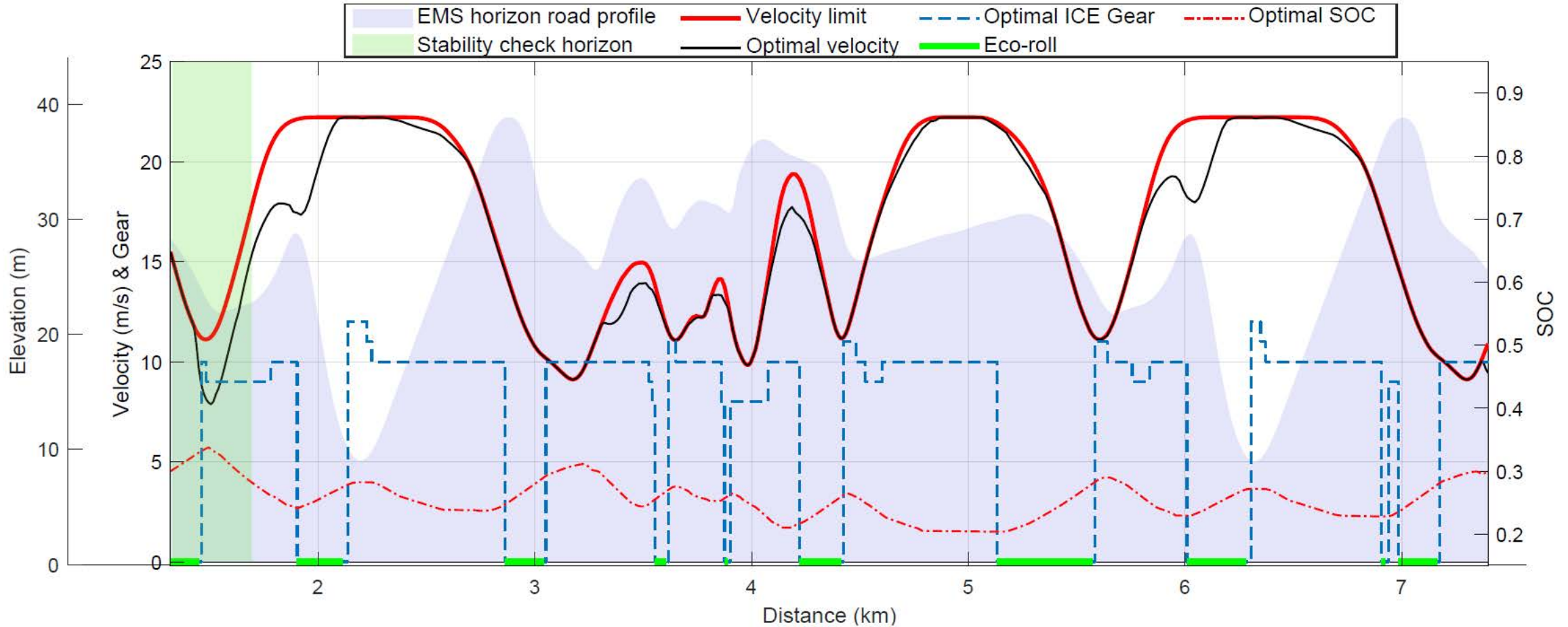

Predictive energy management and motion control

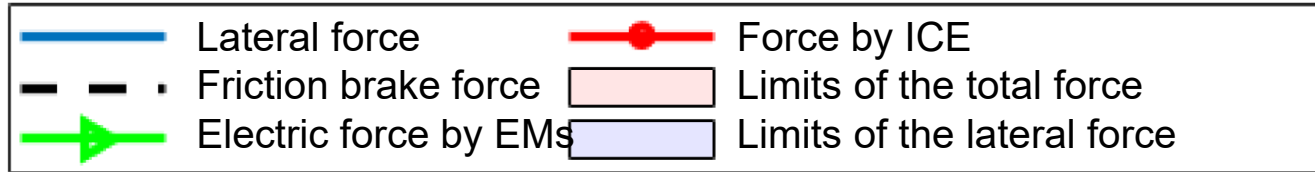

Optimal forces but unstable vehicle

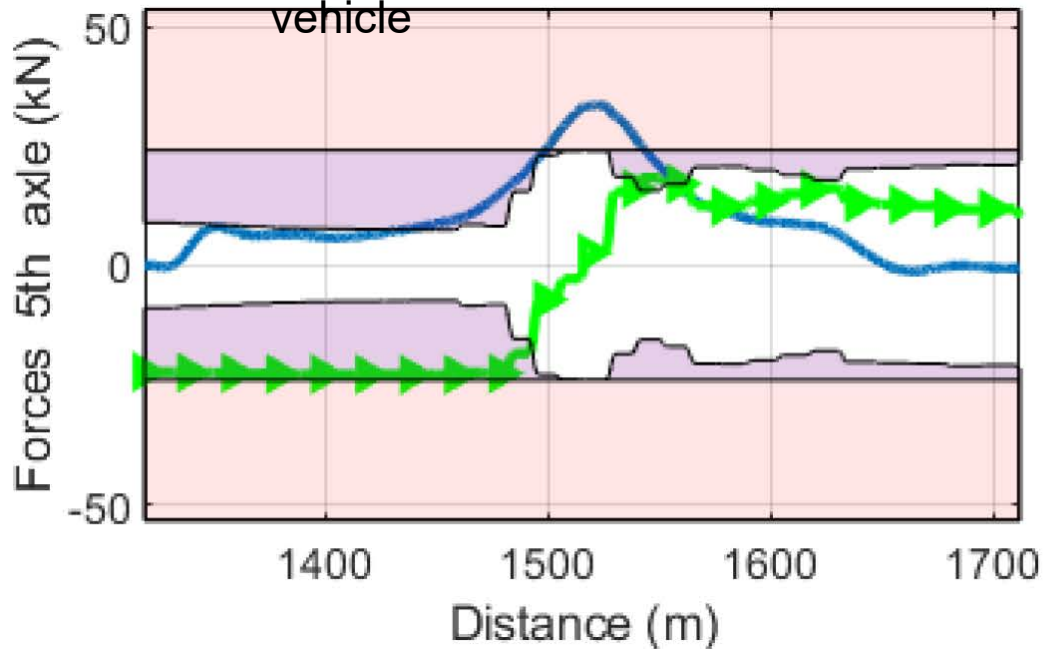

Optimal forces and stable vehicle

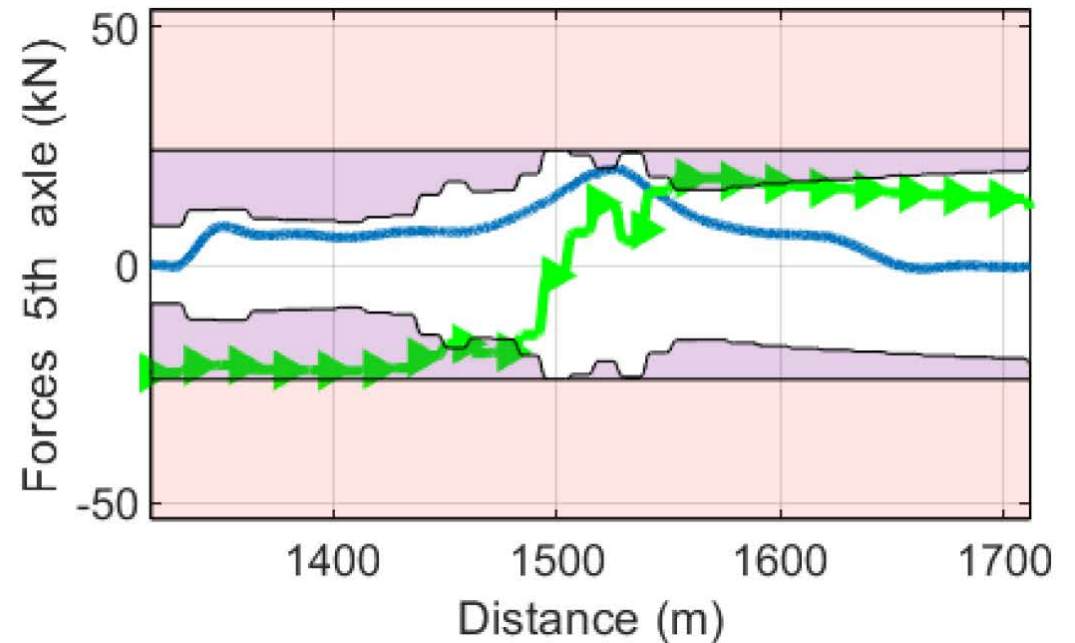

Predictive motion control

High-speed off-tracking minimization using NMPC:

- combined steering, braking and propulsion control
- coupled lateral and longitudinal dynamics
- steerable dolly

animations

No optimal control

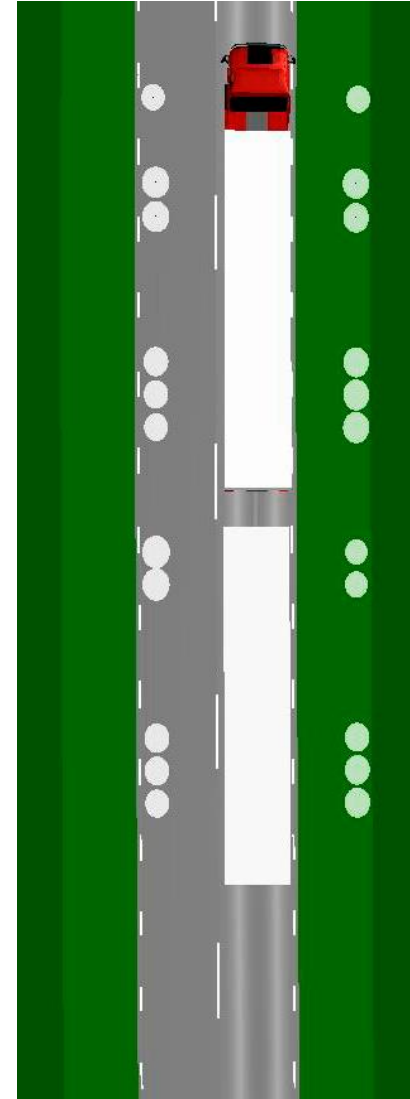

With optimal control

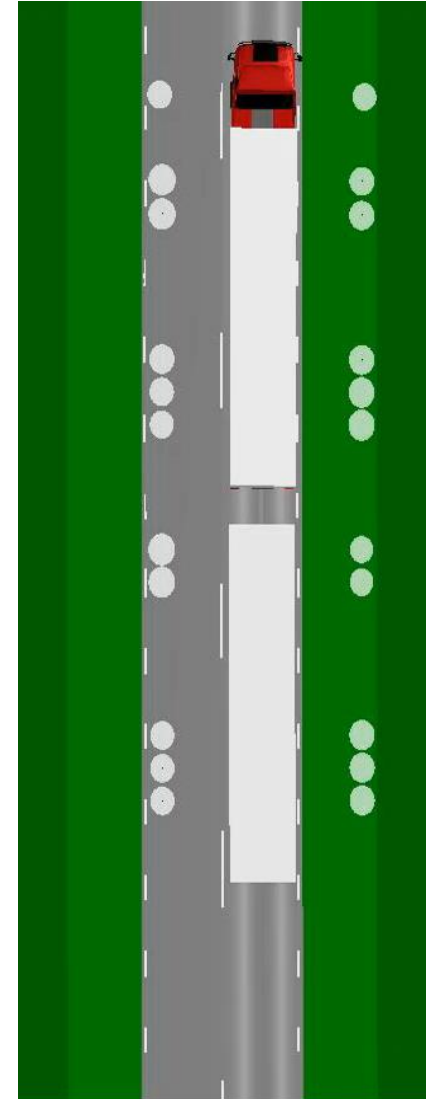

Predictive motion control

Combined steering, braking and propulsion control for off-tracking minimization using NMPC. Dolly is steerable.

Low-speed off-tracking

animations

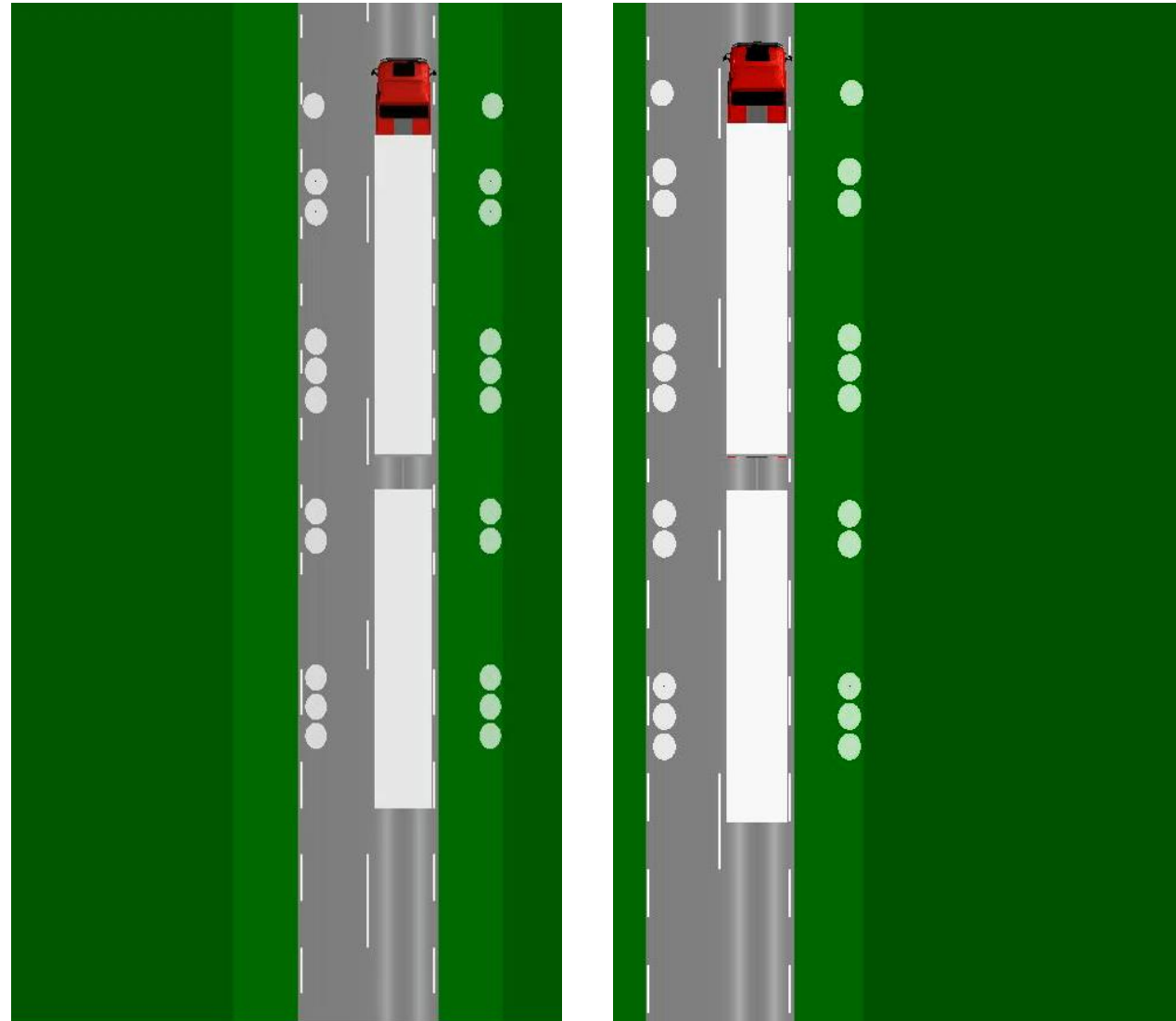

Main conclusion

Profitable, efficient and safe road freight transportation can be achieved by optimizing vehicles and infrastructure, and simultaneous optimal control of energy usage and vehicle motion on roads.

References

- T. Ghandriz, Transportation Mission-Based Optimization of Heavy Combination Road Vehicles and Distributed Propulsion Including Predictive Energy and Motion Control, Doctoral thesis, Chalmers University of Technology, Series number: 4882
- T. Ghandriz, B. Jacobson, L. Laine, and J. Hellgren, Impact of automated driving systems on road freight transport and electrified propulsion of heavy vehicles, Transportation Research Part C: Emerging Technologies, vol. 115, no. 102610, 2020. doi: 10.1016/j.trc.2020.102610
- T. Ghandriz, B. Jacobson, N. Murgovski, P. Nilsson, and L. Laine, Real-time Predictive Energy Management of Hybrid Electric Heavy Vehicles by Sequential Programming. IEEE Transactions on Vehicular Technology, 2021, doi: 10.1109/TVT.2021.3069414
- T. Ghandriz, B. Jacobson, P. Nilsson, L. Laine, and N. Fröjd Computationally Efficient Nonlinear One- and Two-Track Models for Multitrailer Road Vehicles. IEEE Access, vol. 8, pp. 203854 - 203875, 2020, doi: 10.1109/ACCESS.2020.3037035
- <https://www.youtube.com/watch?v=6LtxlwvH-mQ>

Thank you!

toheed.ghandriz@chalmers.se

toheed.ghandriz@volvo.com

Presentation: *High Capacity Transport in Sweden*, Jesper Sandin, VTI

SAFER

VEHICLE AND TRAFFIC SAFETY CENTRE AT CHALMERS

HCT and traffic safety research in Sweden

SVEA Seminar 2021-05-26

jesper.sandin@vti.se

High Capacity Transports (HCT)

Challenge

- Increased transport demands
- Traffic Congestion
- Environmental concerns

Solutions:

- Build new infrastructure
 - Expensive
 - Takes time
 - Environmental impact remains
- Introducing HCT vehicles
 - Fewer vehicles needed
 - Higher energy efficiency
 - Reduced emissions (CO2)
 - Higher transport efficiency
 - Reduced transport costs
 - ? – Traffic safety



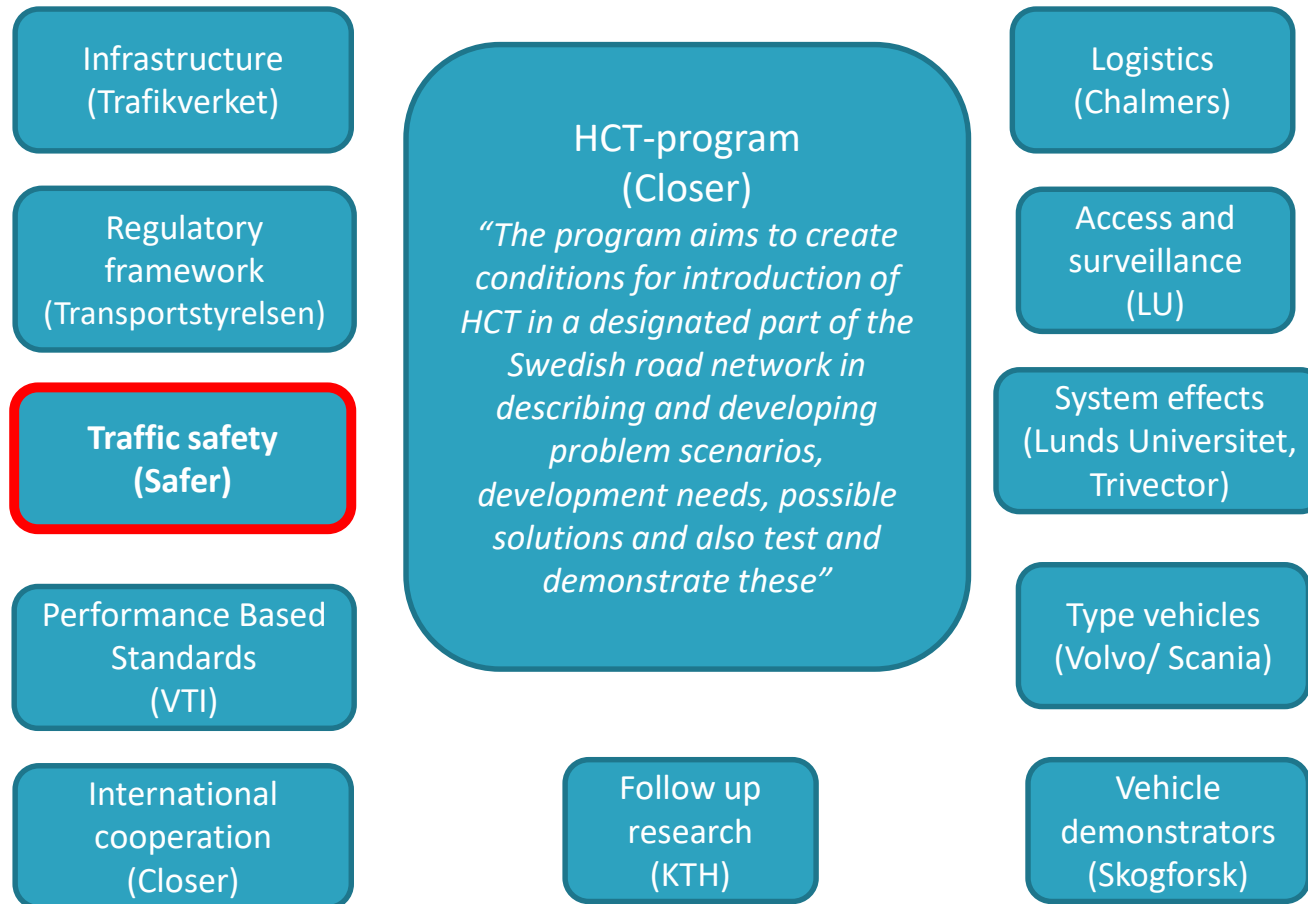

High safety performance of HCTs – Why?

Based on countries that have long experience of HCT on a larger scale

Lower accident risk compared to the conventional truck fleet

- Canada: HCTs are 2.5 to 5 times safer
- Australia: HCTs have 76% less accidents
 - But the cost of each crash may be higher

Why?

- Fewer vehicles are needed for transport
- Vehicles customized for the transport tasks and roads (through PBS)
- Special permit required:
 - Designated transport routes, restrictions on speed, time of day, road and weather conditions
 - Australia: monitoring of truck mass and route (IAP)
- Safe and experienced drivers
- Higher degree of control of, and within, hauliers
 - Accepted because of the productivity gains



SAFER
VEHICLE AND TRAFFIC SAFETY CENTRE AT CHALMERS

Definition of HCT in Sweden

An HCT in Sweden is longer than 25.25m and/or heavier than 64tonnes

- 74 tonne HCTs are allowed on designated road networks



Double trailer with containers (GVW 60tonne, length 32m)

Risk estimation of overtaking maneuvers

Fears that overtaking-related crashes increase with longer HCTs

- Field study on undivided two-lane road and 2+1 road
 - The 30m ETT-vehicle, and a 24 m reference vehicle
 - Meeting margins used as an indirect risk measure
 - Meeting margins somewhat smaller (ca 0,3 s) for the HCT (not stat. sign.)
 - Meeting margins also influenced by road width and traffic volume
 - Car drivers don't remember that they have passed a longer vehicle

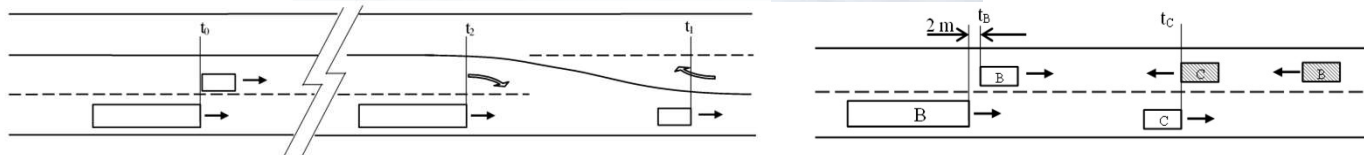

Bicycle study (planned)

Purpose:

- Measure lateral distance and estimate subjective risk perception when bicyclists are passed by longer truck combinations (~32m) on undivided two-lane roads
- Comparison with conventional trucks and passenger cars

Theoretically side forces due to turbulence depend on

- Lateral distance
- Front area of passing vehicle
- Speed of passing vehicle



Interviews with HCT drivers

- Formal and informal demands and instructions
 - Do not exceed 80km/h
 - Carry no overload
 - No accidents or traffic remarks
 - Demands are understood and even appreciated
 - Must plan better and drive without taking risks
- Increased weight and length require more planning when driving
- More axles
 - Increase stability
 - Affect startability on low friction (less load on driving axle) and more wheels to roll
 - Braking capacity is fully adequate
- Appropriate driver characteristics
 - Few years experience
 - Interest in the work and the vehicles
 - Be calm, stress resistant, planning ability, good driving style
- Concerns about traffic diversions in case of accidents or roadwork



Theoretical effect of truck weight in frontal collisions

- The crash violence increases with collision speed and truck weight – up to a certain degree:
 - The truck weight becomes less important at a weight ratio above 1:10
 - Truck weights exceeding 40t have a minor worsening effect

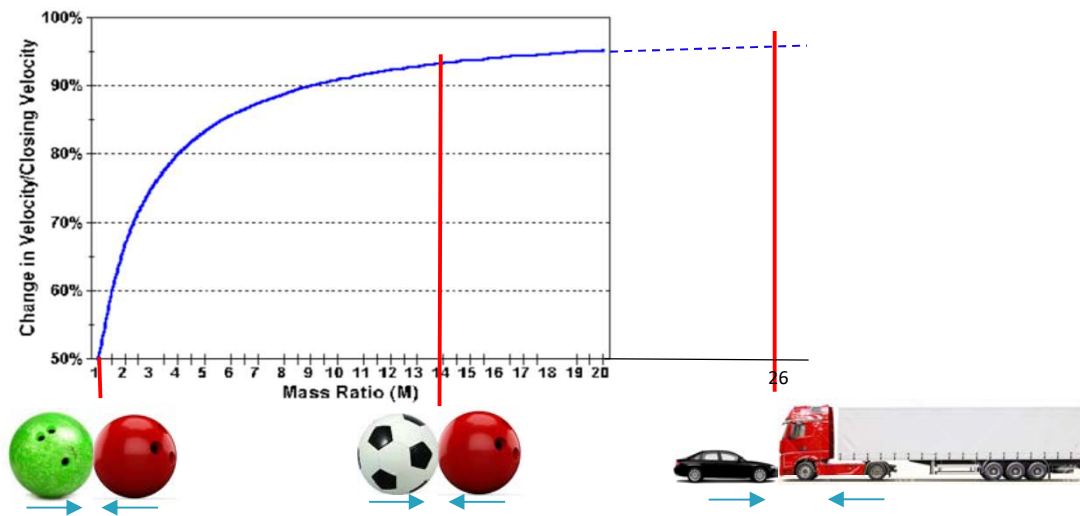

Ongoing survey of accidents with conventional HGVs

- Time period: 2009-2018
- # accidents involving selected HGV combinations: 4 070
- Share of total # accidents (examples):
 - Single: 19%
 - Rear-end accidents where truck is “striking vehicle”: 13.5%
 - Truck has changed lane into adjacent lane: 11%
 - Oncoming accidents where truck went into the opposite lane: 3.5%
- For truck and trailer combinations (24-25.25m):
 - A larger share of single and rear-end accidents are associated with winter road conditions

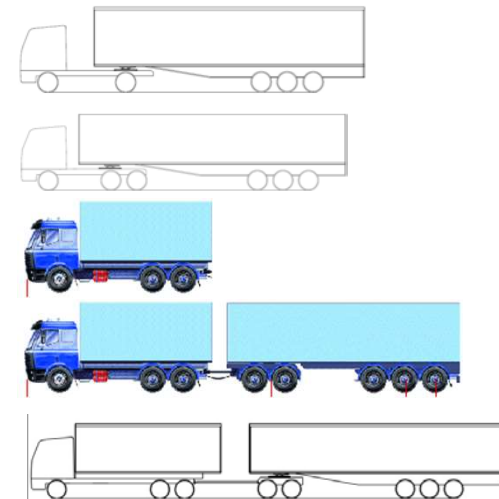

Effect estimation on traffic safety and societal costs

Two examples of studies:

- **USA:** assumption that HCTs would lead to a 10% reduction of total truck travel (Woodroffe 2016)
 - This would generate appr. \$16 billion, save 330 lives and prevent 4 000 injuries per year

- **Sweden** (reversed research question and analysis):
 - If the allowed vehicle dimensions were **reduced** from 25.25m/60t to 18.75m/40t (Vierth et al. 2008):

 - “... would lead to large economic losses. Transport costs would increase in particular, but significant cost increases would also occur in the areas of road safety, exhaust emissions and noise emissions.”

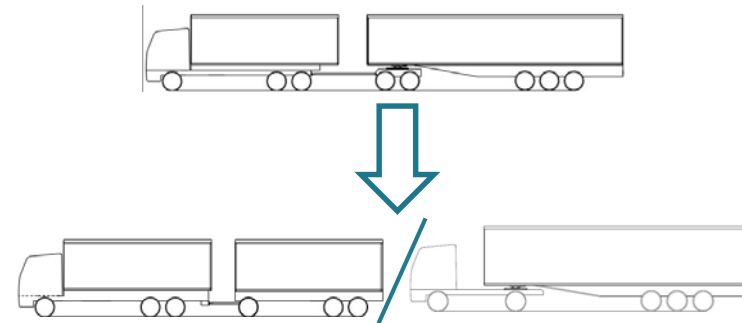
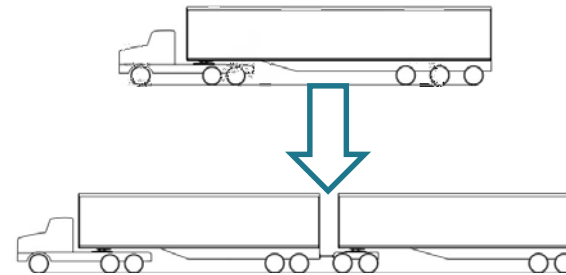

Effect estimation on traffic safety and societal costs

- If HCTs were allowed to various degrees in Sweden? ▪
- Purpose of next study
 - Base the analysis on an ongoing survey of accidents with conv. heavy trucks from 2009 to 2018
 - Focus on combination type and length and correlation with personal injuries (=costs)

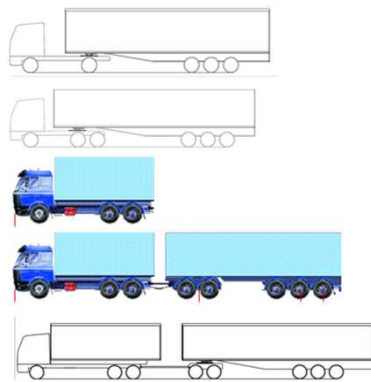

Truck accidents

Questions and assumptions:

- Assume same amount of transported goods and no shifts between modes
- Will the type of transported goods affect the results?
- To what degree can longer HCTs replace conventional trucks of different types?
- On which road categories may longer HCTs be allowed?
- Example: If HCTs are allowed on undivided two-lane roads which are associated with the most severe crashes, then fewer number of trucks would reduce the risk of those crashes.
- However we do not know if HCTs will increase the risk of other types of crashes.

**Presentation: *Remote driving operation*, Lin
Zhao, KTH**



REmote Driving Operation (FFI-REDO)

Real world state feedback for teleoperated drivers

Lin Zhao

PhD student at KTH



SCANIA



ERICSSON

**ITRL — INTEGRATED TRANSPORT
RESEARCH LAB**

KTH ROYAL INSTITUTE OF TECHNOLOGY

Background



Autonomous vehicle

Remote driving



Key problem

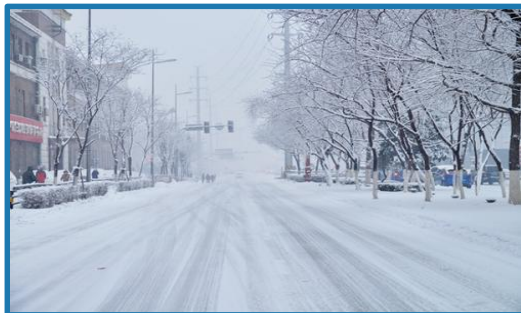

1. https://gimg2.baidu.com/image_search/src=http%3A%2F%2Fimg1.xcarimg.com
2. https://www.google.com/url?sa=i&url=https%3A%2F%2Fsvrigradio.se%2Favsnitt%2F1177213&psig=AOvVaw2wotxWl_maMx2z-9PZGD46&ust=1621936259758900&source=images&cd=vfe&ved=0CqRjRqFwoTCKDcuNaF4vACFQAAAAAdAAAAABAD



SCANIA



ERICSSON

**ITRL — INTEGRATED TRANSPORT
RESEARCH LAB**

KTH ROYAL INSTITUTE OF TECHNOLOGY

Problems in remote driving

Main problems

1. Similar to game and no real world feeling.
Possible method: Steering and seat force feedback
2. Delay problem during the signal transmission.
Possible method: Vehicle dynamic state prediction
3. The vehicle characteristics like speed, yaw rate is different from real driving.
Possible method: Force feedback
4. The driving accuracy could decrease compared with real driving.
Possible method : Remote Advanced Driving Assistant System

Research platform

RCV-E and Driving Simulator.

RCV: Research Concept Vehicle

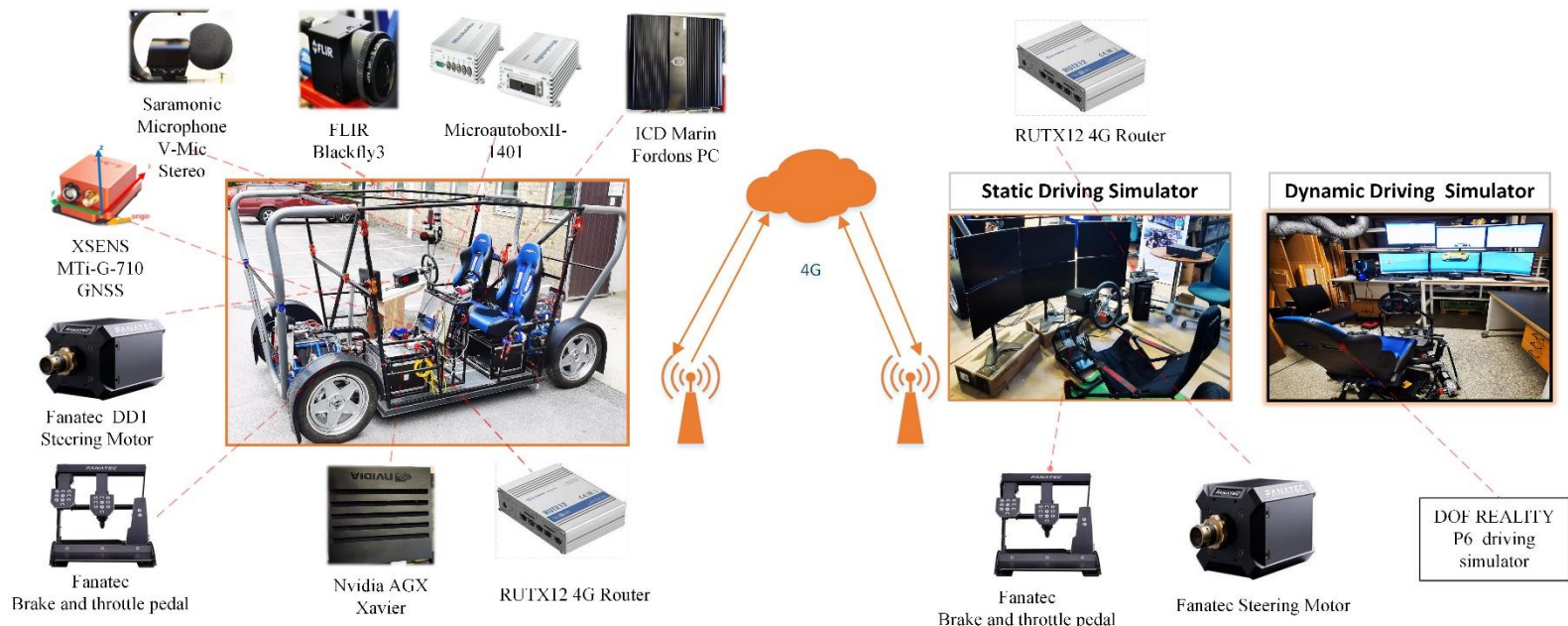

Remote driving platform verification



HIL verification

- This platform is integrated with Carmaker Vehicle Simulation software for Hardware In Loop (HIL) verification.
- The feedback model verification is conducted on CarMaker software based HIL platform before the formal test.



Steering system comparison between remote driving and real vehicle

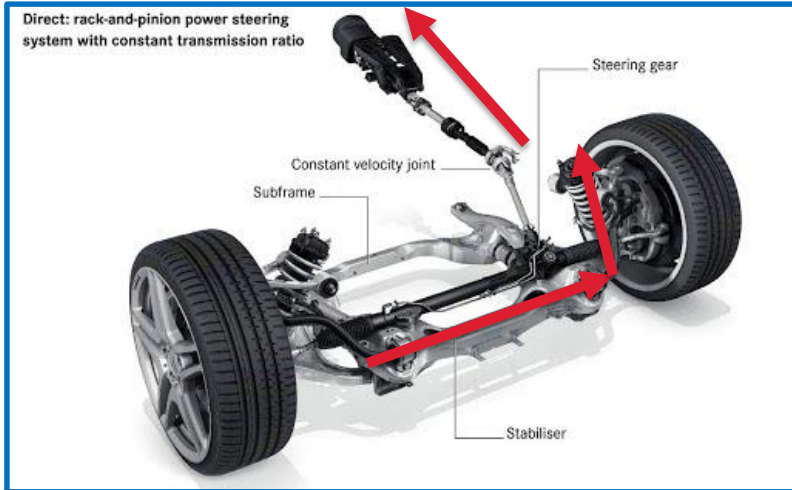

Real vehicle steering system



Remote driving steering system

Key challenge: How to generate the real vehicle feeling in remote driving?

1. <http://blog.autointhebox.com/car-steering-system.html>

Feedback force generation

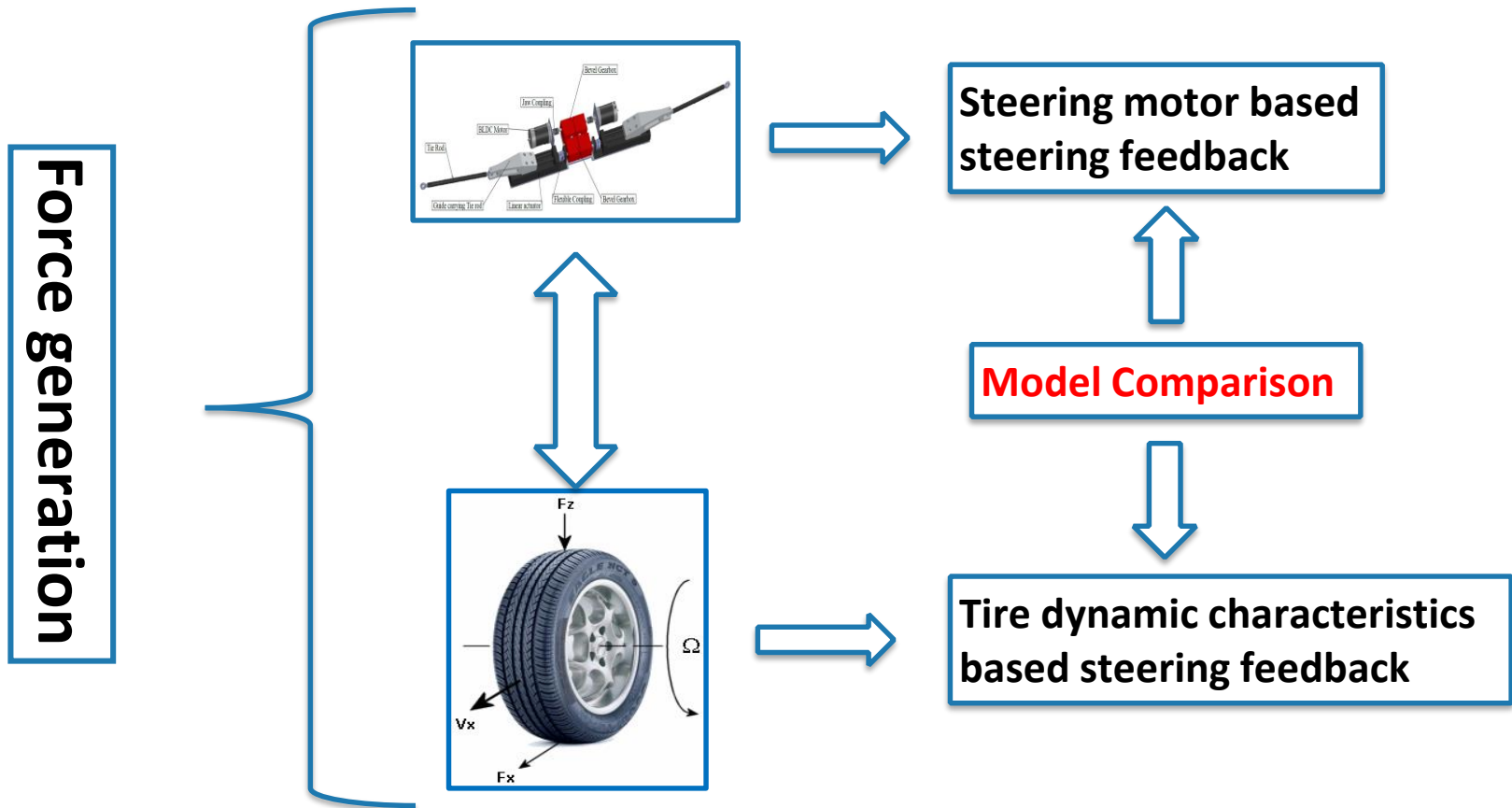

1. <https://www.mathworks.com/help/physmod/sdl/ref/tireroadinteractionmagicformula.html>

Assessment of driver workload

- Hardware setting: the same steering system (Logitech G29)
- Subjective assessment: Safety, ease of use, real world feeling and so on.
- Objective assessment: Driver EEG signal, Heart rate change, SRR.



Test arrangement

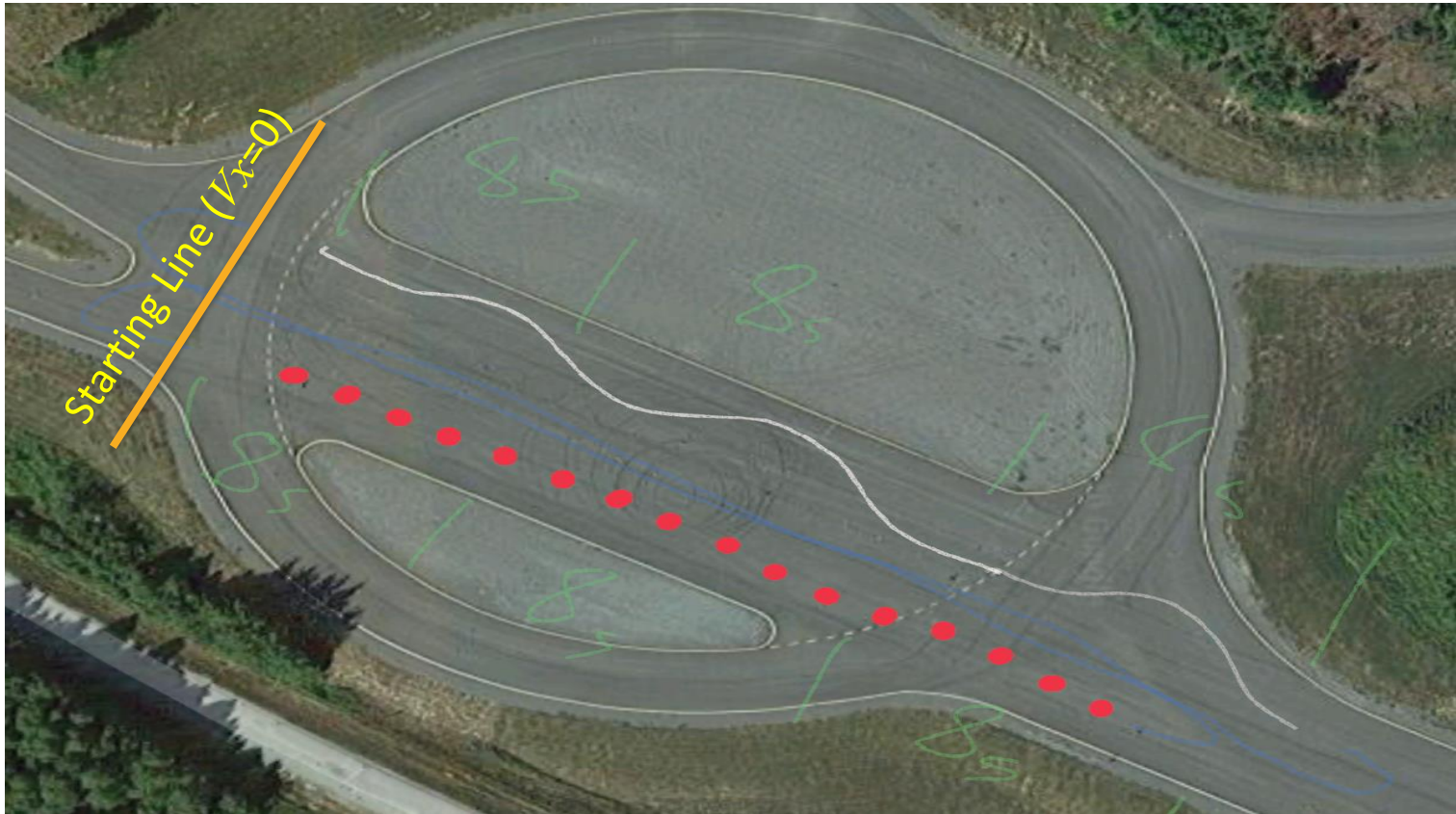

Driver learning rate (Pre-test)

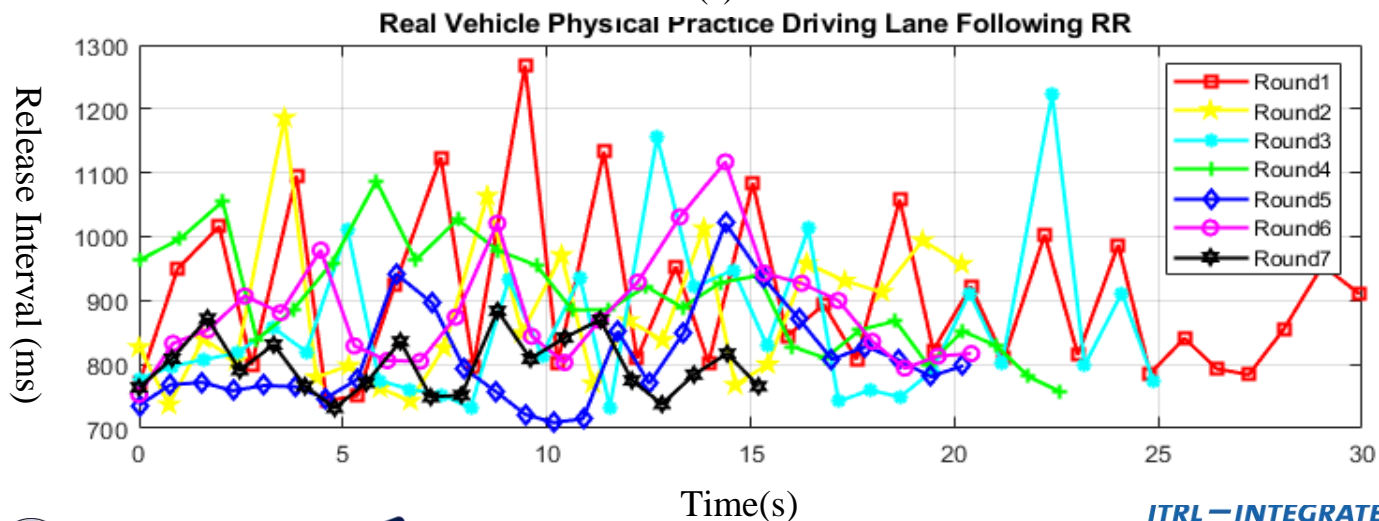
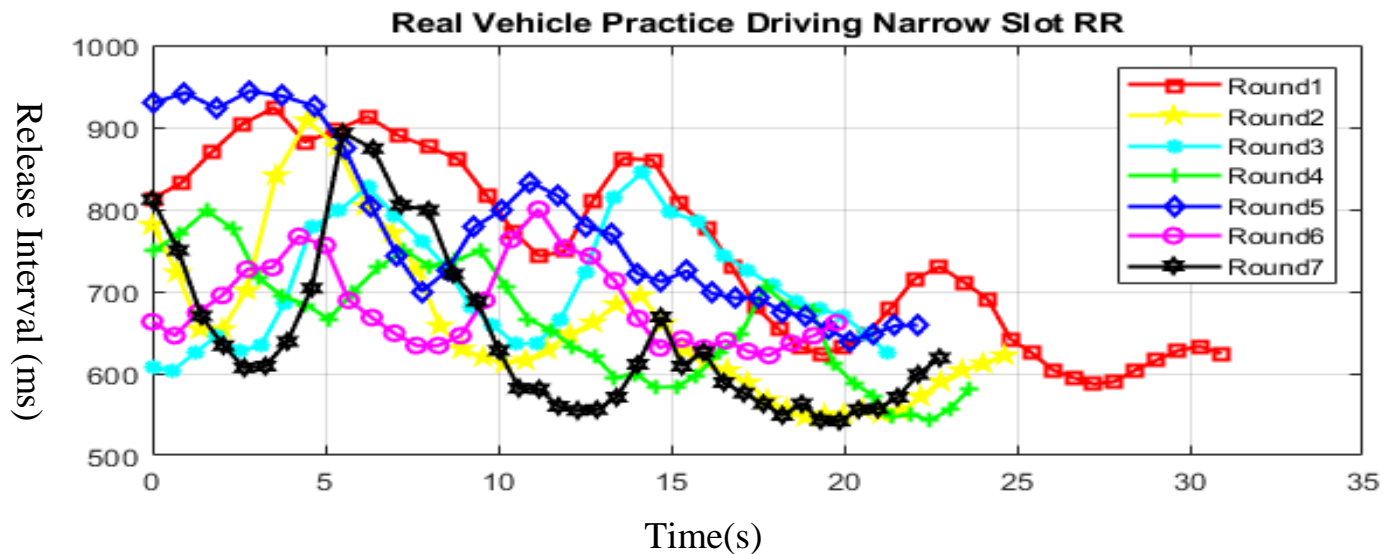



Driver learning rate with EEG signal (Pre-test)

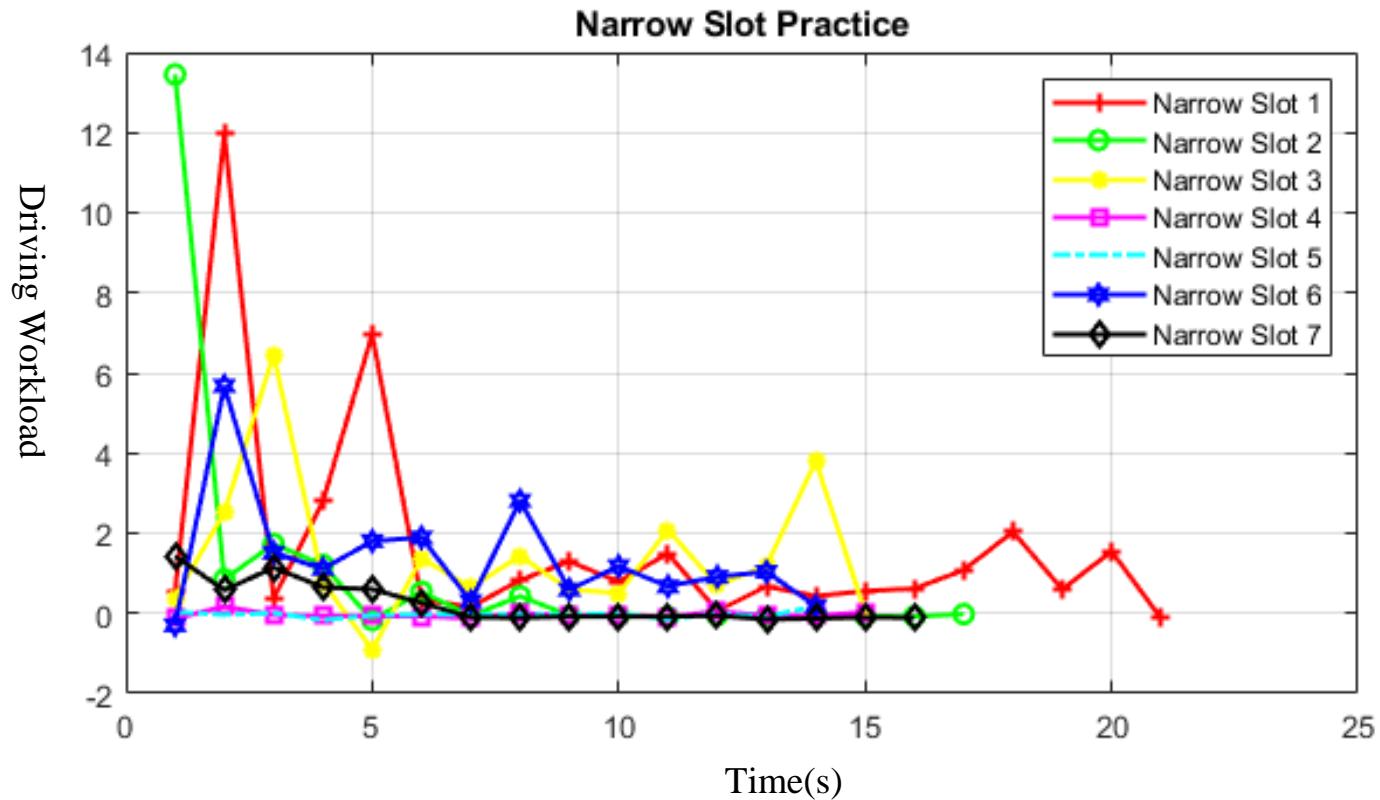

Future plan

1. Formal test at Arlanda Test Track

- Professional drivers to feel the differences between models.
- More participants to verify the data collection of workload between models.
- Investigating the difference of path following accuracy between remote driving and real driving.

2. Road type based feedback force generation



Broken road



Tarmac road



Cobblestone road



Forest road

1. The role of the scale and the frequency bandwidth of steering wheel vibration on road surface recognition. *8th International Symposium on Advanced Vehicle Control (AVEC '06)*, Taipei, Taiwan, Aug 20-24th 2006,



Question and Discussion



***ITRL — INTEGRATED TRANSPORT
RESEARCH LAB***

KTH ROYAL INSTITUTE OF TECHNOLOGY



Thank you for your listening



SCANIA



ERICSSON

***ITRL — INTEGRATED TRANSPORT
RESEARCH LAB***

KTH ROYAL INSTITUTE OF TECHNOLOGY

**Presentation: *Automated Comfortable
Docking at Bus Stops*, Amal Elawad, Volvo
Buses/Chalmers**



CHALMERS
UNIVERSITY OF TECHNOLOGY

Automated Comfortable Docking at Bus Stops

Amal Elawad, PhD student | Systems and Control Division, Electrical Engineering Department | 26.05.2021



CHALMERS
UNIVERSITY OF TECHNOLOGY

Project Team



Amal Elawad

Doctoral student



Nikolce Murgovski
Associate Professor



Mats Jonasson
Senior Researcher



Bengt J H Jacobson
Full Professor



Jonas Sjöberg
Full Professor

Agenda

- **Project description.**
- Problem statement.
- The comfort model.
- Optimization problem formulation.
- Results: simulations and experiments.



Project Description

Bus stop docking

1

Docking stops

1



Depot process

2

Depot process

2



Bus train

3

Bus trains

3





Project Description

Bus stop docking

1

Docking stops

1



Depot process

2

Depot process

2



Bus train

3

Bus
trains

3



Project Description

Bus stop docking

1



1.1. Autonomous docking
(geometric constraints): accepted
paper at ECC21.



1.2. Automated comfortable docking
(comfort constraints)

Agenda

- Project description.
- **Problem statement.**
- The comfort model.
- Optimization problem formulation.
- Results: simulations and experiments.



CHALMERS
UNIVERSITY OF TECHNOLOGY

Why optimizing comfort?

- System performance (e.g., fuel consumption, parking time) can be improved by higher acceleration/deceleration than normal.
- However, the risk of passengers losing their balance is increased, especially for standing passengers.

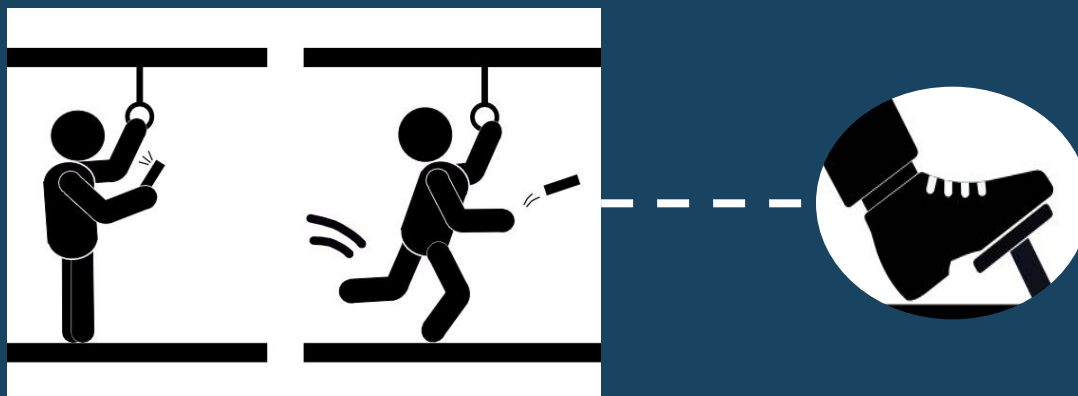



Why optimizing comfort?

- System performance (e.g., fuel consumption, parking time) can be improved by accelerating/decelerating.
- However, the risk of passengers losing their balance is increased, especially for standing passengers.
- Ride comfort is a combined effect of acceleration and jerk (coupled).
- A comfort model is needed.

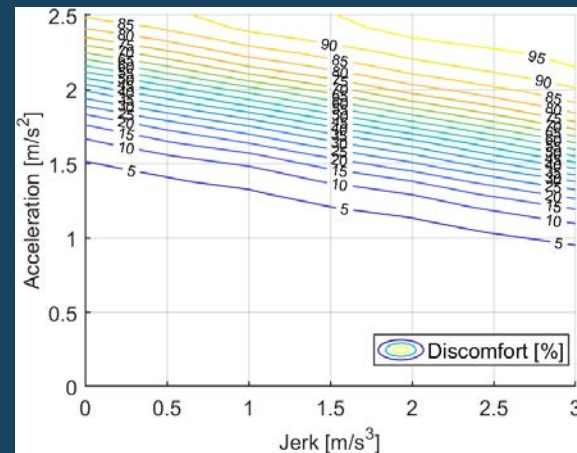

Acceptability of discomfort rated by passengers given in percentage. The higher is the least acceptable. [1]

Agenda

- Project description.
- Problem statement.
- **The comfort model.**
- Optimization problem formulation.
- Results: simulations and experiments.

The comfort model

- Derived by fitting the data in [1] to a curve.
- Resulting curve: a function that couples the effect of acceleration and jerk:

$$dis(s, a, j) = \frac{A_2 Q_1}{A_2 Q_2 + e^{-(A_1 Q_3).a}}$$

$$A_1 = [1, j, j^2]$$

$$A_2 = [1, j, j^2, j^3]$$

Q_1, Q_2, Q_3 : constant coefficient vectors

s, a, j : point on path, acceleration, and jerk

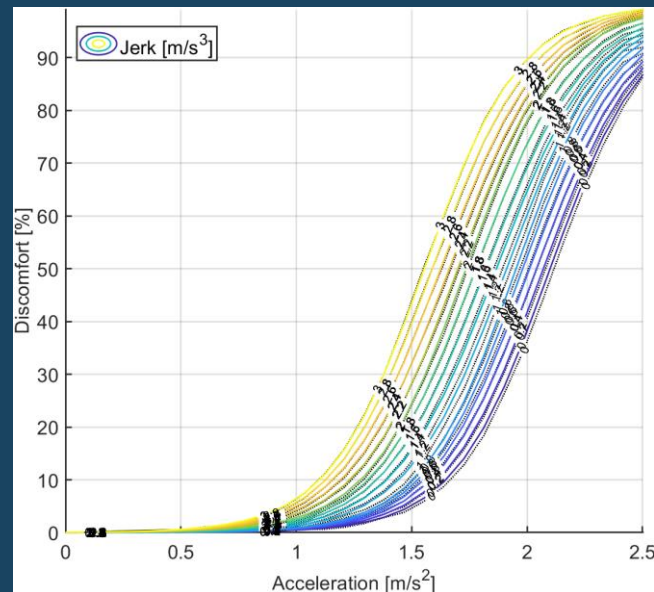

Acceptability of discomfort rated by passengers given in percentage [1]

Agenda

- Project description.
- Problem statement.
- The comfort model.
- **Optimization problem formulation.**
- Results: simulations and experiments.

The Vehicle model

- Kinematic bicycle model.
- Assumptions: front-steered (city bus), no tire slip (simplification).

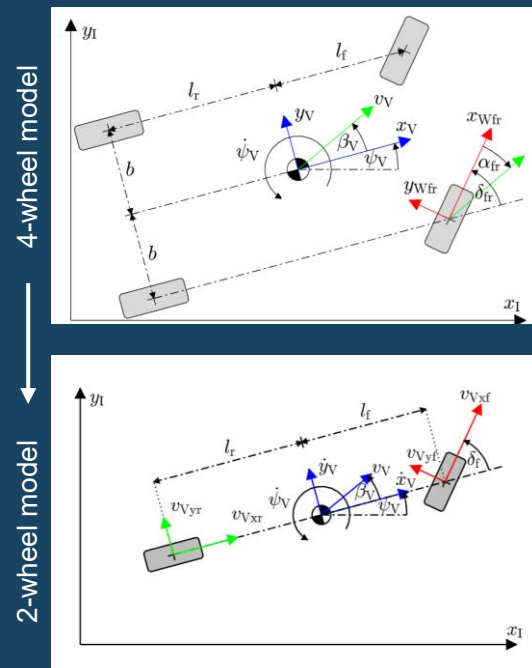

The bus stop geometry

- Location: at Arendals Skans bus charging station.



 Start

 End



CHALMERS
UNIVERSITY OF TECHNOLOGY

The bus stop geometry



Arendals Skans bus stop (Google maps)

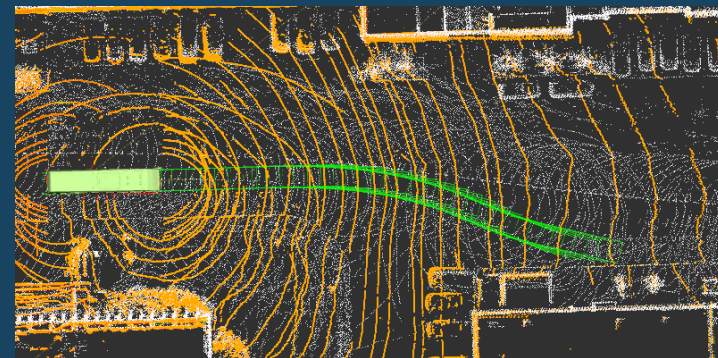

Path as seen from the bus navigation system

The Optimal Control Problem (OCP)

- The objective function minimizes:

$$J(\mathbf{x}, \mathbf{u}, z) = \underbrace{\|\mathbf{x}(s_f) - \mathbf{x}_f\|_{Q_f}^2}_{\text{Deviation from a target final state}} + \underbrace{z}_{\text{Discomfort}} + \underbrace{\int_0^{s_f} \|\mathbf{u}(s)\|_R^2 \cdot ds}_{\text{Actuator usage}}$$

Q_f, R : weighting matrices

The Optimal Control Problem (OCP)

- The objective function.
- The nonlinear control problem (NLP)

$$\min_u \tilde{J}(x, u, z)$$

subject to

Dynamics ← $x(k+1) = \tilde{f}(x(k), u(k)), \quad k = 0, \dots, kf - 1$

Road geometry ← $g(x, k) \leq 0, \quad k = 1, \dots, kf$

States and inputs $\left\{ \begin{array}{l} x_{min}(k) \leq x(k) \leq x_{max}(k), \quad k = 1, \dots, kf \\ u_{min}(k) \leq u(k) \leq u_{max}(k), \quad k = 0, \dots, kf - 1 \end{array} \right.$

Discomfort ← $\xi_{min}(k) \leq \xi(k) \leq \xi_{max}(k), \quad k = 0, \dots, kf - 1$

Initial states ← $x(0) = x_0$

Agenda

- Project description.
- Problem statement.
- The comfort model.
- Optimization problem formulation.
- **Results: simulations and experiments.**

Simulation results

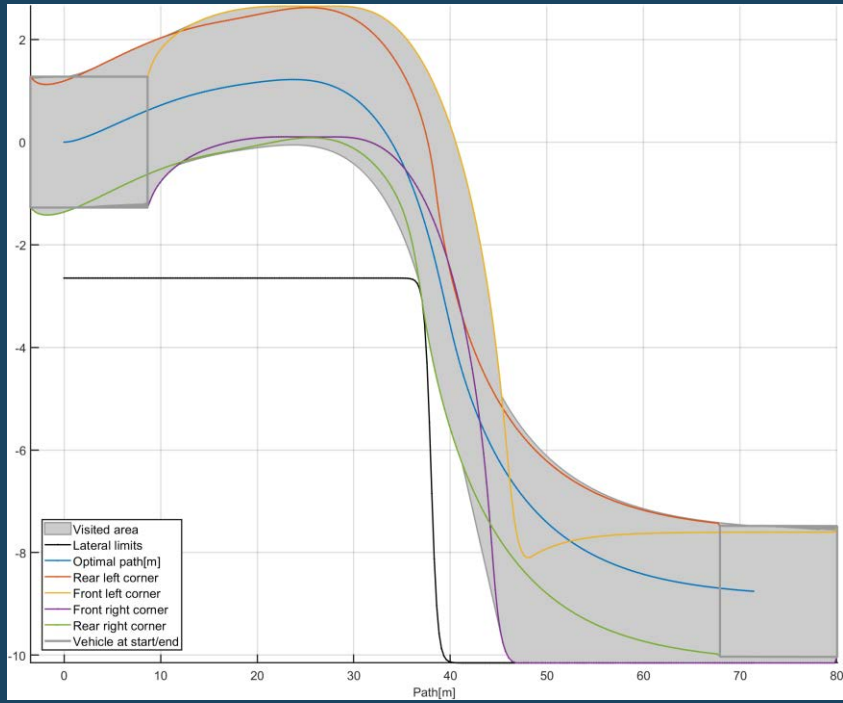

Simulated optimized trajectory

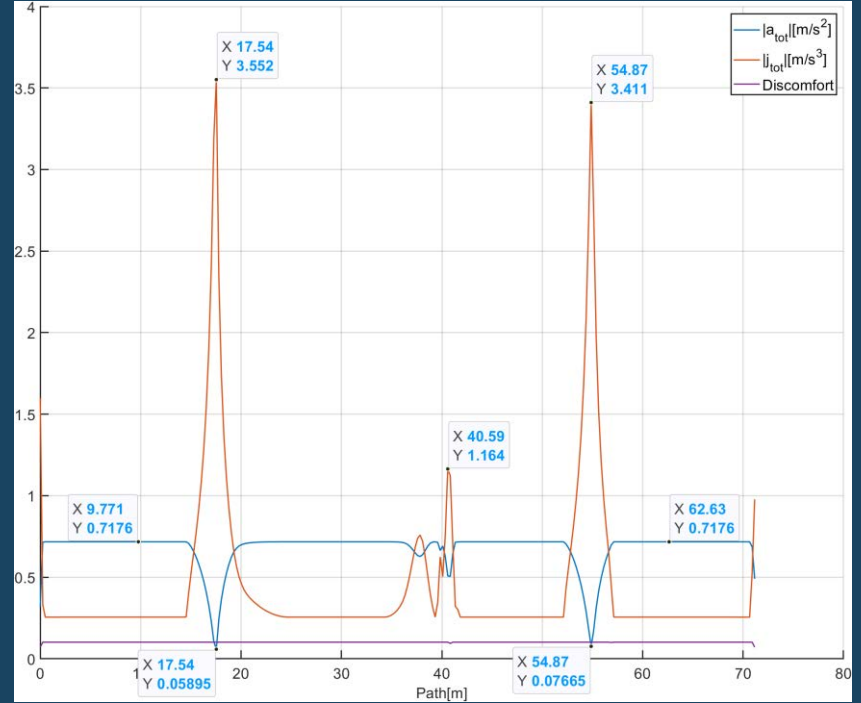

Total acceleration, total jerk, and discomfort profile

Simulation results

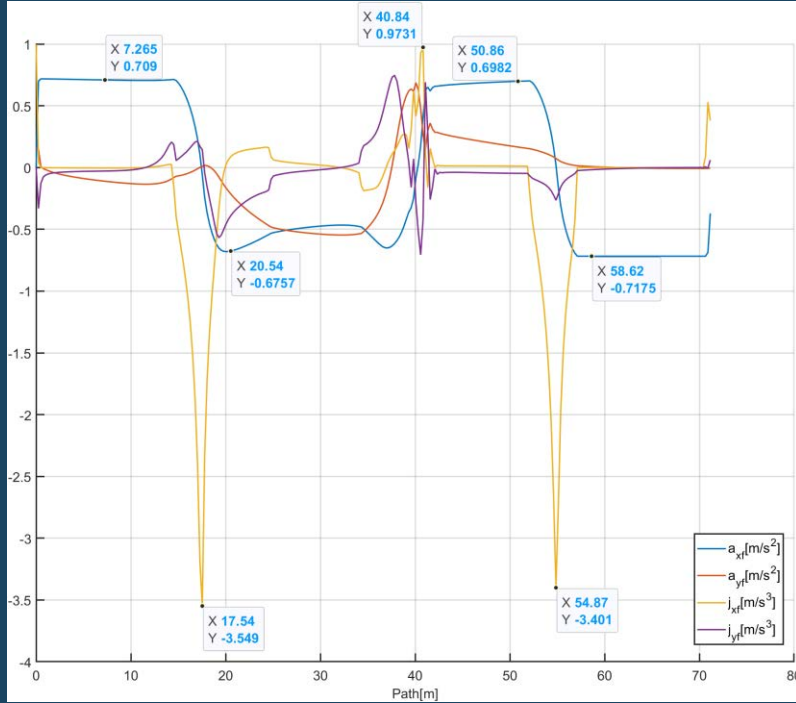

Acceleration and jerk (longitudinal and lateral)

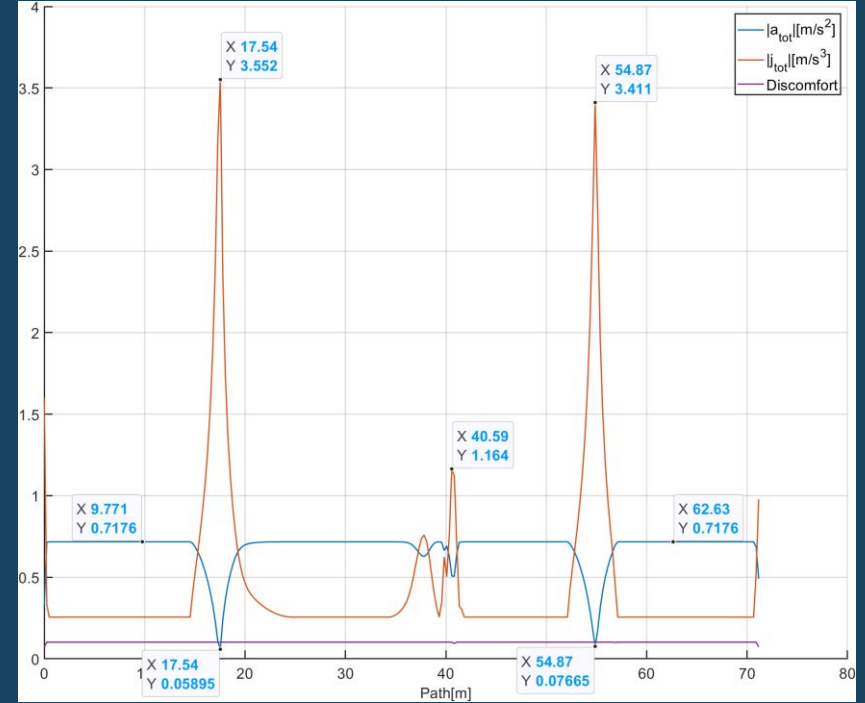

Total acceleration, total jerk, and discomfort profile

Simulation results

(video)

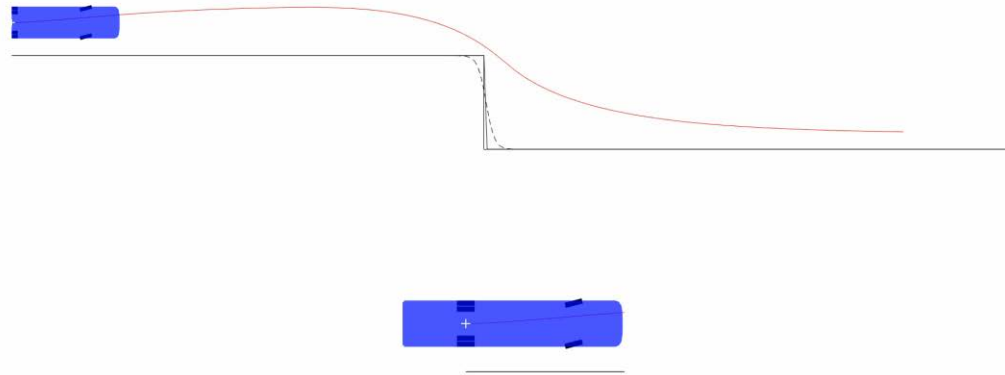

(video)

Experiments

The autonomous trajectory was loaded, and comfort was assessed by 2 passengers standing approximately at the middle of the bus. (see the video)

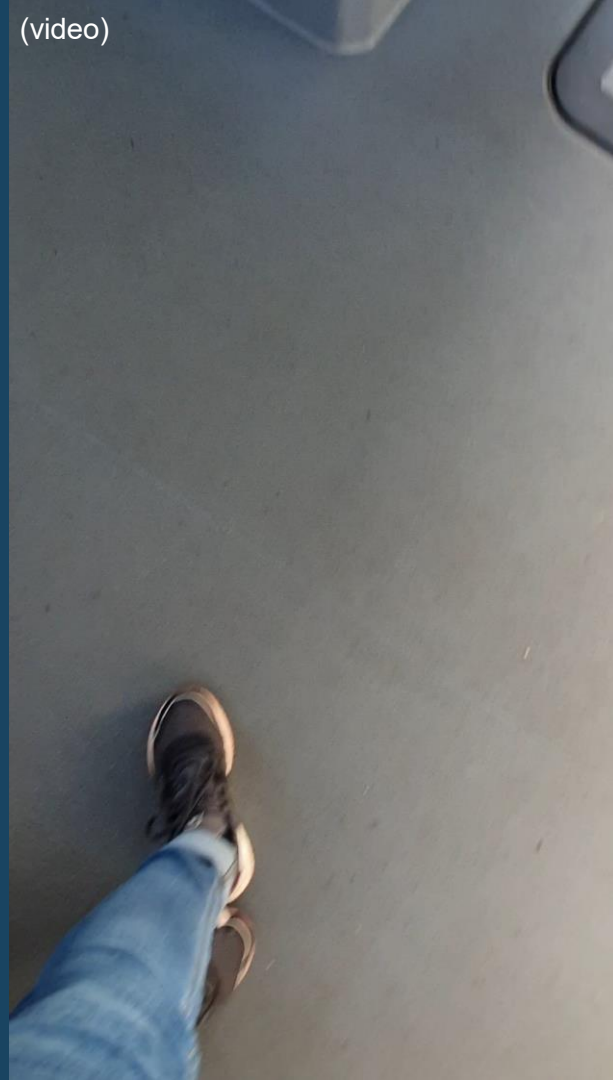
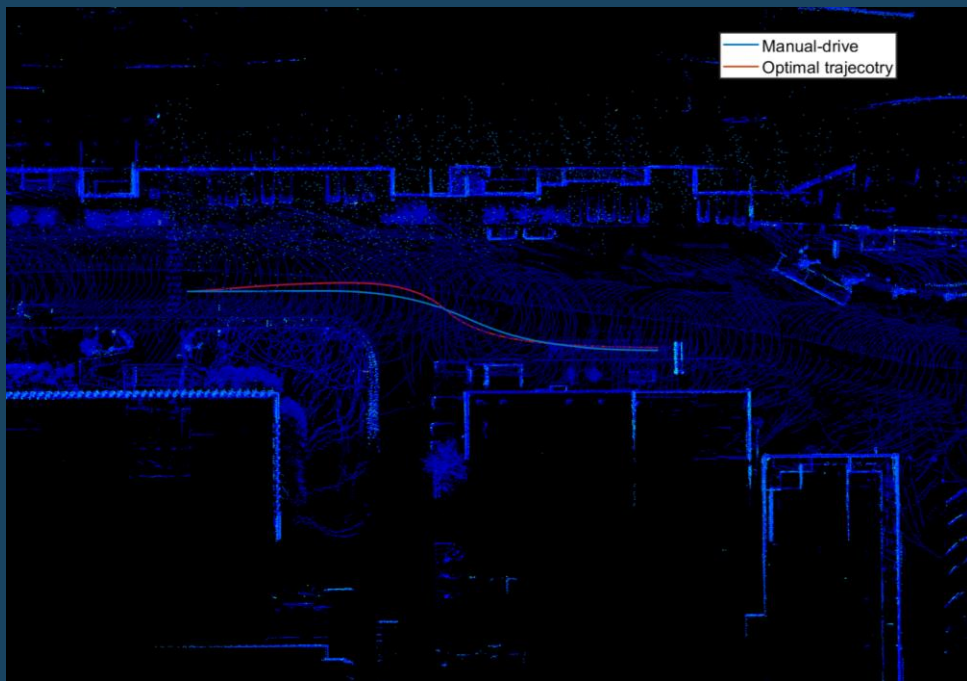

Optimal vs. manual drive

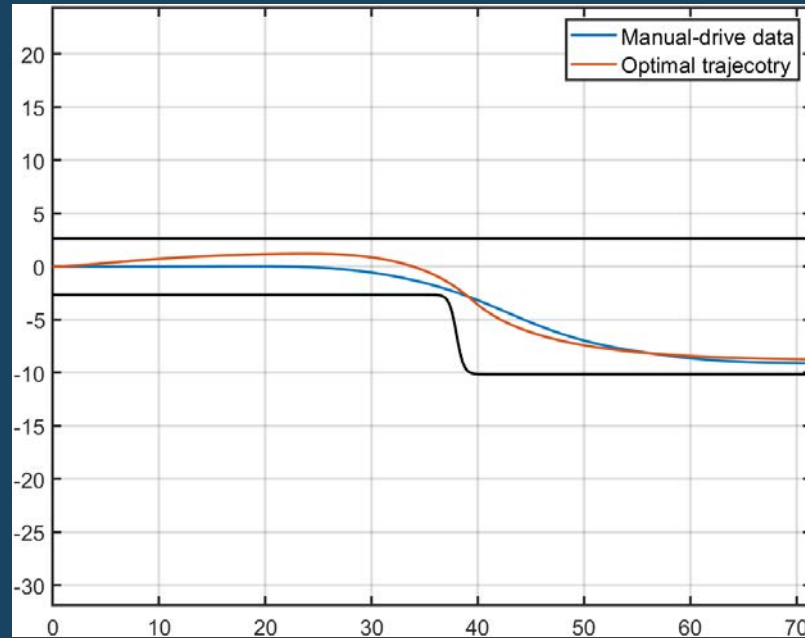

Manual vs. optimal trajectory

Optimal vs. manual drive

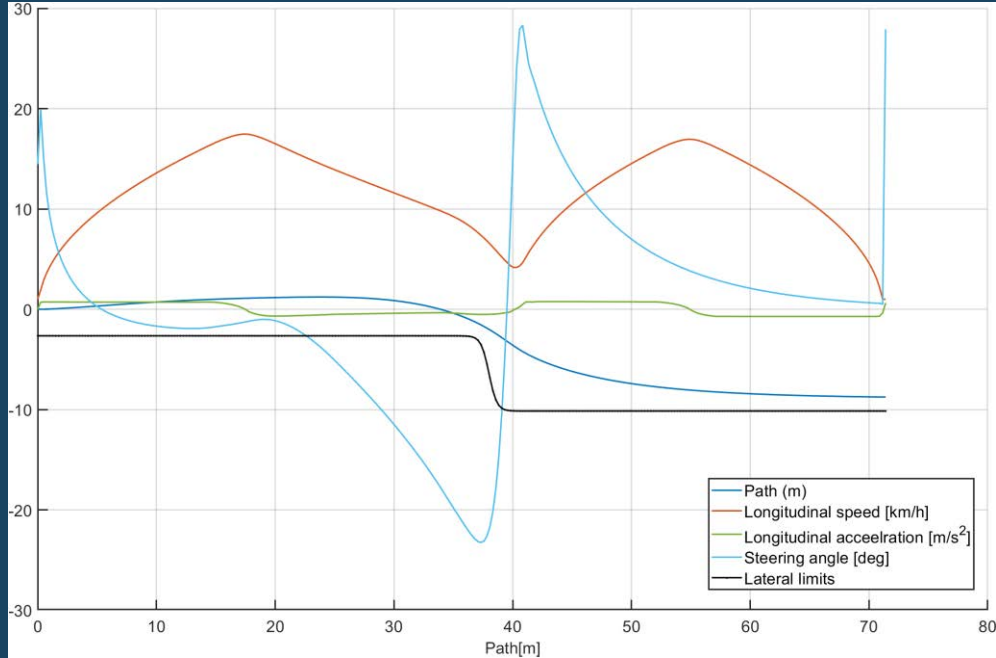

Simulation: notice the speed profile around the beginning of the bus stop

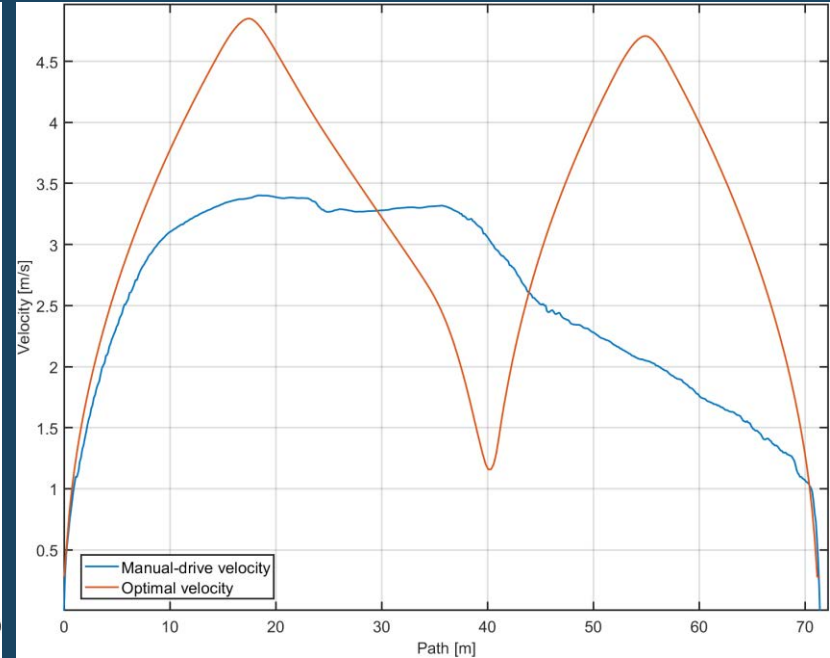

Speed profile of manual vs. optimal trajectory



CHALMERS
UNIVERSITY OF TECHNOLOGY

How to proceed from here?

- Plans are made for further tests at Volvo, to log the acceleration data.
- A quantitative evaluation of the discomfort is needed, to compare simulations to experimental data.



Acknowledgements

- This project is supported by the Swedish State Innovation Agency, VINNOVA and Region Västra Götaland.
- Special thanks to **Joakim Jonasson** from Volvo Buses for technical support and bus operation.

Thank you!

amal.elawad@chalmers.se



CHALMERS
UNIVERSITY OF TECHNOLOGY

Presentation: Alternative Input Devices for Steer-by-Wire Systems, Matthijs Klomp, VCC

V O L V O

ALTERNATIVE INPUT DEVICES FOR STEER-BY-WIRE SYSTEMS

Viktor Alkelin & Casper Christiansen
Master Thesis Students
Linköping University

2020.04.29

Project requirements

- Provide a solution for manual steering in autonomous cars
- Minimal space-usage and modification to the vehicle interior
- Should be able to handle parking and low speed maneuvers safely

Hardware

- Brushless DC motor with Hall sensors and encoder
- Planetary gearbox 33:1
- Torque sensor emulator
- Vector VN8911

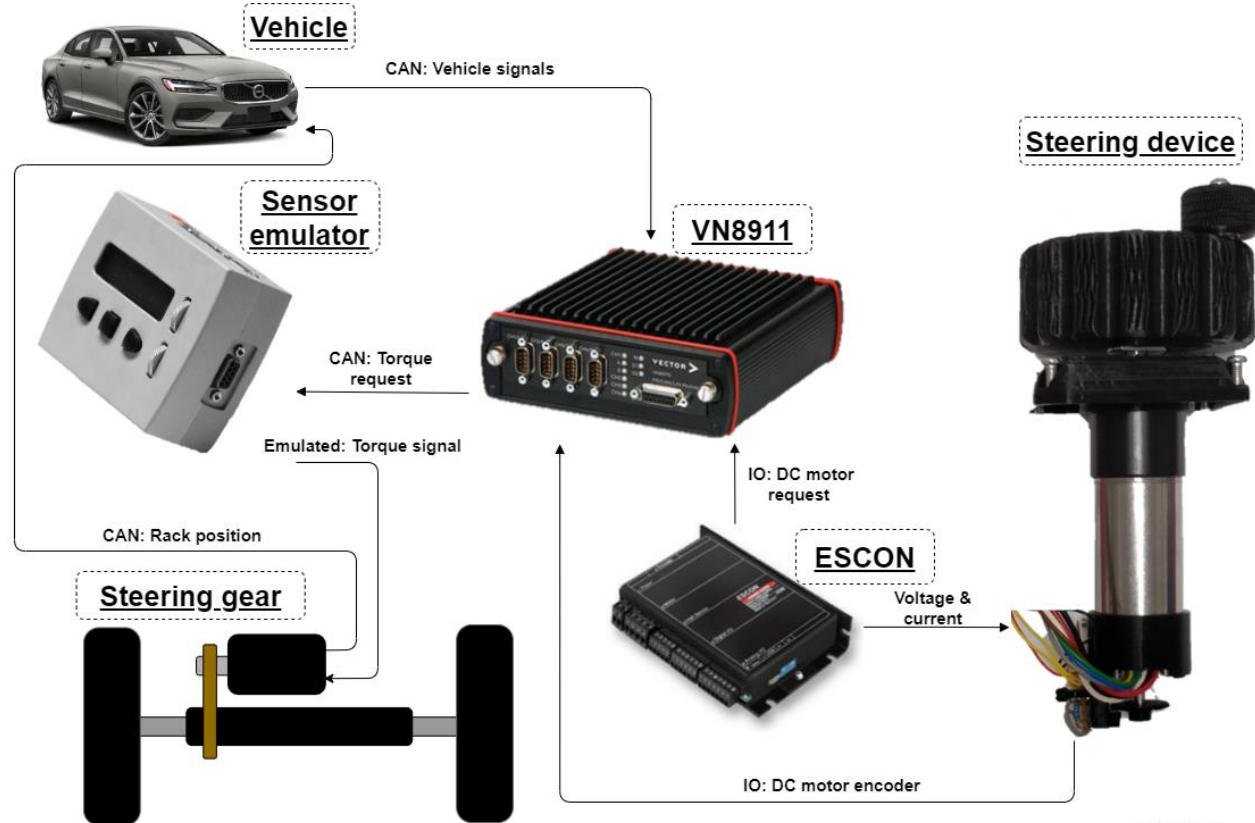

EPOS4 EB Micro

Part number 638677



Control strategy

Open-loop speed control strategy

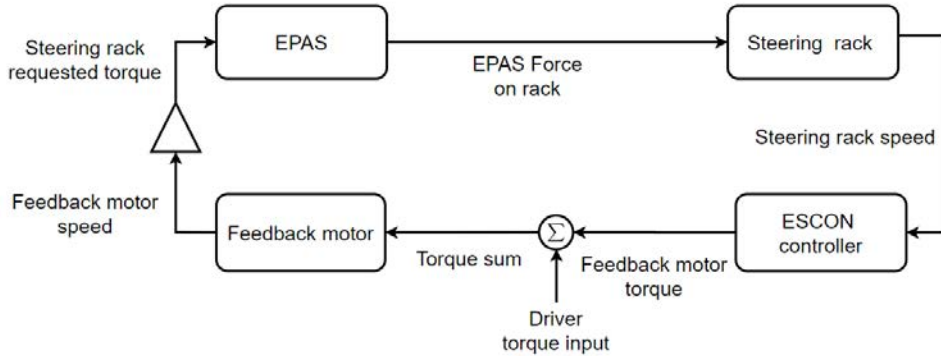

Closed-loop angular control strategy

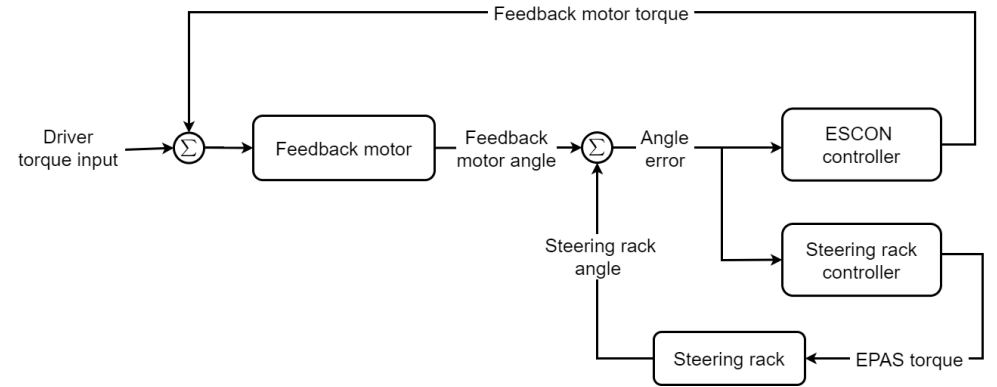

Prototype

- “Plug and play” for the Volvo SPA-platform
- Only minor modification to the steering gear





User study

43 people here at Volvo,
25 of which answered the evaluation form

- In what scenario do you see yourself driving a car with an alternative steering device?

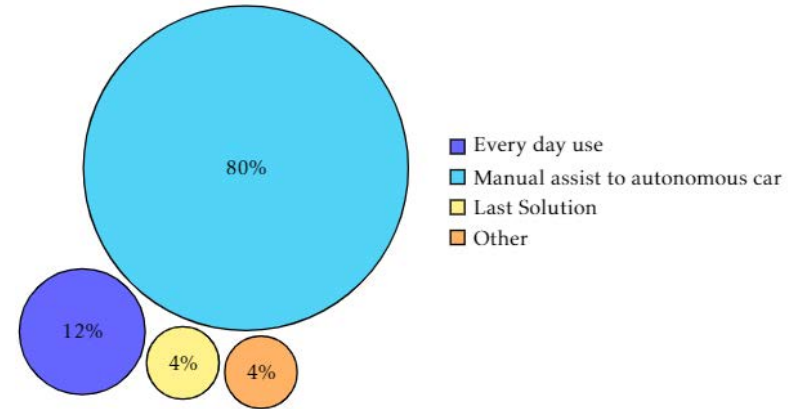

Note: The answer *Never* had zero responses and were excluded

Figure 6.4: In what scenario do you see yourself driving a car with an alternative steering device?

- What did you think about the driver experience?

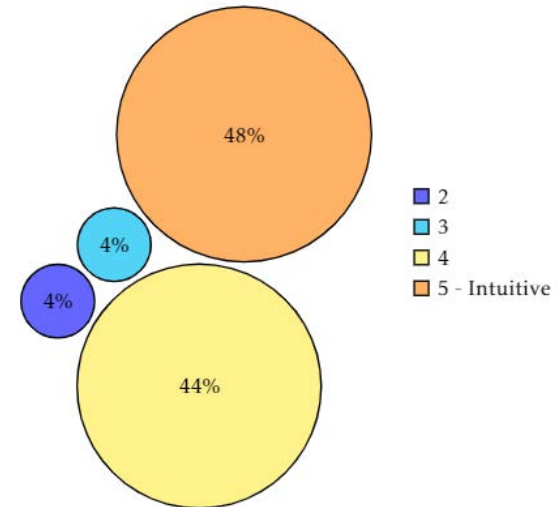

Note: The answer 1 - *Non-intuitive* had zero responses and were excluded

Hällered proving grounds

Narrow slalom

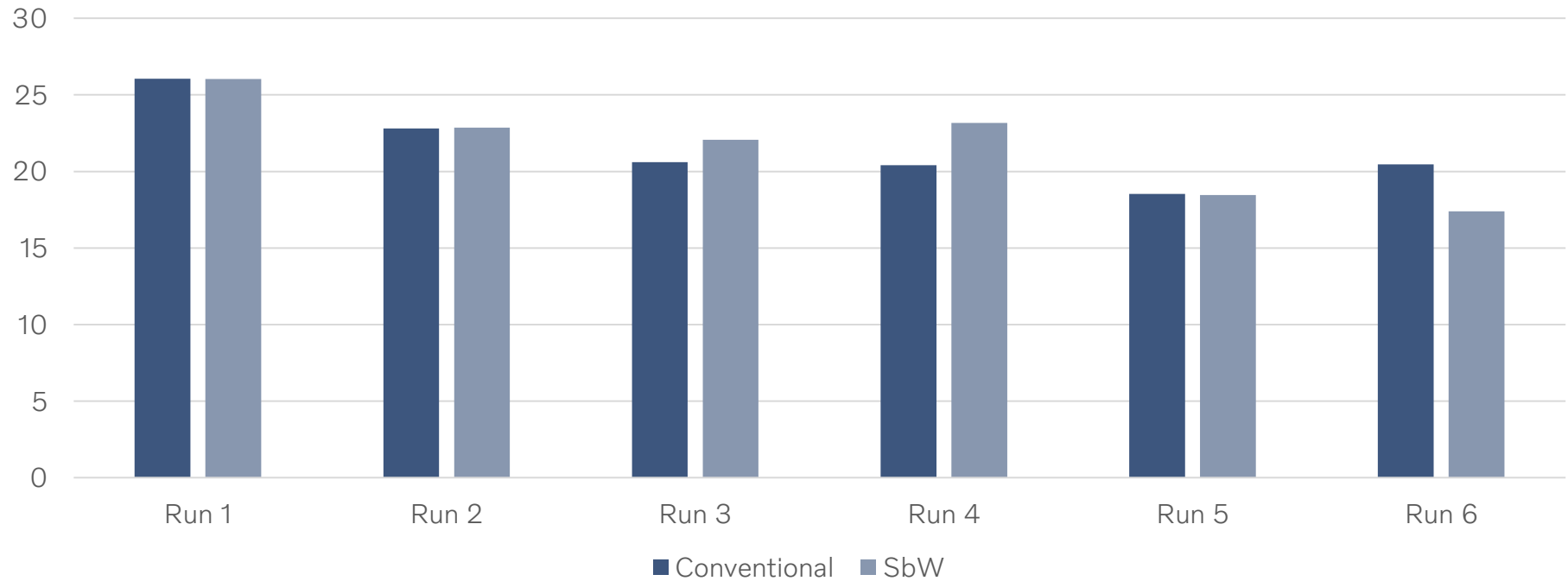

VOLVO

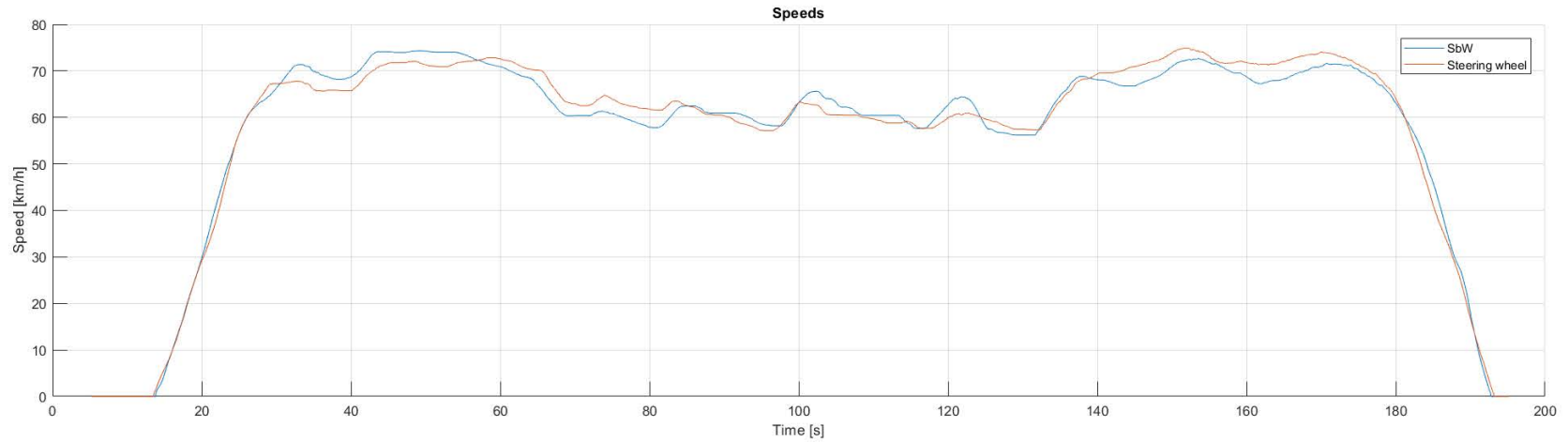
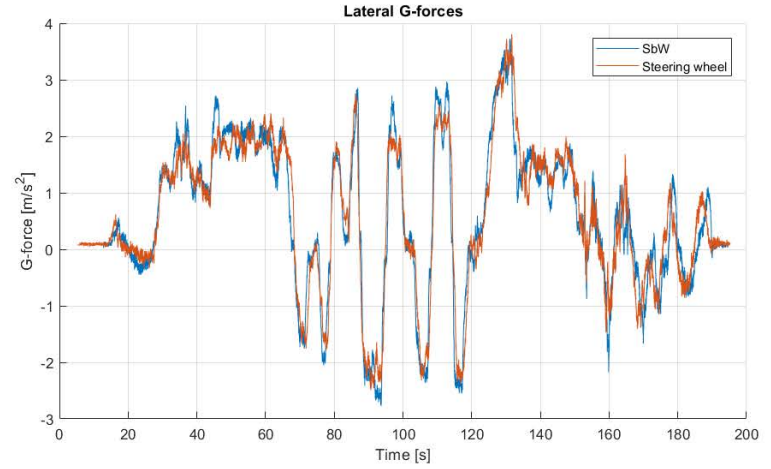
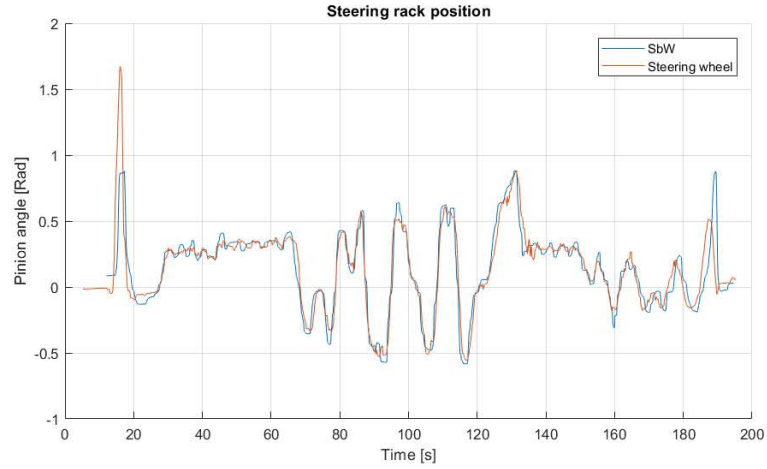



Thank you

**Presentation: Front seat
Passenger experience of ride comfort
in passenger cars, Xiaojuan Wang, CEVT &
Chalmers**

Ride comfort in future mobility

Xiaojuan Wang

Industrial PhD Candidate

xiaojuan.wang1@cevt.se

xiaojuan@chalmers.se

+ 46 (0)72 18 43 544



TEAM · Chalmers University of Technology



Anna-Lisa Osvelder

Professor in Design & Human Factors

- *Sustainable urban mobility*
- *Safe and efficient human machine systems*
- *Sustainable product use*
- *Healthy work system and ergonomics*



Patrik Höstmad

Associate Professor in Applied Acoustics,

- *Urban Sound Environments*
- *Rolling Noise, Rolling Resistance and Safety*
- *Vehicle Acoustics*
- *Human Perception of Sound and vibrations*
- *Sound Design and Audio Technology*

TEAM · CEVT

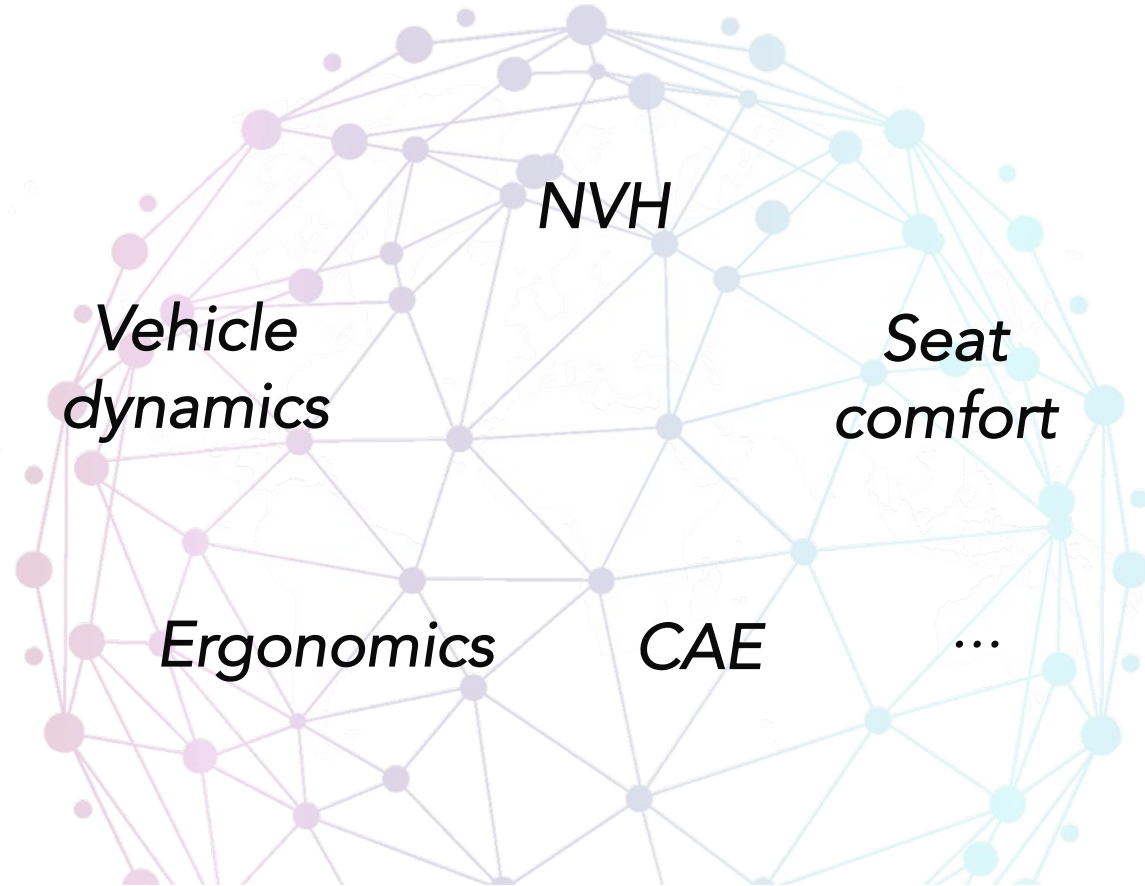

Factors of Ride Comfort

Ambient Factors

- Sounds
- Air quality
- Pressure Gradients
- Thermal
- Lighting

Ergonomics Factors

- Seat Architecture
- Seat-Human interaction
- Functionality
- Visibility

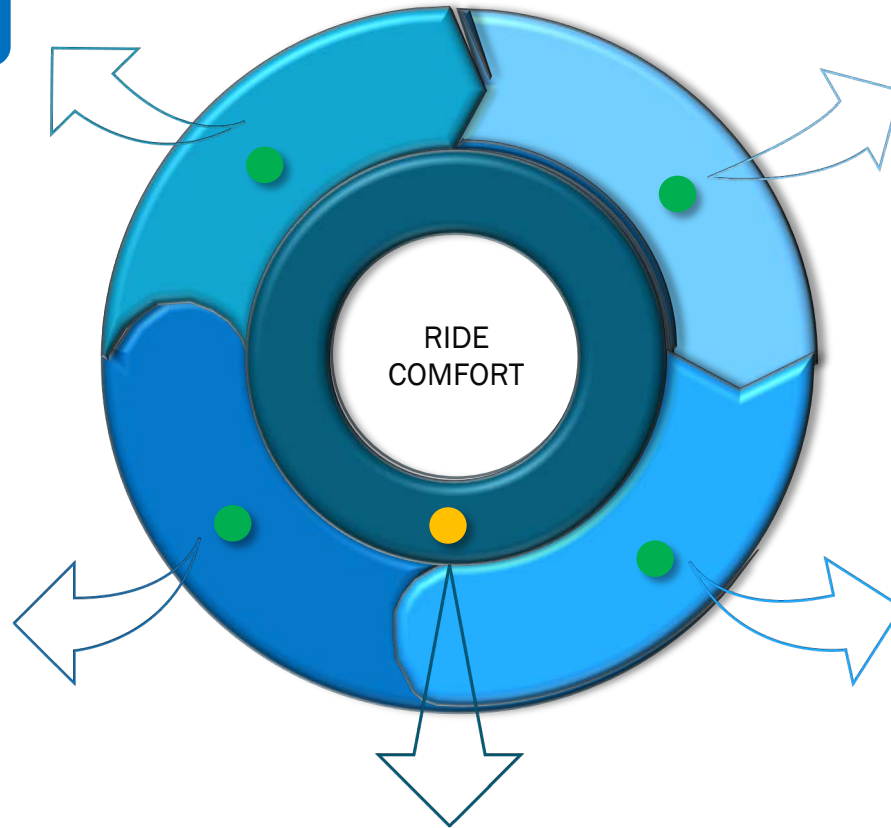

Dynamic Factors

- Accelerations
- Shocks
- Vibrations
- Ride motions

Multi Stressor

- Global Comfort
- Vibrations & Visibility
- Vibrations & Noise

Human factors

———— User study · Ride comfort and NVH ————

- *single factor*
- *single driving scenario*
- *conventional*

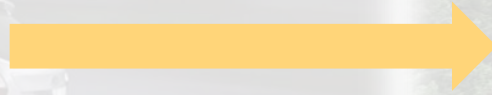

- *simultaneous factors*
- *real-world driving scenarios*
- *conventional v.s. electrical*

User study · Ride comfort and NVH

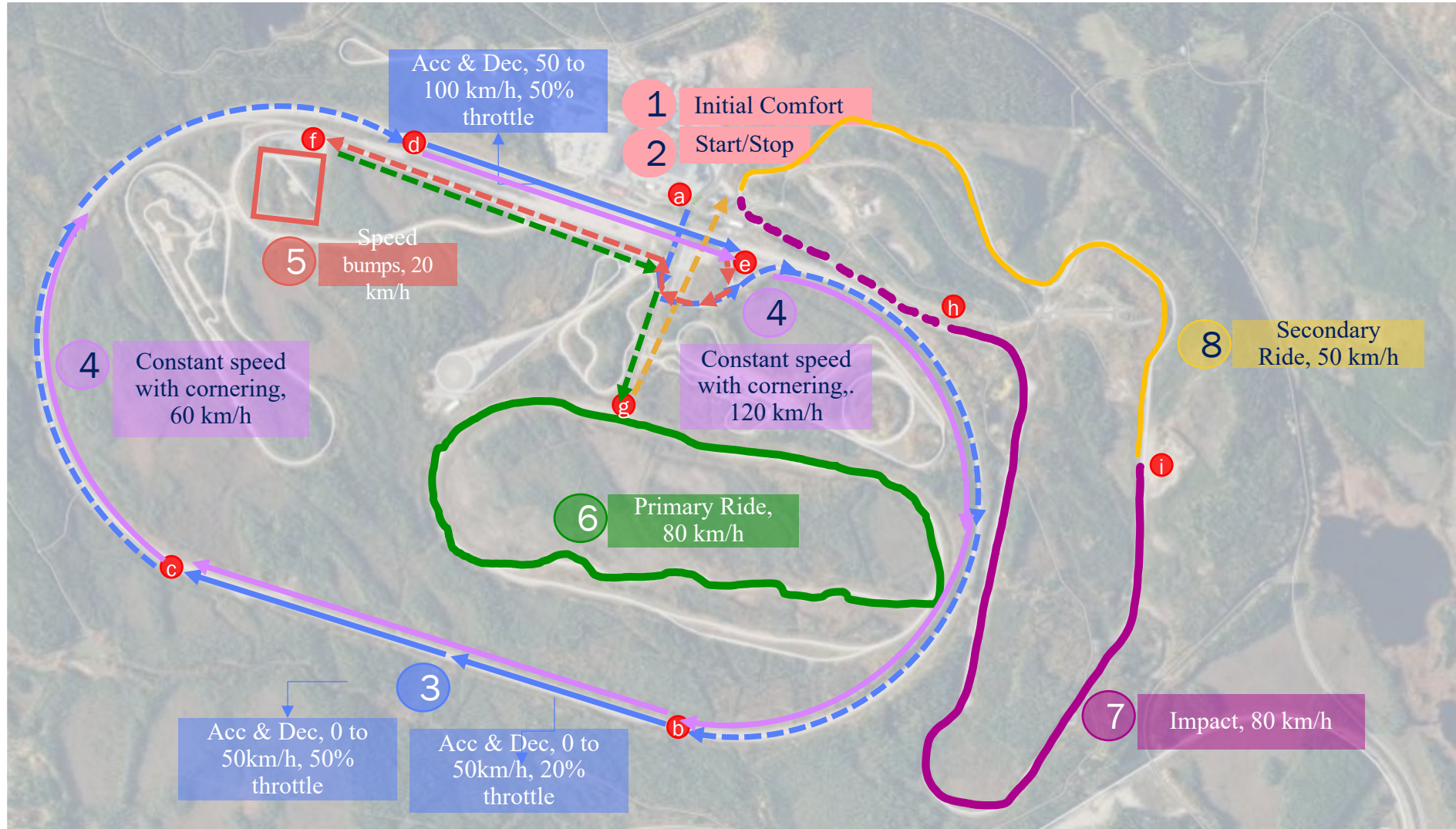





———— User study · Ride comfort and NVH ————

- *How to assess comfort and discomfort?*
 - *comfort*
 - *well-being and relaxation*
 - *not change with time*
 - *discomfort*
 - *physical constraints, poor biomechanics, NVH*
 - *accumulate with time*
 - *15–20 minutes*





———— User study · Ride comfort and NVH ————

- *What to assess in the questionnaires?*
 - *static comfort*
 - *ingress, roominess, visibility*
 - *seat adjustment, seat support*
 - *seat belt adjustment, seat belt position*
 - *air quality, lighting, temperature*
 - *dynamic discomfort*
 - *roominess, relaxed position*
 - *seat support*
 - *seat belt constrain, seat belt position*
 - *vibrations*
 - *sounds*

1.4 How do you feel when you are sitting in this car seat?

	-2	-1	0	1	2	
Tense						Relaxed

2.1 How annoyed did you feel when you heard the sounds?

	-2	-1	0	1	2	
Extremely annoyed						Not Annoyed at all

———— User study · Ride comfort and NVH ————

- *What to discuss in the follow-up interview?*
 - *the experiences of overall ride comfort*
 - *the reasons for the rating*

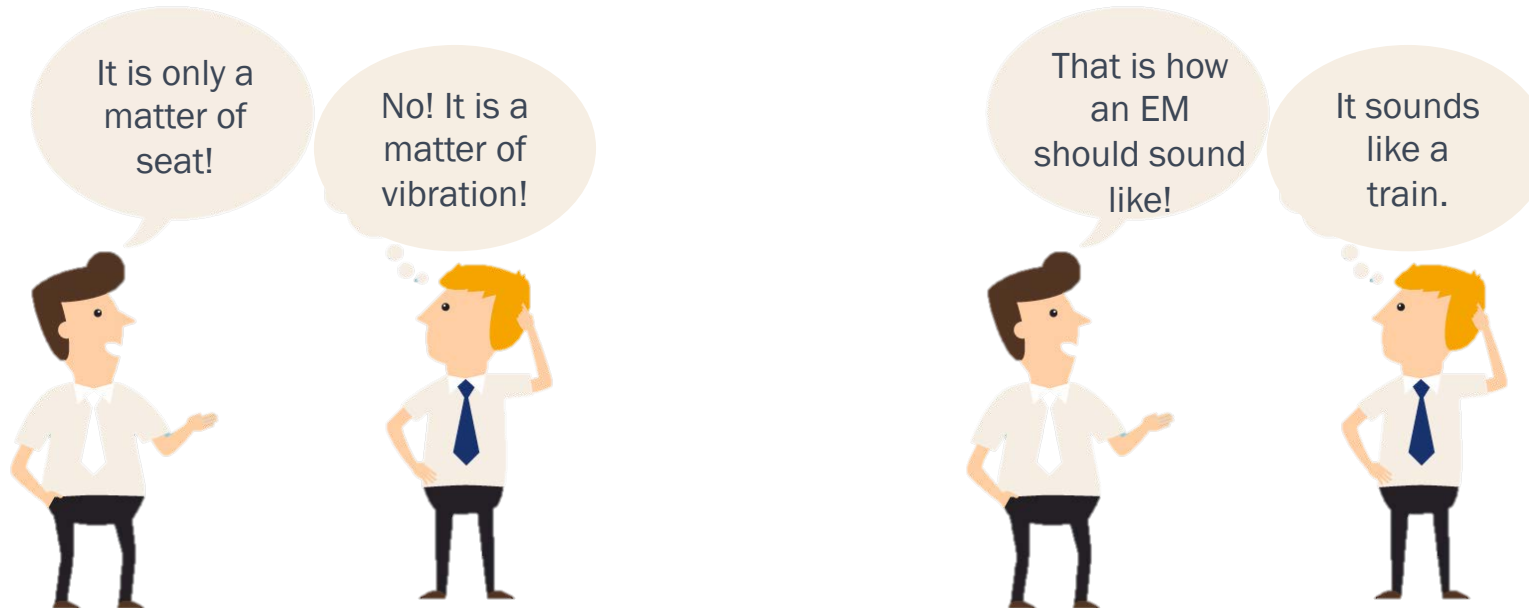

Static Comfort

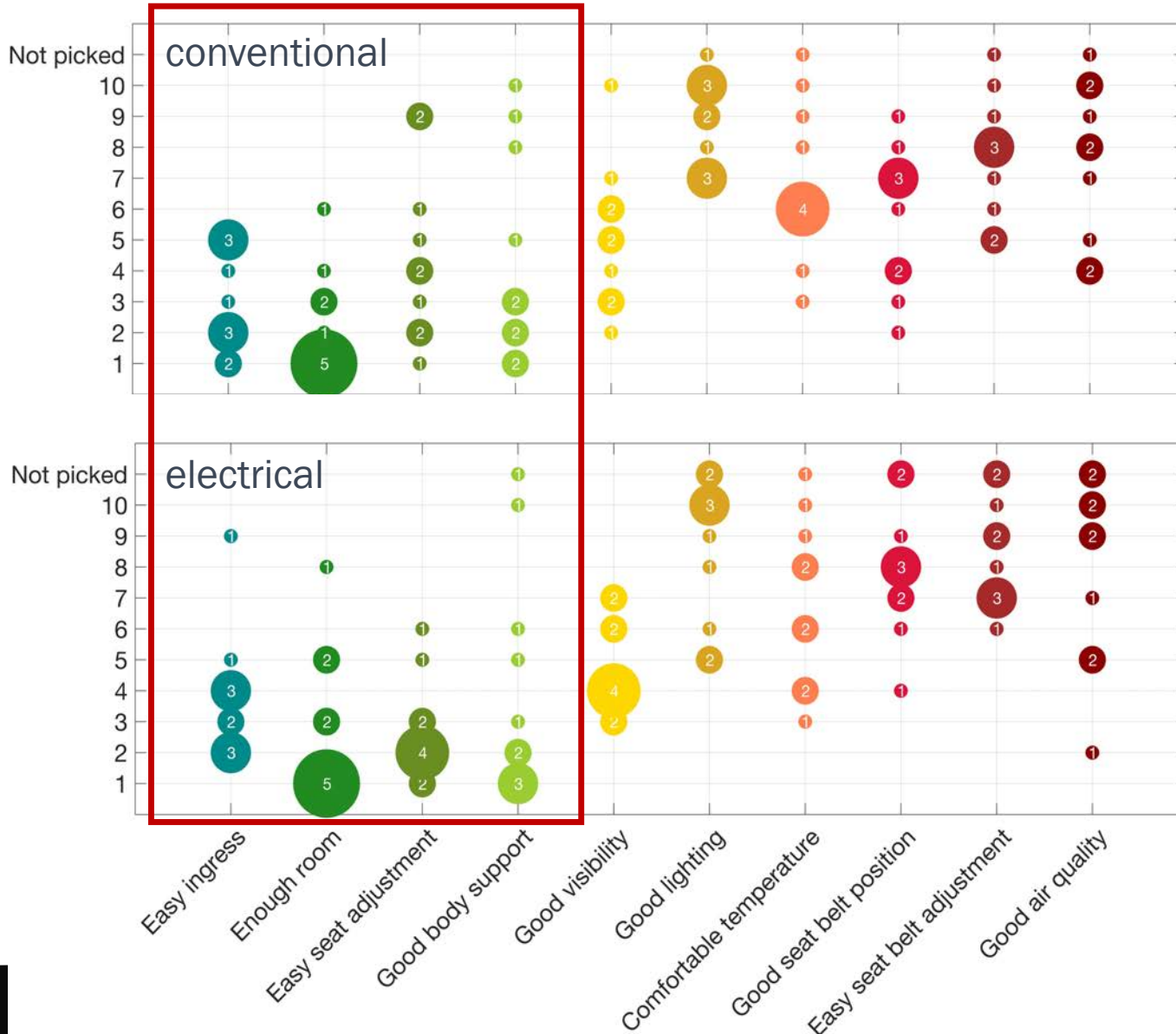

Factors for static comfort

- ingress, roominess, seat adjustment, seat support
- hard to explain ingress, but easy to compare
- lateral clearance
- the adjustment of length, backrest, headrest
- thigh support, lumbar support

Dynamic Discomfort

Factors for dynamic discomfort

- not enough support in the conventional car
- annoying sounds in the electrical car

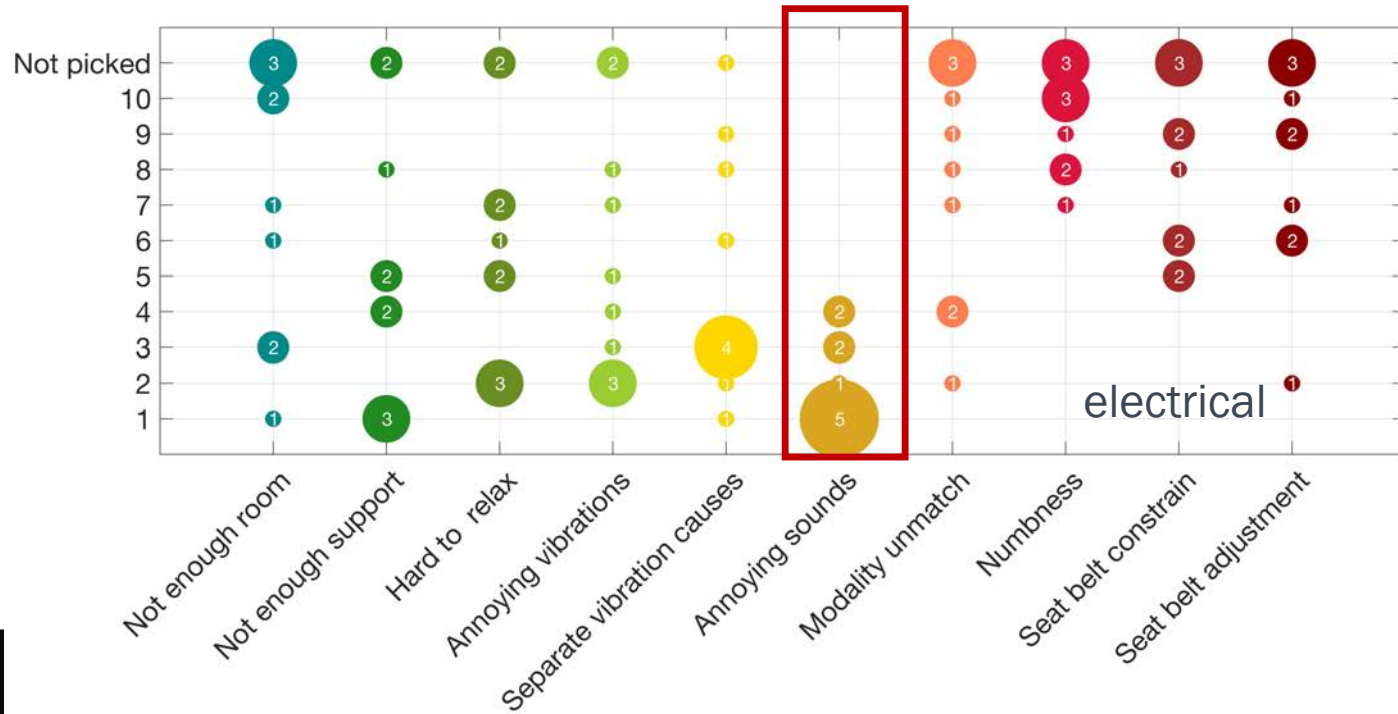
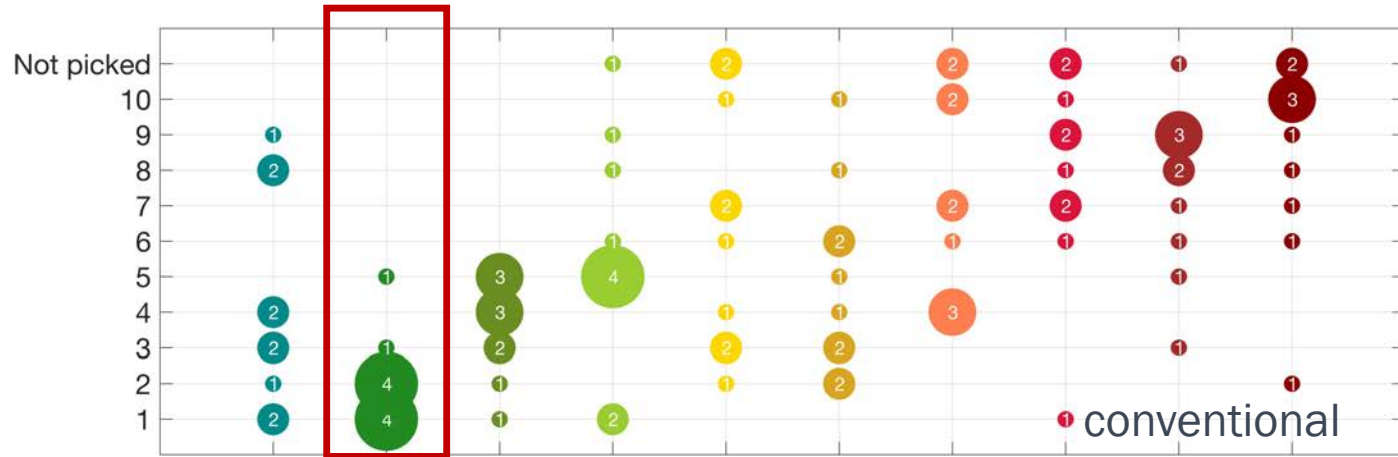

Publications

- Review of 115 papers
- Most affected human body parts
- Vibrations in passenger cars
- Preferable seat dimensions
- Impact of demographic properties
- Application of current standards
- Future demands on ride comfort
- NVH in future electrical vehicles



Human Response to Vibrations and Its Contribution to the Overall Ride Comfort in Automotive Vehicles - A Literature Review

Xiaojuan Wang China Euro Vehicle Technology AB

Anna-Lisa Osvalder and Patrik Höstmad Chalmers University of Technology

Ingemar Johansson China Euro Vehicle Technology AB

Citation: Wang, X., Osvalder, A., Höstmad, P. and Johansson, I., "Human Response to Vibrations and Its Contribution to the Overall Ride Comfort in Automotive Vehicles - A Literature Review," SAE Technical Paper 2020-01-1085, 2020, doi:10.4271/2020-01-1085.

Abstract

The various factors that affect ride comfort, including noise, vibrations and harshness (NVH) have been in focus in many research studies due to an increasing demand in ride comfort in the automotive industry. Vibrations have been highlighted as an important contribution to assess and predict overall ride comfort. The purpose of this paper is to present an approach to explain ride comfort with respect to vibration for the seated occupant based on a systematic literature review of previous fundamental research and to relate these results to the application in the contemporary automotive industry. The results from the literature study show that numerous research studies have determined how vibration frequency, magnitude, direction, duration affect human

response to vibration. Also, the studies have highlighted how body posture, age, gender and anthropometry affect the human perception of comfort. An analysis was made of the consistency and inconsistency of the results obtained in the different studies. The deviations of the research results from real-world ride comfort in automotive vehicles were analyzed and divided into three groups: appreciable and consistent with industry results, appreciable and inconsistent with industry results and not appreciable in industrial results. The overall conclusion from this literature study was that there is much information available from laboratory studies regarding human response to vibrations, but there is a lack of studies that take into account all the different parameters that affect the overall ride comfort experience for automotive vehicle occupants.

———— Future Publications ————

Noise and vibration influence on overall ride comfort in a conventional passenger car under different driving scenarios

- the factors for static comfort & dynamic discomfort
- the combined effects under different scenarios

Noise and vibration influence on overall ride comfort in an electrical passenger car under different driving scenarios

- the factors for static comfort & dynamic discomfort and the combined effects
- the comparison with a conventional car

Human responses to sounds and vibrations in passenger cars

- the sounds and vibrations in a conventional car and an electrical car
- human responses to sounds and vibrations

Towards a methodology for prediction of overall ride comfort for front seat occupant in passenger cars

- the method of subjective assessment & objective measurements
- the future implication in virtual analysis tools

———— For the future ————

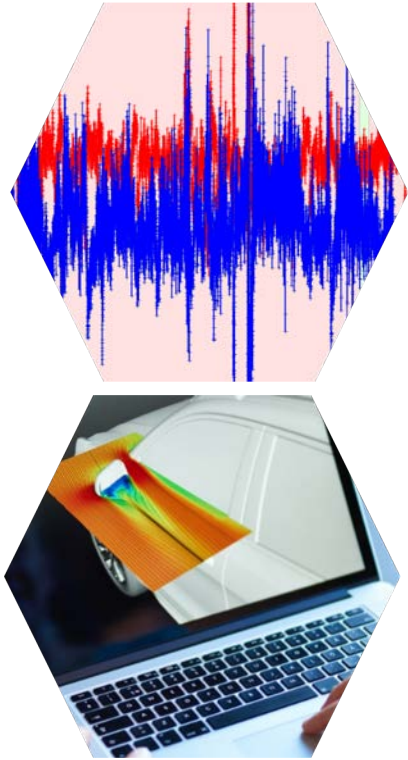

- the critical inputs
 - motions, vibrations & sounds from the real-world measurements



- the objective criteria

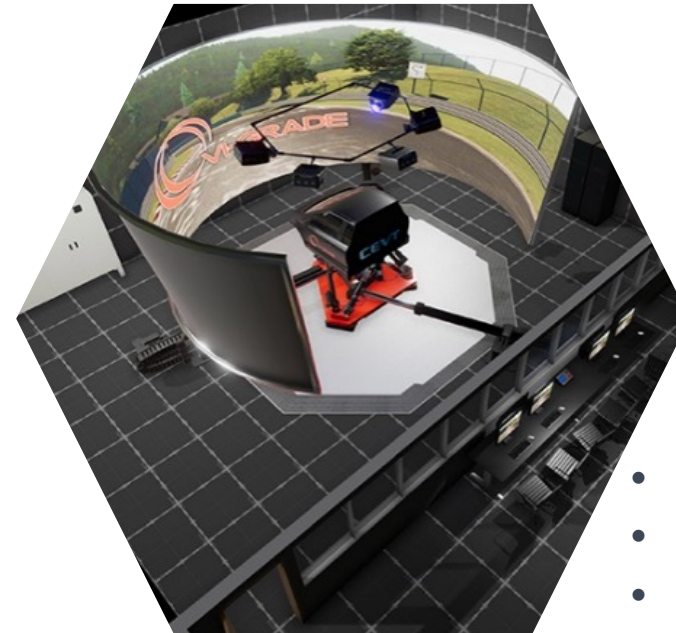

- larger samples
- controlled test environments
- both short-term and long-term test scenarios
- future seat architecture

———— For the future ————

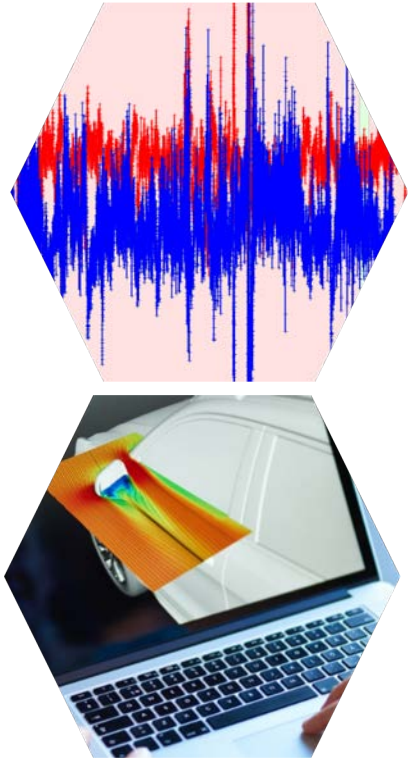

- the critical inputs
 - motions, vibrations from the real-world measurements



- the objective criteria



- large diversities of subjects
- static & dynamic factors
- various seat-human interactions

LABORATION

WE ARE STILL **ON** THE WAY
THANK YOU



Xiaojuan Wang

Industrial PhD Candidate

xiaojuan.wang1@cevt.se
xiaojuan@chalmers.se

+ 46 (0)72 18 43 544

in

Xiaojuan Wang
PhD candidates in Ride Comfort & NVH
Gothenburg Metropolitan Area · 139 connections ·

Add profile section More...

- Chalmers University of Technology
- Chalmers University of Technology

**Presentation: *Motion Sickness in
Autonomous Vehicles*, Ilhan Yunus, VCC &
KTH**

**Presentation: *New Mobility Engineering*
master programme, Erik Hulthén and Giulio
Bianchi Piccinini, Chalmers**

MASTER'S PROGRAMME MOBILITY ENGINEERING

MCS, 120 CR, 2 YEARS



CHALMERS
UNIVERSITY OF TECHNOLOGY

DEVELOP TOMORROW'S MOBILITY SYSTEMS!



New MP integrating aerospace, automotive engineering, marine technology and railway technology

Giulio Bianchi Piccinini

Programme director of Master's Programme in
Mobility Engineering (MPMOB)

Current transportation challenges



Challenges

- Improved capacity
- Reduced costs
- Less development time
- Smaller environmental impact
- Enhanced safety
- Increased sustainability

Possible solutions

- Artificial intelligence
- Automation
- Digitalization
- Electrification/alternative fuels
- Energy-efficient solutions
- Simulation-based design

Aim of MP



Train students:

- To develop safe, sustainable, high-performance mobility solutions.
- To understand features, design requirements and challenges of the present and future mobility solutions.
- To gain a holistic knowledge of mobility solutions and the ability to apply them for different transportation needs and environments.

Study plan



Students will gain in-depth knowledge in one of these profiles:

- Aerospace
- Automotive Engineering
- Marine Technology
- Railway Technology

Study plan – Aerospace

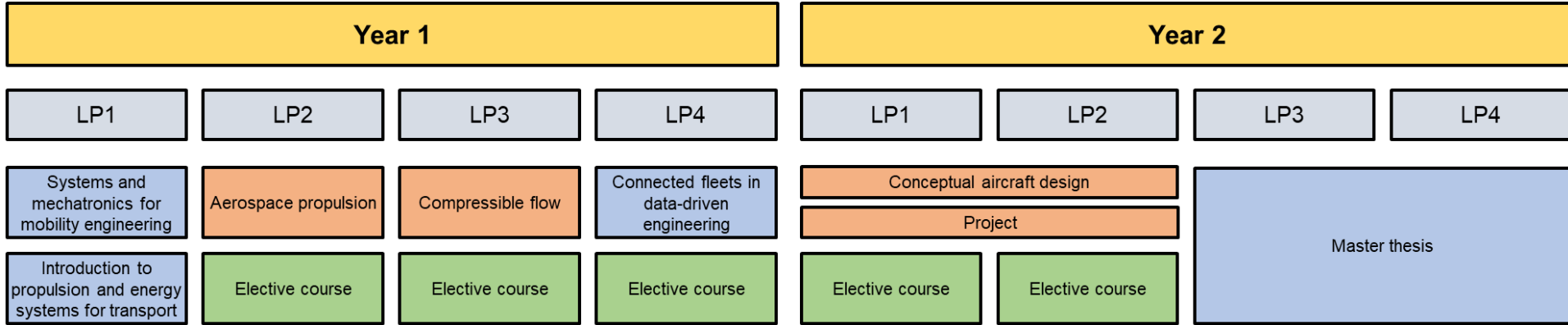

Mandatory course for all profiles

Mandatory course for aerospace

Elective course for aerospace

Red threads:

- Propulsion
- Structural
- Artificial intelligence

Study plan – Automotive engineering



Vehicle engineering

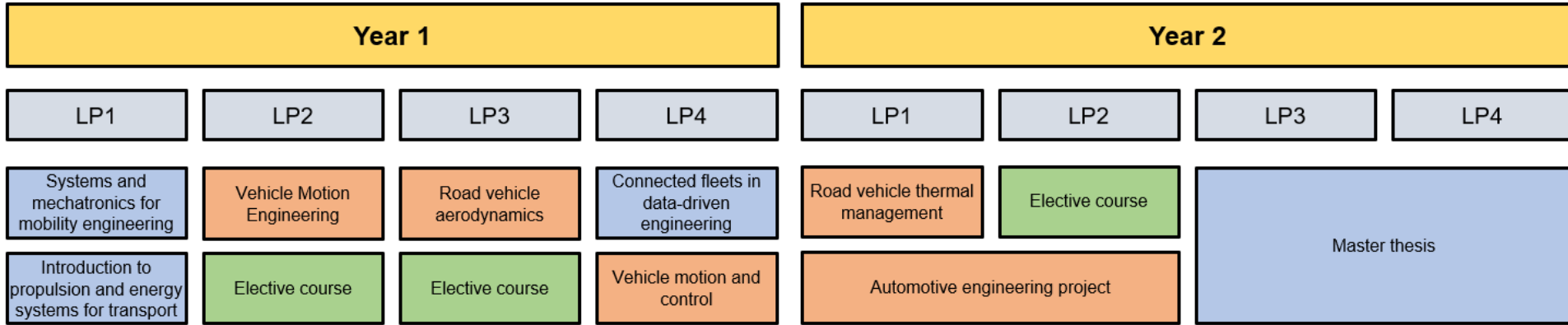

Mandatory course for all profiles

Mandatory course for automotive engineering

Elective course for automotive engineering

Red threads:

- Vehicle dynamics
- Vehicle aerodynamics

Study plan – Automotive engineering



Vehicle safety

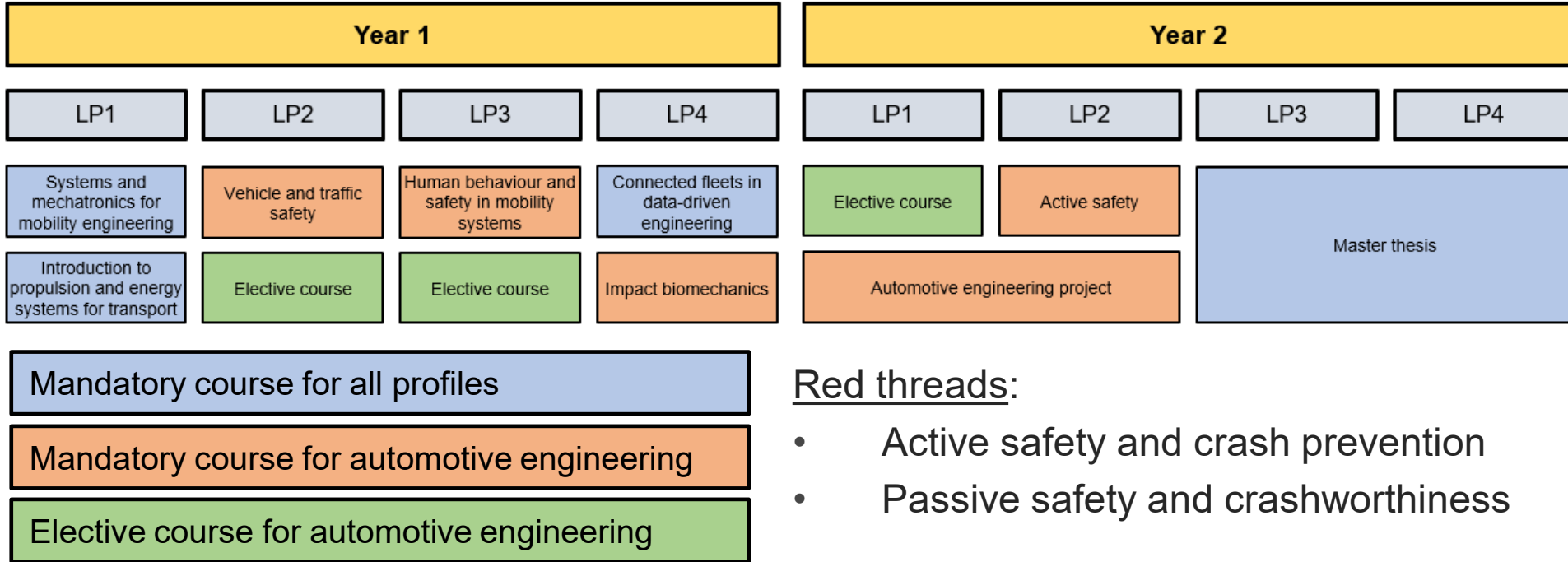

Study plan – Automotive engineering



Vehicle powertrain

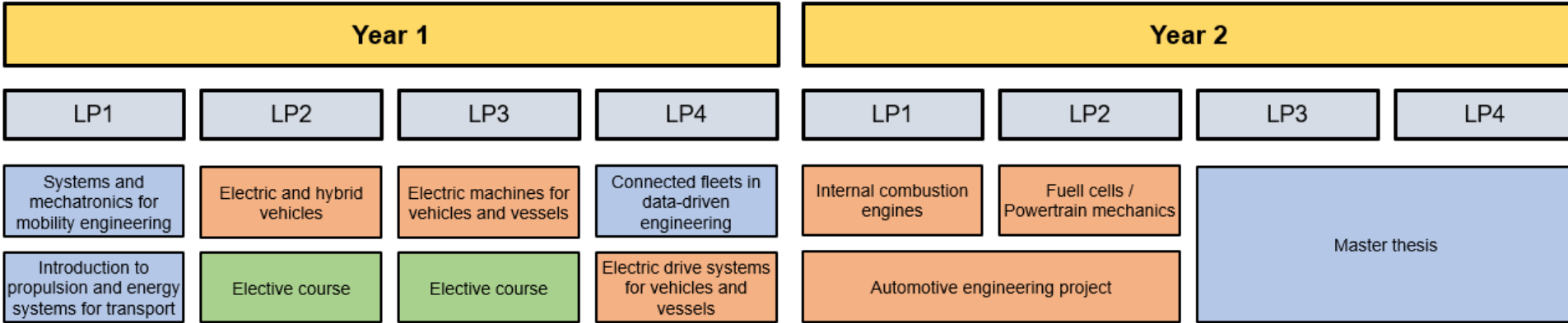

Mandatory course for all profiles

Mandatory course for automotive engineering

Elective course for automotive engineering

Red threads:

- Propulsion
- Drivetrain

Study plan – Marine technology

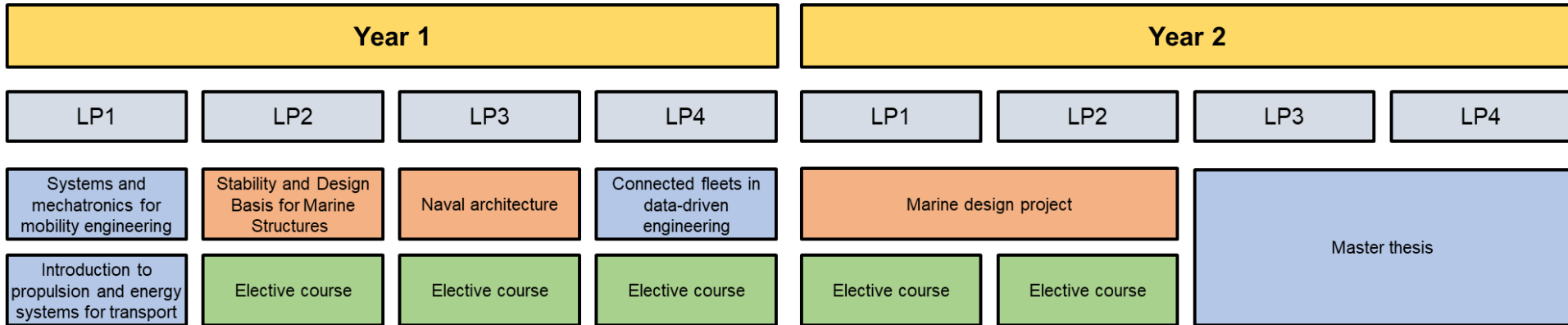

Mandatory course for all profiles

Mandatory course for marine technology

Elective course for marine technology

Red threads:

- Naval architect

Study plan – Railway technology



Year 1				Year 2			
LP1	LP2	LP3	LP4	LP1	LP2	LP3	LP4
Systems and mechatronics for mobility engineering	Railway technology	Project in railway technology	Connected fleets in data-driven engineering	Elective course	Elective course	Master thesis	
Introduction to propulsion and energy systems for transport	Elective course	Elective course	Elective course	Elective course	Elective course		

Mandatory course for all profiles

Mandatory course for railway technology

Elective course for railway technology

Red threads:

- Material deterioration
- Railway mechanics
- Asset management

Hands-on education



Study visits

Guest lectures from industry and
transport administration

Chalmers Formula Students

Lab exercises

Project work within each profile

Chalmers' research-based education

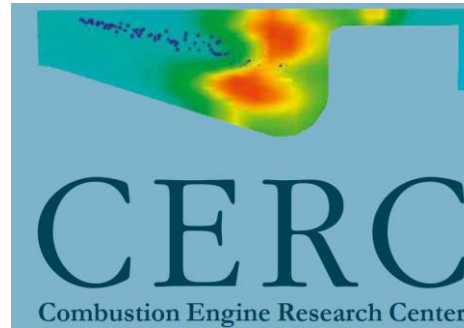

International environment

Students admitted from 17 countries in 2020*



*Students admitted within Master Programme in Automotive Engineering (MPAUT) and Naval Architecture and Ocean Engineering (MPNAV)

Examples of career opportunities



Within automotive, railway, aerospace and naval:

- Research and development
- Design engineering and simulation
- Manufacturing and operation
- Sales
- Testing
- Technical support and maintenance

Examples of job providers



BOMBARDIER



CEVT



**green
cargo**

**Consulting
companies**

**Companies outside
Sweden**

Do you want to know more?



Contact

Giulio Bianchi Piccinini

giulio.piccinini@chalmers.se

+46 31 772 1421



**Presentation: Vehicle Engineering master
programme, Mikael Nybacka, KTH**

Master program in *Vehicle Engineering*



ROYAL INSTITUTE
OF TECHNOLOGY

Program responsible:

Mikael Nybacka, KTH Vehicle Engineering and Solid Mechanics



Road vehicle



Rail vehicle



Vehicle engineering

- *some quick facts*



Two-year programme (120 ECTS credits) given in English

Two tracks, road and rail vehicles

600-700 applicants and 300 1st hand applicants over the last 5 years

Admitted 53 students 2021 (14% acceptance rate)

Around 1/3 Swedish and 2/3 international students

Specific entry requirements

- A bachelor's degree, or equivalent, corresponding to 180 ECTS credits, with courses in
 - Mathematics and programming: must include
 - (i) differential and integral calculus in several variables,
 - (ii) linear algebra,
 - (iii) numerical analysis),
 - (iv) ordinary and partial differential equations and integral transforms,
 - (v) basic control theory,
 - (vi) mathematical statistics and
 - (vii) basics of programming in a higher programming language
 - equivalent to at least 25 ECTS credits in total.
 - Applied mechanics: must include
 - (i) rigid body mechanics,
 - (ii) solid mechanics,
 - (iii) fluid mechanics and
 - (iv) thermodynamics,
 - equivalent to at least 20 ECTS credits in total.



Learning goals

You will learn about:

- future *demands* and *challenges*,
- vehicles *components* and *functions*,
- vehicles *dynamic properties* and *interaction with its environment*,
- *active vehicle systems* for safety, monitoring and comfort,
- vehicles *role in the transport system and in society*.

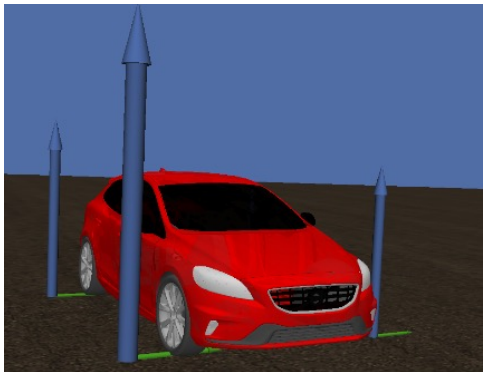

Program structure

Industry and research projects

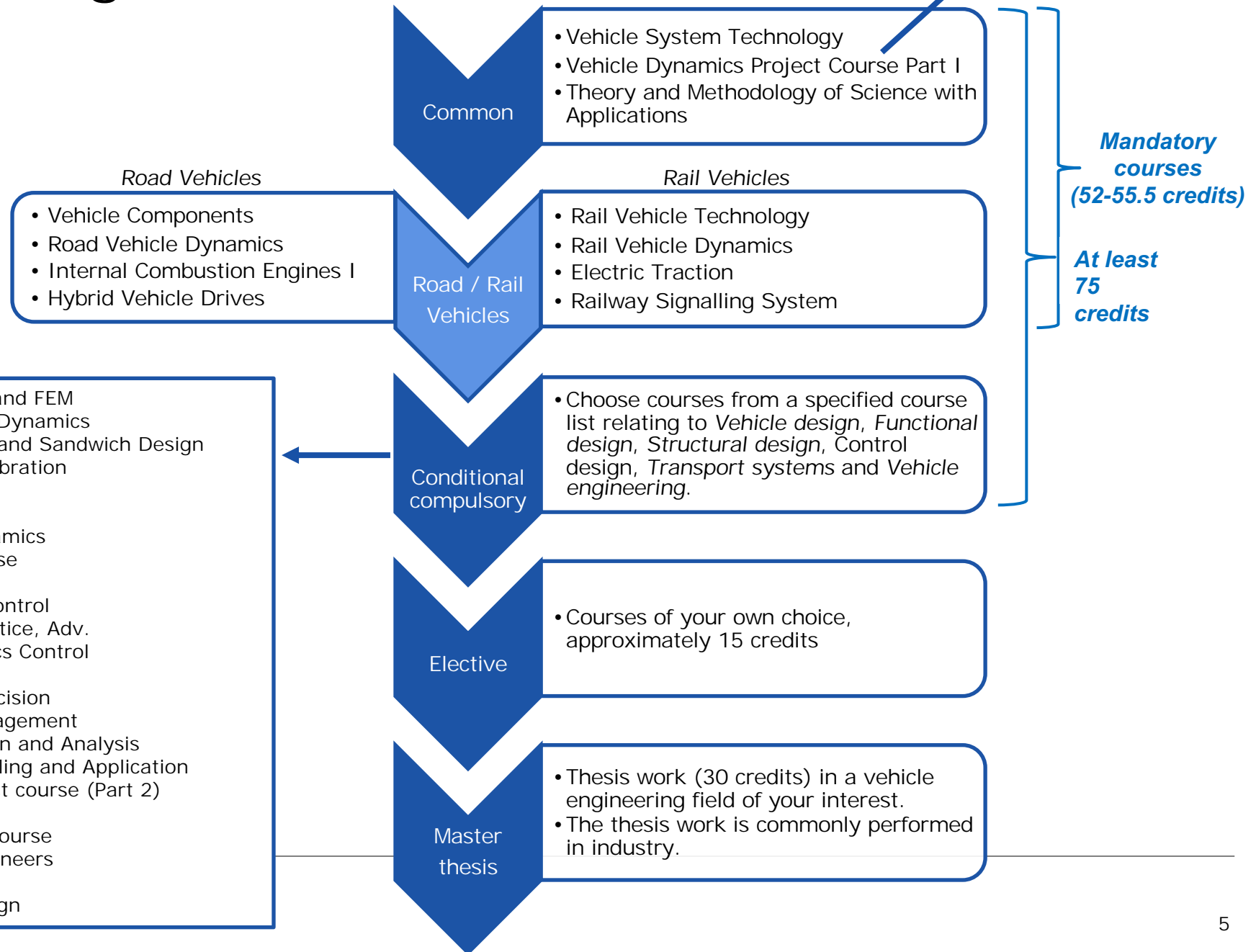

Vehicle Engineering Lab

- Teknikringen 8

Our common laboratory:

- Teaching
- Experiments
- Computer exerc.
- Own studies

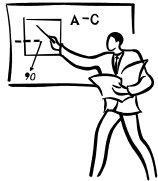

Experiment vehicles and test tracks



Volvo S90 D5 AWD Geartronic

Arlanda test track



RCV

Research
Concept Vehicles

RCV-E



Renault Twizy

Lunda airfield



MSC thesis examples

Develop new body tilting for Regina 250

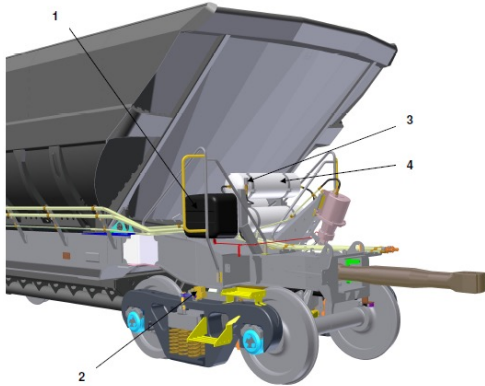

Simulation model of a iron ore carriage



Energy efficient propulsion with in-wheel motors

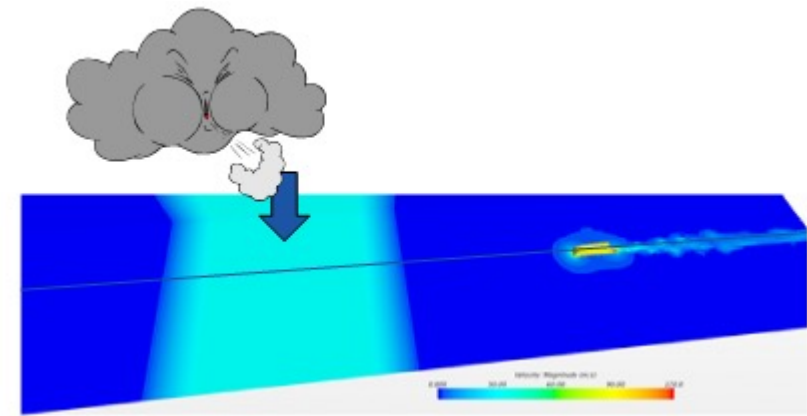

Side wind sensitivity of vehicles

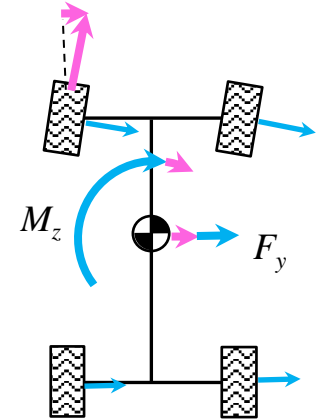



ROYAL INSTITUTE OF TECHNOLOGY

EIT Urban Mobility Master School



Sustainable Urban Mobility Transitions

Gain the knowledge to design and manage sustainable urban plans & policies, and the skills to drive responsible innovation.

[READ MORE!](#)



Smart Mobility Data Science & Analytics

Reshape our urban systems by harnessing big data through advanced data analytics, modelling, and simulation.

[READ MORE!](#)

Duration: 2 years (120 ECTS)
Educational level: second-cycle
Language of instruction: English

30 ECTS of business-orientated character focusing on innovation and entrepreneurship.

90 ECTS of a specific engineering specialisation.

Students that graduate from the program will be awarded a double degree from KTH and from the other university where the student studies.

2 or 3 additional programmes will start in the coming years.

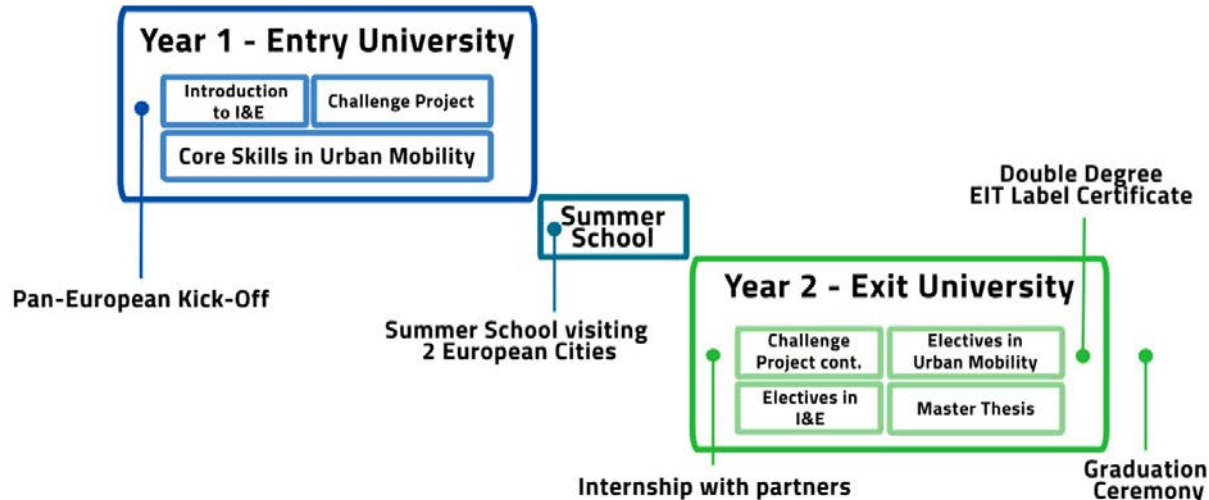

Vehicle Engineering

- Fordonsteknik

Mikael Nybacka
Programme responsible

mnybacka@kth.se

Research groups *Rail vehicles, Vehicle dynamics, Aero dynamics and Conceptual vehicle design*
At the division of Vehicle Engineering and Solid Mechanics

Teknikringen 8

www.kth.se/en/studies/master/vehicleengineering

Poster: *Improving Vehicle Dynamics Development Process by combining simulation and motion platform simulator*, Lidong Wang, Chalmers

Double Master Thesis: Vehicle Dynamics Development Process

Student: Wang, Lidong
 Examiner: Bengt J H Jacobson
 Supervisor: Ingemar Johansson



Abstract

In this thesis, a vehicle dynamics development process for the concept engineering phase that includes offline simulation tools and a motion driving simulator is being used. The process will allow test drivers to give feedback in the early stage of concept design and system engineering, especially before test vehicles being built. The process aims at reducing the time and cost in the whole vehicle dynamics developing process.

Deliverables

- Developing tools and methods to work with offline simulations and the driving simulator for the next phase of development.
- An analysis of different ways to use the same vehicle model in offline simulation and in the driving simulator.
- A procedure for developing vehicle dynamic performance with simulation and driving simulator.
- The tools and methods will be assessed in different types of vehicles and different manoeuvres.
- Methods to quantify the contribution of driving simulators in development processes.
- A system that facilitates DIL vehicle tuning during both real-time process and post-process.
- Case studies that prove the effectiveness of the procedure from different perspectives.

Tools and Methods

A simulation system has been developed based on IPG Carmaker as the simulation tool, and the Chalmers CASTER is being used as the motion driving simulator. The developed tools and methods have been applied in case studies to assess the development process.

Main Benefits

- To get subjective feedback from a driver earlier by using simulator.
- Reduce the use of early prototypes in the project.
- Reduce both time and cost.
 - Potential of reducing the lead time for the concept phase with around 20 weeks.
 - Reduce the cost on building prototypes.
- Other beneficials.
 - Develop better technical solutions before the first test series.
 - Allow quick comparison between different vehicle configurations and tunings of the chassis.

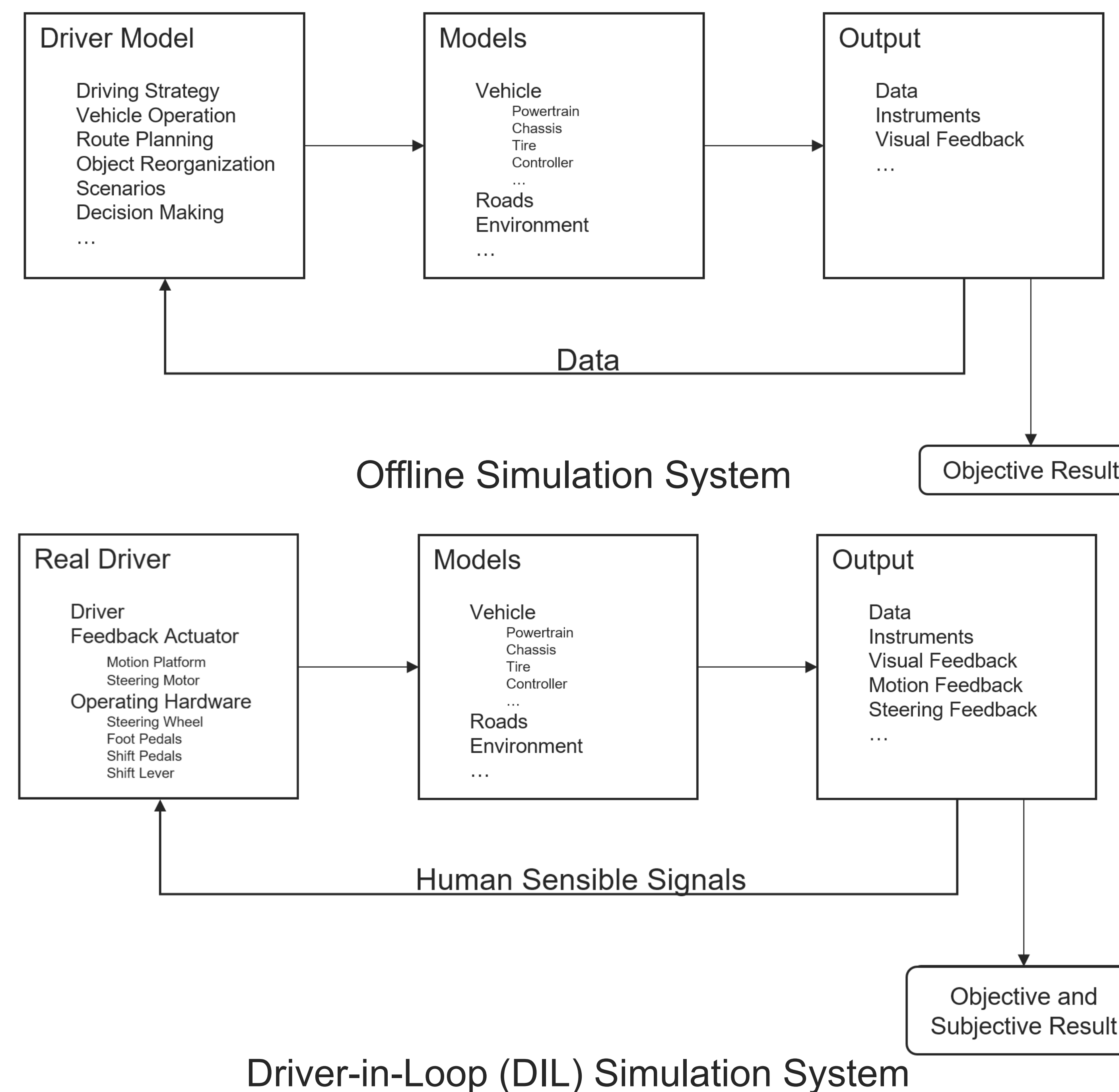

Case Study 1

This case study is cooperating with the research project Driving Stability of Passenger Vehicles under Crosswinds.

Case Study 2

This case study is investigating parameters that affects steering feels.

Case Study 3

This case study is about tuning chassis for best vehicle dynamics performance.



A DLC test with motion simulator

Outstanding Work

- Continue developing the tools and methods
- Applying the tools and methods to the development processes
- Assessing the improvement of using the tools and methods in the development process
- Continue tuning models
- Writing the reports
- Final presentation

Poster: *Propelled and steered converter dolly for more efficient shunting of semi-trailers on goods terminals*, Neel Kachhawah and Clive Rahul Misquith, Chalmers

Master thesis: Propelled and steered converter dolly for improved shunting of semi-trailers on goods terminals

Students:

Clive Rahul Misquith

misquith@student.chalmers.se

Neel Kachhawah

neelk@student.chalmers.se

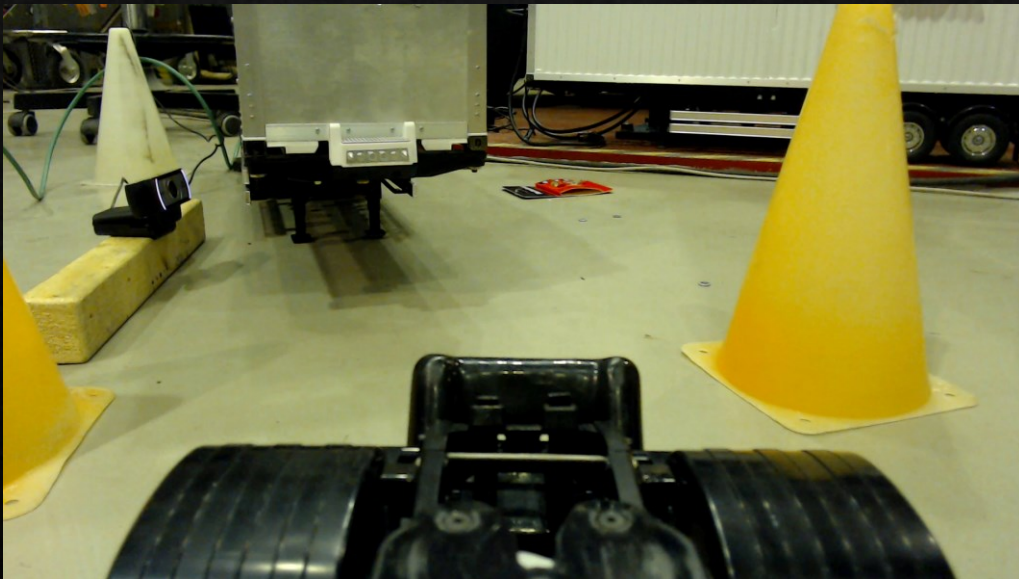

Objectives of the thesis

- ❖ Optimizing the terminal operating cycles (coupling and decoupling with semi-trailer) for time, energy and cost using i-Dolly.
- ❖ Performing shunting operations at dry ports and local distribution of semi-trailers more efficiently using i-Dolly.
- ❖ Replace the need for a driver for such repetitive and demanding maneuvers which can be automated with relative ease.

ArUco Localization

- ❖ For small scale models, ArUco markers give heading and position of i-Dolly and semi-trailer.
- ❖ With a ceiling mounted camera, it is analogous to GPS with accuracy within a few centimeters.



Cubic Spline Real-Time Path Planner

- ❖ Using a set of waypoints, a smooth curve is generated between these points.
- ❖ The equation of the curve is a cubic polynomial.

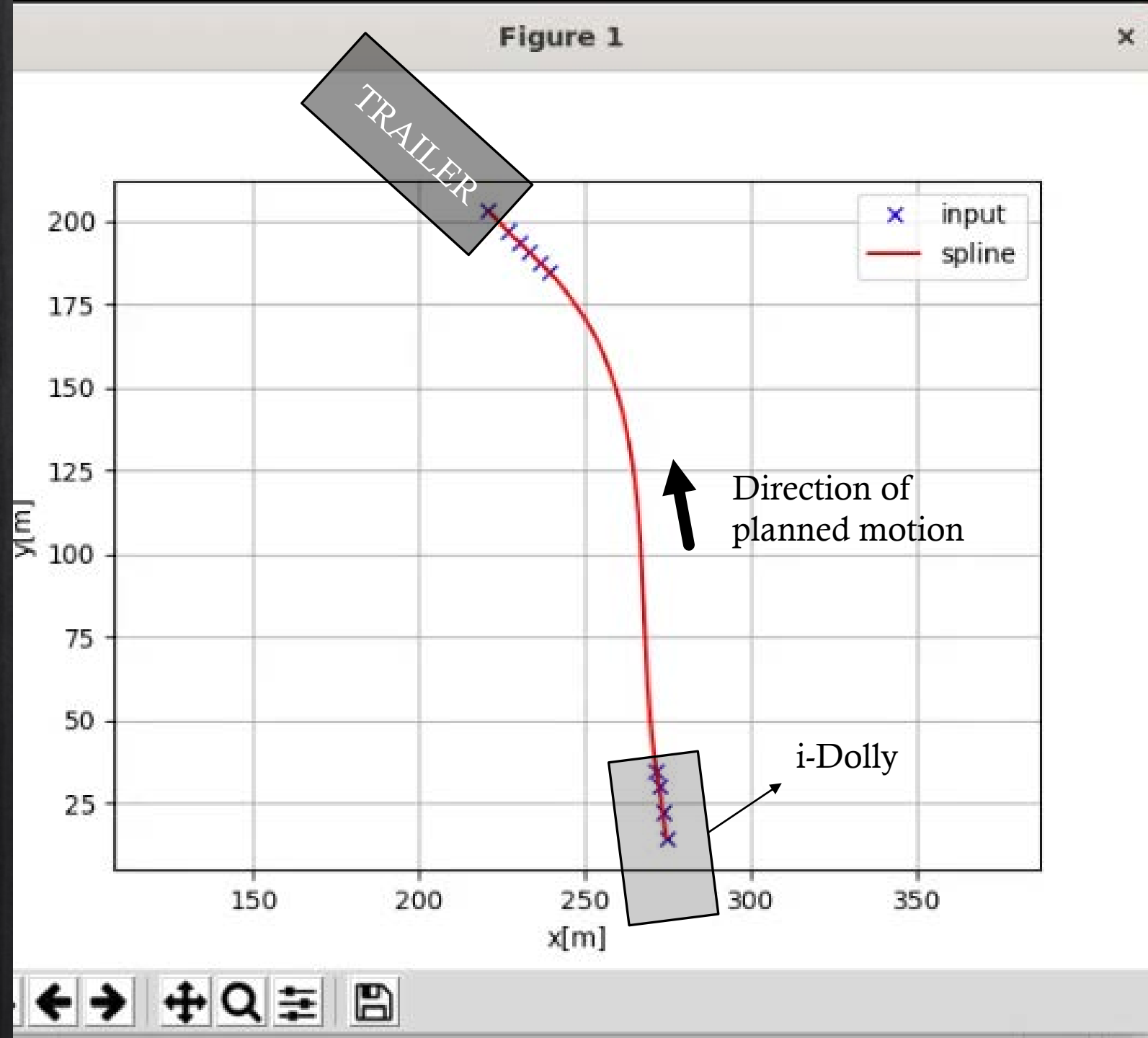

Stanley Control

- ❖ Uses the center of front axle for tracking.
- ❖ Considers single track kinematic model.
- ❖ Less computation compared to non-linear MPC.
- ❖ Globally stable controller i.e. vehicle will return on path irrespective of starting conditions.

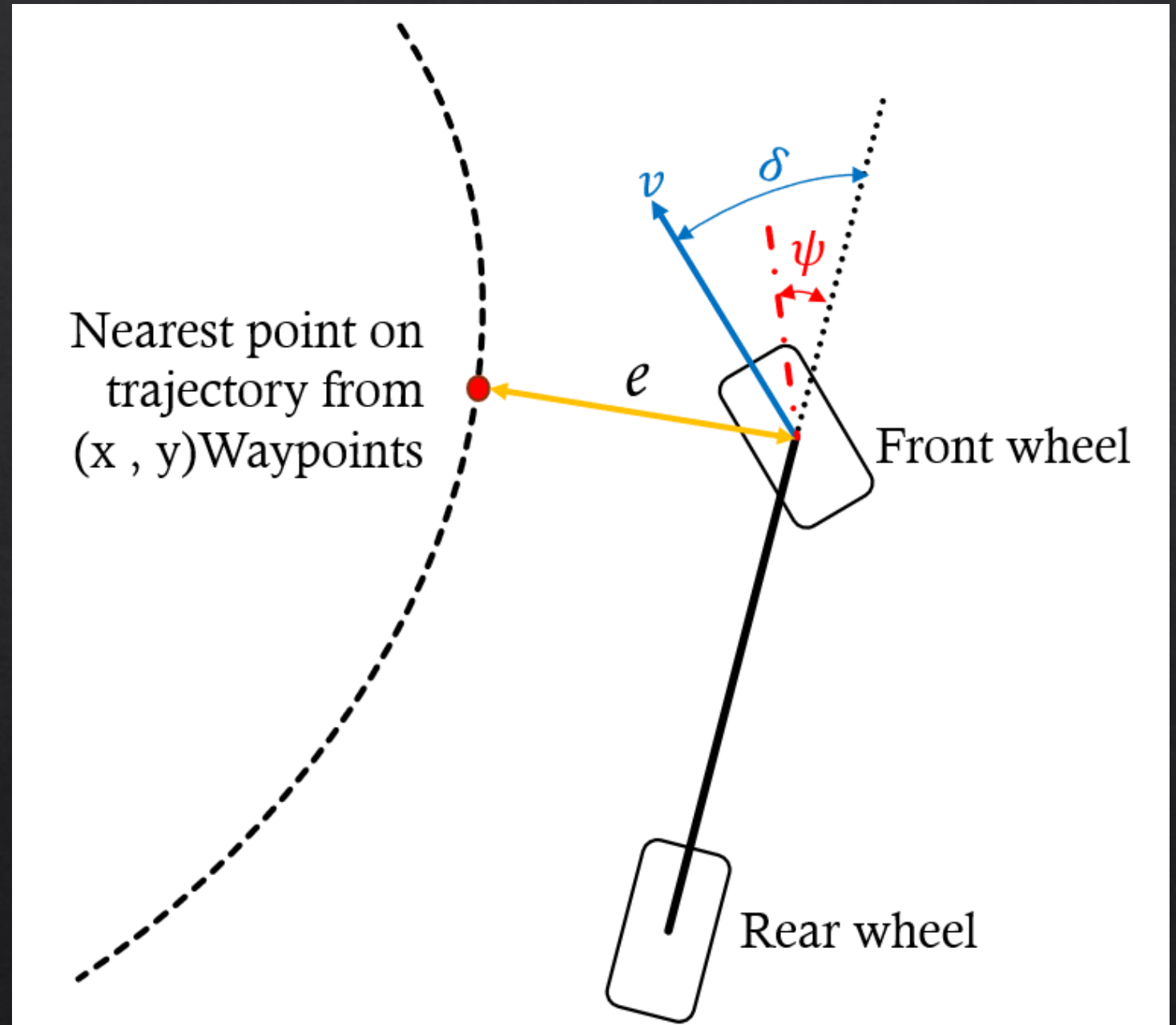

Execution of Reverse Maneuver for coupling i-Dolly with semi-trailer

reverse-diplo-amd64-1:1 (reverse) - TigerVNC

maj 13 17:15

Activities Matplotlib ▾

Figure 1

Speed[km/h]:1.08

200
175
150
125
100
75
50
25

150 200 250 300 350

Display

```
reverse@reverse-diplo-amd64-1: ~/repos/opencv-percepti...  
reverse@reverse-diplo-amd64-...  
reverse@reverse-diplo-amd64-...  
diplo-stanleycontroller-amd64 | Received Envelope with ID = 1047/0  
diplo-stanleycontroller-amd64 | Received Envelope with ID = 1047/0  
diplo-stanleycontroller-amd64 | Received Envelope with ID = 1210/0  
diplo-stanleycontroller-amd64 | Received Envelope with ID = 1055/1  
diplo-stanleycontroller-amd64 | Received Envelope with ID = 1200/0  
diplo-stanleycontroller-amd64 | Received Envelope with ID = 1210/0  
diplo-stanleycontroller-amd64 | Truck heading: -1.312025434831199  
diplo-stanleycontroller-amd64 | Received Envelope with ID = 1030/0  
diplo-stanleycontroller-amd64 | Received Envelope with ID = 1031/0  
diplo-stanleycontroller-amd64 | Received Envelope with ID = 1032/0  
diplo-stanleycontroller-amd64 | Received Envelope with ID = 1118/0  
diplo-stanleycontroller-amd64 | Received Envelope with ID = 1051/0  
diplo-stanleycontroller-amd64 | Received Envelope with ID = 1047/0  
diplo-stanleycontroller-amd64 | Received Envelope with ID = 1030/0  
diplo-stanleycontroller-amd64 | Received Envelope with ID = 1031/0  
diplo-stanleycontroller-amd64 | Received Envelope with ID = 1032/0  
diplo-stanleycontroller-amd64 | Received Envelope with ID = 1118/0  
diplo-stanleycontroller-amd64 | Received Envelope with ID = 1051/0  
diplo-stanleycontroller-amd64 | Received Envelope with ID = 1047/0  
diplo-stanleycontroller-amd64 | Received Envelope with ID = 1047/0
```

Link to demonstration [here](#)

**Poster: *Evaluation of Active Rear Steering
through Multi Body simulation*, Gabriele
Bertoli and Matteo Rossi, KTH**



Gabriele Bertoli



Matteo Rossi



POLITECNICO
MILANO 1863

Evaluation of Active Rear Steering through MultiBody simulation

GABRIELE BERTOLI and MATTEO ROSSI

Master Thesis supervised by M. Boerboom, H. Abadikhah, L. Drugge, M. Vignati

Why should a vehicle have Active Rear Steering?

1. It improves maneuverability

- ✓ A tighter turning radius and a higher yaw-rate gain are achieved at low velocity.

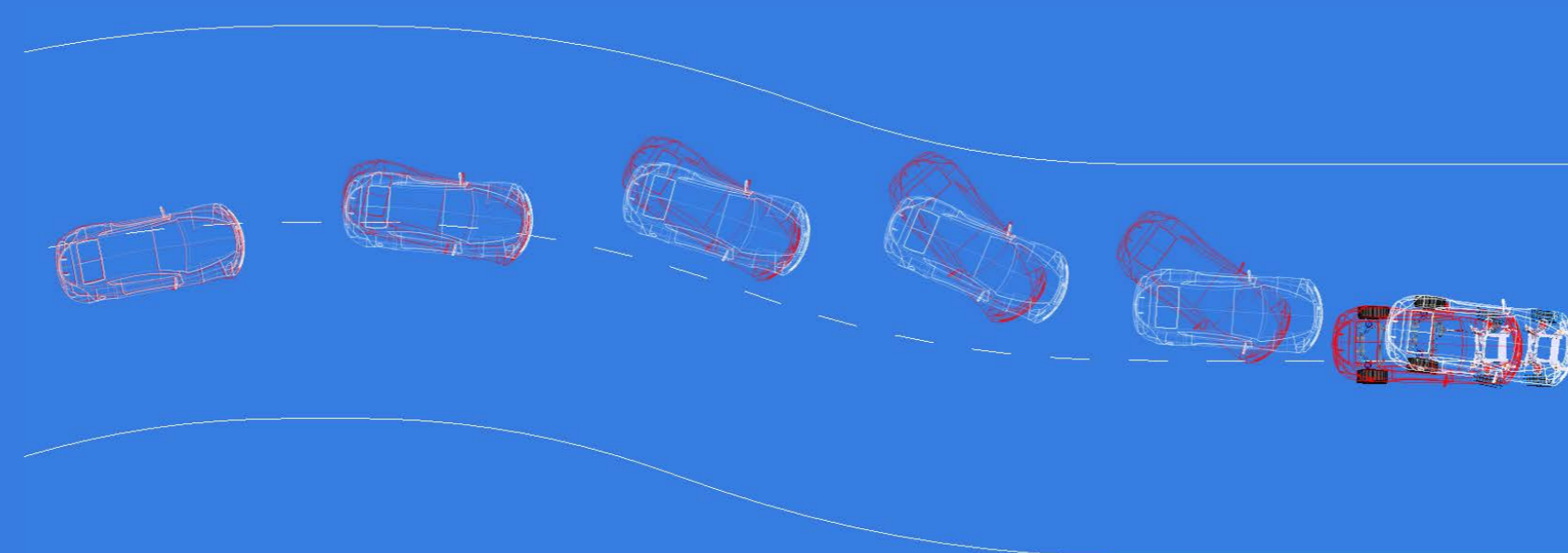

2. It improves stability

- ✓ The damping of the vehicle is increased, thus reducing the overshoot at high velocity.
- ✓ The side-slip angle can be kept close to zero.

3. It improves reactivity

- ✓ Lag between yaw-rate and lateral acceleration is reduced.

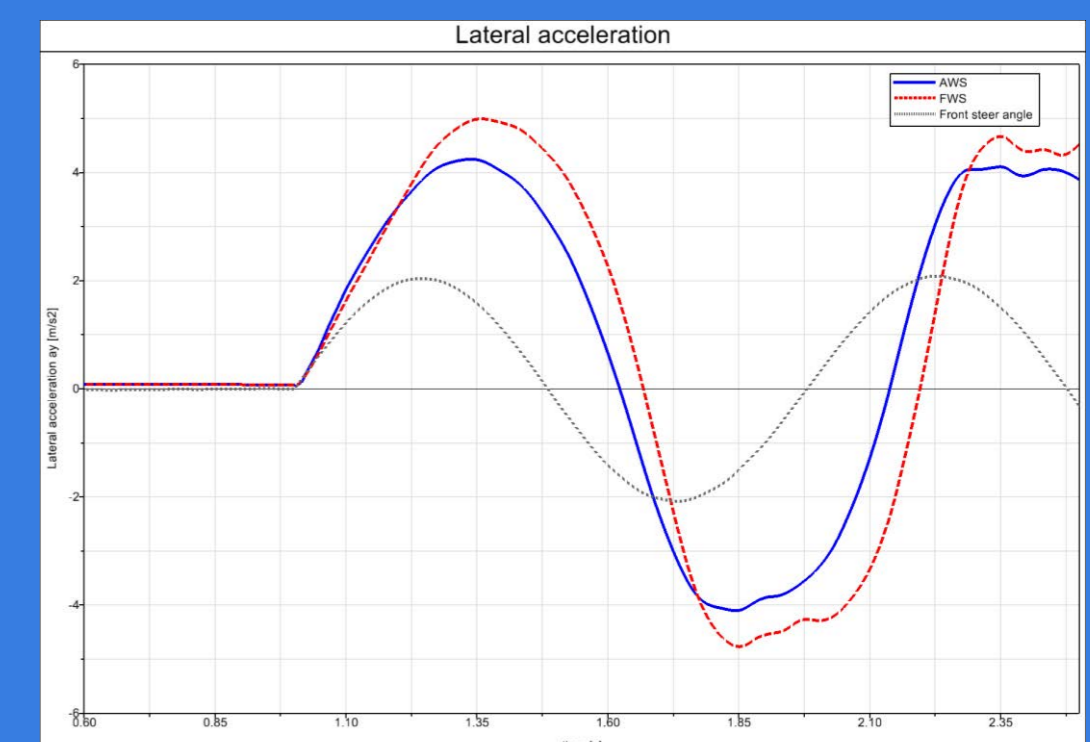

How should the rear wheels be steered? A feedforward approach.

The simplest way

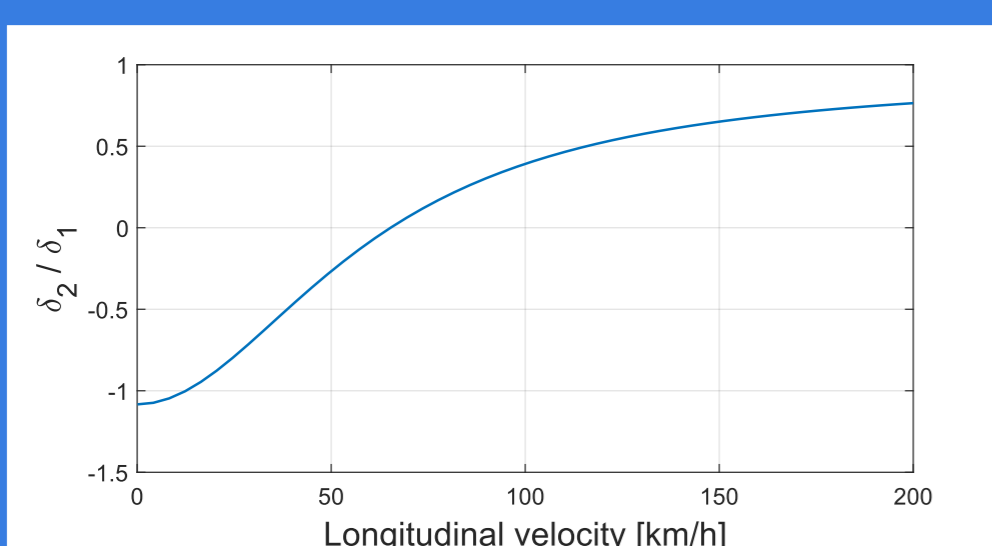

The rear steer angle is function of front steer angle and longitudinal velocity.

Better maneuverability, stability and agility are already achieved by such a simple control logic.

For instance, the rear steer angle can be set to minimise the side-slip angle.

An alternative possibility

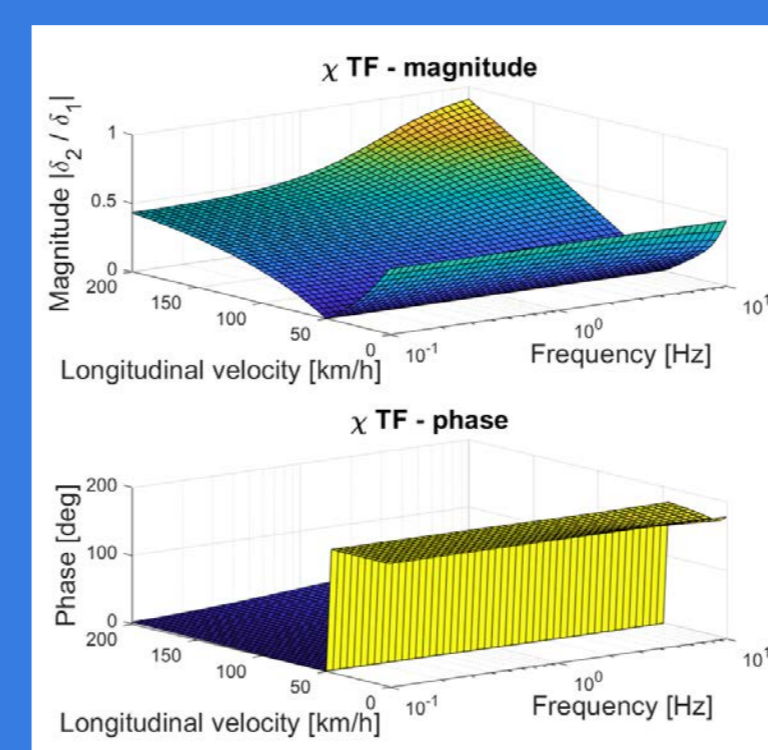

The rear steer angle can also be function of the steering frequency.

A desirable vehicle response can be defined as reference; for instance, the one of a vehicle with its wheelbase increasing with velocity.

Working with the transfer functions, the rear steer angle can be set to make the vehicle follow the desired reference. It turns out that the rear steer angle depends on the steering frequency too. Such a result implies that for high-frequency inputs at the steering wheel the rear wheels will steer more.

The disadvantage of this possibility, still under investigation, is that the response of the vehicle becomes less linear and less predictable.

Our tools

An interactive Graphical User Interface

On the one hand, a GUI has been designed for a more efficient evaluation of Active Rear Steering (ARS) effects.

Simple to use and easy to understand, this tool allows the interactive comparison of transfer functions and step responses of a vehicle with and without ARS.

The GUI is based on a single track model with linear and non-linear tyres. It allows to analyse the yaw-rate, side-slip and lateral acceleration in both frequency and time domain.

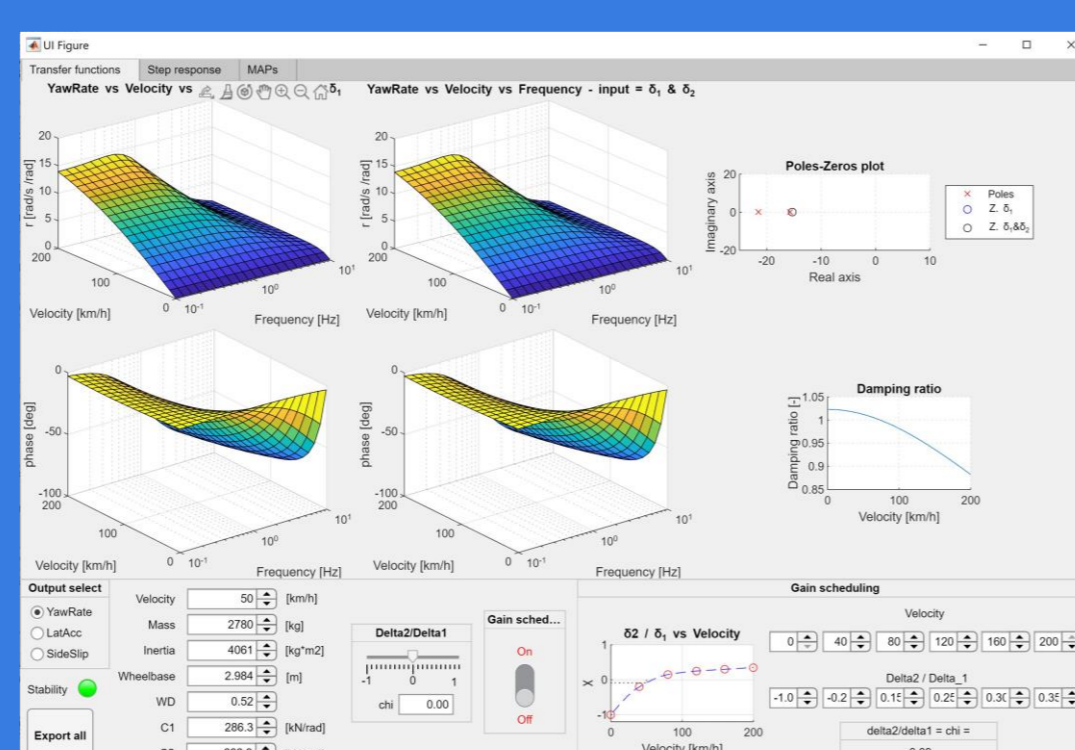

A MultiBody Simulation model

On the other hand, an MBS model has been developed from scratch.

Extremely detailed, plenty of data needed and more complex to implement, but the model can capture information unavailable from a bicycle model, such as internal forces and compliance.

Furthermore, this model allows to easily implement a control logic in Simulink and carry out co-simulations.

In the model, bodies are rigid, connected through compliant bushings and it adopts MF-tyres.

