

2004

## Excavations at Azoria, 2002

Donald C. Haggis

*University of North Carolina at Chapel Hill*

Margaret S. Mook

*Iowa State University, msmook@iastate.edu*

C. Margaret Scarry

*University of North Carolina at Chapel Hill*

Lynn M. Snyder

*Smithsonian Institution*

William C. West III

*University of North Carolina at Chapel Hill*

Follow this and additional works at: [http://lib.dr.iastate.edu/language\\_pubs](http://lib.dr.iastate.edu/language_pubs)



Part of the [Ancient History, Greek and Roman through Late Antiquity Commons](#), and the [Archaeological Anthropology Commons](#)

The complete bibliographic information for this item can be found at [http://lib.dr.iastate.edu/language\\_pubs/43](http://lib.dr.iastate.edu/language_pubs/43). For information on how to cite this item, please visit <http://lib.dr.iastate.edu/howtocite.html>.

---

## Excavations at Azoria, 2002

### **Abstract**

This report summarizes the results of the first season of excavation at Azoria in eastern Crete and provides an overview of the project's goals and problem orientation. Work in 2002 concentrated on the peak of the South Acropolis and the occupational phases of the seventh-sixth centuries B.C. The recovery of a possible andreion complex suggests the urban character of the site in the sixth century and forms a starting point for discussing the political economy of the Archaic city. The excavations revealed important evidence for the organization of the sixth-century settlement and for the complex stratigraphic history of the site, including the Final Neolithic, Late Prepalatial, Early Iron Age, Archaic, and Hellenistic periods.

### **Disciplines**

Ancient History, Greek and Roman through Late Antiquity | Archaeological Anthropology

### **Comments**

This article is from *Hesperia* 73 (2004): 339–400.

### **Rights**

This article is protected under the Creative Commons BY-NC license that allows for downloading and sharing articles, as long as the ASCSA and *Hesperia* are credited as the source. The articles and works derived from them cannot be used for commercial purposes.

# EXCAVATIONS AT AZORIA, 2002

## ABSTRACT

This report summarizes the results of the first season of excavation at Azoria in eastern Crete and provides an overview of the project's goals and problem orientation. Work in 2002 concentrated on the peak of the South Acropolis and the occupational phases of the seventh–sixth centuries B.C. The recovery of a possible *andreion* complex suggests the urban character of the site in the sixth century and forms a starting point for discussing the political economy of the Archaic city. The excavations revealed important evidence for the organization of the sixth-century settlement and for the complex stratigraphic history of the site, including the Final Neolithic, Late Prepalatial, Early Iron Age, Archaic, and Hellenistic periods.

## INTRODUCTION

Azoria (*Azorias*) is the local toponym for a distinctively rounded and double-peaked hill overlooking the Bay of Mirabello in northeastern Crete (Figs. 1, 2). Located 1 km southeast of the modern village of Kavousi and 3 km from the sea, the site occupies a topographically strategic position at a natural transition between the lowland plain of the north Isthmus of Ierapetra and the mountain valleys of Avgó and Papoura, which form the northwestern edge of the Siteia Mountains. The 2002 excavations at Azoria were conducted from June 3 to July 16, after which four weeks were spent at the Institute for Aegean Prehistory Study Center for East Crete (INSTAP-SCEC), processing and studying the finds.

The site was originally explored by Harriet Boyd (Hawes) in 1900.<sup>1</sup> In that year she began an extensive campaign of archaeological investigations in eastern Crete under an Agnes Hoppin Memorial Fellowship from the American School of Classical Studies at Athens, excavating at a number of locales in the area around Kavousi. Azoria had evidently attracted her interest because of its complex chronology and position along important inland routes connecting the plain of Kavousi with the Siteia Mountains.<sup>2</sup>

1. Boyd 1901.
2. Boyd 1904, p. 29.

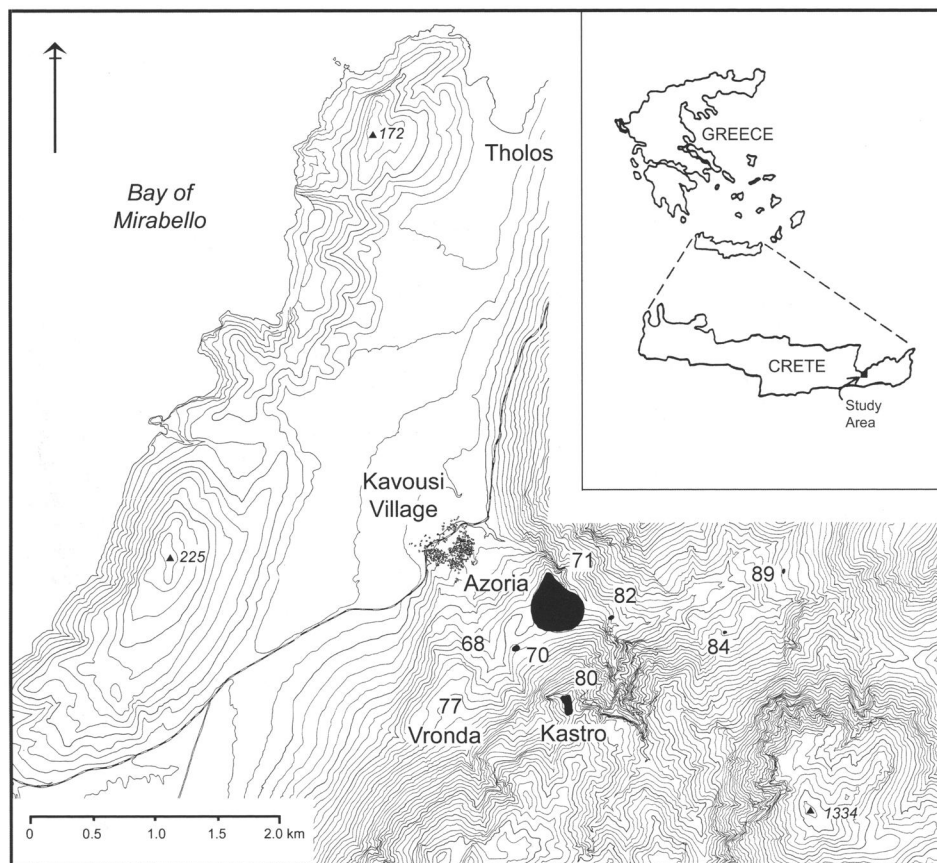

Figure 1. Map of Kavousi area showing the locations of Azoria (71), the temple at Pachlitzani Agriada (82), and other Orientalizing–Archaic sites. D. C. Haggis

Boyd excavated a roughly rectangular trench measuring about 300 m<sup>2</sup> located in the center of the summit of the South Acropolis (Figs. 2, 3). Here she uncovered a deeply stratified and puzzling series of walls that seemed to form the foundations of three circular structures overlying at least two earlier phases of building. Boyd unfortunately did not publish illustrations or detailed descriptions of the artifacts from these excavations, although she proposed a Late Mycenaean and Early Iron Age date for pottery recovered from the buildings' earliest levels.<sup>3</sup>

The current reinvestigation of Azoria by the American School of Classical Studies has its roots in an intensive survey of the Kavousi area conducted by Haggis between 1989 and 1992. This survey revealed the large size of the site, its complex settlement history, and the long duration of occupation, which spanned the Final Neolithic, Bronze Age, Early Iron Age, and Archaic periods.<sup>4</sup> The regional survey demonstrated that the stable and constant system of clustered agricultural villages characteristic of much of the Early Iron Age (ca. 1200–700 B.C.) gave way to a pattern of dispersal and gradual abandonment from 800 to 625 B.C.<sup>5</sup> The abandonment

3. Boyd (1901, p. 154) excavated aggressively on the hilltop, leaving architecture in situ, but reaching bedrock in all of her soundings, in some cases at a surprising depth exceeding 2 m. While the architecture recovered in this

trench is well preserved today, there is no visibly extant stratigraphy that might be examined in the current excavation. In 2002, members of the Azoria Project began a systematic cleaning and restoration of this architecture. Our

documentation of Boyd's early excavation will be published in a later report.

4. Haggis 1993, 1996, 2001.

5. All dates in this report, unless otherwise indicated or obviously recent, are B.C.



**Figure 2. Aerial view of Azoria, from the south.** Photo M. S. Mook

of these villages seems to have coincided with an increase in the size of the Azoria settlement, which we now estimate to have been as large as 15 ha in the seventh–fifth centuries. The rural sites that replaced the Early Iron Age site clusters were few and smaller in size. They seem to have been part of a weak, two-level hierarchy of settlement that emerged by the end of the seventh century (Fig. 1).

The results of the survey, in conjunction with excavations conducted from 1987 to 1992 at the neighboring sites of Vronda and Kastro,<sup>6</sup> have helped define an Early Iron Age settlement system characterized by discrete groups of sites centered on upland water supplies, arable land, and pasturage (Fig. 1). These communities practiced a mixed household agropastoral economy.<sup>7</sup> Although the settlement at Vronda (Fig. 1:77) was abandoned at the end of Late Minoan (LM) IIIC, the continued use of the site as a cemetery during the Early Iron Age and Orientalizing phases may be an indication of strong social links, perhaps kinship ties, persisting between settlements in the area until the seventh century, when the burials ceased.<sup>8</sup> Excavations at the neighboring site of the Kastro (Fig. 1:80) have revealed a contraction and abandonment of settlement from 725 to 625, reinforcing the idea of a long-term shift of population to Azoria at the end of the Early Iron Age.<sup>9</sup> The large size of Azoria, which is roughly 10–15 times larger than adjacent Early Iron Age sites, leads us to hypothesize that a nucleation of population and attendant processes of urbanization were under way here during the Archaic period.

6. Coulson et al. 1997; Gesell, Day, and Coulson 1983, 1985, 1988, 1990, 1995; Gesell, Coulson, and Day 1991.

7. Flint-Hamilton 1999, 2000; Snyder and Klippel 1999; Klippel and Snyder 1991, 1999; Haggis 1993, 2001; cf. Wallace 2001; Nowicki 1999, pp. 157–169; Foxhall 1995; Donlan and Thomas 1993; Garnsey and Morris 1989, pp. 99–103; Cherry 1988.

8. Gesell, Day, and Coulson 1995, pp. 116–117; cf. Haggis 1993, 2001.

9. Mook 1994; 1998, p. 45; Coulson et al. 1997; Gesell, Day, and Coulson 1995, p. 119.

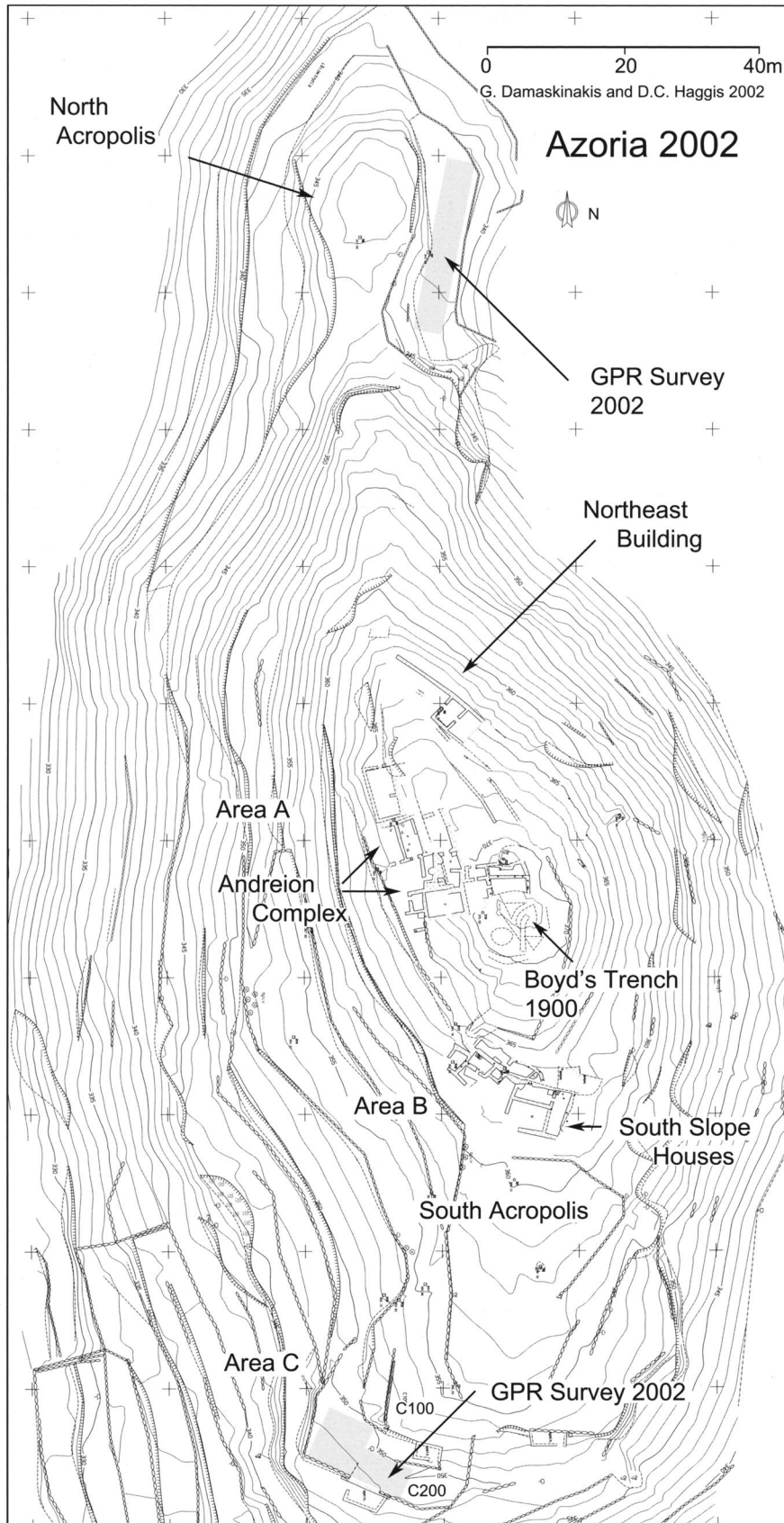

Figure 3 (*opposite*). Topographical plan of the North and South Acropoleis. G. Damaskinakis and D. C. Haggis

The current excavation is part of an initial five-year work plan (2002–2006) to explore stratigraphically the process of nucleation and the local consequences of changes in rural settlement and land use associated with the formation of a small urban center. The relationship between the urban and rural cultural spheres has implications for understanding changing systems of land use through time and for defining the structure of economic and political power in the early city. At the heart of the research design is the study of the new civic identity that emerged following the demise of the Early Iron Age village clusters.

## RECENT PHYSICAL AND CULTURAL TOPOGRAPHY

The hilltop of Azoria consists of alternating outcrops of gray dolomite, bluish gray crystalline limestone, and phyllite, rising steeply east of the alluvial ridge where the modern village of Kavousi lies. The slopes of the hill on the northern and eastern sides descend sharply into the river valleys draining from the mountain watersheds of Avgo and Ayios Niketas. The precipitous cliffs of the Kastro dramatically overshadow the site to the south.

Ancient walls and pottery sherds are concentrated on the surface of Azoria at an elevation of approximately 320–370 m above sea level. The site visibly extends across 15 ha from Panagia Skali (Fig. 1:70) in the west to Pachlitzani Agriada (or Makellos) in the east (Fig. 1:82).<sup>10</sup> The access to the site from the south is a well-constructed cobble path, or *kalderimi*, of Venetian date. This path passes through an abandoned hamlet that may have been occupied as recently as the Ottoman period.

The hilltop of Azoria, now crowded with dense garigue and maquis vegetation (thyme, sage, burnet, broom, carob, wild olive), has not been used for agriculture for at least a generation, although the regular series of agricultural terrace walls encircling the site testify to previous use of the area for extensive barley cultivation (Figs. 2, 3).<sup>11</sup> Some olive, almond, and fig trees are scattered on the lower terraces of the hill. Beekeeping has been both a recent and traditional occupation, owing to the density of thyme bushes that have overtaken the hill following successive periods of intensive browsing of sheep and goat. Although the site appears to have been occupied sporadically from the Byzantine to modern period, the condition of Azoria a hundred years ago was probably little different from what one sees today.<sup>12</sup>

10. Pachlitzani Agriada, at the base of the Azoria hill, is the location of an important Geometric–Archaic rural temple of Eileithyia excavated by Alexiou in 1950; see Alexiou 1956; Drerup 1969, p. 8; Mazarakis Ainian 1997, p. 212.

11. Landowners and their descendants remember clearing the terraces and planting barley at Azoria before

World War II. After the war, agricultural use of the site largely came to an end. Some areas were leased to local shepherds, except for the lowest terraces, which were planted in olives in the late 1960s and early 1970s. Boyd (1901) mentions no agricultural use of the site.

12. Boyd 1901, p. 150.

## PROJECT GOALS

Excavation at Azoria has been undertaken with two primary goals. One is to explore the nature of Archaic settlement on Crete, focusing on the significant cultural changes taking place ca. 600 B.C. The Early Iron Age (ca. 1200–700) and Orientalizing (ca. 700–600) periods on the island exhibit an unusual density of habitation sites, early urbanization, and a dynamic mixing of indigenous, mainland Greek, and Near Eastern cultural influences. These conditions contrast dramatically with those of the sixth century, an era of apparent occupational discontinuity.<sup>13</sup> While recent reviews of the evidence for the Archaic period in the Aegean have demonstrated problems and inconsistencies in the type and quality of archaeological data available,<sup>14</sup> the scarcity of occupational evidence is particularly noteworthy on Crete, where the sixth century has long been considered a critical chronological gap, a veritable “period of silence,” or even a second “dark age.”<sup>15</sup> While the lack of evidence for settlement in this period may be partially attributable to the vagaries of archaeological exploration,<sup>16</sup> a number of scholars have postulated plausible historical models and fascinating environmental, military, and economic scenarios to account for the apparent depopulation and occupational hiatus in Crete ca. 600 B.C.<sup>17</sup>

In his study of regional ceramic styles in Late Archaic and Classical Crete, Brice Erickson concludes that the assumption of an island-wide hiatus is a grossly distorted, Knossos-centric view deserving critical reevaluation through systematic excavation.<sup>18</sup> Results of recent surveys at Praisos, Vrokastro, and Gournia, along with excavations at Kommos and Itanos, also suggest that the assumed gap in settlement may ultimately prove illusory.<sup>19</sup> Yet localized discontinuities are nonetheless apparent. In

13. Sjögren 2001; Nowicki 2000; Hoffman 1997, pp. 255–260; Prent 1996–1997; S. Morris 1992, pp. 151–194; Whitley 1991, pp. 181–198; Coldstream 1984, 1991. See Camp 2000, pp. 48–49, for discussion of the Early Iron Age and Archaic periods on Crete as contexts for the analysis of city-state formation.

14. For comprehensive surveys of Archaic Crete, see most recently Sjögren 2001; Morris 1998. See Perlman 2000 and 2002 for surveys of the evidence for the development of Gortyn from the Early Iron Age until the Archaic period.

15. Coldstream and Huxley 1999; Morris 1998, pp. 65–66; Perlman 1993, pp. 202–203; S. Morris 1992, p. 169; Coldstream 1991, p. 298; Stampolides 1990. The pattern is, however, highly variable. The Vrokastro area in eastern Crete witnessed a restructuring of settlement but not abandonment

(Hayden, Moody, and Rackham 1992, p. 329). Hayden’s (1997) survey in Meseleroi is of considerable importance as it is to date the only project to model Archaic settlement patterns in Crete.

16. The perceived gap is also related to the historiography of Cretan archaeology; the emphasis on Minoan remains has led to the marginalization of the material culture of the Iron Age, Archaic, and Classical periods. The study of these periods in Crete has fallen outside the mainstream discourse in classical archaeology (cf. Alcock 2002, pp. 100–101; S. Morris 1992, p. 183). Characteristic of this trend is Osborne’s puzzling omission of Crete in his recent survey of Greek archaeology (2004). Osborne’s study ignores the past decade of work focusing on precisely the issues emphasized in his essay: ceramic regionalism (Erickson 2002), ritual and memory (Prent 2003; Watrous 1996, 1998), literacy and

social organization (Perlman 2002; Whitley 1997, 1998b), economy and regional structure (Chaniotis 1999b; Viviers 1994, 1999), urban and regional surveys (Greco et al. 1996, 1997, 1999, 2000; Whitley, Prent, and Thorne 1999; Hayden 1997), diachronic comparative perspectives (Alcock 2002, pp. 99–131; Bennet 1990; cf. Alcock 1999, p. 179), and the Greek sanctuary (Shaw and Shaw 2000).

17. Erickson 2002, p. 86; Coldstream and Huxley 1999; Prent 1996–1997; Huxley 1994, pp. 128–129; S. Morris 1992, pp. 169–172; Morris 1998, pp. 65–66.

18. Erickson 2000, 2002.

19. Whitley, Prent, and Thorne 1999; Whitley 1992–1993, 1998a; Whitley, O’Connor, and Manson 1995; Hayden 1997; Watrous and Blitzler 1995; Shaw 2000; Greco et al. 1996, 1997, 1998, 1999, 2000.



the Greek sanctuary at Kommos, building begins in the latter half of the sixth century, following a significant and inexplicable gap from the end of the seventh century. At Praisos, Whitley and his survey team suggest that the essential form of the city was established by the Late Geometric period (ca. 770–715 B.C.), but pending the complete study and publication of the ceramic sequence and the distribution of sixth-century pottery, the transition from the seventh to the sixth century and the configuration of the settlement in the sixth and fifth centuries remain obscure.<sup>20</sup> At Itanos, the most compelling evidence for the transitional period comes from stratigraphic excavations in the north necropolis (phases II and III), where new building foundations were constructed in the late seventh or early sixth century. This was followed, however, by a destruction in the early fifth century, an intriguing pattern that echoes our findings at Azoria.<sup>21</sup>

The foregoing evidence suggests that the apparent gap in late-seventh- and sixth-century occupation at many sites on Crete may be related to real stratigraphic and historical discontinuities and, perhaps to a lesser extent, to problems in identifying sixth-century ceramic forms.<sup>22</sup> One of the objectives of the Azoria excavation is thus to assess the evidence for the sixth-century discontinuity through diverse and intensive sampling strategies and to reevaluate its significance in light of contemporary sociopolitical changes taking place in the seventh-century B.C. Aegean and eastern Mediterranean.<sup>23</sup>

The other goal of the excavation is to study the urbanization processes that preceded the sixth-century discontinuity, examining changes in the economy and formal structure of the settlement from LM IIIC (ca. 1200–1050 B.C.) through the Orientalizing period. In the Aegean, the problem of city-state formation involves a multilateral discourse encompassing historical, archaeological, and anthropological perspectives.<sup>24</sup> Local environmental variations notwithstanding, early Greek cities generally seem to have functioned as economic and political centers of small territorial polities with complex agricultural and exchange systems. The broad aims of the Azoria Project are to test hypotheses of urbanization derived from survey, design models of the formation of the city, reconstruct details of the political economy of the center, and elucidate the changing relationship between the center and its hinterland.

The site of Azoria has three primary advantages for the study of urbanization. First, the scale of settlement is small enough to permit us to investigate thoroughly a number of specific architectural components of the site's economic, social, religious, and political organization. Second,

20. Whitley, Prent, and Thorne 1999, pp. 252–253.

21. Greco et al. 1998, p. 596; 2000, pp. 551–555. Pottery deposits have not yet been published in the Itanos preliminary reports, and the evaluation of this building sequence must await publication of the finds.

22. Erickson's (2000) study of Archaic and Classical pottery provides a

starting point for considering regional ceramic sequences and dispelling the notion of a gap or abandonment at many sites. However, the ultimate usefulness of such chronologies and the reconstruction of archaeological contexts requires reevaluation through systematic excavation, as well as definition of the complex formal transitions in both the Orientalizing and Classical periods.

23. Cf. Whitley 2001, pp. 168–174; Vink 1996–1997; Osborne 1996–1997; Van der Vliet 1996–1997; Osborne 1996, pp. 200–201; cf. S. Morris 1992; Sherratt and Sherratt 1993.

24. E.g., Mitchell and Rhodes 1997; Andersen et al. 1997; Small 1995, 1997; Snodgrass 1977, 1987, 1991, 1993; Coldstream 1984, 1991; Morris 1991.

because of the intensity of previous survey and excavation in the surrounding area, the regional archaeological and historical contexts are sufficiently established to allow a meaningful assessment of the socioeconomic relationships between the site and its hinterland. And third, the lack of extensive subsequent occupation on the site (in Roman, Byzantine, Venetian, and modern periods) indicates a largely pristine or abandonment-phase condition. This rare state of preservation permits us to address questions concerning not only the foundation and development of the settlement, but also the historical causes of its abandonment in the fifth century.

Our immediate aim, however, is to recover data concerning subsistence and production behavior that will help us understand the changes in social structure and economic organization that took place as Azoria became the center of an integrated territory and a participant in the complex exchange systems of the wider Aegean and Mediterranean regions. By relating differential patterns of crop processing and animal husbandry to models of land use and power relationships, it may be possible to identify corporate groups and to define the organizational structure of the emerging city. While we are still in the process of studying the plant and animal remains recovered from work in 2002, the first season's results have shown the great potential of recovering subsistence data from different contexts of production and consumption in both the domestic and civic spheres.

Recent studies of early state-level polities, including those of the Aegean, have concerned themselves more with the function and complexities of political economies than with simplistic developmental models of hierarchical organization.<sup>25</sup> Diachronic studies of urbanization, interaction between urban and rural sites, and agropastoral systems may yield numerous insights regarding changes in social organization and power relations in emergent state societies.<sup>26</sup> Recent approaches to Greek city-state formation (ca. 800–600 B.C.) have differentiated diverse patterns of emerging complexity as distinct and often separate phenomena from the institution (and artifact) of the city itself.<sup>27</sup> These studies have recognized the importance of agriculture and exchange systems in defining the form and function of the urban center.<sup>28</sup>

Patterns of agricultural production and animal husbandry and the details of food mobilization and food-processing can reflect complex social relationships in the emergent city.<sup>29</sup> Although urbanization itself may constitute only one aspect—or expression—of ideological and political power, it is nevertheless an important archaeological context for unraveling the structure of the city-state and its changes through time.<sup>30</sup> Azoria affords an important opportunity to study urbanization in the Early Iron Age and Archaic Aegean, focusing on agricultural specialization and exchange as operable mechanisms of elite appropriation and control, the consumption of agricultural surplus, and the changing nature of urban-rural relationships as new systems of staple finance and wealth distribution were implemented.<sup>31</sup> The Azoria Project aims to trace the development of a single polity by analyzing changes in economy and social structure, using the results of the excavation to shape a model of urbanization that emphasizes the role of human agency—in terms of the control and management of labor and agricultural and pastoral resources—in processes of sociopolitical change.<sup>32</sup>

25. Schoep 2002; Stein 1994b; Blanton et al. 1996; Cowgill 1993.

26. Cf. Stein 1994b; Yoffee 1979, 1993.

27. E.g., Morris 1991.

28. Garnsey and Morris 1989; cf. Snodgrass 1991. For Crete, see perspectives offered by Camp (2000, pp. 48–49) and Perlman (2000, pp. 59–63).

29. Halstead 1981, 1988; Gumerman 1997.

30. Yoffee 1979, 1993; cf. Schwartz 1994.

31. Stein 1994a; Schwartz and Falconer 1994; Schwartz 1994; D'Altroy and Earle 1985; Earle 1987.

32. Cf. Jameson 1992; Garnsey and Morris 1989.

## METHODS

Surface finds of cultural material (primarily sherds, stone tools, metals, and architecture) cover an area of about 15 ha at Azoria. The zone acquired for excavation in 2002 consists of the hilltops and immediate slopes, about 2 to 3 ha in area, encompassing both the North and South Acropoleis (Fig. 3). The primary goal of our sampling strategy is to investigate contexts that will permit the study of functional differentiation of architectural spaces across the site, the spheres of domestic, civic, and cultic activity, and the relationship between public and private space. Given the unevenness of the terrain and the exposure of architecture across much of the surface of this target area, we defined trenches by readily observable architectural spaces rather than by a measured grid. This flexible definition of the size of sample units required trench lines, datum points, benchmarks, and survey points to be located with a Total Station as needed during the course of excavation. Although this method emphasizes the excavation of distinctive architectural units and the study of diachronic changes in their form and function, our focus on crop and livestock processing also necessitates the excavation of large, contiguous interior and exterior spaces and the measurement of the total volume of matrices excavated in those spaces.

Our principal objective in 2002 was to begin exploring the topography of the Archaic town and the stratigraphy of the site. Trenches were located within three broad sampling areas on the South Acropolis labeled as areas A, B, and C on the topographical plan (Fig. 3). Area A consists of the northern part of the South Acropolis, including part of the hilltop where Harriet Boyd had originally excavated in 1900 (A100; Boyd 100, 200), the west slope (A600, A800, A900, A1100–1600), and the northeast slope (A200–500, A700, A1000). Area B is the south slope of the peak of the South Acropolis (B100–500). Area C is the southwestern edge of the South Acropolis, containing two test trenches (C100, C200).<sup>33</sup> The present report focuses on areas A and B (see below, Fig. 5).

Consistent excavation and sampling methods were employed throughout these units. With the exception of samples collected for flotation (water-sieving), 100% of the sediment matrices in all stratigraphically significant deposits, or what we call “intensive sampling loci” (e.g., floors, habitation debris, ceiling debris, wall collapse and tumble, floor packing, hearths, bins, vessels in situ, fill deposits), were dry-screened with a quarter-inch sieve, and all artifacts, stone tools, bones, and large botanical finds such as olive stones were collected.<sup>34</sup> Each of six trenches being excavated simultaneously had its own sieve in operation. A sieving team, usually consisting of two individuals, conducted the dry-screening under the supervision of science director Lynn Snyder or bioarchaeologist Maria Liston. The total volume of all matrices of all loci (stratigraphic units) was measured during the dry-sieving stage by counting standard 20-liter buckets (*zembilia*). A minimum of 2,649 *zembilia* of soil (ca. 53,000 l, or some 64 tons) was screened in 2002, maximizing the recovery of bones of small animals and fish, and shell fragments.

With this rigorous daily sampling in mind, special shaker screens (Fig. 4) were designed by the excavation foreman, Manolis Kasotakis, in

33. Geophysical prospection with ground-penetrating radar (GPR) was conducted on the North Acropolis and in area C on the South Acropolis (Fig. 3), with encouraging results: anomalies indicating subsurface linear accumulations. The GPR work was conducted by Antonia Stamos of Temple University. The results of this work will be published in a subsequent report.

34. Surface soil, eroded levels, and recent slopewash debris were not dry-screened systematically. Five-liter standard samples were, however, retained from such deposits for flotation.



**Figure 4. Shaker screen.** Photo M. S. Mook

consultation with the field director. The screens are made of aluminum—and thus reasonably easy to move around the site—and consist of three basic parts: (1) a removable screen inset that has a  $1.00 \times 0.61$  m framework to which wire mesh is fixed with bolts, rivets, or solder; (2) a removable frame, 0.15 m deep and lined with a coarse hardware cloth, into which the screen inset is placed (and removed for cleaning, repair, and replacement); and (3) a four-legged base, which has an opposing set of swinging axles designed to hold the frame in place, suspending it over the discard pan, which slopes at an angle. The removable frame allows for easy cleaning (and dumping of coarse stone debris), while the discard pan contains and channels the fine dirt directly into a discard chute or wheelbarrow.

Flotation samples were also collected from “intensive sampling loci.” Soil was routinely retained in the form of 5-liter standard samples from every locus excavated, while targeted or intensive sampling was conducted in definable features and stratigraphically significant loci such as floor deposits, destruction debris, and closed contexts. Intensive samples consisted of an average of 20 liters per locus, but some were as large as 100 liters. In 2002, a total of 469 soil samples were taken for flotation, out of which 160 (or approximately one-third) were standard samples, while 309 (or about two-thirds) were intensive samples.

Flotation was conducted at the INSTAP Study Center for East Crete. The flotation system used to process the samples employed a variant of the widely used barrel-type machine, in which a constant flow of water enters the barrel through a submerged pipe with a perforated head and exits over a baffle.<sup>35</sup> A screen with a 1/16-inch mesh is used to catch the heavy fraction (residue), while the light fraction (flot) is caught in a sieve

35. Pearsall 2000, pp. 44–52.

lined with nylon cloth attached to the baffle. Systems of this type have been demonstrated to have very high recovery rates (usually above 90%) of even the smallest seeds.<sup>36</sup> The light and heavy fractions are allowed to air-dry in the cloth or sieve in which they are captured and are then transferred to bags for further processing. Under the direction of the Azoria Project archaeobiologists, the residue we recovered is being hand-sorted at INSTAP-SCEC to recover bone, shell, carbonized plant remains, and small artifacts. The entire light fraction is being sorted by microscope (10×–40×) at INSTAP-SCEC and the Research Laboratories of Archaeology at the University of North Carolina at Chapel Hill.<sup>37</sup>

## THE SPINE WALL

At the outset of excavation in area B (B100–500), we discovered parts of three separate Archaic buildings sharing a massive central wall that forms the back of the structures on either side of the wall (Fig. 5; also below, Figs. 6, 7). This wall, which we have called a “spine wall,” conforms to the natural bedrock contour, extending east–west along the south for a distance of some 20 m before turning sharply north along the west side of the hilltop. While this wall must have served a retaining function, effectively stabilizing the slope and permitting building on terraces, the wall was clearly also the core element along which the buildings of the South Acropolis were constructed. Further excavation to the north, in area A, exposed two other 20-m-long segments of the wall. One of these bisected the building complex on the west slope (A600, A1200, A1500, A1600). Another segment in the northeast, visible during the surface survey in 1991, served as a retaining wall for the houses there (A300–500, A700, A1000). Several other sections of the wall have not yet been excavated but are partially exposed on the surface of the hilltop, allowing us to reconstruct an unbroken circuit 200–250 m long that runs roughly the full extent of the 364–365 m contour and forms two building levels, one above the wall and the other below.

36. Wagner 1982.

37. The remarks in the following pages concerning the distribution and abundance of plant materials are based on M. Scarry’s preliminary analysis of 102 light fraction samples, representing a total of 1,314 liters of floated matrix. The information should be regarded as subject to revision, as seeds from the heavy fractions of many samples have not yet been sorted, and there are numerous samples for which neither light nor heavy fractions have been sorted. Moreover, seeds are generally sparse in the samples, and the cereals and pulses that do occur are often broken. These specimens need to be reexamined to confirm the identity of the grains and to determine which pulses (e.g., lentil, pea, bitter vetch) are represented.

The wall was built in regular horizontal courses bonded by mud mortar. Several courses are preserved. The building blocks include large cobbles and boulder-sized stones of local dolomite and limestone, with the average length and height of individual stones measuring about 0.80 m. With a preserved height of up to 1.50 m, the wall creates impressively sturdy facades. Some segments are truly megalithic in proportions and appearance, with boulders exceeding 1.20 m in length or height. Cobbles were used in some cases to fill irregular gaps and interstices between the larger stones. At some points along the circuit, the wall clearly has two well-built faces, but at other points, where it is preserved as a retaining or foundation wall, there is only one. The segment exposed on the west slope has a very regular appearance and probably represents the original form of the wall in the early sixth century. Here the stones are uniform in dimension (ca. 0.50–0.80 m in length) and, with few exceptions, the coursing forms even rows. The southern segment running through the houses in area B is less regular in appearance because of building renovations at the end of the sixth century, when the wall was repaired with smaller stones in some places.

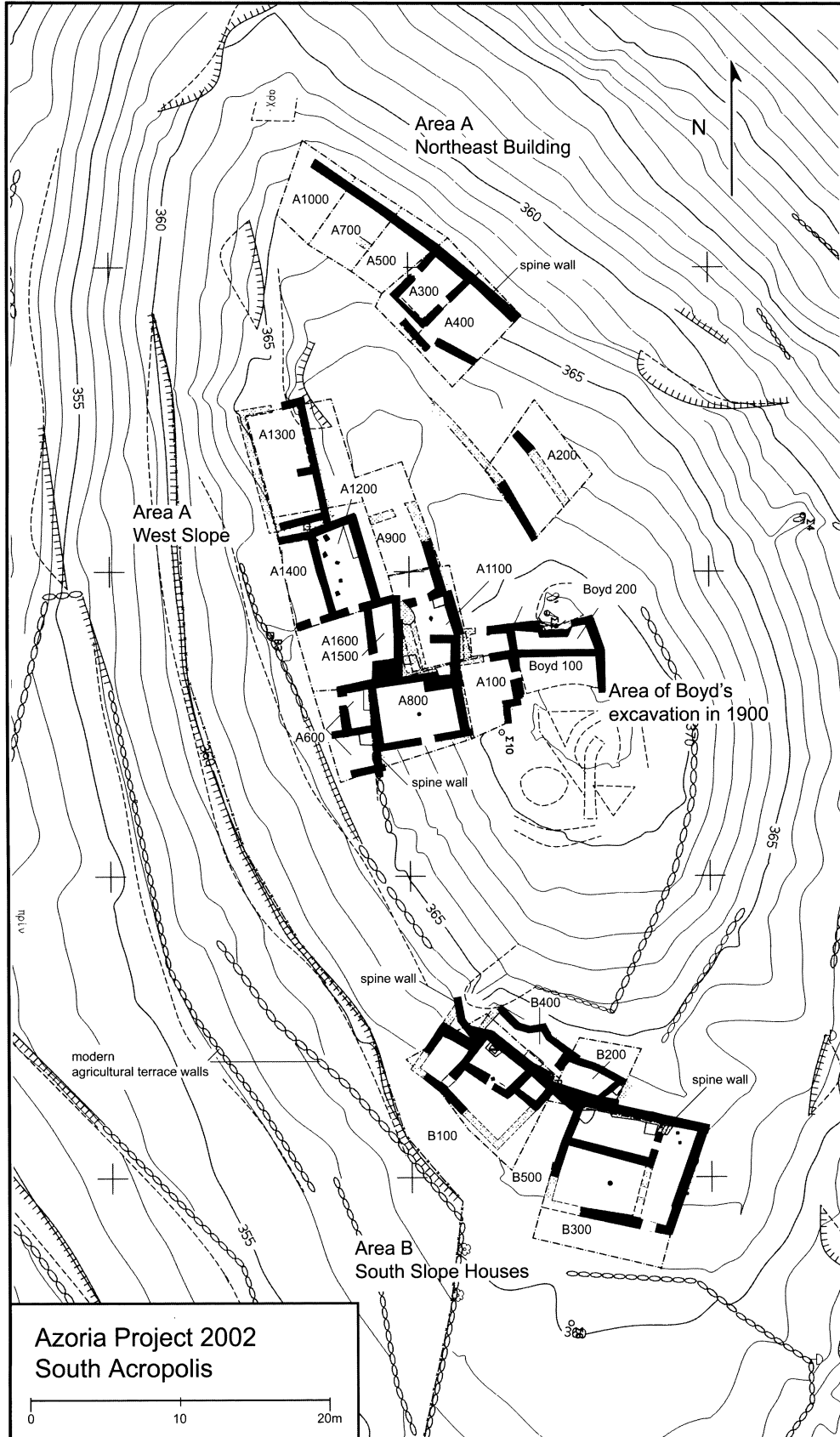

Figure 5 (*opposite*). Plan of the South Acropolis: Areas A and B. G. Damaskinakis and D. C. Haggis

The spine wall is striking in both the ambitious modification of the terrain that its construction entailed and in the imposing facades that it would have presented on the uppermost terraces of the site. Similar megalithic retaining walls were exposed further down the slope from area B in test trenches on the southwest edge of the South Acropolis in area C (C100–200). This suggests that the spine wall on the hilltop was only one of a series of concentric circuits that may have been an essential part of the reorganization of the settlement at the end of the seventh century.

An obviously similar form of urban planning is apparent at the neighboring site of Lato, where the houses on the slopes north and west of the agora were built in rows contained by a regular series of monumental concentric walls conforming to the contours of the hill.<sup>38</sup> The site of Vroulia on the island of Rhodes, while not as rugged in topography, provides another contemporary (seventh–sixth-century) parallel for the use of spine walls at Azoria.<sup>39</sup> At Vroulia, a 170-m-long wall, described as an *enceinte* by the excavator, physically connects the buildings on the north side of the settlement, while another 40-m-long segment to the south—anchoring a parallel row of houses—reduplicates the arrangement, suggesting that the use of such walls was an important aspect of planning at the site.<sup>40</sup> A “spine wall” segment connecting a cluster or row of four contiguous houses, attributed by the excavator Platon to the late seventh century, is also evident at Onythe Goulediana in western Crete,<sup>41</sup> while at Corinth, the seventh–sixth-century houses 2 and 3 show a similar arrangement.<sup>42</sup> Finally, recent survey in the Meseleroi valley in eastern Crete has also recovered evidence for the use of spine walls in the Archaic settlements in the hinterland of ancient Oleros.<sup>43</sup> Architectural terrace walls used to level uneven terrain and to permit the construction of regular axial house plans seem to be an essential aspect of early Greek architecture on Crete. This tradition has its roots in the Protogeometric and Geometric periods and perhaps continues into Classical and Hellenistic times at Lato.<sup>44</sup>

The spine walls at Azoria show a similar response to topography, but the end result is rather different. The walls are megalithic, if not in some cases monumental, in form; they are also consistent in construction technique across the site and synchronous in date. While architectural regularity and repetition of form are part of the design, the overall effect is neither one of convenience nor of necessity. The buildings accommodated by the spine walls are not restricted by the terrain, and their plans do not conform to the exigencies of the slope. The spine wall seems to be an important

38. Ducrey and Picard 1996, pp. 752–753; Picard 1992, p. 158; cf. P. Demargne 1929; J. Demargne 1903; Hadjimichali 1971. While Lato’s houses are generally dated to the fourth century B.C., the recovery of Geometric and Orientalizing remains suggests the possibility that the essential form of the city was established earlier.

39. Kinch 1914, pp. 112–114. The houses at Vroulia are built contiguously

in rows, sharing long segments of walls that form the back of the houses; the interior house walls, which are only half the thickness of the long walls, are built as perpendicular projections.

40. Whitley 2001, p. 171; Lang 1996, pp. 60–62; I. Morris 1992, pp. 174–199.

41. Morris 1998, pp. 63–64; Platon 1956, p. 227; for other possible examples of the arrangement on Crete, see Levi 1930–1931, on Axos, and Lebessi

1973, p. 457, on Afrati.

42. Williams and Fisher 1972, pp. 145–147.

43. Hayden 1997, pp. 130–131.

44. Geometric examples are known in the Lower Settlement at Vrokastro and on the east and west slopes of the Kastro at Kavousi. See discussion in Hayden 1983, pp. 382–386; Coulson et al. 1997, pp. 352–353; cf. Jameson 1990.

part of the rebuilding of the site at the end of the seventh or beginning of the sixth century, a reorganization of space that is physically unifying. In its modest expression of planning and monumentality, the spine wall may have had a symbolic function as well, serving to articulate the identity of the community and the new social, administrative, and managerial roles and responsibilities of its members.<sup>45</sup>

### SOUTH SLOPE HOUSES IN AREA B (B100–500)

Excavation in area B, on the south slope of the South Acropolis, was conducted in five contiguous trenches (Figs. 3, 5). The spine wall runs east–west along the contour, linking the buildings and shaping the topography of the south slope. Two houses abutting the spine wall on the south side, one in B100 and the other in B300, are separated by a wide alley or courtyard (B500) (Fig. 6). While the southernmost margin of trenches B100, B300, and B500 was not well preserved, having been subjected to the effects of plowing and severe erosion, there is sufficient architectural evidence to reconstruct the plans and use phases of the houses. A third house, immediately northeast of B100, abuts the spine wall on its northern face. Only two rooms of this house (B200 and B400) were excavated in 2002.

#### EAST CORRIDOR HOUSE: B300

The largest building on the south slope, excavated in B300, consists of a two-room house with a spacious square room (ca. 42 m<sup>2</sup>) on the west and a narrower rectangular room or corridor (20 m<sup>2</sup>) on the east (Fig. 6). In a later phase, the large west room was divided by a cross-wall running east–west, while a stairway was installed in the northwest corner of the narrower east room, providing access to as yet unexcavated buildings on the terrace above and to the north.

The floor of the large room on the west is made of clay, leveling the uneven bedrock throughout. The position of internal wooden posts or pillars is indicated by two flat stones on the clay floor in the northern half of the room and by a circular cutting in the bedrock in the eroded southern half, where perhaps we can also infer a fourth that is now missing. These supports, spaced 3.0–3.5 m apart in the center of the room, would have accommodated the unusually large span. A similar placement of four pillars is a regular feature of the large rooms of houses at Onythe Goulediana.<sup>46</sup> In the northwest corner of this large room, built up against the northern and western walls of the room, is a hearth made of a bedding of phyllite clay bordered by fieldstones on the north and south (Fig. 7). The three stones in a row on the south side of the hearth are flat and could have functioned as work platforms, as a circular worked depression on the easternmost stone indicates. On the eastern side, a single elongated stone juts out at an angle in front of the mouth of the hearth, forming a heat shield.

The east and west rooms were connected by a doorway in the northwest corner of the east room, where a nicely worked threshold block and

45. Fagerström (1988, pp. 113–114) provides the most detailed discussion of spine wall construction in the Geometric and Archaic Aegean, linking the evidence of planning and architectural complexity with the organization of social units and the formation of a community identity in the emergent polis ca. 700 B.C.

46. Platon 1956, p. 227.



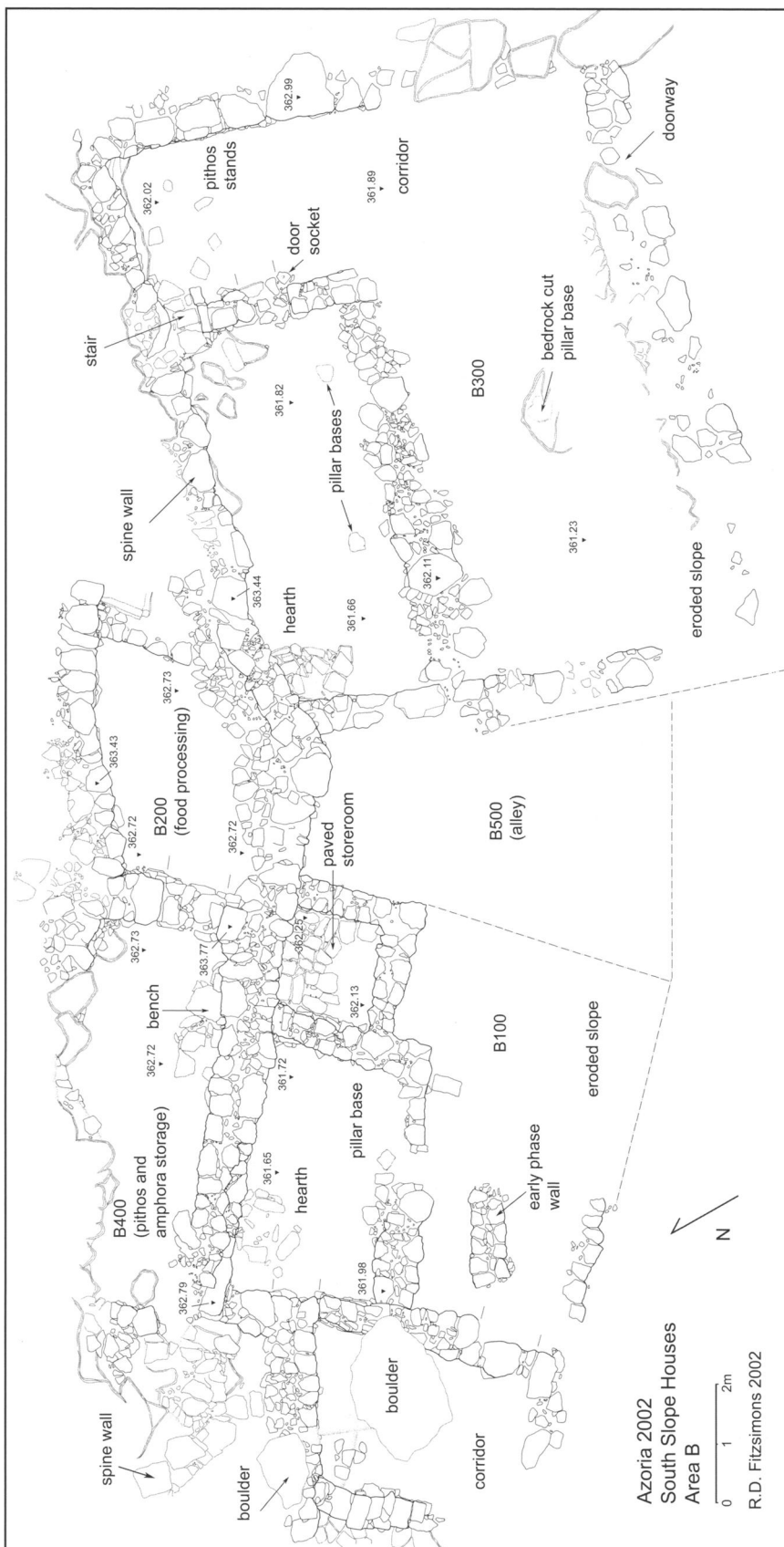

Figure 6. State plan of the south slope houses. R. D. Fitzsimons



Figure 7. B300: Hearth and spine wall. Photo M. S. Mook



Figure 8. B300: Corridor with pithoi, from the southwest. Photo M. S. Mook

door socket were found in situ. Two pithoi, one Archaic and the other a LM IIIC heirloom,<sup>47</sup> along with two groundstone tools (handstones), were found on the floor surface against the northern wall of the eastern room (Fig. 8). The pithoi are fragmentary and were found smashed amid burned clay and ashy soil. Removal of the pithoi revealed two large and two small paving stones, probably functioning as supports for the vessels.<sup>48</sup> Flotation

47. The pithos at the top and right in Fig. 8 is a typical local LM IIIC type with incised chevron bands and rope decoration; cf. Mook and Coulson 1997, p. 362; Haggis and Mook 1993, pp. 275–276. The LM IIIC pithos was some 700 years old at

the time of the abandonment of the room. This is an interesting instance of the recycling of artifacts, not only throughout the Early Iron Age, but also during the seventh century, when the settlement seems to have been radically rebuilt. For the pithos as a

high-value commodity in the Classical period, see Cahill 2002, pp. 226–227.

48. See Platon 1956, p. 227, for paving stones used as pithos supports in storerooms at Onythe.

samples taken from within and around the pithoi contained several wheat grains and grape pips, as well as a few small seeds from an as yet unidentified grass.

The pithoi in the east room were evidently crushed and scattered during a fiery destruction that seems to have consumed the site late in the sixth century. The intensity of burning in this event is visible in both rooms, where patches of reddish gray clay form a matrix with pieces of carbon or black ashy soil. At the end of the sixth century, the house underwent a significant renovation. The floor level was raised throughout the building, and an east–west cross-wall divided the large western room in half, obviating the use of the pillar bases. The doorway that connected the east and west rooms in the first phase continued in use, but the elevated floor level obscured the threshold block and pivot stone. Furthermore, the spur wall on the north side of the door was rebuilt, extending a few centimeters to the south over the threshold block. As part of this rebuilding, a stairway was constructed within the spur wall itself, creating a new access into the east room from the terrace above, which may have served as an exterior courtyard. The pithos fragments in the east room were buried in ceiling collapse and destruction debris, and a new surface was constructed over them, bringing the new floor level up to the level of the bottom step of the stairway.

The new rectangular north room, formed by the cross-wall bisecting the west room, had an area of 15 m<sup>2</sup>. The built hearth from the previous phase appears to have continued in use. Twenty grape pips and a single fragment of a cereal grain were found in flotation samples from the floor of this room. In the eastern part there was a large lekane with two registers of impressed relief decoration: one with a guilloche band, and the other with alternating cranes and sphinxes (Figs. 9, 10).<sup>49</sup> A concentration of olive stones was recovered from the soil surrounding the lekane. A pithos rim and neck fragment was also found in the abandonment phase; the neck has vertical registers with impressed antithetical spirals or volutes, recalling the “tree of life” motif (Fig. 11).<sup>50</sup> The Orientalizing motifs on the pottery from Azoria’s sixth-century deposits, especially the coarse storage vessels, illustrate the conservative character of Archaic material culture at this site. The motifs appear to draw on typical seventh-century decorative repertoires, but they could also reflect a continuing economic and cultural influence from the eastern Mediterranean on elite consumption patterns.<sup>51</sup>

49. See Anderson 1975, pp. 45–47; Schaefer 1957, pp. 31–35; and Savignoni 1901 for discussions of the Near Eastern and Egyptian elements in Cretan Archaic relief decoration, as well as examples of vessels with Orientalizing motifs similar to those on this lekane and the relief-decorated pithoi discussed below.

50. Brock (1957, pp. 183–184, pattern 16) presents an array of variations of this type of Orientalizing

motif (“volutes, sacred trees, etc.”).

51. S. Morris 1992, pp. 172–194; Demargne 1947, pp. 348–349; Levi 1945, p. 18; Kirsten 1942, p. 4. Shaw (2000, p. 693, n. 28) doubts Crete’s waning connections with the East in the sixth century, i.e., the cessation of ties because of shifting trade patterns and the western emphasis of Phoenician routes. Crete’s sixth-century role in the eastern Mediterranean has been modeled largely on negative evidence

and needs to be reevaluated in light of current work that targets the Archaic period on the island. The use or abandonment of Orientalizing motifs on the island in the sixth century may turn out to be more a matter of specific consumption patterns and contexts than of economy, chronology, or regionalism; however, see recent discussion in Erickson 2002, p. 79; Morris 1997; Whitley 1997, pp. 659–660.

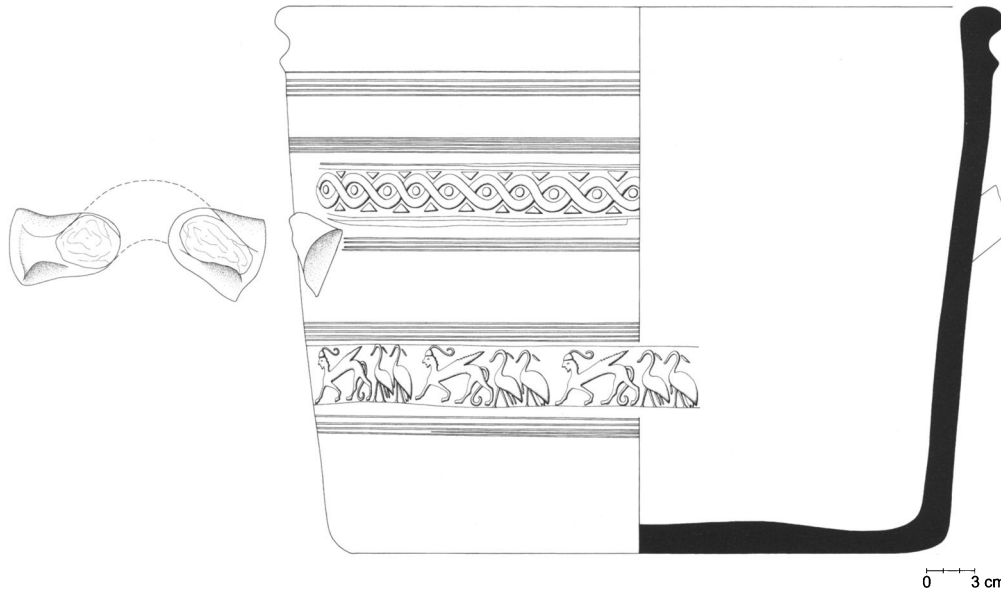

Figure 9. B300: Lekane. R. Docsan



Figure 10. B300: Lekane. Photo E. Attali and C. Papanikolopoulos

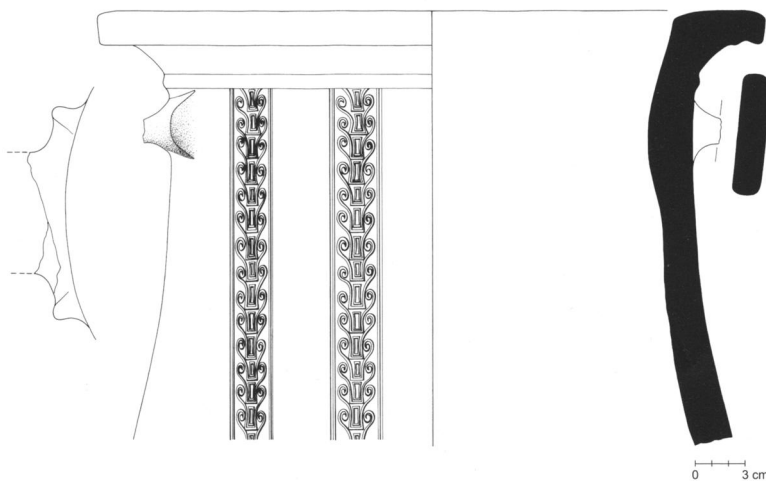

Figure 11. B300: Pithos rim and neck. R. Docsan

### WEST CORRIDOR HOUSE: B100

The northern wall of the house in B300 (the spine wall) runs west along the south slope until it turns northwest, forming the back wall of another house, separated from the first in B300 by an alley or courtyard (B500) (Fig. 6). The house in B100 has a ground plan similar to that in B300, but on a smaller scale. The original building was rectangular in plan, with its large main square room on the east side and a narrower rectangular room on the west—essentially a mirror image of the neighboring house in B300. As in B300, the doorway between the east and west rooms was placed to the north of center in the dividing wall. The large main room, in its earliest phase, was spacious, enclosing an area of about 28 m<sup>2</sup>. One pillar base (a limestone block) was preserved in the center of the room, indicating the placement of a roof support. Unfortunately, the southern half of the room, along with the entire southeastern corner of the building, had suffered disturbance from both plowing and erosion before excavation. Work in this area uncovered only the foundation or leveling stratum, consisting of the dense stone packing (pebbles and small cobbles) that we found beneath most of the seventh- and sixth-century buildings at the site. Removal of the stone packing, down to a depth of some 20 cm below the level of the preserved part of the eastern room, revealed an earlier segment of wall and an adjacent floor surface. The *terminus ante quem* for this earlier construction is the early sixth century. Much Early Iron Age pottery was recovered, however, from the eroded slope on the south, suggesting a possibly earlier foundation date for the structure. In the better-preserved northern half of the room, excavation revealed a buildup of three floor surfaces, spanning the sixth century and culminating in the renovation of the room in the late sixth or early fifth century.

The adjacent room to the west (Fig. 6), originally 11.25 m<sup>2</sup> in area, was exceedingly difficult to excavate because of two rather substantial boulders that had apparently fallen from the bedrock outcrop above and to the north of B100. The rocks were found lying directly on top of the collapsed walls in the southern area of the room, attesting to the rather dramatic consequences of an earthquake occurring after the building's abandonment in the first quarter of the fifth century. Even though the presence of these boulders precluded extensive exposure of the earliest sixth-century surfaces in this room, the later renovation is readily apparent. The western room was bisected with a cross-wall extending east-west from the building's west wall, across the room and into the doorway, blocking access to the east room of B100. The space between the new cross-wall and the spine wall was then filled. The renovation effectively reduced the size and perhaps even changed the function of the west room. A new doorway was also required in the southeastern corner of the room, where a large limestone threshold block abuts the south wall of the building.

The neighboring east room was also changed substantially in the fifth century. Although the erosion along the southern edge of the building precludes certain reconstruction of this area of the house, the large square was apparently subdivided into three rooms. The largest of the new rooms was rectangular in shape (ca. 7.70 m<sup>2</sup>). It was equipped with a built hearth



**Figure 12. B100: Detail of the hearth.**  
Photo M. S. Mook

in the northwest corner (Figs. 6, 12) and a doorway in the south wall. The hearth is constructed of two large, opposing limestone blocks, set against smaller cobbles carefully positioned between the hearth and the north wall of the building. As in the case of B300, a single stone heat shield juts out at an angle at the mouth of the hearth. The floor is made of phyllite clay, burned red from exposure to heat.

Reused pithos fragments, perhaps fallen from their position in the chimney, were found cradled in the hearth itself. The reused pithos is decorated in relief with a guilloche band and a register of cranes. The stratified sixth-century deposits in the room contained a good deal of lustrous black-gloss tableware (Fig. 13:1–3), including an Attic kantharos<sup>52</sup> (Fig. 13:2, Fig. 14) and a black-figure closed vessel (Fig. 13:3), as well as a variety of matt-coated open vessels. These are represented by high-necked (Fig. 13:4) and low-necked (Fig. 13:5) cup rims and various bases (Fig. 13:6–13), some of which surely belong to other types of cups and open vessels.<sup>53</sup> Several mortar (Fig. 13:14–16), lekane, and cooking vessel fragments were also found. Only a few flotation samples have been examined from the kitchen and hearth in this house. These have yielded a wheat grain, a fragment of a cereal grain, and a number of grape pips.

East of the room with the hearth is a smaller square room paved with limestone and schist slabs (Fig. 15). Its small size (2.25 m<sup>2</sup>) and paving

52. The authors thank Brice Erickson for visually confirming the identification of the fabric of this kantharos as Attic.

53. See Erickson 2002 for examples of the range of sixth-century open shapes he has identified from nearby Afrati and Kato Syme; see also Erickson 2000 for a broader range of regional variations from sites in

central and western Crete, along with Callaghan and Johnston 2000, pp. 249–252, for parallels to the late-sixth-century material. Late Archaic pottery from the town at Knossos, dated to the first two decades of the fifth century, is presented in Coldstream 1973 and Coldstream and MacDonald 1997. While this house in B100 yielded well-stratified depos-

its spanning much of the sixth century and the early fifth century, formal presentation of Azoria's ceramic sequence will not be made before the evidence is more complete, and continued excavation of the site confirms the stratigraphic and chronological observations made during the first season.

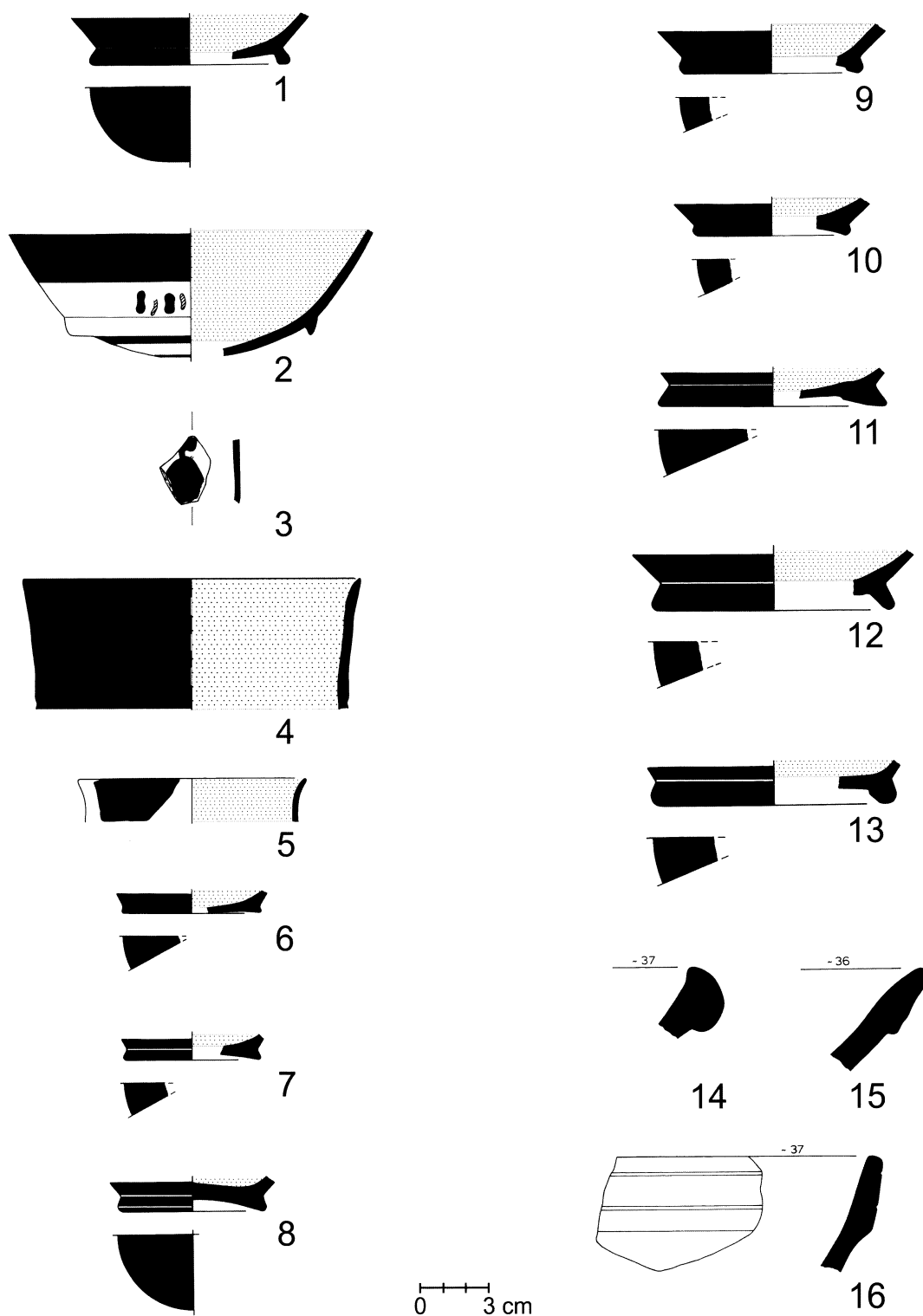
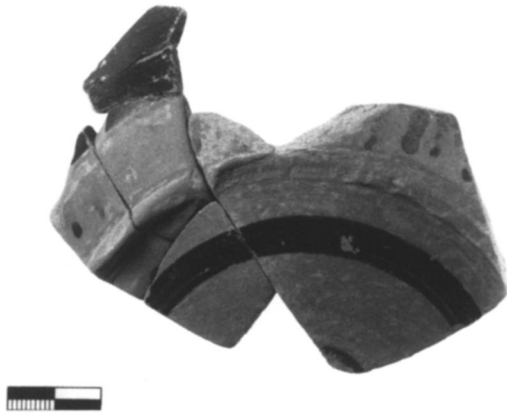

Figure 13. B100: Selected pottery from the room with the hearth.  
R. Docsan



**Figure 14. B100: Attic kantharos.**  
Photo E. Attali and C. Papanikolopoulos

stones suggest a convenient storage facility adjacent to the kitchen. While no doorway is obvious, the south wall of the room is preserved only to a single course, indicating the likely point of entry.<sup>54</sup> Thus, it is possible that both the room with the hearth and the paved storeroom were accessible from a single long room spanning the southeast side of the building.

The two houses in B100 and B300 are very similar in plan in their earliest phase; one large square room, with internal pillars supporting the wide roof span, forms the main hall of the house, while an off-center doorway connects the hall to a rectangular room, narrower in dimensions. Based on the evidence from the house in B300, this narrower room or corridor would have served a combined storage and work function, as well as affording the main access to the interior rooms of the house. The entrances to these buildings are not clearly discernible, but doorways in the south are likely, if unproven, given the poor preservation of the buildings along the southern edge of the south slope. In the subsequent late-sixth-century phase, internal modifications to the plan of the houses, while not exactly the same, demonstrate a tendency to divide and compartmentalize space, giving greater definition to storage, food-processing, and living areas. Similar complex house plans, consisting of a corridor giving access to one or more rooms, are apparent at Onythe Goulediana (rooms A, B, E, H), Aigina (houses 2 and 3), and Corinth (house 1).<sup>55</sup>

The corridor house is a definable type in the Aegean, and it may represent an important phase in the formal development of the Greek *pastas*, or courtyard house, of the fifth and fourth centuries. In tracing the origins of the latter, Nevett has emphasized the difficulty in reconstructing formal predecessors because of the lack of evidence from the sixth and early fifth centuries.<sup>56</sup> It may be that the corridor-house type, evident throughout the Meseleroi valley and at Onythe on Crete, as well as on the mainland, will help to fill this perceived gap in the development of the Classical courtyard house.<sup>57</sup> The corridor itself, evident in the south slope houses B100

54. See Kinch 1914, pp. 112–114, for the lack of visible doorways in storerooms at Vroulia on Rhodes; see also I. Morris 1992, pp. 193–195.

55. For use of the term “corridor-style” house and discussion of the type,

see Morris 1998, pp. 20–64; cf. Krause 1977, pp. 165–169.

56. Nevett 1999, pp. 162–163.

57. Morris 1998, pp. 20–21; Hayden 1997, pp. 128–129; Krause 1977, p. 169.





**Figure 15. B100: Paved storeroom, from the north.** Photo M. S. Mook

and B300 at Azoria, is essentially an enclosed *pastas*, a mediating or transitional element providing access to internal and compartmentalized spaces of the house.<sup>58</sup> In some examples, the corridor seems to have functioned as a kind of court or large vestibule, suggesting its purpose was both liminal and utilitarian, controlling access to the house's interior, while providing space for both work and storage.<sup>59</sup>

#### **SOUTH SLOPE HOUSE: B200 AND B400**

Immediately north of the houses in B100 and B300, on the opposite side of the spine wall, are two rooms of another house. These rooms, one in B200 and the other to the west in B400, used the spine wall as their southern limit (Fig. 6). The rooms are connected by a doorway. The room in B200, about 8.75 m<sup>2</sup> in area, has two distinct phases. The earliest so far excavated consists of a clay floor surface with evidence of burning associated with a late-sixth-century destruction at the site. The burning is attested by patches of ash, reddish gray clay, carbonized wood, and other plant fibers that may represent debris from the thatch underlying the flat clay roofs of the houses. The burned floor had one saddle quern against the south wall and another on the west side of the room, both in situ on the surface. The presence of the querns and a sparse but diverse collection of seeds from wheat, pulses, hackberry, olive, and grape suggest that this was an area where the final stage of food-processing took place, perhaps a kitchen. Just above the floor, amid the burned ceiling debris, a small stone grinding/pounding implement was also found.

The room was rebuilt following the late-sixth-century destruction, with wall lines only slightly deviating from their original plan. A clay floor was laid on top of the earlier destruction debris, and the room was evidently expanded on the eastern side, with the new surface extending over the earlier east wall. On the west side of the room, the doorway leading

58. The corridors within these south slope houses should not be classified as *pastades*, however, given that they seem to have served as enclosed storage areas as well as for communication between rooms; furthermore, they do not relate to interior courtyards.

59. Nevett (1999, pp. 68–69) and Cahill (2002, pp. 88–89, 99–100, 105–106) discuss uses of the *pastas*; cf. Hayden 1997, p. 129, for the use of the corridors in Archaic houses in Meseleroi.

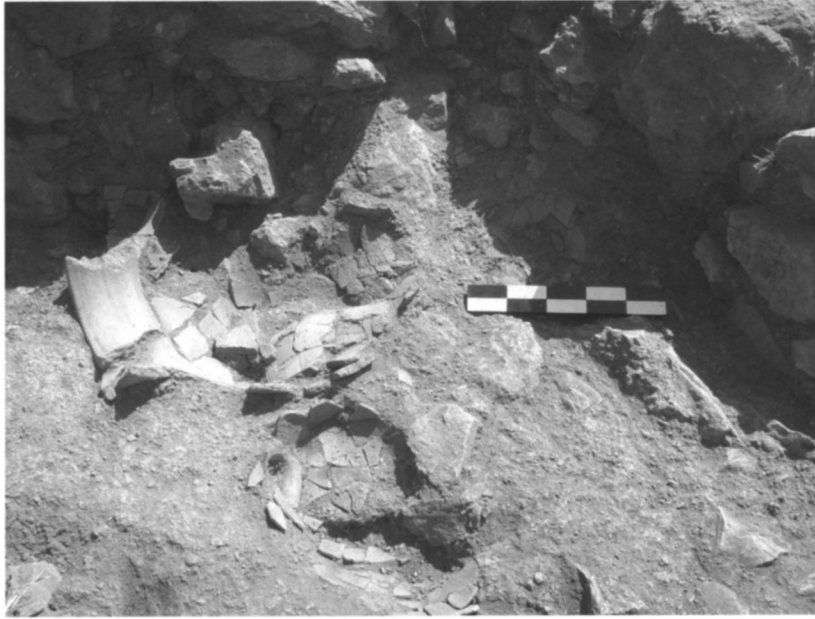

**Figure 16. B400: Storeroom with pottery deposit, from the south.**  
Photo M. S. Mook

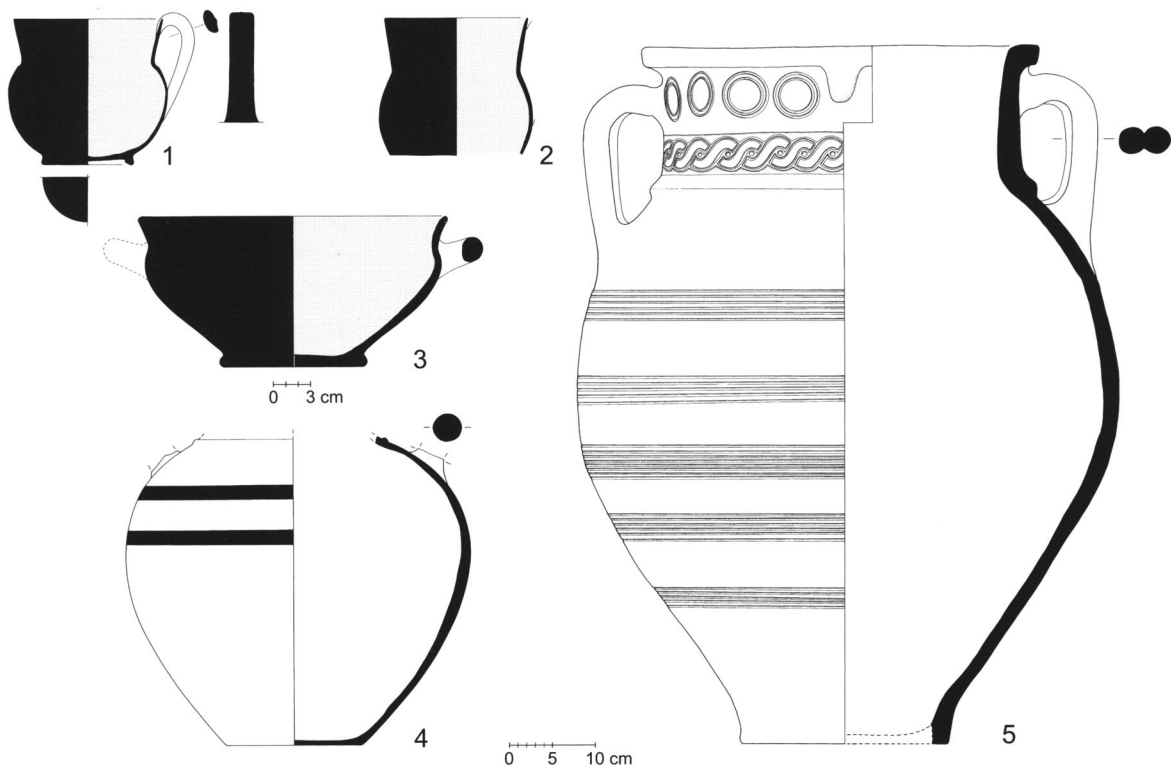

**Figure 17. B400: Selected pottery from the storeroom. R. Docsan**



**Figure 18. B400: Pithos from the storeroom.** Photo E. Attali and C. Papanikolopoulos

into the adjoining storeroom in B400 was partially blocked by the rebuilding of the western wall of B200, leaving only a threshold block, visible in the wall foundation, as evidence of this earlier entrance. The threshold was raised some 40 cm above the level of the new floor and was provided with a new threshold block and doorjambs.<sup>60</sup>

The neighboring room to the west in B400 is a storage area, connected by means of the doorway mentioned above (Fig. 6). While the east and west walls are preserved, the north wall consists of natural outcrops of bedrock with intermittent wall segments, the best preserved being in the northeast corner. A bench, built up against the south wall, may have been a stand to support vessels, or it could have facilitated access to the pithoi. Two floor levels were excavated in 2002, corresponding in elevation to the phases discovered in the neighboring kitchen in B200. A number of vases were recovered in the room (Figs. 16–18): two high-necked cups (Fig. 17:1, 2), a large skyphos (Fig. 17:3), three amphoras (e.g., Fig. 17:4), two hydrias, a cooking pot, and two pithoi. One pithos (Fig. 17:5, Fig. 18) is a short globular jar (ca. 0.80 m tall) with a tall narrow neck and squared rim marked on the front by a pendant tongue; the neck is decorated very simply with a horizontal row of stamped shield bosses and an impressed guilloche band. Other finds included a spindle whorl, two querns, and a bronze rivet. The flotation samples examined thus far have produced only scant specimens of grain, pulses, and grape.

Large boulders, characteristic of the earthquake damage, were found on the top of the wall collapse in the middle of the room in B400; these had to be broken and removed to conduct excavation in the western and central areas of the room. The rooms in B200 and B400 appear to have been food preparation and storage areas, respectively, perhaps related to the buildings on the south side of the spine wall in B100 and B300. One of the goals of future excavation is to explore further the relationship between buildings on the south slope.

60. High thresholds might be a characteristic of doorways of storerooms in private houses at the site (cf. Kinch 1914, pp. 112–114, for Vroulia), offering an element of security as well as protection from vermin, flood water, and sediment.

## THE NORTHEAST BUILDING (A300–500, A700, A1000)

The northeast extension of the spine wall (a segment ca. 22 m in length) was investigated in 2002, revealing a series of axially aligned rooms and apparently exterior spaces that follow the bedrock contour across five trenches. These trenches, from southeast to northwest, include A400, A300, A500, A700, and A1000 (Figs. 5, 19). The rooms, forming parts of a single building, were constructed side by side, between the spine wall on the northeast and the bedrock face on the southwest (Fig. 19). The spine wall at this location thus functioned as a retaining wall, allowing the floors of the rooms to extend 1.50 m beyond the limits of the bedrock shelf. The best-preserved rooms are in A400 and A300, where the southwestern two-thirds of the clay floors are stabilized on the bedrock shelf. The northeastern edges are severely eroded, especially where the bedrock drops away. In most cases the floors on this edge have slipped out and away from the erosion line, with debris covering the top extant portion of the spine wall.

The room in A400 is at least 25 m<sup>2</sup> in size; its eastern limit has not yet been defined. It has a good clay floor and a partially preserved south wall that seems to have collapsed into the room, perhaps as a result of the post-abandonment earthquake destruction mentioned above (Fig. 19). Three flat stones on the floor surface indicate the location of posts in the center of the room: two on the south side, about 1 m from the south wall, and the third on the north about 1.5 m from the spine wall. While no pillar support was found in the northeast, its absence may be explained by the erosion along the north side of the room. The regular placement of internal roof supports would have been required to span the 5-m width of the room. Although no features associated with the room's function were preserved, the concentration of no less than nine stone tools, mostly handstones, along with the presence of a quern in the south part of the room, might suggest that food-processing activities were undertaken here.<sup>61</sup> Other finds from the room included an astragalus, a terracotta loom weight, and a shell bead.

Excavation in a sounding along the northwestern edge of the room, on the inner face of the spine wall, revealed a layer of deep leveling fill that we associate with the rebuilding of the settlement in the late seventh century. The pottery recovered from this sondage and its continuation in the adjacent room A300 included two Final Neolithic bowl rims, a body fragment of a late Prepalatial collared jar or amphora with trickle decoration,<sup>62</sup> and a considerable number of LM IIIC sherds.<sup>63</sup> Among the LM IIIC finds were a krater rim (Fig. 20:1), a deep bowl decorated with a lozenge

61. The flotation samples from this room and the adjoining room (A300) have not yet been preliminarily sorted. Thus, there are no plant data to support or refute the suggestion of food-processing.

62. The fabric of the sherd is char-

acteristic of Mirabello wares for hole-mouth and pithoid jars (EM III–MM I); cf. Haggis and Mook 1993, pp. 277–278.

63. See Mook and Coulson 1997 for stratified LM IIIC pottery from this immediate region.

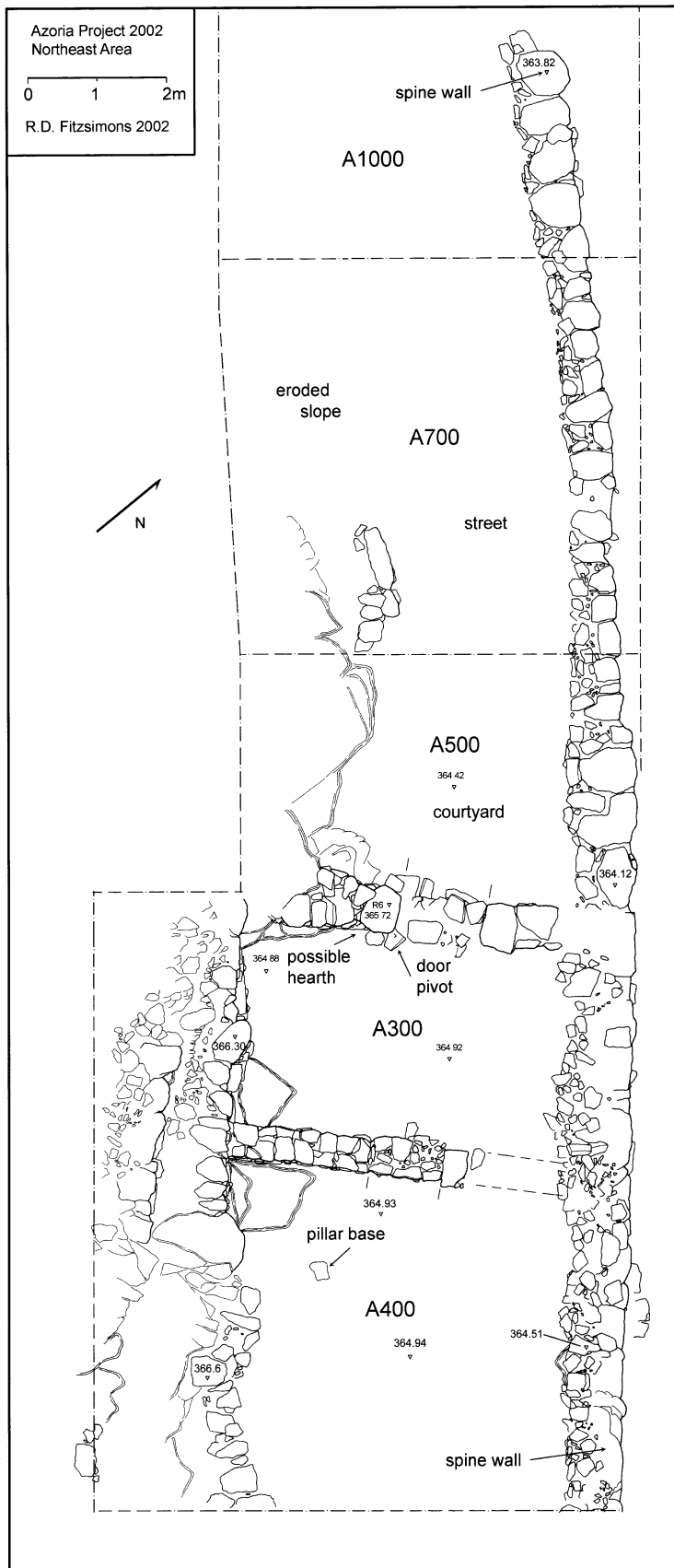

Figure 19. State plan of the northeast area. R. D. Fitzsimons

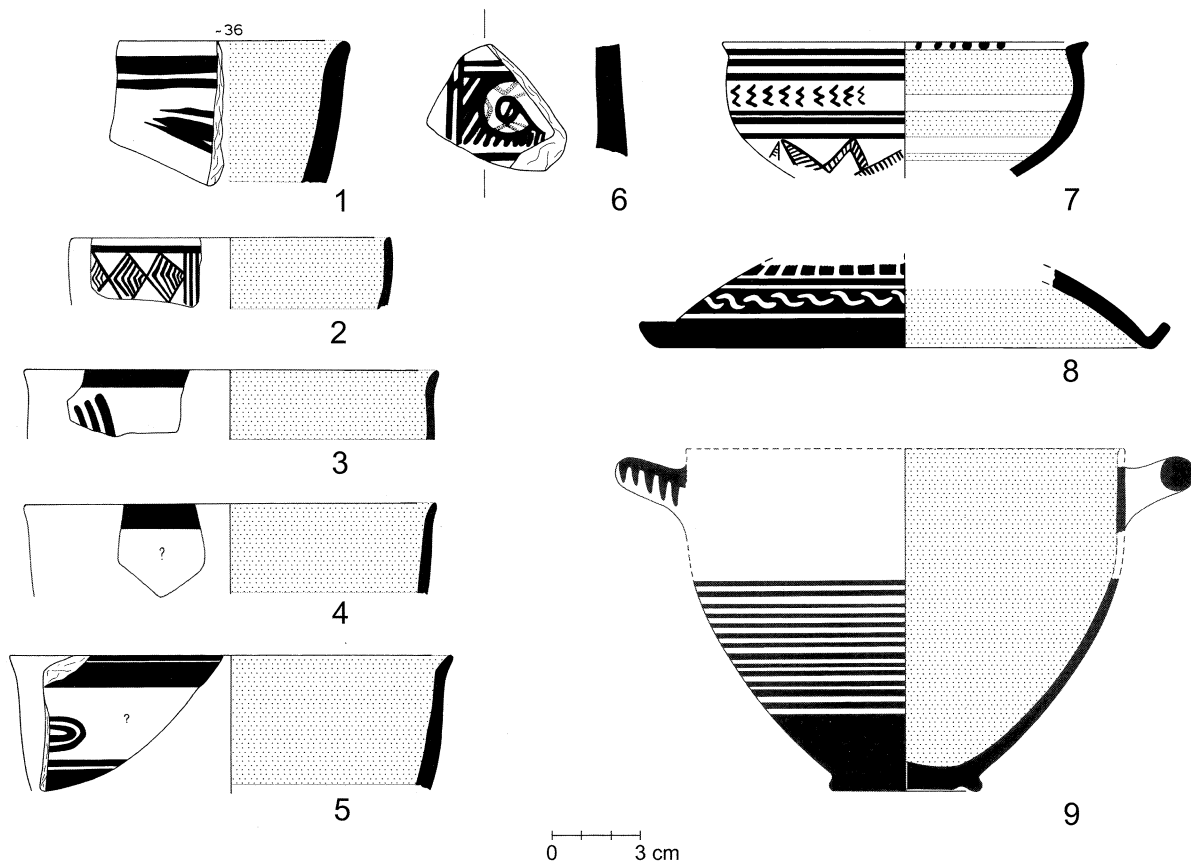

Figure 20. A300, A400, A1200: Earlier pottery from the foundation fill (possible or fugitive decoration indicated by question marks).

R. Docsan

chain filled with chevrons (Fig. 20:2), two handles from deep bowls, a closed body fragment from a jug or stirrup jar, a lekane rim, and several pithos sherds with typical decorative bands and fabrics.<sup>64</sup> LM IIIC sherds, especially from deep bowls (Fig. 20:3–5), were recovered from similar fill deposits in A1200. Geometric and Orientalizing pottery is also common in such leveling fill deposits. In A300 and A400 we recovered a fragment from an Eteocretan-style pithoid jar (Fig. 20:6), a small hemispherical Late Geometric bowl with banded interior (Fig. 20:7), a Late Geometric–Early Orientalizing white-on-dark domed lid (Fig. 20:8), and an Orientalizing kotyle (Fig. 20:9), along with other pottery from the same range of phases. These finds are consistent with the pottery from the nearby Kastro.<sup>65</sup>

A cross-wall divides the room in A400 from the one in A300 to the northwest. These rooms are connected by a well-fashioned doorway and threshold in the center of the wall (Fig. 19). Inasmuch as the architecture

64. These pithoi include the prevalent phyllite-quartzite fabric used for coarse storage pottery at Vronda as well as a jar-ware common at Mirabello in LM IIIC; see Haggis and Mook 1993, pp. 275–277.

65. See Mook 2004 for an overview of the LM IIIC through Orientalizing

ceramic sequence from stratified deposits on the Kastro. The most substantial quantity of Cretan Protogeometric through Orientalizing pottery yet published comes from the North Cemetery at Knossos, although it is of little stratigraphic significance (Coldstream and Catling 1996).

of this room was exposed to a depth of 0.20 m above the floor surface, A300 may have been partially excavated by Boyd in 1900. The floor is a well-consolidated clay surface with indications of burning throughout. A concentration of burned clay and ashy soil was found against the west wall of the room, between a projection of the bedrock and a single stone. This may have been the location of a built hearth that was exposed and perhaps partially damaged during Boyd's early excavation campaign in 1900. Finds from the room included two querns, a handstone, an iron blade, a terracotta stopper, a loom weight, and a piece of a copper sheet, objects possibly associated with domestic functions.

Just north of the putative hearth is another doorway in the northeast, providing access to A500. The threshold, constructed of flat pieces of limestone and phyllite, has a door socket in situ in the southeast corner. The doorjambs consist of large rectangular blocks of limestone spanning the full width of the wall. The shapes of these stones are very regular and the surfaces facing into the doorway appear worked. The jamb on the south side of the doorway is a single block almost a meter high, consistent with the fabric of the west wall of A300, which incorporates large boulders on a bedrock foundation. The megalithic character of the west wall could indicate that it served as an exterior wall of the building, with its doorway opening onto a corridor or courtyard in A500 to the west.

A500 was largely eroded except for a patchy clay surface preserved along the bedrock on the southwest side of the space. No doorway was preserved between A500 and A700. A patch of clay, perhaps a surface, was preserved in A700 behind a small segment of wall in the southwest part of the room. A1000 was nearly denuded by natural erosive processes before excavation. While the eroded character of the area west of A300 precludes certain definition of function, the position of a preserved portion of the south wall in A500, as well as the shape of the bedrock on the southern edge of the trenches, suggests that the space may have been a street or corridor, roughly 1.5–2.0 m wide, leading from the west end of the terrace to a courtyard space in A500.

### **THE WEST SLOPE (A100, A600, A800, A900, A1100–1600)**

The west slope of the South Acropolis proved to be the most productive of the areas explored in 2002 (Figs. 5, 21, 22). Here, along the 364–365 m contour, we recovered a segment of the spine wall, beginning some 25 m north from the point in B100 where the wall turns sharply north from its northwest trajectory on the south slope. Following the spine wall for some 30 m along the west slope through trenches A600, A1600, A1200, and A1300, we found that, as on the south slope, the wall formed a central and unifying architectural element, effectively permitting two groups of buildings on different levels, one east and the other west of the wall. As an integral structural element, the spine wall provided the western wall for buildings on the lower terrace and a retaining wall for fill supporting buildings on the upper terrace.

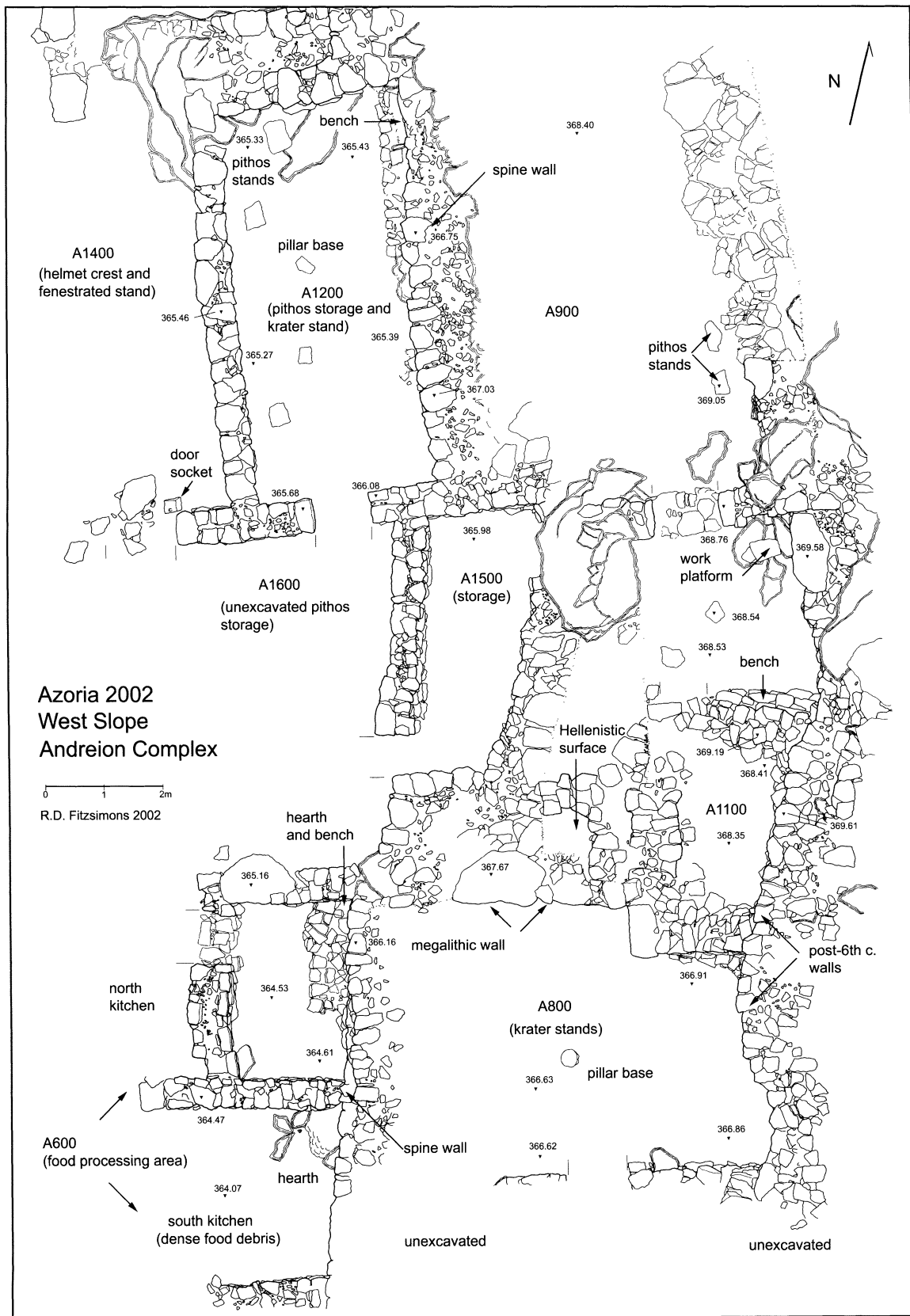
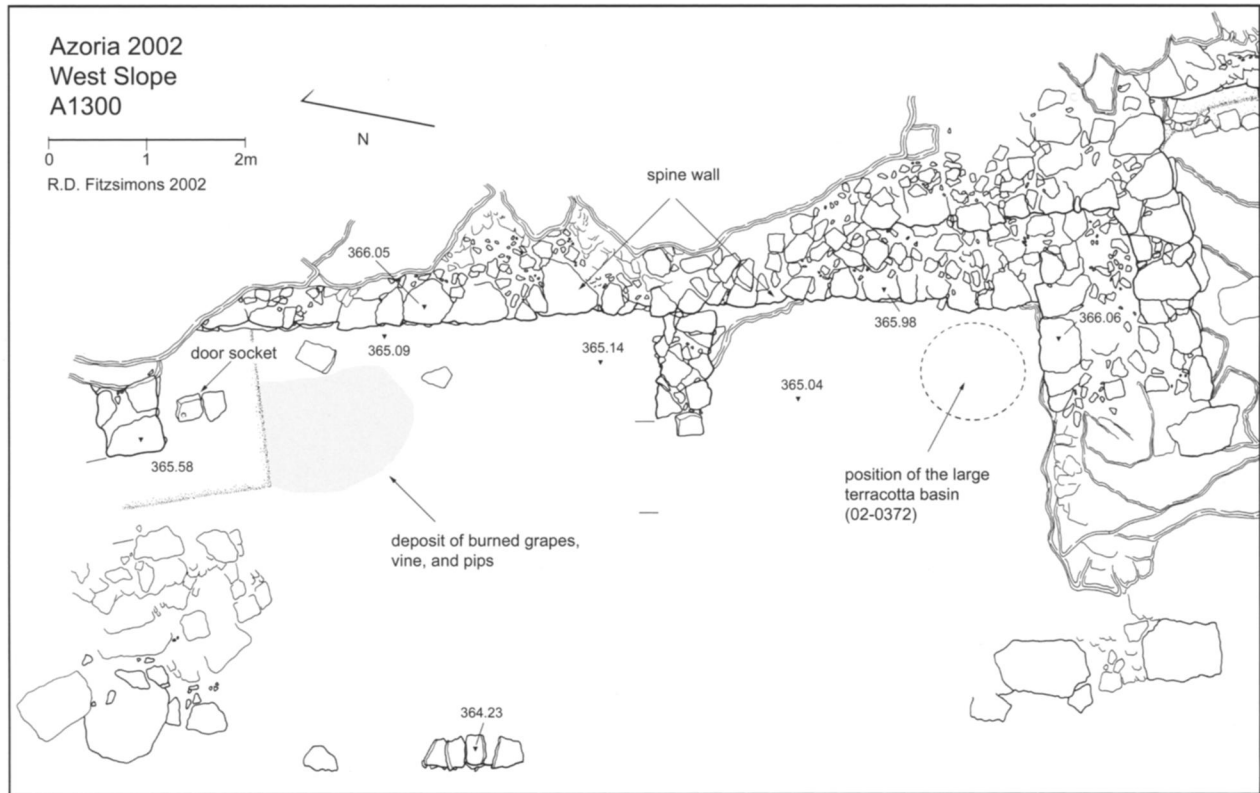

Figure 21. State plan of the west slope. R. D. Fitzsimons





**Figure 22. A1300: State plan showing the location of grape and vine debris and a large lekane.**  
R. D. Fitzsimons

Five separate buildings were recovered. A building is defined here as a series of contiguous enclosed spaces (rooms) that are clearly connected via doorways. Since excavation of the west slope has not yet been completed, the definition of these spaces as buildings and the related nomenclature remain tentative. The buildings as presently defined (see Figs. 5, 21, 22) are as follows: (1) a two-room building on the north edge of the area excavated in 2002 (A1300) (Fig. 22); (2) a three-room building on the upper terrace just below the hilltop, spanning trenches A900 and A1100; (3) one large room of a building situated at the southern edge of this complex and east of the spine wall (A800); (4) a four-room building immediately to the west (A1500, A1600, A1400, and A1200); and (5) two adjoining rooms on the west side of the spine wall (A600). The spine wall continues into the scarp of the unexcavated area south of A800 and A600.

### INDUSTRIAL AREA: A1300

Immediately north of storerooms A1200 and A1400 is a two-room building, A1300, which may have been part of an industrial establishment (Figs. 5, 22). The building has a northern aspect, with no apparent connection or doorway to the south, where the walls are built against bedrock. A segment of the building's north wall is preserved on the east, where a door-jamb indicates the location of the access to the room; a door socket lies displaced just south of this wall. On the east side of the building, a double retaining wall supports leveling fill between the wall and bedrock.

The division between A1300 and the storerooms A1200 and A1400 is a clear and intentional element of the architectural design. The south

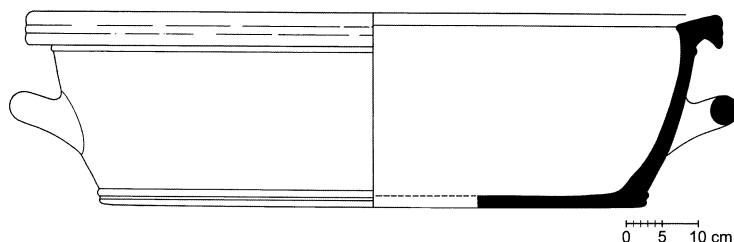

Figure 23. A1300: Lekane. R. Docsan

end of A1300 and the north ends of A1200 and A1400 are separated by a spur of bedrock upon which the walls of both buildings are constructed (incorporating the bedrock into the wall construction). A space between the walls originally contained fill, some of which was excavated to explore the method of construction. The west wall of A1300 is preserved only in the southwest corner, while a large part of the floor along the western side has eroded away. The floor sequence, however, was recoverable along most of the eastern side. Two architectural and occupational phases are apparent. At the end of the sixth century, the floor level was raised some 0.26 m, and the cross-wall was installed, creating a large room on the north and a smaller room on the south. In the southernmost area of the building, the clay floors seem to have suffered extreme erosion. Here, sitting on the earliest floor level of the building (Fig. 22), we found fragments of a gigantic lekane. The basin (Fig. 23) has thick walls and a base diameter of 0.75 m, suggesting that its use was industrial.<sup>66</sup>

In the northern part of the building, there was a lens of ash and carbonized plant fiber that seems to have been incorporated as part of the typical, gravelly cobble leveling fill beneath the earliest floor surface (Fig. 22). All of the flotation samples from this deposit have been analyzed. They contain wood charcoal and hundreds of fragments of grape seeds, as well as smaller quantities of grape skins and stems. Other than a single stray specimen of pine nut, no other food remains were recovered. While no stone press has yet been found, it might be conjectured that the ash and carbon debris represent burned waste material from an early wine pressing operation, for which the industrial lekane in the south room was a collecting basin. The ash layer and the basin are not, however, directly associated stratigraphically. The ash lens forms part of the foundation level for the earliest floor in the north, while the basin pieces were found lying directly on the earliest floor of the south room.

The physical and architectural separation of space between A1300 and A1200/1400 suggests functional, if not social, distinctions affecting communication and activity patterns along the west slope. Further excavation is needed to clarify these patterns across the site, but we can postulate in this area a segregation and centralization of storage and industrial areas associated with the manufacturing of wine and olive oil.

### THREE-ROOM BUILDING: A900 AND A1100

The building on the uppermost terrace on the west slope consists of three rooms (Fig. 21). The northernmost room, located in A900, is best preserved at its south end. A clay floor and schist paving stones were found in the southeast corner. Wall segments forming the room's southwest corner, south wall, and doorway were also observed. This large room was origi-

66. Given the lack of a preserved later floor immediately above this lekane, it is difficult to determine whether the vessel belongs to the earlier or later phase of the room.

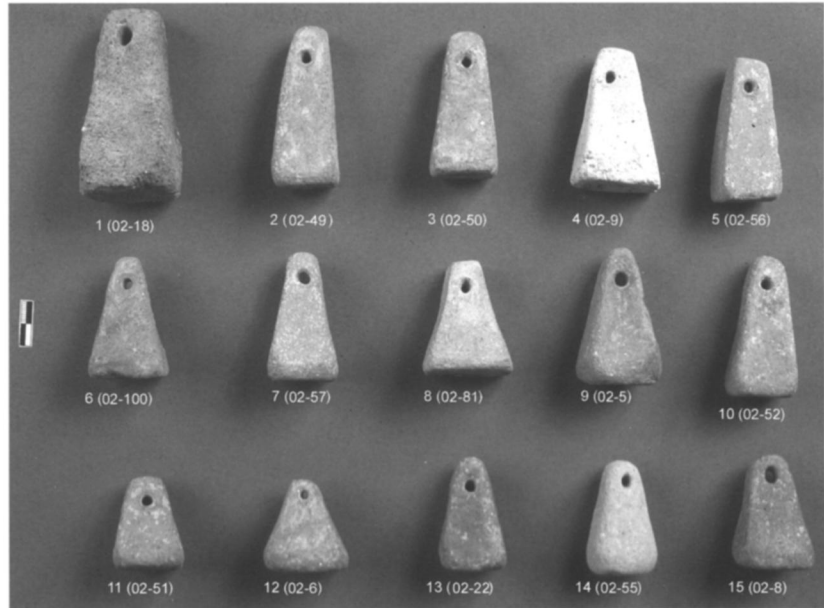

**Figure 24. Various loom weights from Archaic deposits.** Photo E. Attali and C. Papanikolopoulos

nally supported by a bedrock shelf on the east and deep terrace fill on the west, where the spine wall (the east wall of the store room in A1200) served as a retaining wall and architectural support for the building. The room may have been as large as 20 m<sup>2</sup> (ca. 6.5 m long and 3.0 m wide), and it seems to have been similar in design and dimensions to the room in A1200, located on the terrace below and to the west. Its present condition, however, precludes a complete reconstruction. The two paving stones along the east side were probably bases for pithoi, fragments of which were found smashed on the room's floor. A terracotta weight was also recovered from this room.

A doorway in the south wall of A900 leads into two smaller rooms in A1100, both with off-center doorways. The first small room, about 7.5 m<sup>2</sup> in area, contained a work platform in the northeast corner, a shallow bench built against the south wall, and, in the center of the room, fragments of a pithos flanked by two paving stones—possible work platforms or stands. Notable finds included two iron fragments and four pyramidal terracotta loom weights (Fig. 24:2, 3, 7, 10). The small pyramidal loom weights are interesting because they are relatively uniform in size and form (ca. 6.6 cm in height, 3.0 cm in width at the base) and fairly consistent in weight (65 g). They represent a marked departure from the larger, bulkier types recovered in the Late Geometric and Early Orientalizing contexts on the Kastro.<sup>67</sup> The weights are generally medium coarse, tempered with phyllite and quartzite, although some have a fine pink or pink-buff fabric with sparse mudstone and quartzite inclusions. The presence of phyllite and quartzite inclusions probably indicates local manufacture. Most show traces of a dull brown, dark brown, black, or lustrous red slip; rarer varieties have a fine buff slip, such as one weight from the south slope house B100 (Fig. 24:4).

The shape, size, and weight of these small Archaic weights point to changes in the warp-weighted loom and the production of a finer, lighter, and tighter weave such as a twill, in contrast to the plain weaves and heavier

67. The Geometric weights are twice the height and width and considerably heavier (555–645 g); cf. Mook 1993, pp. 286–287.

cloths probably produced with the large truncated pyramidal types of the Early Iron Age.<sup>68</sup> While loom weights are found scattered throughout the excavated area, the concentration of such weights in the small north room of A1100 (along with the presence of two others in the adjoining room in A900 and five more immediately downslope in A1200) might serve to indicate the presence of a loom and a locus of textile production. The assumption, based on evidence from Knossos, that the small pyramidal type begins no earlier than 500 B.C. on Crete can now be corrected.<sup>69</sup> While the type is used at Azoria throughout the sixth and early fifth centuries, the change from large pyramids to the small Archaic types probably occurred sometime in the late seventh century, certainly no later than 600 B.C.

The south room of A1100 was also very small in size, with an area of approximately 5.0 m<sup>2</sup> in the sixth century. It was apparently filled in with stones following a phase of wall collapse and burning at the end of the sixth century. This deep stone layer may have been deposited sometime in the third century, when two buildings were constructed up against this fill: one on the Archaic terrace to the west of the room, and the other over the northeastern corner of A800, just south of the room. These Hellenistic buildings are not well preserved and reconstruction of their plans based on extant remains is not possible; only fragments of wall and small patches of floor surfaces indicate their original location.<sup>70</sup>

The three rooms in A900 and A1100 along the upper terrace of the peak were supported on their western edge by terrace fill contained by retaining walls forming the east walls of A1200 and A1500 on the terrace below (Fig. 21). The building conforms to the natural bedrock shelf, using an ambitiously constructed terrace to extend the floor surface to the west and to expand and regularize room sizes. The narrow axial plan of the building and its off-center doorways represent formal and structural adaptations to and integration with the uneven bedrock terrain. All three rooms of A900 and A1100 show signs of burning (carbonized wood, ash, and burned red clay) on the floor surfaces, evidence of the sixth-century destruction horizon observable across the site. A1100 appears to have been abandoned and filled in following the destruction, perhaps as early as the fifth century or as late as the third century, when a new wall was constructed on the interior of A800, against the outer face of the south wall of A1100.

It remains unclear whether these three rooms, with storage in the north (in A900) and two workrooms to the south (in A1100), were parts of a house or an industrial area. The concentration of loom weights, the unusually small size of the south rooms, and the absence of food-processing equipment might, however, suggest nondomestic or specialized functions. The storeroom in A900 is similar in dimensions to those on the terraces below (A1200 and A1400). All three of these are considerably larger than the domestic storage facilities so far uncovered on the site (cf. B400). It is possible that A900 was part of the storage complex to the west (see below). Finally, the concentration of loom weights in the building might be evidence for the presence of a warp-weighted loom, probably in the north room of A1100, if not for specialization of textile production in this part of the site.

68. Barber 1991, pp. 104, 197. The authors thank Elizabeth Barber for her comments on these loom weight types (pers. comm. 2004). See Foxhall 1998, pp. 304–305, for the ritual and social significance of textiles in the Archaic period.

69. Whitley, Prent, and Thorne 1999, p. 253; cf. Sackett 1992, pp. 405–406.

70. The date of these architectural changes is conjectural. It is based on the presence of third-century pottery, the latest datable material in the deposits. The actual date of the architectural renovations might have been as early as the early fifth century.

### STORAGE COMPLEX: A1200 AND A1400–1600

Four rooms to the west of the building in A900 and A1100 form a coherent unit (A1200, A1400–1600), although we expect future excavation to show communication with rooms to the south (in A600), if not also with the unexcavated buildings on the terrace below and to the west (Fig. 21). A small storage room in A1500 was built against the terrace fill and bedrock that form the foundations of the rooms above in A1100. The room's eastern wall is a single-faced retaining wall supporting dense stone fill behind it on the east. The room is long and narrow (ca. 1.5 × 4.5 m), and the bedrock rises to an unusual height in the center, indicating that an uneven floor surface was tolerated by its users. The clay surface preserved across the northern half of the room was extremely burned, with visible woodlike patterns in the carbonized debris embedded in the surface. The bedrock was burned as well. Although the floor in the south part of the room was eroded, a fragmentary hydria and krater found among the artifacts lying against the bedrock outcrop may originally have been sitting directly on the floor. A flotation sample associated with these vessels produced a few grape pips, an olive stone, and a poppy seed. Other finds from the room included a spindle whorl, an iron strip, and a handstone. It is likely that this small room was a special storage area, perhaps for vessels associated with cooking and drinking activities.

A doorway in the southwest corner of A1500 leads into A1600, a room about twice the size of the small storeroom. It was excavated down to the lower level of wall collapse and destruction debris in 2002, without recovering the room's floor or western wall. The eastern wall of A1600, separating A1500 from A1600, slumps dramatically toward the west. Finds from the upper levels of A1600 consisted of numerous large fragments of pithoi, perhaps attesting to additional storage in this area. Another, more likely possibility, to be confirmed by further excavation of A1600, is that the space functioned as a vestibule or courtyard linking the storerooms A1200, A1400, and A1500 on the north with the kitchen areas to the south (Fig. 21).

On the north side of A1600, two well-fashioned doorways lead into two separate rooms: A1200 on the east and A1400 on the west (Fig. 21). A1400 was not well preserved, and the western limits of the room have not been defined with certainty. A clay surface was exposed by excavation along the east side of the room, and elsewhere an eroded bedrock outcrop represents the floor's foundation. The typical pebbly clay was used to level the bedrock and to serve as packing for the floor. The room produced a number of interesting objects, including fragments of a terracotta fenestrated stand (Fig. 25), pieces of sheet bronze, and part of a bronze helmet crest (Fig. 26).

Like their bronze counterparts, terracotta stands of the type illustrated in Figure 25, along with others from Azoria discussed below, probably held vessels for wine.<sup>71</sup> The Azoria stands have much in common with the rod and cast metal tripods and other ceramic stands of Early Iron Age and Archaic date found in Crete, mainland Greece, Cyprus, Italy, Syria, and Palestine.<sup>72</sup> The triangular spaces created in metal stands for structural support, along with the circular voids in both the rings and the centers of

71. Carter 1997, pp. 109–112. We thank Jane Carter for her insightful comments on the Azoria stands and for sharing her wealth of knowledge concerning Bronze Age and Early Iron Age stands in the Aegean and eastern Mediterranean (pers. comm. 2003). See also Langdon 1993 for detailed discussion of kraters with stands and their relationship to bronze cauldrons from seventh-century Italian contexts (pp. 173–176), bowls with stands (pp. 213–214), and fenestrated dinos and tankard stands (pp. 118–121).

72. See Catling 1964, pp. 190–223, for Early Iron Age bronze stands and the suggestion that terracotta types were imitations of bronze prototypes (pp. 219–223); Langdon 1993, pp. 173–176, for Italo-Geometric imitations of bronze stands from North Syria; and Matthäus 1985, pp. 299–340, for Early Iron Age and Archaic bronze examples from Cyprus.

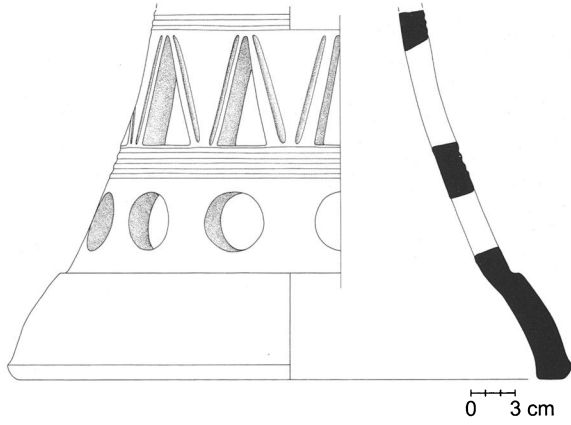

Figure 25. A1400: Fenestrated stand.  
R. Docsan

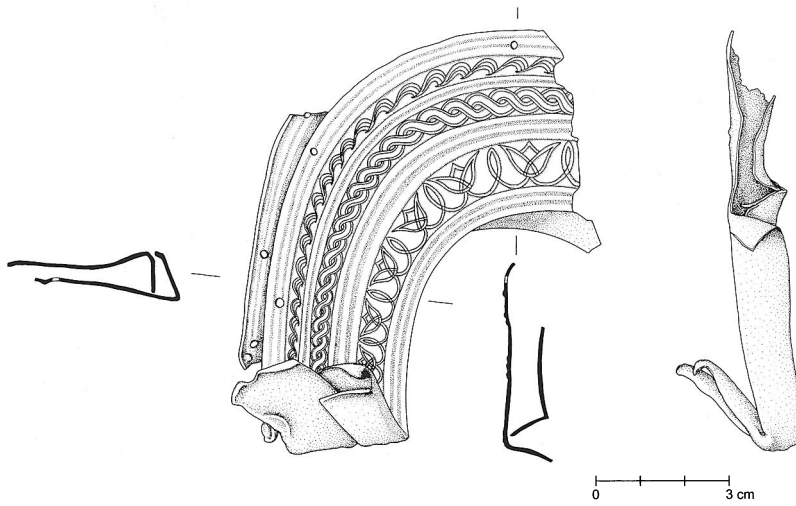

Figure 26. A1400: Helmet crest  
fragment. D. Faulmann



Figure 27. Helmet from Afrati,  
with the area of the crest represented  
by the Azoria fragment outlined.  
After Hoffmann 1972, pl. 13



Figure 28. A1200: Pithos deposit in southeast corner. Photo M. S. Mook

volute forming the termini of the metal struts, are features echoed in the fenestration patterns of this terracotta stand and others from Azoria. On the whole, the pattern of fenestrations on these stands is more elaborate than that of their seventh-century predecessors.

The bronze helmet fragment (Fig. 26) is the top part of the distinctly high crest that belongs to an open-faced Cretan type, known in only one other full-sized example from Afrati (Fig. 27).<sup>73</sup> Registers of incised lotus chains, guilloche, and wave patterns, separated by sets of ridges, decorate the surface of the Azoria piece. The crest was apparently made of two opposing pieces of bronze, each forged separately in one piece with half of the helmet. The two-piece box construction is evident at the bottom, where the pieces are overlapping and crimped. The top of the crest would have been open. A series of holes along the top edge indicate the location of pins, rivets, or loops (no longer preserved) that would have connected the two symmetrical halves, while also providing anchors for the plume or horse tail that could have been woven through the open top edge.

The neighboring storeroom A1200 is almost 20 m<sup>2</sup> in area, measuring 6.5 m in length and 3.0 m in width (Fig. 21). The back (east) wall of the building is a continuation of the spine wall, with its regular courses of limestone boulders. This massive retaining wall originally supported the fill that formed the foundation for the floor in trench A900 above. The extant layer of fill, about 0.50 m deep, was excavated immediately east of the wall and yielded a number of LM IIIC sherds, including deep bowl rims (Fig. 20:3–5) and body fragments, in addition to later Early Iron Age sherds.

A long stone and clay bench, ca. 3.0 m long and 0.50 m wide, is situated in the northeast corner of the room. The bench is bordered with stones and capped with a layer of very hard-packed, silty phyllite clay. At the northern end of the bench, three upright stones form a three-sided bin or hearth, around which was found a considerable amount of what appears to be iron slag.<sup>74</sup> The presence of the slag notwithstanding, A1200 seems to have been used primarily for storage in its last phase in the late sixth century. The remains of at least seven pithoi were found smashed directly on the floor surface (Figs. 28–30). Two paving stones mark the locations of

73. The Afrati helmet is now in the Museum für Kunst und Gewerbe, Hamburg (H5, inv. no. 1970); see Hoffmann 1972, pp. 5–6. Bronze armor dating to the seventh–sixth centuries has been found in probable cult contexts at Dreros (Xanthoudides 1918), Afrati (Lebessi 1973), and Axos (Levi 1930–1931).

74. This puzzling slag debris will be sampled for analysis.

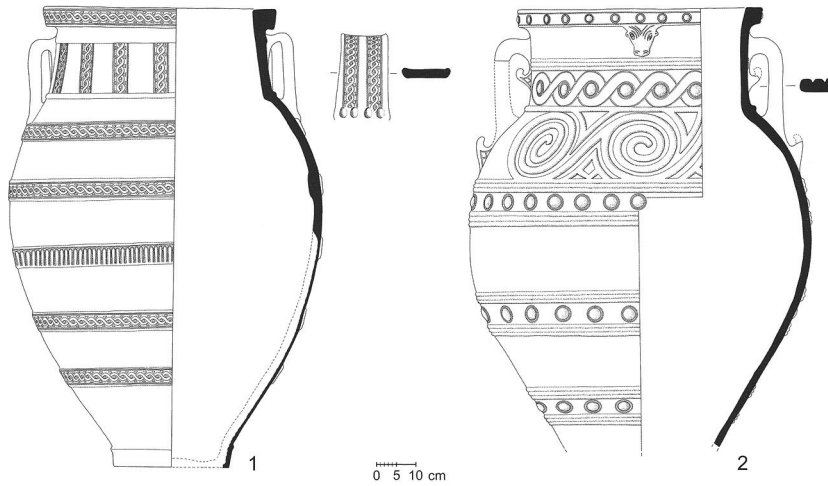

Figure 29. A1200: Two pithoi from the storeroom. D. Faulmann



Figure 30. A1200: Two pithoi and a stand from the storeroom. Photo M. S. Mook



Figure 31. A1200: Storeroom, from the south. Photo M. S. Mook





Figure 32. A1200: Lekane in situ.

Photo M. S. Mook

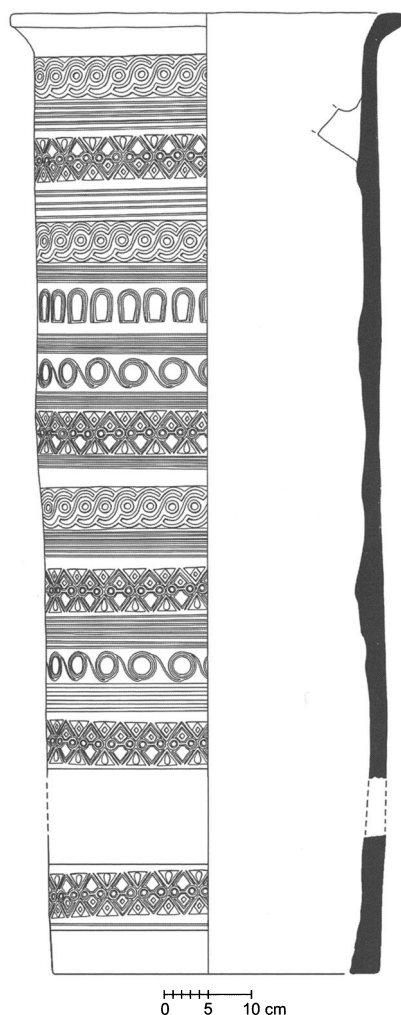

Figure 33. A1200/A800: Cylindrical stand. R. Docsan

pillars in the middle of the room, roughly on an axis with the doorway, while three other larger flat stones along the western edge of the room are probably pithos stands (Fig. 31).

The pithoi from A1200 occur in two sizes, exemplified in the restored examples with complete profiles. The smaller pithos (Fig. 29:1) is 1.14 m tall, while the larger one (Fig. 30, center) is 1.43 m in height.<sup>75</sup> These pithoi are decorated with the elaborate relief-work characteristic of Cretan storage jars, including a variety of guilloche patterns, shield bosses (stamped and appliquéd), plastic ribs, heraldic birds, foliate bands, rosettes, interlocking spirals, and arcaded tongues, among others.<sup>76</sup> An interesting feature of some pithoi is the existence of a front and back, distinguished by more elaborate decoration on one side and suggestive of an element of display. One pithos (Fig. 29:2) has appliquéd shield bosses on the rim exterior, a pendant bull protome on the rim, a bossed guilloche on the neck, and plastic running spirals on the shoulder, all between the handles on the front of the jar. Other examples are less ornate; the front of one pithos (Fig. 30, center) is distinguished by rim decoration consisting of a pendant tongue and stamped shield bosses with groups of chevrons. The use of appliquéd shield bosses gives the impression of rivets holding together sheets of bronze,<sup>77</sup> and the bull's head protome on the pithos rim illustrated here also has many parallels in bronze.<sup>78</sup>

Other finds from A1200 included a whole lekane recovered on the floor on the east side of the room (Fig. 32), a spindle whorl, five terracotta loom weights, three handstones, a quern, a diorite hand axe, numerous copper and iron fragments, a small Creto-Cypriot lekythos, an imported (probably Rhodian) fruit-stand,<sup>79</sup> an iron spear point tip, and the major portion of a tall cylindrical terracotta stand (Figs. 30, right; 33). The base of the last item was recovered in A800 (see below). The stand is decorated with a complex array of stamped motifs in registers, including guilloches, disk-and-lozenge motifs, outlined tongues, and linked shield bosses, separated by groups of incised bands. These patterns are identical to those found on pithoi. Unlike the other terracotta stands recovered from the west slope, this example is a solid piece with no fenestrations and with an off-center handle on the interior, located below the rim and originally extending across the opening. The function of this handle is

75. Compare the pithos from B400 (Figs. 17:5, 18), which is 0.81 m in height, representing a third and smaller-sized category of jar. The storage capacity of the pithoi in room A1200 alone was thousands of liters, and such jars, independent of their contents, represented a significant investment. Cahill (2002, p. 228) notes that at Olynthos large pithoi constituted a household's most expensive pots, costing the equivalent of "the price of a whole house in a neighboring town."

76. For discussion of other examples of Cretan relief-pithoi, see Woodard

1982, pp. 19–59; Anderson 1975, pp. 41–61, 99–100; Schaefer 1957, pp. 9–44; Levi 1945, pp. 9–15; and Savignoni 1901.

77. See Matthäus 1985, pl. 44.

78. See Matthäus 1985, pls. 59, 110, 111.

79. The lead weight is a plummet or line weight similar to examples recovered in Temple B at Kommos (Schwab 2000, pp. 391–392), where they are thought to have been dedications by a fisherman to the deity worshipped in the Archaic temple (cf. Boardman 1967, p. 204).



**Figure 34 (left).** A1200: Olive stones.  
Photo D. C. Haggis

**Figure 35 (right).** A1200: Grape pips.  
Photo D. C. Haggis

uncertain, but it may have served to help support a krater or to assist with moving this rather substantial piece.

There was much evidence for burning in A1200, particularly on the floor surface in the northern and eastern areas. The vessels and other objects were found directly on top of burned clay, carbonized wood, and ash debris. The surface had numerous patches of blackened soil and red-burned phyllite clay. These red and black patches on the floor surface preserve the patterns of fallen roof beams and branches of roof packing.<sup>80</sup>

The intense fire that contributed to the destruction of A1200 also preserved considerable quantities of botanical remains. More than a thousand fragments of grape pips and skins and hundreds of fragments of olive stones were recovered from this room. A preliminary examination of the distribution of the seeds suggests that grapes were stored in the northern portion of the room, while olives were stored toward the center (Figs. 34, 35). Trace quantities (fewer than 10 specimens each) of almond, fig, pulse, unidentifiable cereal grain, hackberry, and poppy seed were also found in samples from this room.

It is possible that the pithos storage area in A1200, along with the adjacent rooms in A1400 and A1500, formed a series of storerooms associated with what we are calling the “special-function building” in A800 to the southeast (see below). Although communication between these areas is not yet fully understood, it is clear from the architecture that the storerooms had a southern orientation, communicating directly with A1600, which, based on the evidence available so far, served as a mediating space between the north and south room clusters. A1600 provided access to A600, the food-processing area lying directly to the south. Future excavation will target A1600 and the western edge of this terrace in the hopes of clarifying the patterns of communication between these contiguous rooms on the west slope.

80. The preserved segments of the wood and plant fiber from the destruction levels across the site are being saved for identification and analysis by Maria Ntinou.



**Figure 36. A800:** View of the special-function building, tentatively identified as an *andreion*, from the east.  
Photo M. S. Mook

### SPECIAL-FUNCTION BUILDING: A800

Trench A800 produced evidence of a late (possibly Hellenistic) wall and surface in the northeast area of the trench, as well as a deep deposit of third-century leveling fill placed on top of the stone tumble and wall collapse that we associate with the site's destruction in the Late Archaic period (Fig. 21). At the bottom of this densely packed, 2-m-deep stone debris, a large single room, 6.5 m wide and 4.5 m deep (some 30 m<sup>2</sup>), came to light. A large retaining wall forms the northern or back wall of the building. It employs the large stone or "cyclopean" construction characteristic of the Early Archaic spine wall (Figs. 21, 36). This monumental wall runs east–west, bisecting the west slope and the spine wall itself. While forming the north wall of the room, it also retains the deep terrace fill supporting the building on the upper terrace to the northeast (A1100).

The floor of the room in A800 is made of clay. A single round column base of hewn limestone was set in the middle of the room (Fig. 36), slightly off-center from the doorway, which is about 1.10 m wide and leads through a well-built cross-wall of smallish boulders. On the floor, fragments of three large and elaborately decorated terracotta stands were found (Fig. 37). Two of these stands are fenestrated and similar in size and function to the stand found in the adjoining storeroom A1400. One stand has a torus molding with red-painted triglyph and metopal sections, while a lower register has alternating black and white sections (Figs. 37, 38).<sup>81</sup> Another, larger stand is fragmentary and apparently unpainted; below its rim and above its triangular fenestrations it has a stamped register of outlined tongues and another of shield bosses. The base of the third stand, which is the largest, was found in A800, and its body and rim were found in storeroom A1200, as noted above (Figs. 30, right; 33). The finds from A800 were exclusively ceramic. In addition to the stands, a pithos base, the remains of cups (Fig. 39:1–3), a small krater (Fig. 39:4), and pouring vessels (e.g., Fig. 39:5) were among the items recovered. We think that the stands were designed to support kraters and probably served as the centerpieces

81. The torus element recalls the bulbous midsection with triglyph and metopal panels on kraters with stands of the late eighth and early seventh century (cf. Langdon 1993, p. 174).



Figure 37. A800: Floor deposit of terracotta stands. Photo M. S. Mook

in drinking and dining ceremonies. It is possible that A800 was a storeroom or repository for objects used in the main rooms as yet unexcavated to the south.

The terracotta stands found in A800, A1200, and A1400 are of particular interest because of their specialized form and limited contexts of occurrence (they are yet to be found elsewhere on the site), indicating that they may have had ceremonial functions. While precise parallels are not known, these stands are clearly the successors of and functionally akin to the Late Geometric terracotta stands customarily used to hold vessels of wine for various public and cultic occasions of drinking and libation. The funerary context of the Late Geometric types is well established, and their iconography has provided a vivid background for the discussion of elite ideology and aristocratic ancestor cults.<sup>82</sup> Although terracotta stands are found in other ostensibly nonfunerary cult contexts, such as the Delphinion at Dreros,<sup>83</sup> as well as in symposium and banqueting scenes depicted on sixth-century kraters, their role in banquets and drinking ceremonies in a civic context in Crete is not yet well attested archaeologically.

The presence of these unusual krater stands leads us to consider a possible ceremonial use for A800. The room is interesting for many reasons, such as its large size, the well-fashioned pillar base in the room's center, and the use of boulder-size stones in its construction on the west, east, and north sides. The presence of drinking vessels and the concentration of krater stands also suggest that A800 had a special function rather than being the locus of typical domestic or industrial activities. Given the room's architectural attributes and the finds from both A800 and the adjoining buildings, we suggest that A800 was one part of an *andreion*, or "men's dining hall," which, according to later authors, was the context for the *sysitia*, or common mess of the urban elite (e.g., Strab. 10.480). The storerooms exposed on the north side of A800 (A1200, A1400–1600) might support this interpretation, as they could have accommodated the legal dues and equipment evidently required for admission to and use in the *sysitia*.<sup>84</sup> As described by Aristotle (*Pol.* 1272a), a percentage (possibly a tenth of the income) of crops and flocks derived from both public lands

82. Carter 1997, pp. 109–111; Langdon 1993, p. 119.

83. Marinatos 1936b, p. 258.

84. Excavation planned for coming seasons, concentrating on what might be the main room of the building adjoining A800 on the south, should clarify the function of this complex; furthermore, we will explore its relationship to the series of storerooms and kitchens by expanding excavation along the terrace below and west of A800.



Figure 38. A800: Fenestrated stand.  
Photo E. Attali and C. Papanikolopoulos

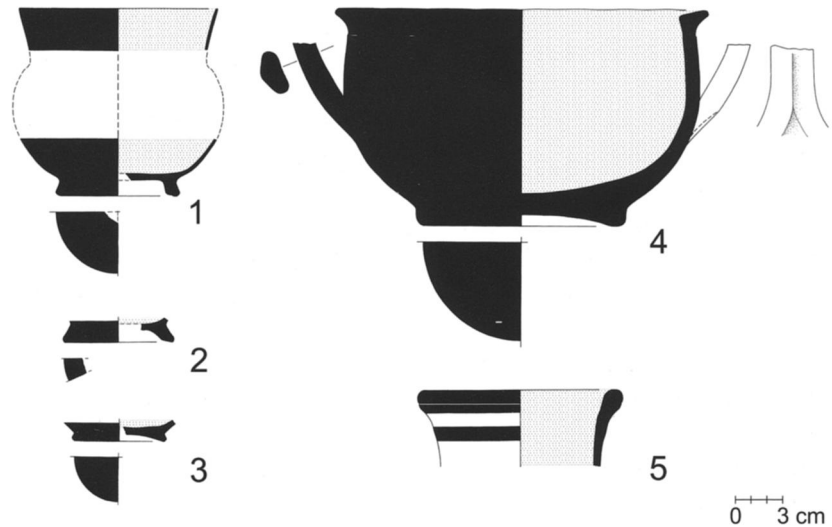

Figure 39. A800: Selected pottery  
from the floor deposit. R. Docsan

and serf tribute was allotted for sacrifices to the gods, public services, and the common meal.

In his recent discussion of the temples at Kommos, Shaw, following Athenaeus (4.143), draws a careful distinction between temples and *andreia*, speculating that most communities probably had only one such public hall.<sup>85</sup> Even though the sources are vague on how many of these structures might have been accommodated by the city, or the specifics of the social organization of the participating groups, contemporary inscriptions and later texts emphasize commensality and the blending of civic and religious ceremony. Multiple social, political, and religious functions associated with the *andreion* may have overlapped with those of other contexts such as temples and later *prytaneia*. The lack of unequivocal archaeological examples of *andreia* presents rather unique interpretive problems.<sup>86</sup>

85. Shaw 2000, pp. 687–688. Sjögren (2001, pp. 86–91), however, rightly avoids the “difficult separation of the secular and the cultic aspects of dining” (p. 87), arguing for close connections between the terms *kosmos* and *andreion* in the administration

of the early polis (p. 135).

86. Even if we accept that the structures at Prinias and the Delphinion at Dreros were temples, Carter (1997) and Koehl (1997) have made compelling arguments, based on analyses of context, assemblages, and iconography,

that they also served the functions of *andreia*. See also Sjögren 2001, p. 91; Shaw 2000, pp. 687–688; Koehl 1997, p. 142; Mazarakis Ainiian 1997, p. 389; Carter 1997, p. 89; Cooper and Morris 1990, p. 78.

The concentration of large decorated terracotta krater stands in A800 and adjacent rooms provides important evidence in support of the *andreion* attribution. While a large krater was presumably shared by the boys in the *andreion* described by Dosiadas (Ath. 4.143), neither kraters nor stands are mentioned in contemporary inscriptions from the island. One piece of relevant evidence, although not from Crete, is the Phanodikos inscription on the so-called “Sigeion stele,” found at Sigeion near the Dardanelles and now in the British Museum. Dated by Jeffery to 575–550, this grave marker commemorated the offering of “a wine krater, stand [*upokreterion*], and strainer for the *prytaneion*” by Phanodikos, son of Hermokrates the Prokonnesian.<sup>87</sup> Guarducci has commented on the importance of public banquets in *prytaneia* and the appropriateness of formal gifts and ceremonial display involving drinking equipment such as krater stands.<sup>88</sup>

The fact that krater stands are unknown in domestic contexts of Late Geometric to Archaic date on Crete attests to their distinctly ceremonial and public character, appropriate to the grave site, the sanctuary, and perhaps the *andreion*, a known place of public drinking. It seems likely that A800 and its adjoining storerooms were parts of a building not unlike the Sigeion *prytaneion*, where public banquets were hosted, with very large and ornate stands being used to support wine bowls, probably large dinoi or kraters. The stylistic variations in the assemblage of stands could be interpreted as a symbolic articulation of the identity and status of individual participants or clans.<sup>89</sup> Given what we know of the public banquet in the Archaic Cretan context, it is logical to consider the *andreion* as the most likely place to have accommodated such vessels. The *andreion* may have had several public functions, creating a venue for political and ritual activities that crosscut kinship group divisions.<sup>90</sup> These activities probably changed from the Archaic to Roman periods, but they evidently centered on the common meal, ceremonial recognition of individual contributions to the city, discussion of civic affairs and the conduct of war, and sacrifices to the gods.<sup>91</sup> If the room in A800 is part of an *andreion*, as we tentatively propose here, the neighboring storerooms (A1200, A1400–1600) may provide an unusual opportunity to explore the contents of the common mess and details of the mobilization and storage of produce and equipment used in public feasts.

The buildings discussed so far appear to have been used for storage and consumption. Further information about the preparation of the food consumed in the complex may be provided by the two contiguous kitchens located on the terrace below A800.

87. Jeffery 1982, pp. 53–54; Richter 1961, p. 36.

88. Guarducci 1961, p. 166.

89. For a contemporary representation of a terracotta stand comparable in size and form to the examples from Azoria, see Schmitt-Pantel’s (1990, pp. 16–19) discussion of the Corinthian krater Louvre E635; for the

centrality of the krater in Archaic banqueting, see Schmitt-Pantel 1990, p. 19; on the visual rhetoric of the decorated krater, its physical context, and practical and ritual significance, see Lissarrague 1990, pp. 204–205.

90. For overlapping functions of *andreia*, *prytaneia*, and Cretan “hearth temples,” see Viviers 1994, pp. 244–

247; Bergquist 1990, p. 43; Cooper and Morris 1990, esp. pp. 68–69, 78; Samuelsson 1988.

91. The conflation of *andreia* and temple functions is pointed out by Carter (1997, p. 89) in her discussion of Prinias; see also Koehl 1997, p. 138, and Mazarakis Ainian 1997, esp. pp. 225–226.

### KITCHENS: A600

On the terrace below and to the west of the large room in A800 is trench A600, where two kitchens of similar size and orientation were found (Fig. 21). Even though this pair of rooms appears linked architecturally to the large building above, sharing the megalithic east–west wall, no clear communication has yet been identified between the upper and lower terraces at this point on the west slope. The spine wall separates the large room in A800 from the kitchens and retains the terrace fill that supported the western area of the floor in A800.

The northern kitchen, about 6.0 m<sup>2</sup> in area, had a well-preserved clay floor, a bench along the east wall, and a hearth in the northeast corner (Figs. 21, 40). The doorway into the room is located off-center (north) in the room's western wall. The area lying to the west of the room is unexcavated. The south kitchen's extant north and south walls suggest that its dimensions were similar to those of the north kitchen, but the western limits of the room were not recovered in 2002. No doorway is yet apparent, although a possible access might have been located at the western end of the room's north wall, where it extends beyond the width (and north–south cross-wall) of the northern kitchen. If this was the location of the door, then it communicated directly with the room or space west of the northern kitchen, rather than directly with the northern kitchen.

The clay floor of the northern kitchen is intact. It shows none of the signs of burning characteristic of the buildings to the north (Fig. 40). Except for the limestone bench or work platform built against the west wall, the room was fairly well emptied of its contents, leading us to believe that it continued in use after the sixth-century destruction, perhaps having been renovated and (unfortunately) kept quite clean. The work platform along the east wall of the room is a shallow bench made of flat fieldstones, one course high, two courses deep (ca. 0.60 m), and about 1.80 m in length. It terminated in a built hearth in the northeast corner of the room. The hearth exploits a rise in the bedrock for its bottom. The western edge is built of large square stones, with a single stone forming the heat shield. Flotation samples taken from the floor of this room yielded several specimens of unidentifiable cereal grain and pulses, along with slightly larger quantities of fig, grape pips, and olive stones. The room's last phase of use may have been contemporary with the latest habitation phases in the houses in B200 and B300. The abandonment might be placed late in the first quarter of the fifth century, sometime after the conflagration that destroyed so much of the site at the end of the sixth century. This date is supported by a black-gloss tulip cup (Fig. 41:1) and a skyphos(?) foot (Fig. 41:2) found in the south kitchen.<sup>92</sup>

The south kitchen also had a bedrock hearth located in the northeast corner (Figs. 21, 42). The hearth walls are indicated by a rough semicircle of stones bordering the rise of burned bedrock. Dense stone debris pitted the clay floor, which extends unevenly over the bedrock. Unlike the north kitchen with its clean and even surface, the southern room was filled with food debris, as well as discarded fragments of black-gloss open shapes (Fig. 41:1, 2), black cups<sup>93</sup> (Fig. 41:3–5), cooking ware that included two

92. This tulip cup, with its slightly curving body and thick splaying foot, seems to be a predecessor of the Knossian late-fifth-century tulip cup (cf. Callaghan 1978, pp. 9–10; Coldstream and Eiring 2001, pp. 78–81). The glossy surfaces of these pieces, the splaying shape of the tulip cup's foot, and prominent torus of the skyphos foot are features not found on cups from obviously earlier contexts at Azoria.

93. The rim and base fragments belong to low-necked cups and fall into Erickson's (2000, p. 408) type I, ca. 500–475 B.C.



**Figure 40. A600: North (clean) kitchen, from the southwest.**  
Photo M. S. Mook

elaborate patterned-burnished chytra with wiped interiors (e.g., Fig. 41:6), pouring vessels (e.g., Fig. 41:7), pithoi, and a complete hydria, which was apparently overturned and smashed on its side (Fig. 42).

The concentration of faunal materials in the south kitchen accounts for nearly 45% of all animal remains examined from intensive sampling across the site in 2002. The proportions in which various animal species were found in this room mirror those in other areas, but the south kitchen assemblage is distinguished by the high concentration of faunal remains in a single room. A total of 1,422 shells and shell fragments, primarily composed of top shell and limpets (Fig. 43), represents 71.7% of the identifiable material, although the amount of food contributed by these and other small species such as fish and sea urchin (Fig. 44) is insignificant when compared to the amount contributed by domestic meat animals. Sheep and/or goat dominate the mammalian assemblage (78.1%). Other domestic faunal remains included 60 pig elements, 8 cattle bones or bone fragments, and 9 domestic dog elements.

An interesting discovery was a number of rabbit bones, which were found in articulated segments. The association of these delicate bones in anatomical position suggests that at least part of this assemblage was primary food debris, quickly covered after being deposited here. This hypothesis is supported by the general lack of evidence for carnivore or rodent gnawing on the bones and the lack of surface deterioration attributable to sun exposure and weathering. The absence of primary butchering debris such as lower legs, feet, and ungulate horn cores—parts commonly discarded in the initial butchering process—is also a notable feature of the south kitchen deposit. This pattern might indicate that complete animal carcasses were not being processed close to areas of consumption. Primary butchering could have been completed elsewhere, perhaps in a centralized



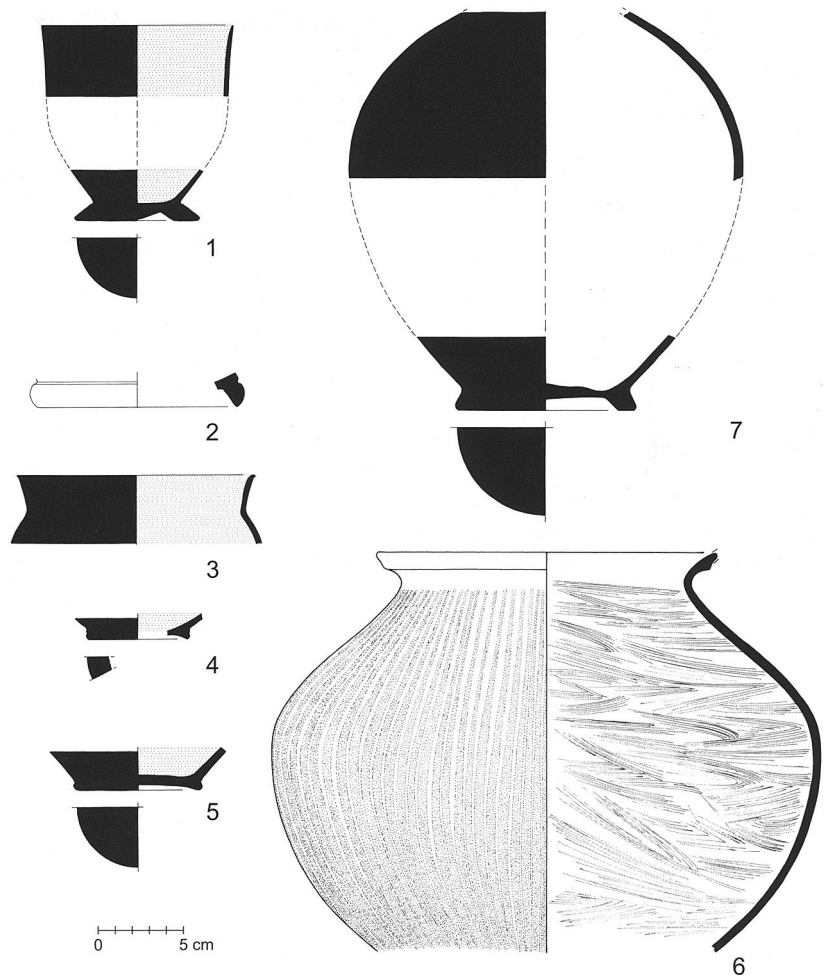

Figure 41. A600: Selected pottery from the kitchens. R. Docsan



Figure 42. A600: South (dirty) kitchen, with hydria in situ (lower right), from the south. Photo M. S. Mook



Figure 43 (*left*). A600: Marine shells from the south kitchen. Photo D. C. Haggis



Figure 44 (*above*). A600: Sea urchin, crab, and fish bone from the south kitchen. Photo D. C. Haggis

area or off-site, with only dressed portions of the ungulates being brought to the kitchens for final preparation and consumption. This proposition, however, needs to be tested through more extensive excavation.

On first inspection, the small quantity of plant food remains recovered from the south kitchen seems at odds with the abundant evidence for meat consumption. The flotation samples from the floor of this kitchen produced an assemblage of botanical finds similar to those from the north kitchen in A600 and from the kitchens in area B. Modest numbers of grape pips and olive stones were found, along with a pulse seed and four fragments of almond shell. Notably, however, the remains present are fruit stones and nutshells, items that would have been discarded during the final preparation of a meal or at the time of consumption. Also, there is no debris that would suggest the initial stages of grain processing (threshing and sieving). These observations are consistent with the interpretation of the animal bones as discards from meals rather than butchering debris.

Both the north and south kitchens appear to have suffered during the destruction that took place across the site at the end of the sixth century. The north kitchen, however, was evidently rebuilt and continued in use, while the south room was abandoned as a kitchen but served as a dump for the rest of the Archaic settlement's occupation. As such, the south kitchen collected substantial amounts of animal and plant remains from the adjacent north kitchen and, conceivably, from the large special-function building to the east.

## THE ANDREION COMPLEX

Our interpretation of the complex of rooms and buildings comprising trenches A600, A800, A1200, and A1400–1600 is of course tentative, pending further exploration of the west slope, and it requires some explanation. As discussed above, among the forms of evidence that support the *andreion* hypothesis are the concentration and reduplication of large storage and cooking facilities in a single building, and the presence of drinking and pouring vessels, armor, and an unusual assemblage of terracotta stands. Furthermore, the lack of definable cult equipment most appropriate to a temple—such as altars, votive deposits, figurines, cut-outs, plaques, exotica, cult statues, and clearly burned sacrificial remains—is also evidence, albeit negative, supporting our interpretation. We need, however, to complete the excavation of the area and to explore the communication patterns within the building, especially between the storage and food preparation rooms and the main halls south of A800.

The form and function of Cretan *andreia* are poorly understood. This is largely attributable to the paucity of well-excavated, well-published, clearly stratified, and well-dated Orientalizing and Archaic findspots on the island. The overlapping ritual and civic functions of these buildings may also make their archaeological identification ambiguous. Later literary sources for *andreia* define their public drinking and dining functions and imply their architectural complexity (with cooking, dining, and lodging areas). Perhaps the most detailed account is Athenaeus's quotation (4.143) of Dosiadas and Pyrgion, alluded to above. This is a description of the public mess, its equipment, and its activities. The building should have movable tables and chairs, wine cups and kraters, and portions of dressed meat. Equal portions of meat were served to all guests except the younger men, who were allotted a half portion. Activities such as ritual libation, drinking, serving, and dining should have archaeological correlates. It is more difficult, however, to infer archaeologically the full range of sociopolitical interactions taking place in the *andreion*, where there was evidently discussion of public affairs and warfare, with an emphasis on individual prowess and bravery.

Contemporary epigraphical sources, while fragmentary and few, also attest to the essential public functions of these buildings. The *andreion* is evidently a building at Gortyn (*IC* IV 4) and at Eltynia (*IC* I x 2), one in which bodily injury is punishable by law. A late-sixth-century inscription from Axos (*IC* II v 1) describes exemptions and wages proffered to workers in the city, taking the form of meals in the *andreion*. The Spensithios decree (*SEG* XXVII 631) provides by far the most detailed information. Lines 11–16 of side B of the incised *mitra* from the Afrati area refer to the obligatory contribution of the *poinikastas* to the *andreion* in the form of “ten double axes of dressed meat” and an “annual offering.”<sup>94</sup> The decree's reference to both meat and offerings corroborates the characterization of the building in later sources as having combined ritual and dining functions. The mention of a measure (or weight) of dressed (or cut portions) of meat is reinforced both in Dosiadas's account and in the faunal remains

94. Jeffery and Morpurgo-Davies 1970, pp. 144–145.

from the south kitchen (A600) at Azoria, where only dressed portions were recovered during the 2002 excavations.<sup>95</sup>

Although the textual sources are helpful, the precise archaeological definition of *andreia* remains problematic. While we might expect these buildings to show functional similarities with one another and to have similar artifact assemblages, it is perhaps more likely that they will not fit neatly into a formal typology. There are apt to be significant divergences, after all, between archaeological typology and cultural reality. Moreover, some of the movable equipment of the *andreion*, such as wooden tables and chairs, are not likely to have been preserved archaeologically even if left in situ, except in the ambiguous remnants of nails and metal fittings. In lieu of an inscription in the building itself, identification of a dining hall or halls will necessarily depend on other sorts of material evidence, such as the remains of meals and drinking and dining equipment, especially cups, jugs, stands, and kraters. All of this evidence is present at Azoria, but it does not allow us to identify an *andreion* with certainty. We do think that the separate and multiple storage and cooking areas to the west and north of A800 offer considerable support for this attribution, but communication between these areas and the main halls requires further excavation.<sup>96</sup>

The main problem is perhaps less the range of evidence required than the overlapping types of evidence likely to be found in cultic and domestic contexts. This problem betrays the embeddedness of ritual in Archaic Cretan society and the resulting ambiguity of the *andreion* as an archaeological context. Carter and Koehl have made good cases for *andreia* at Prinias and Dreros, but these identifications are dependent on the interpretation of the dining ceremonies as well as a careful reading of iconography as the social-symbolic expression of an elite social structure centered on the hunt, warfare, ancestors, and initiation rituals.<sup>97</sup> For example, evidence of large fixed hearths and benches in Cretan “hearth temples” or “house temples” has been important, if not central, in the various arguments for *andreion* and *prytaneion* functions.<sup>98</sup> But considering the practical aspects of the *andreion*, as derived from literary and epigraphical sources, the dining halls themselves should, in all likelihood, be spacious, with ample room for movable tables, chairs, and large kraters.<sup>99</sup>

We might imagine that cooking and food-processing for potentially large numbers of people (members and guests) would have taken place outside the main halls, perhaps in any number of adjoining service areas equipped with hearths and ovens. Furthermore, substantial storage would have been a necessity for such buildings, if we assume that extensive pro-

95. We are grateful to the late Michael Jameson for his comments (pers. comm. 2004) on the “butchering” nomenclature in the Spensithios decree.

96. Koehl (1997, p. 138) has argued, following Dosiadas’s account in Athenaeus, that the *andreion* should have hearths, storage areas for provisions for the feast, and pantries for the

storage of cups, kraters, and portable tables.

97. Koehl 1997; Carter 1997.

98. See discussion in Sjögren 2001, p. 91; Shaw 2000, pp. 687–688; Carter 1997, pp. 89–91; Koehl 1997, pp. 140–143; Mazarakis Ainian 1997, p. 389; Viviers 1994, pp. 244–249; Cooper and Morris 1990, p. 78; Samuelsson 1988.

99. Viviers (1994, pp. 245–247) points out in his analysis of the so-called temple at Afrati that the lack of a large central hearth might preclude a *prytaneion* attribution, while couch fixtures would not be usual attributes of an *andreion* in which the diners were seated rather than reclining.

visions of wine, oil, grain (wheat and barley), meat, secondary products (such as milk and cheese), figs, nuts, grapes, and other fruit,<sup>100</sup> along with numerous forms of equipment for food-processing, serving, and consumption, were needed to support the public mess.<sup>101</sup>

The importance of weapons and armor also needs to be considered. As mentioned above, a bronze helmet crest, an iron spear point, and sheet bronze fragments were recovered from the storerooms in A1400 and A1200 at Azoria. Although we do not have specific references in extant literary or epigraphical sources to the display or dedication of armor or weapons, we learn from Dosiadas that warfare, and especially the prowess of individual warriors, was the subject of regular, perhaps ritualized discussion and public praise in the *andreion* (Ath. 4.143).<sup>102</sup> Even though the original context of the Spensithios decree—our best contemporary epigraphical source for payments owed to the *andreion*—is unknown, the text was inscribed on a bronze *mitra*<sup>103</sup> that we could guess was meant to be hung or displayed in a public place, presumably a temple, sanctuary, or other public building. Could *andreia* have accommodated such civic and honorific displays? Viviers has observed that armor and weapons, such as those found at Afrati, would have been most effectively displayed on the walls of an *andreion*, where they could have served to illustrate the didactic and honorific storytelling that apparently followed the meals in the public mess.<sup>104</sup>

Unfortunately, specific formal parallels for our building are lacking, so in looking for comparanda, we must carefully reevaluate Geometric–Archaic domestic and cultic contexts excavated on the island. For example, one possible *andreion* might be the building on the western hill at Dreros, excavated by Xanthoudides in 1917.<sup>105</sup> The main hall of the building is 24 m long and over 10 m wide. It consisted of three rooms, one of which was equipped with a paved platform (perhaps floor paving) and a very small U-shaped hearth, which was not large enough for roasting meat. Even though the excavator thought that this enormous structure was the city's Delphinion known from inscriptions, the large size of the building, the multiple rooms, the possible second story, and the presence of numerous fragments of bronze armor and a bronze vessel led Marinatos to propose that it was an *andreion*, an appropriately sized assembly hall

100. Jeffery and Morpurgo-Davies (1970, pp. 150–152) discuss the provisions for the *andreion*, which, by analogy with the Spartan *phiditia*, would have included barley, but also luxury goods such as meat, wheat, wine, and cheese (cf. Arist. *Pol.* 1271a–b; [*Ath. Pol.*] 4.140e, 141d–e). See Schmitt-Pantel 1992, pp. 60–76, for the Cretan *syssitia*, and Chaniotis 1999b, pp. 192–197, for discussion of animal products. The remains in the storeroom A1200 at Azoria indicate not only the storage of cereals, pulses, and olives, but also almonds, figs, and grapes. According to the Spensithios

decree, the city was to make annual payments of 50 jugs of must or unfermented juice (*kleukios*) and some value or amount of fruit to the scribe (Jeffery and Morpurgo-Davies 1970, pp. 124, 136); one wonders, given the context of this decree, whether these wages in kind were not paid out of the stores in the *andreion* itself.

101. That personal items belonging to free persons could be stored for use in the *andreion* seems confirmed by the Gortyn inscription *IC IV 75B*; see discussion in Willetts 1955, p. 221. We are not told in the inscription what these items were, but possibilities

include armor, weapons, and dining utensils such as cups, bowls, stands, and kraters.

102. See also Carter 1997, p. 91; she interprets Aristotle's (*Pol.* 1272a) representation of the membership of the Cretan *syssitia* as a warrior/hunter aristocracy being supported by farmers and laborers.

103. Jeffery and Morpurgo-Davies 1970, pp. 118–123; Raubitschek 1972.

104. See Viviers 1994, pp. 248–249, for the context of the Spensithios *mitra*.

105. Xanthoudides 1918, pp. 24–28.

and dining room for the city's military aristocracy.<sup>106</sup> Following Marinatos and Viviers, we could suggest that the large quantities of armor in the Dzeros building—and at similar structures at Axos and Afrati—provide a parallel for the Azoria building's assemblage. We need to learn more about the meaning of public dedications and displays of the accoutrements of warfare, however, and to reevaluate the evidence for temples and *andreia* accordingly.<sup>107</sup>

## COMMENTS AND CONCLUSIONS

Pottery recovered in soundings beneath the sixth-century floors at Azoria indicates that the settlement was established as early as the Final Neolithic and continued in use into the Prepalatial periods. While the size of the site in the early second millennium is unknown, the surface collections and the distribution of material recovered in soundings demonstrate that it covered an area of at least 6 ha by LM IIIC. The site was occupied continuously throughout the Early Iron Age, and by the end of the seventh century it had been substantially rebuilt. The inhabitants evidently utilized the walls and debris of earlier Early Iron Age buildings as foundations, but they also significantly reorganized the spatial and architectural plan of the site. In some cases they systematically destroyed earlier LM IIIC–Late Geometric buildings but recycled objects such as pithoi.

The spine wall that encircles the South Acropolis suggests an element of urban planning and a large-scale organization of space and labor not apparent in the architecture of the neighboring Early Iron Age villages. This restructuring of space represents a departure from the agglomerative development of Early Iron Age settlements on Crete, in which architectural complexes seem to have grown, within the limitations of the topography and terrain, as individual kinship groups expanded. The reorganization and formal planning evident at Azoria at the end of the seventh century may represent a new materialization of social and political organization and a new conceptualization of urban space, symbolizing a new urban identity.<sup>108</sup>

The identification of the city itself remains uncertain. Its early abandonment at some time in the fifth century could account for the difficulty in locating the site in extant inscriptions. Azoria is, however, linked to important coastal and inland transportation routes. It occupies a strategic

106. Marinatos 1936a, p. 254. Slightly smaller in size, but similar in the large quantity of armor and weapons in their assemblages, are the so-called temples at Afrati and Axos; cf. Sjögren 2001, pp. 197–198, 223. Viviers (1994, pp. 244–249) provides the most detailed and persuasive argument for an *andreion* at Afrati; see also Wees 1998, p. 363, for public display of armor in the *andreion*.

107. Lebesse 1973; Levi 1930–1931. On Crete, a distinction might eventually be made between patterns of dedi-

catory behavior in various public contexts. Full-size armor occurs at putative *andreia*, such as those at Dzeros (Xanthoudides' building), Axos, and Afrati. Miniature armor (as at Palaikastro) and bronze plaques (as at the Syme shrine and the Dzeros temple) may have been more appropriate votive offerings within temples; Sjögren 2003, pp. 50–52.

108. See Vink 1996–1997, p. 12, however, where the author argues that a drop in visibility of seventh-century remains in the Aegean may have to do with the self-evident identity of the

emergent city-state, no longer requiring the same forms of material expression used in the Late Geometric. This process of restructuring and political consolidation may have been slower to develop on Crete, where urbanization and its material expression occurred in the late seventh rather than the late eighth century; cf. Fagerström 1988, pp. 113–114, where it is suggested that new forms of planning—including the use of the spine wall—are architectural elaborations characteristic of the emergent polis in the seventh century.

location at the northern edge of the Isthmus of Ierapetra, which was a veritable corridor between the Aegean and the Mediterranean. The site overlooks the plain of Kavousi (Kambos), a separate northern extension of the Isthmus lowland. Some historians have associated this lowland plain with the territory of Strabo's Larisa (9.5.19), a city that was abandoned at an unknown date in conjunction with the synoecism of the city of ancient Hierapytna (modern Ierapetra) on the south coast.<sup>109</sup> While Strabo is obviously a very late and chronologically vague source of information for this political consolidation, the Kavousi plain—as a distinctly separate topographical extension of the Isthmus lowland—is interesting precisely because the geographer emphasizes that the plain below the abandoned city was, in his time, still called the Larisian. Of course there have been several different locations proposed for ancient Larisa, such as modern Kedri, Kalamafka, Anatoli, Vainia, and, most recently, the Early Iron Age–Classical site of Profitis Elias near Episkopi at the Isthmus watershed.<sup>110</sup>

Determining the identification of Larisa and the relationship of the as yet unidentified Archaic cities at Azoria and Profitis Elias to ancient Hierapytna is of critical importance in reconstructing the history of settlement in this region during the Classical and Hellenistic periods. The fifth-century abandonment of Azoria, for example, could be linked to the spread of Hierapytnan power to the north coast, with population relocating southward into the Isthmus either to Profitis Elias or to Hierapytna itself. We know the site of Profitis Elias was occupied until the end of the fifth century, when it, too, was apparently abandoned. Given this evidence, we might surmise that the synoecism in the Isthmus involved an active and ongoing centralization of power and nucleation of population, processes linked to the extreme economic and political influence of the Hierapytnan capital on the surrounding countryside.<sup>111</sup>

Although Azoria's historical identity remains uncertain, the main elements of urbanization at this site may be clearly defined. (1) Certain distinctive building types, such as the corridor houses on the south slope (B100 and B300) and the axially planned three-room type (A300–500; A900, A1100), were differentiated and repeatedly constructed. (2) The spine wall was built as an architecturally unifying element that both regularized the uneven terrain and facilitated the organization and expansion of buildings across the site. It may have had a segregating function as well, controlling communication routes and access to various parts of the settlement. (3) A systematic leveling and rebuilding of the hilltop at the end of the seventh century is indicated by the foundation layers discovered beneath some of the sixth-century floors. (4) Grape and olive storage, food-processing, and ceremonial drinking and dining were centralized on the west slope. There is also some evidence for wine production in A1300, and the concentration of loom weights and whorls in A900, A1100, and A1200 might point to textile manufacturing.<sup>112</sup>

The building in A800, with its adjoining storerooms and kitchens, may have been a public building complex with many of the functions of the *andreia* referred to in literary sources and inscriptions. The evidence from Azoria could eventually provide the means of reconstructing the economics of ruling groups and the restructuring of the earliest city's civic institutions. Our picture of the Cretan *sysitia*, derived from contemporary

109. Guizzi 2001, pp. 306–310; Guarducci 1942, p. 19.

110. Guizzi 2001, pp. 309–310; Hayden 1997, pp. 96, 140–141; Watrous and Blitzer 1995; Bowsky 1994, p. 6.

111. Whitley 2001, p. 387. For the mechanics of territorial expansion in Crete, see Viviers 1999 and Bowsky 1994, p. 6. On the process of expansion tending toward the creation of regional hegemonies or “super-states,” see Bennet 1990, pp. 200–201. While such expansion and regional reconsolidation are historically attributed to the third or second century, it is possible that Hellenistic rivalries represent an intensification of earlier practices (see Erickson 2002, p. 43; Chaniotis 1999b, esp. p. 211).

112. Chaniotis (1999b, pp. 206–207) admits the possibility of specialized pastoralism and textile production in some areas of Classical Crete.

and later sources, accords well with Schmitt-Pantel's definition of the "civic institution" in the Archaic Greek city, in which rituals of commensality are viewed as fluid social practices. Rather than constituting strictly cultic or political behavior—sacred or profane, public or private activities—these rituals articulated social hierarchies and complex political relationships.<sup>113</sup> In her analysis of the poetics and iconography of the Archaic banquet, Schmitt-Pantel remarks "that participation—in different forms of commensality, in collective hunting, in the group of ephebes and then of hoplites, in assemblies—is the mark of belonging to the citizen group; furthermore these practices, common to all and shared by all, form an essential part of the common domain (*koinon*) which characterizes city life."<sup>114</sup> Understanding such a context of public commensality, or the Cretan *syssition* as public banquet, requires answers to several questions about the feast itself. What foods were stored, prepared, and consumed, and in what buildings? How was the *andreion* supplied? How was agricultural and pastoral production managed? And, finally, what can the archaeological contexts of food storage, processing, and distribution tell us about the social organization of the Early Archaic city?

Preliminary studies of plant and animal remains from the west slope indicate the storage of large quantities of grapes and olives, while one of the kitchens produced a midden of animal remains derived from prepared cuts of meat. It seems reasonable to assume that wheat and pulses were staple foods at Azoria, but remains of these field crops are scarce in our samples, and those that are present occur in the form of cleaned grains and seeds.<sup>115</sup> Notably lacking are spikelet fragments, chaff, awns, pods, and weed seeds that comprise the debris from processing such crops for storage or from using dung as fuel. It would appear that field crops were threshed and sieved in other locations, perhaps in the vicinity of nearby farmhouses, in the fields, or on threshing floors (*alonia*) around the perimeter of the site. Whatever the case, cereals and pulses seem to have arrived in kitchen work areas cleaned and ready for grinding and cooking. Since cleaned grains and pulse seeds are edible, only the occasional pot spill would leave evidence of their presence. This does not, however, explain the dearth of cereals and pulses in storage rooms that were burned. The question of where field crops were stored remains to be answered.

This assemblage has, however, allowed us to begin analyzing differential patterns of food consumption across the site, as well as the mobilization and redistribution of certain key food resources. This information will affect our reconstruction of the relationship between city and countryside in the Archaic period. Jameson, for example, has predicted a dispersed pattern of hamlets on private estates in Crete, accommodating the complex relationships between serfs and citizens on both public and private land.<sup>116</sup> While he proposed extensive agricultural systems for both Crete and Sparta, with strategies emphasizing cereal production at the expense of olives and vines, the evidence from Azoria is striking precisely because it seems to refute this model. The mobilization of these luxury products (grape and olive) presupposes significant changes from the local Early Iron Age pattern, in the use of both infield and marginal lands, as well as in the organization of extensive agricultural production in general.<sup>117</sup> Given the extreme variability of land resources and agricultural productivity, espe-

113. Schmitt-Pantel 1990, p. 24; cf. Lavrencic 1988, p. 157.

114. Schmitt-Pantel 1990, p. 24.

115. On the whole, plant remains are quite sparse in the deposits excavated in 2002. Catastrophic burning produced sizable quantities of wood from structural elements in some rooms in both areas A and B. With the exception of the A1200 storage room, however, the floors beneath the burned roof collapse produced only marginally more seeds than the floors in rooms with no burning. Nonetheless, several patterns have emerged that require further exploration and interpretation.

116. Jameson 1992, pp. 137–138; cf. Hanson 1992 on the economic changes involved in the intensification of viticulture in the Archaic period.

117. In contrast to the field crops, grapes and olives are widely distributed and surprisingly abundant at Azoria. Small quantities of the seeds of both fruits are scattered on the kitchen floors. Larger quantities are found among the shattered pithoi and lekanoi in the kitchens and storage rooms. The prominence of these luxury crops runs counter to the expectations of models predicting the extension of the agropastoral system in conjunction with the move toward urbanization in Crete.



cially in eastern Crete, agriculture and herding will have required a new level of regional management in the Archaic period, affecting the role of the elites, relationships between households, and exchange between neighboring regions and cities.<sup>118</sup>

In our study of Azoria, we examine agricultural production as an identifiable system of economic power in the community, one that is potentially definable and recoverable archaeologically. The characteristics of the sixth-century urban horizon on the site suggest the attainment of a threshold of elite power, entailing the centralization of surplus and, in turn, differential access to agricultural/pastoral land and labor. Was the status of Azoria's emergent elite reinforced ritually through exclusionary meals in an *andreion*? Was it also reinforced by the acquisition of imports such as fine Attic and East Aegean pottery and metals, as well as by the rationing of foreign or Orientalizing iconography? That is, was this urban phase of the site the first period in which a wealth distribution system with obvious external links was established?

One purpose of continuing excavation at Azoria is to gather evidence that might attest to new configurations of power and help us to understand the meaning of settlement nucleation, the physical segmentation of the site, and the establishment of new kinds of buildings with potentially important political and ritual functions. Our primary goal is to explore the origins of this political economy, distinguishing the process of urbanization from the essential sociopolitical relationships that led to the establishment of a city at the end of the seventh century B.C., and testing the relevance of current models of staple finance and wealth distribution systems.<sup>119</sup> Much more excavation is required to explore these questions, to investigate the hypothetical *andreion* complex, and to examine differences in architecture and patterns of consumption across the site.

The evidence from Azoria also allows us to reconsider the alleged cultural hiatus in sixth-century Crete. Far from being a "dark age," the Archaic period at Azoria is characterized by the architectural sophistication of a thriving urban center. Elements of city planning, civic architecture, imported ceramics, and the lingering interest in Orientalizing traditions suggest a level of sociopolitical complexity well in keeping with the epigraphical evidence from this era. It remains to assess the cultural implications of these features. From an archaeological perspective, the seventh century, and especially the latter part of it, emerges as a formative period involving a reorganization of power relationships on the island.<sup>120</sup> This reorganization may have involved the formalization of the *andreion* as a context for negotiating power, the sudden and early use of legal inscriptions as monuments,<sup>121</sup> and, finally, the phenomenon of urbanization itself—not the cognizance of a community of place, which may have existed as early as 1000 B.C.—but a new perception and materialization of the city as the locus of communal identity. Urbanization in Crete may ultimately be characterized as both an expression of ideological and political power in emerging state-level polities and, in functionalist terms, as a crucial part and product of the state formation process. The transformation of the Azoria settlement may find parallels across the Cretan landscape, where the settlements and cemeteries of other communities may also have witnessed a social restructuring during Crete's mysterious period of silence.

118. See Chaniotis 1999b, esp. 197, on the importance of herding in supplying the Cretan *syssitia* and the complexities of transhumance and land management in the Archaic and Classical periods; cf. Viviers 1999, p. 222.

119. Morgan (2003, pp. 73–85) discusses the problems involved in identifying administrative structure, identity of place, and expressions of political power in the early city. See D'Altroy and Earle 1985 on models of wealth and staple finance.

120. Economic and social changes involving, among other things, the shift in emphasis from domestic and burial concerns to those of the sanctuary and city seem to characterize the seventh-century Aegean (cf. Osborne 1996, pp. 200–201; Vink 1996–1997; Osborne 1996–1997; Van der Vliet 1996–1997; Prent 1996–1997); it remains to be seen how Crete fits into this paradigm.

121. According to Whitley (1997 and 1998b), legal inscriptions in Cretan cities served less to codify laws for a literate populace than to symbolize the inherent permanence of the organizational structure, or, in other words, the self-fulfilling prophecy and projection of a dominant ideology; but see also Perlman's (2002, pp. 195–197) analysis, which suggests a less restrictive and more practical public literacy.

## ACKNOWLEDGMENTS

Excavation was carried out by permission of the Greek Ministry of Culture under the auspices of the American School of Classical Studies at Athens. We are grateful for the encouragement and continuing support of the 24th Ephorate of Prehistoric and Classical Antiquities, especially from the acting director, Stavroula Apostolakou, as well as from Metaxia Tsipopoulou and the late Nikos Papadakis. We are indebted to Maria Kyriakaki (University of Crete, Rethymnon) for her assistance and patience as overseer for the 24th Ephorate. Special thanks are owed to the staff of the American School of Classical Studies at Athens; the former director, James Muhly; Stephen Tracy, director; and Maria Pilali, administrator. We also thank Thomas Brogan, director of the INSTAP Study Center for East Crete, and Eleanor Huffman, assistant to the director, for their practical assistance and unflinching support of the project at every stage.

The staff for the 2002 excavation season at Azoria consisted of Donald Haggis (University of North Carolina at Chapel Hill), director; Margaret Mook (Iowa State University), field director; Lynn Snyder (Smithsonian Institution), science director and zooarchaeologist; Margaret Scarry (University of North Carolina at Chapel Hill) and Susan Allen (Boston University), palaeoethnobotanists; Maria Liston (University of Waterloo), bioarchaeologist; Rodney Fitzsimons (Iowa State University), architect; Georgos Damaskinakis (Herakleion), surveyor; Manolis Kasotakis (Kavousi), excavation foreman; William West (University of North Carolina at Chapel Hill), historian and epigraphist; Kathy Hall and Stephania Chlouveraki (INSTAP-SCEC), conservators; Roxana Docsan (Athens), archaeological illustrator; Holly Parton (British School of Archaeology at Athens) and Polly Tessler (Whitney Museum), registrars; Douglas Faulmann (INSTAP-SCEC), archaeological illustrator; Erieta Attali and Chronis Papanikolopoulos (INSTAP-SCEC), photographers. We acknowledge gratefully the useful advice and input of Philip Betancourt (Temple University), Doniert Evely (Oxford University), Laura Motta (University of Cambridge), John Scarry (University of North Carolina at Chapel Hill), David Small (Lehigh University), Antonia Stamos (Temple University), and Natalia Vogeikoff-Brogan (American School of Classical Studies at Athens).

There were seven trench supervisors from the University of North Carolina at Chapel Hill and McMaster University: K. Bishop, M. Eaby, J. Manese, W. McCall, S. Pak, G. Park, and P. Vanaria. Student excavators included A. Callis (Sweet Briar College), N. Doub (University of North Carolina at Chapel Hill), G. B. Ernst (University of North Carolina at Chapel Hill), S. Krebs (University of North Carolina at Chapel Hill), E. Marion (University of Waterloo), K. Miller (Duke University), D. Park (George Washington University), T. Rohrbeck (Duke University), and S. Swingler (University of Waterloo). In addition, there were 15 workmen from the villages of Kavousi and Epano Chorio: K. Boutas, A. Dantes, M. Dantes, P. Hantzidakis, G. Kanitakis, M. Kophinakis, S. Koutsakis, K. Lionoudakis, E. Maniadakis, I. Papadakis, B. Phiorakis, E. Sobanakis,

G. Souriadakis, N. Spiliarotis, and A. Syritoules. There were also six pot-washers: K. Daskalogianaki, M. Kanitaki, A. Kasotaki, M. Phioraki, K. Siganou, and S. Tzari.

Funding for the 2002 season was provided by grants from the National Geographic Society (7193-02), the National Endowment for the Humanities (RZ-20812), the Wenner-Gren Foundation for Anthropological Research (GR 6875), and the Institute for Aegean Prehistory. Additional support was received from the College of Arts and Sciences, the Office of the Vice Chancellor for Research, and the Department of Classics of the University of North Carolina at Chapel Hill, and from the INSTAP Study Center for East Crete (in kind), as well as from the Azoria Project Fund (0-65305-42).

Interim reports and research proposals for the project are available via the World Wide Web at [www.azoria.org](http://www.azoria.org).

## REFERENCES

- Alcock, S. E. 1999. "Introduction: Three 'R's' of the Cretan Economy," in Chaniotis 1999a, pp. 175–180.
- . 2002. *Archaeologies of the Greek Past: Landscape, Monuments, and Memories*, Cambridge.
- Alexiou, S. 1956. "Ἱερόν παρά το Καβούσι Ιεραπέτρας," *CretChron* 10, pp. 7–19.
- Andersen, H. D., H. W. Horsnæs, S. Houby-Nielsen, and A. Rathje, eds. 1997. *Urbanization in the Mediterranean in the 9th to 6th Centuries B.C.*, Copenhagen.
- Anderson, L. H. 1975. "Relief Pithoi from the Archaic Period of Greek Art" (diss. Univ. of Colorado).
- Barber, E. J. W. 1991. *Prehistoric Textiles: The Development of Cloth in the Neolithic and Bronze Ages, with Special Reference to the Aegean*, Princeton.
- Bennet, J. 1990. "Knossos in Context: Comparative Perspectives on the Linear B Administration of LM II–III Crete," *AJA* 94, pp. 193–211.
- Bergquist, B. 1990. "Symptotic Space: A Functional Aspect of Greek Dining-Rooms," in Murray 1990, pp. 37–65.
- Blanton, R. E., G. M. Feinman, S. E. Kowalewski, and P. N. Peregrine. 1996. "A Dual Processual Theory for the Evolution of Mesoamerican Civilization," *CurrAnthr* 31, pp. 1–14.
- Boardman, J. 1967. *Excavations in Chios, 1952–1955: Greek Emporio*, Oxford.
- Bowsky, M. W. B. 1994. "Cretan Connections: The Transformation of Hierapytna," *Cretan Studies* 4, pp. 1–44.
- Boyd, H. A. 1901. "Excavations at Kavousi, Crete, in 1900," *AJA* 5, pp. 125–157.
- . 1904. "Gournia: Report of the American Exploration Society's Excavations at Gournia, Crete, 1902–1905," in *Transactions of the Department of Archaeology: Free Museum of Science and Art, University of Pennsylvania* 1, Philadelphia, pp. 7–44.
- Brock, J. K. 1957. *Fortetsa: Early Greek Tombs near Knossos*, Cambridge.
- Cahill, N. 2002. *Household and City Organization at Olynthus*, New Haven.
- Callaghan, P. J. 1978. "KRS 1976: Excavations at the Shrine of Glaukos, Knossos," *BSA* 73, pp. 1–30.
- Callaghan, P. J., and A. W. Johnston. 2000. "The Pottery from the Greek Temples at Kommos," in Shaw and Shaw 2000, pp. 210–301.
- Camp, J. McK. 2000. "Walls and the Polis," in *Polis and Politics: Studies in Ancient Greek History*, ed. P. Flensted-Jensen, T. H. Nielsen, and L. Rubinstein, Copenhagen, pp. 41–57.

- Carter, J. B. 1997. "Thiasos and Marzeah: Ancestor Cult in the Age of Homer," in *New Light on a Dark Age: Exploring the Culture of Geometric Greece*, ed. S. Langdon, Columbia, pp. 72–112.
- Catling, H. W. 1964. *Cypriote Bronze-work in the Mycenaean World*, Oxford.
- Cavanagh, W. G., M. Curtis, J. N. Coldstream, and A. W. Johnston, eds. 1998. *Post-Minoan Crete. Proceedings of the First Colloquium on Post-Minoan Crete Held by the British School at Athens and the Institute of Archaeology, University College London, 10–11 November 1995 (BSA Studies 2)*, London.
- Chaniotis, A., ed. 1999a. *From Minoan Farmers to Roman Traders: Sidelights on the Economy of Ancient Crete*, Stuttgart.
- . 1999b. "Milking the Mountains: Economic Activities on the Cretan Uplands in the Classical and Hellenistic Period," in Chaniotis 1999a, pp. 181–220.
- Cherry, J. F. 1988. "Pastoralism and the Role of Animals in the Pre- and Protohistoric Economies of the Aegean," in *Pastoral Economies in Classical Antiquity*, ed. C. R. Whittaker, Cambridge, pp. 6–34.
- Coldstream, J. N. 1973. "Knossos 1951–61: Orientalizing and Archaic Pottery from the Town," *BSA* 68, pp. 33–63.
- . 1984. "Dorian Knossos and Aristotle's Villages," in *Aux origines de l'hellénisme: La Crète et la Grèce. Hommage à Henri Van Effenterre*, Paris, pp. 311–322.
- . 1991. "Knossos: An Urban Nucleus in the Dark Age?" in *La transizione dal Miceneo all'Alto Arcaismo: Dal palazzo alla città*, ed. D. Musti, A. Sacconi, L. Rocchetti, M. Rocchi, E. Scafa, L. Sportiello, and M. E. Giannotta, Rome, pp. 287–299.
- Coldstream, J. N., and H. W. Catling, eds. 1996. *Knossos North Cemetery: Early Greek Tombs*, London.
- Coldstream, J. N., and L. J. Eiring. 2001. "The Late Archaic and Classical Periods," in *Knossos Pottery Handbook: Greek and Roman*, ed. J. N. Coldstream, L. J. Eiring, and G. Forster, London, pp. 77–89.
- Coldstream, J. N., and G. L. Huxley. 1999. "The Archaic Gap," *BSA* 94, pp. 289–307.
- Coldstream, J. N., and C. F. MacDonald. 1997. "Knossos: Area of the South-West Houses, Early Hellenic Occupation," *BSA* 92, pp. 191–245.
- Cooper, F., and S. Morris. 1990. "Dining in Round Buildings," in Murray 1990, pp. 66–85.
- Coulson, W. D. E., D. C. Haggis, M. S. Mook, and J. Tobin. 1997. "Excavations on the Kastro at Kavousi: An Architectural Overview," *Hesperia* 66, pp. 315–390.
- Cowgill, G. 1993. "What We Still Don't Know about Teotihuacan," in *Teotihuacan: Art from the City of the Gods*, ed. K. Berrin and E. Pasztory, New York, pp. 116–125.
- D'Altroy, T., and T. Earle. 1985. "Staple Finance, Wealth Finance, and Storage in the Inca Political Economy," *CurrAnthr* 26, pp. 187–206.
- Demargne, J. 1903. "Fouilles à Lato en Crète," *BCH* 27, pp. 206–232.
- Demargne, P. 1929. "Terres cuites archaïques de Lato," *BCH* 53, pp. 382–429.
- . 1947. *La Crète dédalique*, Paris.
- Donlan, W., and C. G. Thomas. 1993. "The Village Community of Ancient Greece: Neolithic, Bronze, and Dark Ages," *SMEA* 31, pp. 61–72.
- Drerup, H. 1969. *Griechische Baukunst in geometrischer Zeit*, Göttingen.
- Ducrey, P., and O. Picard. 1996. "Recherches à Latô VII. La rue ouest: Habitations et défense," *BCH* 120, pp. 721–754.
- Earle, T. 1987. "Chiefdoms in Archaeological and Ethnohistorical Perspective," *Annual Review of Anthropology* 16, pp. 279–308.
- Erickson, B. L. 2000. "Late Archaic and Classical Crete: Island Pottery Styles in an Age of Historical Transition, ca. 600–400 B.C." (diss. Univ. of Texas at Austin).
- . 2002. "Aphrati and Kato Syme: Pottery, Continuity, and Cult in Late Archaic and Classical Crete," *Hesperia* 71, pp. 41–90.
- Fagerström, K. 1988. *Greek Iron Age Architecture: Developments through Changing Times*, Göteborg.
- Fisher, N., and H. van Wees, eds. 1998. *Archaic Greece: New Approaches and New Evidence*, Swansea.
- Flint-Hamilton, K. B. 1999. "Legumes in Ancient Greece and Rome," *Hesperia* 68, pp. 371–386.
- . 2000. "The Paleoethnobotany of Iron Age Crete," *AJA* 104, p. 368 (abstract).
- Foxhall, L. 1995. "Bronze to Iron: Agricultural Systems and Political Structures in Late Bronze Age and Early Iron Age Greece," *BSA* 90, pp. 239–250.
- . 1998. "Cargoes of the Heart's Desire: The Character of Trade in the Archaic Mediterranean World," in Fisher and Wees 1998, pp. 295–309.
- Garnsey, P., and I. Morris. 1989. "Risk and the Polis: The Evolution of Institutionalized Responses to Food Supply Problems in the Ancient Greek State," in *Bad Year Economics: Cultural Responses to Risk and Uncertainty*, ed. P. Halstead and J. O'Shea, Cambridge, pp. 98–105.
- Gesell, G. C., W. D. E. Coulson, and L. P. Day. 1991. "Excavations at Kavousi, Crete, 1988," *Hesperia* 60, pp. 145–178.
- Gesell, G. C., L. P. Day, and W. D. E. Coulson. 1983. "Excavations and Survey at Kavousi, 1978–1981," *Hesperia* 52, pp. 389–420.
- . 1985. "Kavousi, 1982–1983: The Kastro," *Hesperia* 54, pp. 327–355.
- . 1988. "Excavations at Kavousi, Crete, 1987," *Hesperia* 57, pp. 279–301.
- . 1990. "Tombs and Burial Practices in Early Iron Age Crete," *Expedition* 32, pp. 22–30.
- . 1995. "Excavations at Kavousi, Crete, 1989 and 1990," *Hesperia* 64, pp. 67–120.
- Greco, E., T. Kalpaxis, A. Schnapp, and D. Viviers. 1996. "Travaux menés en collaboration avec l'École française en 1995: Itanos (Crète orientale)," *BCH* 120, pp. 941–952.
- . 1997. "Travaux menés en collaboration avec l'École française

- en 1996: Itanos (Crète orientale)," *BCH* 121, pp. 793–807.
- . 1998. "Travaux menés en collaboration avec l'École française en 1997: Itanos (Crète orientale)," *BCH* 122, pp. 585–602.
- . 1999. "Travaux menés en collaboration avec l'École française en 1998: Itanos (Crète orientale)," *BCH* 123, pp. 515–530.
- Greco, E., T. Kalpaxis, N. Papadakis, A. Schnapp, and D. Viviers. 2000. "Travaux menés en collaboration avec l'École française en 1999: Itanos (Crète orientale)," *BCH* 124, pp. 547–559.
- Guarducci, M. 1942. *Inscriptiones Creticae 3: Tituli Cretae Orientalis*, Rome.
- . 1961. "Appendix: Epigraphical Notes," in *Archaic Gravestones of Attica*, by G. M. A. Richter, London, pp. 155–174.
- Guizzi, F. 2001. *Hierapytna: Storia di una "polis" cretese dalla fondazione alla conquista romana*, Rome.
- Gummerman, G. 1997. "Food and Complex Societies," *Journal of Archaeological Method and Theory* 4, pp. 105–139.
- Hadjimichali, V. 1971. "Recherches à Latô III: Maisons," *BCH* 95, pp. 167–222.
- Haggis, D. C. 1993. "Intensive Survey, Traditional Settlement Patterns, and Dark Age Crete: The Case of Early Iron Age Kavousi," *JMA* 6, pp. 131–174.
- . 1996. "Archaeological Survey at Kavousi, East Crete: Preliminary Report," *Hesperia* 65, pp. 373–432.
- . 2001. "A Dark Age Settlement System in East Crete and a Reassessment of the Definition of Refugee Settlements," in *Defensive Settlements of the Aegean and the Eastern Mediterranean after ca. 1200 B.C.*, ed. V. Karageorghis and C. Morris, Nicosia, pp. 41–59.
- Haggis, D. C., and M. S. Mook. 1993. "The Kavousi Coarse Wares: A Bronze Age Chronology for Survey in the Mirabello Area, East Crete," *AJA* 97, pp. 265–293.
- Halstead, P. 1981. "From Determinism to Uncertainty: Social Storage and the Rise of the Minoan Palace," in *Economic Archaeology: Towards the Integration of Ecological and Social Approaches*, ed. A. Sheridan and G. Bailey, Oxford, pp. 187–213.
- . 1988. "On Redistribution and the Origins of Minoan-Mycenaean Palatial Economies," in *Problems in Greek Prehistory*, ed. E. B. French and K. A. Wardle, Bristol, pp. 519–530.
- Hanson, V. D. 1992. "Practical Aspects of Grape-Growing and the Ideology of Greek Viticulture," in *Agriculture in Ancient Greece*, ed. B. Wells, Stockholm, pp. 161–166.
- Hayden, B. J. 1983. "New Plans of the Early Iron Age Settlement of Vrokastro," *Hesperia* 52, pp. 367–387.
- . 1997. "Rural Settlement of the Orientalizing through Early Classical Period: The Meseleroi Valley, Eastern Crete," *Aegean Archaeology* 2 (1995), pp. 93–144.
- Hayden, B. J., J. A. Moody, and O. Rackham. 1992. "The Vrokastro Survey Project, 1986–1989: Research Design and Preliminary Results," *Hesperia* 61, pp. 293–353.
- Hoffman, G. L. 1997. *Imports and Immigrants: Near Eastern Contacts with Iron Age Crete*, Ann Arbor.
- Hoffmann, H. 1972. *Early Cretan Armorers*, Mainz.
- Huxley, G. 1994. "On Knossos and Her Neighbors (7th Century to Mid-4th Century B.C.)," in *Knossos: A Labyrinth of History*, ed. D. Evely, H. Hughes-Brock, and N. Momi-gliano, Oxford, pp. 123–133.
- Jameson, M. H. 1990. "Domestic Space in the Greek City-State," in *Domestic Architecture and the Use of Space*, ed. S. Kent, Cambridge, pp. 92–113.
- . 1992. "Agricultural Labor in Ancient Greece," in *Agriculture in Ancient Greece*, ed. B. Wells, Stockholm, pp. 135–146.
- Jeffery, L. H. 1982. "Lordly Tombs: An Epigraphic Sidelight in Archaic Attic Society," in *Πρακτικά του Η' Διεθνούς Συνεδρίου Ελληνικής και Λατινικής Επιγραφικής*, Athens, pp. 52–54.
- Jeffery, L. H., and A. Morpurgo-Davies. 1970. "Ποινικαστάς and Ποινικά-  
ζειν: BM 1969.4-2.1, a New Archaic Inscription from Crete," *Kadmos* 9, pp. 118–154.
- Kinch, K. F. 1914. *Vroulia*, Berlin.
- Kirsten, E. 1942. *Das dorische Kreta*, Würzburg.
- Klippel, W. E., and L. M. Snyder. 1991. "Dark-Age Fauna from Kavousi, Crete: The Vertebrates from the 1987 and 1988 Excavations," *Hesperia* 60, pp. 179–186.
- . 1999. "Harvest Profiles, Domestic Ovicaprids, and Bronze Age Crete," in *The Practical Impact of Science on Near Eastern and Aegean Archaeology* (Wiener Laboratory Monograph 3), ed. S. Pike and S. Gitin, London, pp. 53–61.
- Koehl, R. B. 1997. "The Villas at Ayia Triada and Nirou Chani and the Origin of the Cretan *Andreion*," in *The Function of the "Minoan Villa."* *Proceedings of the Eighth International Symposium at the Swedish Institute at Athens, 6–8 June 1992* (*SkrAth* 4<sup>e</sup>, 46), ed. R. Hägg, Stockholm, pp. 137–149.
- Krause, C. 1977. "Grundformen des griechischen Pastashauses," *AA* 1977, pp. 164–179.
- Lang, F. 1996. *Archaische Siedlungen in Griechenland: Struktur und Entwicklung*, Berlin.
- Langdon, S., ed. 1993. *From Pasture to Polis: Art in the Age of Homer*, Columbia.
- Lavrencic, M. 1988. "ΑΝΔΡΕΙΟΝ," *Tyche* 3, pp. 147–161.
- Lebessi, A. 1973. "Αρχαιότητες και μνημεία κεντρικής και ανατολικής Κρήτης: Αφρατί," *ArchDelt* 25, B' 2 (1970), pp. 455–460.
- Levi, D. 1930–1931. "I bronzi di Axos," *ASAtene* 13–14, pp. 43–146.
- . 1945. *Early Hellenic Pottery of Crete*, Princeton.
- Lissarrague, F. 1990. "Around the Krater: An Aspect of Banquet Imagery," in Murray 1990, pp. 196–209.
- Maaskant-Kleibrink, M., ed. 1996–1997. *Caeculus 3: Debating Dark Ages* (Papers on Mediterranean Archaeology), Groningen.
- Marinatos, S. 1936a. "Le temple géométrique de Dréros," *BCH* 60, pp. 214–256.

- . 1936b. "Le temple géométrique de Dréros (II)," *BCH* 60, pp. 257–285.
- Matthäus, H. 1985. *Metallgefäße und Gefäßuntersätze der Bronzezeit, der geometrischen und archaischen Periode auf Cypern* (Prähistorische Bronzefunde 2.8), Munich.
- Mazarakis Ainian, A. J. 1997. *From Rulers' Dwellings to Temples: Architecture, Religion, and Society in Early Iron Age Greece (1100–700 B.C.)*, Jonsered.
- Mitchell, L. G., and P. J. Rhodes, eds. 1997. *The Development of the Polis in Archaic Greece*, London.
- Mook, M. S. 1993. "The Northwest Building: Houses of the Late Bronze and Early Iron Ages on the Kastro at Kavousi, East Crete" (diss. Univ. of Minnesota).
- . 1994. "The Development of a Domestic Architectural Unit throughout the Early Iron Age: The Northwest Building on the Kastro, East Crete," *AJA* 99, pp. 335–336 (abstract).
- . 1998. "Early Iron Age Domestic Architecture: The Northwest Building on the Kastro at Kavousi," in Cavanagh et al. 1998, pp. 45–57.
- . 2004. "From Foundation to Abandonment: New Ceramic Phasing for the Late Bronze Age and Early Iron Age on the Kastro at Kavousi," in *Crete beyond the Palaces. Proceedings of the "Crete 2000" Centennial Celebration of American Archaeological Work on Crete (1900–2000)* (Prehistory Monographs 10), ed. L. P. Day, M. S. Mook, and J. D. Muhly, Philadelphia, pp. 163–179.
- Mook, M. S., and W. D. E. Coulson. 1997. "Late Minoan IIIC Pottery from the Kastro at Kavousi," in *Late Minoan III Pottery: Chronology and Terminology* (Monographs of the Danish Institute at Athens 1), ed. E. Hallager and B. P. Hallager, Aarhus, pp. 337–370.
- Morgan, C. 2003. *Early Greek States beyond the Polis*, London.
- Morris, I. 1991. "The Early Polis as City and State," in *City and Country in the Ancient World*, ed. J. Rich and A. Wallace-Hadrill, London, pp. 25–58.
- . 1992. *Death Ritual and Social Structure in Classical Antiquity*, Cambridge.
- . 1997. "The Art of Citizenship," in *New Light on a Dark Age: Exploring the Culture of Geometric Greece*, ed. S. Langdon, Columbia, pp. 9–43.
- . 1998. "Archaeology and Archaic Greek History," in Fisher and Wees 1998, pp. 1–92.
- Morris, S. 1992. *Daidalos and the Origins of Greek Art*, Princeton.
- Murray, O., ed. 1990. *Symptica: A Symposium on the Symposion*, Oxford.
- Nevett, L. 1999. *House and Society in the Ancient Greek World*, Cambridge.
- Nowicki, K. 1999. "Economy of Refugees: Life in the Cretan Mountains at the Turn of the Bronze and Iron Ages," in Chaniotis 1999a, pp. 145–172.
- . 2000. *Defensible Sites in Crete, ca. 1200–800 B.C.*, Liège.
- Osborne, R. 1996. *Greece in the Making: 1200–479 B.C.*, London.
- . 1996–1997. "The Spartan Exception," in Maaskant-Kleibrink 1996–1997, pp. 19–24.
- . 2004. "Greek Archaeology: A Survey of Recent Work," *AJA* 108, pp. 87–102.
- Pearsall, D. M. 2000. *Paleoethnobotany: A Handbook of Procedures*, 2nd ed., New York.
- Perlman, P. 1993. "One Hundred-Citied Crete and the 'Cretan politeia,'" *CP* 87, pp. 193–205.
- . 2000. "Gortyn: The First Seven Hundred Years (Part I)," in *Polis and Politics: Studies in Ancient Greek History*, ed. P. Flensted-Jensen, T. H. Nielsen, and L. Rubinstein, Copenhagen, pp. 59–90.
- . 2002. "Gortyn: The First Seven Hundred Years, Part II: The Laws from the Temple of Apollo Pythios," in *Even More Studies in the Ancient Greek Polis* (Papers from the Copenhagen Polis Centre 6), ed. T. H. Nielsen, Stuttgart, pp. 187–228.
- Picard, O. 1992. "Lato," in *The Aerial Atlas of Ancient Crete*, ed. J. W. Myers, E. E. Myers, and G. Cadogan, Berkeley, pp. 155–159.

- Platon, N. 1956. "Ανασκαφή εις Γουλεδιανά Ρεθύμνης," *Prakt* 1956, pp. 226–228.
- Prent, M. 1996–1997. "The Sixth Century B.C. in Crete: The Best Candidate for Being a Dark Age?" in Maaskant-Kleibrink 1996–1997, pp. 35–46.
- . 2003. "Glories of the Past in the Past: Ritual Activities at Palatial Ruins in Early Iron Age Crete," in *Archaeologies of Memory*, ed. R. M. Van Dyke and S. E. Alcock, Oxford, pp. 81–103.
- Raubitschek, A. E. 1972. "Appendix I: A Mitra Inscribed with a Law," in Hoffmann 1972, pp. 47–49.
- Richter, G. M. A. 1961. *Archaic Gravestones of Attica*, London.
- Sackett, L. H., ed. 1992. *Knossos: From Greek City to Roman Colony*, Oxford.
- Samuelsson, E. 1988. "Greek 'Hearth-Temples': An Alternative Interpretation," *AJA* 92, pp. 279–280 (abstract).
- Savignoni, L. 1901. "Fragments of Cretan Pithoi," *AJA* 5, pp. 404–417.
- Schaefer, J. 1957. *Studien zu den griechischen Reliefpithoi des 8.–6. Jahrhunderts v. Chr. aus Kreta, Rhodos, Tenos, und Boiotien*, Stuttgart.
- Schmitt-Pantel, P. 1990. "Sacrificial Meal and *Symposion*: Two Models of Civic Institutions in the Archaic City?" in Murray 1990, pp. 14–33.
- . 1992. *La cité au banquet: Histoire des repas publics dans les cités grecques*, Rome.
- Schoep, I. 2002. "Social and Political Organization on Crete in the Protopalatial Period: The Case of Middle Minoan II Malia," *JMA* 15, pp. 101–132.
- Schwab, K. A. 2000. "Bronze, Lead, and Bone Implements," in Shaw and Shaw 2000, pp. 391–395.
- Schwartz, G. M. 1994. "Rural Economic Specialization and Early Urbanization in the Khabur Valley, Syria," in *Archaeological Views from the Countryside: Village Communities in Early Complex Societies*, ed. G. M. Schwartz and S. E. Falconer, Washington, D.C., pp. 19–36.
- Schwartz, G. M., and S. E. Falconer. 1994. "Rural Approaches to Social Complexity," in *Archaeological Views from the Countryside: Village Communities in Early Complex Societies*, ed. G. M. Schwartz and S. E. Falconer, Washington, D.C., pp. 1–9.
- Shaw, J. W. 2000. "Ritual and Development in the Greek Sanctuary," in Shaw and Shaw 2000, pp. 669–732.
- Shaw, J. W., and M. C. Shaw, eds. 2000. *Kommos IV: The Greek Sanctuary*, Princeton.
- Sherratt, S., and A. Sherratt. 1993. "The Growth of the Mediterranean Economy in the First Millennium B.C.," *WorldArch* 24, pp. 361–378.
- Sjögren, L. 2001. *Sites, Settlements, and Early Poleis on Crete (800–500 B.C.)*, Stockholm.
- . 2003. *Cretan Locations: Discerning Site Variations in Iron Age and Archaic Crete (800–500 B.C.)*, Oxford.
- Small, D. B. 1995. "Heterarchical Paths to Evolution: The Role of External Economies," in *Heterarchy and the Analysis of Complex Societies*, ed. R. M. Ehrenreich, C. L. Crumley, and J. E. Levy, Arlington, pp. 77–79.
- . 1997. "City-State Dynamics through a Greek Lens," in *The Archaeology of City-States: Cross-Cultural Approaches*, ed. D. L. Nichols and T. H. Charleton, Washington, D.C., pp. 107–118.
- Snodgrass, A. 1977. *Archaeology and the Rise of the Greek State*, Cambridge.
- . 1987. *An Archaeology of Greece: The Present State and Future Scope of a Discipline*, Berkeley.
- . 1991. "Archaeology and the Study of the Greek City," in *City and Country in the Ancient World*, ed. J. Rich and A. Wallace-Hadrill, London, pp. 1–24.
- . 1993. "The Rise of the Polis: The Archaeological Evidence," in *The Ancient Greek City-State*, ed. M. H. Hansen, Copenhagen, pp. 30–40.
- Snyder, L. M., and W. E. Klippel. 1999. "Dark Age Subsistence in East Crete: Exploring Subsistence Change and Continuity during the Late Bronze Age–Early Iron Age Transition," in *Aspects of Paleodiet in the Aegean*, ed. S. J. Vaughan and W. D. E. Coulson, Oxford, pp. 65–83.
- Stamplides, N. C. 1990. "Eleutherna on Crete: An Interim Report on the Geometric–Archaic Cemetery," *BSA* 85, pp. 375–403.
- Stein, G. 1994a. "Economy, Ritual, and Power in Ubaid Mesopotamia," in *Chiefdoms and Early States in the Near East: The Organizational Dynamics of Complexity*, ed. G. Stein and M. S. Rothman, Madison, pp. 35–46.
- . 1994b. "Introduction, Part II: The Organizational Dynamics of Complexity in Greater Mesopotamia," in *Chiefdoms and Early States in the Near East: The Organizational Dynamics of Complexity*, ed. G. Stein and M. S. Rothman, Madison, pp. 11–22.
- Van der Vliet, E. C. L. 1996–1997. "The Seventh Century B.C. as a Dark Age: A Historian's Perspective," in Maaskant-Kleibrink 1996–1997, pp. 25–34.
- Vink, M. C. 1996–1997. "The Archaic Period in Greece: Another Dark Age?" in Maaskant-Kleibrink 1996–1997, pp. 1–18.
- Viviers, D. 1994. "La cité de Dattalla et l'expansion territoriale de Lyktos en Crète centrale," *BCH* 118, pp. 229–259.
- . 1999. "Economy and Territorial Dynamics in Crete from the Archaic to the Hellenistic Period," in Chaniotis 1999a, pp. 221–234.
- Wagner, G. 1982. "Testing Flotation Recovery Rates," *AmerAnt* 47, pp. 127–132.
- Wallace, S. A. 2001. "Case Studies of Settlement Change in Early Iron Age Crete (c. 1200–700 B.C.): Economic Models of Cause and Effect Reassessed," *Aegean Archaeology* 4, pp. 61–99.
- Watrous, L. V. 1996. *The Cave Sanctuary of Zeus at Psychro: A Study of Extra-Urban Sanctuaries in Minoan and Early Iron Age Crete*, Liège.
- . 1998. "Crete and Egypt in the Seventh Century B.C.: Temple A at Prinias," in Cavanagh et al. 1998, pp. 75–79.
- Watrous, L. V., and H. Blitzer. 1995. "The Gournia Survey Project:

- A Preliminary Report of the 1992–1994 Field Seasons,” *AJA* 99, p. 313 (abstract).
- Wees, H. van. 1998. “Greeks Bearing Arms: The State, the Leisure Class, and the Display of Weapons in Archaic Greece,” in Fisher and Wees 1998, pp. 333–378.
- Whitley, J. 1991. *Style and Society in Dark Age Greece: The Changing Face of a Prehistoric Society, 1100–700 B.C.*, Cambridge.
- . 1992–1993. “Praesos,” *AR* 39, pp. 77–79.
- . 1997. “Cretan Laws and Cretan Literacy,” *AJA* 101, pp. 635–661.
- . 1998a. “From Minoan to Eteocretans: The Praesos Region, 1200–500 B.C.,” in Cavanagh et al. 1998, pp. 27–39.
- . 1998b. “Literacy and Lawmaking: The Case of Archaic Crete,” in Fisher and Wees 1998, pp. 311–332.
- . 2001. *The Archaeology of Ancient Greece*, Cambridge.
- Whitley, J., K. O’Conor, and H. Manson. 1995. “Praisos III: A Report on the Architectural Survey Undertaken in 1992,” *BSA* 90, pp. 405–428.
- Whitley, J., M. Prent, and S. Thorne. 1999. “Praisos IV: A Preliminary Report on the 1993 and 1994 Survey Seasons,” *BSA* 94, pp. 215–264.
- Willett, R. E. 1955. *Aristocratic Society in Ancient Crete*, London.
- Williams, C. K., II, and J. E. Fisher. 1972. “Corinth, 1971: Forum Area,” *Hesperia* 41, pp. 143–185.
- Woodard, M. E. 1982. “The Principal Figural Reliefs of the Cretan Relief Pithoi of the Seventh Century B.C.” (M.A. thesis, Univ. of North Carolina at Chapel Hill).
- Xanthoudides, S. 1918. “Ἀθήροις,” *ArchDelt* 4, suppl. 2, pp. 23–30.
- Yoffee, N. 1979. “The Decline and Rise of Mesopotamian Civilization: An Ethnoarchaeological Perspective on the Evolution of Social Complexity,” *AmerAnt* 44, pp. 5–35.
- . 1993. “Too Many Chiefs? (or, Safe Texts for the ’90s),” in *Archaeological Theory: Who Sets the Agenda?* ed. N. Yoffee and A. Sherratt, Cambridge, pp. 60–78.

### *Donald C. Haggis*

UNIVERSITY OF NORTH CAROLINA  
AT CHAPEL HILL  
DEPARTMENT OF CLASSICS  
212 MURPHEY HALL, CB 3145  
CHAPEL HILL, NORTH CAROLINA 27599

dchaggis@email.unc.edu

### *Margaret S. Mook*

IOWA STATE UNIVERSITY  
CLASSICAL STUDIES PROGRAM  
FOREIGN LANGUAGES AND LITERATURES  
300 PEARSON HALL  
AMES, IOWA 50011

msmook@iastate.edu

### *C. Margaret Scarry*

UNIVERSITY OF NORTH CAROLINA  
AT CHAPEL HILL  
DEPARTMENT OF ANTHROPOLOGY  
301 ALUMNI BUILDING, CB 3115  
CHAPEL HILL, NORTH CAROLINA 27599

scarry@email.unc.edu

### *Lynn M. Snyder*

SMITHSONIAN INSTITUTION  
NATIONAL MUSEUM OF NATURAL HISTORY  
DEPARTMENT OF ANTHROPOLOGY  
MRC 112  
WASHINGTON, D.C. 20560

snyder.lynn@nmnh.si.edu

### *William C. West III*

UNIVERSITY OF NORTH CAROLINA  
AT CHAPEL HILL  
DEPARTMENT OF CLASSICS  
212 MURPHEY HALL, CB 3145  
CHAPEL HILL, NORTH CAROLINA 27599

wwest@email.unc.edu