



Research article

Communication protocols evaluation for a wireless rainfall monitoring network in an urban area

Lilia Ortega-Gonzalez^{a,b}, Melisa Acosta-Coll^{a,b}, Gabriel Piñeres-Espitia^{a,b}, Shariq Aziz Butt^{a,b,*}^a Department of Computer Science and Electronics, Universidad de la Costa, Calle 56 # 55-66, Barranquilla, Colombia^b Department of Computer Science, University of Lahore, Pakistan

ARTICLE INFO

Keywords:

LoRaWAN
Rainfall monitoring
Zigbee
Sigfox

ABSTRACT

Rainfall monitoring networks are key elements for the development of alerts and prediction models for communities at risk of flooding during high intensity rainfall events. Currently, most of these networks send the precipitation measurement to a data center in real-time using wireless communication protocols, avoiding travel to the measurement site. An Early Warning System (EWS) for pluvial flash floods developed in Barranquilla (Colombia), used the GPRS protocol to send rain gauge data in real-time to a web server for further processing; however, this protocol has a high consumption of energy and also high maintenance costs. This article carried out an evaluation in terms of link budget, link profile, energy consumption and devices costs of three low-power wireless communication protocols, Zigbee, LoRaWAN and Sigfox, to determine which one is the most suitable for the EWS of the city of Barranquilla. To perform the evaluation, a wireless sensor network was designed and characterized for Zigbee and LoRaWAN with Radio Mobile tool taking into account the measurement points implemented with GPRS network. The evaluation included the power consumption of Zigbee, LoRaWAN and Sigfox. From the results of simulations, LoRaWAN and Zigbee network has similar radio signal received and the LoRaWAN network obtains the least losses per path. As for power consumption, the LoRaWAN devices has the lowest energy consumption, as well as, the LoRaWAN network sensor nodes are cheaper. Finally, the protocol with the best general performance was LoRaWAN, since complies with the communication, consumption and cost requirements.

1. Introduction

RAINFALL monitoring is a key element for weather forecasting and any water system analysis (Organización Meteorológica Mundial, 1994). Rain gauges are the validated technological instruments used to measure rainfall. To characterize the space-time variations of rainfall, sufficiently dense rain gauges are required in the area to be monitored (Mendoza et al., 2016).

Currently, rain gauges operate in networks that use wireless communication to send measurements and avoid data collection only at the monitoring site. With the rise of the Internet of Things (IoT), Wireless Sensor Networks (WSNs) were integrated into the ecosystem of technologies that are widely used for environmental monitoring (Bonilla et al., 2016). In the above wireless sensor networks, the nodes interact with the environment through sensors to collect information in real-time and transmit it to a base station for further processing. These networks operate with efficient radio communication by optimizing packet

forwarding, transmission speed and power consumption of the connected devices (Rueda and Talavera, 2017) (Martínez et al., 2009).

WSNs operate with different wireless communication protocols, which have been applied rainfall monitoring projects with IoT; the most widely used are GPRS, Sigfox, LoRa, WiFi, ZigBee, Bluetooth, and NarrowBand IoT (NB IoT) (Talavera et al., 2017). Table 1 compares these technologies according energy consumption, range, security, and data rate (Bhoyar et al., 2019) (Sadowski and Spachos, 2020).

For flood modeling in urban areas, precipitation measurement is one of the main inputs. However, the deployment of WSN faces more challenges than rural and suburban environments; this is because it has less line of sight view and a higher risk of environmental interference (Cama-Pinto et al., 2016). In Barranquilla, Colombia, the Universidad de la Costa, developed an early warning system (EWS) for the detection of urban pluvial flooding hazard with a hydrological and hydraulic model (Acosta-Coll et al., 2018). Since the city was built without a stormwater drainage system, dangerous flash floods form along the city streets during

* Corresponding author.

E-mail address: shariq2315@gmail.com (S. Aziz Butt).

Table 1. Compares these technologies according energy consumption.

	GPRS	Bluetooth	WiFi	Zigbee	LoRaWAN	Sigfox	NB-IoT
Modulation	GMSK	GFSK	BPSK QPSK COFDM CCK MQAM	BPSK O-QPSK	CSS	BPSK	QPSK
Frequency	0,8 GHz 1,7 GHz 1,8 GHz	2.4GHz	2.4 GHz 5 GHz	868 MHz 915 MHz 2.4 GHz	915 MHz	915 MHz	Licensed LTE frequency bands
Bandwidth	200 kHz	1 MHz	22 MHz	300 kHz 600 kHz 2 MHz	125 kHz 250 kHz	100 Hz	200 kHz
Maximum data rate	114 kbps	1 Mbps	54 Mbps	250 kbps	300 kbps	100 bps 600 bps	200 kbps
Range (Urban)	5 km	10m	100m	100m	5 km	10 km	1 km
Transmit current (Max)	500mA	300mA	700mA	285mA	135mA	200mA	220mA

heavy rain events; this endangering pedestrians and drivers, causing deterioration of the network vial, and disrupts business activity (Acosta Coll, 2013).

Developed EWS provides information on flash flood intensity, speed, and depth from a 4.5 km long channel of an ungauged basin through a WSN. This EWS consists of a WSN with three nodes deployed along the channel; is powered by a photovoltaic system and composed of a rain gauge, gateway, and a GPRS module to send the acquired data. However, despite their high coverage and transmission power, GPRS technology consumes more energy and requires high maintenance costs than other wireless communication technology.

In order to improve this WSN into a low-cost and more energy-efficient system, this study selected three wireless communication protocols, Zigbee, LoRaWAN, and Sigfox, to perform an evaluation and determine the most suitable one in terms of communication, link budget, link profile, energy consumption, and implementation cost. To carry out the evaluation, a wireless network is developed for Zigbee and LoRaWAN. The link profile was evaluated by performing simulations using the free software Radio Mobile, and the same node location points. The evaluation included an analysis of power consumption of Zigbee, LoRaWAN and Sigfox.

2. Review of related work

2.1. Wireless rainfall monitoring network

Autonomous and connected rain gauges are used in many cities for monitoring rainfall (Kama et al., 2018). Previously, GPRS technology was the most used for the implementation of wireless networks for rainfall monitoring. In (Garcia et al., 2016), a real-time urban flood monitoring system was deployed using the GPRS network in Bulevar España, Manila, Philippines. The system's stations were composed of a soil pressure sensor and a rain gauge connected to a data logger. Data from the stations were sent using the GPRS network to a TCP server. The information obtained was processed to provide visual information and real-time flood updates via mobile and web services.

In the same way, in Namibia a WSN has been developed in Namibia to monitor rainfall and manage water resources in southern Africa. This system is based on the Arduino Platform, a GPRS Module (SIM 900), a Solar panel with battery, a temperature and humidity sensor (DHT 22) and a tipping bucket rain gauge (TBRG). The data are sent to the cloud via TCP protocol and received by the PHP-based Weather underground server. This system allows capturing data every 2,5 min and displaying readings and graphs of temperature, humidity and precipitation data obtained from the stations (Mangundu et al., 2017).

Operating costs, energy consumption and development of IoT protocols have led to new wireless technologies for real-time rainfall monitoring. In (Santos et al., 2020) a rain application is developed based on a hybrid architecture; it provides communication between a digital rain gauge (transmitter) and a data server (receiver) through wireless communication technologies in Petrópolis, Rio de Janeiro, Brazil. The proposed hybrid architecture is based on short and long range communication that compares the performance of Wi-Fi and LoRa technologies. The wireless technologies are evaluated in terms of packet loss, performance and packet arrival delay for prototype development. The tests were carried out in different measurement scenarios in real-time. The results showed that Wi-Fi provides higher bandwidth over short distances, while LoRa provides robust communication over long distances.

Early warning systems are one of the most widely used applications in rainfall monitoring. In (Vitadhani et al., 2020) a simulation study was carried out to explore the use of LoRaWAN technology for the flood early warning control system on the Ciliwung River, Jakarta, Indonesia. The proposed system allows the communication of monitoring points with several LoRa gateways. To determine the location of the gateways, the monitoring zone was divided into two areas according to the monitoring points of an existing system. This system was simulated through the NS3 tool, obtaining an optimal height for the first gateway at 30 m in the first area and at 108 m for the gateway of the second area or having two gateways in this area at 30 m. The results show the feasibility of implementing LoRaWAN technology to support water level telemetry to form a river flood early warning system.

Other wireless rainfall monitoring system is based on Arduino with NB-IoT, CoAP protocol and a weather sensor kit. This prototype is installed at Rajamangala beach and the data are displayed through the Grafana tool on a PC (Kaewwongsri and Silanon, 2020).

2.2. Early warning systems in Barranquilla - Colombia

For several years now, the city of Barranquilla has presented a problem in the management of rainwater in its urban area. The lack of a rainwater drainage system in the entire city and the high slopes of the streets and impermeable areas produce runoffs; these flow through the streets with flows exceeding $100 \text{ m}^3/\text{s}$ in rain events (Ávila et al., 2017). In (Ávila, 2012) an early warning model is developed for the management of flash floods in the city of Barranquilla, based on real-time rainfall data, and the integration of a rainfall-runoff model in the PCSWM with the decision making criteria on hazards associated with water depth and speed. For the development of the system twelve rain gauges were installed in the city covering about 150 km². The model combines the processing of rainfall data in real-time (with a 1 min interval), a

rainfall-runoff model in the PCSWMM and an estimate of the hazard level for each intersection in streets susceptible to flash flooding. Finally, the results of the calibrations and validations of measured rainfall and flow data allowed to anticipate the flow and hazard level five to 40 min in advance. This time can allow people to make quick decisions regarding their mobility in the city and reduce accidents caused by flash floods.

Other investigation (Acosta-Coll et al., 2018) describes a low-cost early warning system to detect in real-time the danger level of a stream in the city of Barranquilla. For the deployment of the system they developed a hydraulic and hydrological model capable of calculating the speed, flow and level of water and its variation over time. The model displays its information in cross-sections of a stream in an ungraded basin using only rain gauges and data from topographic studies. The alert is then sent to a web platform through a network of wireless sensors to warn the community in real-time of the danger of the event.

Wireless sensor networks have also been used for monitoring flash flooding in the city of Barranquilla. In (Cama-Pinto et al., 2016) it is shown the design of a wireless sensor network architecture to monitor in real-time atmospheric parameters that influence the detection of the danger level of flash floods. For the deployment of the network, a section of the route of a specific stream in the city is characterized; in this section, the points where the main tributaries are received are identified; in addition, the nodes that will monitor the environmental conditions and determine the level of alert are established. For the capture and transmission of the data, the Libelium Waspote platform and Zigbee technology are used through the XBee-PRO ZB (S2) radio modules. The information obtained by the nodes are hosted in a server to be finally displayed in a mobile web application; this application shows the population the level of danger of the stream at different points of its path.

2.3. Network design and simulation using Radio Mobile software

Under the implementation of the Longley-Rice model, the Radio Mobile software has multiple support utilities for the design and simulation of telecommunication links and networks. The simulation parameters allow to reflect in real form the equipment intended to be used in the physical implementation (García Garrancho, 2006).

Different works use the Radio Mobile software to simulate radio links and to provide important design information. In this case (Trandafir et al., 2010), presents the output analysis of the simulation of a public Wi-Fi network using the Radio Mobile application. The network consists of access points installed on the roof of the trains and fixed antennas mounted on masts on the side of the Bucharest-Brasov railroad, Romania. The results of the simulations show the distribution and availability of the radio signal in terms of area coverage and point-to-point links between the established radio units.

The mobile radio software is also used in (Balmaceda et al., 2018) in order to expand the coverage area and improve the capacity of the WiMAX network of the internet service provider Yota in Nicaragua. For this purpose, simulations of radio links have been carried out and implemented in three representative sites of the WiMAX network; in these sites, a measurement and monitoring campaign of the established radio links has been carried out. The comparative analysis of the predictions with the results of the measurements and monitoring at the WiMAX network sites, shows a 50% improvement of the network capacity with the implementation and monitoring of the designed low-cost radio links. From the results of the simulations it was also concluded that the performance and coverage of the WiMAX network can be improved using multi-antenna techniques and higher order modulation and coding schemes (Caicedo-Ortíz, 2015).

In Barranquilla (Caicedo-Ortíz et al., 2018) Radio Mobile is used to evaluate the feasibility and stability of the Z1 node link in a cassava crop. Two tests were performed, first in a free space scenario and second test introducing losses due to vegetation. Simulations of the first test indicate a good sensitivity at the receiver with a tolerance margin of 31.6 dB between

the Gateway and the Z1 node. In the second test, a 10% loss was introduced in the link simulations to simulate vegetation, resulting in a tolerance margin of 27.9 dB. Both tests indicate good results in the link budgets.

3. Methodology

In this work, first, the coverage area, the location of the nodes, the distances between the nodes and the core network, and the most suitable devices for each technology were established. Secondly, a WSN was designed for LoRaWAN and ZigBee technology, using the free Radio Mobile software the link profile was evaluated.

Since the effective propagation of radio signal depends on an accurately prepared link budget that provides an account for all the gains and losses from a transmitter through a medium (free space, cable, waveguide etc) to a receiver. The link budget includes parameters such as the effective isotropic radiated power of the transmitter (EIRP), that is the maximum power allowed to be sent to open space in a specific area (Buettrich, 2007), and the link margin which is obtained by comparing the expected received signal strength with the receiver sensitivity or threshold (Seibold, 2005).

The effective isotropically radiated transmitter power (EIRP) and the link margin can be expressed as follows

$$EIRP = PTx + GTx \quad (1)$$

where,

PTx is the transmit power in dBm

GTx is the gain of the transmitting antenna in dB

$$\text{Link margin} = EIRP - L_{Total} + GRx - THR_x \quad (2)$$

where,

$EIRP$ is the effective isotropically radiated power in dBW or dBm

L_{Total} is the total path loss, including miscellaneous losses, reflections and fading margins in dB

GRx is the receive gain in dB

THR_x is the receive threshold or receive sensitivity in dBW or dBm.

Both the link profile and link budget were evaluated in two types topologies, star and mesh. These scenarios allow us to determine the wireless communication protocol with the best communication performance in urban areas for rainfall monitoring.

In order to evaluate the link profile, we used the Radio Mobile software, which is a tool allows simulating radio links that operate within the range from 20 MHz to 20 GHz; besides model of relief planes of the study site with values quite similar to those acquired in physical implementations (Caicedo-Ortíz, 2015). Likewise, Radio Mobile software emulates the characteristics of the wireless communication system as well as the parameters of each equipment.

3.1. Wireless rainfall monitoring network design

Wireless sensor networks are a set of autonomous sensors spatially distributed in a specific region to observe some phenomena and collect data of interest (Martínez et al., 2009). A WSN has different sensor nodes that acquire data and a master node that sends the data to a base station for further processing (Koucheryavy and Salim, 2009).

For the design of the WSN with Zigbee and LoRaWAN, the architecture of the early warning system developed by the Universidad de la Costa (Acosta-Coll et al., 2018) was used, which contain three nodes to monitor the dangerous flash flood called "La Brigada". The WSN used the same three measurement points and added a fourth point corresponding to the gateways of each technology. Table 2 shows the location for the nodes and gateway. For the Sigfox architecture, it works as a GPRS

Table 2. Location for the nodes and gateway.

Item	Location	Node to gateway distance
Gateway	10°59'42.69"N,74°47'20.25"W	N/A
Node 1	10°59'1.57"N, 74°48'6.34"W	1.89 km
Node 2	10°59'30.90"N,74°47'48.26"W	0.92 km
Node 3	10°59'35.81"N,74°47'35.18"W	0.50 km

solution and needs coverage in the deployment area; the Sigfox service operator will manage the gateway remotely; therefore, this solution is not owned. Figure 1 illustrates the distribution of the nodes and the distance between the monitoring nodes and the base station for the WSN solution.

3.2. Architecture and network parameters

The WSN architecture for the monitoring system has three nodes and a base station. Each node contains an Arduino Uno, a rain gauge, a data transmission module; the nodes and the gateway are powered by a photovoltaic system composed of a solar panel, a rechargeable battery and a charge controller. Also, the base station has a photovoltaic system and a gateway, corresponding to each of the selected wireless technologies. Figures 2, 3 and 4 illustrate the node components for LoRaWAN, ZigBee and Sigfox technology respectively; Figures 5 and 6 show the base stations components for ZigBee and LoRaWAN technology. Table 3 presents the transmission parameters, coverage, and performance of the

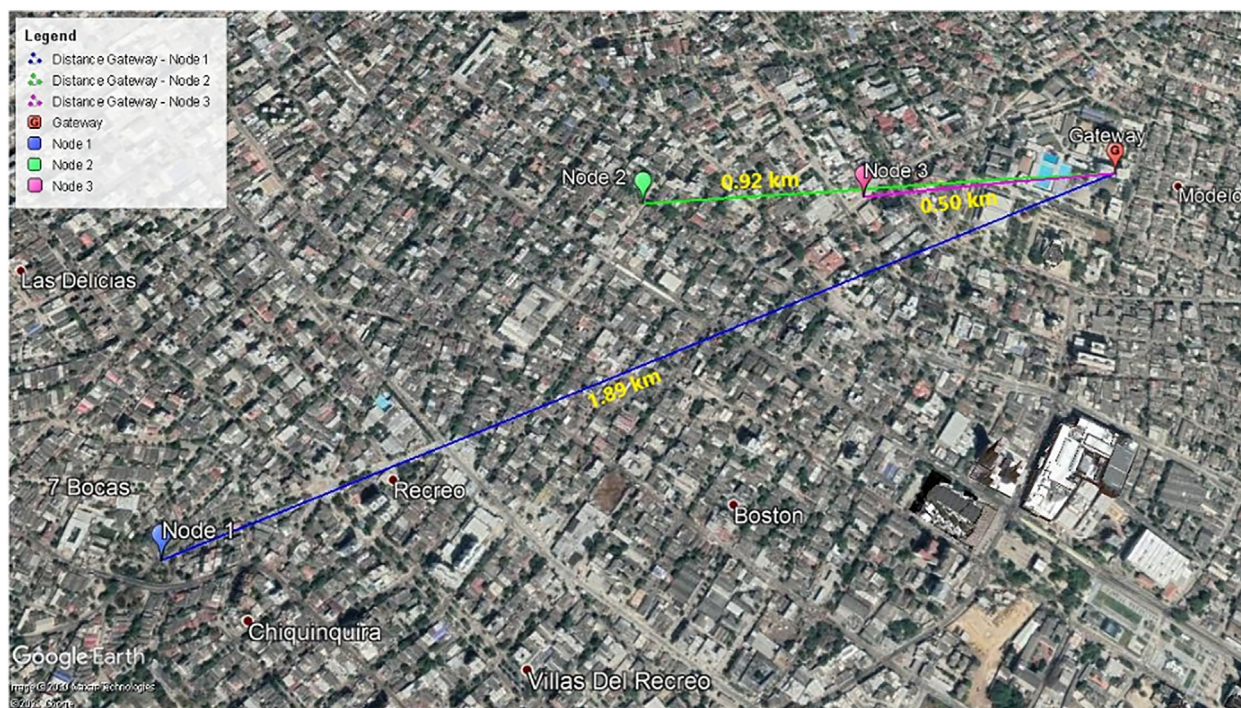

Figure 1. Nodes distance to gateway.

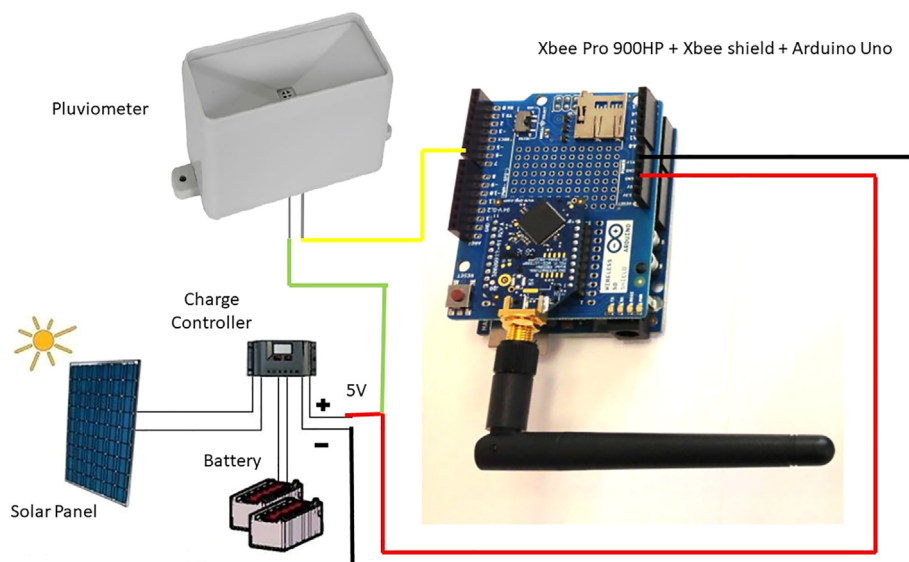

Figure 2. ZigBee nodes components.

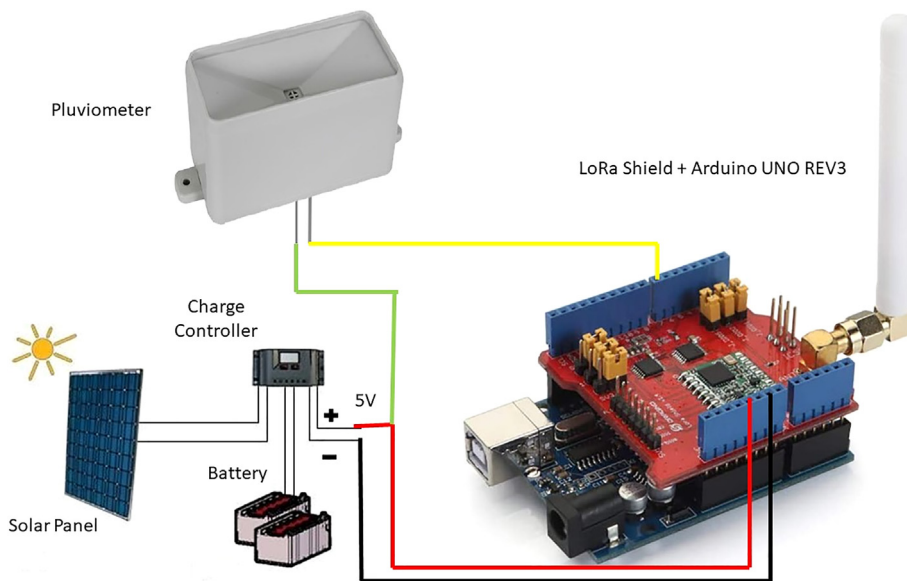

Figure 3. LoRAWAN node components.

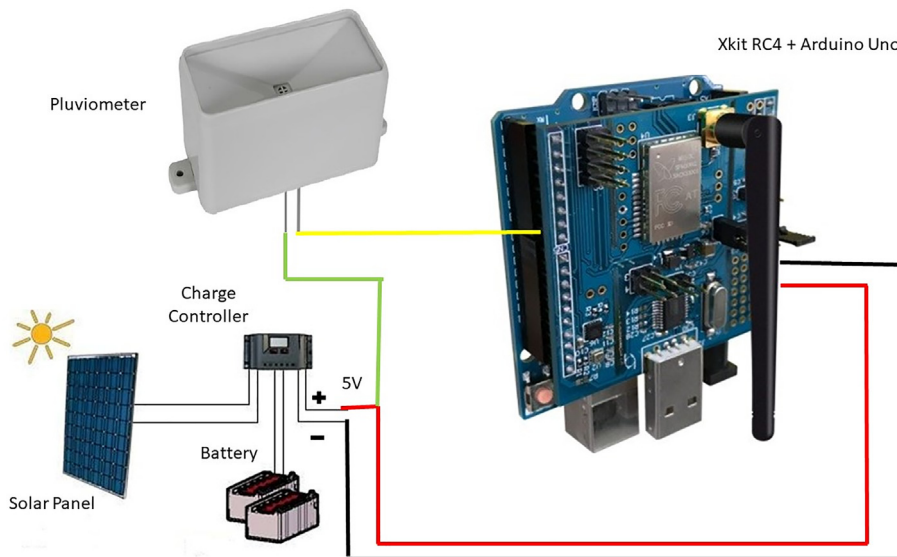

Figure 4. SigFox node components.

transmission modules, and Table 4 the main features of the selected gateways for each wireless technology.

3.3. Radio mobile design

For ZigBee and LoRaWAN, we used Radio Mobile to evaluate the links profile between the sensor nodes and the gateway. Radio Mobile uses the Longley-Rice irregular terrain model as a propagation radio model in the 20MHz to 20GHz frequency range (Zennaro et al., 2010). The software shows the antennas gain range, the tolerance loss of the connections, and the minimum transmits power of the radios on each link.

The nodes and gateways locations are taken from Table 2, and the communication modules parameters from Table 3 and Table 4. Sensor nodes were located in light pole at 10 m height above ground level. The gateway is located to 46 m above sea level on the roof of a building. For the star topology, the sensor nodes work as slaves, and the central node formed by the gateway works as the master node. On the other hand, the

mesh topology is a multi-hop system, each node can send and receive information from another node and from the gateway. Unlike the star topology, where communication can only occur between the sensor nodes and the gateway, in the mesh topology the nodes can send messages to each other. Figure 7 shows the links between the nodes and the gateway.

4. Results and discussion

4.1. Link profile

For the link profile evaluation between the sensor nodes and the gateway, the Radio Mobile software calculates the free space loss, obstruction, total path loss, received signal, and system gain. Table 5 presents the link profile results for the network with Zigbee and LoRaWAN with star topology and Table 6 presents the results of mesh topology. Sigfox technology was not evaluated with the Radio Mobile tool

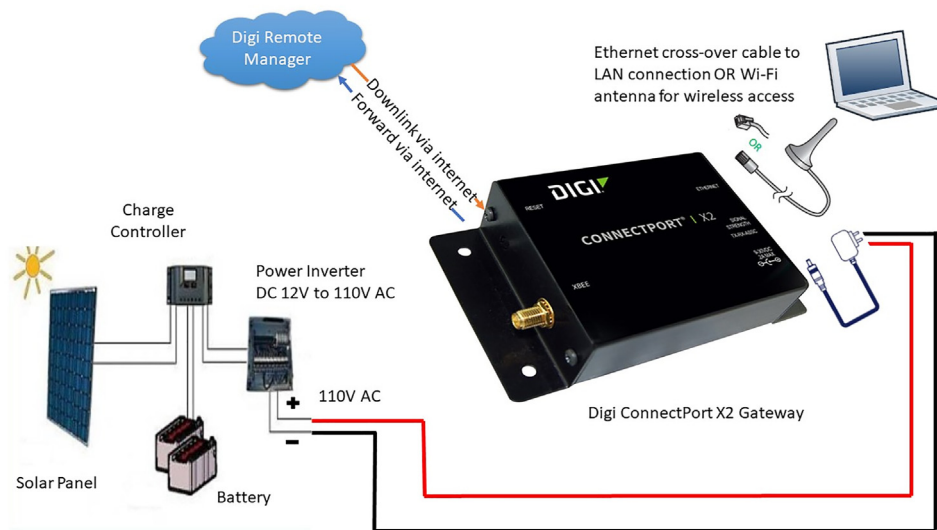

Figure 5. ZigBee base station components.

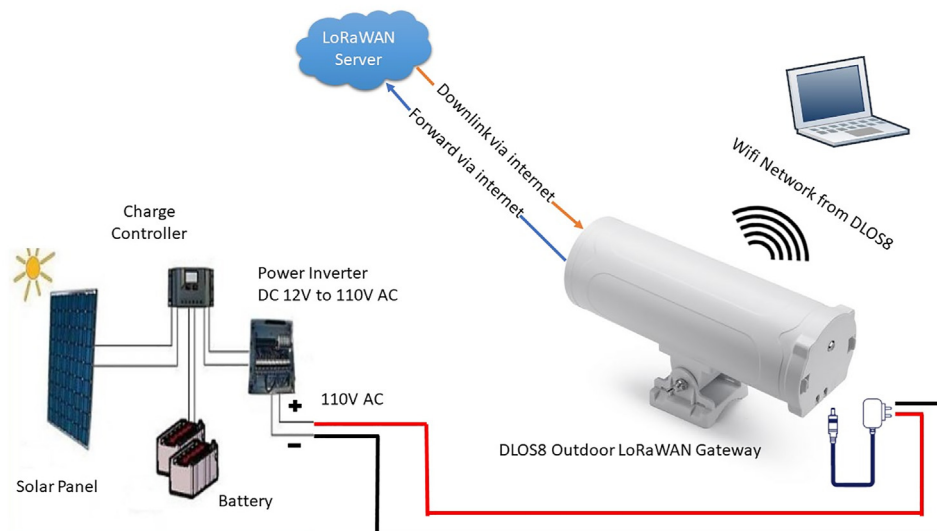

Figure 6. LoRaWAN base station components.

Table 3. Transmission parameters, coverage, and performance of the transmission modules.

Technology	Zigbee	LoRaWAN	Sigfox
Transmission module	Digi XBee-PRO 900HP	Dragino LoRa Shield v1.2	Thinextra Xkit RC4
Frequency band	902 a 928 MHz	915 MHz	902 a 928 MHz
RF Data rate	Up 200 Kbps	Up 300 Kbps	0.6 Kbps
Outdoor/line-of-sight range	6.5 km	15 km	30 km
Transmit power	+24 dBm - 250 mW	+20 dBm - 100 mW	+22.5 dBm - 178 mW
Receiver sensitivity	-101 dBm	-148 dBm	-129 dBm
Antenna	Dipole 2.1 dBi	Omnidirectional 3dBi	Omnidirectional 3dBi

because the gateway is owned by the service provider, i.e., it is part of a third party in the network design architecture.

4.1.1. Star topology analysis

The received radio signal strength of the link profiles is a key part of the network measurement reports (NMR). The received radio signal strength is measured as Rx-Level and is reported in a range from 0 to 64. The Rx-Level is the signal level above -110 dBm. An Rx-Level 30 is: $-110 + 30 \text{ dB} = -80 \text{ dBm}$ (Kadhim and Salih, 2014). Table 7 shows the range of received radio signal strength in dBm values.

According to Tables 5 and 7, the links simulated with the Radio Mobile software are strong for each of the wireless networks and meet the established network requirements. According to the Rx-Level values of each link, the Zigbee and LoRa devices obtain similar received radio strength. On the other hand, the devices with the lowest received signal strength were those used in the LoRaWAN network; however, the variation of values with the Zigbee network is in the range of 2.5 dBm.

Regarding path loss, the results are quite similar for the two wireless networks. With a low difference, the LoRaWAN network had lower path

Table 4. Main features of the selected gateways.

Technology	Zigbee	LoRaWAN
Gateway	Digi Connectport X2	Dragino DLOS8
Frequency band	902 a 928 MHz	915 MHZ
RF Data rate	200 Kbps	300 Kbps
Receiver sensitivity	-101 dBm	-140 dBm
Antenna	External	External
Protection	IP68	IP65

Table 7. Range of radio signal strength in dBm values.

RX level (dBm)	Strength
-120 to -95	Poor
-95 to -83	Good
-85 to -70	Very Good
-70 to -10	Excellent

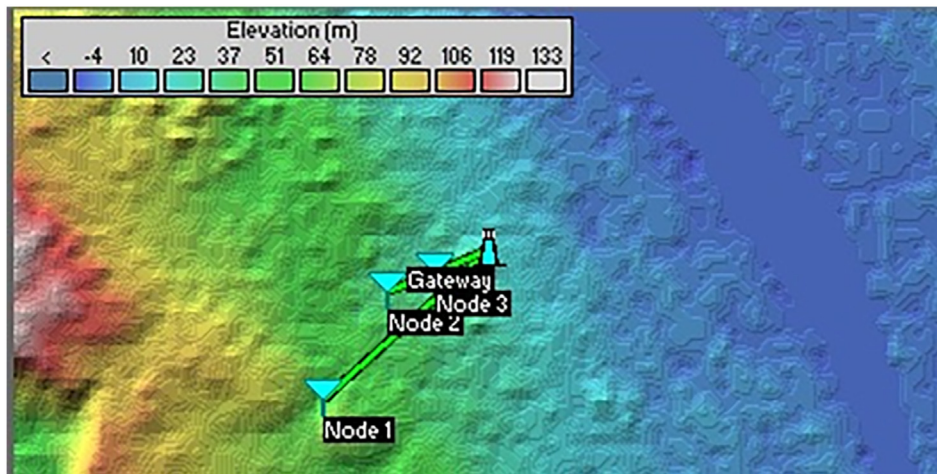

Figure 7. Nodes and gateway link.

loss. The obtained results are attributed to the fact that the selected LoRaWAN devices achieve a sensitivity higher than -148dBm. In addition, the slack in both links is 2.1 F1 (radius of the first Fresnel zone) as shown in Figure 5; this value guarantees a stable link between the node and the gateway. Figure 8 shows the RadioMobile simulation for the farthest link between the node and the gateway in Zigbee and LoRa technologies.

4.1.2. Mesh topology analysis for link profile

Comparing Tables 5, 6, and 7, the Rx-Level values of the mesh topology links are higher than those evaluated in the star topology, proving its robustness and stability. In the mesh topology, the Zigbee network devices obtain higher received radio intensity. However, the variation of values with the LoRaWAN network is in the range of 2.2 dBm.

Table 5. Link profile results for the network with Zigbee and LoRaWAN star topology.

Network	Zigbee Network			LoRaWAN Network		
	Node 1 to Gateway	Node 2 to Gateway	Node 3 to Gateway	Node 1 to Gateway	Node 2 to Gateway	Node 3 to Gateway
Average frequency (MHz)	915	915	915	908.5	908.5	908.5
Free Space Loss (dB)	97.1	90.9	85.6	97.1	90.9	85.6
Obstruction (dB)	-2.3	-1.7	-4.9	-1.8	-2.4	-4.8
Statistics (dB)	6.3	6.2	6.3	6.3	6.2	6.3
Total Path loss (dB)	101.1	95.5	87.0	101	94.7	87.0
Rx level (dBm)	-73.0	-67.3	-58.8	-75.5	-68.7	-61.0
System gain (dB)	129.1	129.1	129.1	174.0	174.0	174.0

Table 6. Link profile results for the network with Zigbee and LoRaWAN mesh topology.

Network	Zigbee Network			LoRaWAN Network		
	Node 1 to Node 2	Node 2 to Node 3	Node 3 to Node 1	Node 1 to Node 2	Node 2 to Node 3	Node to Node 1 3
Average frequency (MHz)	915	915	915	908,5	908,5	908,5
Free Space Loss (dB)	92,1	84,2	94,7	92,1	84,1	94,6
Obstruction (dB)	-5,6	7,3	-5,9	-5,5	5,5	-6
Statistics (dB)	5,7	4,9	5,8	5,7	4,9	5,8
Total Path loss (dB)	92,3	96,4	94,6	92,3	94,5	94,5
Rx level (dBm)	-64,2	-68,3	-66,4	-66,4	-68,5	-68,5
System gain (dB)	129,1	129,1	129,1	174	174	174

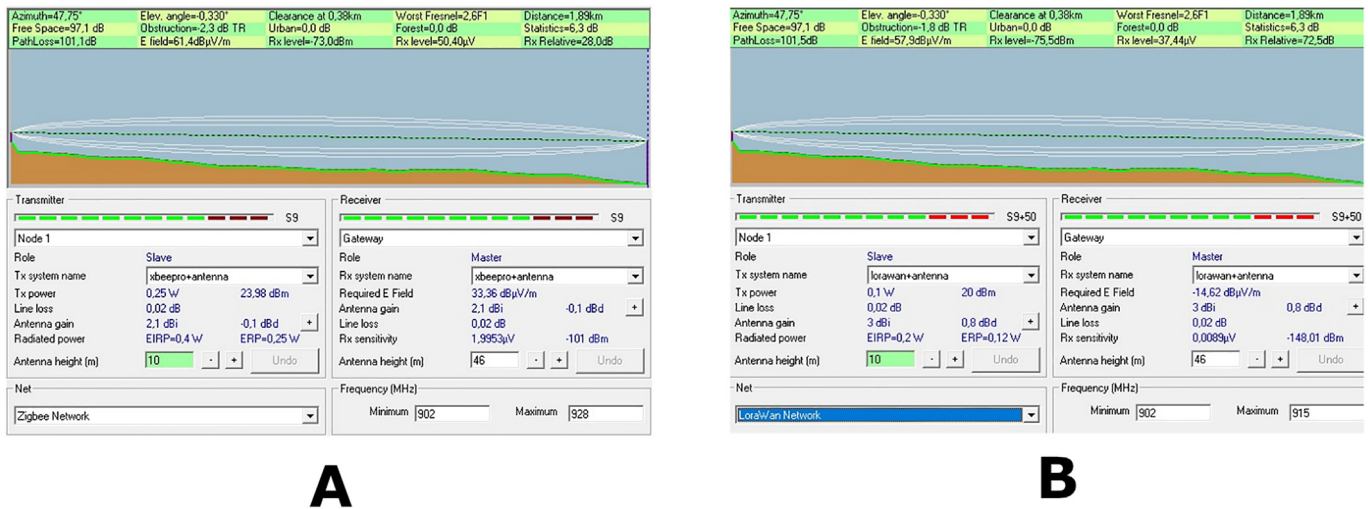

Figure 8. Radio Mobile Simulation star topology. A. Zigbee Node. B. LoRa Node.

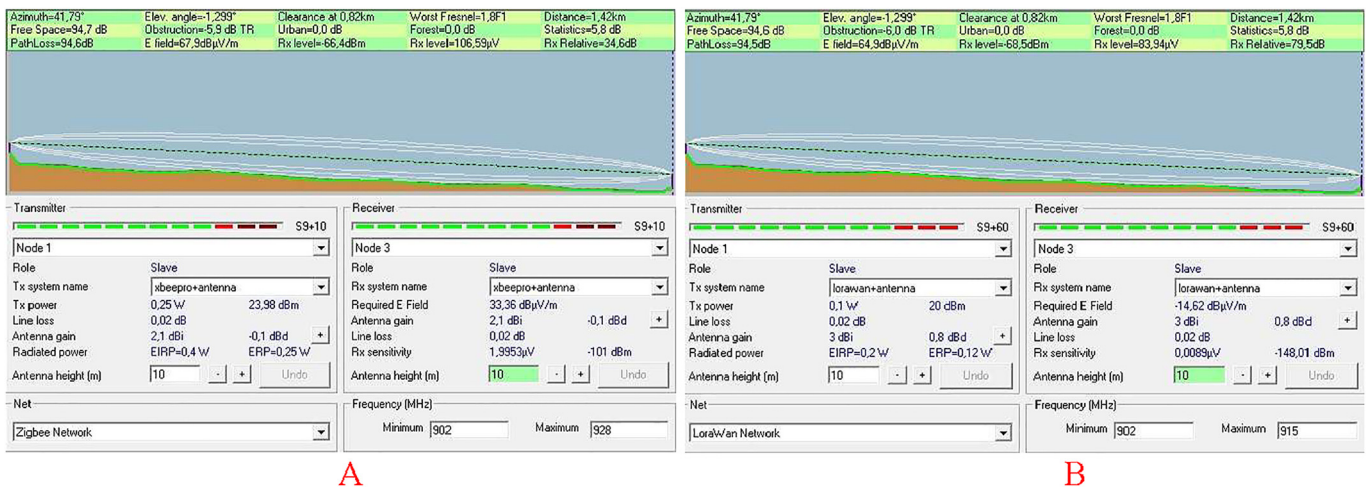

Figure 9. Radio Mobile Simulation mesh topology. A. Zigbee Node. B. LoRa Node.

In terms of path loss, the results remain quite similar for the two wireless networks. With a minor difference, the LoRaWAN network had a lower path loss. In this case, the slack in both links is 1.8 F1 (radius of the first Fresnel zone), as shown in Figure 6; this value guarantees a stable link between the nodes. Figure 9 shows the RadioMobile simulation for the farthest link between node 1 and node 3 in Zigbee and LoRa technologies.

4.2. Link budget

A link budget takes into account the effective isotropic radiated power of the transmitter (EIRP) and all losses in the link upstream of

the receiver (Seybold, 2005). The link margin corresponds to the difference between the received signal value and the receiver sensitivity and EIRP is the maximum power allowed to be sent to open space in a specific area (Buettrich, 2007). The available link margin depends on many factors, the type of modulation used, the transmitted power, the net gain of the antenna, any waveguide or cable loss between the transmitter and antenna, the radome loss and, most importantly, the path loss.

Over a given path, the variation over a period of time in path loss can be large, so an adequate margin must be considered to ensure a stable, quality link during adverse weather conditions or other atmospheric

Table 8. Link budget results for the network with Zigbee and LoRaWAN star topology.

Red	Zigbee			LoRaWAN		
	Node 1 to Gateway	Node 2 to Gateway	Node 3 to Gateway	Node 1 to Gateway	Node 2 to Gateway	Node 3 to Gateway
Transmit power (dBm)	23,98	23,98	23,98	20	20	20
Antenna transmission gain (dB)	2,1	2,1	2,1	3	3	3
EIRP (dB)	26,08	26,08	26,08	23	23	23
Path loss (dB)	101,1	95,5	87,0	101	94,7	87,0
Receiver sensitivity (dBm)	-101	-101	-101	-148,01	-148,01	-148,01
Antenna receive gain (dB)	2,1	2,1	2,1	3	3	3
Link Margin (dB)	28,08	33,68	42,18	73,01	79,31	87,01

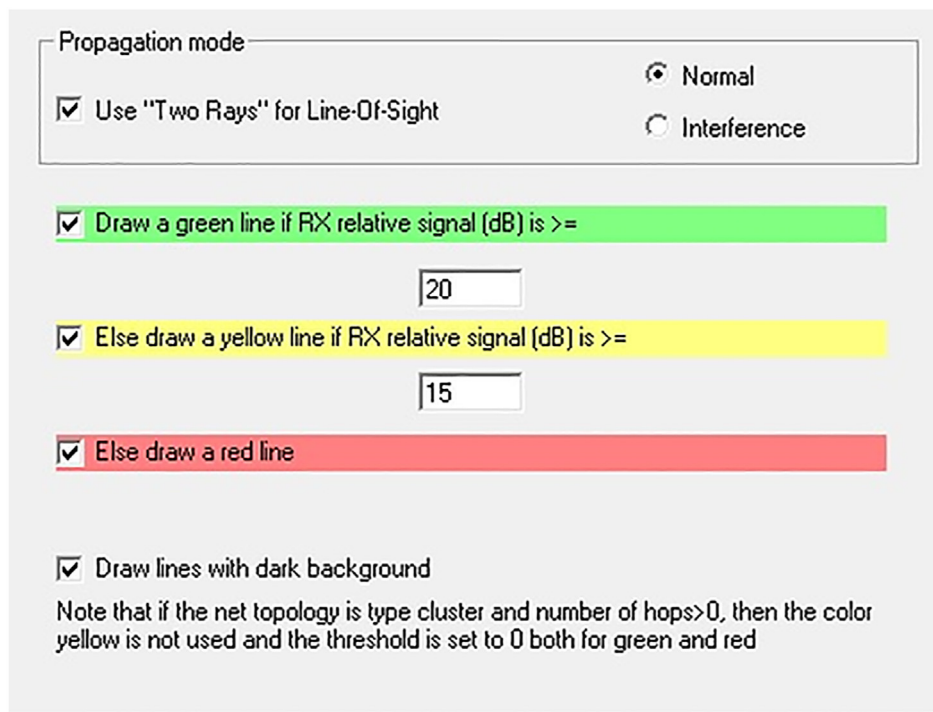

Figure 10. Radio Mobile Rx Relative configurations.

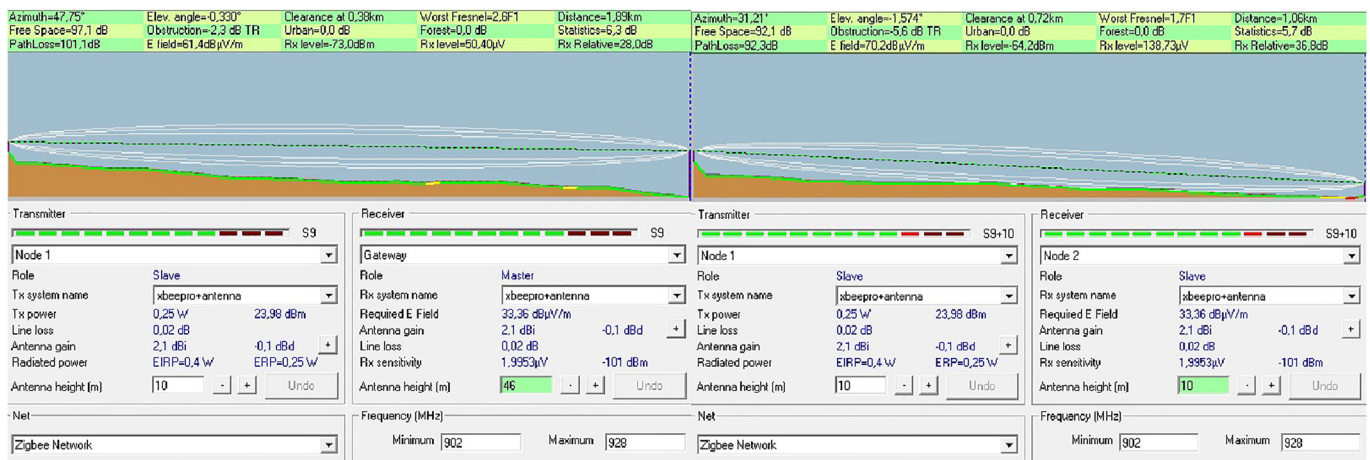

Figure 11. Radio Mobile Simulation Zigbee Node 1 to Node 2. A. mesh topology. B. star topology.

Table 9. Link budget results for the network with Zigbee and LoRaWAN mesh topology.

Red	Zigbee			LoRaWAN		
	Node 1 to Gateway	Node 2 to Gateway	Node 3 to Gateway	Node 1 to Gateway	Node 2 to Gateway	Node 3 to Gateway
Transmit power (dBm)	23,98	23,98	23,98	20	20	20
Antenna transmission gain (dB)	2,1	2,1	2,1	3	3	3
EIRP (dB)	26,08	26,08	26,08	23	23	23
Path loss (dB)	92,3	96,4	94,6	92,3	94,5	94,5
Receiver sensitivity (dBm)	-101	-101	-101	-148,01	-148,01	-148,01
Antenna receive gain (dB)	2,1	2,1	2,1	3	3	3
Link Margin (dB)	34,78	30,68	32,48	78,71	76,51	76,51



Figure 12. Radio link from node 1 to node 2 Google Earth.

Table 10. The power parameters of the sensor nodes transmission.

Technology	Zigbee	LoRaWAN	Sigfox
Transmission module	Digi XBee-PRO 900HP	Dragino LoRa Shield v1.2	Thinextra Xkit RC4
Supply voltaje (VDC - Voltage Direct Current)	2.1 to 3.6	3.3	2.7 to 3.6
Transmit current (mA - milliamps)	215	120	200
Receive current (mA - milliamps)	29	10.8	32
Sleep current (uA - microamps)	2.5	1	2.5

anomalies. A margin of 10–15 dB is typical under normal conditions, but in the presence of noise in the received signal, a margin on the order of 20 dB should be considered. In urban areas where there are many radio links operating it is common to find high noise levels. Therefore, in such scenarios an even larger margin is required.

In Radio Mobile, the Rx Relative parameter allows to know the margin value with respect to the sensitivity of the receiving system with which the received signal power arrives. In Radio Mobile it is also possible to differentiate the relative reception margin for each link. The software is configured so that all margins below 15dB are marked in red, between 15 and 20 dB in yellow and those above 20dB in green. Figure 10 presents the relative margin configuration.

4.2.1. Star topology analysis for link budget

Antenna gains, transmission losses and transmitted power directly affect the link budget. The link budget parameters of each of the profiles performed are recorded in Table 8.

In terms of margin, all the developed radio links meet the necessary requirements to guarantee their stability and quality in the presence of noise in urban areas. Comparing the margin values of the links recorded in Table 8, the LoRaWAN radio links have the highest margins. The margins obtained are attributed to the fact that LoRaWAN's high sensitivity, combined with its integrated +20 dBm power amplifier, provides an optimal link budget for this application requiring range or robustness.

4.2.2. Mesh topology analysis for link budget

For the mesh topology, the link budget parameters for each of the radio links performed are shown in Table 9.

In terms of margin, the radio links developed in mesh topology are superior to those developed in star topology, meeting the quality and

Table 11. The power parameters of the gateways.

Technology	Zigbee	LoRaWAN
Gateway	Digi Connectport X2	Dragino DLOSS
Power input (VDC - Voltage Direct Current)	9–30	12–24
Power supply (VDC - Voltage Direct Current)	12	12
Power consumption (Watts - W)	1.2, Max: 3.4	3.6, Max: 6

Table 12. Comparison of the equipment.

Technology	Zigbee		LoRaWAN		Sigfox	
	Device	Cost	Device	Cost	Device	Cost
Transmission module	Digi XBee-PRO 900HP	\$44.50	Dragino LoRa Shield v1.2	\$24.49	Thinextra Xkit RC4	\$36.25
Antenna	Antenna - 900 MHz, half wave dipole, 2.1 dBi	\$20	915MHz ISM, RF Antenna 903MHz–928MHz 3dBi	\$10	915MHz ISM, RF Antenna 903MHz–928MHz 3dBi	\$10
Gateway	Digi Connectport X2	\$183.75	Dragino DLOS8	\$320.07	Month Service Cost	

stability and quality requirements necessary for this application in an urban area. According to Table 9, LoRaWAN radio links continue to have the highest margins of the two technologies.

Regarding the Zigbee technology, the performance of the radio link in Radio Mobile between node 1 and node 2 marks a small red path, which represents that in this small stretch of communication the relative margin is less than 15 dB, demonstrating the instability of the link in this stretch of data transmission.

Despite obtaining overall better link margin between node 1 and node 2, the behavior of the radio link between node 1 and the gateway of the Zigbee network is more stable, demonstrating that the star topology is the most suitable for data transmission at this point. Most of the communication path between node 1 and the gateway is marked in green, and only a small section is marked in yellow, which represents margins higher than 15dB that entails less risk of packet loss in the transmission of data collected by node 1. Figure 11 illustrates the radio link between node 1 to node 2 and the radio link between node 1 and the gateway of the Zigbee network.

These transmission drawbacks are due to terrain obstructions and the elevation presented in the path between node 1 and node 2 of the network. The transmission between node 1 and the gateway has fewer obstacles and the terrain is more suitable for establishing line of sight. These terrain drawbacks can also affect the line-of-sight behavior of the LoRaWAN network to some extent. Therefore, in this case the rainfall monitoring network is more secure configured in star topology. Figure 12 shows the terrain impairments presented in the path from node 1 to node 2.

4.3. Power consumption

For all monitoring systems, energy consumption is a main concern, if a sensor node stops transmitting, data would be missing and the system would no longer have accurate information. The energy requirements of each component must be carefully considered to optimize the energy consumption of the system (Sadowski and Spachos, 2020) [11]. Parameters such as supply voltage, transmit current, and receive and sleep currents are important for measuring the power consumption of a device. Table 10 presents the power parameters of the sensor nodes transmission modules and Table 11 the power parameters of the gateways.

According to Tables 10 and 11, the LoRaWAN devices have greater energy efficiency due to their low consumption in the data transmission of the sensor nodes, but, Zigbee gateway has lowest energy consumption than LoRaWAN.

4.4. Implementation costs

The sensor nodes of the three WSN have the same number of power units, sensors and microcontroller. Table 12 presents the cost comparison of the equipment used for each of the wireless technologies. The unit price per component is considered.

From Table 9, the LoRaWAN transmission modules for sensor nodes has the lowest cost and for the central station, the Zigbee gateway are cheaper than LoRaWAN and Sigfox devices.

5. Conclusion

In this work, the Sigfox, Zigbee and LoRaWAN wireless communication protocols were evaluated in terms of link profile, power consumption and device costs. This evaluation focuses on determining which technology is the most suitable for a rainfall monitoring network in an urban area. Currently, a GPRS-based network is in operation; it is analyzed to replace it due to its high-energy consumption and high maintenance cost. The Radio Mobile tool was used for the evaluation; a network was designed for each of the selected technologies using the measurement points of the GPRS network.

In terms of communication, Zigbee and LoRaWAN network presents similar received radio signal and the LoRaWAN network obtains the least losses per path. Similarly, the devices with the least energy consumption were those used in the LoRaWAN network. For data transmission in the sensor nodes, the LoRaWAN network modules are the lowest cost in the system. For the central station, the least cost gateway is the one used in the Zigbee network.

Considering each parameter, it can be concluded that LoRaWAN technology is the most suitable for the rainfall monitoring network in the urban area. Likewise, the high sensitivity combined with the integrated power of LoRaWAN devices, produces a link budget leader in evaluation in terms of communication, power consumption and implementation costs.

Declarations

Author contribution statement

Lilia Ortega-Gonzalez, Melisa Acosta-Coll, Gabriel Piñeres-Espitia & Shariq Aziz Butt: Conceived and designed the experiments; Performed the experiments; Analyzed and interpreted the data; Contributed reagents, materials, analysis tools or data; Wrote the paper.

Funding statement

This research did not receive any specific grant from funding agencies in the public, commercial, or not-for-profit sectors.

Data availability statement

Data included in article/supplementary material/referenced in article.

Declaration of interests statement

The authors declare no conflict of interest.

Additional information

No additional information is available for this paper.

References

- Acosta Coll, M., 2013. Sistemas de Alerta Temprana (S.A.T) para la Reducción del Riesgo de Inundaciones Súbitas y Fenómenos Atmosféricos en el Área Metropolitana de Barranquilla. *Sci. Tech.* 18 (2), 303–308.

- Acosta-Coll, M., Ballester-Merelo, F., Martínez-Peiró, M., 2018. Early warning system for detection of urban pluvial flooding hazard levels in an ungauged basin. *Nat. Hazards* 92 (2), 1237–1265.
- Ávila, H., 2012. Perspectiva del manejo del drenaje pluvial frente al cambio climático - caso de estudio: ciudad de Barranquilla, Colombia*. *Revista de Ingeniería* (36), 54–59.
- Avila, L., Ávila, H., Sisa, A., 2017. A reactive early warning model for urban flash flood management. *World environmental and water resources Congress 2017: water, wastewater, and stormwater; urban watershed management; and municipal water infrastructure - selected papers from the world. Environ. Water Res. Congr. 2017 (August)*, 372–382.
- Balmaceda, J., Aubert, J., Arias, M.R., 2018. Performance Analysis of Radio Link Implementation for Low Cost Deployed WiMAX Networks. In: 2017 IEEE 37th Central America and Panama Convention, CONCAPAN 2017, 2018–January, pp. 1–5.
- Bhoyar, P., Sahare, P., Dhok, S.B., Deshmukh, R.B., 2019. Communication technologies and security challenges for internet of things: a comprehensive review. *AEU - Int. J. Electron. Commun.* 99, 81–99.
- Bonilla, I., Arturo, T., Morles, M., 2016. Iot, El Internet De Las Cosas Y La Innovación De Sus Aplicaciones. *VinculadTégica EFAN* (1), pp. 2313–2340. Retrieved from: <http://www.web.facpua.uanl.mx/VinculadTégica/Revistas/R2/2313-2340 - Iot, El Internet De Las Cosas Y La Innovación De Sus Aplicaciones.pdf>.
- Buettrich, S., 2007. Unidad 06 Unidad 06: : Cálculo de Radioenlace Cálculo de Radioenlace Tabla de contenido, pp. 1–22. Retrieved from. http://www.itrainonline.org/itrainonline/mmtk/wireless_es/files/06_es_calculo-de-radioenlace_guia_v02.pdf.
- Caicedo-Ortíz, J.G., 2015. Modelo de despliegue de una WSN para la medición de las variables climáticas que causan fuertes precipitaciones. *Prospect* 13 (1), 106.
- Caicedo-Ortíz, J.G., De-la-Hoz-Franco, E., Ortega, R.M., Piñeres-Espitia, G., Combata-Niño, H., Estévez, F., Cama-Pinto, A., 2018. Monitoring system for agronomic variables based in WSN technology on cassava crops. *Comput. Electron. Agric.* 145, 275–281.
- Cama-Pinto, A., Acosta-Coll, M., Piñeres-Espitia, G., Caicedo-Ortíz, J., Zamora-Musa, R., Sepulveda-Ojeda, J., 2016. Diseño de una red de sensores inalámbricos para la monitorización de inundaciones repentinas en la ciudad de Barranquilla, Colombia. *Ingeniare. Revista Chilena de Ingeniería* 24 (4), 581–599.
- García, F.C.C., Retamar, A.E., Javier, J.C., 2016. A real time urban flood monitoring system for metro Manila. *IEEE Region 10 Annual International Conference. In: Proceedings/TENCON, 2016–January*, pp. 3–7.
- García Garrancho, P., 2006. *Manual de uso de Radio Mobile*, p. 31. Retrieved from: https://upcommons.upc.edu/bitstream/handle/2099.1/6989/anexo/Anexo_16.pdf.
- Kadhim, L.A., Salih, S.M., 2014. Indoor distributed antenna system for the university of baghdad building. *IEEE Trans. Antenn. Propag.* 5 (4), 57–68.
- Kaewwongsri, K., Silanon, K., 2020. June). Design and implement of a weather monitoring station using CoAP on NB-IoT network. In: 2020 17th International Conference on Electrical Engineering/Electronics, Computer, Telecommunications and Information Technology (ECTI-CON). IEEE, pp. 230–233.
- Kama, A., Diallo, M., Drame, M.S., 2018. Low cost connected and autonomous rain gauge for real time rainfall monitoring in Dakar. In: 2018 25th International Conference on Telecommunications, ICT, pp. 660–664, 2018.
- Koucheryavy, A., Salim, A., 2009. Cluster head selection for homogeneous wireless sensor networks. *Inte. Conf. Adv. Commun. Tech. ICACT* 3 (3), 2141–2146.
- Mangundu, E.M., Mateus, J.N., Zodi, G.A.L., Johson, J., 2017. October). A wireless sensor network for rainfall monitoring, using cellular network: a case for Namibia. In: 2017 Global Wireless Summit (GWS). IEEE, pp. 240–244.
- Martínez, R.F., Meré, J.O., de Píson Ascacfbar, F.J.M., Marcos, A.G., Elías, F.A., 2009. *Redes inalámbricas de sensores: teoría y aplicación práctica*. Grupo de Investigación EDMANS-Universidad de la Rioja, España.
- Mendoza, A., González, H., Buelvas, J., Rueda, S.L.M., 2016. *Guía para la Implementación de Sistemas de alerta temprana*.
- Organización Meteorológica Mundial, 1994. *GUÍA DE PRACTICAS HIDROLÓGICAS*.
- Rueda, J.S., Talavera Portocarrero, J.M., 2017. Similitudes y diferencias entre Redes de Sensores Inalámbricas e Internet de las Cosas: hacia una postura clarificadora. *Revista Colombiana de Computación* 18 (2), 58–74.
- Sadowski, S., Spachos, P., 2020. Wireless technologies for smart agricultural monitoring using internet of things devices with energy harvesting capabilities. *Comput. Electron. Agric.* 172 (September 2019), 105338.
- Santos, S.C., Firmino, R.M., Mattos, D.M.F., Medeiros, D.S.V., 2020. An IoT Rainfall Monitoring Application Based on Wireless Communication Technologies, pp. 53–56.
- Seybold, J.S., 2005. Introduction to RF propagation. In: *Introduction to RF Propagation*.
- Talavera, J.M., Tobón, L.E., Gómez, J.A., Culman, M.A., Aranda, J.M., Parra, D.T., Garreta, L.E., 2017. Review of IoT applications in agro-industrial and environmental fields. *Comput. Electron. Agric.* 142 (September), 283–297.
- Trandafir, B., Fratu, O., Halunga, S., 2010. Simulation and analysis of a Wi-Fi public network using the radio mobile software. In: 2010 9th International Symposium on Electronics and Telecommunications, ISETC'10 - Conference Proceedings, pp. 281–284.
- Vitadhani, A., Alief, F., Haryanto, B., Harwahyu, R., Fitri Sari, R., 2020. Simulating LoRaWAN for flood early warning system in ciliwung river, bogor-Jakarta. In: *Proceedings - 2020 International Seminar on Application for Technology of Information and Communication: IT Challenges for Sustainability, Scalability, and Security in the Age of Digital Disruption, ISemantic 2020*, pp. 274–279.
- Zennaro, M., Bagula, A., Gascon, D., Noveleta, A.B., 2010. Long distance wireless sensor networks: simulation vs reality. In: *Proceedings of the 4th ACM Workshop on Networked Systems for Developing*.