



Aalborg Universitet

AALBORG UNIVERSITY
DENMARK

Pulse Tripling Circuit and Twelve Pulse Rectifier Combination for Sinusoidal Input Current

Abdollahi, Rohollah ; Gharehpetian, Gevork B. GHAREHPETIAN; Anvari-Moghaddam, Amjad; Blaabjerg, Frede

Published in:
IEEE Access

DOI (link to publication from Publisher):
DOI: [10.1109/ACCESS.2021.3098620](https://doi.org/10.1109/ACCESS.2021.3098620)

Publication date:
2021

Document Version
Version created as part of publication process; publisher's layout; not normally made publicly available

[Link to publication from Aalborg University](#)

Citation for published version (APA):
Abdollahi, R., Gharehpetian, G. B. GHAREHPETIAN., Anvari-Moghaddam, A., & Blaabjerg, F. (2021). Pulse Tripling Circuit and Twelve Pulse Rectifier Combination for Sinusoidal Input Current. *IEEE Access*, 9, 103588-103599. [9491159]. <https://doi.org/DOI: 10.1109/ACCESS.2021.3098620>

General rights

Copyright and moral rights for the publications made accessible in the public portal are retained by the authors and/or other copyright owners and it is a condition of accessing publications that users recognise and abide by the legal requirements associated with these rights.

- ? Users may download and print one copy of any publication from the public portal for the purpose of private study or research.
- ? You may not further distribute the material or use it for any profit-making activity or commercial gain
- ? You may freely distribute the URL identifying the publication in the public portal ?

Take down policy

If you believe that this document breaches copyright please contact us at vbn@aub.aau.dk providing details, and we will remove access to the work immediately and investigate your claim.

Date of publication xxxx 00, 0000, date of current version xxxx 00, 0000.

Digital Object Identifier 10.1109/ACCESS.2017.Doi Number

Pulse Tripling Circuit and Twelve Pulse Rectifier Combination for Sinusoidal Input Current

Rohollah Abdollahi¹, Gevork B. Gharehpetian², (Senior Member IEEE), Amjad Anvari-Moghaddam³, (Senior Member IEEE), and Frede Blaabjerg³, (Fellow IEEE)

¹Electrical Engineering Department, Technical and Vocational University, Qom, Iran

²Electrical Engineering Department, Amirkabir University of Technology, Tehran, Iran

³Department of Energy Technology, Aalborg University, 9220 Aalborg, Denmark

Corresponding author: Rohollah Abdollahi (e-mail: rohollah.abdollahi@yahoo.com).

ABSTRACT In this paper, a novel pulse tripling circuit (PTC) is suggested, to upgrade a polygon autotransformer 12-pulse rectifier (12-PR) to a 36-pulse rectifier (36-PR) with a low power rating. The kVA rating of the proposed PTC is lower compared to the conventional one (about 1.57% of load power). Simulation and experimental test results show that the total harmonic distortion (THD) of the input current of the suggested 36-PR is less than 3%, which meets the IEEE 519 requirements. Also, it is shown that in comparison with other multi-pulse rectifiers (MPR), it is cost-effective, its power factor is near unity and its rating is about 24% of the load rating. Therefore, the proposed 36-PR can be considered as a practical solution for industrial applications.

INDEX TERMS Sinusoidal Input Current, Multi-pulse rectifier, Harmonics reduction, Pulse increasing circuits

I. INTRODUCTION

In recent years, different structures of multipulse rectifiers have been designed and employed in order to improve the power quality at the common point of connection in industrial applications such as power system, ship propulsion and aircraft electricity system as well as high voltage DC transmission lines. Multipulse rectifiers (MPRs) have widely been used in industry due to their low harmonic distortion, simple configuration, robustness and also power factor correction [1-3]. Although, various structures of 12- and 18-pulse rectifiers have been introduced, developed and utilized to reduce the harmonic content of the line current [4-6]; but still these structures could not satisfy and meet the standards requirements and recommendations [7-10]. For example, the 12-PR input current THD is about 15% without using any output filters, which cannot meet the IEEE standard 519 [7], IEC 61000-3-2 [8], MIL-STD 1399 [9], and also DO-160G [10], which determines the environmental conditions and test procedures of airborne equipment for the entire spectrum of aircraft. In MIL-STD 1399, voltage and current harmonics should be set at 5% and 3% of the fundamental for loads of 1 kVA or more, respectively. In IEEE-519, the emission limits have been designed to limit the maximum individual frequency voltage harmonics to 3% of the fundamental.

For higher-pulse numbers, larger harmonics are permitted, provided that non-characteristic harmonics are less than 25% of the limits specified. In DO-160 G, odd and even order harmonics limitations have been presented for balanced 3-phase

electrical equipment. To overcome this issue, higher pulse numbers systems have been suggested by many researchers [11-14]. But this approach cannot be accepted, if a considerable number of MPRs should be applied to an industrial application, because a great deal of transformers with a high turn ratios have to be used. Therefore, their windings would have large dimensions. Also, they have heavy core and high rating. Thus, a 12-PR is a practical selection considering its lower weight, simple transformer structure, lower power rating, and low losses. However, 12-PR cannot meet requirements of the mentioned standards without using a passive filter. To solve this problem, different 24-PRs have been presented in [15-17] employing auxiliary and control schemes, which result in cost increase and more MPR complexity. Also, their rating is still more than 35% of the load rating.

In [18], a transformer-based 24-PR has been suggested, which uses passive harmonic mitigation. However, the THD of the ac main current is more than 5% in light load conditions. In [19], a 20-PR has been proposed, whose rating is 30.12% of the load rating. Also, several studies have also been carried out using 40-PR and 72-PR [20-22] for harmonic mitigation. The kVA rating of these rectifiers is more than 40% of the load rating. In [23], a 22-phase polygon autotransformer has been employed with a 44-PR. This configuration demands 44 diodes, and many transformers with high turn ratios. Also, in this configuration, the total magnetic part rating is approximately 42%. Therefore, it is proposed that higher pulse numbers with less complexity and kVA must be used to meet the IEEE-519

requirements. In [24], a 48-PR based on single-phase diode bridge rectifier (DBR) and triple-tapped interphase reactor.

To improve the power quality, it is possible to use an inductive filtering based parallel operating transformer with shared filter [25]. In [26], an enhanced circuit for a multi-pulse AC/DC converter has been presented. An alternative to mitigate harmonic current distortion in a 12-PR has been suggested in [27]. Compared to other passive 12-PRs, a tight dc bus and very low harmonic distortion of current has been obtained by means of an active current imposition. The results have shown that the performance of the suggested solution was the same as the performance of 3-phase unity power factor PWM rectifiers using two switches. In [28], the Active Output Filter (AOF) has been discussed. The suggested AOF concept has resulted in a significant decrease in size and weight compared to passive L-C, but considering their relatively low reliability and high complexity in its control system, its application needs reliability improvement. An autotransformer-based 12-PR has been reported in [27] for feeding two isolated single-ended primary-inductor converters. The kVA rating of the mentioned design is 18.5%, which is relatively higher than other autotransformers (the kVA rating of the polygon autotransformer is approximately 18% of the load power). In [29], a transformer-based 24-PR has been suggested, which is based on harmonic injection circuit at the dc-link, but its total magnetic part rating was high. In [30], a 36-PR has been reported with a transformer configuration. The major drawback of transformer-based MPRs is its magnetic parts rating, which may be more than 100% of dc load rating. Different topologies of conventional autotransformer-based 36-PRs have been reported in [31-34], to mitigate harmonics at the PCC.

The conventional 36-PRs require an 18-phase autotransformer, while the proposed 36-PR of this paper is based on a very simple 6-phase autotransformer. Also, the kVA rating of the 36-PRs is more than 40% of the load rating and requires 36 diodes, which increases the cost.

To achieve similar performance in terms of various power-quality indices and increase the number of pulses without increasing the cost and complexity, a PTC is proposed in this paper for current THD reduction. Fig. 1 shows the reduced-rating autotransformer based 36-PR presented in this paper. It has a PTC in the dc-link of the autotransformer-based 12-PR and it is suitable for retrofit applications.

As contributions of this paper, the merits of the novel 36-PR are summarized, as follows:

- The proposed 36-PR uses a PTC, which realizes all technical constraints, and has less rating, weight, volume, and cost in comparison with the other conventional 36-PRs.
- The proposed rectifier benefits the application of a cost-effective autotransformer by utilizing PTC with high technical capacities and lower kVA rating.
- Compared to the other autotransformers, the kVA rating of the polygon autotransformer is approximately 18% of the load power.
- The circulating current is generated by using a PTC. This solution with a lower kVA rating leads to a reduction in the harmonics of the input current and kVA ratings.

- In the suggested 36-PR, the input line current THD is 1.40% and 2.73%, at full and light load conditions, respectively. The current THD is less than 3% and within MIL-STD and IEEE-519 requirements.

II. PROPOSED 36-PULSE RECTIFIER

As shown in Fig. 1, there is a 3-phase voltage source on the ac side and a resistive load at the DC side. The proposed 36-PR consists of two main sections:

- 12-PR based on retrofit polygon autotransformer
- Pulse tripling circuit (PTC)

The structure of the 12-PR is based on polygon autotransformer with reduced magnetic parts rating, which generates two sets of 3-phase voltage with a 30-degree phase shift. These voltages are passed through two 6-pulse diode bridge rectifiers to generate a rectified 12-pulse waveform which is fed to the PTC to generate the rectified 36-pulse waveform. With this polygon autotransformer, the dc-link voltage obtained is slightly higher than that of a six-pulse diode bridge rectifier output voltage. To make the proposed harmonic mitigation suitable for retrofit applications, the autotransformer design has been modified to make the dc-link voltage the same as that of a six-pulse diode bridge rectifier. The application of zero-sequence blocking transformer (ZSBT) is not required, in the case of utilization of an MPR for isolating transformers.

Nevertheless, the ZSBT is used in this paper to ensure the independent operation of the autotransformer output voltages, since the polygon autotransformer has been used. The ZSBT eliminates the voltage difference between two rectifier bridges and suppresses the circulating current to guarantee the independent operation of two 6-pulse diode bridge rectifiers (DBRs).

The PTC includes an Inter-Phase Transformer (IPT), which has an additional secondary winding and four diodes. The primary winding of the IPT ensures the independent operation of the two 3-phase diode bridges, which can absorb the instantaneous difference in the output voltage of the two diode bridges. The secondary winding of this IPT is connected to four diodes, and the dc side is connected to the load.

A. 12-PR Polygon Autotransformer

The conventional 36-PR consists of an 18-phase autotransformer, which generates two 9-phase voltages with a phase shift of 10° . Also, it has two 18-pulse diode-bridge rectifiers. Fig. 2 (a) shows phasor diagram of the 18-phase autotransformer [32] for the conventional 36-PR. As shown in this figure, the structure of the conventional 36-PR autotransformer is complex and has a large number of windings and connections, which lead to volume and weight increase.

In Fig. 2 (b), the phasor diagram of the 6-phase polygon autotransformer for the 12-PR is depicted. To remove the harmonics, 30° is the minimum phase displacement. As mentioned before, the 6-phase polygon autotransformer generates two 3-phase voltages named group 1 and 2, i.e., (V_{a1}, V_{b1}, V_{c1}) and (V_{a2}, V_{b2}, V_{c2}), respectively. These two groups are applied to the first and the second diode bridges, respectively.

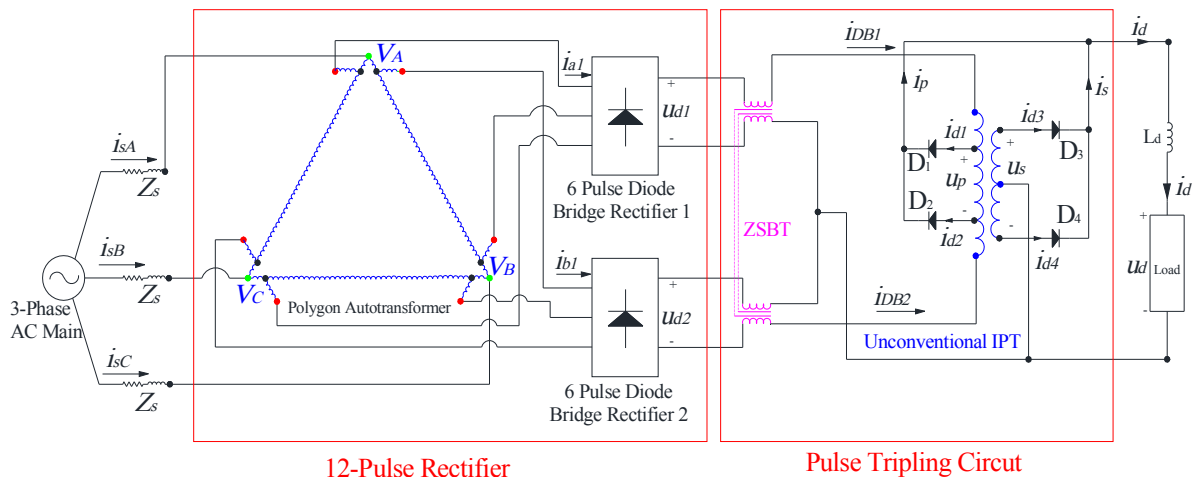

Fig. 1. Proposed polygon autotransformer-based 36-PR with pulse tripling circuit.

The similar voltages in group 1 and group 2 has the phase shift of 30° . The voltages, V_{a1} and V_{a2} , have a phase shift of $+15^\circ$ and -15° from phase A input voltage, respectively. As shown in Fig. 2, the winding voltages are as follows:

$$V_A = V_S \angle 0^\circ, V_B = V_S \angle -120^\circ, V_C = V_S \angle 120^\circ \quad (1)$$

The winding voltages are supposed to be:

$$V_{a1} = V_S \angle 15^\circ, V_{b1} = V_S \angle -105^\circ, V_{c1} = V_S \angle 135^\circ \quad (2)$$

$$V_{a2} = V_S \angle -15^\circ, V_{b2} = V_S \angle -135^\circ, V_{c2} = V_S \angle 105^\circ$$

For V_{a1} and V_{a2} , we have:

$$V_{a1} = V_A + K_1 V_{CA} - K_2 V_{BC} \quad (3)$$

$$V_{a2} = V_A - K_1 V_{AB} + K_2 V_{BC}$$

The output voltage of the conventional 6-pulse rectifier is $1.65 V_m$ and the output voltage of the proposed rectifier is $1.7 V_m$. As a result, the output voltage of the proposed rectifier is 3% higher than the traditional 6-phase rectifier. Therefore, it is necessary to correct the output voltage of the proposed rectifier to 3% through recalculation of the number of winding turns. The values of constants K_1 and K_2 are changed for retrofit applications as:

$$K_1 = 0.0472, K_2 = 0.1201 \quad (4)$$

These values specify the winding turns in proportion to the input ac main voltages, and are different from the winding turns of the polygon autotransformer determined in [5]. The obtained values lead to a reduction of about 6% in the kVA rating of the proposed autotransformer. Based on these values, the 6-phase polygon autotransformer will be simulated and developed.

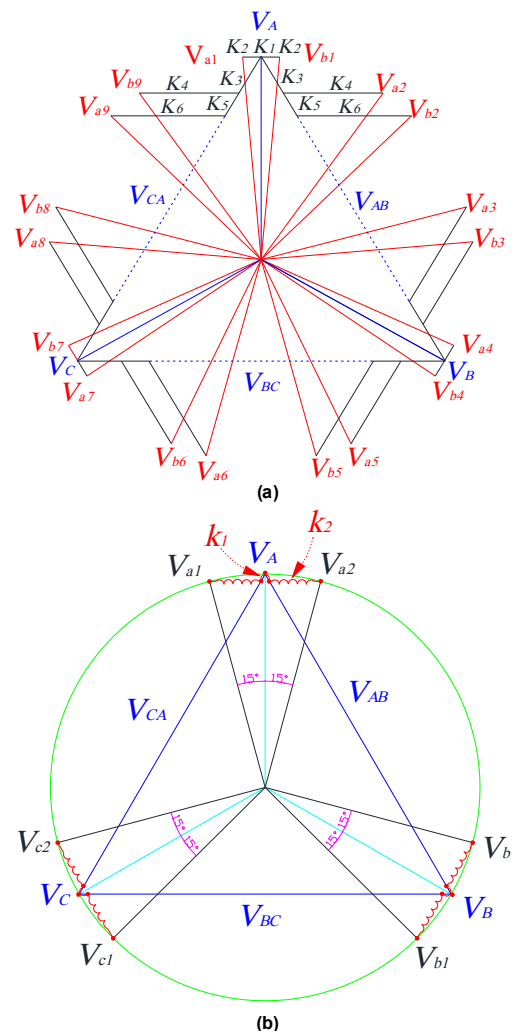

Fig. 2. Phasor diagram of autotransformer for 36-PR, (a) Conventional [32], and (b) Proposed circuit.

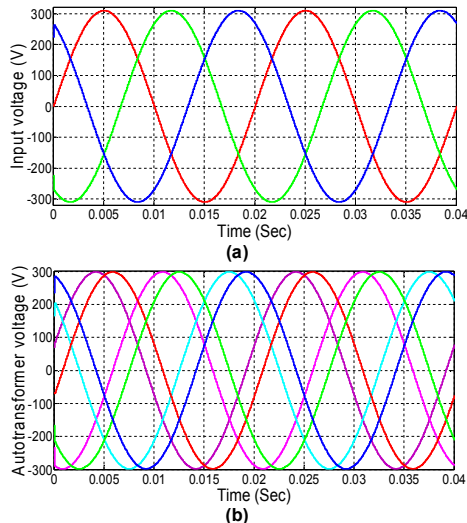

Fig. 3. (a) Input line and (b) output voltage of 6-phase polygon autotransformer.

The input and output voltages of the 6-phase polygon autotransformer are shown in Fig. 3. As mentioned before, the output of the autotransformer is two 3-phase voltages with 30° phase shift, and 3% lower than the input voltage, in order to ensure the proper operation of the proposed 36-PR for retrofit applications.

B. Novel Pulse Tripling Circuit (PTC)

In the novel PTC, the conventional IPR is replaced by an unconventional IPT. The primary winding of the proposed IPT and two diodes form the first passive harmonic reduction method; the secondary winding and two diodes constitute the second harmonic reduction method. Suppose that the output voltage of the two 6-pulse DBRs is u_{d1} and u_{d2} . The voltage in the secondary winding of the used IPT is equal to u_s and the load voltage is equal to u_d . As shown in Fig. 4 and considering the relationship between u_{d1} and u_{d2} and between u_d and u_s , the rectifier of the proposed PTC has four modes of operation.

Mode 1: When $u_{d1} > u_{d2}$ and $|u_s| < u_d$, the PTC operates in Mode 1 which is shown in Fig. 4 (a). In this mode of operation, diodes D_3 and D_4 are turned off and the current will be zero in the secondary winding of the proposed IPT, and in the primary winding of the used IPT, diode D_1 is turned on, and diode D_2 is turned off. The IPT operates as PTC.

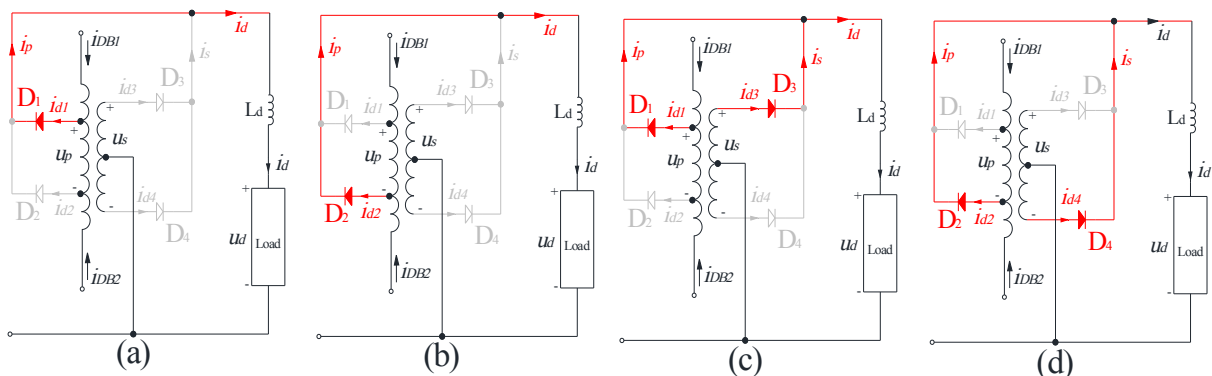

Fig. 4. Novel PTC operation modes, (a) Mode 1, (b) Mode 2, (c) Mode 3, and (d) Mode 4.

Mode 2: When $u_{d1} < u_{d2}$ and $|u_s| < u_d$, the PTC is in Mode 2, as shown in Fig. 4 (b). In this mode, diodes D_3 and D_4 are turned on and the current will be zero, and diode D_1 is turned off, and diode D_2 is turned on. It is obvious that the IPT operates as a PTC.

Mode 3: When $u_{d1} > u_{d2}$ and $u_s > u_d$, the PTC operates under Mode 3, as shown in Fig. 4 (c). In this mode, diode D_3 is turned on, current i_{d3} is positive, and it is injected to the load. Diode D_4 is turned off. Simultaneously, diode D_1 is turned on and diode D_2 is turned off. Again, the IPT acts as a PTC.

Mode 4: When $u_{d1} < u_{d2}$ and $-u_s > u_d$, Mode 4 will be triggered as shown in Fig. 4 (d). In this mode, diode D_4 is turned on, current i_{d4} is positive, and it is injected to the load. Diode D_3 is turned off. Simultaneously, diode D_2 is turned on and diode D_1 is turned off. The used IPT operates as a PTC.

The conduction modes and the corresponding conduction angles of the output voltage of the two 6-pulse DBRs (u_{d1} and u_{d2}) are shown in Fig. 5.

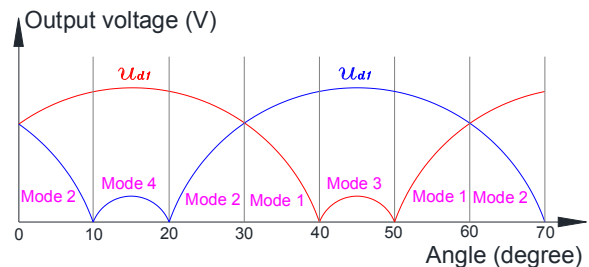

Fig. 5. Conduction modes and corresponding conduction angles of the output voltages.

In Fig. 6, the simulated voltage across the secondary and primary of the proposed PTC is depicted. According to Fig. 6, the primary and secondary voltages of the proposed IPT are equal to the difference and sum of the output voltage of two 3-phase DBRs, respectively. Based on the output voltage of these bridges, the used IPT primary and secondary winding voltages are 932.8 V and 43.41 V, respectively. As a result, the turn ratio of the IPT is 21.48.

The main objective is that the proposed rectifier should operate as a 36-PR and the proposed IPT must operate as a PTC while the THD has to be minimized. As it can be seen in Fig. 6, the proposed PTC voltage frequency is 360 Hz, which is 6 times the supply frequency. The voltage and current frequency of the

PTC is six times of the source frequency, resulting in a smaller transformer kVA rating. Additionally, the kVA rating of the PTC is negligible. This means that $N_p/N_s = 21.48$, also we have $N_{p1}/N_p = 0.33$ and $N_{s1}=N_{s2}$. The ZSBT shown in Fig. 7, is designed and wound on core with E-laminations (13.35 cm × 8.9 cm) and I-laminations (13.35 cm × 2.25 cm). The number of turns is calculated as $N_{z1} = N_{z2} = N_{z3} = N_{z4} = 31$.

Based on the current flowing through different windings, the gauge of wire used in all the windings is taken as 18. Since the magnetic flux in the core of an interphase reactor is alternating at six times the supply frequency, it results in higher core losses. Furthermore, there is always a certain dc unbalance that may saturate the core, so the flux density used is less than in a normal transformer. In this paper, the flux density is taken as 0.8 T, and the current density is considered as 2.3 A/mm².

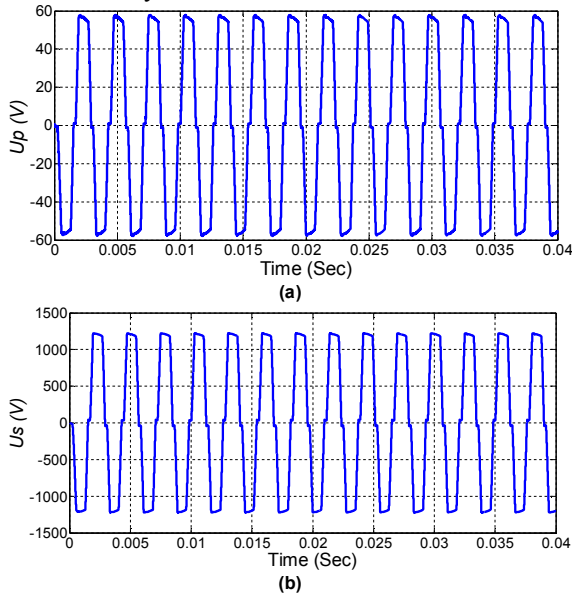

Fig. 6. Voltage across the proposed PTC, (a) primary winding and (b) secondary winding.

The Unconventional IPT is wound using core with E and I laminations (13.35 cm × 8.9 cm and 13.35 cm × 2.25 cm, respectively). Based on the voltage across different windings, the number of turns is calculated, and based on the current flowing through different windings, the gauge of the wire is determined. The number of turns and gauge of wire used to realize the Unconventional IPT are N_{p1} (10, 20), N_{p2} (10, 20), N_{p3} (10, 20), N_{s1} (331, 16), N_{s2} (331, 16).

Noted that to minimize the current THD, it has been demonstrated in [35] and [38] that the secondary to primary turn ratio must be 10.74 and 5.06, respectively, but in the proposed IPT, this turn ratio is 21.48, which is in a good agreement with the results presented in Fig. 6. However, the rating of the multi-tapped IPT used in [35], is 2.68% and that of the suggested IPT used in the proposed PTC is 1.57%. Also, the rating of this 36-PR based on star autotransformer [35] and star transformer [38] was approximately 48% and more than 100% of the load power, respectively. But, the proposed 36-PR, which is based on polygon autotransformer of this paper, has the rating of 24.16% of the load rating, which is 10.78% less than the one given in [35]. This means that it can be used for retrofit applications, which is not possible for the one presented in [35]. It must be

mentioned that in [39], a 36-PR has been proposed, which is based on 12-pulse diode rectifier with two auxiliary single-phase full wave rectifiers (ASFRs). In the structure of this 36-PR, a transformer has been used, whose rating is more than 100%. This 36-PR is suitable for isolated applications, but for non-isolated cases, it is unjustifiable. Also, its THD is more than 3%, and it cannot be used for retrofit applications. In [40], a 36-pulse rectifier has been presented, which is based on zig-zag autotransformer and a PTC with winding turn ratio of 10.74. Its THD is 2.19% and its kVA rating is 30.51%. In our case, the THD of the proposed structure is 1.4% and the kVA rating is 24.16%. Therefore, it is obvious that the structure proposed in this paper is better than the solution presented in [40], as well.

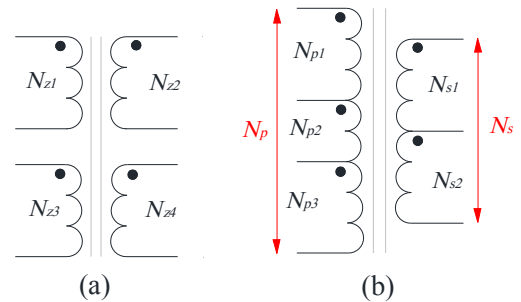
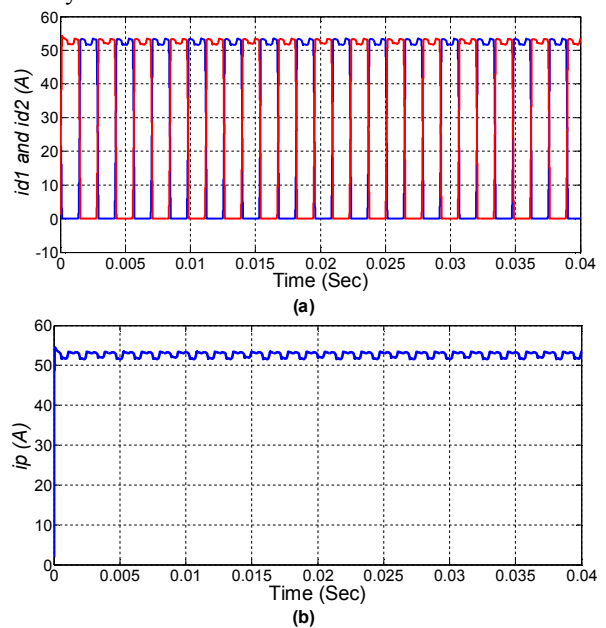

Fig. 7. Winding configuration of (a) ZSBT and (b) Unconventional IPT

In Fig. 8, the current of the proposed PTC at 50hp/460V is depicted, which approves the performance of the proposed PTC for a 36-PR. The IPT used in the current design has an additional secondary winding. This secondary winding increases the voltage, which in turn leads to reduction in current of the PTC diodes and the secondary of the IPT. Therefore, the conduction losses are low, which is a good solution for high current loads. It can be seen in Fig. 9 that independent operation of two 3-phase DBRs is enabled using the ZSBT. The output voltage, with a 30° phase shift for these DBRs, is presented in Fig. 9. Since the polygon autotransformer is not isolated, it is necessary to utilize the ZSBT.



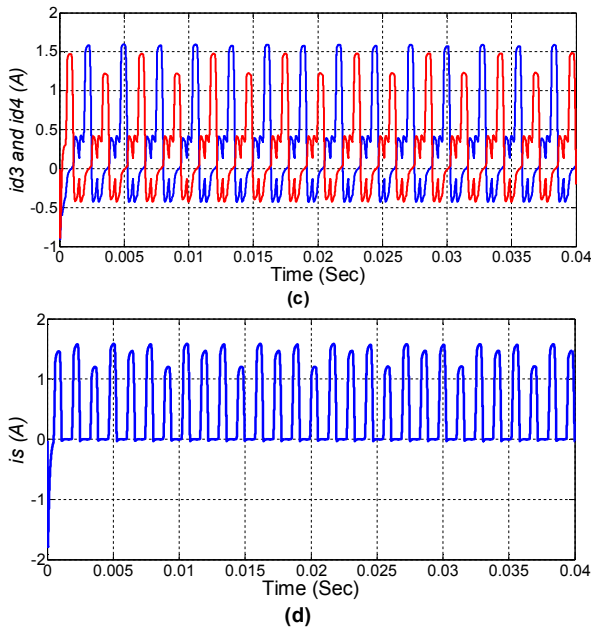

Fig. 8. (a) Current of PTC, (a) i_{d1} and i_{d2} , (b) i_p , (c) i_{d3} and i_{d4} , and (d) i_s .

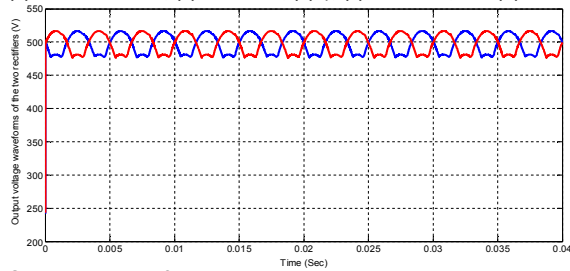

Fig. 9. Output voltages of two 3-phase DBRs.

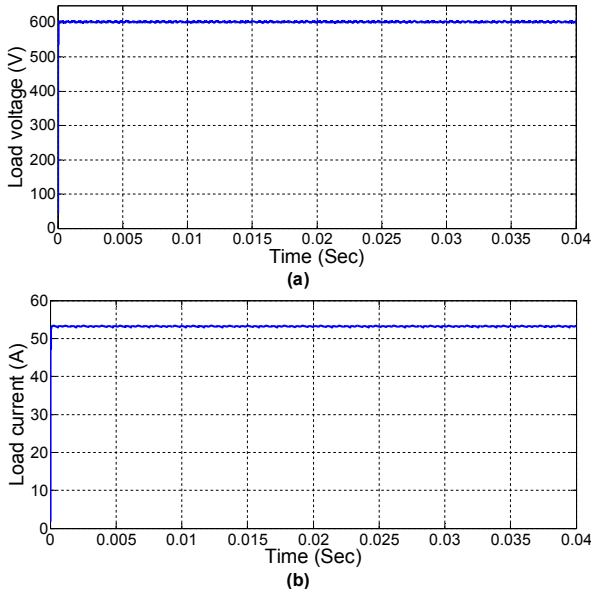

Fig. 10. Load (a) voltage and (b) current in the proposed 36-PR.

As shown in Fig. 9, the two 6-pulse rectifier bridges are independently operating with the support of the ZSBT circuit. In Fig. 10, the output voltage and current of the proposed 36-PR are presented.

Fig. 11 presents the simulation results of the input line voltage and currents at 50hp/460V under full load condition. It can be seen clearly that the input line voltage and currents have

nearly sinusoidal waveforms. In general, partial asymmetric operation of multi-pulse rectifiers results in network 3-phase voltage asymmetry, which in turn causes a minor DC component injection. In the proposed structure, to have an independent operation for two 3-phase DBRs, a ZSBT has been used; however, a light asymmetry can be seen. The voltage and current THD are 1.03% and 1.40%, respectively, which are well below the thresholds defined in standards. According to Fig. 12, the currents of the input line at 10kVA/380V are depicted under 20% and 100% of the full load power, respectively. Under 20% and 100% of the full load power, the THD of the input line current is approximately 2.90% and 1.72%, respectively.

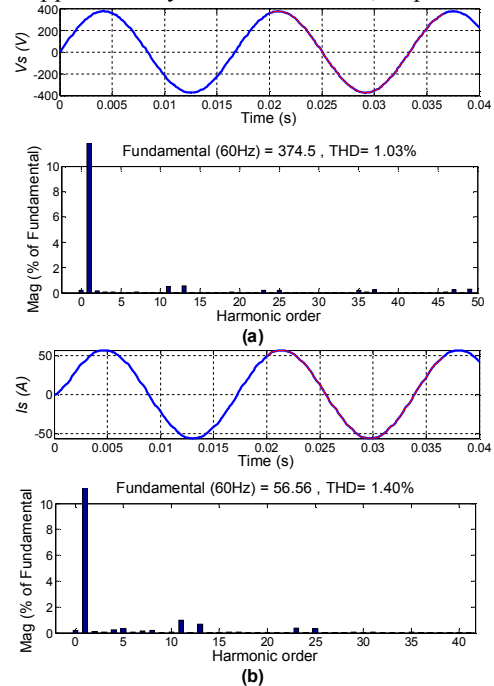

Fig. 11. Simulation results of input (a) voltage and (b) current waveform of the proposed 36-PR and their harmonics spectrum at 50hp and 460 V.

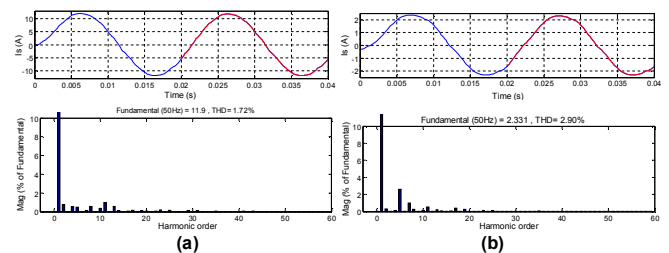

Fig. 12. Simulation results of input current waveform of the proposed 36-PR and their harmonics spectrum at 10kVA and 380 V (a) 20% and (b) 100% full load conditions.

Table 1 summarizes a comparison among the proposed 36-PR, the conventional 36-PRs [32-34] and the 6-PR for different values of power quality. As listed in this table, the 6-PR cannot satisfy the IEEE 519 and MIL-STD requirements. In the proposed 36-PR, the input current THD under full load and light load is 1.40% and 2.72% and its power factor is 0.99 and 0.99, respectively. Also, the input voltage THD is about 1.03%. In other words, the proposed 36-PR satisfies the requirements of the MIL-STD 1399 and IEEE-519. As it can be seen in Table 1, the proposed 36-PR reduces the THD of the input current/voltage more than the other 36-PRs.

Table 1. COMPARISON OF SIMULATED POWER QUALITY PARAMETERS USING DIFFERENT MPRs at 50hp/460V.

Topology	% THD of V_{ac}	Fundamental Input Current I_s (A)		% THD of I_s , at		Distortion Factor		Displacement Factor		Power Factor	
		Light Load	Full Load	Light Load	Full Load	Light Load	Full Load	Full Load	Full Load	Light Load	Full Load
6-pulse	5.64	10.33	52.69	52.53	28.53	0.88	0.87	0.94	0.95	0.98	0.98
36-Pulse [32]	2.16	10.47	52.43	3.65	2.20	0.99	0.99	0.99	0.99	0.99	0.99
36-Pulse [33]	2.46	10.49	52.21	3.91	2.85	0.99	0.99	0.99	0.99	0.99	0.99
36-Pulse [34]	2.16	10.57	52.45	3.64	2.21	0.99	0.99	0.99	0.99	0.99	0.99
Proposed 36-pulse with PTC	1.03	10.86	56.56	2.72	1.40	0.99	0.99	0.99	0.99	0.99	0.99

In order to reduce kVA rating and input current THD, in this paper, the PTC has been used for the proposed 36-pulse rectifier. Therefore, the PTC in the proposed 36-pulse rectifier needs more current, but as can be seen in Table 1, the difference, in comparison with the exiting 36-pulse rectifiers, is in the rage of 0.3 A and neglectable.

III. EXPERIMENTAL RESULTS

In Fig. 13 (a), a laboratory-scale prototype of the proposed 36-PR is presented. The input phase voltage is 380 V_{rms} (AC input line-to-line) and 50 Hz, and the load power is 10 kVA. According to Fig. 13 (b), the input voltage and current THD of the proposed configuration are 1.2%, and 1.72%, respectively. In Fig. 13 (c) and Fig. 13 (d), the currents of the input line are depicted under 20% and 50% of the full load power, respectively. Under 20% and 50% of the full load power, the THD of the input line current is approximately 2.90% and 2.27%, respectively.

Also, in Fig. 13 (e) and Fig. 13 (f), the harmonics spectrum of the input voltage and current are depicted under 20%, 50% and 100% full load conditions. It should be mentioned that the THD under light load is still below 3%. These experimental results verify that the harmonics are considerably reduced and the THD of the proposed 36-PR is less than 3%, which meets the MIL-STD 1399 and IEEE-519 requirements.

The operating frequencies of more electric aircraft applications are 400 Hz or 800 Hz. The line current and the current spectrum at these frequencies are like shown in Figs. 14 and 15. It can be seen that in the frequency range of 380 Hz till 800 Hz, the current THD is less than 3%, which assures DO-160G limits; Therefore, the proposed 36-PR can be used in aircrafts applications. The experimental results of harmonics spectrum of the input current spectrum at 50Hz including odd and even harmonics, are shown in Fig. 16, which are in good agreement with the standard DO-160 G. To reduce harmonics in more electric aircrafts, a T-connected autotransformer-based 20-PR has been reported in [36], but the THD of ac mains current was not acceptable considering the DO-160G requirements and the application of filters was mandatory. Also, its rating was more than 44% of the load rating, and therefore, compared to the proposed 36-PR, more cost-intensive. In [37], an autotransformer-based 18-PR has been presented for harmonic reduction of the same application. The input line current THD was 6.74% under full load and its rating was 34% of load rating. Also, the current THD was 4.47% and 4.06% at 400 Hz and 800 Hz, respectively.

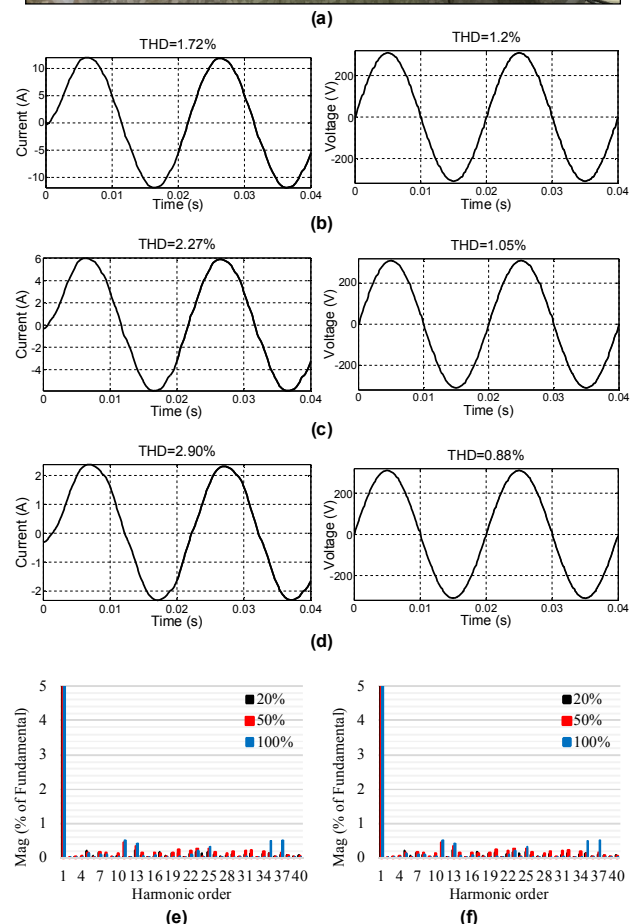
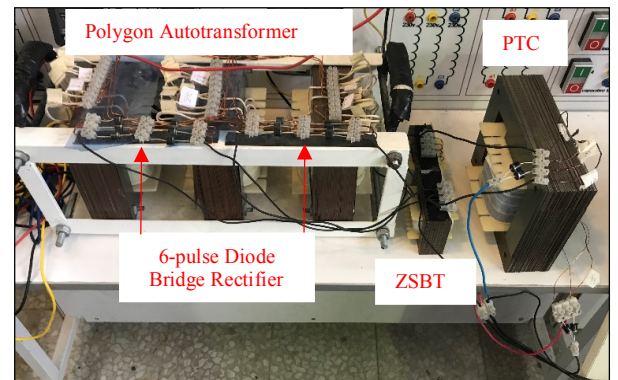

Fig. 13. Test results. (a) Prototype of proposed 36-PR, test results of input line current and voltage with its spectrum at 10kVA/380V under, (b) 100%, (c) 50%, (d) 20% of full load rating, (e) harmonics spectrum of the input voltage at 20%, 50% and 100% full load conditions, and (f) harmonics spectrum of the input current at 20%, 50% and 100% full load conditions.

In comparison, it must be said that the input line current THD is less than 3%, and also for input voltage of 115 V at 400 Hz, the kVA rating of autotransformer can be determined as 21.27 kVA. Thus, the magnetic rating of the autotransformer is approximately 21.72% of the rated load power.

IV. APPARENT POWER RATINGS

For the suggested 36-PR, the 6-phase polygon autotransformer, ZSBT, and proposed PTC ratings are determined using the following equation [2]:

$$S = 0.5 \sum V_{winding} I_{winding} \quad (5)$$

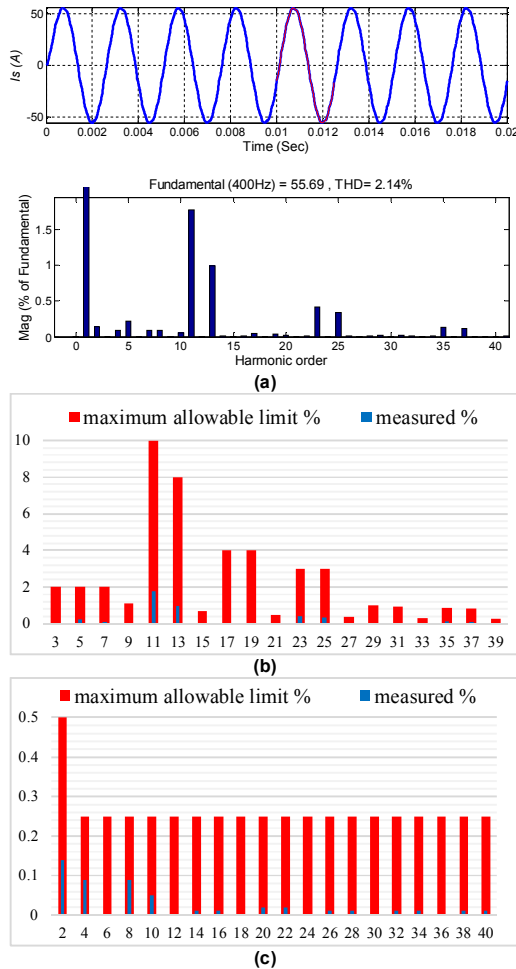

Fig.14. (a) Simulated input line current and its spectrum at 400Hz, (b) Odd current harmonics, (c) Even current harmonics.

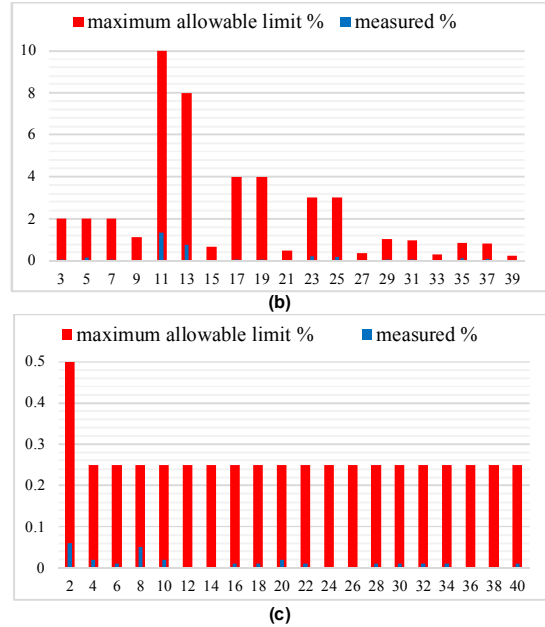
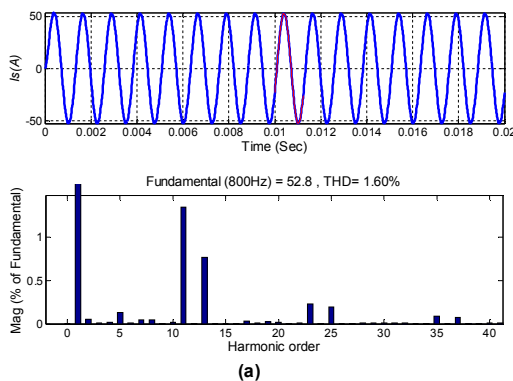

Fig.15. Simulated line current and its spectrum at 800Hz, (b) Odd current harmonics, (c) Even current harmonics.

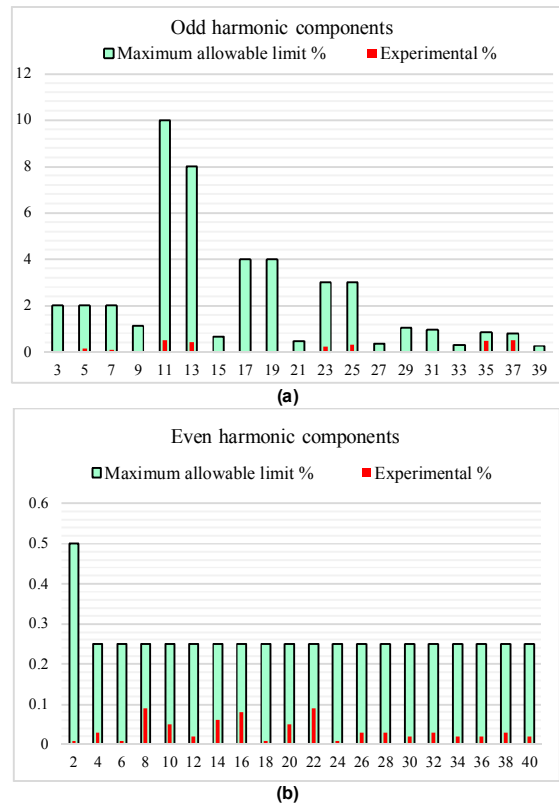

Fig.16. Experimental results of harmonics spectrum of the input current spectrum at 50Hz, (a) Odd current harmonics, (b) Even current harmonics.

where, $I_{winding}$ is the winding full load current and $V_{winding}$ presents the winding rms voltage. In the Table 2 given parameters are calculated using the simulation results of the 10 kVA load. It can be seen that the 6-phase polygon autotransformer, ZSBT and proposed PTC ratings are 18.04 kVA, 0.455 kVA, and 0.157 kVA, respectively. As a result, magnetic parts rating of the suggested 36-PR is 24.16% of the

Table 2. RMS values of voltage and current for windings of different transformers and their VA rating for 10kVA/380V load

Transformer	RMS values	W ₁	W ₂	W ₃	W ₄	W ₅	VA rating
T _{AB}	V _{rms} (V)	17.92	17.92	45.59	45.59	379.6	660.43
	I _{rms} (A)	6.04	6.10	6.06	6.10	1.13	
T _{BC}	V _{rms} (V)	17.92	17.92	45.58	45.58	379.6	601.45
	I _{rms} (A)	6.06	6.20	6.06	6.10	1.13	
T _{CA}	V _{rms} (V)	17.92	17.92	45.6	45.6	379.6	602.49
	I _{rms} (A)	6.06	6.10	6.04	6.20	1.13	
ZSBT	V _{rms} (V)	30.87	30.87	30.87	30.87		455.02
	I _{rms} (A)	7.37	7.37	7.37	7.37		
PTC	V _{rms} (V)	10.37	10.11	10.37	331.5	331.5	157.07
	I _{rms} (A)	7.37	4.15	7.37	0.18	0.18	

load power. The main advantage of the proposed PTC is that the kVA rating of the used IPT is slightly less than the conventional IPT, which is employed in the PDC. In the proposed PTC, the rating of the proposed IPT is about 1.57%, while in the PDC, this value is about 7.5% of the load power. In other words, the proposed PTC with a lower kVA rating leads to more harmonic reduction compared to the conventional PDC.

The rating and current THD of the suggested 36-PR are compared in Fig. 17 with rating and current THD of other 36-PRs. It is obvious that the suggested 36-pulse topology rating is 24.16% and its current THD is less than 3%. The THD of the supply current in these conventional 36-PRs is more than 3% when operating under heavy load conditions, which does not satisfy the MIL-STD requirements. With respect to the MIL-STD, it is necessary to employ the proposed 36-PR. In this figure, it can be observed that the proposed rectifier rating is 19.06%, 37.54%, 37.74% and 19.76% less than that of [31], [32], [33] and [34] 36-PRs, respectively. It must be said that the total cost and size can be specified by the transformer magnetic rating. Also, the proposed rectifier needs 16 diodes, while the conventional 36-PRs [30-34] need 36 diodes, which make them noneconomic. Therefore, the suggested rectifier has a lower rating, weight, volume, and costs. In other words, the suggested 36-PR provides a techno-economic solution for industrial applications. Also, the efficiency of the proposed 36-PR is 97.7% under full load.

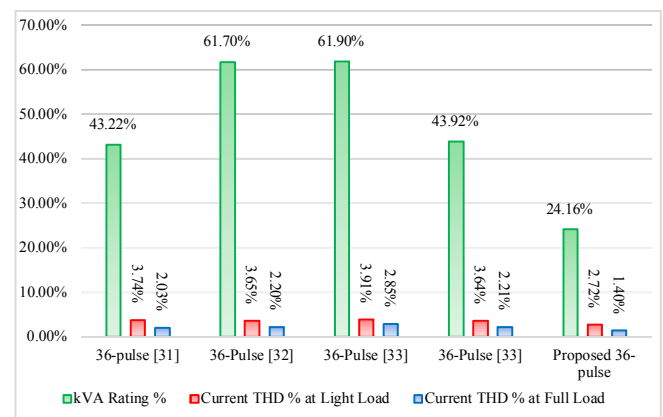

Fig. 17. Comparative evaluation of kVA and THD of proposed 36-PR with conventional 36-PRs.

The proposed 36-pulse configuration has been compared with 20-pulse rectifier [11, 14, 19, and 36], 24-pulse rectifier [15], 36-pulse rectifier [33, and 34], 40-pulse rectifier [12, 13, and 20], 44-pulse rectifier [23], and 72-pulse rectifier [21, and 22] in Table 3 in terms of THD, efficiency, number of diodes, magnetic rating, and cost. Following the procedure mentioned in [21 and 22], the cost can be estimated at 4.5 times of kVA rating of a transformer. It should be emphasized that the total cost and size of the system are determined by the transformer magnetic rating.

According to Table 3, one can easily conclude that there is a direct relationship between the number of pulses and the number of components, the kVA rating and finally the cost.

Table 3. COST AND SIZE COMPARISON OF THE PROPOSED 36-PULSE RECTIFIER WITH THE EXISTING MPRs

Part	Unit cost (\$)	20- Pulse [11]	20- Pulse [14]	20- pulse [19]	20- Pulse [36]	24- pulse [15]	36- pulse [33]	36- pulse [34]	40- pulse [12]	40- pulse [13]	40- pulse [20]	44- pulse [23]	72- pulse [21]	72- pulse [22]	Proposed structure
% of THD		3.04	3.70	3.70	3.71	1.06	2.82	2.21	2.55	2.65	2.22	1.55	1.68	2.19	1.40
% of Efficiency		97.65	94.43	97.73	97.75	98.20	97.35	97.24	97.54	97.50	97.48	96.48	97.53	97.40	97.95
Total kVA rating of the autotransformer (% of load rating)	4.5 times the kVA	40.27	45.47	30.12	44.48	35.30	43.55	44.15	63.98	48.45	57.26	42	44.33	43.61	24.16
Diode	2.25	20	20	20	20	12	36	36	42	42	42	44	38	38	16
MOSFET	3.2	-	-	-	-	4	-	-	-	-	-	-	-	-	-
Approximate total cost (\$)		226.2	249.6	180.5	245.2	198.6	276.9	279.6	382.4	312.5	352.2	288	285	281.7	144.7

As an example, the cost of the 24-pulse rectifier proposed in [15] is about 198.6 \$ and the cost of a conventional 36-pulse rectifier is 280 \$, while the total cost of the proposed system is about 145 \$, which is lower than the existing rectifiers. Considering this table, it can be said that the proposed 36-pulse rectifier is able to provide effective performance similar to a higher pulse system and has lower components, less complexity in term of design and finally provides an economical solution for industrial applications.

V. CONCLUSION

In this paper, a cost-effective 36-PR was proposed, based on a 6-phase polygon autotransformer and a PTC. The suggested PTC with a lower kVA rating compared to the conventional PDC resulted in further harmonic reduction. In comparison with conventional 36-PRs, the THD of the input line current was remarkably decreased to less than 3%, which satisfies the IEEE-519, MIL-STD, and DO-160G requirements and is suitable for more electric aircrafts. Also, in comparison with conventional 36-PRs, it was shown that the rating of the proposed 36-PR could reach 24.16% of the load power, which is a clear advantage for several industrial applications.

REFERENCES

- [1] B. Singh, S. Gairola, B. N. Singh, A. Chandra, and K. Al-Haddad, "Multi-pulse AC-DC converters for improving power quality: a review," *IEEE Trans. Power Electron.*, vol. 23, no. 1, pp. 260-281, Jan. 2008.
- [2] D. A. Paice, *Power Electronic Converter Harmonics: Multipulse Methods for Clean Power*. New York: IEEE Press, 1996.
- [3] Y. Zhang, X. Zhang, Z. Chen, B. Li, and Y. He, "Engineering Application Research of Aircraft Power Supply Characteristics Based on 18-Pulse Rectifier Power System," *IEEE Access*, vol. 7, pp. 22026-22034, 2019.
- [4] B. Singh, G. Bhuvaneshwari, and V. Garg, "Harmonic Mitigation Using 12-Pulse AC-DC Converter in Vector-Controlled Induction Motor Drives," *IEEE Trans. Power Electron.*, vol. 21, no. 3, pp. 1483-1492, July 2006.
- [5] Y. Zhang, J. Xia, X. Zhang, Zh. Chen; B. Li; Q. Luo; Y. He, "Modeling and Prediction of the Reliability Analysis of an 18-Pulse Rectifier Power Supply for Aircraft Based Applications," *IEEE Access*, vol. 8, pp. 47063-47071, 2020.
- [6] D. Yuan; Sh. Wang; Y. Liu, "Dynamic Phasor Modeling of Various Multipulse Rectifiers and a VSI Fed by 18-Pulse Asymmetrical Autotransformer Rectifier Unit for Fast Transient Analysis," *IEEE Access*, vol. 8, pp. 43145 - 43155, 2020.
- [7] *IEEE Standard 519-1992, IEEE Recommended Practices and Requirements for Harmonic Control in Electrical Power Systems*. New York: IEEE Inc., 1992.
- [8] *IEC Standard 61000-3-2:2004, Limits for harmonic current emissions*, International Electromechanical Commission. Geneva, 2004.
- [9] "Aircraft Electric Power Characteristics, Military Standard MIL-STD-704F", Department of Defense Std., Ma. 2004.
- [10] RTCA Inc., "Environmental Conditions and Test Procedures for Airborne Equipment - RTCA DO-160", RTCA Inc. Std. [Online]. Available: <http://www.rtca.org>.
- [11] S. P. P, R. Kalpana, B. Singh, and G. Bhuvaneshwari, "A 20-Pulse Asymmetric Multi-Phase Staggering Autoconfigured Transformer for Power Quality Improvement," *IEEE Trans. on Power Electron.*, vol. 33, no. 2, pp. 917-925, Feb. 2018.
- [12] R. Abdollahi and G. B. Gharehpetian, "Inclusive Design and Implementation of Novel 40-Pulse AC-DC converter for retrofit application and harmonic mitigation," *IEEE Trans. Ind. Electron.*, vol. 63, no. 2, pp. 667-677, Feb. 2016.
- [13] R. Abdollahi, "a Simple Harmonic Reduction Method in 20-Pulse AC-DC Converter," *Journal of Circuits, Systems, and Computers*, vol. 28, no. 01, pp. 19500132018. DOI: 10.1142/S0218126619500130, 2019.
- [14] R. Kalpana, G. Bhuvaneshwari, B. Singh, S. Singh, and S. Gairola, "Autocconnected-transformer-based 20-pulse ac-dc converter for telecommunication power supply," *IEEE Trans. Ind. Electron.*, vol. 60, no. 10, pp. 4178-4190, Oct. 2013.
- [15] F. Meng, W. Yang, Sh. Yang, and L. Gao, "Active harmonic reduction for 12-pulse diode bridge rectifier at dc side with two-stage auxiliary circuit," *IEEE Trans. Ind. Inform.*, vol. 11, no 1, pp. 64-73, Feb. 2015.
- [16] F. Meng, W. Yang, Y. Zhu, L. Gao, and Sh. Yang, "Load adaptability of active harmonic reduction for 12-pulse diode bridge rectifier with active interphase reactor," *IEEE Trans. Power Electron.*, vol. 30, no. 12, pp. 7170-7179, Dec. 2015.
- [17] R. Izadinia and H. R. Karshenas, "Current Shaping in a Hybrid 12-Pulse Rectifier Using a Vienna Rectifier," *IEEE Trans. on Power Electron.*, vol. 33, no. 2, pp. 1135-1142, Feb. 2018.
- [18] S. Yang, J. Wang, and W. Yang, "A Novel 24-Pulse Diode Rectifier with an Auxiliary Single-Phase Full-Wave Rectifier at DC Side," *IEEE Trans. on Power Electron.*, vol. 32, no. 3, pp. 1885-1893, March 2017.
- [19] S. Prakash P, R. Kalpana, and B. Singh, "Inclusive Design and Development of Front-End Multi-Phase Rectifier with Reduced Magnetic Rating and Improved Efficiency," *IEEE Journal of Emerging and Selected Topics in Power Electronics*, vol. 8, no 3, pp. 2989-3000, Sep. 2020.
- [20] B. Singh and S. Gairola, "A 40-pulse ac-dc converter fed vector-controlled induction motor drive," *IEEE Trans. Energy Convers.*, vol. 23, no. 2, pp. 403-411, June 2008.
- [21] R. Abdollahi, G. B. Gharehpetian, and M. S. Mahdavi, "Cost-effective multi-pulse AC-DC converter with lower than 3% current THD," *International Journal of Circuit Theory and Applications*, vol. 47, no. 7, pp. 1105-1120, 2019.
- [22] R. Abdollahi, "Power quality enhancement of a T-connected autotransformer based on 72-pulse AC-DC converter with rated power reduction," *Electrical Engineering*, vol. 102, pp. 1253-1264, 2020.
- [23] R. Abdollahi, "Multi-Phase Shifting Autotransformer Based Rectifier," *IEEE Open Journal of the Industrial Electronics Society*, vol. 1, pp. 38-45, 2020. doi: 10.1109/OJIES.2020.2984715, 2020.
- [24] Y. Lian; Sh. Yang; W. Yang, "Optimum Design of 48-Pulse Rectifier Using Unconventional Interphase Reactor," *IEEE Access*, vol. 8, pp. 61240-61250, 2020.
- [25] Q. Liu, and Y. Li, "An Inductive Filtering-Based Parallel Operating Transformer with Shared Filter for Power Quality Improvement of Wind Farm", *IEEE Trans. Ind. Electron.*, vol. 35, no. 9, PP. 9281-9290, Sept. 2020.
- [26] Sh. Khan, X. Zhang, H. Ali, H. Zaman; M. Saad; B. M. Khan; J. Karamat, "A Novel 24-Pulse Rectification System," *IEEE Access*, vol. 6, pp. 59350-59361, 2018.
- [27] A. de O. C. Neto, A. L. Soares, G. B. de Lima, D. B. Rodrigues, E. A. A. Coelho, and L. C. G. Freitas, "Optimized 12-Pulse Rectifier with Generalized Delta Connection Autotransformer And Isolated Sepic Converters For Sinusoidal Input Line Current Imposition," *IEEE Trans. on Power Electron.*, vol. 34, no. 4, pp. 3204-3213, April 2019.
- [28] F. M. Alhuwaisheh, A. S. Morsy and P. N. Enjeti, "A New Active Output Filter (AOF) for Variable Speed Constant Frequency (VSCF) Power System in Aerospace Applications," *IEEE Trans. on Power Electron.*, vol. 33, no. 2, pp. 1087-1093, Feb. 2018.
- [29] F. Meng, Q. Du, L. Wang, L. Gao, and Zh. Man, "A Series-Connected 24-Pulse Rectifier Using Passive Voltage Harmonic Injection Method at DC Link," *IEEE Trans. on Power Electron.*, vol. 34, no. 9, pp. 8503-8512, Sept. 2019.
- [30] R. Abdollahi, "A novel isolated 36-pulse AC-DC converter for line current harmonic mitigation," *Journal of Applied Research and Technology*, vol. 16, no. 4, pp. 241-254, 2018.
- [31] B. Singh and S. Gairola, "Design and Development of a 36-Pulse AC-DC Converter for Vector Controlled Induction Motor Drive," in *Proc. IEEE Conf. Power Electron. Drives Syst. PEDS'07*, pp. 694-701, 2007.
- [32] R. Abdollahi, "A tapped delta autotransformer based 36-Pulse AC-DC Converter for Power Quality Improvement," *International Journal of Electrical and Electronics Engineering Research*, vol. 2, no. 1, pp. 31-53, 2012.
- [33] R. Abdollahi, "T-Connected Autotransformer Based 36-Pulse AC-DC Converter for Power Quality Improvement," *PRZEGLĄD ELEKTROTECHNICZNY (Electrical Review)*, vol. 88, no. 2, 2012.
- [34] R. Abdollahi, "Design and construction of a polygon-connected autotransformer-based 36-pulse AC-DC converter for power quality improvement in retrofit applications," *Bulletin of the Polish Academy of Sciences: Technical Sciences*, vol. 63, no. 2, 2015.
- [35] L. Gao, X. Xu, Zh. Man, J. Lee, "A 36-Pulse Diode-Bridge Rectifier Using Dual Passive Harmonic Reduction Methods at DC Link", *IEEE Trans. Power Electron.*, vol. 34, no. 2, pp. 1216-1226, Feb. 2019.

- [36] R. Abdollahi, and G. B. Gharehpetian, "A 20-pulse Autotransformer Rectifier Unit for More Electric Aircrafts", *IEEE Journal of Emerging and Selected Topics in Power Electronics*, DOI: 10.1109/JESTPE.2020.2990670, 2020.
- [37] J. Chen, J. Shen, J. Chen, P. Shen, Q. Song, and Ch. Gong, "Investigation on the Selection and Design of Step-Up/Down 18-Pulse ATRUs for More Electric Aircrafts," *IEEE Trans. Transport. Electrific.*, vol. 5, no. 3, pp. 95-811, 2019.
- [38] F. Meng, X. Xu, L. Gao, Z. Man and X. Cai, "Dual Passive Harmonic Reduction at DC Link of the Double-Star Uncontrolled Rectifier," *IEEE Trans. Ind. Electron.*, vol. 66, no. 4, pp. 3303-3309, April 2019.
- [39] J. Wang, X. Yao, X. Gao, and Sh. Yang, "Harmonic Reduction for 12-Pulse Rectifier Using Two Auxiliary Single-phase Full-wave Rectifiers", *IEEE Trans. Power Electron.*, (Early Access).
- [40] S. P. P, R. Kalpana, K. S. Chethana and B. Singh, "A 36-Pulse AC-DC Converter With DC-Side Tapped Interphase Bridge Rectifier for Power Quality Improvement," *IEEE Transactions on Industry Applications*, vol. 57, no. 1, pp. 549-558, Jan.-Feb. 2021.



drives, power quality, and power systems.

ROHOLLAH ABDOLLAHI received the M.Sc. degree in electrical engineering (power electronics and electrical machines) from Iran University of Science and Technology, Tehran, Iran, in 2011. He is faculty member of the Department of Electrical Engineering, Technical and Vocational University, Qom, Iran. He is the author of more than 80 journal and conference papers. He has been granted 2 US patents and 13 Iran patents. His fields of interest include power electronics, electrical machines and



holding the Assistant Professor position at AUT from 1997 to 2003, the position of Associate Professor from 2004 to 2007 and has been Professor since 2007. He was selected by the MSRT (Ministry of Science Research and Technology) as the distinguished professor of Iran, by IAEEE (Iranian Association of Electrical and Electronics Engineers) as the distinguished researcher of Iran, by Iran Energy Association (IEA) as the best researcher of Iran in the field of energy, by the MSRT as the distinguished researcher of Iran, by the Academy of Science of the Islamic Republic of Iran as the distinguished professor of electrical engineering, by National Elites Foundation as the laureates of Alameh Tabatabaei Award and was awarded the National Prize in 2008, 2010, 2018, 2018, 2019 and 2019, respectively. Based on the Web of Science database (2005-2019), he is among world's top 1% elite scientists according to ESI (Essential Science Indicators) ranking system. Prof. Gharehpetian is distinguished, senior and distinguished member of CIGRE, IEEE and IAEEE, respectively. Since 2004, he has been the Editor-in-Chief of the Journal of IAEEE. He is the author of more than 1200 journal and conference papers. His teaching and research interests include Smart Grid, Microgrids, FACTS and HVDC Systems, Monitoring of Power Transformers and its Transients.

GEVORK B. GHAREHPETIAN (Senior Member, IEEE) received his BS, MS and PhD degrees in electrical engineering in 1987, 1989 and 1996 from Tabriz University, Tabriz, Iran and Amirkabir University of Technology (AUT), Tehran, Iran and Tehran University, Tehran, Iran, respectively, graduating all with First Class Honors. As a PhD student, he has received scholarship from DAAD (German Academic Exchange Service) from 1993 to 1996 and he was with High Voltage Institute of RWTH Aachen, Aachen, Germany. He has been



AMJAD ANVARI-MOGHADDAM

(Senior Member, IEEE) received the Ph.D. degree (Hons.) in power systems engineering from the University of Tehran, in 2015. He is currently an Associate Professor with the Department of Energy Technology, Aalborg University, where he is the Coordinator and responsible for the Integrated Energy Systems Laboratory (IES-Lab). He has coauthored more than 200 technical articles, four books, and eight book chapters, in the field. His research interests include planning, control, and operation management

of microgrids, renewable/hybrid power systems, and integrated energy systems with appropriate market mechanisms. He as an Associate Editor of the IEEE TRANSACTIONS ON POWER SYSTEMS, IEEE ACCESS, the IEEE SYSTEMS JOURNAL, the IEEE OPEN ACCESS JOURNAL OF POWER AND ENERGY, and the IEEE POWER ENGINEERING LETTERS. He is the Vice-Chair of IEEE Power and Energy Society (PES) Danish Chapter and serves as a Technical Committee Member for several IEEE PES/IES/PEL and CIGRE working groups. He was a recipient of 2020 DUO_India Fellowship Award, DANIDA Research Fellowship grant from the Ministry of Foreign Affairs of Denmark in 2018, IEEE-CS Outstanding Leadership Award 2018 (Halifax, Nova Scotia, Canada), and the 2017 IEEE-CS Outstanding Service Award (Exeter-UK).



FREDE BLAABJERG (Fellow, IEEE)

received the Ph.D. degree in electrical engineering from Aalborg University, in 1995. He was with ABB-Scandia, Randers, Denmark, from 1987 to 1988. He became an Assistant Professor, in 1992, an Associate Professor, in 1996, and a Full Professor of Power Electronics and Drives, in 1998. Since 2017, he has been a Villum Investigator. He is honoris causa with the University Politehnica Timisoara (UPT), Romania, and Tallinn Technical University (TTU), Estonia. He has published more than 600 journal

articles in the fields of power electronics and its applications. He is the co-author of four monographs and an editor of ten books in power electronics and its applications. His current research interests include power electronics and its applications, such as wind turbines, PV systems, reliability, harmonics, and adjustable speed drives. Dr. Blaabjerg has received 30 IEEE prize paper awards, the IEEE PELS Distinguished Service Award, in 2009, the EPE-PEMC Council Award, in 2010, the IEEE William E. Newell Power Electronics Award, in 2014, and the Villum Kann Rasmussen Research Award, in 2014. He has been a Distinguished Lecturer of the IEEE Power Electronics Society, from 2005 to 2007, and the IEEE Industry Applications Society, from 2010 to 2011, and from 2017 to 2018. From 2019 to 2020, he was a President of the IEEE Power Electronics Society. He is a Vice-President of the Danish Academy of Technical Sciences. From 2014 to 2018, he was nominated by Thomson Reuters to be between the most 250 cited researchers in Engineering in the world. He was the Editor-in-Chief of the IEEE TRANSACTIONS ON POWER ELECTRONICS, from 2006 to 2012.