



Aalborg Universitet

AALBORG UNIVERSITY
DENMARK

An auto-regressive model for battery voltage prediction

Vilsen, Søren Byg; Stroe, Daniel-Ioan

Published in:
2021 IEEE Applied Power Electronics Conference and Exposition (APEC)

Publication date:
2021

Document Version
Accepted author manuscript, peer reviewed version

[Link to publication from Aalborg University](#)

Citation for published version (APA):
Vilsen, S. B., & Stroe, D-I. (Accepted/In press). An auto-regressive model for battery voltage prediction. In 2021 IEEE Applied Power Electronics Conference and Exposition (APEC)

General rights

Copyright and moral rights for the publications made accessible in the public portal are retained by the authors and/or other copyright owners and it is a condition of accessing publications that users recognise and abide by the legal requirements associated with these rights.

- ? Users may download and print one copy of any publication from the public portal for the purpose of private study or research.
- ? You may not further distribute the material or use it for any profit-making activity or commercial gain
- ? You may freely distribute the URL identifying the publication in the public portal ?

Take down policy

If you believe that this document breaches copyright please contact us at vbn@aub.aau.dk providing details, and we will remove access to the work immediately and investigate your claim.

An auto-regressive model for battery voltage prediction

1st Søren B. Vilsen

Department of Mathematical Sciences
Aalborg University
Aalborg, Denmark
svilsen@math.aau.dk

2nd Daniel-Ioan Stroe

Department of Energy Technology
Aalborg University
Aalborg, Denmark
dis@et.aau.dk

Abstract—Accurate modelling of the dynamic behavior of Lithium-ion (Li-ion) batteries is important in a wide range of scenarios from the determination of appropriate battery-pack size, to battery balancing and state estimation in battery management systems. The prevailing methods used in voltage prediction are the equivalent electrical circuit (EEC) models. EEC models account for the change in the voltage by a series of resistor capacitor networks to mimic the internal resistance of a battery. Thus, given a change in current the EEC models create an appropriate change in the voltage. The downside is that the parameters of the model needs to be fully characterised, across the entire range of usage and life of the battery. This is both time consuming and expensive. In this paper, a linear auto-regressive (AR) process is proposed to account for the short-term dynamic behaviour of the battery cell, allowing for accurate prediction of the voltage given other measurable parameters such as current and temperature. After conducting a sensitivity analysis on the size of the sequence needed to train the AR model, it was found that less than a days worth of raw measurements data is enough to offer a better voltage prediction than a traditional EEC model (the root mean square errors of the two considered voltage estimation approaches were 0.00157 and 0.0133 V, respectively).

Index Terms—Lithium-ion battery, Voltage prediction, Auto-regressive process, Equivalent electrical circuits

I. INTRODUCTION

Accurate modelling of the voltage of Lithium-ion (Li-ion) batteries is important for predicting the battery performance behaviour under different operating conditions, for optimally sizing battery systems, or for accurate battery state estimation. Different approaches have been proposed for battery voltage modelling, generally falling into one of three categories: electrochemical, mathematical, and electrical [1]. The accuracy and complexities of the three categories are traditionally thought of as follows: (1) electrochemical models have the highest accuracy, but require complex and destructive laboratory experiments to parameterise the models, (2) the mathematical models have the lowest accuracy, but are extremely easy to parameterise based on battery data-sheet information, while (3) the electrical models are usually based on equivalent electrical circuits (EEC) and are regarded as a trade-off between the electrochemical and mathematical models as they offer relatively high accuracy without the need of destructive laboratory testing [1]. However, this will change

with the introduction of more statistical and machine learning techniques into electrical engineering.

EEC-based models predict the battery voltage by accounting for the open-circuit voltage (OCV) and its relationship to the state-of-charge (SOC), the ohmic resistance, and through a series of parallel-connected resistor-capacitor (RC) networks to account for the transient behaviour [2]–[4]. In order to provide accurate prediction of the voltage, the parameters of the EEC model need to be characterised across the entire range of operating conditions (i.e. temperature, SOC, load current) for the intended application [5]. Nevertheless, even though the laboratory testing procedure is straight-forward (unlike that of battery electrochemical characterisation/modelling), the process is very time-consuming. Furthermore, as the battery is subjected to degradation (i.e., capacity fade and resistance increase) during long-term operation, the laboratory parametrisation has to be repeated to account for these changes [6].

Auto-regressive (AR) processes are useful tools in sequential analysis [7], [8], and are, therefore, extremely common in fields such as economics, epidemiology, and the social sciences [8]. An AR process models its response as a linear function of past measurements. This makes AR processes well suited for short-term prediction of voltage given past measurements such as current, voltage, and temperature. Short-term predictions in this context usually refers to one-step ahead prediction, where step refers to the step-size of the time-series, i.e. the sampling rate of the system. While AR based models have been used for state-of-charge [9], [10], they have seen little to no use in voltage prediction to the authors knowledge. The AR modelling approach has the distinct advantage that the parameters of the system can be determined using only raw measurement information. That is, it does not require expensive laboratory testing, only that the battery is used, and while the parameters are also subjected to change under degradation, they are easily re-estimated given new measurement data.

In this paper, we compare the results for the short-term battery voltage prediction obtained from a traditional EEC-based model, with those of the proposed AR voltage model. The EEC model is based on 1 RC network and its parameters were obtained by extensive laboratory characterisation of a Li-ion battery. The AR voltage model was parameterised

using raw current and voltage measurements from a real-life dynamic mission profile, and will model the voltage as a linear function of the current and past voltage measurements. Furthermore, a sensitivity analysis is performed on the size of the raw measurement data used to estimate the parameters of the AR voltage model. The robustness of the proposed AR voltage model was also validated on a separate profile of the same chemistry, and similar in age (in terms of degradation), and the results compared to those of both a 1-RC and 3-RC EEC model.

II. EXPERIMENTAL SET-UP

For validation of the proposed AR model, a Li-ion battery cell (lithium iron phosphate – LFP chemistry) with a nominal capacity of 180 Ah and nominal voltage of 3.3V was considered. In order to parameterise the traditional EEC-based model, the battery was subjected to an extensive characterisation procedure, similar to the one presented in [5]; the capacity, OCV, and internal resistance were measured at 25°C for various currents, and over the whole SOC range. The charging and discharging capacity of the LFP-based battery cell was measured for five C-rates (i.e., 0.2C, 0.25C, 0.5C, 0.75C, and 1C) and the results are presented in Fig. 1. As one can observe, for the considered C-rates, the discharging capacity varies in a narrow interval between 197.1 Ah (measured at 1C-rate) and 198.3 Ah (measured at 0.2C).

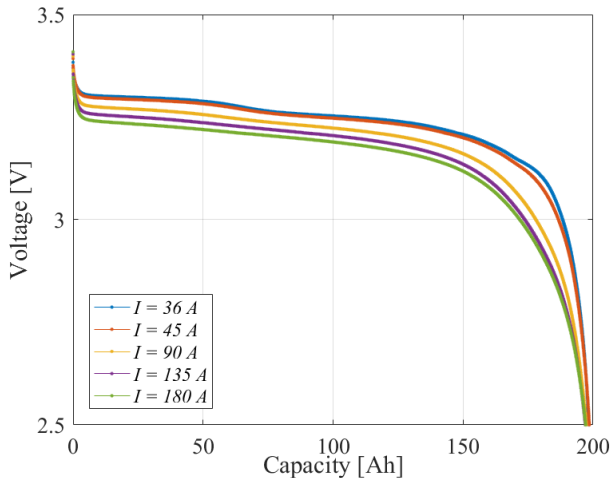

Fig. 1. Measured battery cell voltage - capacity characteristic for different discharging C-rates.

The OCV vs SOC characteristic of the battery cell was obtained by pulse charging and discharging of the cell with $C/5$ (i.e., 36 A) using 5% SOC increments. The OCV at a specific SOC was measured after the battery was on standby for 3 hours. The obtained OCV vs SOC characteristic at 25°C is presented in Fig. 2. Finally, the internal resistance of the battery cell was measured using the DC pulse technique, where 18 seconds charging and discharging pulses were applied with 0.25C, 0.5C, and 1C, over the whole SOC range considering 5% SOC resolution.

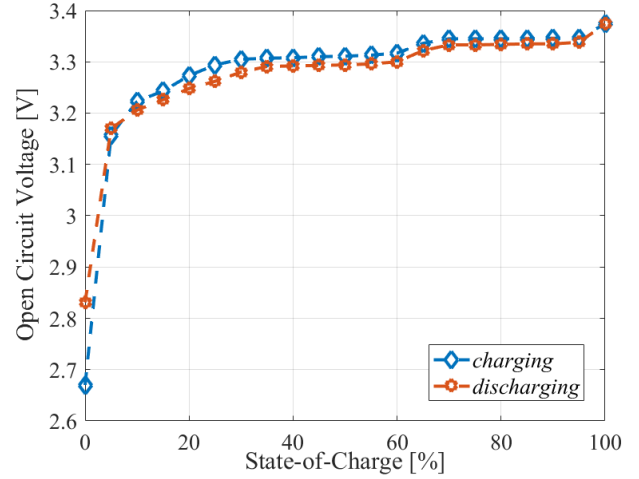

Fig. 2. Measured battery OCV versus SOC characteristic during charging and discharging.

Furthermore, for parameterising the AR model, a one-week mission profile corresponding to the battery operation in a forklift was considered. The current profile is illustrated in Fig. 3, while the corresponding SOC and voltage of the profile are illustrated in Fig.'s 4 and 5.

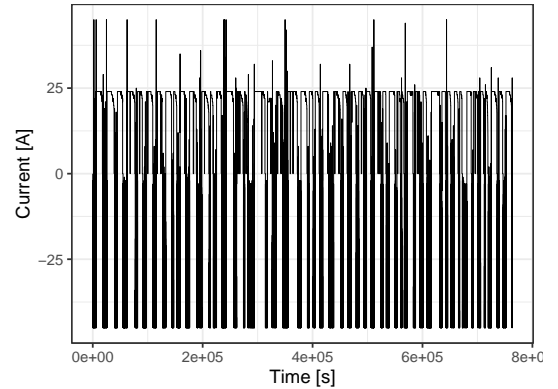

Fig. 3. The one-week current profile applied to the LFP-based Li-ion battery cell.

III. THE EQUIVALENT ELECTRICAL CIRCUIT MODEL

An n -RC EEC is a generalisation of the Thevenin EEC, allowing for n parallel-connected resistor-capacitor (RC) networks. A circuit diagram representation of the n -RC EEC can be seen in Fig. 6, where V denotes the terminal cell voltage, V_{oc} the open-circuit voltage (OCV), I is the current, R_0 is the ohmic resistance, and the pair (R_n, C_n) are the resistance and capacitance of the n 'th RC network. This can also be expressed mathematically as:

$$V(t) = V_{oc} - \sum_{i=1}^n V_i \exp\left(-\frac{t}{\tau_i}\right), \quad (1)$$

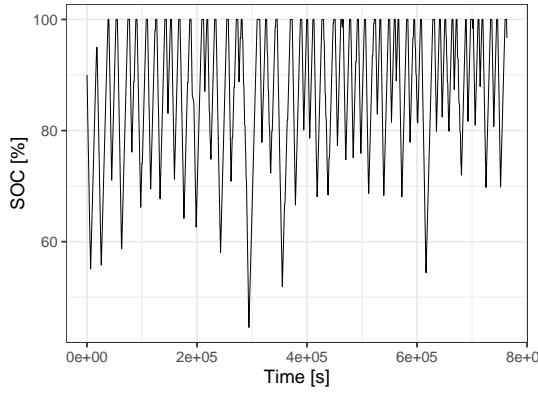

Fig. 4. The state-of-charge profile for the Li-ion battery cell during one-week of operation.

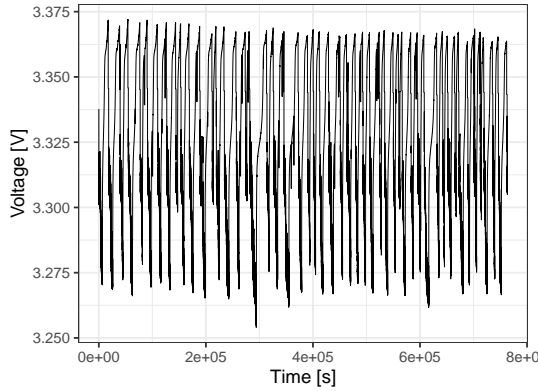

Fig. 5. The voltage profile for the Li-ion battery cell during one-week of operation.

where V_i is the initial voltage, and τ_i is the time constant of the i 'th RC network (i.e. $\tau_i = R_i C_i$).

Furthermore, as the OCV, as well as the parameters R_0 , R_i , C_i , are heavily dependent on the SOC, an estimate of the SOC based on the Coulomb counting method is included in the framework, as

$$S(t) = S(0) - \frac{1}{Q} \int_0^t I(u) du, \quad (2)$$

where $S(t)$ is the SOC at time t , and Q is the usable charge capacity of the battery cell.

The parameters of the n -RC EEC were obtained by the current pulse technique, during the battery characterization presented in Section II. That is, by applying a charging/discharging current of a certain amplitude and length to the battery and measuring the voltage response of the battery [11], [12]. The ohmic resistance, R_0 , is then obtained by Ohms law, considering the initial 0.1 seconds voltage drop, i.e.

$$R_0 = \left| \frac{\Delta V}{\Delta I} \right| = \left| \frac{V(0.1) - V(0)}{I} \right|, \quad (3)$$

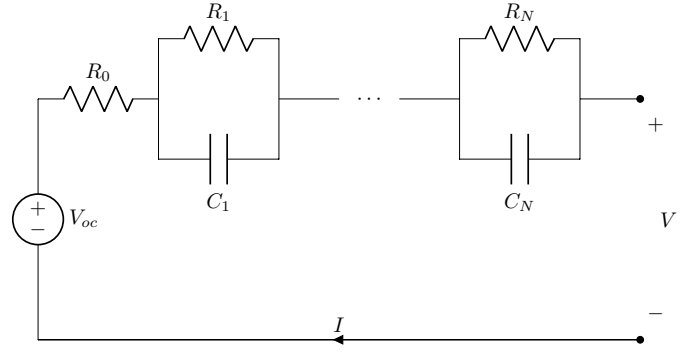

Fig. 6. Electrical circuit diagram of the n -RC EEC model.

where $V(0)$ and $V(0.1)$ are voltages measured right before and 0.1 seconds after initiating the current pulse, and I is the amplitude of the current pulse.

The RC parameters, (R_i, C_i) pairs and initial voltages, V_i , were found using the recursive methodology presented in [2]. The methodology requires the recursive calculation of the transient voltage, $V_{\tau_i}(t)$. That is, when identifying parameters of the i 'th RC network, starting at the last (n 'th) RC network, the transient voltage is calculated by:

$$V_{\tau_i}(t) = \begin{cases} V_{oc} - V(t), & \text{when } i = n \\ V_{oc} - V(t) - \sum_{j=i+1}^n \hat{V}_j(t), & \text{when } i < n \end{cases} \quad (4)$$

where $\hat{V}_i(t)$ is the predicted voltage of the i 'th RC network at time t . The newly updated transient voltage is then used to find the time-constant τ_i as:

$$\tau_i = \frac{t_{i2} - t_{i1}}{\log \left(\frac{V_{\tau_i}(t_{i1})}{V_{\tau_i}(t_{i2})} \right)}, \quad (5)$$

where t_{i1} and t_{i2} are the beginning and end of the time window used for assessing the i 'th RC network. With the time-constant, the initial voltage of the i 'th RC network is found by:

$$V_i = V_{\tau_i}(t_{i1}) \exp \left(\frac{t_{i1}}{\tau_i} \right), \quad (6)$$

which will be used to calculate the predicted voltage of the i 'th RC network as:

$$\hat{V}_i(t) = V_i \exp \left(-\frac{t}{\tau_i} \right). \quad (7)$$

Lastly, the resistance and capacitance parameters are found using the size and duration of the current pulse, denoted I_p

and T_p , respectively:

$$R_i = \frac{V_i}{I_p \left(1 - \exp\left(-\frac{T_p}{\tau_i}\right)\right)}, \quad \text{and} \quad C_i = \frac{\tau_i}{R_i}. \quad (8)$$

The OCV-SOC relationship was obtained by laboratory experiments following the methodology presented Section II. The parameters were then arranged in look-up tables (to account for the dependencies on SOC, and current), allowing for simulation of the terminal cell voltage of the battery, given a series of current measurements. As the focus of this paper is to compare two simple approaches, two EEC are implemented to predict the voltage: a 1-RC EEC model (i.e. the Thevenin model), and the 3-RC EEC model.

IV. THE AUTO-REGRESSIVE MODEL

In general, an auto-regressive (AR) model relates the present measurement of the response (in our case the voltage) with previous measurements, and it does so in a linear fashion. The AR framework can also be easily extended to account for general trends, additional input (this could be current, temperature, SOC, and so on), and seasonal effects (seasonal in this context does not necessarily refer to changes in weather, but patterns repeating in predictable cycles) [7], [8].

The AR voltage model proposed in this work is a first order AR model, implying the voltage at time t will only depend on the immediate past voltage measurements, i.e. the voltage measured at time $t-1$. The AR voltage model also accounts for the effect of the current amplitude, the change in current, and sum of the current (an unnormalised measure of the SOC). Letting V_t be the voltage at time t , I_t the current at time t , ΔI_t the change in current between time $t-1$ and t (i.e. $\Delta I_t = |I_t - I_{t-1}|$), and S_t be the sum of the current until time t , then the AR voltage model can be written as:

$$V_t = \mu + \alpha V_{t-1} + \beta_1 I_t + \beta_2 \Delta I_t + \beta_3 S_t + \varepsilon_t, \quad (9)$$

where ε_t is assumed to follow a normal distribution with mean zero and a finite variance σ^2 , and ε_t is assumed to be uncorrelated with ε_s when $t \neq s$. This model can also be depicted graphically as seen in Fig. 7.

The parameters of the model, $\theta = (\mu, \alpha, \beta_1, \beta_2, \beta_3)^T$, can be estimated by maximising the log-likelihood of the model in Eq. (9), which can be written as:

$$\begin{aligned} \ell(\theta | \mathbf{V}_{1:T}, \mathbf{I}_{1:T}) &= -\frac{T-1}{2} \log(2\pi\sigma^2) \\ &\quad - \frac{1}{2\sigma^2} \sum_{t=2}^T (V_t - \mu_t(\theta | V_{t-1}, I_t, \Delta I_t, S_t))^2, \end{aligned} \quad (10)$$

where $\mathbf{V}_{1:T}$ and $\mathbf{I}_{1:T}$ are observed sequences of the voltage and current, respectively, and $\mu_t(\theta)$ is the mean-value structure

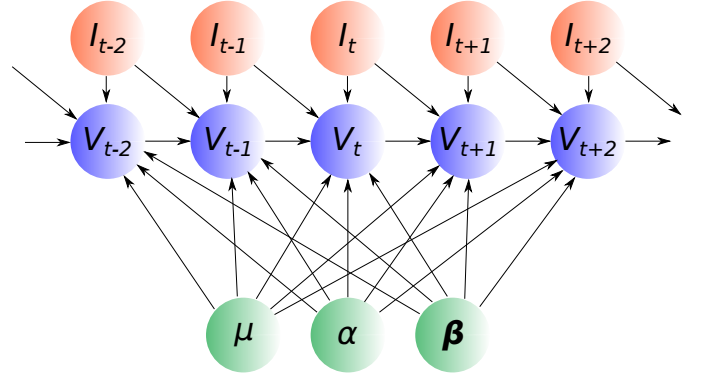

Fig. 7. Graphical model representation of the AR model model. seen in Eq. (9)

of the AR voltage model, given as:

$$\begin{aligned} \mu_t(\theta | V_{t-1}, I_t, \Delta I_t, S_t) &= \\ \mu + \alpha V_{t-1} + \beta_1 I_t + \beta_2 \Delta I_t + \beta_3 S_t. \end{aligned} \quad (11)$$

In order to maximise Eq. (10) with respect to θ , the model is restated as a multiple linear regression model:

$$\mathbf{V}_{2:T} = \mathbf{F}\theta + \varepsilon_{2:T}, \quad (12)$$

where \mathbf{F} is matrix where the t 'th row will contain the data necessary to calculate the $(t+1)$ 'th voltage of the sequence, i.e. it is given by:

$$\mathbf{F} = \begin{bmatrix} 1 & V_1 & I_2 & \Delta I_2 & S_2 \\ 1 & V_2 & I_3 & \Delta I_3 & S_3 \\ \vdots & \vdots & \vdots & \vdots & \vdots \\ 1 & V_{T-1} & I_T & \Delta I_T & S_T \end{bmatrix}. \quad (13)$$

Using this formulation of the model, the maximum likelihood estimates of the θ parameters can be found as:

$$\hat{\theta} = (\mathbf{F}^T \mathbf{F})^{-1} \mathbf{F}^T \mathbf{V}_{2:T}. \quad (14)$$

From the log-likelihood in Eq. (10), it should be clear that as the size of the sequence increases, so does both the memory and computational complexities of the maximisation. Therefore, it will be of interest to determine the amount of information necessary to get consistent estimates of the AR voltage model parameters.

V. RESULTS

While the estimation of the parameters of the AR voltage model requires less information, than the parameters of the EEC model, it is of interest to find out how much data is needed to get consistent estimates of the AR voltage model parameters, and how applicable these are to a different use cases (i.e. different profiles of similar battery chemistry and

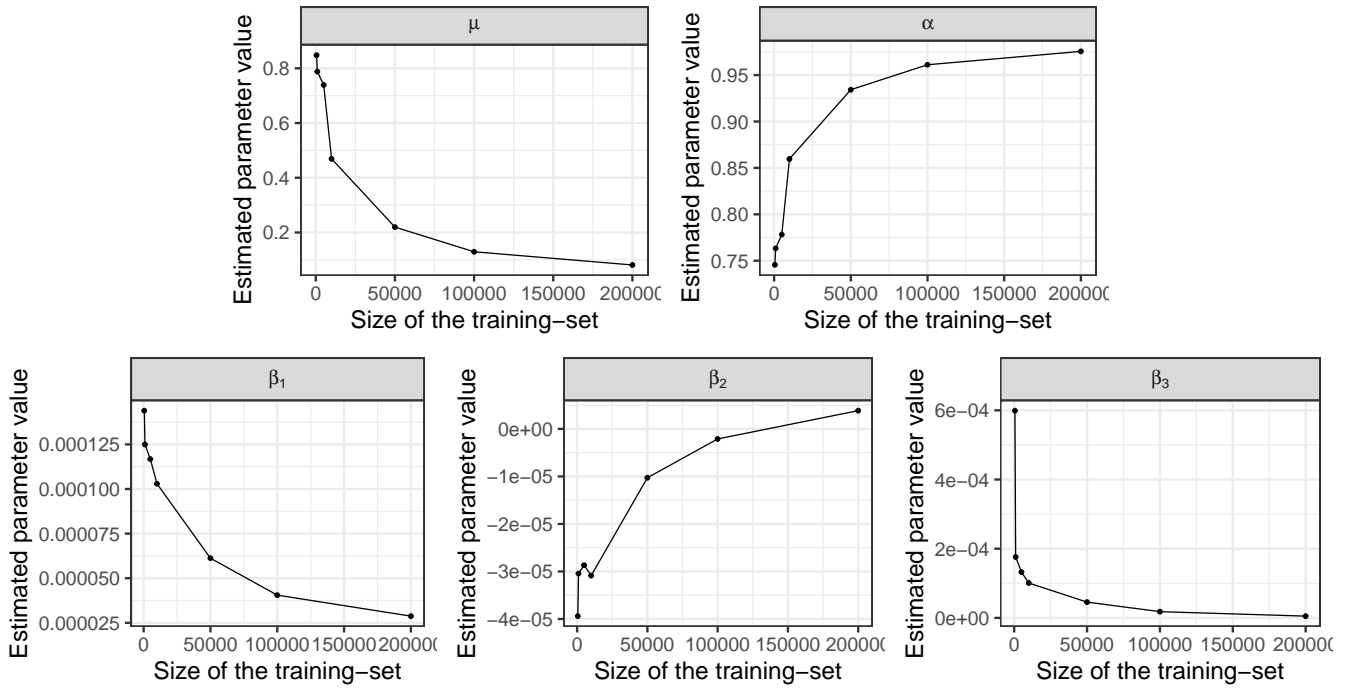

Fig. 8. The estimated parameters of the AR voltage models in the sensitivity experiments, against the size of the sequence used to estimate the parameters.

TABLE I

NUMERICAL COMPARISONS OF THE AR AND EEC MODELLING APPROACHES, INCLUDING THE SENSITIVITY RESULTS OF THE AR VOLTAGE MODEL, FOR THE REMAINDER OF THE ONE-WEEK PROFILE. THE NUMERICAL ACCURACY METRICS USED ARE RMSE, MAE, MAX AE, MAPE, AND MAX APE.

Model	Training-size	RMSE [V]	MAE [V]	Max AE [V]	MAPE [%]	Max APE [%]
EEC (1-RC)	-	0.0181	0.0133	0.0705	0.40	2.16
EEC (3-RC)	-	0.0138	0.0096	0.0498	0.38	2.03
AR	500	0.1631	0.1521	0.2742	4.57	8.20
AR	1000	0.0478	0.0445	0.0887	1.34	2.65
AR	5000	0.0367	0.0343	0.0709	1.03	2.15
AR	10000	0.0292	0.0275	0.0610	0.83	1.83
AR	50000	0.0133	0.0125	0.0391	0.37	1.17
AR	100000	0.0052	0.0048	0.0289	0.14	0.86
AR	200000	0.0020	0.0015	0.0260	0.04	0.78

similar level of degradation). Therefore, a sensitivity study is conducted on the size of the data-set used to estimate the model parameters, and two different profiles. The parameters will be estimated based on the first 500, 1,000, 5,000, 10,000, 50,000, 100,000 and 200,000 seconds, of the one-week battery dynamic profile, which is presented in Fig. 3 and Fig. 4. This yields a series of seven AR voltage models. When performing the sensitivity experiments the models will be compared in two ways: (1) visual comparison of short-term predictions, and (2) numerically, through the root mean square error (RMSE), mean absolute error (MAE), maximum absolute error (Max AE), mean absolute percentage error (MAPE), and maximum absolute percentage error (Max APE).

Using the sensitivity study, the change in the estimated parameters can also be examined as a function of the size of the training set. Fig. 8 shows the estimated parameters for each of the 7 AR voltage models in the sensitivity experiments. The figure shows that as the size of the sequenced used to train the

parameters increases, the estimated parameters stabilise. That is, they are tending toward the maximum likelihood estimate of the entire sequence.

In order to validate the AR voltage modelling approach and analyse the sensitivity of the size of the training sequence, the 7 sensitivity models will be applied to the remaining 400,000 seconds of the one-week profile. The results of the sensitivity study on the one-week profile can be seen in Table I, showing the RMSE, MAE, Max AE, MAPE, and Max APE between measured voltage of the profile, and the predicted voltage of the 7 AR voltage models, and the EEC model. The table shows that as the size of the sequence used to estimate the parameters increases, the errors decreases between the AR voltage model and the observed voltage. It further shows that the error of the AR voltage model becomes smaller than the error of the EEC model, when the size of the sequence is larger than 50,000 seconds (i.e. using less than a days worth of operation). Furthermore, it can be observed that further increasing the

One-week profile

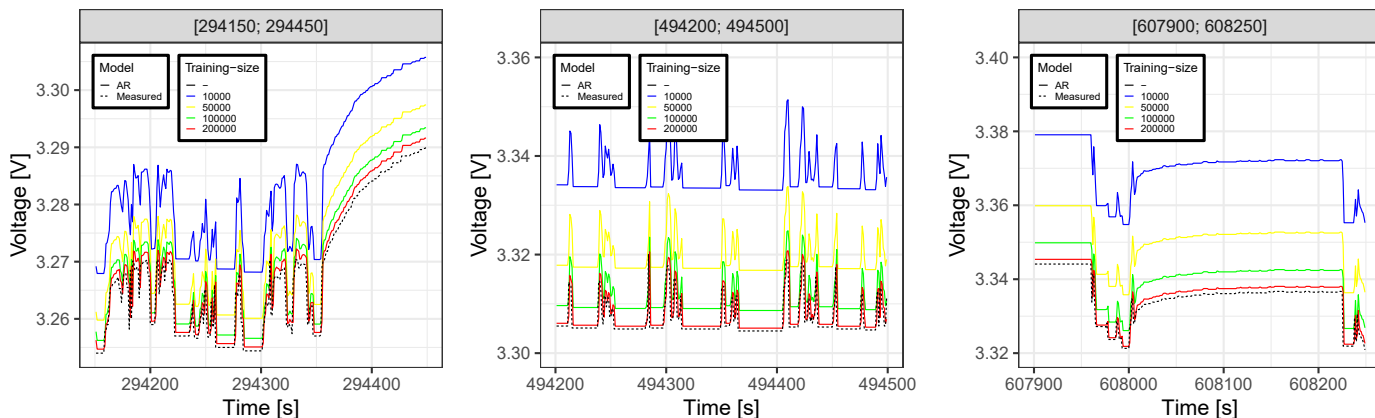

Fig. 9. Example of measured and estimated voltage profiles, at different times during the one-week battery testing.

size of the training sequence from 50,000 to 100,000” and/or 200,000 results only in a slight improvement of the voltage estimation error.

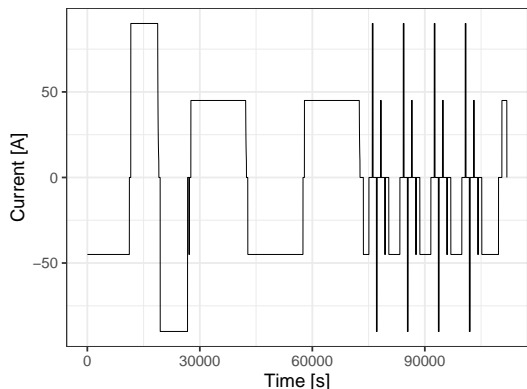

Fig. 10. The current profile of the reference performance test applied to the LFP-based Li-ion battery cell at the end of the week.

Fig. 9 shows three windows of time for the remainder of the one-week profile, allowing for the visually comparison the AR and EEC modelling approaches. They further show four of the sensitivity experiments conducted on the AR voltage model. The solid blue line is the measured voltage, the green dashed line is the simulation of the EEC-based model, and the red lines are three of the sensitivity experiments of the AR voltage models. The figures show the same effect as can be seen in the table, i.e. as the size of the sequence used to estimate the parameters increases, the predicted voltage of the AR voltage model tends towards the measured voltage, passing the EEC model around 50,000 seconds.

To show the general applicability of the proposed AR voltage model, it was further applied to the profile of the reference performance test (RPT), which was performed at the end of the dynamic operation profile. The RPT is a structurally different profile than the dynamic profile however, applied to the same battery and at the same level of degradation. The

current profile of the RPT can be seen in Fig. 10. The results, summarised in Table II, on the less-dynamic profile of the RPT, are even better than that of the more-dynamic one-week profile used to train the models. The table shows that the AR voltage model with the smallest training size, i.e. only using the first 500 seconds, has smaller errors (in every comparison metric), than the EEC model. This is further support by the visual comparisons shown in Fig. 11.

VI. DISCUSSION

In this paper, an auto-regressive modelling approach was proposed for short-term prediction of the voltage of Li-ion batteries. The sensitivity of the dependence on the size of the training sequence, on accuracy of the AR modelling approach was also analysed on both the dynamic one-week profile, and the simpler RPT profile. The results of the sensitivity analysis were compared to the accuracy of a 1-RC EEC model. These comparison showed that on the dynamic profile, the RMSE of the AR voltage model become lower than that of the EEC, at around 50,000 seconds, were the RMSE of the AR and EEC models were 0.00157 and 0.0133 V, respectively. Furthermore, on the more stable RPT profile, the RMSE of all of the AR models were lower than the RMSE of the EEC.

With that said, the AR modelling approach is not without its disadvantages, the clearest being the fact that the predictions are only made a single time instance (in this case second – it will depend on the resolution of the sequence used to train the model) ahead with high accuracy. That is, to make a prediction at time t , it is necessary to know the voltage and current at time $t - 1$. This is not the case for the EEC model, where only a sequence of current values are needed to simulate the voltage. Furthermore, the AR model is going to be more unstable under continued degradation. The effect of this can be seen on the left-hand plot in Fig. 12, showing a moving average of the MAE against time. The smoothed MAE clearly shows that the MAE, on average, increases with time. As this profile was used to age the battery, it implies that the parameters may be effected by the degradation. This is

TABLE II

NUMERICAL COMPARISONS OF THE AR AND EEC MODELLING APPROACHES, INCLUDING THE SENSITIVITY RESULTS OF THE AR VOLTAGE MODEL, FOR THE REMAINDER OF THE RPT PROFILE. THE NUMERICAL ACCURACY METRICS USED ARE RMSE, MAE MAX AE, MAPE, AND MAX APE.

Model	Training-size	RMSE [V]	MAE [V]	Max AE [V]	MAPE [%]	Max APE [%]
EEC (1-RC)	-	0.0887	0.0338	0.6229	1.12	24.93
EEC (3-RC)	-	0.0681	0.0269	0.4621	1.19	24.66
AR	500	0.0291	0.0230	0.1267	0.72	5.07
AR	1000	0.0257	0.0125	0.1706	0.41	6.83
AR	5000	0.0255	0.0128	0.1653	0.42	6.61
AR	10000	0.0155	0.0072	0.1034	0.24	4.14
AR	50000	0.0072	0.0031	0.0794	0.10	3.02
AR	100000	0.0045	0.0019	0.0978	0.06	3.72
AR	200000	0.0031	0.0015	0.1076	0.05	4.10

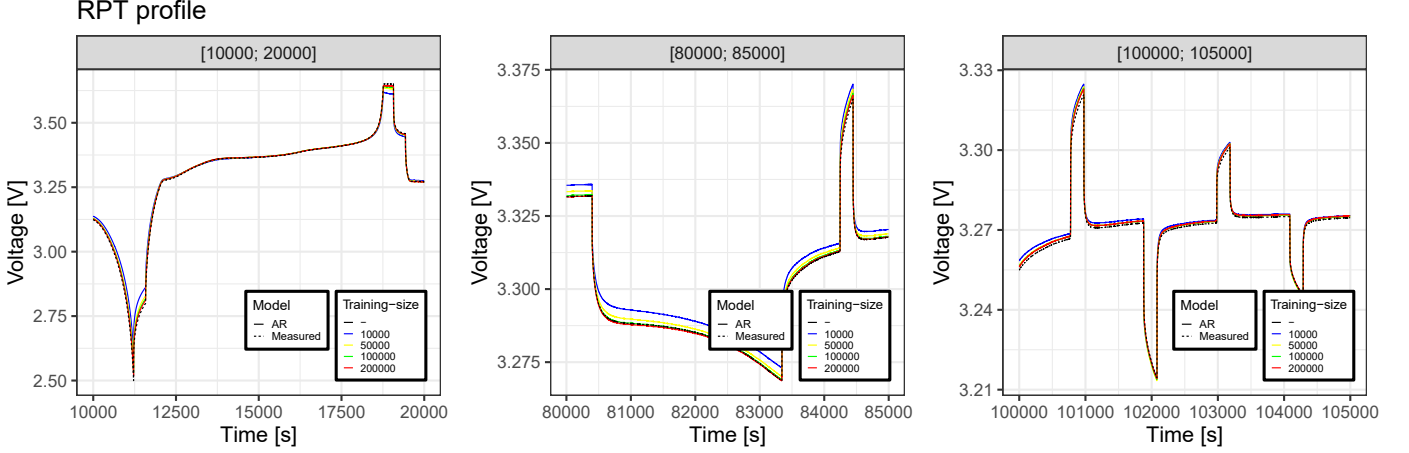

Fig. 11. Example of measured and estimated voltage profiles, at different times during the battery RPT.

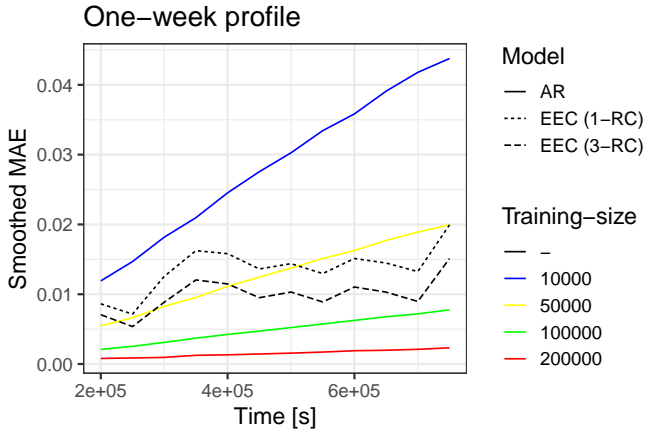

Fig. 12. A moving average of the MAE against time, for the one-week profile, shown for four of the sensitivity models and the EEC model.

also true for the EEC parameters, however, the rate of change for the AR parameters seems to be higher than for the EEC parameters. This suggests that the parameters of the AR model may need to be re-estimated at a higher rate than those of the EEC model.

To account for the time-varying nature of the AR parameters, a filtering approach can also be taken to the estimation of

the parameters. This would allow for continuous updating of the parameters as data is gathered, alleviating the amount of data needed to be stored to allow for periodic re-estimation. In this context, the AR model needs to be re-stated as a state-space model, with the state-equation representing the parameters, and the observation-equation the model in Eq. (9):

$$\begin{aligned} V_t &= F_t \theta_t + \varepsilon_t, \\ \theta_t &= \theta_{t-1} + \omega_t, \end{aligned} \quad (15)$$

where $F_t = (1, V_{t-1}, I_t, \Delta I_t, S_t)$, and ω_t is assumed to follow a multivariate normal distribution with mean-vector $\mathbf{0}$ and covariance matrix, Σ . Furthermore, when formulated as a state-space model, if both the state- and observation-equations are linear and the noise is white (i.e. uncorrelated), filtering using the Kalman filter will ensure that the parameters converge to the maximum likelihood estimates [8].

Computationally the three approaches, EEC, AR modelling using Eq. (14) for parameter estimation, and AR modelling using Kalman filtering for parameter estimation, have slightly different advantages and disadvantages. The EEC parameterisation is very expensive, taking about 10-14 days of laboratory measurements, compared to both of the AR approaches one using about a days worth of raw measurement data, and the other, being done continually, requiring a couple of seconds

worth of measurement data. The main advantage the EEC model has on the two AR approaches is the frequency with which this needs to be performed.

Lastly, there are two additional shortcomings of the AR voltage model presented in this paper, namely that it does not account change in for battery temperature, and that SOC estimation is not possible in its present form. Both of these shortcomings are considered for future research.

REFERENCES

- [1] M. Chen and G. A. Rincon-Mora, "Accurate electrical battery model capable of predicting runtime and I-V performance," *IEEE Transactions on Energy Conversion*, vol. 21, pp. 504–511, 2006.
- [2] A. Hentunen, T. Lehmuspelto, and J. Suomela, "Time-domain parameter extraction method for thevenin-equivalent circuit battery models," *IEEE Transactions on Energy Conversion*, vol. 29, pp. 558–566, 2014.
- [3] A. Stroe, D. Stroe, M. Swierczynski, R. Teodorescu, and S. K. Kær, "Lithium-ion battery dynamic model for wide range of operating conditions," in *2017 International Conference on Optimization of Electrical and Electronic Equipment (OPTIM) 2017 Intl Aegean Conference on Electrical Machines and Power Electronics (ACEMP)*, 2017, pp. 660–666.
- [4] S. S. Madani, E. Schaltz, and S. Knudsen Kær, "An electrical equivalent circuit model of a lithium titanate oxide battery," *Batteries*, vol. 5, no. 1, 2019. [Online]. Available: <https://www.mdpi.com/2313-0105/5/1/31>
- [5] D.-I. Stroe, M. Swierczynski, A.-I. Stroe, and S. Knudsen Kær, "Generalized characterization methodology for performance modelling of lithium-ion batteries," *Batteries*, vol. 2, 2016.
- [6] Stroe, A.-I., Knap, V., and Stroe, D.-I., "Comparison of lithium-ion battery performance at beginning-of-life and end-of-life," *Microelectronics Reliability*, vol. 88-90, pp. 1251–1255, 2018.
- [7] M. West and J. Harrison, *Bayesian Forecasting and Dynamic Models*. Springer, 1997.
- [8] R. H. Shumway and D. S. Stoffer, *Time Series Analysis and Its Applications*. Springer, 2011.
- [9] X. Dang, L. Yan, H. Jiang, X. Wu, and H. Sun, "Open-circuit voltage-based state of charge estimation of lithium-ion power battery by combining controlled auto-regressive and moving average modeling with feedforward-feedback compensation method," *International Journal of Electrical Power & Energy Systems*, vol. 90, pp. 27–36, 2017.
- [10] G. Dong, Z. Chen, and J. Wei, "Sequential monte carlo filter for state-of-charge estimation of lithium-ion batteries based on auto regressive exogenous model," *IEEE Transactions on Industrial Electronics*, vol. 66, no. 11, pp. 8533–8544, 2019.
- [11] "Electrically propelled road vehicles – Test specification for lithium-ion traction battery packs and systems – Part 1: High-power applications, ISO 12405-1:2011," 2011.
- [12] D. Stroe, M. Swierczynski, S. K. Kær, and R. Teodorescu, "Degradation behavior of lithium-ion batteries during calendar ageing—the case of the internal resistance increase," *IEEE Transactions on Industry Applications*, vol. 54, pp. 517–525, 2018.