

Fall 2013

Research at Worcester Polytechnic Institute, Fall 2013

Worcester Polytechnic Institute

Follow this and additional works at: <http://digitalcommons.wpi.edu/wpiresearch-all>

Recommended Citation

Worcester Polytechnic Institute, "Research at Worcester Polytechnic Institute, Fall 2013" (2013). *WPI Research*. Book 1.
<http://digitalcommons.wpi.edu/wpiresearch-all/1>

This Book is brought to you for free and open access by the Marketing Publications at DigitalCommons@WPI. It has been accepted for inclusion in WPI Research by an authorized administrator of DigitalCommons@WPI.

Re search

2013

at WORCESTER POLYTECHNIC INSTITUTE



What is this **Bee**
Thinking?

More than you might guess. The success of
a \$1 billion industry may depend on its thoughts.

A large fire is burning in a laboratory setting. The fire is bright orange and yellow, with thick black smoke rising from it. Several people are standing around the fire, observing it. The laboratory has white walls and various pieces of equipment. The word "if..." is written in a large, white, lowercase font in the upper left corner of the image.

if...

IF... WE INVEST IN FACILITIES FOR CUTTING-EDGE RESEARCH. THEN... JUST IMAGINE WHAT WE CAN ACCOMPLISH.

The new Fire Protection Engineering Laboratory at WPI's Gateway Park is the most advanced university facility in the United States for research on fire. With the well-equipped Fundamentals Laboratory for bench-scale studies and the 2,500-square-foot Engineering Laboratory for full-scale fire tests, the new facility is making it possible for faculty members and students in WPI's graduate program in Fire Protection Engineering — the first such program in the nation — to address the most challenging fire safety problems of today and tomorrow and develop solutions that protect people and property.

Join Underwriters Laboratories, Honeywell, Kidde, RJA Group, Siemens Building Tech, Lufkin Trust, and Aon Fire Protection Engineering in supporting this exciting new facility and the faculty and students who drive today's leading-edge research.

if...

the campaign to **advance WPI**

ONLINE: WPI.EDU/+GIVE

PHONE: 508-831-4177

EMAIL: IF@WPI.EDU

if... The Campaign to Advance WPI — a comprehensive, \$200 million fundraising endeavor — is about providing outstanding resources for education and research. The Campaign will supply the facilities to help the university's talented faculty and students address important challenges that matter to society and produce innovations and advances that help build a better world.

if... we imaging a bright future, together we can make it happen.

Research

2013

at WORCESTER POLYTECHNIC INSTITUTE

Discovery and Innovation with Purpose > wpi.edu/+research



10

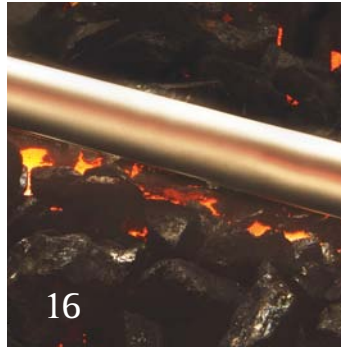

16



24

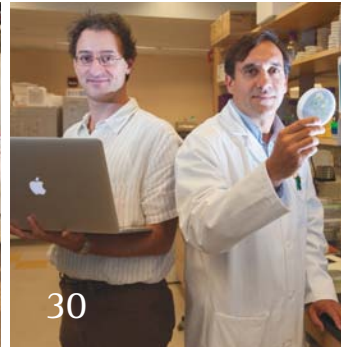

30

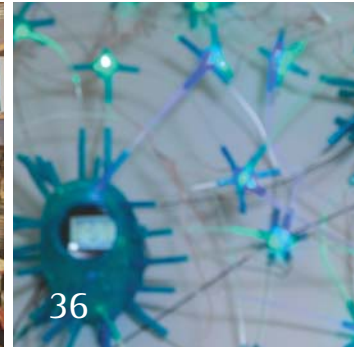

36

3 > Notebook

Notable research stories from the past year. [A](#) [E](#)

9 > Art of Science

Beauty is in the eye of the researcher. [A](#) [E](#)

10 > Hive Mind

How bees think, and why that matters. [A](#)

16 > Palladium and Black Gold

WPI technology may be the key to clean coal. [E](#)

24 > Building a Winning Academic Team

In academia as in baseball, it's all about talent. [A](#) [B](#) [E](#)

30 > A Perfect Blendship

Biology, physics, and a remarkable partnership. [A](#)

36 > The Weakest Link

Security experts meet the enemy, and he is us. [A](#) [E](#)

38 > Highlights

Faculty awards, honors, books, and grants. [A](#) [B](#) [E](#)

44 > Tools of the Trade

In Soussan Djamasbi's lab, the eyes have it. [B](#)

The symbols above indicate that the stories describe research in Arts and Sciences [A](#), Business [B](#), or Engineering [E](#).

ON THE COVER: Bumblebee photo by Patrick O'Connor.

WATCH VIDEOS ABOUT WPI RESEARCH > Snap this code with your smart phone using a QR code reader or visit YouTube.com/WPI and click on Research at WPI.



ACADEMIC LEADERSHIP

Philip Ryan '65, *Interim President*

Eric Overström, *Provost and Senior Vice President*

David Cyganski, *Dean of Engineering ad interim*

Karen Kashmanian Oates, *Dean of Arts and Sciences*

Mark Rice, *Vice Provost for Innovation and Entrepreneurship and Dean of the School of Business*

EDITOR

Michael Dorsey, *Director of Research Communications*

DESIGN

Pamela Mecca

PHOTOGRAPHY

Patrick O'Connor

Steven King

Dan Vaillancourt

PRODUCTION

Doreen Manning, *Managing Editor*

Peggy Isaacson, *Copy Editor*

Dianne Vanacore, *Production Coordinator*

Research at Worcester Polytechnic Institute is produced annually for the Division of Academic Affairs by the Division of Marketing and Communications.

Address correspondence to:

Editor, Research at WPI
Worcester Polytechnic Institute
100 Institute Road
Worcester, MA 01609-2280
508-831-5609
research@wpi.edu
wpi.edu/+research



WPI



> MESSAGE FROM THE OFFICE OF THE PROVOST

GO, TEAM!

The great UCLA basketball coach John Wooden knew something about building a winning team. His Bruins won 10 NCAA national championships in the 12 years between 1963 and 1975, a feat as yet unduplicated. Wooden was aware that to be successful as a coach you have to dedicate yourself to recruiting highly talented players. But he also believed that talent can take you only so far. To get the rest of the way, and build a winning program that endures, you must create an environment where talented people know they will thrive.

As you'll read in the story beginning on page 24, WPI has, in recent years, made an extraordinary investment in talent, recruiting more than 90 new tenured and tenure-track faculty members since 2006 (or close to 30 percent of our current full-time faculty). These are men and women with impressive academic and scholarly credentials—CAREER Awards, notable postdoctoral and academic appointments, well-established and well-funded research programs, and distinguished honors. Landing these rising stars, who were also being wooed by other top universities, often required a full-court press, complete with negotiations over start-up packages, laboratory space, and so on.

While it is true that our ability to offer these amenities can make a big difference when recruiting new talent, it is the environment new faculty members find when they arrive and the character of our scholarly community that ultimately convinces them to stay on and achieve their career aspirations at WPI. Among the most important qualities of that community are the ease with which research collaborations can cross disciplinary boundaries and the importance our researchers place on doing work that not only expands our understanding of the universe, but helps create a better, safer, healthier, and more sustainable world.

This issue of *Research at Worcester Polytechnic Institute* is bristling with examples of what happens when smart, accomplished, and passionate educators and researchers join this dynamic community. Take, for example, Luis Vidali and Erkan Tüzel (page 30). Members of the new faculty class of 2009, they quickly developed a productive research partnership that blends their complementary disciplines of biology (Vidali) and physics (Tüzel). Studying the inner machinery of the cell through laboratory work and computer modeling, they have won wide acclaim and attracted significant funding, including an NSF CAREER Award (Vidali) and an NIH R01 grant (Tüzel).

Then there is our growing strength in cybersecurity research and education, which has been bolstered over the last two years through four strategic hires: Thomas Eisenbarth and Lifeng Lai in Electrical and Computer Engineering, and Craig Shue and Krishna Venkatasubramanian in Computer Science (you'll meet them in a story starting on page 36). Through collaborations with each other, and with faculty in multiple disciplines across campus, they are establishing WPI as a center for high-impact work in this emerging field, bringing in new awards, forging collaborations with industry and government, and producing scholarship that is earning recognition from their peers.

We could point to many other success stories that have resulted from our unprecedented investment in new faculty talent. They include remarkable tales of individual achievement, of course. But just as important are the countless products of wide-ranging, cross-disciplinary faculty collaborations. For it may just be that the most important and satisfying outcome of our recent success in faculty recruiting is that we have been able to find so many people who understand the rewards and the power of working together with like-minded colleagues on important and meaningful research. We think it is safe to say they would wholeheartedly agree with John Wooden, who once said that "the main ingredient of stardom is the rest of the team."

Winning
takes talent;
to repeat takes
character.

— John Wooden

Michael B. Manning, PhD
Vice Provost for Research

Eric W. Overström, PhD
Provost and Senior Vice President

notebook

> STRINGING CELLS ON A THREAD TO REBUILD HEARTS

DURING A HEART ATTACK, vessels that deliver blood to the heart are choked off. Deprived of oxygen, cardiac muscle dies, to be replaced by scar tissue. With sections of its muscle now unable to contract, the heart becomes a less efficient pump. A number of research teams are seeking ways to restore heart function by regenerating damaged tissue. One promising approach involves seeding the heart with human mesenchymal stem cells (hMSCs), which are derived from bone marrow. In work to date, it has been shown that this method can restore some heart function, but with existing delivery methods (injecting the cells into the bloodstream or directly into the heart muscle), only about 15 percent of the cells actually engraft.

A research team at WPI has been working for several years on a more effective way to place stem cells exactly where they are needed and to give them a fighting chance to take hold. It involves growing the cells on microthreads made from fibrin, a protein involved in blood clotting. About the width of a human hair, the threads can be twisted into cable-like structures that mimic natural connective tissues. First developed in the lab of **George Pins**, PhD, associate professor of biomedical engineering, as a potential tool for repairing torn anterior cruciate ligaments in the knee, the microthreads were transformed by Pins and **Glenn Gaudette**, PhD, also an associate professor of biomedical engineering, into biological sutures that can be used to stitch stem cells directly into wound sites and damaged tissues.

In 2012 Gaudette and Pins founded VitaThreads to commercialize this invention; Adam Collette, vice president of product development, and Harry Wotton '94, CEO, are co-founders. In early 2013 the company was one of four finalists in the Association of University Technology Managers annual international business plan contest. In the summer of 2013, Pins and Gaudette received a five-year, \$1.94 million award from the National Institutes of Health to continue to develop this innovative technology.

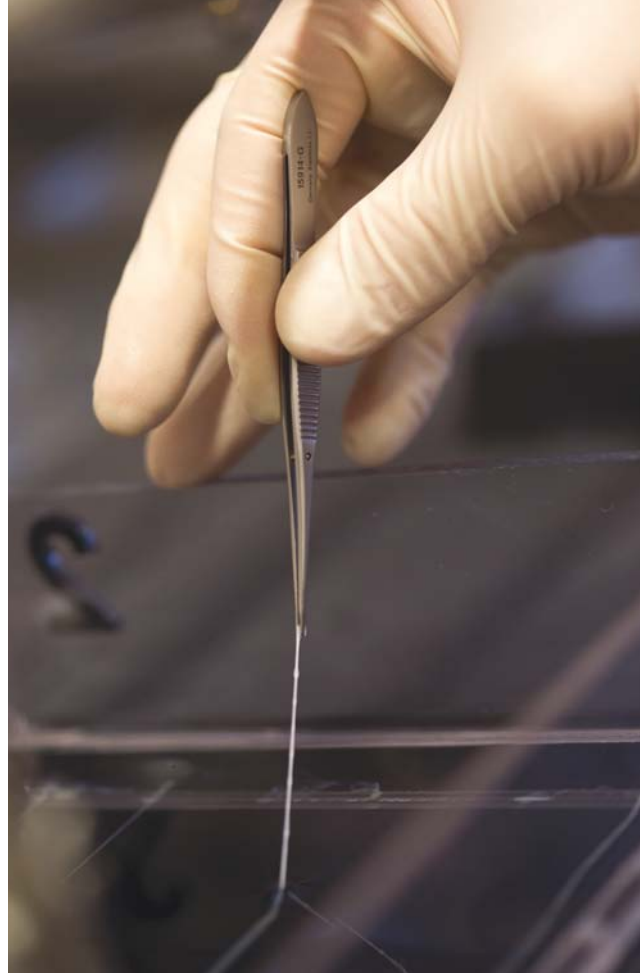

In early studies the WPI team was able to grow up to 40,000 adult stem cells on each centimeter of a microthread suture. When the threads were stitched into an infarcted rat heart, more than 60 percent of the cells successfully engrafted into the cardiac muscle. With the NIH award, they will work to optimize the adhesion of stem cells to the microthreads by adjusting the composition of the threads and the process used to grow the cells.

In addition to hMSCs, they will also work with induced pluripotent stem cells (iPSCs), which are adult human skin cells reprogrammed to act like stem cells, and evaluate the ability of each cell type to engraft and promote regeneration in an infarcted heart. The iPSCs will be developed in the lab of Michael Laflamme, MD, PhD, associate professor of pathology at the University of Washington and a leader in the field of using induced pluripotent stem cells for cardiac regeneration. After stitching the cells into the damaged hearts, the team will use novel imaging and analytic techniques to determine whether the cells are promoting muscle regeneration and improving the mechanical function of the infarcted heart. Finally, they will add another class of cells, one that promotes blood vessel formation, to the microthreads to see if those cells, in combination with the stem cells, can augment the regeneration of the damaged cardiac muscle.

< WPI researchers are using microthreads made from fibrin, above and left, as scaffolds for adult stem cells. The cells are grown on the threads (cells in the process of dividing appear in green in the photomicrograph). Bundles of threads, which mimic natural connective tissue, are stitched into damaged heart muscle, where they initiate regeneration.

> WPI TEAMS PREPARE FOR A ROBOT SHOWDOWN

STANDING MORE THAN SIX FEET TALL, sheathed in a rugged metal framework, and sporting a chest-mounted heat sink that glows with a high-tech aura, WPI's Atlas robot is an impressive sight. Created by Boston Dynamics (working under a contract from the Defense Advanced Research Projects Agency, or DARPA), Atlas is the most sophisticated and capable humanoid robot ever built.

DARPA is interested in accelerating the development of robots like Atlas that can work in facilities designed for people and perform the kinds of tasks needed for disaster response. That is the goal of the DARPA Robotics Challenge (DRC), which has engaged robotics teams at universities, government labs, and companies. Having navigated four independent tracks, the surviving teams will meet in December 2013 in Florida for a match-up in which humanoid robots will respond to a simulated disaster scenario.

WPI will be represented on two of those teams. The first, led by researchers at Drexel University, will field a robot known as Hubo. At WPI, one of eight universities preparing Hubo for the rigors of the DRC, **Dmitry Berenson**, PhD, assistant professor of computer science and robotics engineering, is heading a team that also includes **Sonia Chernova**, PhD, assistant professor of computer science and robotics engineering, and **Robert Lindeman**, PhD, associate professor of computer science. They are developing the algorithms that will enable Hubo to find and turn a valve. The robots will also have to drive a truck, walk across rubble, and remove debris blocking an entryway, among other tasks.

Joining the Drexel team at the December trials will be a team of WPI robotics engineers who earned a place in the Florida showdown by entering a DRC track known as the Virtual Robotics



Velin Dimitrov, a PhD candidate in robotics engineering and a member of WPI's homegrown DARPA Robotics Challenge Team, with WARNER (WPI's Atlas Robot for Nonconventional Emergency Response).

Competition (VRC). Working against the clock, they programmed a virtual version of the Atlas to tackle a challenging series of tasks. Of 26 teams that qualified for the VRC, WPI's placed second; its reward: a real Atlas to use in the December contest.

The best performing teams in December will advance to the DARPA Robotic Challenge finals in 2014. The ultimate winner will walk away with \$2 million—and an Atlas robot to call their own.

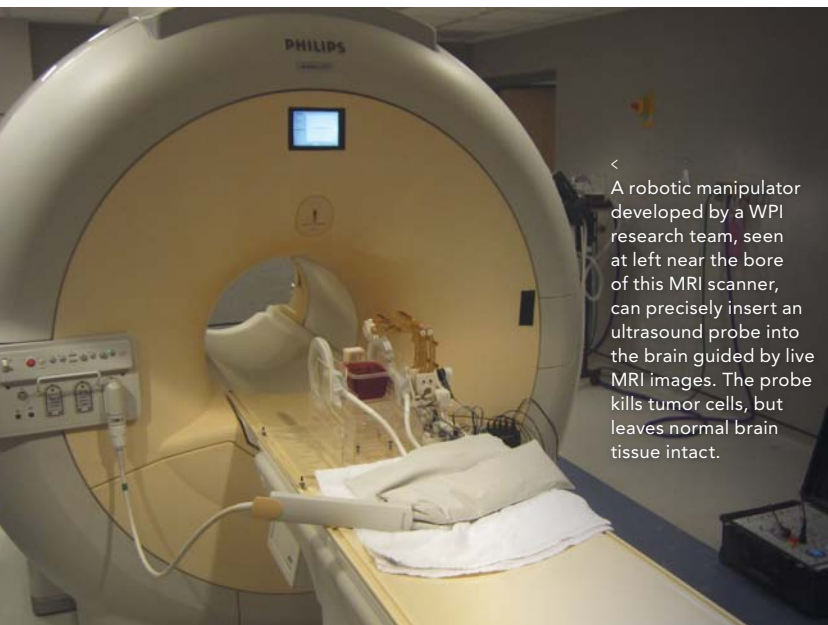

< A robotic manipulator developed by a WPI research team, seen at left near the bore of this MRI scanner, can precisely insert an ultrasound probe into the brain guided by live MRI images. The probe kills tumor cells, but leaves normal brain tissue intact.

> TARGETING BRAIN CANCER WITH A REMARKABLE ROBOT

TYPICALLY, PATIENTS WITH BRAIN TUMORS receive one of two courses of treatment, both of which have important limitations. Stereotactic radiation surgery, in which a radiation beam is focused on the tumor, is noninvasive and can increase survival, but it may take multiple treatments to relieve symptoms and it is difficult to confirm that the tumor has been destroyed. Open-brain surgery provides quick relief of symptoms and tissue samples for lab testing, but it is highly invasive and can lead to serious complications.

Gregory Fischer, PhD, assistant professor of mechanical engineering and robotics engineering and director of WPI's Automation and Interventional Medicine (AIM) Laboratory, thinks there's a better way. With a five-year, \$3 million R01 award from the National Institutes of Health (NIH), Fischer is leading a multi-institution research team developing an innovative treatment system that marries a probe



A BURNING QUESTION: WHAT TO DO WITH ARCTIC OIL SPILLS

OIL COMPANIES HAVE SPENT BILLIONS OF DOLLARS in recent years exploring the Arctic, which the U.S. Geological Survey estimates may contain 90 billion barrels of undiscovered oil—enough to meet global demand for nearly three years. But as the industry rushes to find and drill for that crude, a troubling question remains unanswered: what will happen if there is a major spill?

It may be all but impossible to get clean-up equipment to locations known for treacherous terrain and harsh weather. In fact, the best way to remove the oil (and avert an environmental catastrophe) may be to burn it in place, but little is known about the effects of low temperatures and icy surfaces on how oil will spread or burn.

To help answer those questions, the U.S. Department of the Interior awarded a one-year, \$400,000 grant to a research team led by **Ali Rangwala**, PhD, associate professor of fire protection engineering, to conduct the first laboratory study of the effects



of cold and ice on oil fires. The team first observed the burning behavior of liquid fuels in cavities carved into small blocks of ice that were chilled to temperatures as low as -30 degrees Celsius in a specially designed environmental chamber.

They found that the heat of the fire causes the ice cavity to evolve in shape as the fire burns. They also studied how liquid fuels spread on a sheet of ice and how they burn while moving through an ice channel. They found that the thickness of the oil affects how efficiently it burns, with thinner oil layers being unable to retain enough heat to sustain a flame.

The research team next conducted large-scale experiments in WPI's new state-of-the-art Fire Protection Engineering Laboratory at Gateway Park. They burned fuel oil in the center of a large ice sheet and measured heat flux, heat release rates, and other key parameters. The data from the small- and large-scale tests will be used to create a predictive model of the spread and burn rate of oil on ice. The researchers hope the model will prove useful to governments and oil companies that may face a situation in which burning oil in an icy environment is the only way to prevent a spill from becoming an environmental nightmare.



Fire Protection Engineering graduate students pour oil into the center of a large ice sheet in preparation for a burn test in WPI's new Fire Protection Engineering Laboratory. The test was part of a groundbreaking project to determine if oil spills in the Arctic can be burned in place.

that can destroy tumors with ultrasound and a robotic manipulator developed in Fischer's lab that can operate within the bore of an MRI (magnetic resonance imaging) scanner. It's an approach that is expected to offer a significant improvement over current treatments.

The robotics technology that will be used in the brain cancer system builds on Fischer's pioneering work with MRI-guided surgical robots, including a robotic system for use in diagnosing and treating prostate cancer funded by the Congressionally Directed Medical Research Programs and the NIH.

In the current project, Fischer's team will develop and clinically test a new robotic device specifically designed to guide an ultrasound probe through a dime-sized opening in the skull to the proper location in the brain, all under live MRI guidance. Developed by industry collaborator Acoustics MedSystems Inc., the probe can emit interstitial high-intensity focused ultrasound energy in a highly directional manner so only malignant tissue is heated and destroyed, even with irregularly shaped deep tumors.

The ultrasound therapy will be performed with live MR thermal imaging; MRI scanners are able to detect temperature changes in tissues. The images will be used to monitor which tissues are being heated and enable physicians to interactively adjust the output of the ultrasound tool.

"MRI is an excellent imaging modality for many conditions," Fischer says, "but to date there has been limited success in harnessing this modality for the guidance of interventional procedures."

Other collaborators on the project include **Reinhold Ludwig**, PhD, professor of electrical and computer engineering at WPI, who will develop specially designed head coils to enhance the brain imaging; Julie Pilitsis, MD, PhD, associate professor of surgery in the division of neurosurgery at Albany Medical College, who will serve as the lead clinical advisor; and Matthew Gounis, PhD, associate professor and co-director of the Advanced MR Imaging Center at UMass Medical School, who will bring expertise in MRI imagery and coordinate clinical tests of the robotic treatment system.

> GREEN BUILDING PRACTICES RAISE FIRE SAFETY CONCERNS

IN RECENT YEARS, the construction industry has enthusiastically adopted a wide array of “green” technologies and materials, from lightweight engineered lumber to rooftop solar panels. But while sustainable construction practices foster energy efficiency and more judicious use of natural resources, there is reason to believe that some of them may make buildings more vulnerable to fire, may make it possible for fires to burn hotter or spread faster than they would with conventional building practices and materials, or may result in increased risk and danger to firefighters.

In 2012 a research team led by **Brian Meacham**, PhD, associate professor of fire protection engineering at WPI, under a commission from the Fire Protection Research Foundation, the research arm of the National Fire Protection Association, undertook a comprehensive survey of the fire safety implications of green buildings. They conducted a global literature search and surveyed agencies around the world to assemble and assess a list of 78 green building elements that could have implications for fire safety.

Photovoltaic panels generate green electricity, but a solar array on a building’s roof will readily burn and may continue to produce electricity as long as the sun is out, posing an electrocution hazard for firefighters. Adding more insulation to a wall can help increase energy efficiency, but some insulation materials can burn, potentially adding fuel to a fire. Fire retardant chemicals may be added to insulation materials to reduce fire hazards, but some can have adverse health effects. “Finding the right balance between sustainability and safety is not always easy,” Meacham says.

The team’s report, “Fire Safety Challenges of Green Buildings,” as well as presentations made by Meacham before national meetings of the National Fire Protection Association, the U.S. Fire Administration, and other organizations, spurred considerable



The threat of electrocution from thousands of solar panels on the roof of the Dietz and Watson warehouse in Delano, N.J., slowed efforts to fight a 2013 fire. Photovoltaic arrays are one of many green building features and practices that raise fire safety concerns, research by WPI fire protection engineer Brian Meacham shows. (Photo by the Star-Ledger, Newark, N.J.)

discussion and pointed to the need for additional study. That continuing work can now get under way, thanks to a \$1 million award from the Department of Homeland Security (Meacham will lead the new project with co-principal investigator **Nicholas Dembsey**, PhD, professor of fire protection engineering). The grant will fund a multi-pronged research effort aimed at quantifying fire hazards and risks associated with green building features, identifying ways to mitigate those hazards and risks, and better preparing the fire service to fight fires in buildings with green features and elements.

Among other tasks, the researchers will explore ways to collect data nationally about fire incidents involving green building elements, particularly those resulting in firefighter injury or death, and they will investigate potential changes to firefighting tactics that may be more effective with buildings employing green construction technologies. They will also seek to quantify the increased fire risks or decreased fire performance associated with green building features by reviewing existing experimental and test data and by conducting burn tests in WPI’s new Fire Protection Engineering Laboratories at Gateway Park. These will include large-scale tests of building envelope and structural systems and evaluation of natural versus mechanical ventilation in atria and large spaces.

> GO FLY A KITE — UNDERWATER! IT’S A GREAT WAY TO GENERATE POWER

UNSEEN, UNDER THE WAVES, winding along coastlines and streaming through underwater channels, are countless currents and tidal flows that bristle with kinetic energy. And just as wind turbines can convert moving air into electricity, there is the potential to transform these virtually untapped liquid “breezes” into vast amounts of power.

That is the vision behind a new research program directed by **David Olinger**, PhD, associate professor of mechanical engineering, who has received a three-year, \$300,000 grant from the National Science Foundation to explore ways to harness ocean currents using an unexpected technology—the kite. The research builds on several years of work, funded by the NSF and the U.S. Environmental Protection Agency, to develop systems that use kites to generate power from the wind.

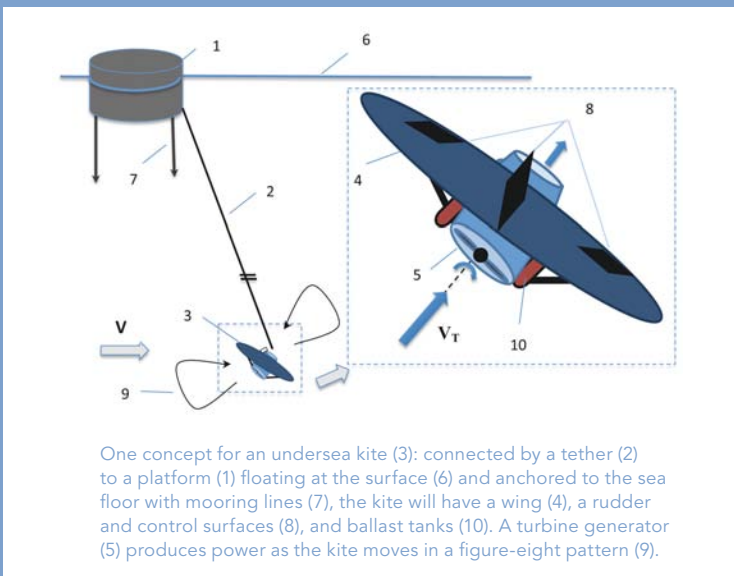

One concept for an undersea kite (3): connected by a tether (2) to a platform (1) floating at the surface (6) and anchored to the sea floor with mooring lines (7), the kite will have a wing (4), a rudder and control surfaces (8), and ballast tanks (10). A turbine generator (5) produces power as the kite moves in a figure-eight pattern (9).

> HARVESTING A SIMPLER, MORE EFFECTIVE TREATMENT FOR MALARIA

IN MEDICINE AS IN LIFE, sometimes simpler is better. That's the philosophy that is driving the current research of **Pamela Weathers**, PhD, professor of biology and biotechnology at WPI. It's an approach that may produce a more economical and effective treatment for one of the most prevalent and deadly infectious diseases of the developing world: malaria.

For more than a decade, Weathers has been working with a plant that produces a compound that is the only remaining effective treatment for malaria, a mosquito-borne parasitic infection that afflicted nearly 220 million people in 2010, according to the CDC. The plant is *Artemisia annua* (commonly known as sweet annie or sweet wormwood), and the compound is artemisinin.

The process of extracting artemisinin from the sweet annie plant, purifying it, and packaging it as a pharmaceutical (particularly when the compound is combined with other antimalarial drugs to make it less prone to resistance) is expensive, and the drug is



frequently in short supply. In her recent research, Weathers has been exploring a novel way to turn the *Artemisia annua* plant, itself, into a medication, which would bypass the need for the costly extraction process and generate a number of other benefits.

For example, using the dried leaves could greatly expand access to antimalarial therapy, Weathers says. "*Artemisia* can be grown readily in most climates," she says. "It is a relatively simple process to harvest the leaves, pulverize them, test samples for their potency, measure out doses, and put them in capsules or make tablets. This could become the basis for local businesses and would be a wonderful socioeconomic stimulus in developing countries."

In addition to making a potent malaria treatment more widely available for a lower price, using the dried leaves may produce a treatment that does a better job of combating the malaria parasite than purified artemisinin, as Weathers and colleagues at the University of Massachusetts reported recently in the *Journal PLOS ONE*. They found that powdered dried leaves from *Artemisia annua* delivered 40 times more artemisinin to the blood and reduced the level of parasite infection more completely in mice. The effectiveness of the dried leaves may be due, in part, to the presence in the leaves of other compounds, including some flavonoids and monoterpenes, also known to have antimalarial abilities.

This fall, Weathers (◀far left) and her students harvested a new crop of *Artemisia annua* from a plot on a farm in Stow, Mass., and then hung it in a greenhouse to dry. The plant will become the raw material for ongoing work in the Weathers lab and will bring the dream of a powerful, cost-effective, widely available—and simple—malaria treatment closer to reality.

Olinger's interest in kite power began when he came across papers from the 1970s that proposed using kites for electricity generation. He advised undergraduate project teams that developed a prototype system consisting of a large kite connected by a long tether to a rocking arm. The arm's up-and-down motion is transferred through a linkage to drive a simple water pump. The system is currently being tested at Heifer International's Heifer Farm in Rutland, Mass. Olinger says the low-cost system would be an ideal way to provide power to remote villages in developing countries.

With NSF funds, Olinger and a team of graduate students have developed computational models that can predict trajectories and power output for kites of different sizes and kite tethers of different lengths. The models help design kites that can fly in stable, high-speed figure-eight patterns under changing wind conditions. Those algorithms will now be applied to the design of kites that can "fly" in underwater currents. "Instead of moving air, you have moving water and the kites have rigid wings," Olinger says, "but the same physical principles apply."

Olinger and his team will study the benefits of mounting turbine-generators directly on kites vs. tethering the kites to a generator. After evaluating various designs in the computer, they will build scale models and test them in large water flumes at the Alden Research Laboratories, a renowned hydraulics research facility just north of the WPI campus.

Whichever design works best, it will have important advantages over stationary marine turbines, which have been used on a limited scale in Europe, Asia, and North America to generate power from tides. For one, the generators can be smaller, since with the figure-eight motion the kite will move faster than the current, greatly amplifying its power output. The kites can be attached to floating platforms, making them cheaper to install than bottom-mounted turbines and easier to retrieve for maintenance.

As the world looks for new ways to wean itself from fossil fuels, a new answer may be emerging: go fly a kite!

> PROTECTING THOSE WHO SAFEGUARD US

A NEW EXHIBIT at the Smithsonian's National Air and Space Museum in Washington, D.C., covers the history of navigation. In one section, the exhibit addresses the challenge of navigating inside buildings. Next to a full-size photo of John Sullivan, deputy chief of the Worcester, Mass., Fire Department, is a Plexiglas case containing what looks like an ordinary walkie-talkie. But there is nothing ordinary about the technology behind that clear plastic. In fact, it represents the product of more than a decade of intensive research by a dedicated team of WPI engineers who dared to take on a daunting technological challenge.

The quest to develop a method for precisely locating and tracking people within structures, where the signals from GPS satellites don't reach, began after a December 1999 warehouse fire in which six Worcester firefighters died after becoming lost or disoriented. Alarmed at the lack of technology available to help firefighters do their jobs more safely, **John Orr**, PhD, then head of the Department of Electrical and Computer Engineering, joined with professor **David Cyganski**, PhD, and associate professor **James Duckworth**, PhD, to launch a research effort to meet this urgent need.

Working without funding at first (the field was too new to draw the interest of federal agencies), then later buoyed by a stream of federal awards from such agencies as the National Institute of Justice, the Department of Homeland Security, and the Federal



Pioneering indoor tracking technology for firefighters developed by a WPI research team is featured in a new exhibit on navigation at the Smithsonian National Air and Space Museum, below. The team continues to develop innovative technological solutions for the fire service, including a system, shown above, undergoing a test in the new WPI Fire Protection Engineering Laboratory, that will alert firefighters of the imminent danger of flashover.

Emergency Management Agency, the team developed a pioneering system that uses radio frequency transmitters and receivers and complex algorithms to pinpoint firefighters in three dimensions. In recent work, the team has integrated the radio location system with inertial navigation technology to further increase its reliability and accuracy.

Building on that success, Cyganski and Duckworth have addressed other technological needs of firefighters. With a major award from FEMA, they have developed a device that can detect the imminent onset of flashover—a deadly event which causes everything in a room to ignite at once. With an additional FEMA award they have developed and tested a device that will alert firefighters to the presence of toxic gases like carbon monoxide and hydrogen cyanide. **Kathy Notarianni**, PhD, professor and head of the Department of Fire Protection Engineering, has been a co-principal investigator on the flashover and toxic gas sensor studies.

At every stage of the research, the researchers have worked closely with firefighters, particularly the men and women of the Worcester Fire Department. First responders have also played a vital role in a series of annual workshops on indoor location that Duckworth and Cyganski have organized since 2006. Funded in recent years by the Department of Homeland Security's Science and Technology Directorate (DHS S&T), the meetings have included demonstrations of prototype location technology (WPI's technology was part of the first test in 2008; the 2012 test focused on the GLANSER, or Geospatial Location Accountability and Navigation System for Emergency Responders, technology funded by the DHS S&T). The workshops have been widely credited with helping accelerate the development of technology for firefighters.

In recognition of their pioneering research, Orr, Cyganski, Duckworth, and Notarianni received the 2012 State Fire Marshal's Award at the 23rd Annual "Firefighter of the Year" award ceremony at Mechanics Hall in Worcester. Presented by Massachusetts Governor Deval Patrick, the award recognizes significant contributions to the fire service made by those outside the service.



art^{of}science

AS YOU ENTER the Life Sciences and Bioengineering Center at WPI's Gateway Park, one of the first things you'll notice is an art gallery. The works are all by scientists and engineers—students, faculty members, and staff who work in the center's laboratories and imaging facilities—and the subject is science. The exhibit features the winners of the annual "Art of Science" contest; contest entries must represent life sciences research at WPI. Here is a sample of the 2013 contenders.

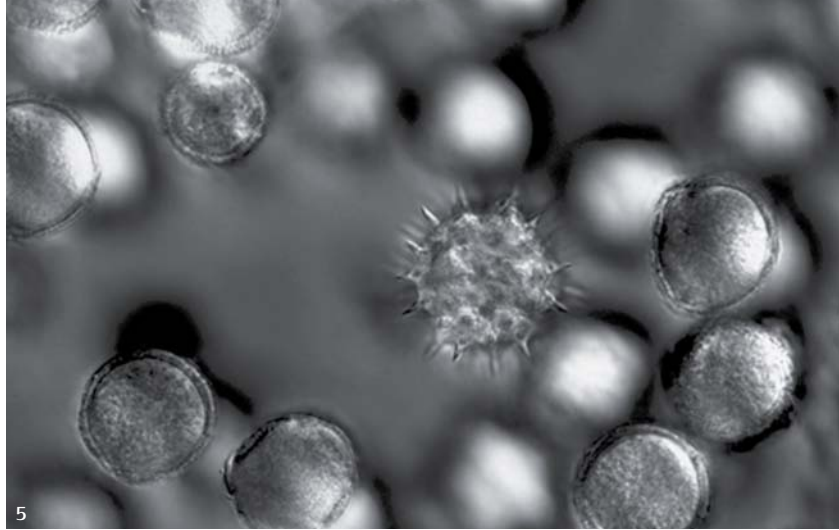
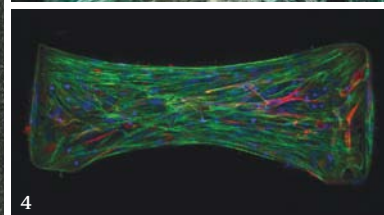
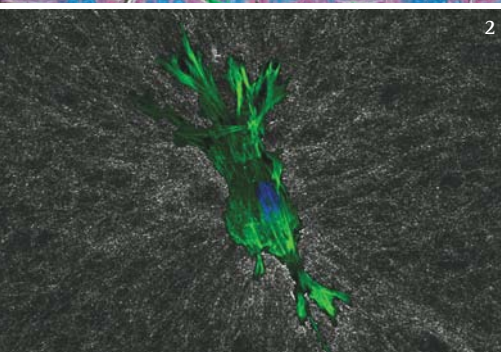
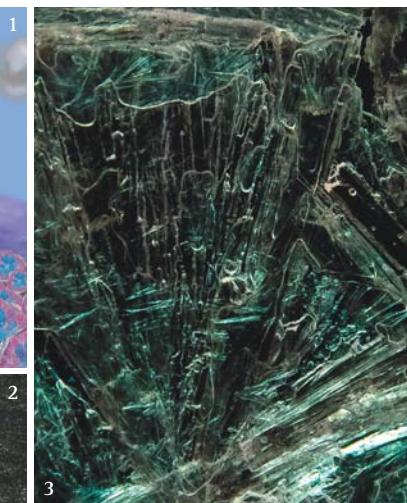
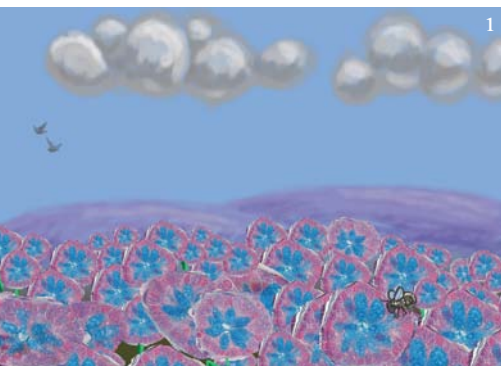

The most beautiful experience we can have is the mysterious — the fundamental emotion which stands at the cradle of true art and true science. —Albert Einstein

1 > Rat Gut Flowers

Zoë Reidinger
PhD Candidate, Biomedical Engineering

Reidinger says this pastoral scene started out as an alcian blue stain of rat intestines taken on an inverted microscope. The stain turns polysaccharides blue; when she noticed that the microvilli in the intestines resembled flowers, she completed the scene in Photoshop, adding clouds and a buzzing bee with the help of Will Ryan.

2 > Cell 'n Gel

Kristen Billiar
Associate Professor of Biomedical Engineering

This view of a human lung fibroblast cultured on a fibrin gel was taken to see how far a cell can "feel" through the body's fibrous extracellular matrix, Billiar says. The cells were captured with a confocal microscope in standard fluorescence mode while the fibers were imaged in confocal reflectance mode.

3 > Recrystallized Benzophenone in Acetone

Morgan Stanton
PhD Candidate, Chemistry and Biochemistry

"In my lab," Stanton writes, "if I let my benzophenone sit out overnight, large, delicate crystals form by morning." She captured this image of the crystals with a Nikon D70 digital camera using ambient light.

4 > Pig Heart Valves in Fibrin Gel

Mehmet Hamdi Kural
PhD Candidate, Biomedical Engineering

Kural captured this image of cells from pig heart valves using a Leica TCS SP5 Point Scanning Confocal Microscope. It will appear in the journal *Biomaterials* (Kural and Billiar, 2013, accepted).

5 > Pollen Grains

Victoria Huntress
Microscopy/Imaging Technology Manager
Life Sciences and Bioengineering Center

Taken at 40 magnification with a Zeiss Aviovert 200M, an inverted microscope, this image of pollen grains is, Huntress says, a "perfect example of art in science. Who knew that pollen grains could be beautiful as well as irritating?"

6 > Drosophila melanogaster

Daniel Valerio '13
Interdisciplinary Major in Biological Illustration

Valerio designed his own major, which combined his passions for art and biology. For his Major Qualifying Project, he illustrated professor Joseph Duffy's research on the transmembrane protein Kekk-6, work conducted with fruit flies. This illustration was created with Photoshop.

A close-up photograph of a man with short brown hair and a slight smile, wearing a blue button-down shirt. He is positioned behind a large, vibrant red rose. The background consists of out-of-focus green trees under a bright sky. A decorative dotted yellow line forms a circular shape around the author's name and another shape around the title.

BY JOAN KILLOUGH-MILLER

Hive Mind

Biologist Robert Gegear studies how bumblebees make decisions. That matters, he notes, because what happens in the mind of a bee affects the success of a \$1 billion industry and the future of Earth's ecological diversity.

PHOTOGRAPHY BY PATRICK O'CONNOR AND STEVEN KING





What goes on in the brain of a bumblebee might seem like a small matter — but to Robert Gegear, assistant professor of biology and biotechnology, it's a billion-dollar question. And it's a question with profound economic and ecological consequences, since a large portion of the world's food supply depends on the work of these tiny pollinators. Gegear is one of the few scientists in North America studying the foraging behavior of bumblebees. Drawing on the disciplines of cognitive psychology, neurobiology, genetics, and ecology, he looks at questions first asked by Aristotle. The answers may be vital to the survival of all species.

As a bumblebee browses in a field of flowers, it's making surprisingly complex calculations about which flowers are worth a visit. At the same time, plants are putting on a show, with scents and appearances designed to attract the bee. The bee has a single goal — to maximize energy intake (in the form of nectar and pollen) to nourish its colony. (*Feed me!*) Plants can't think or act, but they continue to evolve in ways that favors pollination and reproduction. (*Choose me!*) Gegear is interested in how the interplay between these two forces has shaped the brains of bees and created magnificent diversity in flowers.



In his lab, Gegear conducts experiments with plastic flowers that he can selectively fill with nectar to observe how bees make choices about which flowers to visit and in what order. He has shown that bees have a high degree of mental flexibility that enables them to learn from prior experiences and maximize the amount of food they take back to the hive.

How smart are bees? It's long been known that they can remember sensory information, and it's easy to demonstrate how quickly they can learn the characteristics of flowers that yield the best payoff. In fact, it takes only one or two trials to teach a bee to associate a particular petal shape or color with a sweet sucrose reward. Some bees learn special tricks to release the petals of locked flowers, or to crawl deep inside a bloom to get at nectar hidden in a mazelike structure. "They're not born knowing how to do this," Gegear says, "but through trial and error they will figure out and remember very complex motor patterns."

BEE-HAVIOR AND BIOLOGY

By observing pollinators in the wild and documenting their responses to controlled environments, Gegear has mapped the economics of their energy-gathering enterprise. In the lab, he constructs arrays of potted or artificial flowers to analyze what happens when bumblebees pit factors such as nectar volume or concentration against the "costs" of travel time and energy. It turns out that bees are quite skilled at deciding when it's beneficial to specialize in high-yield flowers, and when it pays to fly farther afield to visit a larger number of plants.

With Bayesian modeling, Gegeer has shown that bees have the capability to apply prior learning to current conditions to make effective decisions. As the environment changes, they will alter their foraging strategy to get the best profit. “It’s not a simple stimulus response-driven behavior,” says Gegeer. “If it were, we would see bees choosing rewarding flowers as they are encountered in the environment. But they don’t do that. Rather, bees are utilizing much more complex executive control functions that afford them a wide range of innovative solutions to behavioral problems. Our results demonstrate that natural selection has equipped bumblebees with a high degree of mental flexibility, which enables them to maximize energetic return under rapidly changing and highly unpredictable ecological conditions.”



There is a downside to such floral multitasking, and it’s called the “switch cost.” Bees must slow down each time they change between foraging tasks; psychologists observe the same lapse when humans subjects are asked to alternate between different numeric tasks. Gegeer has found that bees will limit the frequency of task switches in order to minimize switch costs. Investigating these mental processes in the foraging life of the bee could help us better understand our own behaviors, he says.

The small brain of the bee, which consists of just a few hundred thousand neurons, is an excellent learning tool, says Gegeer. For even without a pre-frontal cortex (which is where such high-level cognitive processes are thought to be housed in humans), bees are capable of mental functions that were once thought to separate human intelligence from all other animals. “As a model system, the bee brain is similar to the human brain, but it is far simpler and more accessible. If we can understand the psychological and neurobiological basis of mental plasticity in the bee, it may provide clues to how our brains work.”

ARE PLANTS RUNNING THE SHOW?

A bee’s tendency to specialize in certain flowers — first described by Aristotle — is still not understood. “Darwin struggled with this,” notes Gegeer, “because it didn’t seem to make adaptive sense. Why would the pollinators make decisions that seem to benefit the plant, but not themselves?” The evolutionary purpose of floral complexity is also unclear.

“Since Darwin,” says Gegeer, “much of the research in this area has focused on the relationship between flower color and type of pollinator (birds, bees, butterflies). But if all it takes is a color to attract a pollinator to a flower, then why do flowers look and smell the way they do? Why are there hundreds of thousands of flowering plants, each with a unique flower?”

“As a model system, the bee brain is similar to the human brain, but it is far simpler and more accessible. If we can understand the psychological and neurobiological basis of mental plasticity in the bee, it may provide clues to how our brains work.”



Gegear and PhD candidate Melissa Mobley are studying the effects of commonly used pesticides on bees' mental agility; the chemicals appear to compromise the insects' ability to forage and pollinate plants, a serious concern since those plants provide one-third of the world's food supply.

Gegear proposes that plants, through the evolution of diverse traits, are actually manipulating the bees and other pollinators toward specialization — shaping their brains and behavior in ways that benefits the plant. “Bumblebees are, by nature, generalists; they’ll visit any flower as long as it has nectar or pollen. All they care about is getting as much as they can per unit of time.” But less switching between species is better for the plants, because mixing pollen interferes with fertilization. “So there is co-evolution — but there is also conflict.”

His research shows that increased floral complexity substantially increases the cost of switching among different flowers. This makes adopting a more specialized foraging strategy a better economic option for the bee. “In this way, floral specialization makes perfect adaptive sense from the bee’s perspective,” Gegear says. “This work on mental flexibility in bees has also provided valuable insight into the adaptive function of floral complexity in plants.” Gegear is currently working with Elizabeth Ryder, associate professor of biology and biotechnology, on computer models they hope will help identify key factors that drive the emergence and persistence of sophisticated cognitive abilities in the bee brain and elsewhere in the natural world.

POLLINATORS IN PERIL

While natural selection has shaped the cognitive skills that have helped bumblebees survive, unnatural factors, including man-made chemicals, may be compromising those abilities and threatening the insects' long-term prospects. To help understand the possible connection between environmental stressors and recent declines in bee populations,

Gegear is studying the effects of commonly used systemic neonicotinoid pesticides on bees. He is also exploring the impact that pathogens in the bees' environment may have on them by stressing the bees' immune systems in a way that mimics infection.

He has demonstrated that “compromised” bees don't forage as effectively as control bees that haven't been exposed to pesticides or pathogens. The results indicate that exposure impairs mental flexibility, reducing the bees' ability to collect pollen and nectar, as well as other survival skills. “They basically become stupid,” Gegear says, “and that makes them inefficient foragers and more susceptible to predators. If the foragers can't bring back adequate amounts of nectar to sustain their colony and establish new ones, over time this will lead to population decline.”

The next step is to extend this work into the field and look at long-term effects of chronic exposure on wild bumblebee populations. “It's not enough just to set an acute lethal limit for these pesticides,” says Gegear. “In the wild, bees are visiting thousands and thousands of flowers in a day, each bearing a tiny bit of pesticide.” Over time, constant exposure to these neurotoxins could cause increased mortality in workers and reproductives (queens and males) or have indirect effects on colony survival through impaired cognitive function of foragers.

“Human-induced environmental change poses a serious threat to bumblebees and other pollinators worldwide,” Gegear says. “Many species are in decline and some are on the verge of extinction. If we don't figure out the cause of these declines soon, we will continue to lose pollinators. And if we lose all of our pollinators, we're in deep trouble.” ^{Re}



Palladium

By Amy Crawford



The U.S. Department of Energy is making a major investment in technology that may finally produce economical power from coal without spewing greenhouse gases into the atmosphere. The key may be an innovative membrane system invented at WPI.

PHOTOGRAPHY BY PATRICK O'CONNOR

AND

Black Gold

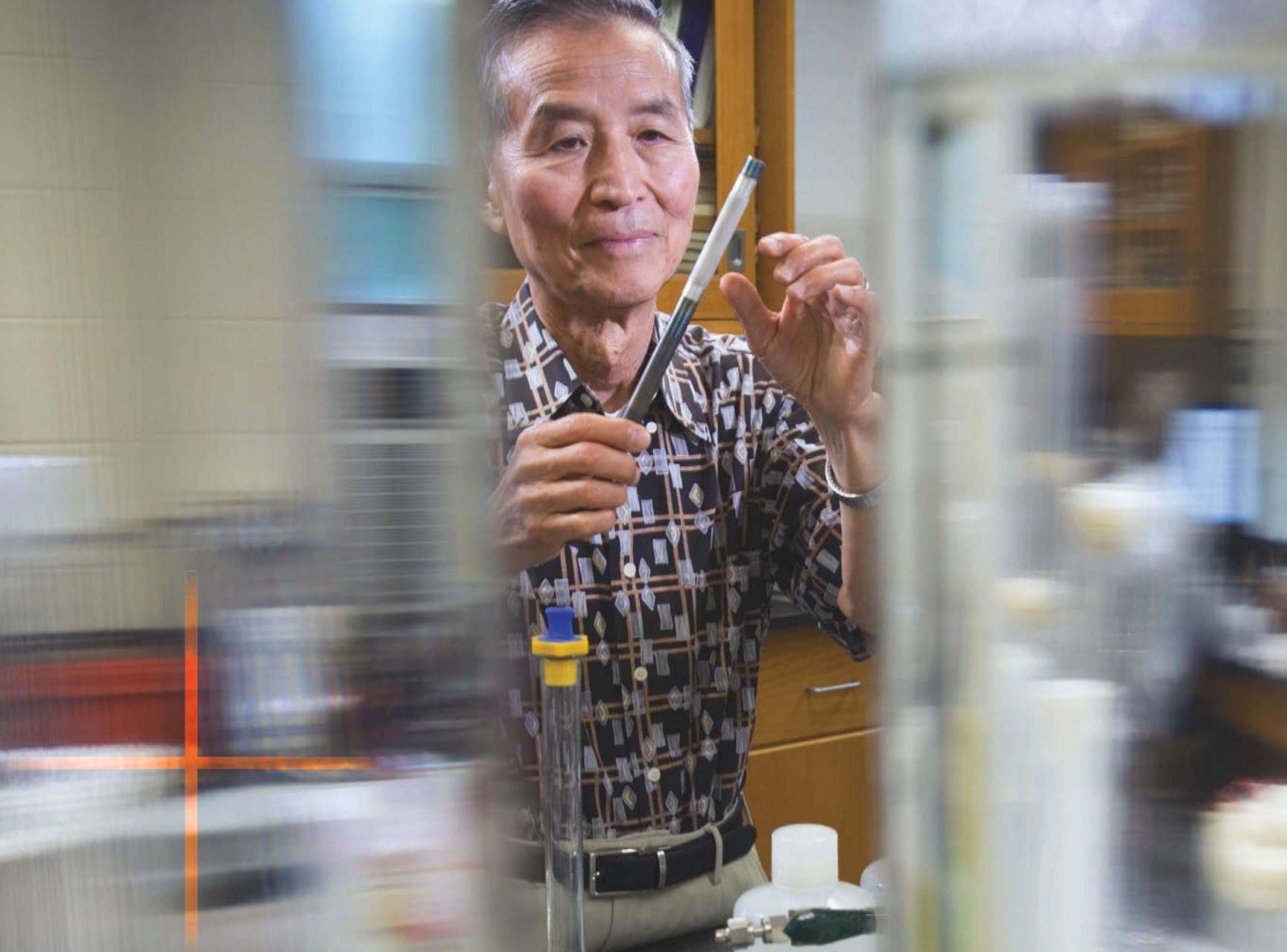

On the banks of the Coosa River in rural Alabama sits a power plant with three towering stacks spouting torrents of steam. Visited regularly by mile-long trains that unload coal onto an enormous black mountain, the plant looks like many other electric generating stations—the sort that spew greenhouse gases into the atmosphere and help accelerate global warming.

But this is the National Energy Technology Laboratory, an experimental plant where the U.S. Department of Energy (DOE) tests some of the most promising new ideas for producing cleaner power—including an inorganic membrane that is the product of more than a decade of groundbreaking research by chemical engineers at WPI.

“With global climate change being a potential issue, technology that promotes the efficient capture of CO₂ from power generation applications is critical,” says Bryan Morreale, the National Energy Technology Laboratory’s focus area lead for materials science and engineering. He calls WPI’s membrane “a revolutionary approach.”

The Alabama facility is home to the National Carbon Capture Center, or NCCC, whose mission is to find ways to derive energy from coal without letting greenhouse gases—primarily carbon dioxide, or CO₂—enter the atmosphere. It’s an exciting proposition, but it’s also fraught with challenges, not the least of which is how to capture carbon.

One approach is coal gasification. Rather than simply being burned, as happens in most coal-fired plants in the



“I think it’s very good material, good applications, good fundamental work. It will provide, hopefully, cleaner and less expensive energy.”

—Yi Hua “Ed” Ma

United States, coal can be heated while steam and oxygen (in quantities too small to support combustion) flow over it. The coal is oxidized, creating a gaseous mix of carbon monoxide, CO₂, water vapor, and molecular hydrogen (H₂). Through a process called the water-gas shift reaction, the carbon monoxide and water vapor (steam) can then be converted to more CO₂ and H₂.

In a final step, the hydrogen and CO₂ flow through a membrane system that separates the CO₂, which can be sequestered to keep it from reaching the atmosphere, and the hydrogen, a valuable chemical commodity that can be recovered and used to make chemicals like ammonia and methanol, help with petroleum refining, become the fuel used in fuel cells, or be burned to produce electricity.

Betting Big on a Membrane

The success and economic viability of the entire process hinges on the membrane, and the most efficient and economical option to emerge in recent years is one developed by Yi Hua “Ed” Ma, James H. Manning Professor of Chemical Engineering, and his research team in WPI’s Center for Inorganic Membrane Studies. Their patented membrane performed brilliantly in the first phase of a national demonstration project funded by the DOE. With a \$1.5 million award, WPI (the only university among the competitors) led one of four teams to pilot test their membrane systems. Two teams, WPI’s and one led by Praxair Inc., have moved on to the second and final phase, in which they will build modules made of multiple membranes that will be tested under real-world conditions. WPI’s module will be tested at the NCCC in a high-stakes experiment that could help pave the way for the clean power plants of the future.

“I think it’s very good material, good applications, good fundamental work,” says Ma, with characteristic modesty, of his lab’s crowning achievement. “It will provide, hopefully, cleaner and less expensive energy.”

Ma came to WPI in 1967 upon earning his doctorate at MIT. After founding the Center for Inorganic Membrane Studies in 1988, he spent more than a decade developing a membrane that uses a thin layer of the precious metal palladium (chemical symbol Pd), deposited on a porous stainless steel support, to tease hydrogen out of a blend of gases, including natural gas. The work on the innovation has been funded by more than \$12 million in grants from industry and government. In the current DOE-funded program, the WPI team is working to scale the membrane system up for a final large-scale test they hope will lead to commercialization.

“It would be an enabling technology, one of many technologies that are needed to really mitigate greenhouse gas emissions,” says Morreale, whose agency is funding WPI’s participation in the project’s second phase with a \$4 million award.

“I’ve followed Ed’s work for 10 or 15 years, and he’s doing a tremendous job,” Morreale adds. “I think he’s really made progress not only on the membrane that he’s developing but membrane technology in general.” Ma’s achievements have earned him a long list of national and international honors. He is a fellow of the American Institute of Chemical

H2

Engineers (AIChE), which presented him with its prestigious Institute Award for Excellence in Industrial Gases Technology. Sessions at an AIChE annual meeting and an issue of the *Journal of the Taiwan Institute of Chemical Engineers* have been dedicated to him. From November 2013 to March 2014, he will serve as Cox Visiting Professor in the Department of Energy Resources of Stanford University.

A Patented Hydrogen Filter

At one end of Ma's Goddard Hall lab, which is stocked with canisters of hydrogen, Erlenmeyer flasks, and tall graduated cylinders filled with colorful solutions used to fabricate the membranes, sits an unassuming apparatus of pipes and tubes, hooked up to a computer. The system, explains Ivan Mardilovich, a research associate professor who has worked in the lab since 1999, is pumping hydrogen through a porous steel tube plated with a thin layer of palladium, a rare element that resembles platinum and is also used in jewelry. This obscure transition metal is the key to the entire enterprise.

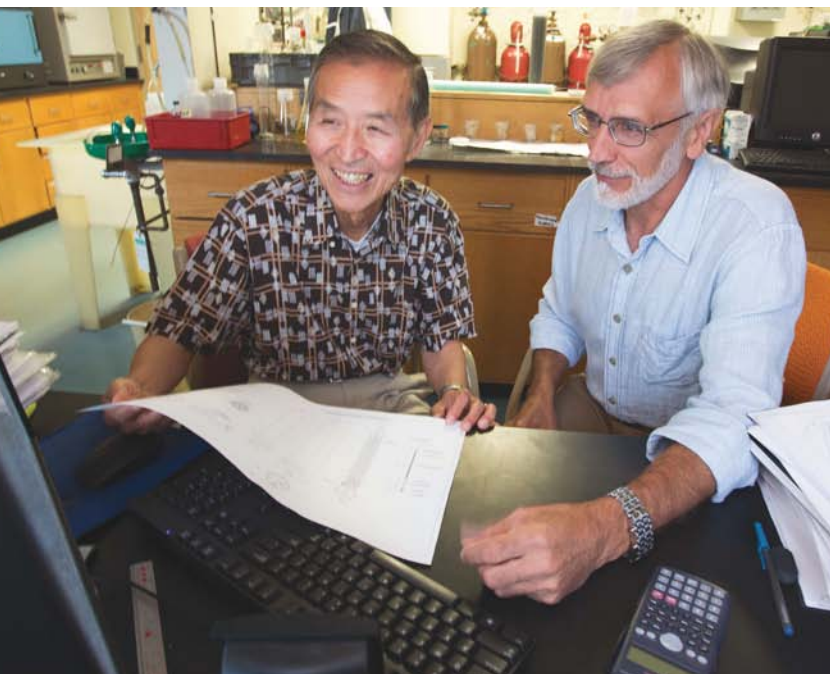

"It's pretty simple," Ma says. "Palladium has a specific property that will dissociate molecular hydrogen into atomic hydrogen, which is significantly smaller."

A membrane is a semipermeable barrier through which different gases or liquids move at different rates. The membrane allows some molecules to pass through easily while others make the journey slowly or are prevented from crossing. WPI's palladium membrane is engineered to allow only atomic hydrogen to pass through, while other gases—including CO₂—stay on the other side.

In practice, the tube-shaped membrane is placed inside a larger tube (see diagram, page 21). A high-pressure mixture of H₂ and CO₂ flows into the outer chamber. Adsorbing on the palladium surface, the molecular hydrogen dissociates

< Ed Ma and Ivan Mardilovich, research associate professor of chemical engineering, review the output of computational models that help Ma's research team in the Center for Inorganic Membrane Studies develop and evaluate designs for palladium membranes.

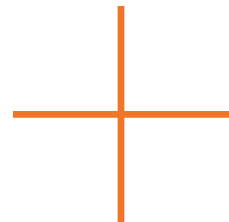

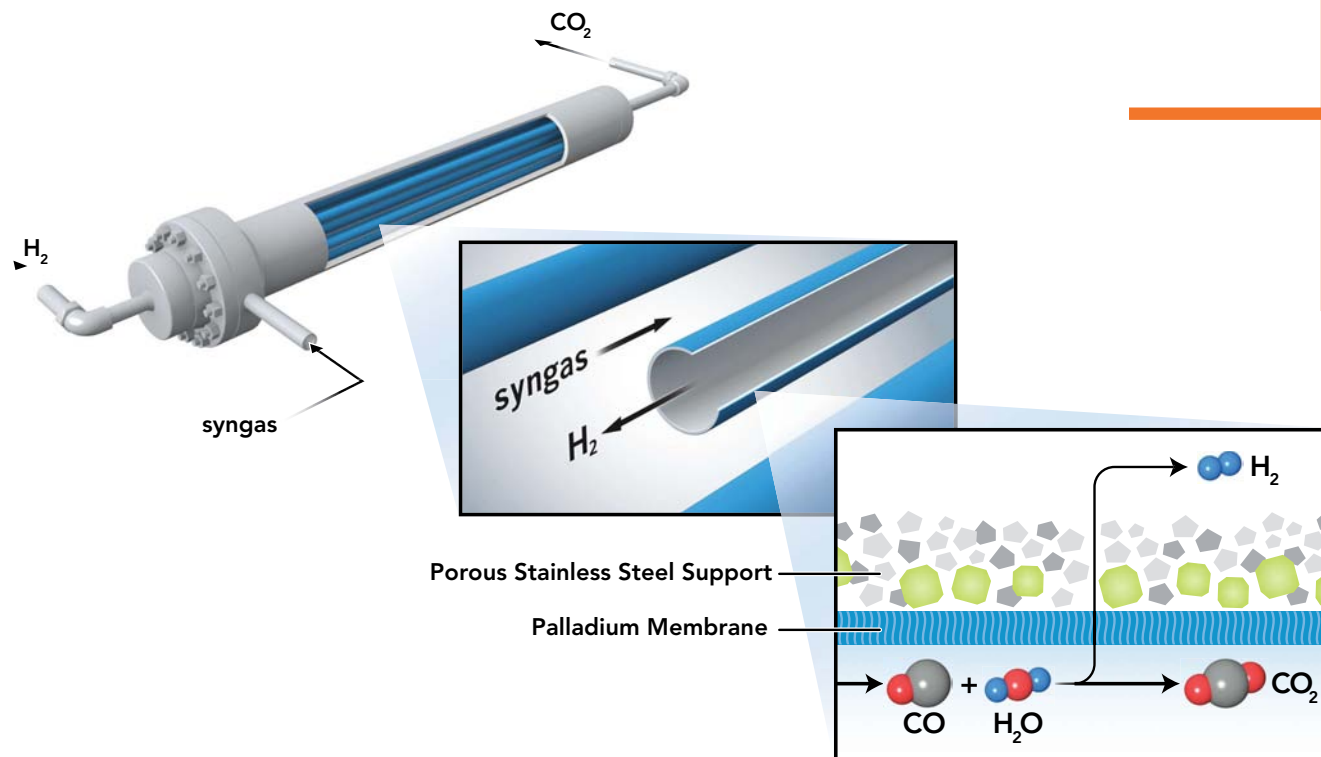

ILLUSTRATION BY CURTIS SAYERS

^
 The modules that Ma and his team are developing for the U.S. Department of Energy will contain between seven and 37 individual membrane tubes. Syngas, a mixture of hydrogen, carbon monoxide, carbon dioxide, steam, and impurities that is produced by the coal gasification process, is delivered to the outside of the membrane tubes. Through what is known as the water-gas shift reaction, the carbon monoxide and steam are converted to hydrogen and carbon dioxide. The palladium layer on the outside of the membrane tube dissociates the molecular hydrogen into atomic hydrogen, which is able to move to the interior of the tube and recombine into molecular hydrogen. The hydrogen, between 20 and 25 pounds per day, is collected for use as a fuel or a chemical feedstock, or, in pure form, for use in fuel cells. The carbon dioxide, unable to permeate through the membrane, exits through a separate port at high pressure and is sequestered.

into two hydrogen atoms. Just small enough to pass through the palladium lattice, the atoms are driven through the membrane to the interior of the membrane tube, where the pressure is lower. There they recombine into H_2 , release from the surface, and are captured. Unable to permeate through the membrane, the CO_2 , still at high pressure, continues on to be stored.

Palladium is expensive, Ma acknowledges, but his team keeps the cost of the membrane down by depositing a very thin layer (just 5- to 10-microns thick) to the porous stainless steel support using an electroless plating process (which uses autocatalytic reactions rather than electricity). The steel gives the palladium membrane mechanical strength and

enables it to be thinner and more easily integrated into other parts of the process than if it were deposited on a ceramic base (which is standard practice with such membranes).

To keep the steel from contaminating the palladium at high temperatures, the WPI researchers developed a method for building up a protective oxide layer between the metals. For some membranes, they also apply a thin layer of gold, using electrodeposition, to protect the palladium from trace amounts of hydrogen sulfide (H_2S) in the gas mixture. The methods they developed for building the membrane on porous steel, the products of years of meticulous research, are the basis for most of the seven patents the innovation has earned over the years.

CO_2



POD

A Metallic Advantage

The system has proven astonishingly effective. In phase one of the DOE trials, the WPI membrane achieved an H₂ purity level of 99.89 percent during the entire 200-hour test period, a level that had never been seen before with coal gas. In a paper published last year in the *International Journal of Hydrogen Energy*, the research team called it “a breakthrough” — not a term scientists use lightly.

“There is no material in nature more efficient in separating hydrogen than palladium,” says Andreas Matzakos, principal concept engineer at Shell Oil Company, which sponsored the WPI work for seven years and is now using the WPI technology to produce hydrogen for cars powered

by fuel cells. Calling the research “brilliantly executed,” he added, “Moreover, it can stand the temperature found in common reactors, and it enables process intensification: the ability to do more steps in a smaller volume.”

Matzakos is referring to another advantage of the metallic membranes that WPI has developed. Unlike polymer membranes, which are also used for gas separation, the metal structures can sustain the high temperatures needed for coal gasification and natural gas reforming, a process for extracting hydrogen from methane. When using organic membranes, on the other hand, the gas must be cooled before it can be separated.

“That’s energy loss,” Ma notes. “That’s cost.”

The membrane’s heat tolerance is what appeals to Praxair, the largest producer of industrial gases in the Americas and one of the largest hydrogen producers in the world, which is hoping to commercialize WPI’s technology for use in hydrogen production. Raymond P. Roberge, senior vice president and chief technology officer at Praxair, says the membrane’s ability to function at higher temperatures will make it much more economical than conventional technology, which requires many separate steps.

“Researchers have been looking for methods to cleanly separate hydrogen from other gases at high temperature for some time with limited success,” says Roberge, a 1972

“There is no material in nature more efficient in separating hydrogen than palladium. Moreover, it can stand the temperature found in common reactors, and it enables process intensification: the ability to do more steps in a smaller volume.”

chemical engineering graduate of WPI. “This technology has the potential to have a substantial impact on a number of manufacturing processes.”

The large-scale palladium membrane module that will be tested at NCCC is capable of producing up to 25 lbs. of hydrogen a day, 10 times the amount generated in the phase one tests. It’s being manufactured by a WPI partner, British company Johnson Matthey, which is licensing the technology. Other partners include California-based Membrane Technology and Research Inc. and T3 Scientific, a Minnesota-based company founded by one of Ma’s former students.

“It’s always difficult going from a laboratory to a real-life situation,” says the DOE’s Morreale. “But I think, if

successful, it could have tremendous impact, not only in the power sector, but also in the chemical sector.”

Whether it will help in the fight against climate change may come down to economics, however. For now, without a tax on carbon emissions, it remains cheaper for power plants to send greenhouse gases into the atmosphere.

Ma says that although some chemical and gas companies, including Johnson Matthey and Praxair, are licensing the technology, the government may have to provide the energy industry with incentives to embrace high-tech solutions like WPI’s membrane. “We have a lot of good science out there, but economically it has to work,” he says. “As an engineer, that’s always part of the equation.” 

Ma and Liang-Chih “Stanley” Ma, a PhD candidate in chemical engineering, demonstrate the multi-stage electroless plating process used to deposit a thin layer of palladium onto porous stainless steel to create a membrane. The process is the basis for most of the seven patents the innovative membrane has been awarded over the years. Opposite page: the finished membranes; the light area in the middle of each membrane is the palladium coating.

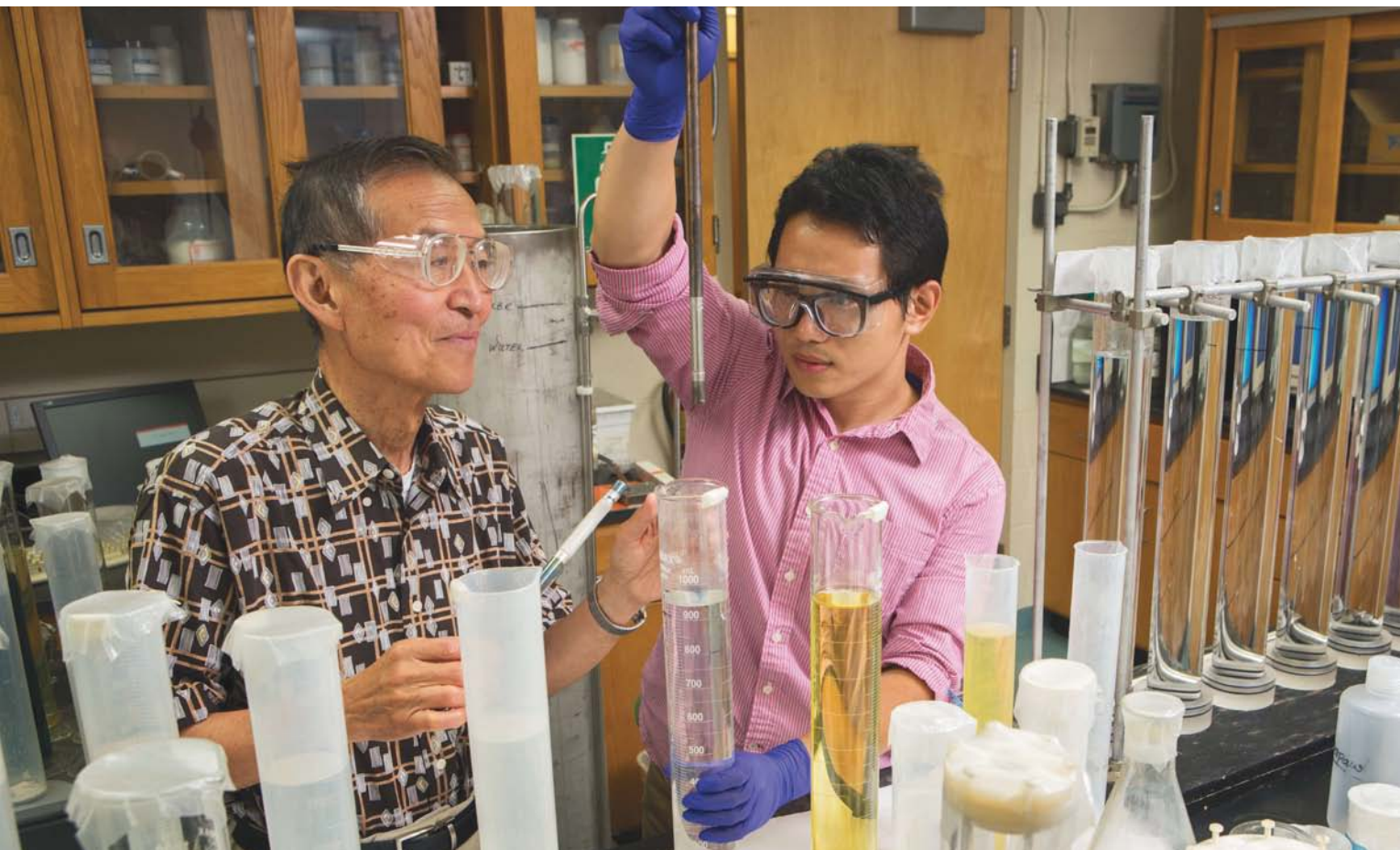



Building a Winning Academic Team

By Kate Silver

Photography by Patrick O'Connor and Dan Vaillancourt



WPI's head talent scouts:
from left, Karen Kashmanian Oates,
Mark Rice, David Cyganski, and
Eric Overström.

As in baseball, recruiting star faculty members requires a good eye for talent, good negotiating skills, and a willingness to invest for the long term.



Dirk Albrecht*
(for Asst. Prof., Biomedical Eng.)

- Ph.D. bioengineering, U. California, San Diego
- Postdoc, The Rockefeller University
- Strong in biological microtechnology/ bioMEMS, neural dynamics/behavior, neuropeptide signaling, quantitative systems analysis and modeling, and more!
- Career Award at the Scientific Interface from Burroughs Wellcome Fund



Scott Barton
(for Asst. Prof., Music)

- Ph.D, composition and computer technologies, U. Virginia
- Won U. Virginia Grad. School of Arts and Sciences Dissertation Year Fellowship
- Expertise: music technology and perception
- Composer, musician, producer, programmer, instrument builder



Dmitry Berenson
(for Asst. Prof., Computer Science)

- Ph.D, robotics, Carnegie Mellon
- Postdoc, U. California, Berkeley
- Focus: robotic manipulation, motion planning, collaborative robotics
- Covered in Nat. Geographic, Sci. American, Fortune; also BBC and PBS

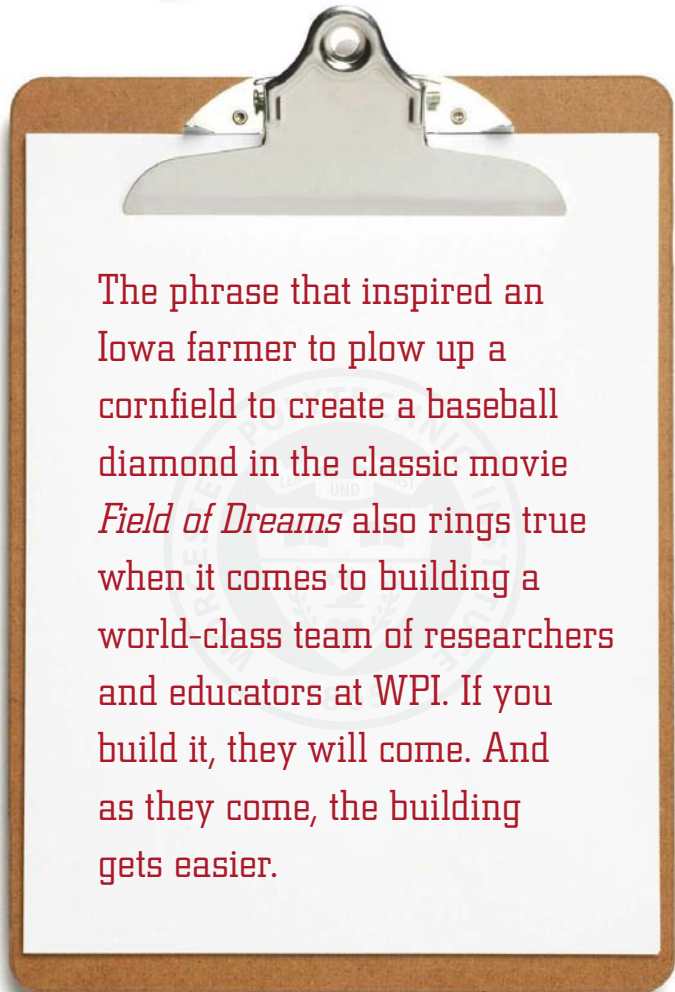

The phrase that inspired an Iowa farmer to plow up a cornfield to create a baseball diamond in the classic movie *Field of Dreams* also rings true when it comes to building a world-class team of researchers and educators at WPI. If you build it, they will come. And as they come, the building gets easier.

To a large degree, the strength and accomplishments of WPI’s faculty define the institution — particularly in the eyes of prospective students and faculty members, and for administrators and faculty at other universities. When the faculty is strong, other strong faculty members are drawn to the university, which helps attract a competitive student body, which brings in accolades and awards, which keeps the cycle going.

“That’s why we want to compete for the very best,” says Eric Overström, WPI’s provost and senior vice president. “It’s as simple as that. We’ve made pretty incredible investments in faculty over the last six years or so, and our focus has been on folks who embrace not only cutting-edge research, but also the project-based learning curriculum and strategy that WPI has practiced for almost 150 years.”

Counting the 13 tenure-track faculty members who joined the university this fall, WPI has recruited more than 90 new educators and scholars since 2006. That amounts to filling more than a third of the Institute’s approximately 250 tenured and tenure-track faculty positions in a very short period of time. Like the satisfying crack of a well-hit fastball, the results of this remarkable building period have resounded through laboratories, classrooms, and offices all across campus and down Salisbury Street to the growing life sciences-focused campus at Gateway Park.

If you build it,

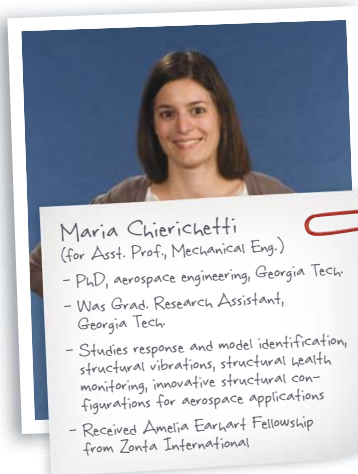

Scouting the Field

Just as the scouts who seek out new talent for the major leagues need to hit the road to see their prospects in action, WPI's faculty recruiters—its provost, deans, department heads, and faculty members—regularly attend conferences, review CVs, and meet with candidates, seeking out bright minds with the potential to make their mark as educators and researchers. And like those baseball scouts, they know that great teams are more than the sum of their parts; they're built with individual stars who can work together, across disciplinary boundaries, to achieve great things.

Recent engineering hires have come from Stanford, Caltech, MIT, Georgia Tech, and more of the best technologically centered universities around the world. WPI also draws forward-thinking minds in the sciences, business, the humanities and arts, and the social sciences from these and other top-tier schools, providing the well-balanced education that the Institute's project-based curriculum, the WPI Plan, demands. Those recruits have helped the university build and expand a host of innovative new interdisciplinary programs in such areas as architectural engineering, environmental engineering, interactive media and game development, life sciences and bioengineering, and robotics engineering (WPI was the first school with a BS in that field and the first with BS, MS, and PhD programs).

A Multitude of Talents

As a school where undergraduate education is highly valued, Overström says WPI looks for men and women who are passionate about teaching. "We're an interesting place," he notes. "Our size and scale and our project-based approach to education allow for a deep and rich engagement with students, so we are always filtering in our selection process for those faculty members who really value that. Finding those highly skilled, highly motivated folks who understand WPI's DNA will ultimately lead to their success, which leads to the success of our students, which leads to the overall success of the institution."

In a way, good teaching is like good batting. Baseball managers hope all their players will produce at the plate. But they also need each player to excel in a particular position in the field. For WPI that means finding rising faculty stars who have emerging research programs that will mesh well with existing research thrusts at the university, that offer opportunities to take those programs in exciting new directions, or that can help establish and build new research strengths in strategically important areas.

With its focus on entrepreneurship (*BusinessWeek* in 2013 ranked WPI's undergraduate business program No. 1 in this area), WPI also looks for faculty members whose work can have an impact beyond the lab, notes Mark Rice,

they will come.

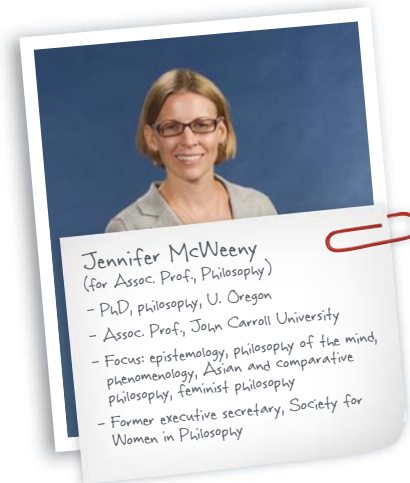
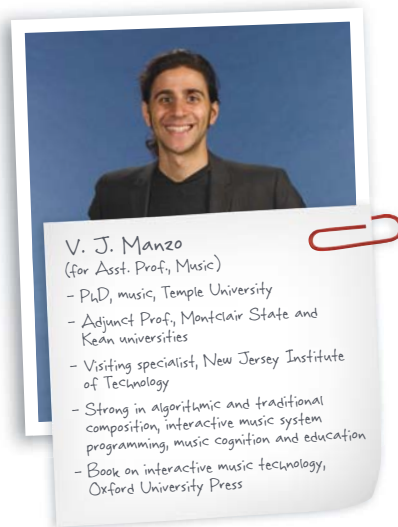
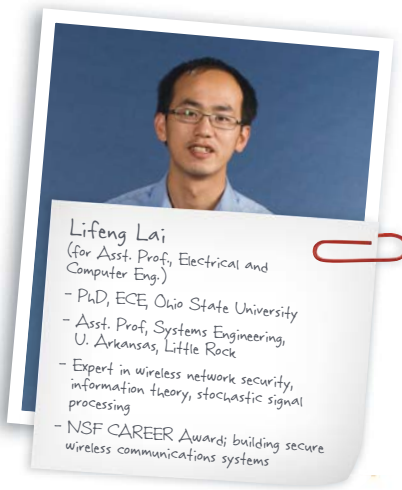

vice provost for innovation and entrepreneurship and dean of the School of Business. “Given WPI’s motto — *Lehr und Kunst*, or theory and practice — connecting research to practice, and developing future practitioners, are both important elements in a successful research enterprise. The work of some of WPI’s researchers will be focused on advancing the work of other researchers; while others will seek opportunities to translate their research into new products, processes, and services that will improve the human condition.”

Often, that translates to drawing in faculty who arrive with experience (in the form of postdoctoral research appointments), notable publications, and grants — including the prestigious National Science Foundation CAREER Award (three of WPI’s 2012 recruits arrived with these highly competitive grants). “These are people who can have a fairly immediate impact, certainly in terms of helping boost our award volume,” says Overström. “Thanks largely to the success of faculty members we’ve brought on board in the last four to five years, in 2012–13 we substantially exceeded our previous record for new research awards.”

A glimpse of just a few recent awards illustrates Overström’s point. Luis Vidali, assistant professor of biology and biotechnology and a member of the record-setting, 23-member faculty Class of 2009, recently received a \$977,000 CAREER Award to study polarized cell growth. The previous year, Diana Lados, associate professor of mechanical engineering (2007) and Sonia Chernova, assistant professor of computer science and robotics engineering (2010), also received CAREER Awards to fund research on metal fracture and fatigue (Lados) and helping everyday people train robots (Chernova). Greg Fischer, assistant professor of mechanical engineering and robotics engineering (2008), has received a five-year, \$3.8 million award from the National Institutes of Health to develop a novel robot-assisted medical system to treat brain tumors.

Bringing the Search Home

Karen Kashmanian Oates, Peterson Family Dean of Arts and Sciences, says that hiring faculty at the caliber WPI seeks is an incredibly active endeavor. She relies on her current faculty to keep their fingers on the pulse of their academic

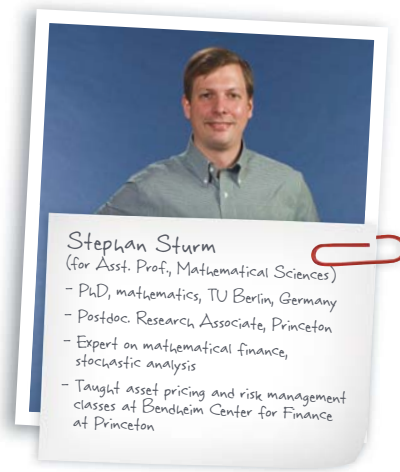
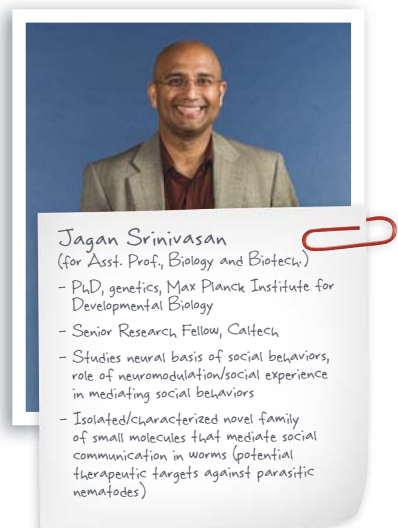
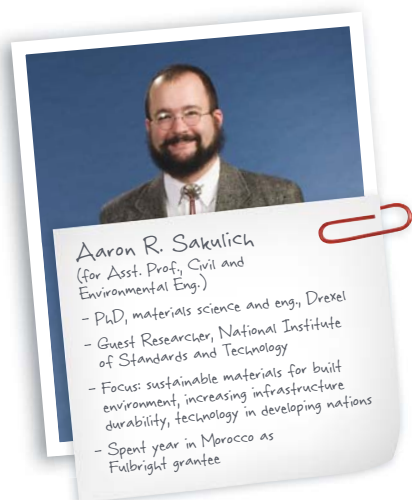



David Medich
(for Asst. Prof., Physics)

- PhD, health, physics/radiological sciences, UMass Lowell
- Dir, UMass Lowell Radioactive Materials Program
- Expert in brachytherapy physics, nuclear diagnostic imaging
- Qualified expert and consultant for International Atomic Energy Agency



Cagdas Denizel Onal
(for Asst. Prof., Mechanical Eng.)

- PhD, mechanical eng, Carnegie Mellon
- Postdoc, MIT
- Strong on soft robotics, printable robotics, control theory, micro/nanoscience and tech
- Co-author, textbook on micro- and nano-robotics and manipulation, based on his dissertation research



Nima Rahbar
(for Asst. Prof., Civil and Environmental Eng.)

- PhD, civil eng, Princeton
- Asst. Prof., UMass Dartmouth
- Works on atomistic simulations, bioinspired design of materials, contact mechanics/adhesion, natural fiber reinforced composites, toughening mechanisms
- NSF CAREER Award
- TMS Structural Materials Division Young Leader Award

disciplines. That means traveling to conferences, searching out the leading minds, and enticing them to come to WPI. “A search committee should actually be a *search* committee,” she says. “A baseball team doesn’t sit back and wait for people to apply. They go out and recruit. If you’re going to put together a team, you have to go out and identify your best prospects; you can’t just wait for them to identify you.”

And once those new faculty members are identified, the dealing begins. While baseball stars seek dollars and perks, talented faculty look for amenities that will help them succeed — particularly as researchers and scholars. Space for a new lab, start-up packages to help get that lab up and running quickly, support for graduate students — these and other needs can become part of the negotiations, Overström says. And since WPI is seeking the best, the university is always aware that its offer will not be the only one on the table. By being willing to invest the resources needed to be competitive, WPI has come out on top in a significant share of the bidding wars.

David Cyganski, dean of engineering ad interim, says WPI’s community of talented and highly collaborative

researchers and teachers is at least as important as dollars in winning the hearts and minds of top faculty. In fact, he says, new recruits feed off the level of interaction they have with their colleagues and with students, who, at all levels, work closely with professors on research. It’s a rare and enriching experience for everyone, he notes. “The level of contact we provide and the kinds of open-ended project scenarios that drive our approach to education excite young faculty members, who say, ‘When I go into work, I don’t want to be interested and excited when I’m in my research laboratory and then go in and teach a boring class.’ Instead, they can say, ‘I can be engaged and excited all the time. My investigation of the world will never end, because I can investigate it together with these young apprentices.’”

Just as Ray Kinsella, the farmer-turned-ballpark builder in *Field of Dreams*, created a little bit of heaven in an Iowa cornfield, WPI has built a university where bright minds collaborate to do remarkable things and prepare new generations of thinkers and doers to build a better world. And each year, from all over the world, the best and brightest continue to come. 



Michael Timko
(for Asst. Prof., Chemical Eng.)

- PhD, chemical eng, MIT
- Was principal chem. eng., Center for Aero-Thermodynamics, Aerodyne Research Inc.
- Strong in bioenergy, biomass conversion, chemical reactor design, chemical measurements in high-pressure, high-temperature environments
- Over \$2 million in funding from NASA, U.S. Army, DOE



Krishna Kumar Venkatasubramanian
(for Asst. Prof., Computer Science)

- PhD, computer science, Arizona State
- Postdoc, U. Pennsylvania
- Expert on secure cyber-physical systems, interoperable medical devices, body area networks
- Coverage: Discovery Channel website, ACM Tech News, IEEE Engineering in Medicine and Biology





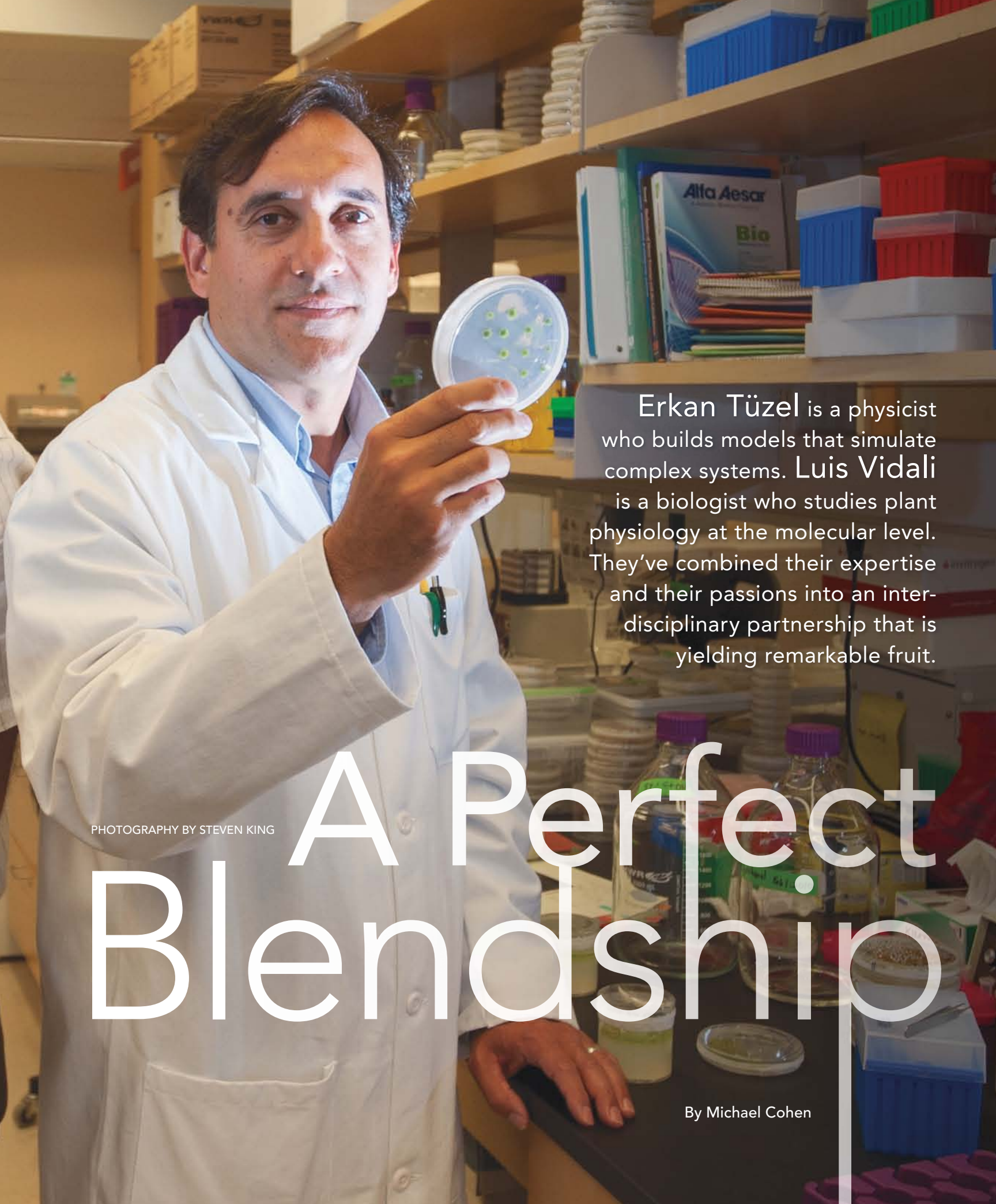

Erkan Tüzel is a physicist who builds models that simulate complex systems. Luis Vidali is a biologist who studies plant physiology at the molecular level. They've combined their expertise and their passions into an interdisciplinary partnership that is yielding remarkable fruit.

PHOTOGRAPHY BY STEVEN KING

A Perfect Blendship

By Michael Cohen



Erkan Tüzel and James Kingsley, PhD candidate in physics, examine a component of a high-performance computing cluster that Tüzel and his research team use to run course-grained models to simulate the behavior of complex biological systems. Opposite page, Luis Vidali and Jeffrey Bibeau, a PhD candidate in biology and biotechnology, study cultures of the moss *Physcomitrella patens*, a model system Vidali uses in his research.

The project was due the next day, and time had gotten away from them. So as dusk dissolved into night, and the first flakes of a winter storm swirled through the trees, they hunkered down in the office they share in the WPI Life Sciences and Bioengineering Center and wrestled ideas from the whiteboard to the keyboard, driven by caffeine and the immutable deadline.

At work that long winter night in 2010 were not undergraduates struggling through an academic rite of passage, but two new professors at WPI, one a physicist, one a biologist, racing to finish their first joint grant application for what was emerging as a powerful partnership.

“It’s a good thing we both love coffee,” says Luis Vidali, assistant professor of biology and biotechnology, as he recounts the story of the all-nighter with Erkan Tüzel, assistant professor of physics.

By two in the morning it was time for a break. Tüzel

and Vidali emerged from the cocoon of their concentration, stretched their legs, and looked out the window to see everything covered in white. “The storm wasn’t supposed to be that bad,” Tüzel remembers. “But it had turned into a blizzard.”

Tüzel headed to his nearby apartment; Vidali, unable to drive through the deep snow, bunked down in the office. Tüzel returned at first light with sandwiches and snacks, and they resumed work, submitting the application just before the deadline. “It would be a better story if we got the grant,” Tüzel says with a laugh.

OVERLAPPING INTERESTS

A computational soft-matter physicist, Tüzel builds course-grained models that simulate the behavior of complex systems. Vidali is a biologist who uses biochemical and genetic tools to study plant physiology at the molecular level. The pair joined the WPI faculty in the summer of 2009.

A generation earlier, it would have been rare for a physicist and biologist to become academic research partners—the fields were too disparate. But Tüzel and Vidali aren't constrained by traditional academic boundaries. From his early days as an undergraduate, Vidali enjoyed mathematics and the satisfaction of measuring and quantifying his work. Likewise, Tüzel has always been fascinated by the

mysteries of biology, and he focused his postdoctoral work on modeling the dynamics of components of living cells.

This overlapping interest was not lost on WPI. In fact, building a research focus in the emerging field of biophysics was part of the strategy for recruiting the faculty class of 2009. Once Vidali and Tüzel had accepted their offers, Germano Iannacchione, head of the Department of Physics, lost little time in planting a seed.

“I wanted to obtain a grant to fund a microscope that could image cellular processes in real time, and Germano told me he thought Erkan might be interested in it, too,” Vidali says. “So I emailed Erkan and found that he was working for the summer as a teaching assistant in the physiology course at the Marine Biological Laboratory in



Woods Hole, which was fantastic, because I had taken that same course a few years before. It gave us a common experience to talk about.”

An exchange of messages led to phone conversations, then meetings over coffee, and even a few beers after work. “Right away, Erkan understood the problems I was facing in my lab, and he could communicate to me in biological language, not just using mathematics,” Vidali says.

Tüzel jumps in to emphasize the same point. “Luis is very quantitative, compared to many biologists I have met in the field,” he says. “So it was easy for us to talk about things right from the start.”

SYNERGY IN ACTION

It turned out both were focused on similar fundamental questions. Tüzel studies microtubules, which are small yet strong filaments that give cells structure (a cytoskeleton) and the molecular motors that transport cargo along these microtubules in support of cellular processes. Much of Vidali’s work is also focused on the cytoskeleton and how the complex overlapping networks of microtubules and filaments made of the protein actin are involved in directing plant growth.

Vidali and his laboratory team conduct experiments with living cells and whole plants. Tüzel’s team uses advanced mathematical modeling and builds high-power computational tools to simulate the dynamics within cells. By joining forces, they bring complementary science and technology to bear on common problems. It is a synergistic partnership that helps each team advance.

“One of the big difficulties of being a theorist today is having access to raw data,” Tüzel says. “In many traditional areas of physics, there are a number of important problems to be solved, but thousands of researchers are already working on them. And it’s hard to get access to unpublished data. By working directly with Luis, not only do we explore these exciting and incredibly complex biological systems, but we also get real-time data on novel problems that we use to evaluate and refine our models.”

Dealing with big data has become a major challenge for biologists. Decoding genomes, which produces hundreds of millions of data points, even for simple plants, is only the first level of mathematical complexity. How those genes



From left, Goker Arpag, a PhD candidate in physics, Tüzel, Vidali, and Zhiyuan Shen, an MS candidate in biology and biotechnology, discuss ongoing research collaborations in the office that Tüzel and Vidali share in WPI’s Life Sciences and Bioengineering Center.

produce proteins, which then assemble into structures that form and operate the processes of life, all in the dynamic, fluidic, three-dimensional environment of cells, are biomechanical events that can now be measured.

“Biologists today can easily be overwhelmed with the huge data sets we get from our experiments,” Vidali says. “So working with Erkan and his group, who understand the physics of complex mechanical systems and can write programs and build models that help us analyze all this data and make predictions — that gives us a tremendous advantage.”

With data, one can build models that simulate cellular processes in motion over time. Feedback from those simulations then helps refine hypotheses to be tested on living cells in the lab. Through this collaborative cycle, Tüzel and Vidali have jointly discovered and published new knowledge about cytoskeletal dynamics and the molecular mechanics underlying tip growth in plants.



“Life self-organizes. It has intrinsic properties that create order, and we don’t really know exactly how. So that is what we are trying to understand.”

Tüzel and Vidali have recently expanded their collaboration to include studying the dynamics of chloroplasts, organelles in plant cells that transform solar energy and CO₂ into sugar through the process of photosynthesis. Chloroplasts move over the course of the day in reaction to the level and direction of ambient light. This movement must involve molecular motors, the cytoskeleton, and a signaling network, but just how it all works is unknown.

“It’s an important problem that not many others are focused on,” Tüzel says, “and it’s well-suited for our combined capabilities.”

Overall, the collaboration thrives for many reasons. Perhaps most important, they get along. They share interests outside of work, like coffee, ethnic foods, reading, and discussing history. They have become genuine friends and their families enjoy each other’s company. They are also committed to changing the culture of education within their respective fields, pushing their students to learn the language of biology and physics, and to work together on common biophysical problems.

Fundamentally, though, they work together because they seek answers to the same existential questions. “Self-organization, that’s the common theme,” both men say, nearly simultaneously, as the discussion draws to a close in their shared office. Then Vidali goes deeper, with Tüzel nodding in agreement. “That’s life, really. It self-organizes. It has intrinsic properties that create order, and we don’t really know exactly how. So that is what we are trying to understand.” 

A FRUITFUL COLLABORATION

Integrating Tüzel’s expertise in physics and modeling with his groundbreaking work on plant physiology helped Vidali earn a coveted five-year, \$977,000 CAREER Award (the largest such award ever received by a WPI faculty member) from the National Science Foundation (NSF). Tüzel and his colleagues at Penn State University secured a four-year, \$1.75 million R01 award from the National Institutes of Health to study a microtubule steering mechanism that may play a role in helping neurons repair themselves after trauma (Tüzel is a co-principal investigator). More recently, Tüzel received a \$293,000 award from the NSF to develop models that will help refine a microfluidic device that can sort sperm for in vitro fertilization. He will work directly with Xinming Huang, associate professor of electrical and computer engineering at WPI, and collaborate with a research team at Brigham and Women’s Hospital in Boston.

The

Weak



Photography by Patrick O'Connor

A young man with short brown hair and glasses, wearing a light blue polo shirt, is shown in profile from the chest up. He is looking out a window with white bars. The background is bright and slightly blurred. The text 'est' is overlaid on a yellow rectangular background in the top left corner.

est

Link

Kathi Fisler, director of WPI's Cybersecurity Program, knows that even the most powerful cryptographic tools and security practices can be undone by the people who use them.

By Alexander Gelfand

Security: a complicated business

Engineers and computer scientists have established cryptographic protocols to hide data from prying eyes. They have invented techniques for shielding wireless networks from intrusion. And they've developed guidelines for limiting access to sensitive information.

But every measure and countermeasure comes with its own costs and its own inherent weaknesses. Some of the weaknesses stem from the human factor: the fact that people use technology in ways that can lead to inadvertent leaks or attacks by malicious actors. WPI's new Cybersecurity Program (see sidebar) draws together experts from computer science, electrical and computer engineering, mathematical sciences, and the social sciences to find new and innovative approaches to protecting digital data — approaches that take the human factor into account in one way or another.

"People are the weakest link in just about any security system," says program director Kathi Fisler, associate professor of computer science. That's why students in the new program are required to take at least one class that deals with human factors. It's also why Fisler says it's important

"to not bug users with stuff they don't want to think about" (and might, therefore, ignore), but instead bug them just enough so they will avoid compromising their own security.

Fisler herself has been building tools to help users understand the implications of their own security and privacy settings, and to help developers understand the security limitations of the systems they design. One of those tools, an application called Margrave, grew out of work she did with her husband, Shriram Krishnamurthi, a professor of computer science at Brown University, her WPI colleague Dan Dougherty, and Tim Nelson, a 2013 PhD recipient who is currently a postdoctoral research associate at Brown.

Margrave interrogates and compares access control policies, the sets of rules that govern who can see and manipulate the various data in a given system. Access control policies specify who can view patient records at a hospital, for example, or who has permission to change student grades in a university database. Such policies can be quite complicated, and are typically managed by human resources personnel who might not understand their full

Preparing Tomorrow's Cyber Watchdogs

In recent years, the need for professionals to defend the nation's information technology from increasingly sophisticated attacks—and from careless users—has been growing at a steep pace. WPI has responded in kind with new academic initiatives, new faculty expertise, and a growing reputation for excellence.

WPI's emerging Cybersecurity Program is driven by nine core faculty members, four of whom arrived during the last two years. They are actively engaged in well-funded research on such topics as software and network security, cryptography, and online privacy.

Having long offered cybersecurity research projects and courses for students pursuing a PhD in either computer science or electrical and computer engineering, the university added a cybersecurity specialization for its existing MS program in computer science. Both programs, as well as a number of new graduate courses in cybersecurity, are seeing rising student interest, according to program director Kathi Fisler, associate professor of computer science.

Also attracting attention is a new graduate certificate in cybersecurity developed expressly for power engineering professionals—the first such program in the nation. The program is designed to help the power industry guard against threats to the electric grid. "This is an exciting program that combines WPI's historic strengths in power engineering with its emerging focus on cybersecurity," Fisler says.

WPI students have expressed their enthusiasm for cybersecurity by forming a cybersecurity club and participating on the WPI Cyber-Defense Team, coached by Craig Shue, assistant professor of computer science. In just its second year, the team took third place, out of 14 teams, in the 2013 Northeast Collegiate Cyber Defense Competition.

WPI's growing momentum in cybersecurity has not gone unnoticed. The university was recently recognized as a National Security Administration/Department of Homeland Security Center of Excellence in Information Assurance Research, Fisler says. "This is a testament to the diverse research and other academic efforts by our security-related faculty."



Krishna Venkatasubramanian develops solutions to security, privacy, and safety concerns raised by interoperable medical devices—pacemakers, sensors, and other medical technology that can communicate over networks.

implications—or the unintended consequences that can ensue when they are altered.

Margrave, however, can run through all of the various roles in an organization and determine precisely who has access to what. It can also compare different access control policies, or different versions of the same policy, to show how changes to the rules can affect privacy and security. That would be a boon to people who must configure their own privacy settings on platforms like Facebook, but have trouble understanding what those settings actually mean. (The “leakage” of private information from Facebook and other websites is one focus of cybersecurity research by Craig Wills, head of WPI’s Computer Science Department.)

Fisler has also been developing methods for mathematically analyzing applications to verify that they conform to the principles of usable security—principles that are meant to ensure that users actually have the ability to maintain their security on a practical basis. The principle of revocability, for example, might require that a user who has decided to share information can also choose to “unshare” it.

Cyberattacks get personal

Krishna Venkatasubramanian, assistant professor of computer science, is also trying to develop security solutions that are both effective and user-friendly. In particular, Venkatasubramanian is looking for methods for securely coordinating medical devices, like x-ray scanners and heart monitors. Such devices have traditionally operated in stand-alone fashion, but are now beginning to communicate with one another across networks.

These interoperable medical devices (IMDs) can provide useful information to doctors and nurses, but they also raise a whole host of new security concerns. A sophisticated attacker could eavesdrop on an IMD network to glean sensitive patient information or interfere with specific devices; researchers have already hacked a pacemaker, for example, and fed it faulty instructions. IMDs, therefore, present a case in which cyberattacks could potentially lead to physical harm, or even death.

Consequently, IMDs need to generate alarms not only when a patient’s health is at risk, but also when security has been breached—alarms that won’t just add to the noise

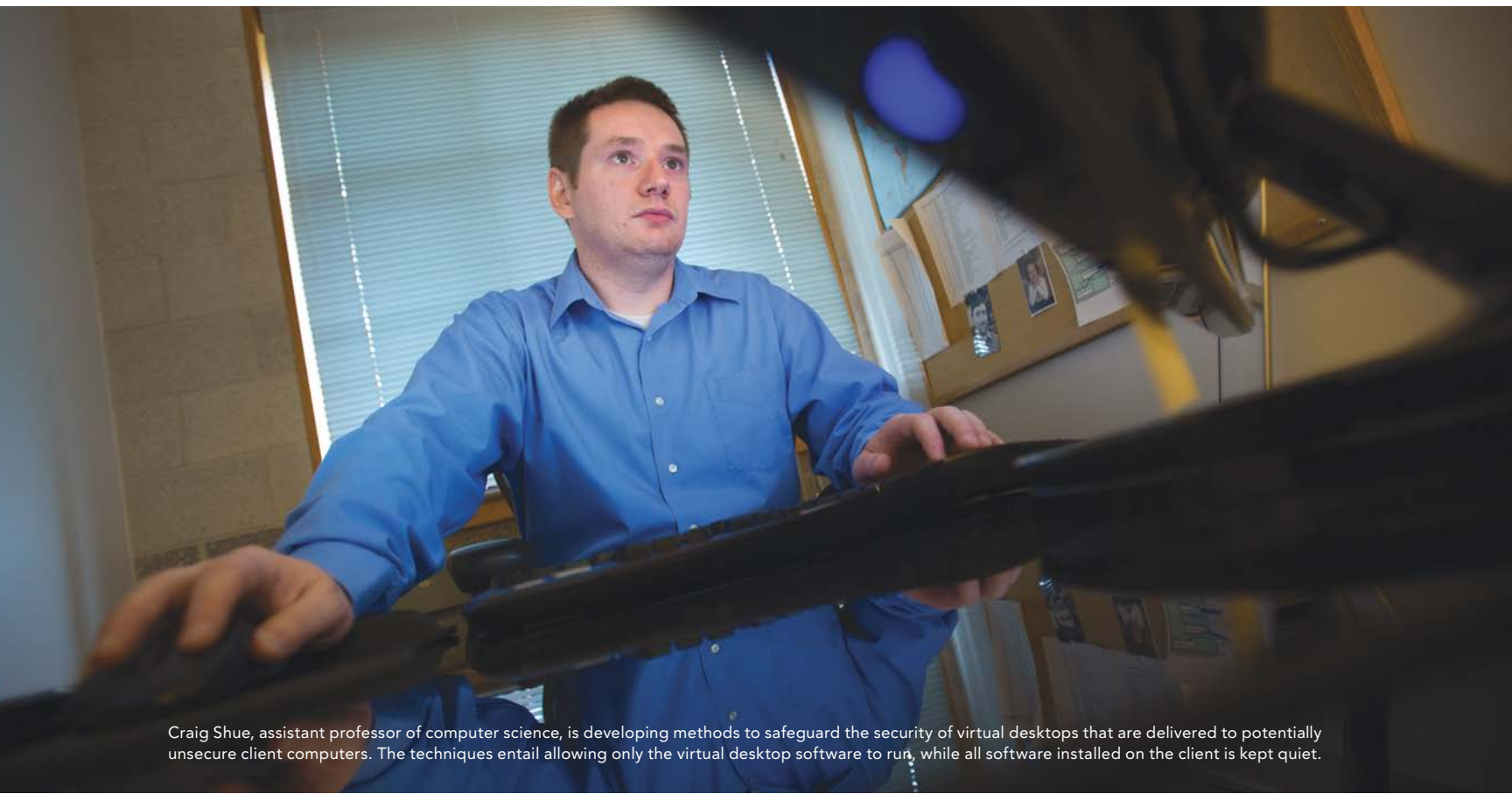

Craig Shue, assistant professor of computer science, is developing methods to safeguard the security of virtual desktops that are delivered to potentially unsecure client computers. The techniques entail allowing only the virtual desktop software to run, while all software installed on the client is kept quiet.

and confusion of a busy operating room or intensive care unit, but will help hospital staff make informed decisions. The devices also need to be able to enter some kind of safe mode until the problem has been solved, without simply shutting down or failing in a way that could harm a patient.

Together with colleagues at the University of Kansas and the University of Pennsylvania, Venkatasubramanian is working to improve IMD alarm systems with the help of a software “coordinator” — middleware that can interpret the data flowing from multiple devices, determine what kind of alarm should be sounded, and communicate that alarm to healthcare providers in a helpful way.

Isolating the problem

Sometimes, however, it’s best to remove users from the security equation completely. That’s one of the goals behind a system designed by Craig Shue, assistant professor of computer science, and graduate student Evan Frenn.

Shue notes that desktop virtualization services like Citrix can deliver entire virtual desktops to client PCs over

the Web. But while the applications and services delivered to the client from the server may be secure, the operating system and applications that live on the client remain vulnerable to infection by malware. In a corporate environment, that can be a serious problem — especially when untrained users are largely responsible for their own security settings, and when more and more people are bringing their own devices to work.

Shue and Frenn have proposed a system in which only the software supplied by the server is allowed to run on the client machine. Everything else, including the client’s operating system — millions of lines of code rife with potential security vulnerabilities — is kept quiet, so that even if the client machine is loaded with malware, none of it can cause trouble. The client is able to attest, or prove, via cryptographic means that nothing but the served applications are running; and responsibility for security stays in the hands of the trained IT professionals who work on the server side.

Shue and Frenn’s scheme was made possible by recent improvements to secure microprocessors called trusted

WPI's new Cybersecurity Program draws together experts from computer science, electrical and computer engineering, mathematical sciences, and the social sciences to find new and innovative approaches to protecting digital data—approaches that take the human factor into account in one way or another.

platform modules (TPMs) that are installed in many desktop and notebook computers. But what about all of the chips that live in the smartphones and smart cards that, increasingly, are being used to access bank account information, make purchases, and provide proof of identity?

While some of those chips employ cryptographic protections like digital signatures, which rely on both public and private keys, they are far from bulletproof. The cryptographic algorithms currently in use, for example, use the same private keys over and over again. By monitoring the electromagnetic emissions from the chips that process those keys, a clever attacker could, over time, collect enough information to crack the private key.

Building elusive keys

According to **Thomas Eisenbarth**, assistant professor of electrical and computer engineering, there are two ways to fend off such attacks: develop countermeasures to protect the standard cryptographic algorithms; or come up with entirely new algorithms that are less vulnerable in the first place. Having already investigated the former approach, Eisenbarth is currently working on the latter in his own laboratory and in the Vernam Lab, a new partnership between Eisenbarth and fellow ECE cybersecurity researchers Berk Sunar and Lifeng Lai, and William Martin, professor of mathematical sciences (the lab is named for Gilbert Vernam, WPI Class of 1914, who discovered the only unbreakable encryption algorithm).

In a forthcoming paper, Eisenbarth and his collaborators investigate key evolving cryptosystems: algorithms whose private keys change over time, making them more resilient to attack. Such systems have existed in theory for some time, but the trick is to implement them so that they will work in small, low-power devices. And researchers don't yet know what would be less costly, and therefore more viable: equipping the old algorithms with fresh countermeasures, or replacing those algorithms altogether with new and improved ones.

"It's always a trade-off between cost and security," says Eisenbarth, who explains that cryptographic enhancements can increase CPU usage, power consumption, and even chip size.

That may be so. But the need for better, cheaper, and less burdensome security measures will only increase. And Eisenbarth and his colleagues in the Cybersecurity Program will continue to help find them, using all the means at their disposal. 



>
Thomas Eisenbarth, assistant professor of electrical and computer engineering, develops key evolving cryptographic algorithms that will make small networked devices more secure.

highlights

> MAJOR RESEARCH AWARDS

Here is a small sample of the many notable awards from federal agencies, corporations, and other entities that have supported research at WPI in recent months.

> MEMBRANE BRINGS CLEAN COAL A STEP CLOSER



With a \$4 million award from the U.S. Department of Energy (DOE), a team of researchers led by **Yi Hua "Ed" Ma**, PhD, James Manning Professor of Chemical Engineering, will continue development of a patented palladium membrane system that may be critical to the economic viability of integrated combined cycle gasification electric power plants that use coal gas as fuel. The membrane system can convert coal gas to carbon dioxide and hydrogen, and separate out the hydrogen for use as a fuel or a chemical feedstock. Ma's team received an earlier, \$1.5 million DOE award for a pilot-scale test. The current grant is funding the development of multi-membrane modules for larger-scale tests at the National Carbon Capture Center in Alabama. (See story, page 16.)

> AN MRI-GUIDED ROBOT FOR TREATING BRAIN TUMORS

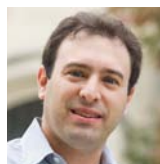

A five-year, \$3 million R01 award from the National Institutes of Health (NIH), through the National Cancer Institute, is allowing a team of researchers led by **Gregory Fischer**, PhD, assistant professor of mechanical engineering and robotics engineering and director of WPI's Automation and Interventional Medicine Laboratory, to test a new, minimally invasive approach to treating brain tumors, one that promises to accurately destroy malignant tissue while leaving surrounding tissue unaffected. This approach, which combines a robot developed at WPI that works in an MRI scanner with a probe that can destroy tumors with high-intensity ultrasound, would be a significant improvement over current treatments. (See story, page 4.)

> STITCHING STEM CELLS INTO DAMAGED HEARTS



Introducing human mesenchymal stem cells into cardiac muscle tissue damaged by a heart attack can improve the heart's ability to pump blood. It's difficult, however, to get large numbers of the cells to take hold and grow. With a five-year, \$1.94 million award from the NIH, a research team led by **Glenn Gaudette**, PhD, associate professor of biomedical engineering at WPI, and including **George Pins**, PhD, associate professor of biomedical engineering, will work to improve upon a novel repair technique that has already shown promising results. The technique involves growing stem cells on biopolymer microthreads and stitching them directly into heart tissue. (See story, page 3.)

> EXPLORING THE FIRE SAFETY OF GREEN BUILDING FEATURES



In a 2012 report commissioned by the Fire Protection Research Foundation, the research arm of the National Fire Protection Association, a team led by **Brian Meacham**, PhD, associate professor of fire protection engineering, showed that some building practices and materials touted as green or sustainable have associated fire safety concerns. Now, with a \$1 million award from the Department of Homeland Security, Meacham and **Nicholas Dembsey**, PhD, professor of fire protection engineering, will explore ways to gather more local and national data on fire incidents involving green building features and elements, identify fire safety risks and hazards associated with green building features and elements (and develop tools for assessing and ranking them), and explore ways to help firefighters understand and respond effectively and safely to those risks (See story, page 6.)

> COLLABORATING TO BUILD A BETTER ONLINE MATH TUTOR



Neil Heffernan, PhD, associate professor of computer science and co-director of WPI's Learning Sciences and Technologies Program, and **Joseph Beck**, PhD, assistant professor of computer science, have received a \$700,000 award, part of a \$1.5 million grant to the University of Massachusetts from the Office of Naval Research (ONR), to help develop an enhanced open, online tutoring platform for mathematics education. The award is part of the ONR's "grand challenge" program aimed at developing tutoring systems that adapt to individual student needs. Through the award, Heffernan and Beck will work with Beverly Woolf, research professor of computer science at UMass, and **Ivon Arroyo**, assistant professor of learning sciences and technologies at WPI, to integrate ASSISTments, an award-winning system developed at WPI that combines tutoring with assessment of student progress, with Wayang Outpost, an emotionally perceptive tutoring system developed by Woolf and Arroyo.

> CAREER AWARD FUNDS RESEARCH ON POLARIZED CELL GROWTH



With a five-year, \$977,000 CAREER Award from the National Science Foundation (NSF), the largest such award received by a WPI faculty member, **Luis Vidali**, PhD, assistant professor of biology and biotechnology, hopes to begin to answer a fundamental question in biology: how are some cells able to grow along a single axis—an ability that is critical to a number of biological functions, including the growth of root hairs in plants and axons in animal neurons. Vidali will use the moss *Physcomitrella patens*, an emerging plant model, in combination with genetic techniques, advanced microscopy, and computer simulations to explore how certain components of the cell's internal anatomy work together to focus the growth machinery on a single point. Vidali's award brings to 21 the number of current WPI faculty members who have received NSF CAREER Awards.

>
HOMOMORPHIC ENCRYPTION FOR SECURE CLOUD COMPUTING



With a \$500,000 award from the NSF, **Berk Sunar**, associate professor of electrical and computer engineering, and **William Martin**, professor of mathematical sciences, will investigate a particularly powerful cryptographic technique known as fully homomorphic encryption (FHE). To date, this methodology has eluded practical real-world implementation, but recent work—in which FHE schemes are based on what is known as “the learning with errors (LWE) problem”—holds promise for significant efficiency gains. Sunar and Martin will address issues involving engineering, computer science, and mathematics in an effort to bring LWE-based homomorphic encryption closer to practice, particularly as a means of ensuring the privacy of transactions performed with cloud-based servers.



>
TOOLS TO HELP WIRELESS NETWORKS OPERATE EFFICIENTLY



As consumers acquire more and more wireless devices, it is important to find ways to enable wireless networks to bring order to the many demands placed upon them so they can make the most efficient use of their limited spectrum. One key to accomplishing this may be for networks to continuously share with wireless devices information about the current and predicted state of the network so the devices, themselves, can adjust their network usage as appropriate. With a \$500,000 NSF award, **Donald Brown**, associate professor of electrical and computer engineering, and **Andrew Klein**, assistant professor of electrical and computer engineering, will develop an analytical framework and efficient techniques to enable such sharing and the synchronization of networked devices—tools that should be applicable to a wide range of wireless communication systems.



>
NEW BOOKS BY WPI FACULTY



BODY AREA NETWORKS: SAFETY, SECURITY AND SUSTAINABILITY

Sandeep Gupta, Tridib Mukherjee, and Krishna Venkatasubramanian
Cambridge University Press, 2013

Body area networks (BANs) may revolutionize healthcare if they can be made safe, sustainable, and secure from interference and malicious attacks. Co-authored by **Venkatasubramanian**, assistant professor of computer science, this book shows how BANs can be redesigned from a cyber-physical systems perspective to overcome these concerns.

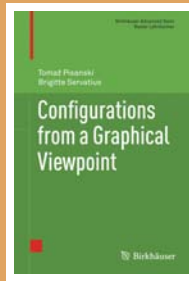

CONFIGURATIONS FROM A GRAPHICAL VIEWPOINT

Tomaz Pisanski and Brigitte Servatius
Birkhäuser Basel, 2013

Among the oldest combinatorial structures, configurations are explored from a graphical viewpoint for the first time in this book co-authored by **Servatius**, professor of mathematical sciences. Designed for graduate courses and advanced undergraduate seminars, the book is also a useful reference work.



DIGITAL COMMUNICATION SYSTEMS ENGINEERING WITH SOFTWARE-DEFINED RADIO

Alexander M. Wyglinski and Di Pu
Artech House, 2013

Written by **Wyglinski**, associate professor of electrical and computer engineering (ECE), and **Pu**, who received his PhD in ECE from WPI in 2013, this is the first textbook that teaches digital communication systems engineering using software-defined radio, a revolutionary wireless technology.

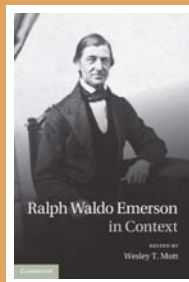

RALPH WALDO EMERSON IN CONTEXT

Wesley Mott, Editor
Cambridge University Press, 2013

Edited by **Mott**, professor of literature, organizer of the Ralph Waldo Emerson Society, and longtime editor of the *Emerson Society Papers*, this collection of newly commissioned essays maps the vital contextual backgrounds to Emerson’s life and work. It includes essays by Mott and Kristin Boudreau, head of WPI’s Department of Humanities and Arts.

> FACULTY ACHIEVEMENTS

> NEW FELLOWS



Kristen Billiar, associate professor of biomedical engineering, has been elected a fellow of the American Society of Mechanical Engineering (ASME).

He has also been named to the executive board of the ASME's Bioengineering Division and elected to a three-year term on the Biomedical Engineering Society's board of directors.



John Blandino, associate professor of mechanical engineering, has been elected to the grade of associate fellow in the American Institute of Aeronautics and Astronautics.



David DiBiasio, professor and head of the Department of Chemical Engineering, has been elected a fellow of the American Institute of Chemical Engineers. Fellow membership is limited to two percent of the organization's 40,000 members.

> DISTINGUISHED PROFESSIONAL HONORS



Rise of a City, a composition for guitar and musical robots by **Scott Barton**, assistant professor of music technology, was a winner of Ablaze Records' international composition competition; it is featured on an Ablaze collection called *Millennial Masters, Vol. 4*.



Terri Camesano, professor of chemical engineering, was selected to be a member of the inaugural class of ELATE (Executive Leadership in Academic Technology and Engineering) Fellows at Drexel University in 2012–13. The program provides academic leadership training and support for women through a one-year fellowship program.



Glenn Gaudette, associate professor of biomedical engineering, has been appointed to the scientific advisory board for the Massachusetts Life Sciences Center, the quasi-public agency tasked with implementing the state's 10-year, \$1 billion Life Sciences Initiative.



Nikolas Kazantzis, professor of chemical engineering, was reappointed a senior associate by the Fellowship Committee at Hughes Hall, the oldest of the six graduate colleges at the University of Cambridge in England.



Rajib Mallick, Ralph White Family Distinguished Professor of Civil and Environmental Engineering, was appointed to the steering committee of the NSF-funded Infrastructure and Climate Network at the University of New Hampshire.



Jeanine Plummer, associate professor of civil and environmental engineering and holder of the Schwaber Professorship in Environmental Engineering, has been elected to a three-year term as chair of the Water Science and Research Division of the American Water Works Association, and currently sits on the organization's Technical and Educational Council.



Tom Robertson, associate professor of history, has won a Truman-Kauffman Research Fellowship from the Harry S. Truman Library Institute for National and International Affairs. Only two fellowships are awarded each year to senior scholars in support of ambitious archival-based research projects that will result in a book to be published by Cambridge University Press.



Josh Rosenstock, associate professor of art, contributed to "Periscope," a live video public art installation commissioned by Paul Allen's Vulcan Inc. for the Amazon.com building in Seattle. Rosenstock developed an autonomously generated animation composed of surveillance and webcam images from around the world.



Jeanine Skorinko, associate professor of social science and policy studies and director of the Psychological Sciences Program, was elected president of the New England Psychological Association for 2013–14.



BUSINESS PROFESSORS EARN FULBRIGHT HONORS

Michael Elmes, a professor in WPI's School of Business, received a grant through the Fulbright Scholars Program to lecture and conduct pioneering research on food security, sustainability, and social justice in the Netherlands during the 2013–14 academic year. This is the second Fulbright award for Elmes, who was a Fulbright Scholar in New Zealand in 2005, an experience that led this year to the establishment of a WPI undergraduate student project center in that country. Through a separate award, **Steven Taylor**, an associate professor in the School of Business, recently spent a month at Massey University in Auckland, New Zealand, as a Fulbright Specialist. Taylor helped that university enhance its arts-based educational programs, particularly through the use of theatre as a learning tool for business students and faculty members.



>
CONFERENCE ORGANIZERS



Christopher Brown, professor of mechanical engineering and director of the Surface Metrology Laboratory at WPI, and **Torbjorn Bergstrom**, operations manager for WPI's Manufacturing Laboratories, were co-chairs for the 7th International Conference on Axiomatic Design, held at WPI in June 2013.



Thomas Eisenbarth, assistant professor of electrical and computer engineering, was general co-chair for the 15th Workshop on Cryptographic Hardware and Embedded Systems, held in Santa Barbara, Calif., in August 2013.



Cosme Furlong, associate professor of mechanical engineering, was a co-chair of the 14th International Symposium on MEMS and Nanotechnology in Lombard, Ill., in June 2013.



Michael Gennert, professor of computer science and director of the Robotics Engineering Program, co-chaired the 2013 IEEE International Conference on Technologies for Practical Robot Applications in Woburn, Mass. His co-chair was **Helen Greiner**, founder and CEO of CyPhy Works Inc. **Taskin Padir**, assistant professor of electrical and computer engineering and robotics engineering, was technical program chair.



Frank Hoy, Paul R. Beswick Professor of Innovation and Entrepreneurship, served on the advisory committee for the 9th annual Family Enterprise Research Conference (FERC), held in Viña del Mar, Chile. He is also co-president of the FERC board of directors.



Elke Rundensteiner, professor of computer science, was co-program chair for the 2013 ACM International Conference on Distributed Event-Based Systems, held in Arlington, Texas.

>
NEW BOOKS BY WPI FACULTY



THE MADONNA ON THE MOON

By Rolf Bauerdick; translated by David Dollenmayer
Knopf, 2013

Translated from German into English by **Dollenmayer**, professor of German, this deeply enchanting debut novel by Bauerdick, a photojournalist who has reported on Eastern Europe's Gypsies, won the European Book Prize. It is a tragicomedy, thriller, and coming-of-age story wrapped up together.



METAL TRANSPORTERS

Edited by José Argüello and Svetlana Lutsenko
Academic Press, 2012

Argüello, Walter and Miriam Rutman Professor of Chemistry and Biochemistry, and **Lutsenko** of Johns Hopkins University, explore the most recent advances in the study of the transporters and pumps that move metal ions across cell membranes. These ions play important roles in the physiology of living organisms.



MURPHY'S AMERICAN DREAM

By James Dempsey
Stay Thirsty Publishing, 2013

This debut novel by **Dempsey**, instructor of writing and rhetoric, tells the story of Alexander Aloysius Aristophanes Murphy II, an émigré from England who "battles the forces of greed, lust, and basic human decency" in Boston. Available only as an e-book, it is described as a comedy noir in the spirit of *The Ginger Man*, *The Big Lebowski*, and *Pulp Fiction*.

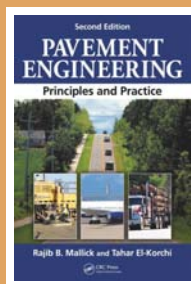

PAVEMENT ENGINEERING: PRINCIPLES AND PRACTICE, SECOND EDITION

By Rajib B. Mallick and Tahar El-Korchi
CRC Press, 2013

This comprehensive overview by **Mallick**, professor of civil and environmental engineering, and **El-Korchi**, head of the Civil and Environmental Engineering Department, includes coverage of emerging areas in pavement engineering, such as sustainable pavements and environmental mitigation in transportation projects.

highlights



Candace Sidner, research professor of computer science, served on the Senior Program Committee for the 2013 conference on Human Robot Interaction, held in Tokyo.



Vadim Yakovlev, research associate professor of mathematical sciences, was chair of the technical program committee for the 47th International Microwave Power Institute's 2013 Microwave Power Symposium in Providence, R.I.



Matt Ward, professor of computer science, served as general chair for the 2013 IEEE Conference on Visual Analytics Science and Technology, held in Atlanta. He was also selected for a six-year term on the steering committee for the IEEE Information Visualization Conference.

> EDITORIAL HONORS



Corey Denenberg Dehner, assistant teaching professor in the Interdisciplinary and Global Studies Division, received the 2012 Journal Award of Special

Recognition from the New England Water Works Association for her paper in the *Journal of the New England Water Works Association* titled "Private Sector Involvement in Public Water Distribution: Assessing Local Water Systems in Massachusetts."



Arne Gericke, professor and head of the Department of Chemistry and Biochemistry, has been named to the editorial board of the *Biophysical Journal*, for the membrane section.



Roger Gottlieb, professor of philosophy, received a silver medal for fiction in the 2013 Nautilus Book Award competition for his collection of short stories titled *Engaging Voices: Tales of Morality and Meaning in an Age of Global Warming* (Baylor University Press, 2011). He won a second silver medal for his new volume *Spirituality: What It Is and Why It Matters* (see *New Books by WPI Faculty*, p.47).

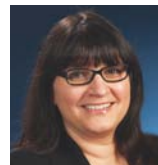

Eleanor Loiacono, associate professor in the School of Business, has been appointed to the scientific board of the international journal *Advances in Hospitality and Tourism Research*.



V.J. Manzo, assistant professor of music technology, has been named to the editorial board for *Symposium*, the peer-reviewed journal of the College Music Society. Manzo was also named a 2013 Distinguished Alumnus by Kean University.



Richard Quimby, associate professor of physics, has been named a senior editor of the *Journal of Optical Engineering* for the areas of fiber optics, optical communications, and lasers.



John Sanbonmatsu, associate professor of philosophy, has been appointed to the editorial board of the *Journal for Critical Animal Studies*.

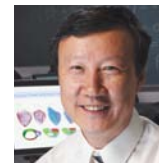

A paper whose authors include **Dalin Tang**, professor of mathematical sciences, **Alan Hoffman**, professor of mechanical engineering, and **Kristen Billiar**, associate professor of biomedical engineering ("Using In Vivo Cine and 3D Multi-Contrast MRI to Determine Human Atherosclerotic Carotid Artery Material Properties and Circumferential Shrinkage Rate and Their Impact on Stress/Strain Predictions"), won an Editor's Choice award as one of the top papers published in the *Journal of Biomechanical Engineering* in 2012.



Michael Timko, assistant professor of chemical engineering, received the R. A. Glenn Award for his paper "Sulfur Group Type Response to an Oxidative Desulfurization Treatment," which he presented at the 2013 national meeting of the American Chemical Society. The award honors the most innovative and interesting paper presented at the meeting.

> BEST PAPER AWARDS

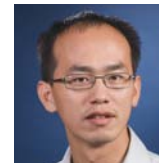

Lifeng Lai, assistant professor of electrical and computer engineering, received the Best Paper Award at the IEEE International Conference on Smart Grid Communications, held in November 2012 in Tainan City, Taiwan.

METALS RESEARCH YIELDS STERLING HONORS

For **Diana Lados**, who has earned worldwide acclaim for her research on metal fatigue and fracture, winning two awards made from silver seems an especially fitting honor. In October 2012, Lados, associate professor of mechanical engineering and founding director of WPI's Integrative Materials Design Center, received the Silver Medal of the Society from ASM International, the materials information society; the society's most distinguished honor for mid-career professionals, it recognizes outstanding contributions to materials science and engineering, leadership, and service to the materials profession. In June 2013, she won the inaugural Constance Tipper Silver Medal from the World Academy of Structural Integrity. Lados was honored for her seminal research, her pioneering contributions with worldwide impact, and her successful efforts to transfer knowledge to industrial applications.





A paper by **Eduardo Torres-Jara**, assistant professor of computer science and robotics engineering, won the Industrial Robot Innovation Award at the International Conference on Climbing and Walking Robots in Australia in July 2013. The paper, "Caminante: A Platform for Sensitive Walking," was co-authored by Vadim Chernyak, Ennio Clarretti, and **Stephen Nestinger**.



Craig Shue, assistant professor of computer science, won the Best Paper Award at the 2013 Workshop on Research for Insider Threat, part of the IEEE Symposium on Security and Privacy in San Francisco, for "Reporting Attacks via a Covert Ethernet Channel," which he co-authored with David Muchene and Klevis Luli.

>
INVITED LECTURES



Tanja Dominko, associate professor of biology and biotechnology, delivered an invited lecture at a meeting of the board of directors of the Rosalind Franklin Society, held in Washington, D.C., in December 2012. She was also appointed director of the Center for Biomedical Sciences and Engineering at the University of Nova Gorica in Slovenia.



Christopher Larsen, professor of mathematical sciences, gave an invited "selected lecture" at the International Workshop on "Multi-Scale Modeling and Characterization of Innovative Materials and Structures," held in Cetara, Italy, in May 2013.



Reeta Rao, associate professor of biology and biotechnology, was an invited speaker at the Global Biotech Congress, held in Boston in June 2013. Her topic was "New Routes Toward the Development of Novel Antifungal Therapeutics." Rao has also been appointed to the editorial board of *PLOS ONE*, an international, peer-reviewed, open-access journal.

>
NEW BOOKS BY WPI FACULTY

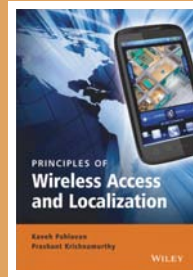

PRINCIPLES OF WIRELESS ACCESS AND LOCALIZATION

Kaveh Pahlavan and Prashant Krishnamurthy
John Wiley and Sons, 2013

Co-authored by **Pahlavan**, professor of electrical and computer engineering and founder of WPI's Center for Wireless Information Network Studies, the book provides a unified treatment of issues related to all wireless access and wireless localization techniques.



SOLDIER FOR CHRIST

John Zeugner
Wipf & Stock Publishers, 2013

In this novel by **Zeugner**, professor emeritus of history and a recipient of a Discovery Grant for fiction from the National Endowment for the Arts, a young rector's assistant's faith is tested by his discoveries of the connections his church in Kobe, Japan, has to Japanese atrocities in Manchuria during World War II.

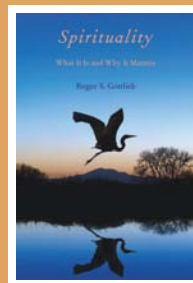

SPIRITUALITY: WHAT IT IS AND WHY IT MATTERS

Roger S. Gottlieb
Oxford University Press, 2012

Winner of a silver medal in the 2013 Nautilus Awards and honored as one of the best books of 2012 by the website *Spirituality and Practice*, this volume by **Gottlieb**, professor of philosophy, explores spirituality from traditional religion to the present and reveals the common thread that joins people of all faiths with those who are spiritual but not religious.



THE SUMMITS OF MODERN MAN

Peter H. Hansen
Harvard University Press, 2013

Hansen, associate professor of history, chronicles the first ascents of the major Alpine mountain peaks and Mount Everest to demonstrate how mountaineering has long served as a metaphor for man's conquest of nature, an idea that retains its currency even as global warming creates ambivalence about our domination of the natural world.



THE EYE-TRACKING TECHNOLOGY IN WPI'S USER EXPERIENCE AND DECISION MAKING RESEARCH LABORATORY CAN HELP BUSINESSES BUILD SUCCESS

"A first impression makes a huge impact on rational decisions," says Soussan Djammasbi, PhD, associate professor of management information systems in WPI's School of Business. "You can't just design something that is easy to use. You have to know what the user wants and how to provide it."

If you've ever found yourself getting lost on one website while you navigate another effortlessly, you've experienced the all-too-frequent disconnect between web design and user needs. Until recently, website creators have relied on good design principles and a bit of luck to create a satisfying customer experience. But that is beginning to change, thanks to the emerging field of user experience research.

WPI's User Experience and Decision Making (UXDM) Research Laboratory, which Djammasbi founded and directs, is one of the leaders in this new discipline, which is built upon cutting-edge eye-tracking technology. Djammasbi says user experience research can help companies be more successful, since more user-friendly websites and applications can lead to repeat customers and more business.

But the potential for the research goes far beyond those basic goals. The work Djammasbi directs is aimed, fundamentally, at expanding our understanding of how people take in and process information displayed on screens, how our emotional reaction to what we see affects our experience, and how interaction with and emotional reaction to screen displays influences the decisions we make. This knowledge could impact how websites, mobile applications, and other screen-based information sources are built.

With funding and partnership from Dynamic Network Services Inc. (Dyn), a leader in Internet infrastructure as a service technology founded by Jeremy Hitchcock '04, Djammasbi has created a state-of-the-art laboratory with 15 eye-tracking stations — five for recording and 10 for analyzing data. In addition to using it for research, she will soon

GOOD
DESIGN
IS IN THE
EYE
OF THE BEHOLDER

BY JULIA QUINN-SZCESUIL

begin teaching a new user experience course in the lab. "I want to expose students to what research happens in industry and what is needed in industry," she says.

The small camera-like eye-tracking unit emits an infrared beam that, once calibrated to the reflection from a particular user's pupil, will detect where that user is directing his gaze, moment by moment, as he navigates a website or uses a mobile app. The results appear as colored zones overlaid on the website or app screen. Red indicates areas that attracted the most eye time, while yellow and green define areas that were viewed less. The more intense the color (for example, the darker the red), the more intense the user's gaze.

"It is a clear indication of the user's attention," Djammasbi

says. "This literally allows us to peer through a user's eyes and see what she is looking at."

Dan McAuliffe, Dyn's user experience manager, says WPI's eye-tracking research opened his eyes. Dyn sponsored a project in which a team of undergraduates was asked to help the company optimize the checkout process on its website for display on mobile devices with a range of screen sizes. The students discovered that while users found the website well designed and intuitive, when the same content was adapted for the mobile screen the need for scrolling, panning, and zooming made the checkout process confusing and prone to error.

Within months of implementing the students' recommendation to have pages dynamically adapt to a mobile device's screen size, Dyn observed "a 10.4 percent increase in number of mobile transactions, with a 32 percent increase in the average value of these transactions," McAuliffe says.

"Design used to be purely about the emotion you got from something, but we didn't have too much data to back that up," McAuliffe says. "You try to put your best foot forward and make an educated guess about what is the best design. Now we can put more science behind it."

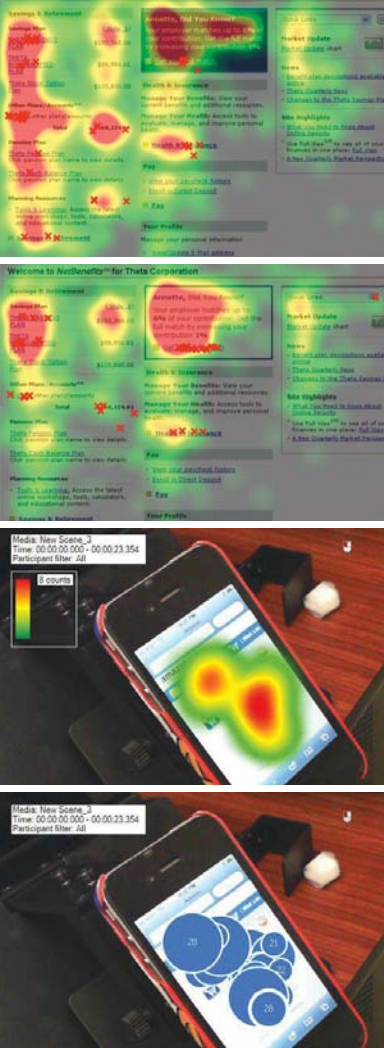

From left, Soussan Djasmasbi, associate professor of management information systems, and Xue "Anny" Luan and Jingmin "Pat" Qiu, MS candidates in marketing and technology innovation, use an eye-tracking system. The system can be used to explore what users focus on when looking at a web page (the top two images are from a 2007 study that showed that people noticed a simpler "bricklet" in the top right of the screen more than a colorful one). The system can also be used to determine how people take in information on mobile devices. The bottom two illustrations show a heat map (how long people look at different areas) and a gaze map (what they look at and in what order). (Photo by Patrick O'Connor)

McAuliffe says conducting usability research at WPI helps his company's designers be proactive, not reactive, by evaluating the user experience before a product launches, rather than waiting to make fixes based on user feedback after the product is already in the field.

Dyn's initial award to Djasmasbi allowed her to establish a specialized lab and move her eye-tracking equipment from her office into dedicated space. The company recently facilitated a new award valued at over \$170,000 (including a generous contribution from Tobii, a leader in manufacturing eye-tracking equipment) that made it possible for the lab to acquire new workstations and expand, creating separate spaces for the testing stations and the analysis stations.

Separating recording and analysis will augment the lab's research and development capacity and, Djasmasbi notes, help "ensure WPI's status as a thought leader in teaching and scholarship in the user experience area." And she hopes the expansion will pave the way for greater collaboration with other researchers at WPI and research partnerships with an even greater number of companies.

Djasmasbi says she is also looking forward to using her equipment and expertise to expand into new domains,

including fields where the usability research has yet to have a significant impact on the user experience such as video games, robotics, in-vehicle displays, computer-based learning, and mobile healthcare apps.

Djasmasbi's students say they are excited by the far-reaching implications of their eye-tracking work. "It is so simple and so profound," says Dhiren Mehta '12, who helped Djasmasbi set up the lab as an MIS graduate student. "It has endless possibilities."

"It tells you what people are drawn to without their having to tell you," says Michelle Mulkern '15, a biotechnology major who has worked in the UXDM lab. "It's inspiring to think that we might be able to help people with cognitive disabilities who could benefit from websites tailored to their needs."

For the time being, Djasmasbi and her team are looking forward to the impact they can continue to have within the domain of commerce. "We can help people make better and more effective decisions based on how they use and process information," she says. "This is huge for business. I think in a few years this will be a standard procedure in every company as the equipment becomes more accessible. There is a need for this and we can deliver it effectively." ^{Re}



WPI

Worcester Polytechnic Institute
100 Institute Road
Worcester, MA 01609-2280

NONPROFIT ORG
US POSTAGE PAID
Lebanon Junction, KY
PERMIT NO. 836

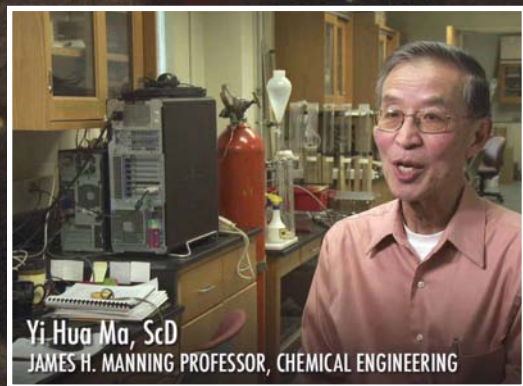

Yi Hua Ma, ScD
JAMES H. MANNING PROFESSOR, CHEMICAL ENGINEERING

Can an inorganic membrane developed at WPI help make the dream of clean coal power a reality?

See the story starting on page 16 and watch videos about this and many other WPI research programs at [YouTube.com/WPI](https://www.youtube.com/WPI); click on Research at WPI.