



Regular languages and partial commutations

Antonio Cano, Giovanna Guaiana, Jean-Eric Pin

► To cite this version:

Antonio Cano, Giovanna Guaiana, Jean-Eric Pin. Regular languages and partial commutations. Journal of Information and Computation, Elsevier, 2013, 230, pp.76-96. <10.1016/j.ic.2013.07.003>. <hal-01247172>

HAL Id: hal-01247172

<https://hal.archives-ouvertes.fr/hal-01247172>

Submitted on 21 Dec 2015

HAL is a multi-disciplinary open access archive for the deposit and dissemination of scientific research documents, whether they are published or not. The documents may come from teaching and research institutions in France or abroad, or from public or private research centers.

L'archive ouverte pluridisciplinaire **HAL**, est destinée au dépôt et à la diffusion de documents scientifiques de niveau recherche, publiés ou non, émanant des établissements d'enseignement et de recherche français ou étrangers, des laboratoires publics ou privés.

Regular languages and partial commutations*

Antonio Cano¹, Giovanna Guaiana² and Jean-Éric Pin³

Abstract

The closure of a regular language under a [partial] commutation I has been extensively studied. We present new advances on two problems of this area: (1) When is the closure of a regular language under [partial] commutation still regular? (2) Are there any robust classes of languages closed under [partial] commutation? We show that the class $\text{Pol}(\mathcal{G})$ of polynomials of group languages is closed under commutation, and under partial commutation when the complement of I in A^2 is a transitive relation. We also give a sufficient graph theoretic condition on I to ensure that the closure of a language of $\text{Pol}(\mathcal{G})$ under I -commutation is regular. We exhibit a very robust class of languages \mathcal{W} which is closed under commutation. This class contains $\text{Pol}(\mathcal{G})$, is decidable and can be defined as the largest positive variety of languages not containing $(ab)^*$. It is also closed under intersection, union, shuffle, concatenation, quotients, length-decreasing morphisms and inverses of morphisms. If I is transitive, we show that the closure of a language of \mathcal{W} under I -commutation is regular. The proofs are nontrivial and combine several advanced techniques, including combinatorial Ramsey type arguments, algebraic properties of the syntactic monoid, finiteness conditions on semigroups and properties of insertion systems.

The closure of a regular language under commutation or partial commutation has been extensively studied [37, 25, 1, 17, 18, 19], notably in connection with regular model checking [2, 3, 9, 10] or in the study of Mazurkiewicz traces, one of the models of parallelism [20, 21, 26, 27, 28, 29, 38]. We refer the reader to the book [16] and to the survey [15] for further references.

In this paper, we present new advances on two problems of this area. The first problem is well-known and has a very precise statement. The second problem is more elusive, since it relies on the somewhat imprecise notion of robust class. By a *robust class*, we mean a class of regular languages closed under some of the usual operations on languages, such as Boolean operations, product, star, shuffle, morphisms, inverses of morphisms, quotients, etc. For instance, regular languages form a very robust class, *commutative languages* (languages whose syntactic monoid is commutative) also form a robust class. Finally, *group languages* (languages whose syntactic monoid is a finite group) form a semi-robust

¹Departamento de Sistemas Informáticos y Computación, Universidad Politécnica de Valencia, Camino de Vera s/n, P.O. Box: 22012, E-46020 - Valencia.

²LITIS EA 4108, Université de Rouen, BP12, 76801 Saint Etienne du Rouvray, France.

³LIAFA, Université Paris-Diderot and CNRS, Case 7014, 75205 Paris Cedex 13, France.

*The first author was supported by the project *Autómatas en dispositivos móviles: interfaces de usuario y realidad aumentada* (PAID 2019-06-11) supported by Universidad Politécnica de Valencia. The third author was supported by the project ANR 2010 BLAN 0202 02 FREC.

class: they are closed under Boolean operations, quotients and inverses of morphisms, but not under product, shuffle, morphisms or star.

Here are the two problems:

Problem 1. *When is the closure of a regular language under [partial]commutation still regular?*

Problem 2. *Are there any robust classes of languages closed under [partial]commutation?*

Apart from group languages, the classes considered in this paper are all closed under polynomial operations. Taking the polynomial closure usually increase robustness. For instance, the class $\text{Pol}(\mathcal{G})$ of polynomials of group languages is closed under union, intersection, quotients, product, shuffle, length-preserving morphisms and inverses of morphisms. There is also a very robust class of languages, denoted \mathcal{W} , which contains $\text{Pol}(\mathcal{G})$ and is closed under union, intersection, quotients, product, shuffle, length-decreasing morphisms and inverses of morphisms [7]. This class is decidable and can be defined as the largest positive variety of languages not containing $(ab)^*$.

Let I be a partial commutation and let D be its complement in $A \times A$. Our main results on Problems 1 and 2 can be summarized as follows:

- (1) The class $\text{Pol}(\mathcal{G})$ is closed under commutation. If D is transitive, it is also closed under I -commutation.
- (2) Under some simple conditions on the graph of I , the closure of a language of $\text{Pol}(\mathcal{G})$ under I is regular.
- (3) The class \mathcal{W} is closed under commutation.
- (4) If I is transitive, the closure of a language of \mathcal{W} under I is regular.

Result (3) is probably the most important of these results. It is, in a sense, optimal since $(ab)^*$ is the canonical example of a regular language whose commutative closure is not regular.

The proofs are nontrivial and combine several advanced techniques, including combinatorial Ramsey type arguments, algebraic properties of the syntactic monoid [6, 7], finiteness conditions on semigroups [14] and properties of insertion systems [4]. A part of these results were first presented in [5].

Our paper is organised as follows. We first survey the known results in Section 2. Then we establish some combinatorial properties, notably on group languages in Section 3. In Section 4, we present two results to compute the closure under I -commutation of a given language. Section 5 is devoted to polynomials of group languages and Section 6 to our main results on the class \mathcal{W} . We conclude the paper by presenting some open problems in Section 7.

1 Definitions and notation

1.1 Words and subwords

In this paper, A denotes a finite alphabet and A^* is the free monoid on A . The empty word is denoted by 1. For each letter a , we denote by $|u|_a$ the number of occurrences of a in u . Thus, if $A = \{a, b\}$ and $u = abaab$, one has $|u|_a = 3$ and $|u|_b = 2$. The sum

$$|u| = \sum_{a \in A} |u|_a$$

is the *length* of the word u .

A word u is a *subword* of v if v can be written as

$$v = v_0 u_1 v_1 u_2 v_2 \cdots u_k v_k$$

where u_i and v_i are words (possibly empty) such that $u_1 u_2 \cdots u_k = u$. For instance, the words *baba* and *acab* are subwords of *abcacbab*.

1.2 Partial commutations

Let A be an alphabet. A *partial commutation* is a symmetric and irreflexive relation on A , often called the *independence relation* in the literature. We denote by \sim_I the congruence on A^* generated by the relations

$$\{(ab, ba) \mid (a, b) \in I\}$$

If L is a language on A^* , we denote by $[L]_I$ the closure of L under \sim_I . A class \mathcal{C} of languages is *closed under I -commutation* if $L \in \mathcal{C}$ implies $[L]_I \in \mathcal{C}$. When I is the relation $\{(a, b) \in A \times A \mid a \neq b\}$, we simplify the notation to \sim and $[L]$, respectively. Thus \sim is the *commutation relation* and $[L]$ is the *commutative closure* of L . A class of languages \mathcal{C} is *closed under commutation* if $L \in \mathcal{C}$ implies $[L] \in \mathcal{C}$.

The *non-commutation relation* (also called *dependence relation*) associated with I , is the relation $D = \{(a, b) \in A \times A \mid (a, b) \notin I\}$. The relations I and D define two (undirected) graphs (A, I) and (A, D) with A as set of vertices.

1.3 Operations on languages

The *marked product* of $k+1$ languages L_0, L_1, \dots, L_k of A^* is a product of the form $L = L_0 a_1 L_1 \cdots a_k L_k$, where a_1, \dots, a_k are letters of A .

The *shuffle product* (or simply *shuffle*) of two languages L_1 and L_2 over A is the language

$$L_1 \sqcup L_2 = \{w \in A^* \mid w = u_1 v_1 \cdots u_n v_n \text{ for some words } u_1, \dots, u_n, \\ v_1, \dots, v_n \text{ of } A^* \text{ such that } u_1 \cdots u_n \in L_1 \text{ and } v_1 \cdots v_n \in L_2\}.$$

The shuffle product defines a commutative and associative operation over the set of languages over A .

Given a class \mathcal{L} of regular languages, the *polynomial closure* of \mathcal{L} , denoted by $\text{Pol}(\mathcal{L})$, consists of the finite unions of languages of the form $L_0 a_1 L_1 \cdots a_k L_k$ where a_1, \dots, a_k are letters and L_0, \dots, L_k are languages of \mathcal{L} . For instance, if \mathcal{I} is the trivial class of languages defined by $\mathcal{I}(A^*) = \{\emptyset, A^*\}$ for each alphabet A , then $\text{Pol}(\mathcal{I})$ is the class of finite unions of languages of the form $A^* a_1 A^* \cdots a_k A^*$, with $a_1, \dots, a_k \in A$.

A *morphism* between two free monoids A^* and B^* is a map $\varphi : A^* \rightarrow B^*$ such that, for all $u, v \in A^*$, $\varphi(uv) = \varphi(u)\varphi(v)$. This condition implies in particular that $\varphi(1) = 1$. We say that φ is *length-preserving* if, for each $u \in A^*$, the words u and $\varphi(u)$ have the same length. Equivalently, φ is length-preserving if, for each letter $a \in A$, $\varphi(a) \in B$. Similarly, φ is *length-decreasing* if the image of each letter is either a letter or the empty word.

1.4 Syntactic ordered monoid

Let L be a regular language of A^* . The *syntactic preorder* of L is the relation \leq_L defined on A^* by : $u \leq_L v$ iff, for every $x, y \in A^*$,

$$xvy \in L \Rightarrow xuy \in L$$

The *syntactic congruence* of L is the relation \sim_L defined on A^* by : $u \sim_L v$ iff, for every $x, y \in A^*$,

$$xvy \in L \Leftrightarrow xuy \in L$$

The *syntactic ordered monoid* of L is $(A^*/\sim_L, \leq_L/\sim_L)$, where \leq_L/\sim_L denotes the order induced by \leq_L on the quotient set A^*/\sim_L .

The syntactic ordered monoid can be computed from the minimal automaton as follows. First observe that if $\mathcal{A} = (Q, A, \cdot, q_-, F)$ is a minimal deterministic automaton, the relation \leq defined on Q by $p \leq q$ if for all $u \in A^*$,

$$q \cdot u \in F \Rightarrow p \cdot u \in F$$

is an order relation, called the *syntactic order*. Then the syntactic ordered monoid of a language is the transition monoid of its ordered minimal automaton. The order is defined by $u \leq v$ if and only if, for all $q \in Q$, $q \cdot u \leq q \cdot v$.

Example 1.1 The minimal deterministic automaton of $(ab)^*$ is represented in Figure 1.1.

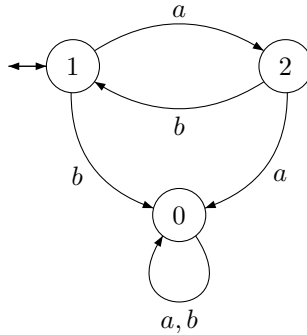

Figure 1.1: The minimal deterministic automaton of $(ab)^*$

The order on the set of states is $1 < 0$ and $2 < 0$. Indeed, one has $0 \cdot u = 0$ for all $u \in A^*$ and thus, the formal implication

$$0 \cdot u \in F \Rightarrow q \cdot u \in F$$

holds for any state q . One can verify that there is no other relations among the states. For instance, 1 and 2 are incomparable since $1 \cdot ab = 1 \in F$ but $2 \cdot ab = 0 \notin F$ and $1 \cdot b = 0 \notin F$ but $2 \cdot b = 1 \in F$.

The syntactic monoid of $(ab)^*$ and its syntactic order are represented below :

Elements		
	1	2
1	1	2
a	2	0
b	0	1
aa	0	0
ab	1	0
ba	0	2

Relations
 $bb = aa = 0$
 $aba = a$
 $bab = b$

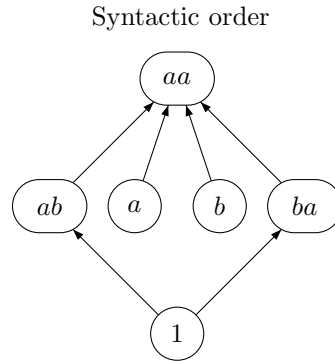

Let M be a finite monoid. The *exponent* of M is the least integer ω such that for all $x \in M$, x^ω is idempotent. Its *period* is the least integer p such that for all $x \in M$, $x^{\omega+p} = x^\omega$. By extension, the *period* (respectively *exponent*) of a regular language is the period (respectively exponent) of its syntactic monoid. The definition of the star-free languages follows the same definition scheme as the one of rational languages, with the difference that the star operation is replaced by the complement. Thus the *star-free* languages of A^* are obtained from the finite languages by using Boolean operations and concatenation product. A well-known result of Schützenberger states that a regular language is star-free if and only if its syntactic monoid has period 1.

Opposite to the star-free languages are the group languages. Recall that a *group language* is a language whose syntactic monoid is a group, or, equivalently, is recognised by a finite deterministic automaton in which each letter defines a permutation of the set of states. Note that if a group language is recognised by a group G , then its period divides $|G|$.

Example 1.2 The set of words over $A = \{a, b\}$ having an even number of subwords equal to ab is a group language whose syntactic monoid is the dihedral group of order 8. A regular expression for this language is

$$(b + a(b(ab^*a)^*b)^*a)^*(1 + a(b(ab^*a)^*b)^*)$$

and its minimal automaton is represented below.

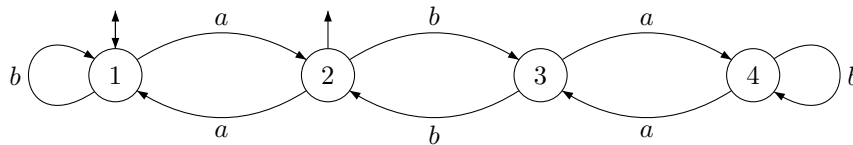

2 Known results

In this section, we briefly survey the known results on our two problems. We also include two easy results, Corollary 2.4 and Proposition 2.6.

2.1 The first problem

For the commutative closure, the problem is solved [37, 17, 18, 19]:

Theorem 2.1 *One can decide whether the commutative closure of a given regular language is regular.*

The commutative closure of the language $(ab)^*$ is not regular since $[(ab)^*] = \{u \in \{a, b\}^* \mid |u|_a = |u|_b\}$. Unfortunately, the class of languages whose commutative closure is regular is not robust. In particular, it is not even closed under intersection as shown in the next example.

Example 2.1 Consider the languages $L_1 = (ab)^* + (ab)^*a^+b^+$ and $L_2 = (ab)^* + (ab)^*b^+a^+$. The commutative closure of these languages is regular, since

$$[L_1] = [L_2] = \{a, b\}^* \setminus (a^+ + b^+)$$

However, $L_1 \cap L_2 = (ab)^*$ and $[(ab)^*]$ is not regular.

For partial commutations, the result of Sakarovitch [38] concluded a series of previous partial results.

Theorem 2.2 *One can decide whether the closure $[L]_I$ of a regular language L is regular if and only if I is a transitive relation.*

The following useful result also holds [12, 11].

Theorem 2.3 *Let I be a partial commutation on A and let L_1, \dots, L_n be languages of A^* . If the languages $[L_1]_I, \dots, [L_n]_I$ are regular, then $[L_1 \cdots L_n]_I$ is regular.*

Corollary 2.4 *Let I be a partial commutation on A and let \mathcal{L} be a set of regular languages on A^* . If, for each language L of \mathcal{L} , $[L]_I$ is regular, then for each language L of $\text{Pol}(\mathcal{L})$, $[L]_I$ is regular.*

Proof. Suppose that, for each language L of \mathcal{L} , $[L]_I$ is regular. We claim that for each language L of $\text{Pol}(\mathcal{L})$, $[L]_I$ is regular. Since, for each family $(L_j)_{j \in J}$ of languages, one has

$$\left[\bigcup_{j \in J} L_j \right]_I = \bigcup_{j \in J} [L_j]_I \quad (1)$$

it suffices to establish the result for a language L of the form $L_0 a_1 L_1 \cdots a_n L_n$, where $L_0, \dots, L_n \in \mathcal{L}$ and a_1, \dots, a_n are letters. Now, since $[a]_I = \{a\}$ for each letter a , the result follows directly from Theorem 2.3. \square

2.2 The second problem

Only a few results are known for the second problem. They concern the following classes of languages:

- (1) the class $\text{Pol}(\mathcal{I})$ of finite unions of languages of the form $A^* a_1 A^* \cdots a_k A^*$, with $a_1, \dots, a_k \in A$,

- (2) the class \mathcal{J} of piecewise testable languages (the Boolean closure of $\text{Pol}(\mathcal{I})$),
- (3) the class $\text{Pol}(\mathcal{J})$, which consists of finite unions of languages of the form $A_0^* a_1 A_1^* \cdots a_k A_k^*$ with $A_i \subseteq A$ and $a_1, \dots, a_k \in A$, also called *APC (Alphabetic Pattern Constraints)* in [2],
- (4) the class $\text{Pol}(\text{Com})$ of polynomials of commutative languages.

Syntactic characterizations are known for \mathcal{J} [39] and for $\text{Pol}(\mathcal{J})$ [35]. The following theorem summarises the results of Guaiana, Restivo and Salemi [20, 21], Bouajjani, Muscholl and Touili [2, 3] and Cécé, Héam and Mainier [9, 10].

Theorem 2.5 *The following properties hold:*

- (1) *the class $\text{Pol}(\mathcal{I})$ is closed under commutation,*
- (2) *the class \mathcal{J} is closed under commutation,*
- (3) *the class $\text{Pol}(\mathcal{J})$ is closed under any partial commutation,*
- (4) *the class $\text{Pol}(\text{Com})$ is closed under any partial commutation.*

Note that neither $\text{Pol}(\mathcal{I})$ nor \mathcal{J} are closed under partial commutation [21, Theorem 15].

We now exhibit another small class closed under any partial commutation. It follows from the definition of Pol that a language belongs to $\text{Pol}(\mathcal{I})$ if and only if it is a *shuffle ideal*, that is, a language of the form $L \sqcup A^*$ for some language L .

Let \mathcal{J}^- be the class of all complements of shuffle ideals. It is a positive variety of languages and the corresponding variety of ordered monoids is defined by the identity $1 \leq x$ (see the dual version of [32, Theorem 6.4]). Further, a language belongs to \mathcal{J}^- if and only if it is closed under taking subwords.

Proposition 2.6 *The class \mathcal{J}^- is closed under any partial commutation.*

Proof. Let L be a language of A^* closed under taking subwords and let I be a partial commutation on A . Let $u \in L$. We claim that if $u \sim_I v$, then for each subword v' of v , there is a subword u' of u such that $u' \sim_I v'$. It suffices to prove the statement for u and v such that $u = xaby$ and $v = xbay$ for some $(a, b) \in I$. Then a simple induction will conclude the proof. Let v' be a subword of v . If v' is a subword of xay or of $xbay$, then it is also a subword of u . Let us now assume that $v' = x'bay'$ for some subword x' of x and some subword y' of y . Let $u' = x'aby'$. Then u' is a subword of u and $u' \sim_I v'$, which proves the claim. It follows that $[L]_I$ is closed under taking subwords. \square

2.3 Star-free languages

Two nice results on star-free languages were proved by Muscholl and Petersen [26]. The first one is the counterpart of Theorem 2.2 for star-free languages.

Theorem 2.7 *Let I be a partial commutation. One can decide whether the closure $[L]_I$ of a star-free language L is star-free if and only if I is a transitive relation.*

The second result is related to our second problem.

Theorem 2.8 *Let I be a partial commutation and let L be a star-free language. If D is transitive, then $[L]_I$ is either star-free or non regular. If D is not transitive, then there exist star-free languages such that $[L]_I$ is regular but not star-free.*

Let us remind the example given in [26]. The language $(abcbac)^*$ is star-free, whereas the language $[L]_{ab=ba} = (((ab + ba)c)^2)^*$ is regular but not star-free.

3 Some combinatorial properties

In this section, we gather together the combinatorial properties that are used in this paper. We first state some consequences of Ramsey's theorem, then we prove some properties of group languages. Finally, we establish a few results on insertion systems.

3.1 Ramsey type properties

In this section, we briefly survey a few consequences of a celebrated result in combinatorics on words, Ramsey's theorem. Similar results can be found for instance in [14, 23, 31], with a slightly different formulation.

Proposition 3.1 *Let M be a finite monoid and let $\pi : A^* \rightarrow M$ be a surjective morphism. For any $n > 0$, there exists $N > 0$ and an idempotent e in M such that, for any $u_0, u_1, \dots, u_N \in A^*$ there exists a sequence $0 \leq i_0 < i_1 < \dots < i_n \leq N$ such that $\pi(u_{i_0}u_{i_0+1} \cdots u_{i_1-1}) = \pi(u_{i_1}u_{i_1+1} \cdots u_{i_2-1}) = \dots = \pi(u_{i_{n-1}} \cdots u_{i_n-1}) = e$.*

When M is a finite group, 1 is the unique idempotent of M and Proposition 3.1 can be simplified as follows:

Corollary 3.2 *Let G be a finite group and let $\pi : A^* \rightarrow G$ be a surjective morphism. Then for any $n > 0$, there exists $N > 0$ such that, for any $u_0, u_1, \dots, u_N \in A^*$ there exists a sequence $0 \leq i_0 < i_1 < \dots < i_n \leq N$ such that $\pi(u_{i_0}u_{i_0+1} \cdots u_{i_1-1}) = \pi(u_{i_1}u_{i_1+1} \cdots u_{i_2-1}) = \dots = \pi(u_{i_{n-1}} \cdots u_{i_n-1}) = 1$.*

3.2 Properties of group languages

In this section, we establish some simple properties of group languages. Let us start with an elementary lemma.

Lemma 3.3 *Let $g_1, g_2, \dots, g_{|G|}$ be a sequence of elements of G . Then there exist two indices i, j with $i \leq j \leq |G|$ such that $g_i \cdots g_j = 1$.*

Proof. Consider the sequence $g_1, g_1g_2, \dots, g_1g_2 \cdots g_{|G|}$. Either one of these elements is equal to 1, or two of them are equal, say $g_1 \cdots g_{i-1} = g_1 \cdots g_j$ with $i \leq j$. In this case, $g_i \cdots g_j = 1$. \square

The next lemma is a kind of insertion property. Let π be a morphism from A^* onto a finite group G , let $R = \pi^{-1}(1)$ and let L be a language recognised by π .

Lemma 3.4 *Let x be a word of R and let u and v be two words. Then $uv \in L$ if and only if $uxv \in L$.*

Proof. If $x \in R$, then $\pi(x) = 1$. It follows that

$$\pi(uxv) = \pi(u)\pi(x)\pi(v) = \pi(u)\pi(v) = \pi(uv)$$

which proves the lemma. \square

We shall also need the following consequence of the previous lemma.

Lemma 3.5 *Let a_1, \dots, a_r be letters, let x be a word of R and let u and v be two words. If $uv \in Ra_1Ra_2R \cdots Ra_rR$, then $uxv \in Ra_1Ra_2R \cdots Ra_rR$.*

Proof. If $uv \in Ra_1Ra_2R \cdots Ra_rR$, then there exist an index i and two words $x', x'' \in A^*$ such that $u \in Ra_1R \cdots Ra_i x'$, $v \in x'' a_{i+1} R \cdots Ra_r R$ and $x' x'' \in R$. Since $x' x'' \in R$ by Lemma 3.4, one gets $uxv \in Ra_1Ra_2R \cdots Ra_rR$. \square

3.3 Insertion systems

An *insertion system* is a special type of rewriting system whose rules are of the form $1 \rightarrow r$ for all r in a given language R . We write $u \rightarrow_R v$ if $u = u' u''$ and $v = u' r u''$ for some $r \in R$. We denote by $\overset{*}{\rightarrow}_R$ the reflexive transitive closure of the relation \rightarrow_R . The closures of a language L of A^* under \rightarrow_R and $\overset{*}{\rightarrow}_R$ are respectively the languages

$$\begin{aligned} [L]_{\rightarrow_R} &= \{v \in A^* \mid \text{there exists } u \in L \text{ such that } u \rightarrow_R v\} \\ [L]_{\overset{*}{\rightarrow}_R} &= \{v \in A^* \mid \text{there exists } u \in L \text{ such that } u \overset{*}{\rightarrow}_R v\} \end{aligned}$$

Recall that a *well quasi-order* on a set E is a reflexive and transitive relation \leq such that for any infinite sequence x_0, x_1, \dots of elements of E , there are two integers $i < j$ such that $x_i \leq x_j$. The results of this section rely on an important result of [4] which extends Higman's theorem on the subword order:

Theorem 3.6 (Bucher, Ehrenfeucht and Haussler) *If H is a finite set of words such that the language $A^* \setminus A^* H A^*$ is finite, then the relation $\overset{*}{\rightarrow}_H$ is a well quasi-order on A^* .*

We are especially interested in the case $R = \pi^{-1}(1)$, where π is a morphism from A^* onto a finite group G . In this case, the set of words that can be derived from a given word has a simple expression. Let us introduce a convenient (but nonstandard!) notation to state this result more easily. Given a word $u = a_1 \cdots a_n$ and a language K , let us denote by $u \uparrow K$ the language $K a_1 K \cdots K a_n K$.

Proposition 3.7 *For each word u of A^* , one has $[u]_{\overset{*}{\rightarrow}_R} = u \uparrow R$.*

Proof. The inclusion of $u \uparrow R$ in $[u]_{\overset{*}{\rightarrow}_R}$ is an immediate consequence of the definitions. For the opposite inclusion, since $u \in u \uparrow R$, it suffices to prove that the language $u \uparrow R$ is closed under \rightarrow_R . But this is just another formulation of Lemma 3.5. \square

Let F be the set of words of R of length $\leq |G|$. Then F is finite by construction. The next lemma states that sufficiently long words contain a factor in F .

Lemma 3.8 *Every word of A^* of length $\geq |G|$ contains a nonempty factor in F .*

Proof. Let $a_1 \cdots a_n$ be a word of length $n \geq |G|$. By Lemma 3.3, there exist two indices i, j , with $i \leq j \leq |G|$ such that $\pi(a_i) \cdots \pi(a_j) = 1$. It follows that $\pi(a_i \cdots a_j) = 1$ and hence $a_i \cdots a_j \in F$. \square

The following result can be viewed as a special case of a well-known result [24, Proposition I.6.4].

Proposition 3.9 *The relations $\xrightarrow{*}_F$ and $\xrightarrow{*}_R$ coincide.*

Proof. Since $F \subseteq R$, it is clear that $u \xrightarrow{*}_F v$ implies $u \xrightarrow{*}_R v$. Since $\xrightarrow{*}_F$ is transitive, it is now sufficient to show that $u \xrightarrow{*}_R v$ implies $u \xrightarrow{*}_F v$. Thus suppose that $u = u'u''$, and $v = u'ru''$ for some $r \in R$. We prove the result by induction on the length of r . If $|r| \leq |G|$, then $r \in F$ and $u \xrightarrow{*}_F v$. Otherwise, Lemma 3.8 shows that r contains a nonempty factor in F . Thus $r = xfy$ with $f \in F$. Further, Lemma 3.4 shows that $xy \in R$. Thus $u \xrightarrow{*}_R u'xyu''$ and by the induction hypothesis, $u \xrightarrow{*}_F u'xyu''$. Now, since $u'xyu'' \xrightarrow{*}_F u'xfyu'' = v$, one has $u \xrightarrow{*}_F v$. \square

Theorem 3.6 now leads to a key property of $\xrightarrow{*}_R$.

Proposition 3.10 *The relation $\xrightarrow{*}_R$ is a well quasi-order on A^* .*

Proof. Lemma 3.8 shows that $A^* \setminus A^*FA^*$ is finite and by Theorem 3.6, $\xrightarrow{*}_F$ is a well quasi-order on A^* . Further, Proposition 3.9 shows that $\xrightarrow{*}_R$ is equal to $\xrightarrow{*}_F$. \square

We now derive an important consequence of Proposition 3.10.

Proposition 3.11 *For each language L of A^* , the language $[L]_{\xrightarrow{*}_R}$ is a polynomial of group languages.*

Proof. Since $\xrightarrow{*}_R$ is a well quasi-order, the language $[L]_{\xrightarrow{*}_R}$ is equal to $[G]_{\xrightarrow{*}_R}$ for some finite language G . Thus $[L]_{\xrightarrow{*}_R}$ is a finite union of languages of the form $[u]_{\xrightarrow{*}_R}$. It follows from Proposition 3.7 that $[L]_{\xrightarrow{*}_R}$ is a polynomial of group languages. \square

Corollary 3.12 *A language L that satisfies $L = [L]_{\xrightarrow{*}_R}$ is a polynomial of group languages.*

Proof. Indeed, the equality $L = [L]_{\xrightarrow{*}_R}$ implies $L = [L]_{\xrightarrow{*}_R}$ and by Proposition 3.11, the language $[L]_{\xrightarrow{*}_R}$ is a polynomial of group languages. \square

4 Computation of $[L]_I$

We have seen that if L is a regular language, then $[L]_I$ is not necessarily regular, which makes the computation of $[L]_I$ a nontrivial problem. This section gathers two results related to this problem.

4.1 Free products

Recall that the *free product* (or *coproduct*) of a family of monoids M_1, \dots, M_n is the free monoid generated by the disjoint union of M_1, \dots, M_n quotiented out by the relations $x_i \cdot y_i = x_i y_i$ ($1 \leq i \leq n$, $x_i, y_i \in M_i$) and the relations $1_i = 1$, where 1_i denotes the identity of M_i ($1 \leq i \leq n$).

Let $(A_1, I_1), \dots, (A_k, I_k)$ be the connected components of the graph (A, I) . Then $\mathcal{P} = \{A_1, \dots, A_k\}$ is a partition of A and A^*/\sim_I is isomorphic to the free product $A_1^*/\sim_{I_1} * \dots * A_k^*/\sim_{I_k}$. For instance, if $A = \{a, b, c, d, e, f, g\}$ and I is the partial commutation represented below

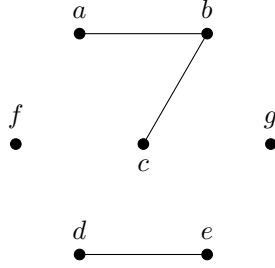

then $\mathcal{P} = \{\{a, b, c\}, \{d, e\}, \{f\}, \{g\}\}$, and

$$A^*/\sim_I = \{a, b, c\}^*/\sim_{I_1} * \{d, e\}^*/\sim_{I_2} * \{f\}^* * \{g\}^*$$

where I_1 and I_2 are defined by $ab \sim_{I_1} ba$, $bc \sim_{I_1} cb$ and $de \sim_{I_2} ed$.

The aim of this section is to construct a generalized automaton recognising $[L]_I$, given the minimal automaton of L . By a *generalized automaton*, we mean a finite automaton in which transitions are labelled by some (non necessarily regular) languages.

Let $\mathcal{A} = (Q, A, \cdot, q_0, F)$ be the minimal automaton of a language L of A^* . Recall that the states of Q are partially ordered by the relation \leq defined by $p \leq q$ if and only if,

$$\text{for all } u \in A^*, q \cdot u \in F \text{ implies } p \cdot u \in F.$$

We now construct a generalized automaton \mathcal{B} over the same set of states Q . The automaton \mathcal{B} also has the same initial state and the same final states as \mathcal{A} . The description of the transitions of \mathcal{B} requires some further notation. For each pair of states (p, q) , let us set

$$K_{p,q} = \{u \in A^* \mid p \cdot u \leq q\}$$

It is easy to see that $K_{p,q}$ is actually an intersection of quotients of L . Let x be a word such that $q_0 \cdot x = p$.

Lemma 4.1 *The following formula holds:*

$$K_{p,q} = \bigcap_{q \cdot y \in F} x^{-1} L y^{-1} \quad (2)$$

Proof. If $u \in K_{p,q}$, then $p \cdot u \leq q$ and thus $q_0 \cdot xu \leq q$. Therefore, if $q \cdot y \in F$, then $q_0 \cdot xy \in F$ by the definition of \leq , whence $xy \in L$ and $u \in x^{-1}Ly^{-1}$.

In the opposite direction, suppose that $u \in x^{-1}Ly^{-1}$ for all words y such that $q \cdot y \in F$. Let us show that $p \cdot u \leq q$. Indeed, if $q \cdot y \in F$, then $u \in x^{-1}Ly^{-1}$, whence $xy \in L$ and $(p \cdot u) \cdot y \in F$. Since this holds for any y such that $q \cdot y \in F$, we have $p \cdot u \leq q$ and hence $u \in K_{p,q}$. \square

Since a regular language has finitely many quotients, Lemma 4.1 shows that the languages $K_{p,q}$ are regular. We now create a transition in \mathcal{B} from p to q labelled by the (non necessarily regular) language

$$R_{p,q} = \bigcup_{1 \leq j \leq k} [K_{p,q} \cap A_j^*]_{I_j}$$

Proposition 4.2 *The generalized automaton \mathcal{B} recognises $[L]_I$.*

Proof. Let $u \in [L]_I$. Let us factorise u as $u = u_1 \cdots u_n$ where all the letters of each u_i belong to the same class of \mathcal{P} , but the letters of two consecutive u_i belong to different classes of \mathcal{P} . Continuing our example, the factorisation of $acbadecbcbagdefg$ would be $(acba)(de)(bcba)(g)(de)(f)(g)$. Since $u \in [L]_I$, there exist some words v_1, \dots, v_n such that $u_1 \sim_I v_1, \dots, u_n \sim_I v_n$ and $v_1 \cdots v_n \in L$.

Let $q_1 = q_0 \cdot v_1, q_2 = q_1 \cdot v_2, \dots, q_n = q_{n-1} \cdot v_n$. Since $v_1 \cdots v_n$ belongs to L , q_n is a final state.



Now, it follows from the definition of the sets $R_{p,q}$ that $u_1 \in R_{q_0,q_1}, \dots, u_n \in R_{q_{n-1},q_n}$. Consequently u is accepted by \mathcal{B} .

In the opposite direction, consider a word u accepted by \mathcal{B} and let



be a successful path of \mathcal{B} labelled by u . This means that q_n is a final state and that $u_1 \in R_{q_0,q_1}, \dots, u_n \in R_{q_{n-1},q_n}$. Consequently, for $1 \leq i \leq n$, there is a single class $A_{\sigma(i)}$ of the partition \mathcal{P} such that $u_i \in [K_{q_{i-1},q_i} \cap A_{\sigma(i)}^*]_{I_{\sigma(i)}}$. According to the definition of the sets $K_{p,q}$, there exist some words $v_1 \in A_{\sigma(1)}^*, \dots, v_n \in A_{\sigma(n)}^*$ such that

- (1) $u_1 \sim_{I_{\sigma(1)}} v_1, \dots, u_n \sim_{I_{\sigma(n)}} v_n$ and
- (2) $q_0 \cdot v_1 \leq q_1, \dots, q_{n-1} \cdot v_n \leq q_n$.

Setting $v = v_1 \cdots v_n$, Property (1) shows that $u \sim_I v$ and Property (2) that $q_0 \cdot v \leq q_n$. Now, by the definition of the order \leq , the condition $q_n \in F$ implies $q_0 \cdot v \in F$ and hence $v \in L$. It follows that $u \in [L]_I$. \square

4.2 The case where D is transitive

It is easy to see that D is transitive if and only if A^*/\sim_I is isomorphic to a direct product of free monoids. For instance, if $A = \{a, b, c, d, e, f, g\}$, and I and D are the relations represented below, then $A^*/\sim_I = \{a, b, c\}^* \times \{d, e\}^* \times \{f\}^* \times \{g\}^*$.

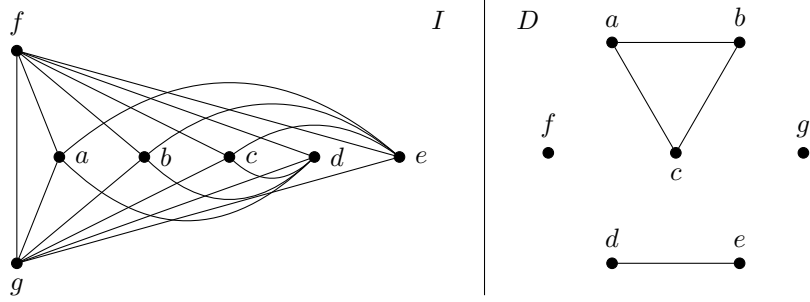

Suppose that $A^*/\sim_I = A_1^* \times \cdots \times A_k^*$. In this case, it is possible to express $[L]_I$ as a shuffle product of k languages (one for each component). Denote by π_j the projection from A^* onto A_j^* , which is the morphism defined by

$$\pi_j(a) = \begin{cases} a & \text{if } a \in A_j \\ 1 & \text{otherwise} \end{cases}$$

and let π_I be the morphism from A^* onto $A_1^* \times \cdots \times A_k^*$ defined by

$$\pi_I(u) = (\pi_1(u), \dots, \pi_k(u))$$

This morphism is intimately connected to our problem, since $u \sim_I v$ if and only if $\pi_I(u) = \pi_I(v)$. In particular, recall that $[L]_I$ is regular if and only if $\pi_I(L)$ is a recognisable subset of $A_1^* \times \cdots \times A_k^*$.

Proposition 4.3 *Let L be a language of A^* . If*

$$\pi_I(L) = \bigcup_{1 \leq i \leq n} L_{i,1} \times \cdots \times L_{i,k} \quad (3)$$

where for $1 \leq j \leq k$, the languages $L_{1,j}, \dots, L_{n,j}$ are languages of A_j^* , then

$$[L]_I = \bigcup_{1 \leq i \leq n} L_{i,1} \sqcup \cdots \sqcup L_{i,k} \quad (4)$$

Proof. Let K denote the right hand side of (4). We first show that $[L]_I$ is a subset of K . Let $u \in [L]_I$. Then there is a word $v \in L$ such that $u \sim_I v$. Let, for $1 \leq j \leq k$, $v_j = \pi_j(v)$. Then $v \in v_1 \sqcup \cdots \sqcup v_k$ and thus $(v_1, \dots, v_k) \in \pi_I(L)$. Therefore, one has $(v_1, \dots, v_k) \in L_{i,1} \times \cdots \times L_{i,k}$ for some $i \in \{1, \dots, n\}$. Now, since $u \sim_I v$, the projections of u and v on each A_j^* coincide. It follows that $u \in v_1 \sqcup \cdots \sqcup v_k$ and hence $u \in L_{i,1} \sqcup \cdots \sqcup L_{i,k}$ and finally $u \in K$.

To prove the opposite inclusion, consider a word $u \in K$. Then one has $u \in L_{i,1} \sqcup \cdots \sqcup L_{i,k}$ for some $i \in \{1, \dots, n\}$. Therefore, there exist some words $v_1 \in L_{i,1}, \dots, v_k \in L_{i,k}$ such that $u \in v_1 \sqcup \cdots \sqcup v_k$. Now, since $(v_1, \dots, v_k) \in L_{i,1} \times \cdots \times L_{i,k}$, one gets by (3) $(v_1, \dots, v_k) \in \pi_I(L)$. Consequently, there exists a word $v \in L$ such that $\pi_I(v) = (v_1, \dots, v_k)$, that is $v \in v_1 \sqcup \cdots \sqcup v_k$. It follows that the projections of u and v on each A_j^* coincide and hence $u \sim_I v$. Thus $u \in [L]_I$. \square

5 Polynomials of group languages

Let us first recall some basic facts about polynomial of group languages. Recall that a *positive variety* of languages is a class of regular languages closed under union, intersection, quotients and inverses of morphisms.

Theorem 5.1 *The class $\text{Pol}(\mathcal{G})$ is a positive variety of languages closed under shuffle, product and marked product.*

Proof. It was shown in [36] that $\text{Pol}(\mathcal{G})$ is a positive variety of languages corresponding to the variety of finite ordered monoids \mathbf{PG}^+ . It follows then from the results of [7] that $\text{Pol}(\mathcal{G})$ is closed under shuffle. It is also closed under marked product by construction.

Let L and L' be two languages. Then

$$LL' = \begin{cases} \bigcup_{a \in A} La(a^{-1}L') & \text{if } 1 \notin L' \\ \bigcup_{a \in A} La(a^{-1}L') \cup L & \text{if } 1 \in L' \end{cases}$$

Let now L and L' be two group languages. Since group languages are closed under quotients, $a^{-1}L'$ is a group language. It follows that LL' belongs to $\text{Pol}(\mathcal{G})$ and it follows immediately that $\text{Pol}(\mathcal{G})$ is closed under product. \square

We now prove a result which should be compared to Corollary 2.4

Theorem 5.2 *Let I be partial commutation on A . If, for each group language K of A^* , $[K]_I$ is a polynomial of group languages, then for each polynomial of group languages L of A^* , $[L]_I$ is a polynomial of group languages.*

The short proof below was communicated to us by Pierre-Cyrille Héam.

Proof. Suppose that for each group language K of A^* , $[K]_I$ is a polynomial of group languages. Let now L be a polynomial of group languages of A^* . By Corollary 2.4, $[L]_I$ is regular. Further, [33, Theorem 7.1] shows that L is open in the pro-group topology, which means that L is a (possibly infinite) union of group languages. By assumption, if K is a group language, then $[K]_I$ is a polynomial of group languages and hence is open. It follows that $[L]_I$ is a union of open sets and hence is also open. Therefore $[L]_I$ is an open regular language and by [33, Theorem 7.1] again, it is a polynomial of group languages. \square

5.1 Commutative closure

The main result of this section states that the commutative closure of a group language is regular, and is in fact a polynomial of group languages. We start with a proof of the weaker property, which relies only on Ramsey type arguments and will serve as a guide for the more technical proof of Theorem 6.2.

Theorem 5.3 *The commutative closure of a group language is regular.*

Proof. Let $L \subseteq A^*$ be a group language and let $\pi : A^* \rightarrow G$ be its syntactic morphism. Let $n = |G|$ and let N be the integer given by Corollary 3.2. We claim that for any letter $a \in A$, $a^N \sim_{[L]} a^{N+n}$. Let $g = \pi(a)$.

Suppose that $xa^Ny \in [L]$. Then there exists a word w of L commutatively equivalent to xa^Ny . It follows that wa^n is commutatively equivalent to $xa^{N+n}y$. Further, since G is a finite group, one has $g^n = 1$ by Lagrange's theorem, whence $\pi(wa^n) = \pi(w)\pi(a^n) = \pi(w)$. Thus the words w and wa^n have the same syntactic image by π and hence $wa^n \in L$. Therefore $xa^{N+n}y \in [L]$.

Conversely, assume that $xa^{N+n}y \in [L]$. Then $xa^{N+n}y$ is commutatively equivalent to some word of L , say $w = u_0au_1a \cdots u_{N-1}au_Nau_{N+1}$. By applying Corollary 3.2 to the sequence of words u_0a, u_1a, \dots, u_Na , we obtain a sequence $0 \leq i_0 < i_1 < \dots < i_n \leq N$ such that

$$\pi(u_{i_0}a \cdots au_{i_1-1}a) = \pi(u_{i_1}a \cdots au_{i_2-1}a) = \dots = \pi(u_{i_{n-1}}a \cdots au_{i_n-1}a) = 1 \quad (5)$$

This implies in particular

$$\pi(u_{i_0}a \cdots au_{i_1-1}a) = \pi(u_{i_1}a \cdots au_{i_2-1}a) = \dots = \pi(u_{i_{n-1}}a \cdots au_{i_n-1}a) = g^{-1} \quad (6)$$

Let r and s be the words defined by

$$w = r(u_{i_0}a \cdots au_{i_1-1}a)(u_{i_1}a \cdots au_{i_2-1}a)(u_{i_{n-1}}a \cdots au_{i_n-1}a)s$$

Since w is commutatively equivalent to $xa^{N+n}y$, the word

$$w' = r(u_{i_0}a \cdots au_{i_1-1}a)(u_{i_1}a \cdots au_{i_2-1}a) \cdots (u_{i_{n-1}}a \cdots au_{i_n-1}a)s$$

is commutatively equivalent to xa^Ny . Furthermore, Formulas (5) and (6) show that $\pi(w) = \pi(r)\pi(s)$ and $\pi(w') = \pi(r)(g^{-1})^n\pi(s)$. Since $(g^{-1})^n = 1$ by Lagrange's theorem, $\pi(w) = \pi(w')$ and thus $w' \in L$. It follows that $xa^Ny \in [L]$, which proves the claim.

Now, the syntactic monoid of $[L]$ is a commutative monoid in which each generator has a finite index. Since the alphabet is finite, this monoid is finite and thus $[L]$ is regular. \square

Theorem 5.3 indicates that the commutative closure of a group language is a commutative regular language. One may wonder whether, in turn, any commutative regular language is the commutative closure of a group language. The answer is no, but requires an improved version of Theorem 5.3.

Theorem 5.4 *The commutative closure of a group language is a polynomial of group languages.*

Proof. Let L be a group language, let $\pi : A^* \rightarrow G$ be its syntactic morphism and let $R = \pi^{-1}(1)$. Let K be the commutative closure of L . We claim that $K = [K]_{\rightarrow R}$. It suffices to prove that if $xy \in K$ and $r \in R$, then $xry \in K$. Since $xy \in K$, there exists a word $v \in L$ which is commutatively equivalent to xy . Thus the word vr is commutatively equivalent to xry . Now, since $\pi(r) = 1$, one gets

$$\pi(vr) = \pi(v)\pi(r) = \pi(v)$$

Therefore $vr \in L$ and $xry \in K$, which proves the claim. It follows by Corollary 3.12 that K is a polynomial of group languages. \square

Example 5.1 Let $A = \{a, b\}$ and let L be the group language of A^* accepted by the automaton represented below.

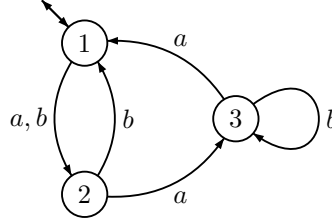

Thus L is recognised by the group of all permutations of a three-element set. Its commutative closure is the language $L_1 + (a^3)^* + (b^2)^* + (b^2)^*ab(b^2)^* + (b^2)^*ba(b^2)^*$, where $L_1 = A^*aA^*aA^*bA^* + A^*aA^*bA^*aA^* + A^*bA^*aA^*aA^*$. Its minimal automaton is the following

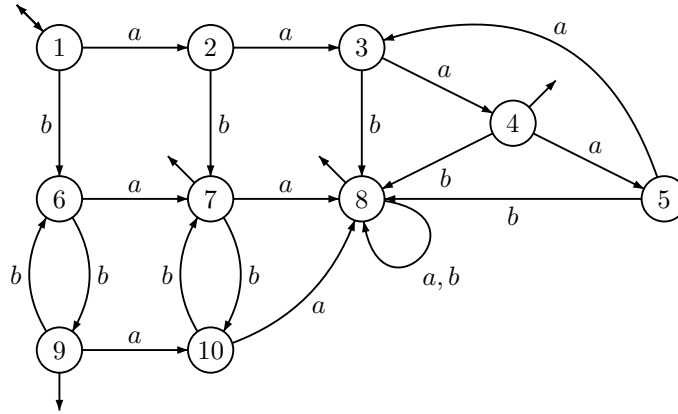

Finally, one can write $[L]$ as a polynomial of group languages as follows: $[L] = L_1 + L_2$ where L_2 is the group language defined by

$$L_2 = \{u \in A^* \mid |u|_a \equiv 0 \pmod 3 \text{ and } |u|_b \equiv 0 \pmod 2 \text{ or } |u|_a \equiv 1 \pmod 3 \text{ and } |u|_b \equiv 1 \pmod 2\}.$$

The next example shows that the commutative closure of a group language is not in general a group language.

Example 5.2 Let L be the set of words over $A = \{a, b\}$ having an odd number of subwords equal to ab . Then L is a group language, but its commutative closure $A^*aA^*bA^* \cup A^*bA^*aA^*$ is not a group language.

Theorem 5.4 can be extended to polynomials of group languages.

Corollary 5.5 *The commutative closure of a polynomial of group languages is also a polynomial of group languages.*

Proof. This is an immediate consequence of Theorems 5.2 and 5.4. Here is another proof, which does not rely on topological arguments.

It is shown in [33] that for any polynomial of group languages L , there exists a morphism $\pi : A^* \rightarrow G$ from A^* onto a finite group G such that L is a

finite union of monomials of the form $Ra_1R \cdots Ra_nR$, where $R = \pi^{-1}(1)$ and a_1, \dots, a_n are letters of A . Clearly, it suffices to prove the theorem when L is one of these monomials. Let K be its commutative closure. By Corollary 3.12, it suffices to prove that $K = [K]_{\rightarrow R}$ to show that K is a polynomial of group languages.

Let x, y and r be words such that $xy \in K$ and $r \in R$. Let v be a word of L commutatively equivalent to xy . Then vr is commutatively equivalent to xyr . As an element of L , v can be written as $r_0a_1r_1 \cdots a_nr_n$ for some words $r_0, \dots, r_n \in R$. Thus $vr \in L$ since $r_nr \in R$. It follows that $xry \in K$ and hence $K = [K]_{\rightarrow R}$. \square

5.2 Closure under partial commutations

Some of the results of Section 5.1 can be extended to partial commutations, usually under some restrictions on the set I . We consider the following subcases: first when D consists of a clique and some isolated vertices, then the more general case where D is transitive and finally an extension of this latter case.

5.2.1 A simple case

We first consider the case when D consists of a clique and some isolated vertices. An example is represented below, with $A = \{a, b, c, d, e\}$.

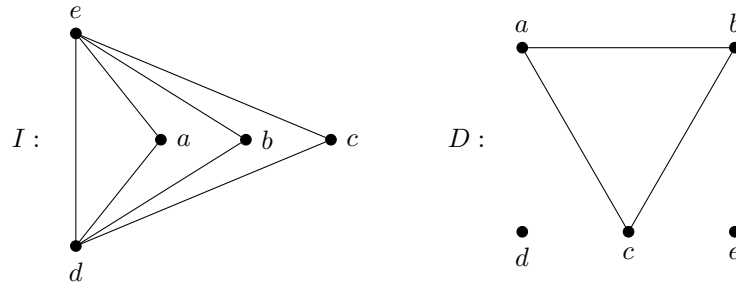

In this case, it is not too hard to modify the proofs of Theorem 5.4 and Corollary 5.5 to obtain the following results:

Theorem 5.6 *Let I be a partial commutation such that D consists of a clique and some isolated vertices. If L is a group language, then $[L]_I$ is a polynomial of group languages.*

Proof. Let L be a group language, let $\pi : A^* \rightarrow G$ be its syntactic morphism and let $R = \pi^{-1}(1)$. We also denote by B the set of vertices of the clique D and by C the set $A \setminus B$. For instance, in our example, we get $B = \{a, b, c\}$ and $C = \{d, e\}$. We claim that the language $K = [L]_I$ satisfies $K = [K]_{\rightarrow R}$. Let $u \in K$ and let $r \in R$. Let us write u as $u_0b_1u_1 \cdots b_ku_k$, where $b_1, \dots, b_k \in B$ and $u_0, \dots, u_k \in C^*$. If $u = xy$, there is an index i and a factorisation $u_i = u'_i u''_i$ such that $x = u_0b_1u_1 \cdots b_i u'_i$ and $y = u''_i b_{i+1} u_{i+1} \cdots b_k u_k$.

Since $u \in K$, there exists a word $v \in L$ such that $u \sim_I v$. It follows that $\pi_B(u) \sim_I \pi_B(v)$ and since the restriction of I to $B \times B$ is the equality, one can write v as $v_0b_1v_1 \cdots b_kv_k$ with $v_0, \dots, v_k \in C^*$. Further, since $\pi_C(u) \sim_I$

$\pi_C(v)$ and since the restriction of I to $C \times C$ is a total commutation, one has $u_0 u_1 \cdots u_k \sim_I v_0 v_1 \cdots v_k$.

Consider the word $w = (v_0 b_1 v_1 \cdots v_{i-1} b_i) r (v_i b_{i+1} \cdots b_k v_k)$. Since $\pi(r) = 1$, one gets

$$\begin{aligned} \pi(w) &= \pi(v_0 b_1 v_1 \cdots v_{i-1} b_i) \pi(r) \pi(v_i b_{i+1} \cdots b_k v_k) \\ &= \pi(v_0 b_1 v_1 \cdots v_{i-1} b_i) \pi(v_i b_{i+1} \cdots b_k v_k) = \pi(v) \end{aligned}$$

and hence $w \in L$. Further, since the letters of C commute with any other letter and since $u_0 u_1 \cdots u_k \sim_I v_0 v_1 \cdots v_k$, one gets

$$\begin{aligned} w &\sim_I b_1 \cdots b_i r b_{i+1} \cdots b_k v_0 \cdots v_k \\ &\sim_I b_1 \cdots b_i r b_{i+1} \cdots b_k u_0 \cdots u_k \sim_I xry \end{aligned}$$

It follows that $w \sim_I xry$ and hence $xry \in K$, which proves the claim. The result now follows from Corollary 3.12. \square

Corollary 5.7 *Let I be a partial commutation such that D consists of a clique and some isolated vertices. If L is a polynomial of group languages, then $[L]_I$ is a polynomial of group languages.*

Proof. The proof is similar to that of Corollary 5.5. \square

5.2.2 The case where D is transitive

In this section we extend the results of Section 5.2.1 to the more general case where D is transitive, already considered in Section 4.2.

The proof we present is totally different from that of Theorem 5.6, which does not seem to generalize easily to the transitive case. We adapt an argument from [6, Proposition 9.6] to compute $\pi_I(L)$ in the special case of a group language. Let $\pi : A^* \rightarrow G$ be the syntactic morphism of a group language L .

Proposition 5.8 *Let $N = k|G|^{k+2}$ and, for $1 \leq i \leq k$, let $R_i = A_i^* \cap \pi^{-1}(1)$. Then the following formula holds:*

$$\pi_I(L) = \bigcup (u_1 \uparrow R_1) \times \cdots \times (u_k \uparrow R_k) \quad (7)$$

where the union runs over the set E of k -tuples of words $(u_1, \dots, u_k) \in \pi_I(L)$ such that $|u_1|, \dots, |u_k| \leq N$.

Proof. First observe that the conditions

$$(u_1 \dots, u_k) \in \pi_I(L) \quad \text{and} \quad L \cap (u_1 \sqcup \cdots \sqcup u_k) \neq \emptyset$$

are equivalent. We shall use freely this remark in the remainder of the proof.

Let K denote the right hand side of (7). We first prove that K is a subset of $\pi_I(L)$. If t is a k -tuple of K , there is a k -tuple $(u_1 \dots, u_k) \in E$ such that

$$t = (r_{1,0} a_{1,1} r_{1,1} \cdots a_{1,n_1} r_{1,n_1}, \dots, r_{k,0} a_{k,1} r_{k,1} \cdots a_{k,n_k} r_{k,n_k})$$

where, for $1 \leq i \leq k$, $u_i = a_{i,1} \cdots a_{i,n_i}$ and $r_{i,j} \in R_i$ for $0 \leq j \leq n_i$.

Since $(u_1, \dots, u_k) \in E$, there exists a word $u \in L$ such that $\pi_I(u) = (u_1, \dots, u_k)$.

Thus u belongs to $u_1 \sqcup \dots \sqcup u_k$. Let us replace each letter $a_{i,j}$ in u by the word $r_{i,j-1}a_{i,j}$ if $j < n_i$ and by $r_{i,n_i-1}a_{i,n_i}r_{i,n_i}$ if $j = n_i$. Let us do this operation for $1 \leq i \leq k$ and $1 \leq j \leq n_i$. Since $\pi(r_{i,j}) = 1$ for all i, j , the resulting word v has the following properties:

- (1) for $1 \leq i \leq k$, $\pi_i(v) = r_{i,0}a_{i,1}r_{i,1} \cdots a_{i,n_i}r_{i,n_i}$ and hence $\pi_I(v) = t$,
- (2) $\pi(v) = \pi(u)$ and thus $v \in L$.

It follows that $t \in \pi_I(L)$ and therefore K is a subset of $\pi_I(L)$.

In the opposite direction, consider a k -tuple $t = (u_1, \dots, u_k) \in \pi_I(L)$. We prove that $t \in K$ by induction on $|t| = |u_1| + \dots + |u_k|$. First assume that $|t| \leq N$. Then $t \in E$ and thus $t \in (u_1 \uparrow R_1) \times \dots \times (u_k \uparrow R_k)$, since $1 \in R_i$ for $1 \leq i \leq k$. It follows that t belongs to K .

We may now assume that $|t| > N$. By assumption, there is a word $u \in L$ such that $\pi_I(u) = (u_1, \dots, u_k)$. First suppose that, for some i , u contains a factor of length $\geq |G|$ in A_i^* . Then by Lemma 3.8, this factor contains a nonempty factor in R_i and thus $u = u'xu''$ with $x \in R_i \cap A^+$. It follows by Lemma 3.4 that $u'u'' \in L$. Further, x is also a factor of u_i , so that $u_i = u'_i x u''_i$. Let $t' = \pi_I(u'u'')$. Then $t' = (u_1, \dots, u_{i-1}, u'_i u''_i, u_{i+1}, \dots, u_k)$ and since $|t'| < |t|$, one gets $t' \in K$ by the induction hypothesis. Therefore, there is a k -tuple $(v_1, \dots, v_k) \in E$ such that $t' \in (v_1 \uparrow R_1) \times \dots \times (v_k \uparrow R_k)$. In particular, $u'_i u''_i \in v_i \uparrow R_i$ and by Lemma 3.5, $u_i = u'_i x u''_i \in v_i \uparrow R_i$. It follows that $t \in (v_1 \uparrow R_1) \times \dots \times (v_k \uparrow R_k)$ and hence $t \in K$.

Suppose now that u has no factor of length $\geq |G|$ in A_i^* . Let us factorize u as

$$u = u_{1,1}u_{1,2} \cdots u_{1,k}u_{2,1} \cdots u_{2,k} \cdots u_{n,1} \cdots u_{n,k}$$

where, for $1 \leq j \leq n$ and $1 \leq i \leq k$, $u_{j,i} \in A_i^*$ and $u_{j,1} \cdots u_{j,k} \neq 1$. For instance, if $A_1 = \{a, b\}$, $A_2 = \{c\}$ and $A_3 = \{d, e\}$, the factorization of the word $cabddabcade$ would be $(1)(c)(1)(ab)(1)(dd)(ab)(c)(1)(a)(1)(de)$. Since u has no factor of length $\geq |G|$ in A_i^* , the length of each word $u_{j,i}$ is strictly less than $|G|$. On the other hand, $|u| = |t| > N$ and thus $n > |G|^{k+1}$. Note that

$$\pi_I(u) = (u_{1,1} \cdots u_{n,1}, u_{1,2} \cdots u_{n,2}, \dots, u_{1,k} \cdots u_{n,k})$$

Let, for $1 \leq r \leq n$, g_r be the element of the group G^{k+1} defined by

$$g_r = (\pi(u_{r,1}), \pi(u_{r,2}), \dots, \pi(u_{r,k}), \pi(u_{r,1}u_{r,2} \cdots u_{r,k}))$$

By Lemma 3.3, applied to the group G^{k+1} , there exist two indices i and j , with $i \leq j \leq |G|^{k+1}$ such that $g_i \cdots g_j = (1, \dots, 1)$ which means that for $1 \leq s \leq k$, $u_{i,s} \cdots u_{j,s} \in R_s$ and that $(u_{i,1}u_{i,2} \cdots u_{i,k}) \cdots (u_{j,1}u_{j,2} \cdots u_{j,k}) \in \pi^{-1}(1)$. Now, since $u \in L$, it follows by Lemma 3.4 that

$$(u_{1,1} \cdots u_{1,k}) \cdots (u_{i-1,1} \cdots u_{i-1,k})(u_{j+1,1} \cdots u_{j+1,k}) \cdots (u_{n,1} \cdots u_{n,k}) \in L$$

Therefore the k -tuple $(u_{1,1} \cdots u_{i-1,1}u_{j+1,1} \cdots u_{n,1}, \dots, u_{1,k} \cdots u_{i-1,k}u_{j+1,k} \cdots u_{n,k})$ belongs to $\pi_I(L)$ and by the induction hypothesis, also belongs to K . It follows by Lemma 3.5 that $(u_{1,1} \cdots u_{n,1}, u_{1,2} \cdots u_{n,2}, \dots, u_{1,k} \cdots u_{n,k})$ belongs to K . Therefore $\pi_I(L) = K$. \square

Theorem 5.9 *Let I be a partial commutation such that D is transitive. If L is a group language, then $[L]_I$ is a polynomial of group languages.*

Proof. It follows from Proposition 5.8 that if L is a group language, then $\pi_I(L) = \bigcup_{1 \leq i \leq n} L_{i,1} \times \cdots \times L_{i,k}$, where each language $L_{i,j}$ is a polynomial of group languages. Since $\text{Pol}(\mathcal{G})$ is closed under shuffle, the result now follows from Proposition 4.3 and more precisely from (4). \square

Corollary 5.10 *Let I be a partial commutation such that D is transitive. If L is a polynomial of group languages, then $[L]_I$ is also a polynomial of group languages.*

Proof. The result follows from Theorems 5.2 and 5.9, but we give also a direct proof.

Since $\text{Pol}(\mathcal{G})$ is closed under shuffle, it suffices, by Proposition 4.3, to prove that if $L \in \text{Pol}(\mathcal{G})$, then $\pi_I(L)$ is a finite union of languages of the form $L_1 \times \cdots \times L_k$, where $L_i \in \text{Pol}(\mathcal{G})(A_i^*)$ for $1 \leq i \leq k$.

Since π_I is a morphism, it preserves union and product. Therefore it suffices to prove the result if L is of the form $L_0 a_1 L_1 \cdots a_n L_n$, where L_0, \dots, L_n are group languages. Theorem 5.9 shows that the result holds for the languages L_0, L_1, \dots, L_n , since they are group languages. Further, if a is a letter, then $\pi_I(a) = (1, \dots, 1, a, 1, \dots, 1)$, where the i -th component is a if and only if $a \in A_i$. It follows that $\pi_I(L_0 a_1 L_1 \cdots a_n L_n)$ is a finite union of languages of the form $R_1 \times \cdots \times R_k$, where each language R_i is a product of the form $S_0 c_1 S_1 \cdots c_r S_r$, with $S_0, \dots, S_r \in \text{Pol}(\mathcal{G})(A_i^*)$ and each c_j is either a letter of A_i or the empty word. But since $\text{Pol}(\mathcal{G})$ is closed under product and marked product, R_i belongs to $\text{Pol}(\mathcal{G})(A_i^*)$. \square

5.2.3 A more general case

Let $(A_1, I_1), \dots, (A_k, I_k)$ be the connected components of the graph (A, I) and put, for $1 \leq j \leq k$,

$$D_j = \{(a, b) \in A_j \times A_j \mid (a, b) \notin I_j\}$$

Theorem 5.11 *Suppose that, for $1 \leq j \leq k$, (A_j, D_j) is transitive. Then, if L is a polynomial of group languages, $[L]_I$ is regular.*

Proof. Formula (2) shows that if $L \in \text{Pol}(\mathcal{G})(A^*)$, then the language $K_{p,q}$ is also in $\text{Pol}(\mathcal{G})(A^*)$. Since $\text{Pol}(\mathcal{G})$ is a positive variety of languages, it is closed under inverse of morphisms. In particular, if ι denotes the identity map from A_j^* into A^* , one has $K_{p,q} \cap A_j^* = \iota^{-1}(K_{p,q})$ and thus $K_{p,q} \cap A_j^*$ belongs to $\text{Pol}(\mathcal{G})(A_j^*)$. If (A_j, D_j) is transitive, it follows from Corollary 5.10 that $R_{p,q}$ is in $\text{Pol}(\mathcal{G})(A^*)$. Finally $[L]_I$ is regular by Proposition 4.2. \square

Note that the condition on I given in the statement of Theorem 5.11 is more general than D be transitive. For instance, the partial commutation of Example 5.3 below satisfies the conditions of Theorem 5.11 but the corresponding set D is not transitive. We now give a simple graph theoretic interpretation of this condition.

Let us adopt a [standard graph terminology](#) [22] and denote respectively by P_3, P_4 and paw the graphs represented below:

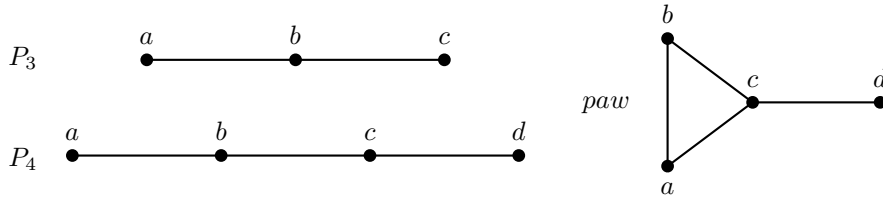

The graph $\text{co-}P_3$ is the complement of the graph P_3 .

We recall a few definitions from graph theory. The *distance* between two vertices of a graph is the number of edges in a shortest path connecting them. The *diameter* of a graph is the greatest distance between two vertices of the graph. Let G and H be two graphs. Let us say that a graph G is H -free if there is no subgraph of G isomorphic to H . A P_4 -free graph is called a *cograph*.

Proposition 5.12 *Let I be a partial commutation, let $(A_1, I_1), \dots, (A_k, I_k)$ be the connected components of the graph (A, I) and let (A_j, D_j) be the complement graph of (A_j, I_j) . Then the following conditions are equivalent:*

- (1) for $1 \leq j \leq k$, (A_j, D_j) is transitive,
- (2) the graph (A, I) is a paw-free cograph.

Proof. (1) implies (2). Suppose that (1) is satisfied but (2) is not. If there is a subgraph of (A, I) isomorphic to P_4 , then the four vertices a, b, c, d are in the same connected component, say (A_j, I_j) . However, (a, d) and (d, b) are in (A_j, D_j) but (a, b) is not. This contradicts the fact that (A_j, D_j) is transitive.

Suppose now there is a subgraph of (A, I) isomorphic to *paw*. Again, (a, d) and (d, b) are in (A_j, D_j) , but (a, b) is not. This contradicts the fact that (A_j, D_j) is transitive.

(2) implies (1). First observe that (A_j, D_j) is transitive if and only if the graph (A_j, I_j) is $(\text{co-}P_3)$ -free. Suppose that (A, I) is a paw-free cograph. Then every graph (A_j, I_j) is a connected paw-free cograph and thus is either triangle-free or $(\text{co-}P_3)$ -free [30]. Therefore it suffices to show that if G is a connected triangle-free cograph, then it is $\text{co-}P_3$ -free. It follows from [13, Theorem 2] that in a connected cograph, every subgraph has diameter ≤ 2 . Suppose that G contains a copy of $\text{co-}P_3$: an edge (a, b) , a vertex c such that nor (c, a) nor (c, b) are edges of G . Since G is connected and has diameter ≤ 2 , there is path of length 2 from c to a , say $(c, d), (d, a)$. Now, since G is triangle-free, (d, b) is not an edge and $(c, d), (d, a), (a, b)$ form a subgraph isomorphic to P_4 , a contradiction. \square

Other characterizations of paw-free cographs can be found in [8]. We can now state the last result of this section.

Theorem 5.13 *Let L be a polynomial of group languages. If the graph (A, I) is a paw-free cograph, then $[L]_I$ is regular.*

One may wonder whether under the conditions of Theorem 5.13, the language $[L]_I$ is a polynomial of group languages. The following example gives a negative answer to this question.

Example 5.3 Let $A = \{a, b, c\}$ and let I be the partial commutation defined by $ab \sim_I ba$. Let L be the set of words having an even number of subwords

equal to ab . Then L is a group language. We claim that $[L]_I$ is not a polynomial of group languages. Indeed, one has $aab \in L$, whence $aba \in [L]_I$. However, for each $n > 0$, one has $abc^n a \notin [L]_I$. It follows by [33, Theorem 7.1] that $[L]_I$ is not a polynomial of group languages.

Example 5.3 also shows that $\text{Pol}(\mathcal{G})$ is not closed under partial commutation.

6 Languages of \mathcal{W}

We now define the class of regular languages \mathcal{W} first introduced and studied in [6, 7].

The class \mathcal{W} is the unique maximal positive variety of languages which does not contain the language $(ab)^*$, for all letters $a \neq b$. It is also the unique maximal positive variety satisfying the two following conditions: it is *proper*, that is, strictly included in the variety of regular languages, and it is closed under the shuffle operation. It is also the largest proper positive variety closed under length-preserving morphisms. Being closed under intersection, union, quotients, shuffle, concatenation, length-decreasing morphisms and inverses of morphisms, \mathcal{W} is a quite robust class, which strictly contains the classes APC, $\text{Pol}(\text{Com})$ and $\text{Pol}(\mathcal{G})$.

The class \mathcal{W} has an algebraic characterization [6, 7] which requires a few auxiliary definitions. Recall that an *ideal* of a monoid M is a subset $I \subseteq M$ such that $MI \subseteq I$. A nonempty ideal I is called *minimal* if, for every nonempty ideal J of M , $J \subseteq I$ implies $J = I$. Every finite monoid admits a unique minimal ideal. Let a and b be two elements of a monoid. Then b is an *inverse of a* if $aba = a$ and $bab = b$. Now, a regular language belongs to \mathcal{W} if and only if its syntactic ordered monoid (M, \leq) satisfies the following condition (*):

For any pair (a, b) of mutually inverse elements of M , and any element z of the minimal ideal of the submonoid generated by a and b , $(abzab)^\omega \leq ab$.

The finite ordered monoids satisfying (*) form a variety of ordered monoids \mathbf{W} [7]. Condition (*) might appear quite involved, but has an important consequence: the variety \mathcal{W} is decidable. That is, given a regular language L , one can decide whether or not L belongs to \mathcal{W} . We also mention for the specialists that \mathbf{W} contains the variety of finite monoids \mathbf{DS} .

6.1 Commutative closure of \mathcal{W}

The main result of this section states that \mathcal{W} is closed under commutative closure. In fact, we prove a stronger result, which relates the period of a language of \mathcal{W} to the period of its commutative closure. We will need the following proposition.

Proposition 6.1 *Let L be a commutative language of A^* and let d be a positive integer. If there exists $N > 0$ such that, for each letter c of A , $c^{N+d} \leq_L c^N$, then L is regular and its period divides d .*

Proof. It follows from [14, Theorem 6.6.2, page 215] that, under these conditions, L is a regular language. Let ω be the exponent of L . The relation

$c^{N+d} \leq_L c^N$ gives $c^{N(\omega-1)}c^{N+d} \leq_L c^{N(\omega-1)}c^N$, whence $c^{N\omega+d} \leq_L c^{N\omega}$ and since $c^\omega \sim_L c^{2\omega} \sim_L c^{N\omega}$, one gets finally $c^{\omega+d} \leq_L c^\omega$. It follows that

$$c^\omega \sim_L c^{\omega+d} \leq_L \dots \leq_L c^{\omega+2d} \leq_L c^{\omega+d} \leq_L c^\omega$$

and hence $c^\omega \sim_L c^{\omega+d}$. Since L is commutative, its syntactic monoid is commutative and therefore $u^\omega \sim_L u^{\omega+d}$ for all $u \in A^*$. It follows that the period of L divides d . \square

The main result of this section can now be stated.

Theorem 6.2 *Let L be a language of $\mathcal{W}(A^*)$. Then $[L]$ belongs to $\mathcal{W}(A^*)$ and its period divides that of L .*

Proof. Let L be a language of $\mathcal{W}(A^*)$ and let $[L]$ be its commutative closure. Since $[L]$ is commutative and since \mathcal{W} contains the variety of commutative languages, proving that $[L]$ belongs to $\mathcal{W}(A^*)$ amounts to show that $[L]$ is regular.

Since $L \in \mathcal{W}(A^*)$, there exist an ordered monoid $(M, \leq) \in \mathbf{W}$, a surjective monoid morphism $\pi : A^* \rightarrow M$ and an order ideal P of (M, \leq) such that $\pi^{-1}(P) = L$. Let ω, p and n be respectively the exponent, the period and the size of M . Let also d be any number such that, for all $t \in M$, t^d is idempotent. In particular, d can be either ω or $\omega + p$. We claim that, for every such d , there exists an integer N such that, for every letter $c \in A$, $c^{N+d} \leq_{[L]} c^N$. If the claim holds, then Proposition 6.1 shows that $[L]$ is regular and that its period divides d . Taking $d = \omega$ and $d = \omega + p$ then proves that this period also divides p .

The rest of the proof consists in proving the claim. We need three combinatorial results. The first one is almost trivial.

Proposition 6.3 *For every $m \in M$, there exists a word u of length $\leq n$ such that $\pi(u) = m$.*

Proof. Let $m \in M$ and let $u = a_1 \dots a_{|u|}$ be a word of minimal length in $\pi^{-1}(m)$. Suppose that $|u| \geq n$. Then, by the pigeonhole principle, two of the $n + 1$ elements $\pi(1), \pi(a_1), \pi(a_1 a_2), \dots, \pi(a_1 \dots a_n)$ are equal, say $\pi(a_1 \dots a_i)$ and $\pi(a_1 \dots a_j)$ with $i < j$. It follows that $\pi(u) = \pi(a_1 \dots a_i a_{j+1} \dots a_{|u|})$, which contradicts the definition of u . Thus $|u| \leq n$. \square

The second one is a slight variation of Proposition 3.1.

Proposition 6.4 *Let c be a letter of an alphabet A . For any $r > 0$, there exists an integer $N = N(r)$ such that, for every word u of A^* containing at least $N + 1$ occurrences of c , there exist an idempotent e of M and a factorization $u = v_0 v_1 c v_2 c \dots v_r c v_{r+1}$ such that, for $1 \leq i \leq r$, $\pi(v_i c) = e$.*

Proof. Let u be a word containing at least $N + 1$ occurrences of c . Let us write this word as $u = u_0 c u_1 c \dots u_N c u_{N+1}$, where, for $0 \leq i \leq N + 1$, $u_i \in A^*$. By Proposition 3.1, applied to the words $u_0 c, \dots, u_N c$, there exist integers $0 \leq i_0 < i_1 < \dots < i_r \leq N$ and an idempotent e of M such that

$$\pi(u_{i_0} c \dots u_{i_1-1} c) = \dots = \pi(u_{i_{r-1}} c \dots u_{i_r-1} c) = e$$

Setting

$$\begin{aligned}
v_0 &= u_0c \cdots u_{i_0-1}c \\
v_1 &= u_{i_0}c \cdots u_{i_1-2}cu_{i_1-1} \\
&\vdots \\
v_r &= u_{i_{r-1}}c \cdots u_{i_r-2}cu_{i_r-1} \\
v_{r+1} &= u_{i_r}c \cdots u_Ncu_{N+1}
\end{aligned}$$

we obtain a factorization $u = v_0v_1c \cdots v_rcv_{r+1}$ such that, for $1 \leq i \leq r$, $\pi(v_ic) = e$. \square

The third one requires an auxiliary definition. A word u of $\{a, b\}^*$ is said to be *balanced* if $|u|_a = |u|_b$.

Proposition 6.5 *Let $B = \{a, b\}$. There exists a balanced word $z \in B^*$ such that, for any morphism $\gamma : B^* \rightarrow M$, $\gamma(z)$ belongs to the minimal ideal of the monoid $\gamma(B^*)$.*

Proof. Let z be a balanced word of B^* containing all words of length $\leq n$ as a factor. Let $\gamma : B^* \rightarrow M$ be a morphism and let m be an element of the minimal ideal J of $\gamma(B^*)$. By Proposition 6.3, applied to γ , there exists a word u of length $\leq n$ such that $\gamma(u) = m$. Since $|u| \leq n$, u is a factor of z and $\gamma(z)$ belongs to $M\gamma(u)M$. Now, since $m \in J$, $M\gamma(u)M = MmM = J$ and hence $\gamma(z) \in J$. \square

Let z be the balanced word given by Proposition 6.5. Let $r = |z|_a = |z|_b$, $n_3 = d(1+r)$, $n_2 = nn_3$ and $n_1 = 3n_2$. Finally let $N = N(n_1)$ be the constant given by Proposition 6.4.

Let $x, y \in A^*$. If $xc^Ny \in [L]$, there exists a word u of L commutatively equivalent to xc^Ny and hence containing at least N occurrences of c . By Proposition 6.4, there exist an idempotent e of M and a factorization

$$u = v_0v_1c \cdots v_{n_1}cv_{n_1+1}$$

such that, for $1 \leq i \leq n_1$, $\pi(v_ic) = e$.

Now, since $n_1 = 3n_2$, one can also write u as

$$u = v_0(f_1g_1) \cdots (f_{n_2}g_{n_2})v_{n_1+1}$$

where, for $1 \leq i \leq n_2$, $f_i = v_{3i-2}cv_{3i-1}$ and $g_i = cv_{3i}c$. The next lemma is the key argument to the proof of Theorem 6.2.

Lemma 6.6 *For $1 \leq i \leq n_2$, the elements $\pi(f_i)$ and $\pi(g_i)$ are mutually inverse.*

Proof. The result follows from the following formulas:

$$\begin{aligned}
&\pi(f_i)\pi(g_i)\pi(f_i) \\
&= \pi(v_{3i-2}c)\pi(v_{3i-1}c)\pi(v_{3i}c)\pi(v_{3i-2}c)\pi(v_{3i-1}c) \\
&= e\pi(v_{3i-1}c) = \pi(v_{3i-2}c)\pi(v_{3i-1}c) = \pi(f_i) \\
&\pi(g_i)\pi(f_i)\pi(g_i) \\
&= \pi(c)\pi(v_{3i}c)\pi(v_{3i-2}c)\pi(v_{3i-1}c)\pi(v_{3i}c) \\
&= \pi(c)e = \pi(c)\pi(v_{3i}c) = \pi(g_i) \quad \square
\end{aligned}$$

Setting $\bar{s} = \pi(c)e$, one gets $\pi(g_i) = \bar{s}$ for $1 \leq i \leq n_2$. Further, by the choice of n_2 and by the pigeonhole principle, one can find n_3 indices $i_1 < \dots < i_{n_3}$ and an element $s \in M$ such that $\pi(f_{i_1}) = \dots = \pi(f_{i_{n_3}}) = s$. Setting

$$\begin{aligned} w_0 &= v_0 f_1 g_1 \cdots f_{i_1-1} g_{i_1-1} & x_1 &= f_{i_1} & y_1 &= g_{i_1} \\ w_1 &= f_{i_1+1} g_{i_1+1} \cdots f_{i_2-1} g_{i_2-1} & x_2 &= f_{i_2} & y_2 &= g_{i_2} \\ & \vdots & & \vdots & & \\ w_{n_3-1} &= f_{i_{n_3-1}+1} g_{i_{n_3-1}+1} \cdots f_{i_{n_3}-1} g_{i_{n_3}-1} & x_{n_3} &= f_{i_{n_3}} & y_{n_3} &= g_{i_{n_3}} \\ w_{n_3} &= f_{i_{n_3}+1} g_{i_{n_3}+1} \cdots f_{n_2} g_{n_2} v_{n_1+1} \end{aligned}$$

we obtain a factorization

$$u = w_0 x_1 y_1 w_1 x_2 y_2 w_2 \cdots w_{n_3-1} x_{n_3} y_{n_3} w_{n_3} \quad (8)$$

such that $\pi(w_1) = \dots = \pi(w_{n_3-1}) = e$, $\pi(x_1) = \dots = \pi(x_{n_3}) = s$ and $\pi(y_1) = \dots = \pi(y_{n_3}) = \bar{s}$.

Recall that $n_3 = d(1+r)$ where $r = |z|_a = |z|_b$. We now define words z_1, \dots, z_d as follows: the word z_j is obtained by replacing in z the first occurrence of a by $x_{d+(j-1)r+1}$, the second occurrence of a by $x_{d+(j-1)r+2}$, \dots , the r^{th} occurrence of a by x_{d+jr} and, similarly, the first occurrence of b by $y_{d+(j-1)r+1}$, the second occurrence of b by $y_{d+(j-1)r+2}$, \dots , the r^{th} occurrence of b by y_{d+jr} . Finally, set

$$u' = w_0 (v_{3i_1-2} c v_{3i_1-1} c z_1 v_{3i_1} c) (v_{3i_2-2} c v_{3i_2-1} c z_2 v_{3i_2} c) \cdots (v_{3i_d-2} c v_{3i_d-1} c z_d v_{3i_d} c) w_1 \cdots w_{n_3} \quad (9)$$

We are now ready for the three final steps.

Lemma 6.7 *The word u' is commutatively equivalent to $xc^{N+d}y$.*

Proof. It is clear that u' is commutatively equivalent to

$$c^d w_0 (v_{3i_1-2} c v_{3i_1-1} c v_{3i_1} c) \cdots (v_{3i_d-2} c v_{3i_d-1} c v_{3i_d} c) (z_1 \cdots z_d) (w_1 \cdots w_{n_3})$$

Now,

$$\begin{aligned} v_{3i_1-2} c v_{3i_1-1} c v_{3i_1} c &= f_{i_1} g_{i_1} = x_1 y_1 \\ & \vdots \\ v_{3i_d-2} c v_{3i_d-1} c v_{3i_d} c &= f_{i_d} g_{i_d} = x_d y_d \end{aligned}$$

Further, by construction, $z_1 \cdots z_d \sim x_{d+1} y_{d+1} \cdots x_{n_3} y_{n_3}$. Therefore $u' \sim c^d w_0 x_1 y_1 w_1 x_2 y_2 w_2 \cdots w_{n_3-1} x_{n_3} y_{n_3} w_{n_3}$ and finally $u' \sim u c^d \sim x c^{N+d} y$. \square

Let T be the submonoid of M generated by s and \bar{s} and let $\gamma : \{a, b\}^* \rightarrow T$ be the morphism defined by $\gamma(a) = s$ and $\gamma(b) = \bar{s}$. By Proposition 6.5, $\gamma(z)$ belongs to the minimal ideal of T and since $e = s\bar{s}$, the definition of \mathbf{W} shows that in M , $(e\gamma(z)e)^d \leq e$.

Lemma 6.8 *One has $\pi(z_1) = \dots = \pi(z_d) = \gamma(z)$.*

Proof. Each of the words z_j is obtained by replacing in z the occurrences of a by some x_k and each occurrence of b by some y_k . Since all the x_k (resp. y_k) have the same image by π , namely s (resp. \bar{s}), $\pi(z_j)$ is equal to $\gamma(z)$. \square

Lemma 6.9 *The word u' belongs to L .*

Proof. It follows from (8) that $\pi(u) = \pi(w_0)e\pi(w_{n_3})$, and hence, since $P = \pi(L)$, $\pi(w_0)e\pi(w_{n_3}) \in P$. Now, observe that

$$\begin{aligned} \pi(v_{3i_1-2}ccv_{3i_1-1}cz_1v_{3i_1}c) &= \pi(v_{3i_1-2}c)\pi(e)\pi(v_{3i_1-1}c)\pi(z_1)\pi(v_{3i_1}c) \\ &= e\pi(c)e\pi(z_1)e = e\bar{s}\gamma(z)e \quad \text{by Lemma 6.8} \end{aligned}$$

By a similar argument, one has

$$\pi(v_{3i_1-2}ccv_{3i_1-1}cz_1v_{3i_1}c) = \dots = \pi(v_{3i_d-2}ccv_{3i_d-1}cz_dv_{3i_d}c) = e\bar{s}\gamma(z)e$$

Finally, since $\pi(w_1) = \dots = \pi(w_{n_3-1}) = e$, it follows from (9) that

$$\pi(u') = \pi(w_0)(e\bar{s}\gamma(z)e)^d\pi(w_{n_3})$$

Furthermore, since $\bar{s} \in T$, $\bar{s}\gamma(z)$ belongs to the minimal ideal of T and since M is in \mathbf{W} , one has $(e\bar{s}\gamma(z)e)^d \leq e$. Since $\pi(L)$ is an order ideal, the element $\pi(w_0)(e\bar{s}\gamma(z)e)^d\pi(w_{n_3})$ is also in $\pi(L)$ and hence $u' \in L$. \square

Putting Lemmas 6.7 and 6.9 together, we conclude that $xc^{N+d}y \in [L]$, which proves the claim and the theorem. \square

Note that there are regular languages outside of \mathcal{W} whose commutative closure is in \mathcal{W} . For instance the language $(ab)^*(a^* + b^*)$ is not in \mathcal{W} but its commutative closure is A^* .

6.2 Partial commutations

In this section, we give two results on partial commutations applied to languages of \mathcal{W} . When I is transitive, we show that if L is a language of \mathcal{W} , then $[L]_I$ is regular. Our second result is similar to Theorem 2.3.

It is also tempting to extend Corollary 5.10 to the languages of \mathcal{W} , but this is not possible. Indeed we exhibit in Example 6.1 a partial commutation I such that D is transitive and a language L of \mathcal{W} such that $[L]_I$ is not regular.

Example 6.1 Consider the alphabet $A = \{a, b, c, d\}$ and the partial commutation relation I (with D transitive) defined by

$$ab \sim_I ba \quad ad \sim_I da \quad bc \sim_I cb \quad cd \sim_I dc$$

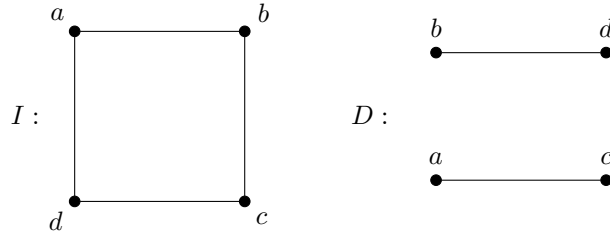

Consider the language

$$L = (abcd)^* + A^*aaA^* + A^*bbA^* + A^*ccA^* + A^*ddA^* + A^*ababA^* + A^*bcbA^* + A^*cdcdA^* + A^*dadaA^*$$

We first show that L belongs to \mathcal{W} and next that $[L]_I$ is not regular.

Let (M, \leq) be the syntactic ordered monoid of L . A short computation, using the software [Semigroupe 2.01](#) [34] shows that M is an aperiodic monoid with zero, containing 170 elements grouped into 4 regular \mathcal{J} -classes and some nonregular \mathcal{J} -classes. These regular \mathcal{J} -classes comprise the singleton $\{1\}$, the minimal ideal $\{0\}$, a unique 0-minimal \mathcal{J} -class with 12 \mathcal{R} -classes and 12 \mathcal{L} -classes and the regular \mathcal{J} -class D represented below:

[*] $bcda$	$bcdab$	bc	bcd
cda	[*] $cdab$	$cdabc$	cd
da	dab	[*] $dabc$	$dabcd$
$abcd$	ab	abc	[*] $abcd$

The presentation of M computed by [Semigroupe](#) has 116 relations and cannot be reproduced here. Similarly, we shall not give the syntactic order in detail, but we mention that the relation $0 \leq x$ holds for all $x \in M$. It follows that if x and y are mutually inverse elements of M such that 0 belongs to the submonoid generated by x and y , then $(xy0xy)^\omega = 0$ and Condition (*) defining \mathbf{W} is trivially satisfied. This covers the trivial case $x = y = 1$ and the cases where x and y belong to the minimal ideal or to the unique 0-minimal ideal. The only remaining case occurs when both x and y belong to D . If x and y are both equal to the same idempotent e of D , Condition (*) is also trivially satisfied. The remaining possibilities for the pair (x, y) are $(abcd, bcd)$, $(bcdab, cda)$, (ab, cd) , $(abc, dabcd)$, (bc, da) and $(cdabd, dab)$. But in all these cases, one gets either $x^2 = 0$ or $y^2 = 0$ and again, Condition (*) is trivially satisfied.

We now show that the language $[L]_I$ is not regular by showing that its syntactic congruence has infinite index. For each $n \geq 0$, set $x_n = (ac)^n$. We claim that if $i \neq j$, then $x_i \not\sim_{[L]_I} x_j$. Indeed, setting $z_i = (bd)^i$, we get $x_i z_i = (ac)^i (bd)^i \in [L]_I$ since $(abcd)^i \in L$ and $(abcd)^i \sim_I (ac)^i (bd)^i$, but $x_j z_i = (ac)^j (bd)^i \notin [L]_I$ since no word u in L satisfies $(ac)^j (bd)^i \sim_I u$. This proves the claim.

6.2.1 The case where I is transitive

Suppose that I is transitive. Let $(A_1, I_1), \dots, (A_k, I_k)$ be the connected components of the graph (A, I) . Then each relation I_j is a total commutation and thus A^*/\sim_I is isomorphic to a *free product* of free commutative monoids. For instance, if $A = \{a, b, c, d, e, f, g\}$, and I and D are the relations represented below, A^*/\sim_I is isomorphic to the free product of the four monoids \mathbb{N}^3 , \mathbb{N}^2 , \mathbb{N} and \mathbb{N} .

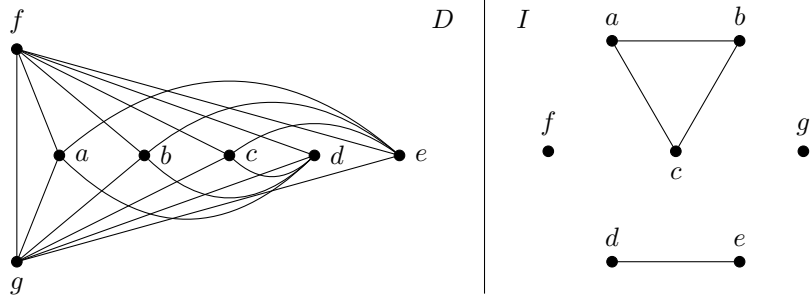

Theorem 6.10 *Let L be a language of $\mathcal{W}(A^*)$ and let I be a transitive partial commutation. Then $[L]_I$ is a regular language.*

Proof. Since \mathcal{W} is closed under quotients, it follows from (2) that $K_{p,q}$ belongs to $\mathcal{W}(A^*)$. Since \mathcal{W} is closed under total commutation by Theorem 6.2, $R_{p,q}$ is also in $\mathcal{W}(A^*)$. Thus the transitions of the automaton \mathcal{B} described in Section 4.1 are regular and $[L]_I$ is regular by Proposition 4.2. \square

We do not know whether $[L]_I$ also belongs to $\mathcal{W}(A^*)$.

6.2.2 Product and partial commutation

Let I be a partial commutation on A and let L_1, \dots, L_n be languages of A^* . Theorem 2.3 shows that if $[L_1]_I, \dots, [L_n]_I$ are regular languages, then the language $[L_1 \cdots L_n]_I$ is regular. We prove in this section a more precise result.

Proposition 6.11 *If $[L_1]_I, \dots, [L_n]_I$ are languages of \mathcal{W} , then $[L_1 \cdots L_n]_I$ is also in \mathcal{W} .*

Proof. Let A_1, \dots, A_n be n disjoint copies of A and let $B = A_1 \cup \dots \cup A_n$. For $1 \leq i \leq n$, let $\lambda_i : A \rightarrow A_i$ be a bijection, which extends to an isomorphism from A^* to A_i^* . Let $X_i = \lambda_i([L_i]_I) \subseteq A_i^*$. Consider the partial commutation J on B defined by

$$J = \{(a, b) \in B^2 \mid a \in A_i, b \in A_j, i \neq j \text{ and } (\lambda_i^{-1}(a), \lambda_j^{-1}(b)) \in I\}$$

By [21, Theorem 6], we have

$$[X_1 \cdots X_n]_J = [A_1^* \cdots A_n^*]_J \cap (X_1 \sqcup \cdots \sqcup X_n). \quad (10)$$

Let $\varphi : B^* \rightarrow A^*$ be the morphism defined, for each $a \in B$, by $\varphi(a) = \lambda_i^{-1}(a)$ if $a \in A_i$. By [21, Theorem 8], we have

$$[L_1 \cdots L_n]_I = \varphi([X_1 \cdots X_n]_J) \quad (11)$$

Now, the language $A_1^* \cdots A_n^*$ is closed under taking subwords and thus belongs to $\mathcal{J}^-(B^*)$. By Proposition 2.6, $[A_1^* \cdots A_n^*]_J$ also belongs to \mathcal{J}^- and hence to $\mathcal{W}(B^*)$, since \mathcal{J}^- is contained in \mathcal{W} . Since \mathcal{W} is a positive variety closed under length-preserving morphisms and under shuffle product, the languages X_i belong to \mathcal{W} and (10) and (11) show that $[L_1 \cdots L_n]_I$ belongs to \mathcal{W} . \square

7 Conclusion and open problems

Our results on commutations can be summarized in a nutshell as follows :

- (1) Both $\text{Pol}(\mathcal{G})$ and \mathcal{W} are closed under commutation.
- (2) If I transitive and if L is in \mathcal{W} , then $[L]_I$ is regular.
- (3) If D transitive and if L is a polynomial of group languages, then so is $[L]_I$.
- (4) If (A, I) is a *paw*-free cograph and if L is a polynomial of group languages, then $[L]_I$ is regular.

Many questions remain open.

- (1) If L is a group language, is $[L]_I$ always regular? The cases where the graph (A, I) is P_4 or *paw* are especially interesting. Note that a positive answer to this question would also show that if L is a polynomial of group languages, then $[L]_I$ is regular.
- (2) If I is a transitive partial commutation and if L is in \mathcal{W} , does $[L]_I$ also belong to \mathcal{W} ?
- (3) If D consists of a single clique and some isolated vertices and if L is in \mathcal{W} , is $[L]_I$ regular?
- (4) Let \mathcal{V} be smallest variety of languages containing the commutative languages and the group languages. Is $\text{Pol}(\mathcal{V})$ closed under [partial] commutation?

Acknowledgements

The authors would like to thank the anonymous referees for several helpful suggestions. The authors would like to thank Pierre-Cyrille Héam for his elegant proof of Theorem 5.2.

References

- [1] A. ACHACHE, Opérateurs de fermeture semi-commutatifs, *Novi Sad J. Math.* **34**,1 (2004), 79–87.
- [2] A. BOUAIJANI, A. MUSCHOLL AND T. TOULI, Permutation Rewriting and Algorithmic Verification, in *Proc. 16th Symp. on Logic in Computer Science (LICS'01)*, pp. 399–409, IEEE Pub., Boston (MA), USA, 2001.
- [3] A. BOUAIJANI, A. MUSCHOLL AND T. TOULI, Permutation Rewriting and Algorithmic Verification., *Information and Computation* **205**,2 (2007), 199–224.
- [4] W. BUCHER, A. EHRENFUCHT AND D. HAUSSLER, On total regulators generated by derivation relations, *Theor. Comput. Sci.* **40**,2-3 (1985), 131–148.
- [5] A. CANO GÓMEZ, G. GUAIANA AND J.-E. PIN, When does partial commutative closure preserve regularity?, in *ICALP 2008, Part II*, L. Aceto and al. (eds.), pp. 209–220, *Lect. Notes Comp. Sci.* vol. 5126, Springer, Berlin, 2008.

- [6] A. CANO GÓMEZ AND J.-E. PIN, On a conjecture of Schnoebelen, in *DLT 2003*, Z. Ésik and Z. Fülöp (eds.), pp. 35–54, *Lect. Notes Comp. Sci.* n° 2710, Springer, Berlin, 2003.
- [7] A. CANO GÓMEZ AND J.-É. PIN, Shuffle on positive varieties of languages, *Theoret. Comput. Sci.* **312** (2004), 433–461.
- [8] D. CARDOSO AND V. LOZIN, On hereditary properties of the class of graphs with convex quadratic stability number, *Journal of Mathematical Sciences* **182** (2012), 227–232.
- [9] G. CÉCÉ, P.-C. HÉAM AND Y. MAINIER, Clôtures transitives de semi-commutations et model-checking régulier, *Technique et Science Informatiques* **27**,1-2 (2008), 7–28.
- [10] G. CÉCÉ, P.-C. HÉAM AND Y. MAINIER, Efficiency of Automata in Semi-Commutation Verification Techniques, *Theoret. Informatics Appl.* **42** (2008), 197–215.
- [11] M. CLERBOUT AND M. LATTEUX, Semi-Commutations, *Information and Computation* **73** (1987), 59–74.
- [12] R. CORI AND D. PERRIN, Automates et commutations partielles, *RAIRO Inform. Théor.* **19**,1 (1985), 21–32.
- [13] D. G. CORNEIL, H. LERCHS AND L. STEWART BURLINGHAM, Complement reducible graphs, *Discrete Appl. Math.* **3**,3 (1981), 163–174.
- [14] A. DE LUCA AND S. VARRICCHIO, *Finiteness and regularity in semigroups and formal languages*, *Monographs in Theoretical Computer Science. An EATCS Series*, Springer-Verlag, Berlin, 1999.
- [15] V. DIEKERT AND Y. MÉTIVIER, Partial commutation and traces, in *Handbook of formal languages, vol. 3: beyond words*, pp. 457–533, Springer-Verlag New York, Inc., New York, NY, USA, 1997.
- [16] V. Diekert and G. Rozenberg (eds.), *The book of traces*, World Scientific Publishing Co. Inc., River Edge, NJ, 1995.
- [17] S. GINSBURG AND E. H. SPANIER, Bounded regular sets, *Proc. Amer. Math. Soc.* **17** (1966), 1043–1049.
- [18] S. GINSBURG AND E. H. SPANIER, Semigroups, Presburger formulas, and languages, *Pacific J. Math.* **16** (1966), 285–296.
- [19] P. GOHON, An algorithm to decide whether a rational subset of \mathbb{N}^k is recognizable, *Theor. Comput. Sci.* **41** (1985), 51–59.
- [20] G. GUAIANA, A. RESTIVO AND S. SALEMI, On the product of trace languages, in *Proc. of the Workshop “Trace theory and code parallelization”*, S. C. R. A. Bertoni, M. Goldwurm (ed.), pp. 54–67, Tech. Rep. n.263-00, 1-2 june 2000, University of Milan, Italy, 2000.
- [21] G. GUAIANA, A. RESTIVO AND S. SALEMI, On the trace product and some families of languages closed under partial commutations, *J. Autom. Lang. Comb.* **9**,1 (2004), 61–79.

- [22] H. N. DE RIDDER ET AL., *Information System on Graph Classes and their Inclusions (ISGCI)*, 2013. <http://www.graphclasses.org/smallgraphs.html#nodes4>.
- [23] M. LOTHAIRE, *Combinatorics on words*, Cambridge University Press, Cambridge, 1997. With a foreword by Roger Lyndon and a preface by Dominique Perrin, corrected reprint of the 1983 original, with a new preface by Perrin.
- [24] M. LOTHAIRE, *Algebraic Combinatorics on Words, Encyclopedia of Mathematics* vol. 90, Cambridge University Press, 2002.
- [25] M. S. L'VOV, Commutative closures of regular semigroup languages, *Kybernetika (Kiev)* **2** (1973), 54–58.
- [26] A. MUSCHOLL AND H. PETERSEN, A note on the commutative closure of star-free languages, *Inform. Process. Lett.* **57**,2 (1996), 71–74.
- [27] E. OCHMAŃSKI AND K. STAWIKOWSKA, On closures of lexicographic star-free languages, in *Automata and formal languages*, pp. 227–234, Univ. Szeged. Inst. Inform., Szeged, 2005.
- [28] E. OCHMAŃSKI AND K. STAWIKOWSKA, Star-free star and trace languages, *Fund. Inform.* **72**,1-3 (2006), 323–331.
- [29] E. OCHMAŃSKI AND K. STAWIKOWSKA, A Star Operation for Star-Free Trace Languages, in *Developments in Language Theory, 11th International Conference, DLT 2007, Turku, Finland*, T. Harju, J. Karhumäki and A. Lepistö (eds.), pp. 337–345, *Lect. Notes Comp. Sci.* vol. 4588, Springer, 2007.
- [30] S. OLARIU, Paw-free graphs, *Inform. Process. Lett.* **28**,1 (1988), 53–54.
- [31] J.-E. PIN, *Varieties of formal languages*, North Oxford, London et Plenum, New-York, 1986. (Traduction de Variétés de langages formels).
- [32] J.-E. PIN, A variety theorem without complementation, *Russian Mathematics (Iz. VUZ)* **39** (1995), 80–90.
- [33] J.-E. PIN, Polynomial closure of group languages and open sets of the Hall topology, *Theoret. Comput. Sci.* **169** (1996), 185–200.
- [34] J.-E. PIN, *Semigroupe 2.01: a software for computing finite semigroups*, 2009. <http://www.liafa.univ-paris-diderot.fr/~jep/Logiciels/Semigroupe2.0/semigroupe2.html>.
- [35] J.-E. PIN AND P. WEIL, Polynomial closure and unambiguous product, *Theory Comput. Systems* **30** (1997), 383–422. Journal version of the article of ICALP 1995.
- [36] J.-E. PIN AND P. WEIL, Semidirect products of ordered semigroups, *Communications in Algebra* **30** (2002), 149–169.
- [37] V. N. RED'KO, On the commutative closure of events, *Dopovidi Akad. Nauk UkraïN. RSR* **1963** (1963), 1156–1159.

- [38] J. SAKAROVITCH, The “last” decision problem for rational trace languages, in *LATIN '92 (São Paulo, 1992)*, pp. 460–473, *Lect. Notes Comp. Sci.* vol. 583, Springer, Berlin, 1992.
- [39] I. SIMON, Piecewise testable events, in *Proc. 2nd GI Conf.*, H. Brackage (ed.), pp. 214–222, *Lect. Notes Comp. Sci.* vol. 33, Springer Verlag, Berlin, Heidelberg, New York, 1975.