

DEFINING THE MECHANISM OF PROSTAGLANDIN E<sub>2</sub>- ENHANCED  
HEMATOPOIETIC STEM AND PROGENITOR CELL HOMING

Jennifer M. Speth

Submitted to the faculty of the University Graduate School  
in partial fulfillment of the requirements  
for the degree  
Doctor of Philosophy  
in the Department of Microbiology and Immunology  
Indiana University

August 2013

Accepted by the Faculty of Indiana University, in partial fulfillment of the requirements for the degree of Doctor of Philosophy.

---

Louis M. Pelus, Ph.D., Chairman

---

Hal E. Broxmeyer, Ph.D.

Doctoral Committee

---

Maureen A. Harrington, Ph.D.

July 19, 2013

---

Mircea Ivan, M.D., Ph.D.

---

Edward F. Srouf, Ph.D.

## Acknowledgements

First and foremost, I would like to thank my mentor, Dr. Louis M. Pelus. Under his tutelage, I gained an enormous amount of knowledge and was exposed to a wide array of educational experiences that not every graduate student gets to have. His trust and patience allowed me to explore many different research avenues. While not all of them were fruitful, I believe I am better prepared for a successful and independent career because of his faith in my scientific judgment. I am truly grateful for his guidance and support over the past five years.

I would also like to thank past and present lab members, Dr. Pratibha Singh, Dr. Peirong Hu, and Kayla Stilger. Their helping hands as well as mental support kept me going through many long and tedious experiments. I particularly would like to thank Dr. Jonathan Hoggatt. Without his guidance and support at the beginning of my tenure in the Pelus lab, I would not be where I am today.

A very special thanks go to my committee members, Dr. Hal E. Broxmeyer, Dr. Maureen A. Harrington, Dr. Mircea Ivan, and Dr. Edward F. Srouf, for always providing me with valuable advice and guidance despite their busy schedules.

Finally, I would like to thank my husband, Nick Speth, who I am extremely fortunate to have in my life. I could not have asked for a more patient and loving partner. I thank him for his incredible support and devotion during my graduate student career, and continued support as I attempt to make my mark within the research community.

## Abstract

Jennifer M. Speth

### DEFINING THE MECHANISM OF PROSTAGLANDIN E<sub>2</sub>- ENHANCED HEMATOPOIETIC STEM AND PROGENITOR CELL HOMING

Hematopoietic stem cell (HSC) transplantation is a lifesaving therapy for a number of hematological disorders. However, to be effective, transplanted HSCs must efficiently “home” to supportive niches within the bone marrow. Limited HSC number and poor function are complications of transplant in some circumstances, and can lead to delayed engraftment and immune reconstitution, or in some cases, bone marrow failure. Enhancing HSC homing is a strategy to improve stem cell transplantation efficiency. We have previously shown that *ex vivo* treatment of mouse or human HSCs with 16-16 dimethyl PGE<sub>2</sub> (dmPGE<sub>2</sub>) increases their bone marrow homing efficiency and engraftment, resulting in part from upregulation of surface CXCR4 expression. We now show that pulse-treatment of mouse or human HSPCs with dmPGE<sub>2</sub> stabilizes HIF1 $\alpha$  in HSPCs, and that similar treatment with the hypoxia mimetic DMOG produces analogous effects to dmPGE<sub>2</sub> on HSPC CXCR4 expression and homing. This suggests that HIF1 $\alpha$  is responsible for PGE<sub>2</sub>'s enhancing effects on HSPCs. Pharmacological inhibition of HIF1 $\alpha$  stabilization *in vitro* with Sodium Nitroprusside (SNP), confirms the requirement of HIF1 $\alpha$  for dmPGE<sub>2</sub>-enhanced migration and CXCR4 upregulation. Additionally, we confirm the requirement for HIF1 $\alpha$  in dmPGE<sub>2</sub>-enhanced *in vivo* homing using a

conditional knockout mouse model of HIF1 $\alpha$  gene deletion. Finally, we validate that the hypoxia response element located 1.3kb from the transcriptional start site within the CXCR4 promoter is required for enhanced CXCR4 expression after PGE<sub>2</sub> treatment. Interestingly, we also observe an increase in the small GTPase Rac1 after dmPGE<sub>2</sub> treatment, as well as a defect in PGE<sub>2</sub>-enhanced migration and CXCR4 expression in Rac1 knockout HSPCs. Using state-of-the-art imaging technology we, confirm an increase in Rac1 and CXCR4 colocalization after dmPGE<sub>2</sub> treatment that likely explains enhanced sensitivity of PGE<sub>2</sub>-treated HSPCs to SDF-1. Taken together, these results define a precise mechanism through which *ex vivo* pulse treatment of HSPC with dmPGE<sub>2</sub> enhances HSPC function through alterations in cell motility and homing, and describe a role for hypoxia and HIF1 $\alpha$  in enhancement of hematopoietic transplantation.

Louis M. Pelus, Ph.D., Chairman

## Table of Contents

List of Tables .....	ix
List of Figures .....	x
List of Abbreviations .....	xii
<b>Chapter 1. Introduction.....</b>	<b>1</b>
Multiple origins of hematopoietic cells.....	1
The Hematopoietic stem cell- Its identification and function .....	2
The Hematopoietic stem cell niche- Roles for CXCR4 and hypoxia .....	11
Hematopoietic stem cell homing and motility.....	18
Prostaglandins- Synthesis, signaling and roles in hematopoiesis .....	23
<b>Chapter 2. HIF1<math>\alpha</math> is necessary for enhanced HSPC homing after PGE<sub>2</sub> treatment .....</b>	<b>30</b>
Introduction.....	30
Materials and Methods .....	32
Mice and human cord blood.....	32
dmPGE <sub>2</sub> and DMOG pulse-exposure.....	32
Flow cytometry analysis.....	33
Analysis of HSPC homing.....	33
Tamoxifen treatment of HIF1 $\alpha$ KO mice.....	34
Migration assays .....	34

Head to head limiting dilution transplants .....	35
Culture of HIF1 $\beta$ mutant cells .....	36
Quantitative real-time PCR .....	36
Western blot analysis.....	36
Luciferase reporter assays .....	37
Statistical analysis .....	37
qRT-PCR Primer sequences.....	38
Results .....	39
PGE <sub>2</sub> and the hypoxia mimetic DMOG stabilize HIF $\alpha$ in HSPCs ....	39
DMOG treatment results in increased HSPC CXCR4 expression <i>in vitro</i> migration to SDF-1 and enhances <i>in vivo</i> homing.....	45
DMOG enhances engraftment.....	50
HIF1 $\alpha$ transcriptional activity is required for PGE <sub>2</sub> -induced CXCR4 Upregulation.....	55
The -1.3kb hypoxia response element is required for PGE <sub>2</sub> -induced CXCR4 upregulation .....	60
HIF1 $\alpha$ is required for CXCR4 upregulation and enhanced migration in PGE <sub>2</sub> -treated HSPCs.....	63
Discussion .....	70

<b>Chapter 3. Rac1: A player in the PGE<sub>2</sub>/HIF1<math>\alpha</math>/CXCR4 axis</b> .....	73
Introduction.....	73
Materials and Methods.....	75
Mice .....	75
dmPGE <sub>2</sub> pulse-exposure.....	75
Flow cytometry analysis.....	75
Migration assays .....	77
Western blot analysis.....	77
Results .....	79
PGE <sub>2</sub> treatment increases the small GTPase Rac1.....	79
PGE <sub>2</sub> treatment increases Rac1 and CXCR4 colocalization.....	82
Rac1, but not Rac2 is required for PGE <sub>2</sub> -enhanced HSPC migration .....	86
Discussion .....	91
<b>Chapter 4. Future Directions</b> .....	93
DMOG in HSC transplants .....	93
Defining the EP receptor responsible for HIF1 $\alpha$ stabilization.....	99
Digging deeper into Rac1's involvement in HSPC motility after PGE <sub>2</sub> treatment.....	105
<b>References</b> .....	109
<b>Curriculum Vitae</b>	



## List of Tables

### Chapter 1

<b>Table 1</b>	qRT-PCR primer sequences.....	38
----------------	-------------------------------	----

## List of Figures

### Chapter 1

<b>Figure 1</b>	Hematopoietic hierarchy .....	9
<b>Figure 2</b>	HIF1 regulation by hypoxia .....	16
<b>Figure 3</b>	GTPase regulation by GEFs and GAPs .....	21
<b>Figure 4</b>	Prostaglandin E <sub>2</sub> biosynthesis .....	24
<b>Figure 5</b>	Prostaglandin signaling through EP receptors.....	28

### Chapter 2

<b>Figure 6</b>	PGE <sub>2</sub> increases HIF1 $\alpha$ protein in mouse and human HSPCS.....	41
<b>Figure 7</b>	PGE <sub>2</sub> increases expression of HIF1 downstream responsive genes.....	43
<b>Figure 8</b>	DMOG increases HSPC CXCR4 and migration to SDF-1 .....	46
<b>Figure 9</b>	DMOG enhances HSPC homing .....	48
<b>Figure 10</b>	DMOG enhances HSC engraftment .....	51
<b>Figure 11</b>	DMOG increases HSC frequency after transplantation .....	53
<b>Figure 12</b>	Mutant HIF $\beta$ cells express CXCR4 and PGE <sub>2</sub> EP receptors .....	56
<b>Figure 13</b>	HIF1 $\alpha$ transcriptional activity is necessary for PGE <sub>2</sub> -induced CXCR4 upregulation .....	58
<b>Figure 14</b>	The -1.3kb HRE is required for enhanced CXCR4 after PGE <sub>2</sub> treatment .....	61
<b>Figure 15</b>	Blockade of HIF1 $\alpha$ stabilization and activity by SNP inhibits PGE <sub>2</sub> -enhanced migration and CXCR4 expression .....	64

<b>Figure 16</b>	Tamoxifen treatment of Cre <sup>+</sup> HIF1 $\alpha$ <sup>flox/flox</sup> mice results in HIF1 $\alpha$ gene deletion.....	66
<b>Figure 17</b>	HIF1 $\alpha$ is required for functional HSPC homing after PGE <sub>2</sub> treatment .....	68
<b>Figure 18</b>	PGE <sub>2</sub> increases Rac1 in HSPCs .....	80
<b>Figure 19</b>	PGE <sub>2</sub> increases Rac1 and CXCR4 colocalization in HSPCs .....	84
<b>Figure 20</b>	Loss of Rac1 abolishes PGE <sub>2</sub> -enhanced HSPC migration .....	87
<b>Figure 21</b>	Rac2 is dispensable for PGE <sub>2</sub> -enhanced HSPC migration .....	89
<b>Figure 22</b>	Cell cycle analysis in SKL after DMOG treatment .....	94
<b>Figure 23</b>	DMOG in HSC transplant .....	97
<b>Figure 24</b>	EP2 and EP4 receptors are necessary for PGE <sub>2</sub> -induced HIF1 $\alpha$ stabilization and CXCR4 upregulation.....	101
<b>Figure 25</b>	Proposed mechanism(s) for PGE <sub>2</sub> 's effects on Rac1 and HIF1 $\alpha$ .....	103
<b>Figure 26</b>	Loss of Rac1 abolishes PGE <sub>2</sub> -enhanced HIF1 $\alpha$ stabilization .....	107

## List of Abbreviations

<b>AA</b>	Arachadonic acid
<b>Adm</b>	Adrenomedullin
<b>AGM</b>	Aorta-gonad-meso-nephros
<b>ALDH</b>	Aldehyde dehydrogenase
<b>ANOVA</b>	Analysis of variance
<b>APC</b>	Allophycocyanin
<b>ARNT</b>	Aryl hydrocarbon receptor nuclear translocator
<b>BFU-E</b>	Burst-forming unit-erythroid
<b>bHLH</b>	Basic helix-loop-helix
<b>BM</b>	Bone marrow
<b>BSA</b>	Bovine serum albumin
<b>CAFC</b>	Cobblestone area-forming cells
<b>cAMP</b>	Cyclic adenosine monophosphate
<b>Cdc42</b>	Cell division cycle 42
<b>cDNA</b>	Complementary deoxyribonucleic acid
<b>CFU</b>	Colony-forming unit
<b>CFU-GEMM</b>	Colony-forming unit-granulocyte, erythroid, macrophage, megakaryocyte
<b>CFU-GM</b>	Colony-forming unit-granulocyte, macrophage
<b>CFU-S</b>	Colony-forming unit-spleen
<b>c-kit</b>	Stem cell factor receptor (CD117)

<b>CLP</b>	Common lymphoid progenitor
<b>CMP</b>	Common myeloid progenitor
<b>CO<sub>2</sub></b>	Carbon dioxide
<b>CoCl<sub>2</sub></b>	Cobalt (II) Chloride
<b>COX</b>	Cyclooxygenase enzyme
<b>cPLA<sub>2</sub></b>	Cytosolic phospholipase A <sub>2</sub>
<b>CRU</b>	Competitive repopulating unit
<b>CXCR4</b>	C-X-C chemokine receptor 4
<b>Cy-7</b>	Cyanine dye 7
<b>DMOG</b>	Dimethyloxallyl glycine
<b>dmPGE<sub>2</sub></b>	16-16 dimethyl prostaglandin E <sub>2</sub>
<b>EMEM</b>	Eagle's minimal essential media
<b>EP</b>	Prostaglandin E <sub>2</sub> receptor
<b>Epo</b>	Erythropoietin
<b>ERT2</b>	Triple-mutant human estrogen receptor
<b>FACS</b>	Fluorescence activated cell sorting
<b>FBS</b>	Fetal bovine serum
<b>FcyR</b>	Immunoglobulin G Fc receptor
<b>FITC</b>	Fluorescein isothiocyanate
<b>GAP</b>	GTPase-activating protein
<b>G-CSF</b>	Granulocyte- colony stimulating factor
<b>GDP</b>	Guanosine diphosphate

<b>GEF</b>	Guanine nucleotide exchange factor
<b>GLUT1</b>	Glucose transporter 1
<b>GMP</b>	Granulocyte macrophage progenitor
<b>GPCR</b>	G-protein coupled receptor
<b>GTP</b>	Guanosine triphosphate
<b>HEK</b>	Human embryonic kidney
<b>HIF1<math>\alpha</math></b>	Hypoxia inducible factor 1-alpha
<b>HIF1<math>\beta</math></b>	Hypoxia inducible factor 1-beta
<b>HI-FBS</b>	Heat-inactivated fetal bovine serum
<b>HPC</b>	Hematopoietic progenitor cell
<b>HPRT</b>	Hypoxanthine phosphoribosyltransferase
<b>HRE</b>	Hypoxia response element
<b>HSC</b>	Hematopoietic stem cell
<b>HSPC</b>	Hematopoietic stem and progenitor cells
<b>IACUC</b>	Indiana University animal care and use committee
<b>IL3R<math>\alpha</math></b>	Interleukin-3 receptor alpha
<b>IL7R<math>\alpha</math></b>	Interleukin-7 receptor alpha
<b>IT-HSC</b>	Intermediate-term hematopoietic stem cell
<b>IUSM</b>	Indiana University School of Medicine
<b>KO</b>	Knockout
<b>LTC-IC</b>	Long-term culture initiating cell
<b>LT-HSC</b>	Long-term hematopoietic stem cell

<b>MEP</b>	Megakaryocyte erythroid progenitor
<b>MPB</b>	Mobilized peripheral blood
<b>NO</b>	Nitric oxide
<b>ODDD</b>	Oxygen-dependent degradation domain
<b>OPN</b>	Osteopontin
<b>PAS</b>	Per-ARNT-Sim
<b>PB</b>	Peripheral blood
<b>PBS</b>	Phosphate buffered saline
<b>PE</b>	Phycoerythrin
<b>PGD<sub>2</sub></b>	Prostaglandin D <sub>2</sub>
<b>PGE<sub>2</sub></b>	Prostaglandin E <sub>2</sub>
<b>PGF<sub>2</sub></b>	Prostaglandin F <sub>2</sub>
<b>PGG<sub>2</sub></b>	Prostaglandin G <sub>2</sub>
<b>PGH<sub>2</sub></b>	Prostaglandin H <sub>2</sub>
<b>PGI<sub>2</sub></b>	Prostaglandin I <sub>2</sub>
<b>PI3K</b>	Phosphoinositide 3-kinase
<b>PKA</b>	Protein kinase A
<b>PKC</b>	Protein kinase C
<b>PLC</b>	Phospholipase C
<b>PVDF</b>	Polyvinylidene fluoride
<b>qRT-PCR</b>	Quantitative real-time polymerase chain reaction
<b>Rac</b>	Ras-related C3 botulinum toxin substrate

<b>RBC</b>	Red blood cell
<b>Rho</b>	Ras homolog
<b>RIPA</b>	Radioimmunoprecipitation assay buffer
<b>RNA</b>	Ribonucleic acid
<b>ROS</b>	Reactive oxygen species
<b>RU</b>	Repopulating units
<b>Sca-1</b>	Stem cell antigen-1
<b>SCF</b>	Stem cell factor
<b>SCID</b>	Severe combined immunodeficient
<b>SDF-1</b>	Stromal derived factor-1
<b>SDS-Page</b>	Sodium dodecyl sulfate polyacrylamide gel electrophoresis
<b>SKL</b>	Sca-1 <sup>pos</sup> , c-kit <sup>pos</sup> , Lineage <sup>neg</sup> cells
<b>SLAM</b>	Signaling lymphocytic activation molecules
<b>SNP</b>	Sodium nitroprusside
<b>ST-HSC</b>	Short-term hematopoietic stem cells
<b>TGF-<math>\alpha</math></b>	Transforming growth factor-alpha
<b>UCB</b>	Umbilical cord blood
<b>VEGF</b>	Vascular endothelial growth factor
<b>VHL</b>	Von-Hippel Lindau
<b>VLA-4</b>	Very late antigen-4
<b>VLA-5</b>	Very late antigen-5
<b>WT</b>	Wild-type



## Chapter 1. Introduction

The human body's blood forming system is a complex network of cells that, through a variety of unique functions, has the ability to provide for physiological demand and adapt and defend against a wide array of pathogens and infections. Blood cell production is maintained throughout the lifetime of the host. Approximately 1 trillion blood cells are produced in one single day in an averaged sized adult male (Ogawa, 1993) to maintain steady state levels in peripheral blood. This continuous production of blood cells is termed "hematopoiesis" after the Greek words *haima* meaning "blood", and *poiein*, meaning "to make". Hematopoiesis is a multifaceted process involving both stochastic and inductive mechanisms, and the focus of this chapter is to provide a brief overview of the main cellular player responsible for hematopoiesis: the hematopoietic stem cell (HSC), including its function, identification, and relationship to environmental mediators, particularly prostaglandins and hypoxia.

### Multiple Origins of Hematopoietic Cells

The origin of blood and blood-forming cells has been at the center of debate for almost an entire century. It is generally accepted that the origin of most primitive hematopoietic cells is the aorta-gonad-meso-nephros (AGM) region of the embryo (Medvinsky & Dzierzak, 1996), and pioneering studies by Moore and Metcalf elegantly showed that the yolk sac is a source of definitive hematopoietic cells (Moore & Metcalf, 1970). More recently, much stronger evidence confirms the yolk sac as being the single origin of definitive adult hematopoietic cells (Tanaka et al., 2012).

Interestingly, studies in the early 20<sup>th</sup> century suggested the presence of a cell in the embryonic yolk sac that could produce both hematopoietic and endothelial cells based on the observation of “blood islands”, in which clusters of red blood cells (RBCs) and macrophages were in close proximity to vascular endothelial cells (Sabin, 1920). However, these precursor cells were not fully identified until recently. Now, studies show the existence of a distinctive population of cells, termed “hemangioblasts”, that can give rise to adult hematopoietic cells as well as endothelial cells (Choi et al., 1998; Ciraci et al., 2011).

### **The Hematopoietic stem cell- Its identification and function**

Hematopoietic stem cells are defined by their ability to self-renew, as well as their ability to differentiate into mature blood cells of all cell lineages. However, the idea that a specific population of cells were capable of and necessary for maintenance of the entire blood system became evident when it was discovered that hematopoiesis could be restored after lethal irradiation, only if bone marrow (BM) and spleen cells were administered to the irradiated recipient (Jacobson et al., 1950a; Jacobson et al., 1950b). Later, more interesting studies performed by Till and McCulloch revealed that there were single clonogenic cells that existed within the bone marrow and when injected into a lethally irradiated host, could create nodules in the spleen that were in similar proportion to the number of cells that were originally injected into the recipients. These cells were also found to have the ability to self-renew and restore hematopoiesis, thus suggesting the existence of a hematopoietic stem cell (Till & McCulloch, 1961; Becker et

al., 1963; Siminovitch et al., 1963; Wu et al., 1968). This assay, termed a colony unit-forming spleen (CFU-S) assay, is still utilized as a surrogate measure of HSCs *in vivo*, although we now know CFU-S is not a measure of true stem cells, but perhaps short-term repopulating hematopoietic progenitor cells (HPCs). In addition to CFU-S, *in vitro* assays such as the cobblestone area-forming cell (CAFC) assay (Ploemacher et al., 1989) and long-term culture initiating cell (LTC-IC) assay (Sutherland et al., 1990) are currently utilized and are also surrogate measures of more immature populations of HPCs.

While the aforementioned assays are still particularly useful for determining the members and function of these progenitor cells, the only true definitive measure of HSC function is the ability to rescue a lethally irradiated host via full reconstitution of the hematopoietic system (Harrison, 1972). Primitive assays involved the transplant of bone marrow cells into irradiated recipients, which were then monitored for a period of weeks for both survival and complete lineage reconstitution. However, this method only reveals the “presence” of HSCs within the graft, and does not quantify the number of HSCs present. Thus, a “competitive” repopulation assay was developed by Harrison in which a donor graft was combined with a “competing” graft and then transplanted into an irradiated recipient (Harrison, 1980). Based on distinct markers on each graft, the contribution (termed “chimerism”) and repopulating ability of each graft could be determined using a formula to calculate repopulating units (RU) (Harrison, 1993).

An even more sensitive method for calculating HSC frequency is the limiting dilution competitive transplant, in which a series of dilutions of the donor graft is “competed” against a constant number of “competitor” cells. Xi-square statistics are

then utilized to calculate a minimum threshold of recipient chimerism (typically set at 2-5%), and the number of recipients per group that are not reconstituted based on this threshold is determined. These “negatives” allow for the frequency of HSCs within the donor grafts to be determined using Poisson statistics (Szilvassy et al., 1990). Typically, sample groups with fewer negatives will possess a higher frequency of HSCs and vice versa.

Common methods for competitive transplants today involve the use of congenic mouse strains possessing two different isoforms of the CD45 antigen, a pan-leukocyte marker. These methods utilize the strains C57Bl6 (expressing CD45.2 antigen) and B6.SJL-PtrcAPep3B/BoyJ (BoyJ) (expressing CD45.1 antigen). These distinct strains can be distinguished by flow cytometry using monoclonal fluorescent-conjugated antibodies, which easily allow for the assessment of donor contribution within the recipient.

Primary transplants are a strong indication of enhanced HSC number and function, however, based on studies in which serial transplantation of CFU-S led to decreased self-renewal capabilities of the donor cells (Vos & Dolmans, 1972; Vos, 1972) it has been suggested that HSCs have varying abilities for long-term self-renewal. This observation, paired with the more recent ability to phenotypically characterize HSC populations by FACS analysis have revealed separate populations of HSCs with differing reconstitution capabilities. HSCs possessing full reconstitution capabilities of up to 16 weeks are termed short-term HSCs (ST-HSCs), whereas intermediate HSCs (IT-HSCs) possess reconstitution abilities for up to 32 weeks, and long-term HSCs (LT-HSCs)

provide reconstitution for longer than 32 weeks (Benveniste et al., 2010). The discovery of these populations emphasizes the importance of performing at least secondary transplants to truly determine long-term HSC reconstitution potential. While a successful primary transplant confirms the presence of both short-term and multipotent progenitors, it does not confirm the presence and self-renewal of LT-HSCs. Successful engraftment and most importantly full multilineage reconstitution after removing primary engrafted cells after 32 weeks and transplanting them into a second recipient, can only result from the presence of LT-HSCs.

With the advent of fluorescence-activated cell sorting (FACS) analysis, the ability to determine the presence and abundance of multiple HSC and HPC populations became possible. However, the characterization of more mature HPC populations was established well before this technology was available. *In vitro* progenitor assays, also known as “colony-forming unit (CFU)” assays have been used since the late 1960’s to measure bone marrow hematopoietic cell clonogenic and regenerative potential.

Depending on the specific growth factors present within semi-solid media, progenitors capable of producing granulocyte-macrophage (CFU-GM) (Bradley & Metcalf, 1966; Ichikawa et al., 1966), erythroid (BFU-E) (Cooper et al., 1974; Iscove & Sieber, 1975), and mixed multipotent (CFU-GEMM) (Fauser & Messner, 1978; Fauser & Messner, 1979; Ash et al., 1981) colonies can be enumerated and consequently, the functional capabilities of the particular cell population can be assessed. With the exception of CFU-GEMM, which appears to have robust secondary replating capacity, but diminished tertiary capacity (Carow et al., 1991), subsequent recloning studies

revealed that these purified lineage-restricted progenitors had limited to no self-renewal capabilities (Purton & Scadden, 2007).

While the pioneering *in vitro* colony assays were the first to allow for functional characterization and clonogenic potential of hematopoietic cell populations, phenotypic identification did not come until later, when FACS analysis allowed for more precise characterization of different stem and progenitor populations. The first population determined to be enriched for hematopoietic stem and progenitor cells (HSPCs) were found to lack markers for mature blood cells such as erythrocytes, neutrophils, macrophages, natural killer cells, T cells and B cells. This population was therefore referred to as Lineage<sup>neg</sup> (Muller-Sieburg et al., 1986). Later, the cell surface markers stem cell antigen-1 (Sca-1) (Spangrude et al., 1988) and stem cell factor (SCF) receptor (c-kit) (Ikuta & Weissman, 1992) were added to further define HSPC populations and this phenotypic designation is still widely accepted as a population that contains HSCs. This particular population will be referred to as Sca-1<sup>pos</sup> c-kit<sup>pos</sup> Lineage<sup>neg</sup> (SKL) cells throughout the remainder of this dissertation.

Murine HSCs can also be identified by their low retention of fluorescent dyes such as Hoechst 33342 and appear as a “side” population when analyzed by flow cytometry. This side population represents approximately 0.05% of whole bone marrow cells and is highly enriched for functional HSCs, even more so that the SKL population (Goodell et al., 1996; Lin & Goodell, 2006). Inconsistent staining and variation based on slight staining modifications can lead to less purified HSC populations, therefore this particular method for identifying HSCs is best when paired with SKL staining.

More recently, a number of different surface markers have been identified that further define HSC based on lineage commitment and multipotency. Most notably, the signaling lymphocytic activation molecule (SLAM) markers, including CD150, CD48 and CD244, in conjunction with SKL markers, define a highly enriched HSC population with long-term renewal capabilities (Kiel et al., 2005; Chen et al., 2008). In addition to SLAM markers, CD34 is commonly used to distinguish long-term versus short-term HSCs. Osawa first discovered that murine hematopoietic cells lacking CD34 expression exhibited multilineage reconstitution ability (Osawa et al., 1996). It is now widely accepted that phenotypic differentiation between long and short-term HSCs is based on CD34 and SLAM expression, where LT-HSCs are defined as Lineage<sup>neg</sup>, c-kit<sup>pos</sup>, Sca-1<sup>pos</sup>, CD34<sup>neg</sup>, SLAM<sup>pos</sup> and ST-HSCs are Lineage<sup>neg</sup>, c-kit<sup>pos</sup>, Sca-1<sup>pos</sup>, CD34<sup>pos</sup>, SLAM<sup>neg</sup> (Weissman & Shizuru, 2008).

Apart from HSCs, progenitor cells can be phenotypically distinguished by a multitude of cell surface markers and differentiation patterns, and can be placed in a differentiation “hierarchy” (Figure 1A). These progenitors include the common myeloid progenitor (CMP), common lymphoid progenitor (CLP), Granulocyte macrophage progenitor (GMP) and Megakaryocyte erythroid progenitor (MEP), all giving rise to the cells indicated in their names. In mice, the CLP population is distinguished by its low expression of both c-kit and Sca-1, as well as expression of IL7R $\alpha$ . It is phenotypically defined as Lineage<sup>neg</sup>, c-kit<sup>low</sup>, Sca-1<sup>low</sup>, IL7R $\alpha$ <sup>pos</sup>. Common myeloid progenitors are distinguished by their lack of Sca-1 expression, and are classified as Lineage<sup>neg</sup>, c-kit<sup>pos</sup>, Sca-1<sup>neg</sup>, CD34<sup>pos</sup>. These progenitors can give rise to both GMP and MEP, which lack Sca-

1 and CD34 expression, and can be distinguished from each other based on expression of FcγR. They are classified as Lineage<sup>neg</sup>, c-kit<sup>pos</sup>, Sca-1<sup>neg</sup>, CD34<sup>neg</sup>, FcγR<sup>pos</sup>, and Lineage<sup>neg</sup>, c-kit<sup>pos</sup>, Sca-1<sup>neg</sup>, CD34<sup>neg</sup>, FcγR<sup>neg</sup> for GMP and MEP, respectively (Kondo et al., 1997; Akashi et al., 2000).

Different from the murine classification, human HSCs are typically defined by their expression of CD34 (Civin et al., 1984; Andrews et al., 1986). However, this population is still heterogeneous for both stem and progenitor cells. With the addition of CD38, human HSCs could be distinguished as mature (CD34<sup>pos</sup> CD38<sup>pos</sup>) and primitive (CD34<sup>pos</sup> CD38<sup>neg</sup>) HSCs (Terstappen et al., 1991), which are analogous to short and long-term HSCs in mice. The Nolte lab introduced an alternative phenotype for identifying human HSCs by expression of aldehyde dehydrogenase activity (ALDH) and CD133 expression. They found that ALDH<sup>hi</sup>CD133<sup>pos</sup>Lineage<sup>neg</sup> populations were highly enriched for long-term repopulating primitive HSCs with reconstitution ability over serial transplantations (Hess et al., 2006). However, for the purpose of this dissertation, human HSPC-containing populations will be defined as CD34<sup>pos</sup>.

Progenitor populations were later defined for CLP, CMP, MEP and GMP populations, and are distinguished from mature progenitors by CD10 expression in the case of CLP populations (Galy et al., 1995), and varying expression levels of IL3Rα for myeloid progenitors (Manz et al., 2002) (Figure 1B).



Figure 1

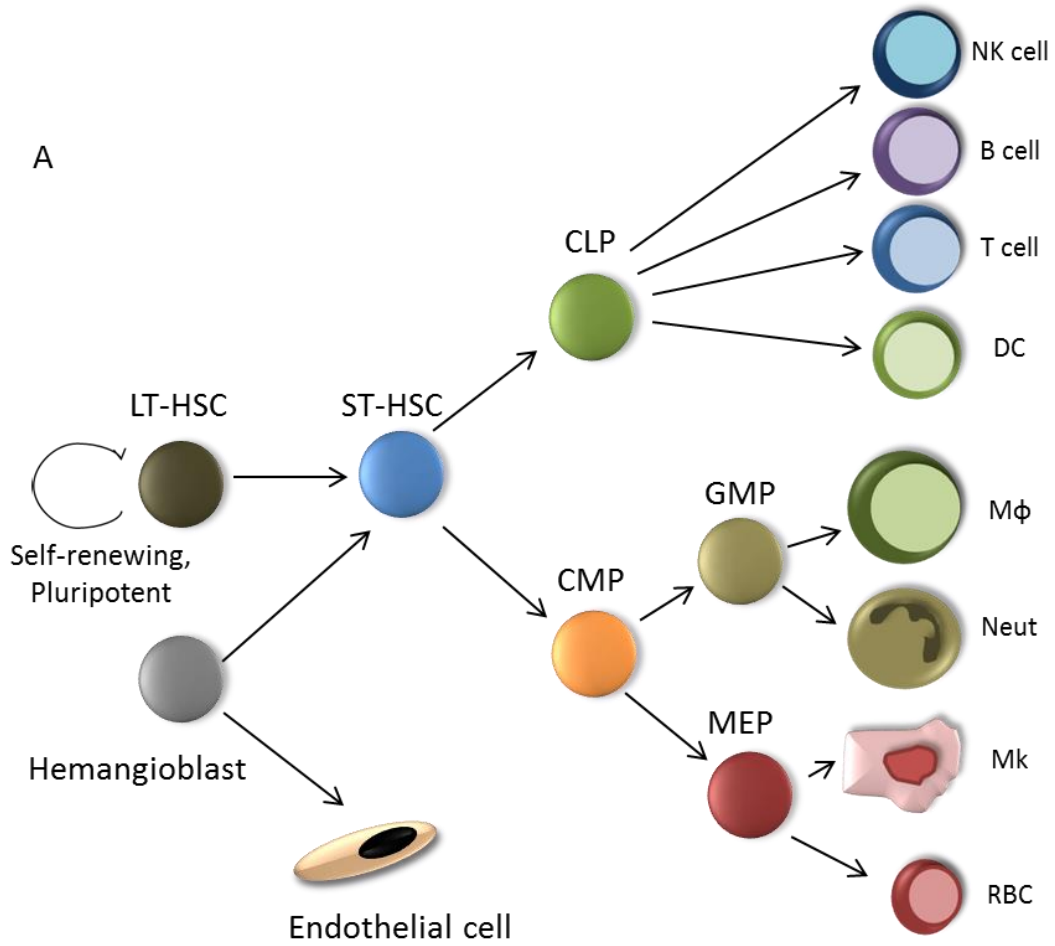

B

Population	Species	Phenotype
LT-HSC	Mouse	CD34 <sup>neg</sup> , Lin <sup>neg</sup> , c-kit <sup>pos</sup> , sca-1 <sup>pos</sup> , CD155 <sup>pos</sup> , CD48 <sup>neg</sup>
	Human	Lin <sup>neg</sup> , CD34 <sup>pos</sup> , CD38 <sup>neg</sup>
ST-HSC	Mouse	CD34 <sup>pos</sup> , Lin <sup>neg</sup> , c-kit <sup>pos</sup> , Sca-1 <sup>pos</sup>
	Human	Lin <sup>neg</sup> , CD34 <sup>pos</sup> , CD38 <sup>pos</sup>
CLP	Mouse	Lin <sup>neg</sup> , c-kit <sup>low</sup> , Sca-1 <sup>low</sup> , IL7Rα <sup>pos</sup>
	Human	Lin <sup>neg</sup> , CD34 <sup>pos</sup> , CD38 <sup>pos</sup> , CD10 <sup>pos</sup>
CMP	Mouse	CD34 <sup>pos</sup> , Lin <sup>neg</sup> , c-kit <sup>pos</sup> , Sca-1 <sup>neg</sup>
	Human	Lin <sup>neg</sup> , CD34 <sup>pos</sup> , CD38 <sup>pos</sup> , IL3Rα <sup>low</sup>
MEP	Mouse	CD34 <sup>neg</sup> Lin <sup>neg</sup> , c-kit <sup>low</sup> , Sca-1 <sup>neg</sup> , FcγR <sup>neg</sup>
	Human	Lin <sup>neg</sup> , CD34 <sup>pos</sup> , CD38 <sup>pos</sup> , IL3Rα <sup>neg</sup>
GMP	Mouse	CD34 <sup>neg</sup> Lin <sup>neg</sup> , c-kit <sup>pos</sup> , Sca-1 <sup>neg</sup> , FcγR <sup>pos</sup>
	Human	Lin <sup>neg</sup> , CD34 <sup>pos</sup> , CD38 <sup>pos</sup> , IL3Rα <sup>pos</sup>

**Figure 1. Hematopoietic hierarchy.**

Shown is a very simplistic graphical representation of the stem cell hierarchy and differentiation patterns, based on current understandings of the hematopoietic process. Starting from the top, a LT-HSC with long-term renewal capabilities can differentiate into a ST-HSC, with limited or lack of ability to self-renew, but still capable of differentiating down all lineages. Division of this multipotent progenitor can produce either myeloid or lymphoid progenitors, which further differentiate into oligopotent and then lineage-restricted progenitors, and finally into mature blood cells. In addition, a primitive hemangioblast can produce either endothelial cells or multipotent hematopoietic progenitors.

## **The Hematopoietic Stem Cell Niche- Roles for CXCR4 and Hypoxia**

While blood cells can be found in a majority of organs and tissues throughout the body, it was first suggested by Schofield that HSCs are maintained in very specific and defined microenvironments, termed “niches”, where signals regulate HSC maintenance (Schofield, 1978). We now know that the primary physiological HSC niche in most higher organisms is the bone marrow, which is comprised of hematopoietic cells, mesenchymal stromal cells, and a milieu of extracellular matrix proteins, chemokines, cytokines, collagens, fibronectins and proteoglycans (Yoder & Williams, 1995). Bone-forming cells, or osteoblasts, have been shown to have proximal interaction with HSCs within the endosteal niche (Calvi et al., 2003; Arai et al., 2004; Visnjic et al., 2004), and co-transplant with osteoblasts or osteolineage cells increases HSC engraftment (El-Badri et al., 1998), suggesting that these cells are an extremely important component of the bone marrow niche and are crucial for HSC maintenance and function.

Osteocytes, which differentiate from osteoblasts, are the most abundant cell type in the bone matrix (Bonewald, 2011). Osteocytes are another integral cell for HSC maintenance and their retention within the niche. It appears that osteocytes may release anabolic factors such as nitric oxide (NO) and prostaglandins into the extracellular matrix (Klein-Nulend et al., 1995), which are known to have positive effects on hematopoietic cell-supporting osteoblasts. Furthermore, absence of osteocytes results in severely impaired mobilization of HSCs in response to granulocyte-colony stimulating factor (G-CSF), despite no alterations in numbers of HSCs within the bone

marrow (Asada et al., 2013), suggesting that osteocytes may be crucial for HSC retention and trafficking from the bone marrow.

Despite HSCs' close proximity to osteoblastic or "endosteal" regions of the bone marrow, the theory of other distinct niches has been proposed and debated. Studies have suggested that HSCs expressing SLAM markers are associated with sinusoidal endothelium (Kiel et al., 2005), and that loss of bone marrow sinusoidal endothelial cells results in impaired HSC engraftment (Hooper et al., 2009; Butler et al., 2010), thus suggesting the presence of a "vascular" niche. Additionally, specific markers expressed on bone marrow endothelial cells such as E-selectin have been shown to be important for regulation of HSC proliferation (Winkler et al., 2012). On the other hand, recent reports show that the vascular niche is not necessary for HSPC expansion (Soki et al., 2013), and other studies reveal a crucial role for perivascular stromal cells in HSC maintenance (Corselli et al., 2013) suggesting the presence of a non-endothelial "perivascular" niche.

While the idea of distinct bone marrow niches will continue to be the topic of debate for many years, it is known that HSCs can interact with cells from all three niches through a number of different adhesion and extracellular molecules such as  $\alpha 4\beta 1$ - Very late antigen 4 (VLA-4),  $\alpha 5\beta 1$ - Very late antigen 5 (VLA-5) (Levesque et al., 1995; Peled et al., 2000), osteopontin (OPN) (Nilsson et al., 2005; Grassinger et al., 2009) and Nestin (Mendez-Ferrer et al., 2010), and these molecules have been shown to be necessary for maintaining HSCs within the bone marrow. However, the CXC chemokine receptor 4 (CXCR4) and Stromal-cell derived factor-1 (SDF-1) interaction has been

considered to be one of the most important for regulation of HSPC trafficking to and from the bone marrow. CXCR4 is expressed by HSCs, and its ligand, SDF-1, is expressed by osteoblasts (Ponomaryov et al., 2000), endothelial and perivascular cells (Katayama et al., 2006) as well as specialized reticular cells (Sugiyama et al., 2006) within the bone marrow, and the interaction between CXCR4 and SDF-1 has positive effects on HSC proliferation and survival (Broxmeyer et al., 2003; Broxmeyer et al., 2005; Broxmeyer et al., 2007).

Another unique characteristic of the bone marrow niche is its oxygen content. Compared to the rest of the body, the bone marrow is distinctly less oxygenated and is considered “hypoxic” (Harrison et al., 2002). During embryogenesis, oxygen levels in the embryo are also low (Rodesch et al., 1992), and hemangioblast differentiation into endothelial and hematopoietic cells is dependent on hypoxia (Phillips et al., 1995; Adelman et al., 1999). Furthermore, early studies revealed a protective effect of hypoxia on the bone marrow and spleen (Rambach et al., 1954). Taken together, these studies indicate that hypoxia may have a positive effect on both development as well as maintenance of hematopoietic cells. Indeed, more recent evidence suggests that HSCs with long-term population capacity are located in hypoxic areas and are not in close proximity to the highly oxygenated capillaries (Parmar et al., 2007; Kubota et al., 2008).

A major transcription factor regulated by hypoxia is Hypoxia Inducible Factor-1 (HIF1). HIF1 was initially characterized as a hypoxia-inducible protein and was shown to upregulate Erythropoietin (Epo) in response to both hypoxia and cobalt chloride (Wang & Semenza, 1993). Later, it was determined that HIF1 was a heterodimeric basic helix-

loop-helix (bHLH) DNA-binding protein, containing a Per-ARNT-Sim (PAS) domain and consisting of two subunits, HIF1 $\alpha$  and HIF1 $\beta$  (Wang & Semenza, 1995; Wang et al., 1995) (Figure 2A). In normoxic conditions, prolyl hydroxylases add a hydroxyl group to specific proline residues in the oxygen-dependent degradation domain (ODDD) within the HIF1 $\alpha$  subunit (Ivan et al., 2001), allowing it to bind to the E3 ubiquitin ligase, von Hippel Lindau (vHL) protein (Ohh et al., 2000). HIF1 $\alpha$  is subsequently ubiquitinated and ultimately undergoes proteasomal degradation (Salceda & Caro, 1997; Maxwell et al., 1999; Kamura et al., 2000). In hypoxia, the prolyl hydroxylases are inhibited due to their requirement for oxygen as a substrate, thus allowing HIF1 $\alpha$  to dimerize with HIF1 $\beta$  and translocate to the nucleus. Once in the nucleus, the HIF1 $\alpha$ / $\beta$  dimer binds to hypoxia response elements (HREs) located within the promoter region of responsive genes (Figure 2B). HIF1 affects the expression of a number of downstream genes that regulate angiogenesis, survival and migration, such as VEGF (Liu et al., 1995), Survivin (Yang et al., 2004; Peng et al., 2006; Wei et al., 2006) and CXCR4, respectively. Interestingly, CXCR4 contains several HREs within its promoter (Schioppa et al., 2003; Staller et al., 2003; Phillips et al., 2005; Zagzag et al., 2006; Wang et al., 2008; Ishikawa et al., 2009), indicating it can be transcriptionally regulated by HIF1.

The hypoxic state of the bone marrow suggests that HIF1 may be important for HSC maintenance within the niche. Elegant studies by Takubo et al. demonstrate that precise regulation of HIF1 $\alpha$  expression is necessary for optimal HSC cell cycle regulation (Takubo et al., 2010), and specific roles for hypoxia and HIF1 $\alpha$  in HSC function and maintenance will be discussed in length later in the dissertation.

Another member of the HIF family, HIF2 $\alpha$ , shares close sequence homology to HIF1 $\alpha$  (Ema et al., 1997) and is known to regulate several hypoxia-responsive genes such as VEGF and Adrenomedullin (Hu et al., 2003). However, it was recently established that, although HIF1 $\alpha$  and HIF2 $\alpha$  are structurally similar, they play varying roles in certain physiological processes such as angiogenesis and tumor formation (Imtiyaz et al., 2010; Skuli et al., 2012) that appear to be non-overlapping. And while it has been shown that HIF2 $\alpha$  can respond to hypoxia similarly to HIF1 $\alpha$  (Ema et al., 1997), it does not appear to regulate CXCR4 or other genes involved in HSPC function.

Figure 2

A

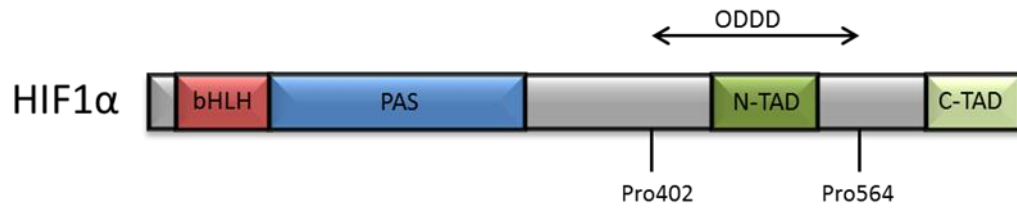

B

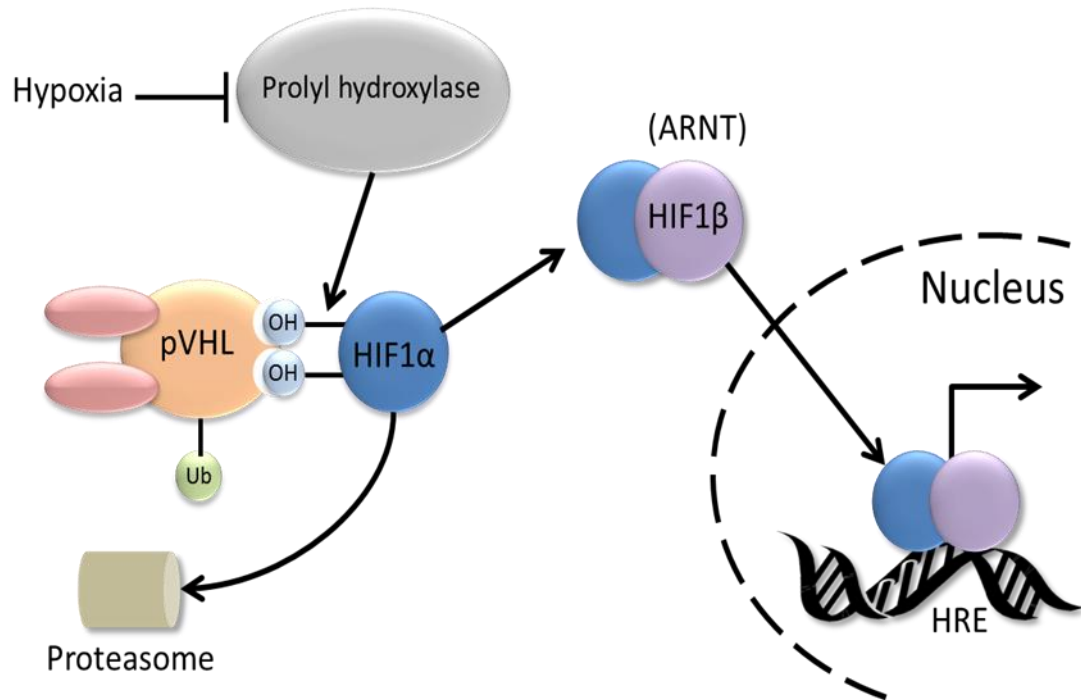



**Figure 2. HIF1 regulation by hypoxia.**

(A) The HIF1 $\alpha$  protein consists of a basic helix-loop-helix (bHLH) DNA-binding domain, as well as a Per-ARNT-Sim (PAS) domain and oxygen-dependent degradation domain (ODDD). Two specific proline residues located at 402 and 564 flank the ODDD region and are required for HIF1 $\alpha$  degradation by the von Hippel Lindau (VHL) protein. (B) Schematic of HIF1 in hypoxia or normoxia. Briefly, HIF1 $\alpha$  is hydroxylated at two proline residues in normoxia by prolyl hydroxylases. The hydroxylated prolines are then recognized and ubiquitinated by the E3 Ubiquitin ligase VHL, and HIF1 $\alpha$  is degraded through the proteasomal pathway. In hypoxia, prolyl hydroxylases are inhibited, allowing HIF1 $\alpha$  to be stabilized and bind to the HIF1 $\beta$  subunit, also known as Aryl Hydrocarbon Nuclear Translocator (ARNT), and together are translocated to the nucleus to bind to hypoxia response elements (HREs) within the promoter of responsive genes.

## **Hematopoietic stem cell homing and motility**

One of the hallmarks of HSCs is their ability to engraft and fully reconstitute the blood forming system of transplant recipients. In order to do this, however, it is essential that they find their way back to the bone marrow after transplant. This process, termed “homing”, is a relatively quick process that lasts no longer than 48 hours. During this short period of time, stem cells must navigate through a barrage of chemokines and cytokines in the blood, cross a blood/bone marrow endothelial barrier, lodge themselves within supportive cellular niches of the bone and begin proliferating. Homing is a process distinct from engraftment, and does not require cell division (Lapidot et al., 2005). Therefore, while effective homing is necessary for engraftment, it does not necessarily assure that engraftment will be successful.

A unique aspect of stem cell homing is the seemingly preferential localization of HSCs to the bone marrow after transplant. Several studies investigated the organ distribution of HSCs post-transplant and found that the majority of HSCs localized to the bone marrow, and did not remain or proliferate in other organs for extended periods of time (Kollet et al., 2001; Matsuzaki et al., 2004), suggesting that the bone marrow contains specific factors that not only attract HSCs, but are necessary for HSC lodgment. More detailed studies revealed that certain adhesion molecules expressed by both HSCs and bone marrow niche cells, such as CXCR4, are extremely important in HSC homing (Peled et al., 1999). Subsequently, studies confirmed that increases in CXCR4 expression on HSCs correlates with an enhanced homing and subsequent engraftment (Brenner et al., 2004; Kahn et al., 2004).

Preferential homing and retention in the bone marrow suggests that HSCs can direct their movement to specific locations within the body. This directional movement, termed cell polarization or cell motility, is an extremely complex and tightly regulated process involving a combination of signal cascades and cytoskeleton rearrangement via actin polymerization, usually in response to chemokine gradients (Fukata et al., 2003). Cell movement typically begins by the formation of lamellipodia towards a chemokine gradient via activation of actin filaments (Bailly et al., 1998). The lamellopod is then stabilized by the formation of adhesions to the cellular microenvironment, and then the posterior of the cell is able to retract and the cell moves forward, repeating the process over and over until the cell has reached its destination (Bailly et al., 1998; Condeelis et al., 2001; Ananthakrishnan & Ehrlicher, 2007). Movement of cells is entirely dependent on actin polymerization at the leading edge of the cell (Ridley & Hall, 1992a; Ridley & Hall, 1992b; Tang & Anfinogenova, 2008), and this polymerization is tightly regulated by a specific family of small GTPases, also known as the “Rho” family (Ridley & Hall, 1992a; Ridley & Hall, 1992b).

Collectively, GTPases are extremely important for cell movement, and essentially all aspects of motility including polarity, cytoskeletal reorganization and signal transduction are controlled by GTPases (Sahai & Marshall, 2002; Tang & Anfinogenova, 2008). The Rho GTPases are a family made up of 6 small, 20-40kDa proteins that include RhoA, RhoB, RhoC (Madaule & Axel, 1985), Cdc42 (Shinjo et al., 1990), Rac1 and Rac2 (Ridley & Hall, 1992a). While these proteins share some homology, Cdc42, Rac1 and Rac2 have distinct functions and are vital for cell motility (Fukata et al., 2003). However,

despite their downstream functional differences, they all behave as typical GTPases. In their inactive GDP-bound form, they are sequestered in the cell cytoplasm, however when activated, Guanine nucleotide exchange factors (GEFs) exchange GDP for GTP and the GTPase moves to the cellular membrane and interact with downstream effector proteins (Schmidt & Hall, 2002). Deactivation requires GTPase-activating proteins (GAPs), which hydrolyze GTP into GDP (Figure 3).

Certain members of the Rho family, specifically Rac1 and Rac2 have been shown to be involved in HSC function and trafficking. Interestingly, Rac proteins can be activated by SDF-1 and are indispensable for HSC homing and engraftment (Yang et al., 2001; Gu et al., 2003; Cancelas et al., 2005). Gu et al. dissected the roles of Rac1 and Rac2 in HSC cell function, and determined that Rac1 played important roles in endosteal homing, growth-factor stimulated proliferation and cell motility, specifically in regards to cell retraction. Rac2 was more important for cell regulation of apoptosis and F-actin assembly, and both were required for normal cell migration to SDF-1 and retention within the bone marrow (Gu et al., 2003). Furthermore, while Rac2 may be the only Rac exclusively expressed on hematopoietic cells (Williams et al., 2008), Rac1 can colocalize with CXCR4 within lipid rafts of hematopoietic cells (Wysoczynski et al., 2005) and has been shown to be required for HIF1 activity (Hirota & Semenza, 2001). This evidence, along with others suggesting that HIF1 $\alpha$  and CXCR4 are crucial for HSC maintenance and homing, strongly indicate Rac1 as being an indispensable component of HSC trafficking.

Figure 3

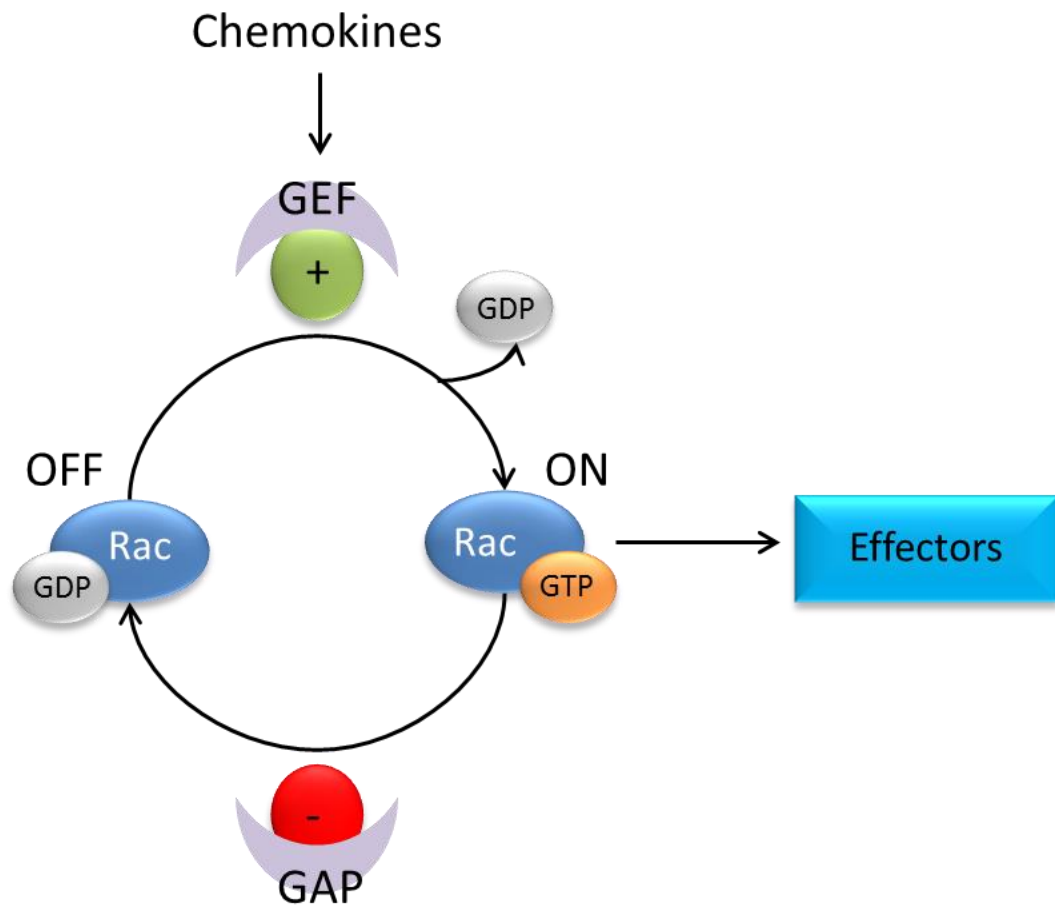

**Figure 3. GTPase regulation by GEFs and GAPs.**

Schematic of Rac GTPase activation and de-activation. Rac is turned “ON” by the activity of Guanine nucleotide exchange factors (GEFs) and conversion of GDP to GTP, normally in response to stimuli such as chemokines such as SDF-1. Once activated, Rac is localized to the cell membrane and interacts with downstream effectors that can influence cell motility and proliferation. GTPase-activating proteins (GAPs) de-activate Rac by hydrolyzing GTP into GDP, and inactive Rac is then sequestered in the cytoplasm until activated again.

## Prostaglandins: Synthesis, Signaling and Roles in Hematopoiesis

Prostaglandins are a series of highly pleiotropic lipid messengers within the large Eicosanoid family of bioactive lipids, and are formed by the oxidation of 20-carbon arachadonic acid (AA). Prostaglandin E<sub>2</sub> (PGE<sub>2</sub>) is the most abundant eicosanoid (Serhan & Levy, 2003; Murakami & Kudo, 2006), and is synthesized by all nucleated cells (Miller, 2006). PGE<sub>2</sub> has an array of physiological effects, but is a well-known facilitator of inflammation (Hinson et al., 1996; Murakami & Kudo, 2006; Samuelsson et al., 2007), fever (Coceani et al., 1989; Ivanov & Romanovsky, 2004; Lazarus, 2006), pain (Schweizer et al., 1988; Stock et al., 2001) and cancer (Hull et al., 2004; Murakami & Kudo, 2006). Due to its extremely short half-life, it is thought to signal in an autocrine or paracrine fashion (Tsuboi et al., 2002).

Biosynthesis of PGE<sub>2</sub> is largely initiated by inflammatory signaling and activation of cytosolic Phospholipase A<sub>2</sub> (cPLA<sub>2</sub>) (Figure 4). Phospholipase A<sub>2</sub> is the predominant phospholipase that initiates PGE<sub>2</sub> synthesis and can cPLA<sub>2</sub> be activated by a number of different molecules, such as Transforming growth factor- $\alpha$  (TGF- $\alpha$ ) (Liu et al., 1993). Once activated, cPLA<sub>2</sub> frees AA from cellular membrane phospholipids. Arachadonic acid then interacts with cyclooxygenase (COX) enzymes 1 and 2. At steady state, COX1 is ubiquitously expressed at low levels, however COX2 expression is induced by inflammatory stimuli such as LPS (Miller, 2006; Murakami & Kudo, 2006; Park et al., 2006). During this step, the intermediate prostaglandin G<sub>2</sub> (PGG<sub>2</sub>) is formed by cyclization of AA through the addition of a 15-hydroperoxy group, followed by reduction of PGG<sub>2</sub> to form the unstable intermediate prostaglandin H<sub>2</sub> (PGH<sub>2</sub>).

Figure 4

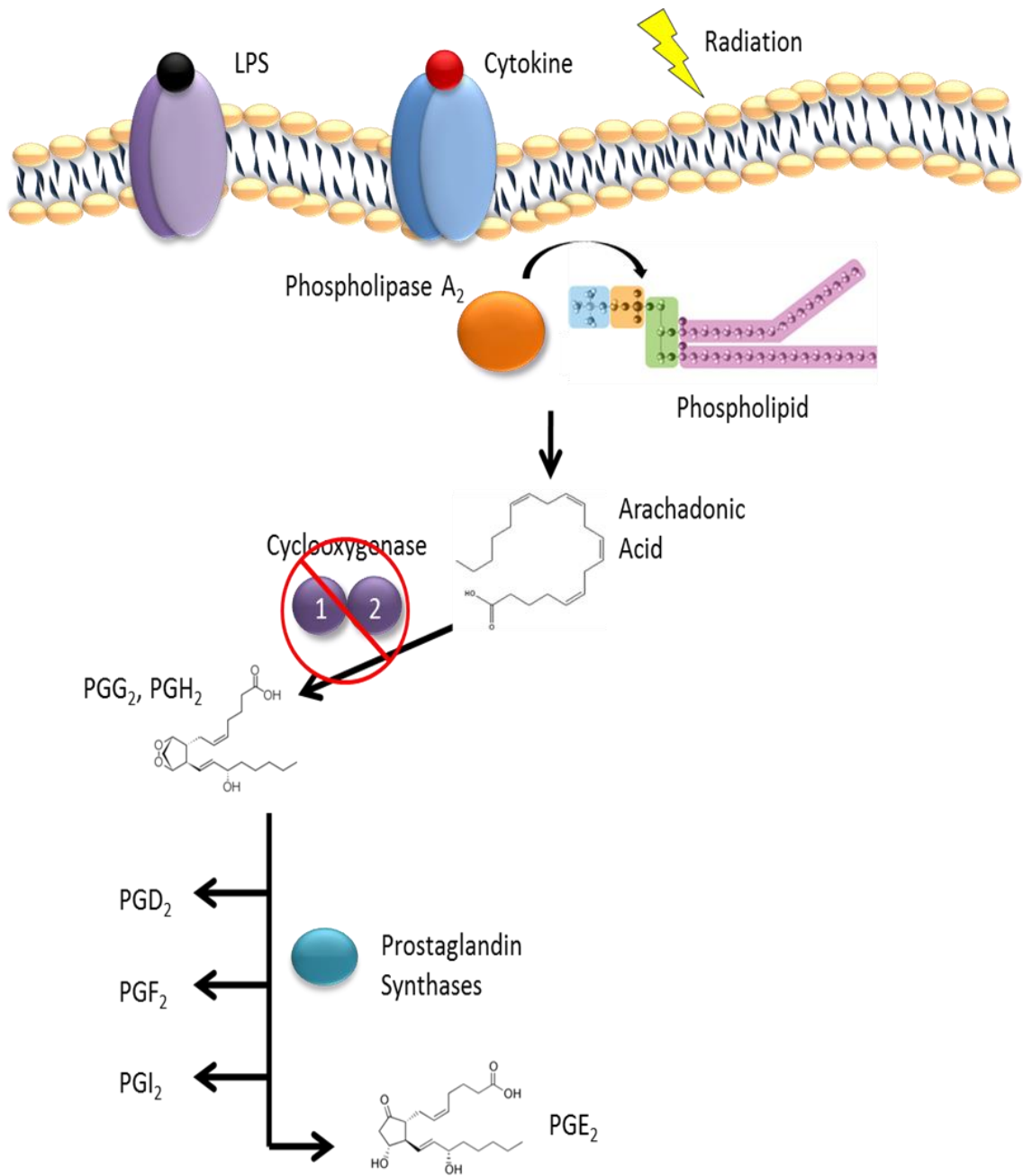



**Figure 4. Prostaglandin E<sub>2</sub> biosynthesis.**

Schematic of PGE<sub>2</sub> synthesis. Stimulation by an inflammatory signal such as cytokines, lipopolysaccharide (LPS) or radiation activates cytosolic Phospholipase A<sub>2</sub> (cPLA<sub>2</sub>), which then cleaves a membrane phospholipid into the 20-carbon arachadonic acid (AA). Arachadonic acid is oxidized by Cyclooxygenases 1 and 2 (COX 1 and 2) to form the unstable intermediate PGH<sub>2</sub>, which is then further converted into Prostaglandins D<sub>2</sub>, F<sub>2</sub>, I<sub>2</sub> and E<sub>2</sub> by specific Prostaglandin Synthases.

From this step, PGH<sub>2</sub> interacts with specific prostaglandin synthases that convert it into the various prostaglandin families such as PGE<sub>2</sub>, PGD<sub>2</sub>, PGF<sub>2</sub> or PGI<sub>2</sub> (Urade et al., 1995; Folco & Murphy, 2006; Park et al., 2006).

Once synthesized, PGE<sub>2</sub> can interact with four different G-protein coupled receptors (GPCRs) with distinct, overlapping and opposite activities, resulting in multiple biological effects (Breyer et al., 2001; Tsuboi et al., 2002; Hull et al., 2004; Sugimoto & Narumiya, 2007) (Figure 5). The E Prostanoid (EP) receptor EP1 activates Phospholipase C (PLC) and increases intracellular calcium levels and Protein kinase C (PKC) activity (Breyer et al., 2001; Tsuboi et al., 2002). The EP3 receptor acts by inhibiting adenylate cyclase and cyclic adenosine monophosphate (cAMP) signaling (Lazarus, 2006; Sugimoto & Narumiya, 2007). Both EP2 and EP4 receptors activate cAMP through Protein kinase A (PKA) signaling (Breyer et al., 2001; Tsuboi et al., 2002; Hull et al., 2004; Sugimoto & Narumiya, 2007), but EP4 can also increase Phosphoinositide 3-Kinase (PI3K) activity in addition to cAMP (Fujino et al., 2003; Vo et al., 2013). Due to overlapping and opposite effects of the four EP receptors, PGE<sub>2</sub> signaling is mainly dependent on the expression and availability of the receptors as well as PGE<sub>2</sub> concentrations. Variations in either will result in different signaling outcomes (Hull et al., 2004).

As mentioned previously, almost all nucleated cells can synthesize PGE<sub>2</sub>. However, within the bone marrow, the primary cell types responsible for synthesizing PGE<sub>2</sub> appear to be osteoblasts (Raisz et al., 1979; Chen et al., 1997; Miyaura et al., 2003) and macrophages (Pelus et al., 1979; Shibata, 1989). Other cell types such as mesenchymal stromal cells and fibroblasts have been reported to secrete PGE<sub>2</sub> as well,

albeit at lower levels (Ylostalo et al., 2012). Based on the ability of multiple marrow stromal cells to produce PGE<sub>2</sub> and their roles in HSC maintenance within the niche, it is logical to hypothesize that PGE<sub>2</sub> is involved in HSC regulation and function. Indeed, early studies showed that PGE<sub>2</sub> plays an important role in hematopoiesis with both stimulatory and inhibitory effects, which were dependent on specific dose and duration of PGE<sub>2</sub> exposure. *In vivo* PGE<sub>2</sub> administration inhibits colony-forming unit granulocyte macrophage (CFU-GM) frequency and cell-cycle rate (Kurland et al., 1978; Pelus et al., 1979; Pelus et al., 1981; Gentile et al., 1983; Gentile & Pelus, 1987; Gentile & Pelus, 1988; Pelus, 1989), while *ex vivo* pulsing of cells with PGE<sub>2</sub> induces cycling of quiescent hematopoietic cells and increased number of HPCs, suggesting that PGE<sub>2</sub> may act on primitive cell populations as well as more mature progenitor cells (Pelus et al., 1982; Pelus, 1982). PGE<sub>2</sub> was also shown to have stimulatory effects on erythroid and multipotent progenitors *in vitro* (Rossi et al., 1980; Lu et al., 1984; Lu et al., 1986), reiterating PGE<sub>2</sub>'s pleotropic effects on different cell populations. More recent studies reveal that PGE<sub>2</sub> enhances bone marrow engraftment after transplantation in mice as a consequence of enhanced homing, survival and proliferation of HSC (Hoggatt et al., 2009).

Figure 5

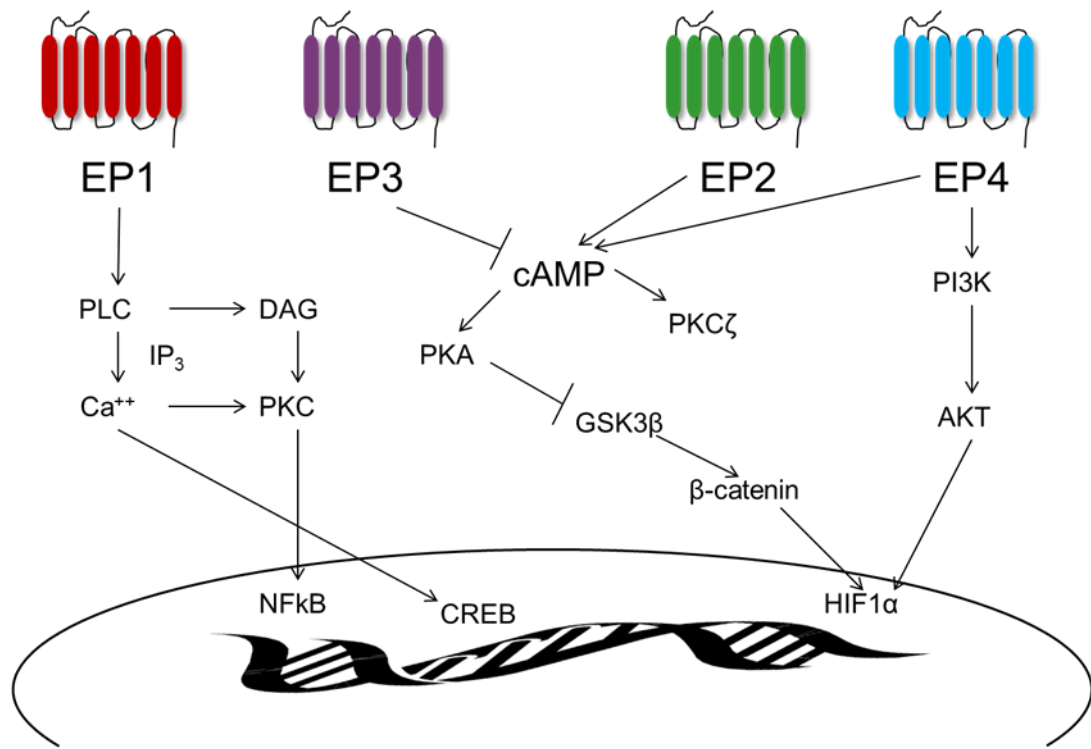

**Figure 5. Prostaglandin signaling through EP receptors.**

Four different EP receptors have similar and opposing effects based on their expression and PGE<sub>2</sub> concentration.

## Chapter 2. HIF1 $\alpha$ is Necessary for Enhanced HSPC Homing After Prostaglandin E<sub>2</sub> Treatment

### Introduction:

Hematopoietic stem cell (HSC) transplant is a life-saving treatment option for a variety of hematological malignancies, inherited metabolic diseases and congenital immunodeficiencies, and is also an attractive strategy for gene therapy (Kondo et al., 2003; Magnani et al., 2013). Primary sources of HSC for transplant include mobilized peripheral blood (MPB) (Ringden et al., 2000; Fruehauf & Seggewiss, 2003; Papayannopoulou, 2004), bone marrow (Goldman & Horowitz, 2002), and umbilical cord blood (UCB) (Broxmeyer et al., 1989; Kurtzberg, 2009; Gluckman, 2011; Broxmeyer, 2012). Transplantation success is dictated by the quality and number of donor cells transplanted, and is dependent on their ability to home to their appropriate bone marrow niche, undergo self-renewal and subsequently differentiate to reconstitute the recipient's hematopoietic system. Some sources of stem cells, however, such as UCB or peripheral blood HSCs from donors who mobilize poorly, display reduced engraftment efficiency due to inadequate HSC number. Inability to efficiently home to the bone marrow can also result in impaired engraftment, for example, in the case of gene transduced HSPCs (Broxmeyer et al., 2006; Hall et al., 2006). Identifying strategies to enhance homing, engraftment and expansion of HSCs after transplantation represent areas to improve transplant efficiency, particularly when HSC number is limited.

We have previously shown that *ex vivo* pulse exposure of mouse and human HSCs to the lipid messenger 16-16 dimethyl prostaglandin E<sub>2</sub> (dmPGE<sub>2</sub>) increases homing, survival and proliferation (Hoggatt et al., 2009), making it an attractive therapeutic strategy to improve HSC transplantation. PGE<sub>2</sub> enhances HSC homing primarily by increasing expression of the homing receptor CXCR4 on HSCs, however the mechanism(s) behind this effect has not been well defined.

As previously mentioned, the transcription factor Hypoxia-inducible Factor 1 alpha (HIF1 $\alpha$ ) has been implicated in HSC maintenance (Takubo et al., 2010) and is thought to regulate HSC proliferation (Eliasson et al., 2010) and transcriptional regulation of CXCR4 (Schioppa et al., 2003; Staller et al., 2003; Pore & Maity, 2006; Zagzag et al., 2006; Ishikawa et al., 2009). Several studies suggest a link between PGE<sub>2</sub> and HIF1 $\alpha$ , however, direct effects on HSC homing after specific manipulation of HIF1 $\alpha$  have not been reported, and the effect of PGE<sub>2</sub> on HIF1 $\alpha$  stabilization/expression has not been studied in primary hematopoietic cells.

In this chapter, we show that dmPGE<sub>2</sub> stabilizes HIF1 $\alpha$  in HSPCs and the hypoxia mimetic Dimethyloxalyl Glycine (DMOG) confers similar effects on HSC function to that of dmPGE<sub>2</sub> treatment, including enhanced homing, engraftment and CXCR4 expression. We also show that PGE<sub>2</sub>-induced CXCR4 upregulation is mediated through binding of HIF1 $\alpha$  to the hypoxia response element (HRE) located 1.3kb upstream from the transcriptional start site within the CXCR4 promoter. In summary, we provide novel insight into the molecular mechanism through which PGE<sub>2</sub> regulates HSC homing and identify additional targets for HSC manipulation.

## **Materials and Methods:**

### **Mice and human cord blood**

C57BL/6 (CD45.2), B6.SJL-*Ptprc<sup>a</sup> Pep3<sup>b</sup>*/BoyJ (BoyJ) (CD45.1), B6.129-*Hif1a<sup>tm3Rsj0</sup>*/J (HIF1a Flox) and B6.Cg-Tg(UBC-cre/ESR1)1Ejb/J (Tamoxifen-Cre) mice were purchased from Jackson Laboratory (Bar Harbor, ME) and maintained in the Indiana University School of Medicine (IUSM) animal facility. C57BL/6 x BoyJ F1 Hybrid (CD45.1/CD45.2 F1) mice were bred and maintained in-house. Conditional HIF1 $\alpha$  knockout mice were generated by breeding HIF1 $\alpha$ <sup>Flox/Flox</sup> mice with Tamoxifen-Cre mice. The resulting hemizygous floxed pups were crossed with homozygous HIF1 $\alpha$ <sup>Flox/Flox</sup> mice and the resulting Cre<sup>+</sup>HIF1 $\alpha$ <sup>Flox/Flox</sup> mice were used in experiments. Mice used in transplant studies received doxycycline feed for 30 days post-transplantation. All mouse experiments were approved by the Institutional Animal Care and Use Committee (IACUC) of IUSM. Human umbilical cord blood (UCB) was obtained from Wishard Hospital (Indianapolis, IN) with IRB approval.

### **dmPGE<sub>2</sub> and DMOG pulse-exposure**

16-16 dimethyl prostaglandin E<sub>2</sub> (dmPGE<sub>2</sub>) in methyl acetate (Cayman Chemical, Ann Arbor, MI) was evaporated on ice under N<sub>2</sub> and reconstituted in 100% ethanol at a concentration of 0.1M. Lyophilized DMOG (Cayman Chemical) was dissolved in 100% ethanol at a concentration of 0.1M. For pulse-exposure experiments, 1x10<sup>6</sup> cells/mL were incubated with either 1uM dmPGE<sub>2</sub> or 5uM DMOG diluted in PBS at 37°C with 5% CO<sub>2</sub> for 2 hours and were washed twice prior to use in experiments. Vehicle-treated cells



were treated in the same manner, using an equivalent volume of ethanol. For experiments involving SNP treatment, 5uM SNP (EMD Millipore, Billerica, MA) was added concomitantly with dmPGE<sub>2</sub> or DMOG and the cells were incubated for 2 hours at 37°C, 5% CO<sub>2</sub>.

### **Flow cytometry analysis**

Bone marrow was harvested from the femurs and tibias of mice and single-cell suspensions were prepared in PBS with 2% HI-FBS (Thermo Scientific HyClone, Logan, UT). Total nucleated cell counts were obtained using a Hemavet-950 (Drew Scientific, Waterbury, CT). All antibodies were purchased from BD Biosciences (San Jose, CA) unless otherwise noted. For detection of mouse Lineage<sup>neg</sup> Sca-1<sup>pos</sup> ckit<sup>neg</sup> (SKL) populations, c-kit-APC or APC-Cy7, Sca-1-PE or PE-Cy7, Lineage-V450, APC or FITC, CD45.1-PE and CD45.2-FITC were used. For post-transplant multilineage analysis, CD11d-APC-Cy7, B22-PE-Cy7 and CD3-APC were used. CXCR4 was quantitated using CXCR4-PE. Events were collected using an LSRII flow cytometer (BD Biosciences) and analyses were performed using either CellQuest (BD Biosciences) or FlowJo (Tree Star Inc., Ashland, OR) software.

### **Analysis of hematopoietic stem and progenitor cell homing**

Whole bone marrow from CD45.2 mice was obtained by flushing the femurs and tibias, and Lineage<sup>pos</sup> cells were depleted using MACS microbeads (Miltenyi Biotech, Auburn, CA). The resulting Lineage<sup>neg</sup> cells were treated with 1uM dmPGE<sub>2</sub>, 5uM DMOG, or

vehicle. The cells were washed and  $2 \times 10^6$  cells were transplanted into lethally irradiated CD45.1 mice. After 16 hours, recipient bone marrow was collected and the mononuclear cell fraction was isolated using Lympholyte-M (CedarLane Labs, Burlington, ON). CD45.2 SKL events were quantitated by FACS. To evaluate the role of CXCR4 in homing, donor cells were treated with dmPGE<sub>2</sub>, DMOG, or Vehicle with or without the selective CXCR4 receptor antagonist AMD3100 (Genzyme, Cambridge, MA) 10 minutes prior to transplant.

#### **Tamoxifen treatment of HIF1 $\alpha$ KO mice**

To conditionally delete HIF1 $\alpha$ , Cre<sup>+</sup>HIF1 $\alpha$ <sup>Flox/Flox</sup> mice and Cre<sup>-</sup>HIF1 $\alpha$ <sup>Flox/Flox</sup> littermate controls were treated i.p. with 1mg of Tamoxifen resuspended in sunflower oil for 3 consecutive days. The mice were rested for 3 days and 3 more subsequent treatments were administered. After two weeks, bone marrow was harvested for experimental analysis and HIF1 $\alpha$  knockdown confirmed using real-time PCR.

#### **Migration assays**

Chemotaxis to SDF-1 was determined using a two-chamber Costar Transwell (6.5-mm diameter, 5 $\mu$ m pore; Cambridge, MA) system as previously described (Fukuda & Pelus, 2008). Briefly, Lineage<sup>neg</sup> bone marrow cells were treated with dmPGE<sub>2</sub>, DMOG and vehicle for 2 hours at 37°C with 5% CO<sub>2</sub>, washed twice and cultured in RPMI/10% HI-FBS overnight to allow for up-regulation of CXCR4. After incubation, cells were washed and resuspended at  $1 \times 10^6$  cells/mL in RPMI/0.5% BSA (0.1 mL was added to the top chamber

of the transwells, with 100ng/mL rmSDF-1 (R&D Systems, Minneapolis, MN) in the bottom chamber), and incubated for 4 hours at 37°C. Total cells migrating to the bottom chamber were collected and cell events were obtained for 30 seconds on high speed using a LSRII Flow Cytometer (BD Biosciences). Percent migration was calculated by dividing the total live cell counts in the lower well by the cell input multiplied by 100. Migrated cells were then stained with Lineage-FITC, Sca-1-PE and ckit-APC antibodies (BD Biosciences), and SKL cell migration was determined by comparing the proportion of SKL cells in input and migrated populations.

#### **Head to head competitive limiting dilution transplants**

Whole bone marrow cells from CD45.1 and CD45.2 mice were treated with either 5 $\mu$ M DMOG or vehicle for 2 hours at 37°C. After treatment, cells were washed twice and mixed with 2x10<sup>5</sup> CD45.1/CD45.2 F1 competitor bone marrow cells at ratios of 1:1, 0.5:1, 0.25:1 and 0.075:1 and were transplanted into lethally irradiated (1100 cGy, split dose) CD45.1/CD45.2 recipients. The proportion of CD45.1, CD45.2 and CD45.1/CD45.2 cells in peripheral blood was determined at 16 and 24 months post-transplant. For secondary transplants, 2x10<sup>6</sup> whole bone marrow from previously transplanted CD45.1/CD45.2 mice were transplanted into lethally irradiated CD45.1/CD45.2 recipients.

### **Culture of HIF1 $\beta$ mutant cells**

Mouse hepatoma cell lines with mutant or wild-type HIF1 $\beta$  were a generous gift from Dr. Mircea Ivan (Indiana University School of Medicine, Indianapolis, IN) and were cultured in DMEM plus 10% HI-FBS (Thermo Scientific HyClone, Logan, UT) with penicillin-streptomycin at 37°C, 5% CO<sub>2</sub>.

### **Quantitative real-time PCR**

Total cellular RNA was extracted using the PureLink<sup>®</sup> RNA Mini Kit (Life Technologies, Carlsbad, CA) per the manufacturer's instructions. Two micrograms of RNA was reversed transcribed using an AccuScript<sup>™</sup> High Fidelity 1<sup>st</sup> strand cDNA synthesis kit (Agilent Technologies, Santa Clara, CA). Two to five microliters of cDNA was used for real-time polymerase chain reaction (RT-PCR). Primers sequences for SYBR Green RT-PCR are listed in Table 1. RT-PCR was performed using Platinum SYBR Green qPCR supermix UDG with ROX (Invitrogen, Carlsbad, CA) in an MxPro-3000 (Agilent Technologies) thermocycler. Dissociation curves were obtained for each primer set to confirm only one PCR product. HPRT expression was used as an internal normalization control.

### **Western blot analysis**

Lineage<sup>neg</sup> cells were treated with either 1 $\mu$ M PGE<sub>2</sub> or 5 $\mu$ M DMOG and cultured for 6 hours at 37°C. Cell lysates were prepared by incubating cell pellets in cold RIPA buffer containing protease inhibitor cocktail (Thermo Fisher, Rockford, IL) on ice for 30 minutes. The lysates were centrifuged at 10,000xg for 10 minutes and supernatants

were resolved by SDS-Page gel electrophoresis and transferred onto a PVDF membrane. Membranes were incubated with a polyclonal anti-HIF1 $\alpha$  (C-Term) antibody (Cayman Chemical). Anti- $\beta$ -actin (Cell Signaling Technology, Danvers, MA) was used as a loading control.

### **Luciferase reporter assays**

One million human embryonic kidney (HEK) cells were seeded in 100mm tissue culture dishes and cultured in EMEM with 10% HI-FBS at 37°C with 5% CO<sub>2</sub> to ~75% confluency. Approximately 24 hours later, the cells were transfected with 2ug of pGL2-CXCR4-Luc vector containing portions of the CXCR4 promoter (Kind gifts from Dr. Wilhelm Krek) and 6ul FUGENE 6 HD Reagent (Promega, Madison, WI). The transfected cells were incubated for an additional 24 hours, washed, trypsinized and then split into 12-well plates in equal numbers. After allowing the cells to adhere for an additional 6 hours, the cells were treated with 1uM dmPGE<sub>2</sub> or vehicle and incubated overnight at 37°C with 5% CO<sub>2</sub>. After incubation, cells were harvested and 2ul of the lysates used to measure luciferase activity using the Firefly Luciferase Reporter Assay System (Promega) according to the manufacturer's instructions.

### **Statistical analysis**

Data are expressed as mean  $\pm$  SEM and were compared by two-tailed *t* tests or One-Way ANOVA with Bonferroni post-hoc analysis as appropriate. *P* values less than 0.05 were considered statistically significant.

**Table 1**

Gene	F/R	Primer Sequence
EP1	F	5' - GCTCCTTGCGGCATTAGTGTG - 3'
	R	5' - TGCGGTCTTTTCGGAATCGT - 3'
EP2	F	5' - CGTTATCCTCAACCTCATTTCGC - 3'
	R	5' - TCCGTCTCCTCTGCCATCG - 3'
EP3	F	5' - TTGCTGGCTCTGGTGGTGAC - 3'
	R	5' - GCTGGACTGCGAGACGGC - 3'
EP4	F	5' - TGACCCAAGCAGACACCACCT - 3'
	R	5' - TCCCACTAACCTCATCCACCAA - 3'
CXCR4	F	5' - CTCGCTATTGTCCACGCCAC - 3'
	R	5' - CCCTGACTGATGTCCCCCTG - 3'
Adm	F	5' - CACCCTGATGTTATTGGGTTCA - 3'
	R	5' - TTAGCGCCCACTTATTCCACT - 3'
GLUT1	F	5' - CTCTGTCGGCCTCTTTGTTAAT - 3'
	R	5' - CCAGTTTGGAGAAGCCCATAAG - 3'
HIF1 $\alpha$	F	5' - ACCTTCATCGGAAACTCCAAAG - 3'
	R	5' - ACTGTTAGGCTCAGGTGAACT - 3'
HPRT	F	5' - TTGCTGACCTGCTGGATTAC - 3'
	R	5' - TATGTCCCCCGTTGACTGA - 3'

Forward (F) and reverse (R) primers used are indicated as shown.

## Results:

### **PGE<sub>2</sub> and the hypoxia mimetic DMOG stabilize HIF1 $\alpha$ in HSPCs**

PGE<sub>2</sub> increases HIF1 $\alpha$  protein stabilization without affecting HIF1 $\alpha$  mRNA in prostate cancer cells and renal proximal tubular cells (Liu et al., 2002; Fernandez-Martinez et al., 2012). Inhibition of PGE biosynthesis by non-steroidal inflammatory drugs (NSAIDs) reduces HIF1 $\alpha$  protein and HIF-responsive genes (Palayoor et al., 2003). Moreover, in HEK cells and in microglial cells, HIF1 $\alpha$  has been reported to upregulate CXCR4 gene expression by interacting with HREs within the CXCR4 promoter (Staller et al., 2003; Wang et al., 2008). Since we previously demonstrated that PGE<sub>2</sub> upregulates CXCR4 in HSPCs that favors enhanced *in vitro* chemotaxis and homing *in vivo* (Hoggatt et al., 2009), we hypothesized that the enhancing effect of PGE<sub>2</sub> on these HSPC functions could be a result of stabilization of HIF1 $\alpha$ . We first determined whether PGE<sub>2</sub> stabilizes HIF1 $\alpha$  in primary mouse and human HSPCs. Treatment of mouse Lineage<sup>neg</sup> bone marrow mononuclear cells with 1 $\mu$ M dmPGE<sub>2</sub> for 2 hours significantly increased HIF1 $\alpha$  protein expression by ~35% determined by Western Blot analysis (Figure 6A).

As a positive control, the hypoxia mimetic DMOG was used. DMOG increases HIF1 $\alpha$  protein accumulation by blocking the prolyl hydroxylases necessary for targeting HIF1 $\alpha$  for degradation, resulting in stabilization of protein even in normoxic conditions (Asikainen et al., 2005). Since DMOG is a potent stabilizer of HIF1 $\alpha$ , we first performed dose-response experiments to determine the appropriate concentration of DMOG to mimic the effects of dmPGE<sub>2</sub> treatment on HIF1 $\alpha$  protein levels. It was determined that 5 $\mu$ M DMOG treatment resulted in a similar ~35% increase in HIF1 $\alpha$  protein levels (Figure

6B), and this concentration was used for the remainder of experiments as a positive control or dmPGE<sub>2</sub> “mimetic”.

Despite the modest increase in HIF1 $\alpha$  protein stabilization with both 1 $\mu$ M PGE<sub>2</sub> and 5 $\mu$ M DMOG treatment, message levels of downstream HIF1 responsive genes Adrenomedullin (Adm) and Glucose transporter 1 (GLUT1) were significantly increased after both treatments (Figure 7), indicating an increase in HIF1 transcriptional activity. As previously reported with PGE<sub>2</sub> treatment, message levels of HIF1 $\alpha$  were not increased, indicating that PGE<sub>2</sub> mainly affects protein stabilization. Overall, these data indicate that both dmPGE<sub>2</sub> and the hypoxia mimetic DMOG have the same effect on HIF1 $\alpha$  protein and downstream activity, and therefore can be used comparatively to assess HSPC function.



Figure 6

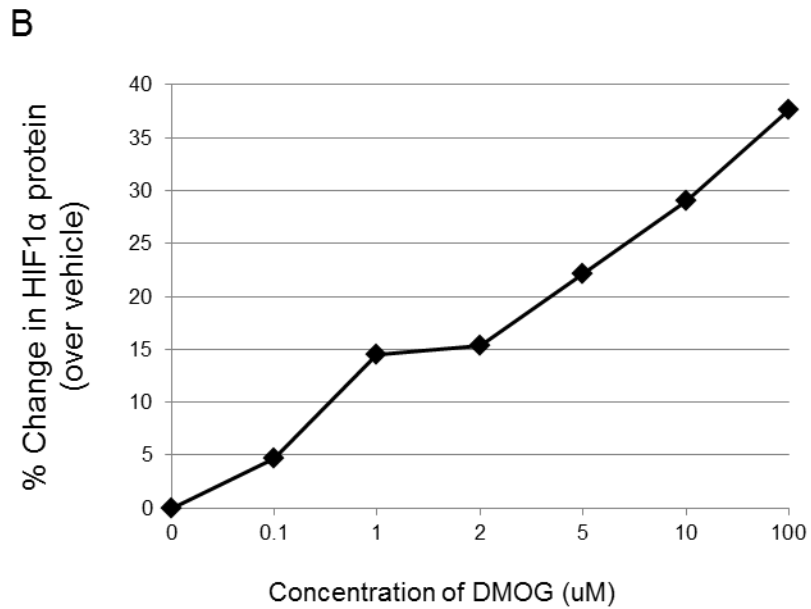
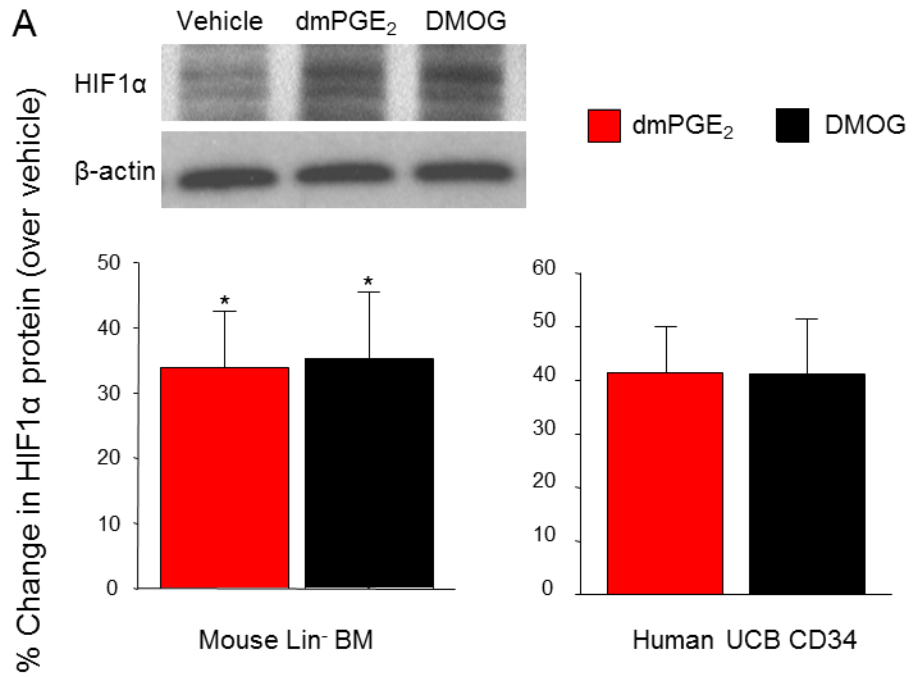
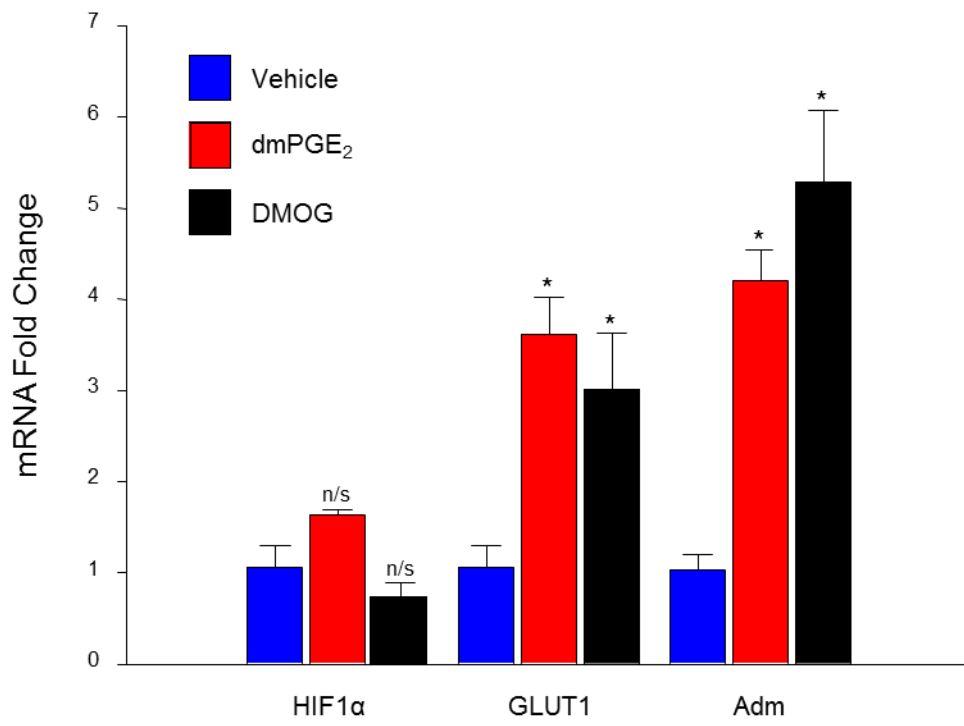

**Figure 6. PGE<sub>2</sub> increases HIF1 $\alpha$  protein in mouse and human HSPCs.**

(A) (Top) Representative blot of HIF1 $\alpha$  protein after treatment with vehicle, 1 $\mu$ M dmPGE<sub>2</sub> or 5 $\mu$ M DMOG. (Bottom left) Densitometry analysis of HIF1 $\alpha$  protein expression in mouse Lineage<sup>neg</sup> bone marrow cells treated with vehicle, 1 $\mu$ M dmPGE<sub>2</sub> or 5 $\mu$ M DMOG. Data are expressed as mean percent change in protein levels  $\pm$  SEM over vehicle control from three separate experiments. (Bottom right) Densitometry analysis of HIF1 $\alpha$  protein expression in human UCB CD34<sup>pos</sup> cells treated with vehicle, 1 $\mu$ M dmPGE<sub>2</sub> or 5 $\mu$ M DMOG from two patient samples. Data are expressed as Mean  $\pm$  SD, N=2. (B) Dose response curve of DMOG treatment compared to 1 $\mu$ M dmPGE<sub>2</sub> treatment. Data is expressed as percent change in HIF1 $\alpha$ : $\beta$ -actin ratio compared to vehicle control.

\*p<0.05.

Figure 7



**Figure 7. PGE<sub>2</sub> increases expression of HIF1 downstream responsive genes.**

Expression of HIF1 responsive genes in mouse Lineage<sup>neg</sup> bone marrow cells after treatment with dmPGE<sub>2</sub> and DMOG as determined by SYBR Green qRT-PCR. Data are expressed as mean ± SEM, N=3. \*p< 0.05.

**DMOG treatment results in increased HSPC CXCR4 expression and enhances *in vitro* migration to SDF-1 and enhances *in vivo* homing to bone marrow**

Since PGE<sub>2</sub> and DMOG have similar effects on HIF1 $\alpha$  stabilization, we investigated whether DMOG treatment would confer similar effects on HSPC function to that normally seen following dmPGE<sub>2</sub> treatment. As expected, DMOG produced an equivalent effect to dmPGE<sub>2</sub> on mouse and human HSPC CXCR4 expression (Figure 8A). Transwell migration assays are an *in vitro* alternative to homing in which HSPCs selectively migrate to an SDF-1 gradient (Kim & Broxmeyer, 1998). Although simplistic in nature, migration assays are thought to accurately reflect cells' potential homing capacity *in vivo*. Treatment of Lineage<sup>neg</sup> bone marrow with DMOG resulted in approximately a 50% increase in SKL chemotaxis to SDF-1 compared to vehicle control (Figure 8B), and was similar to dmPGE<sub>2</sub> treatment. These data indicate that DMOG-enhanced CXCR4 expression also results in enhanced migration capacity .

In an *in vivo* homing model utilizing two different congenic mouse strains, pulse exposure of bone marrow cells with DMOG for 2 hours *ex vivo* duplicates the enhanced SKL cell homing *in vivo* normally seen with dmPGE<sub>2</sub> (Figure 9A) . As we previously reported (Hoggatt et al., 2009), the enhanced homing effect of *ex vivo* pulse exposure to dmPGE<sub>2</sub> could be blocked by the selective CXCR4 antagonist, AMD3100 (Figure 9B). In a similar fashion, the enhanced homing effect of DMOG on SKL cell homing was completely blocked by treatment of pulsed cells with AMD3100, indicating that, like dmPGE<sub>2</sub>, the specific effect is CXCR4 dependent.

Figure 8

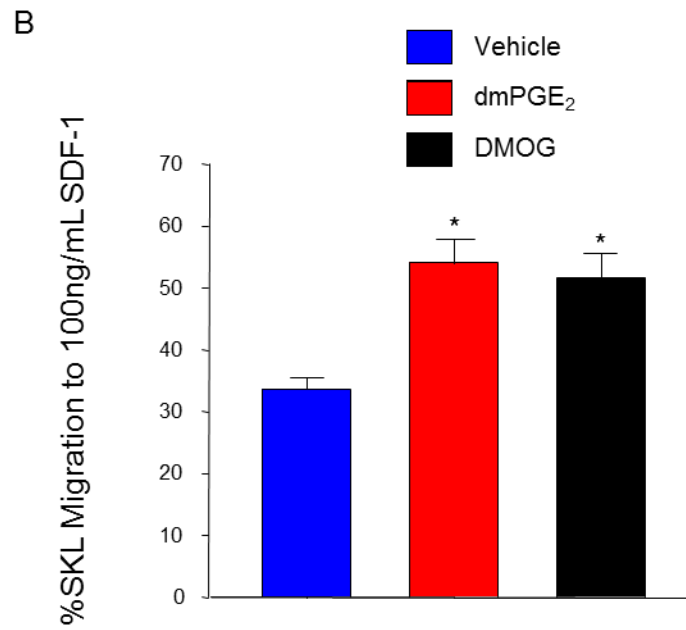
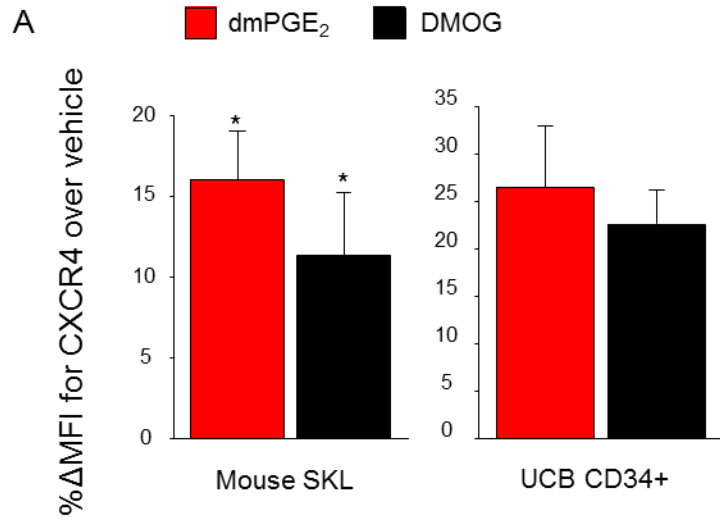
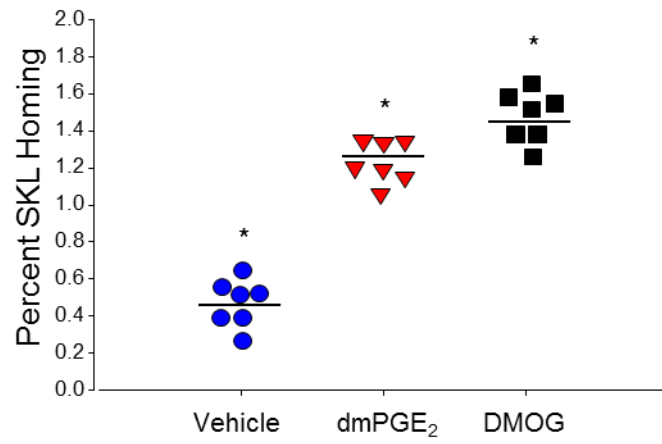

**Figure 8. DMOG increases HSPC CXCR4 and migration to SDF-1.**

(A) (Top) CXCR4 expression (Mean  $\pm$  SEM; N=3) on murine SKL cells 24 hours after treatment with dmPGE<sub>2</sub> or DMOG. CXCR4 cell surface expression was measured as mean fluorescence intensity (MFI) based on isotype control. Data are expressed as percent change in MFI of CXCR4 over vehicle. (Bottom) Similar experiment using human UCB CD34<sup>pos</sup> cells isolated from two patient samples. Data are expressed as Mean  $\pm$  SD, N=2.

(B) *In vitro* Transwell Migration of murine SKL cells.  $1 \times 10^6$  Lineage<sup>neg</sup> cells were treated with vehicle, 1uM dmPGE<sub>2</sub> or 5uM DMOG for 16 hours at 37°C. Cells were assayed for the ability to migrate to 100ng/mL rmSDF-1 for 4 hours at 37°C. Data are expressed as mean  $\pm$  SEM, N=9. \*p<0.05.

Figure 9



B

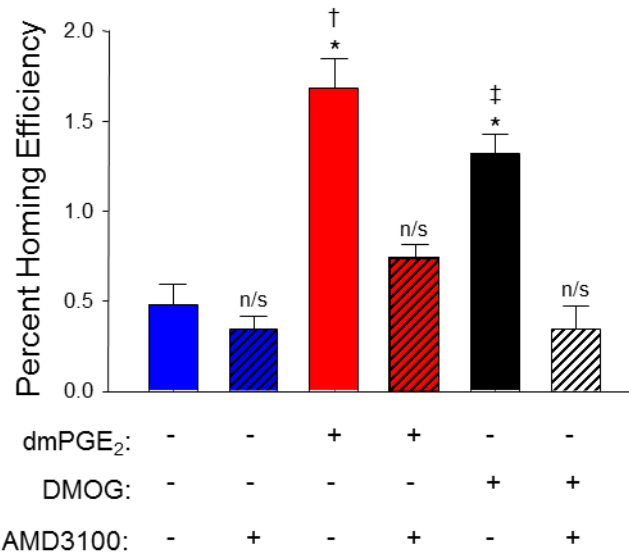



**Figure 9. DMOG enhances HSPC homing.**

(A) Bone marrow cells from CD45.1 mice were treated with vehicle, 1uM dmPGE<sub>2</sub>, or 5uM DMOG and 1x10<sup>6</sup> treated Lineage<sup>neg</sup> cells were transplanted into lethally irradiated CD45.2 mice. Sixteen hours later bone marrow was analyzed for homed SKL cells. Data are represented as mean ± SEM from two separate experiments (N=4-5 mice per group, per experiment, each assayed individually). (B) Similar homing experiment with or without the addition of AMD3100 10 minutes prior to transplant. Data are represented as mean ± SEM from two separate experiments (N=4-5 mice per group, per experiment, each assayed individually) \*p<0.05.

## **DMOG enhances HSC engraftment**

To test DMOG's effects on HSC engraftment, we utilized a limiting-dilution, head to head transplant model employing three different congenic mouse strains, allowing us to determine HSC competitiveness and contribution of both DMOG and vehicle-treated cells within the same recipient using flow cytometry (Figure 10A). Treatment of donor bone marrow cells with DMOG for 2 hours prior to transplant significantly increased peripheral blood (PB) chimerism at 6 months post-transplant compared to cells treated with vehicle control (Figure 10B), with no apparent differences in lineage reconstitution observed between recipients receiving vehicle and DMOG-treated cells (Figure 10C). Enhanced chimerism as a result of DMOG treatment also correlated with a 2-fold increase in HSC frequency determined by Poisson statistics (Figure 11A), and an ~2-fold increase in competitive repopulating units (CRU) (Figure 11B), calculated by the method of Harrison (Harrison, 1980). Due to both PGE<sub>2</sub> and DMOG's effects on HSPC homing, the increased chimerism and resulting increase in HSC frequency is most likely a result of increased homing and retention of HSPCs within the bone marrow. These results indicate that the enhancing effects of dmPGE<sub>2</sub> on HSPC homing and engraftment we previously reported can be mimicked in part by the hypoxia mimetic DMOG, and suggest that the effects of PGE<sub>2</sub> on HSPC function mediated through CXCR4 results as a consequence of stabilization of HIF1 $\alpha$ .

Figure 10

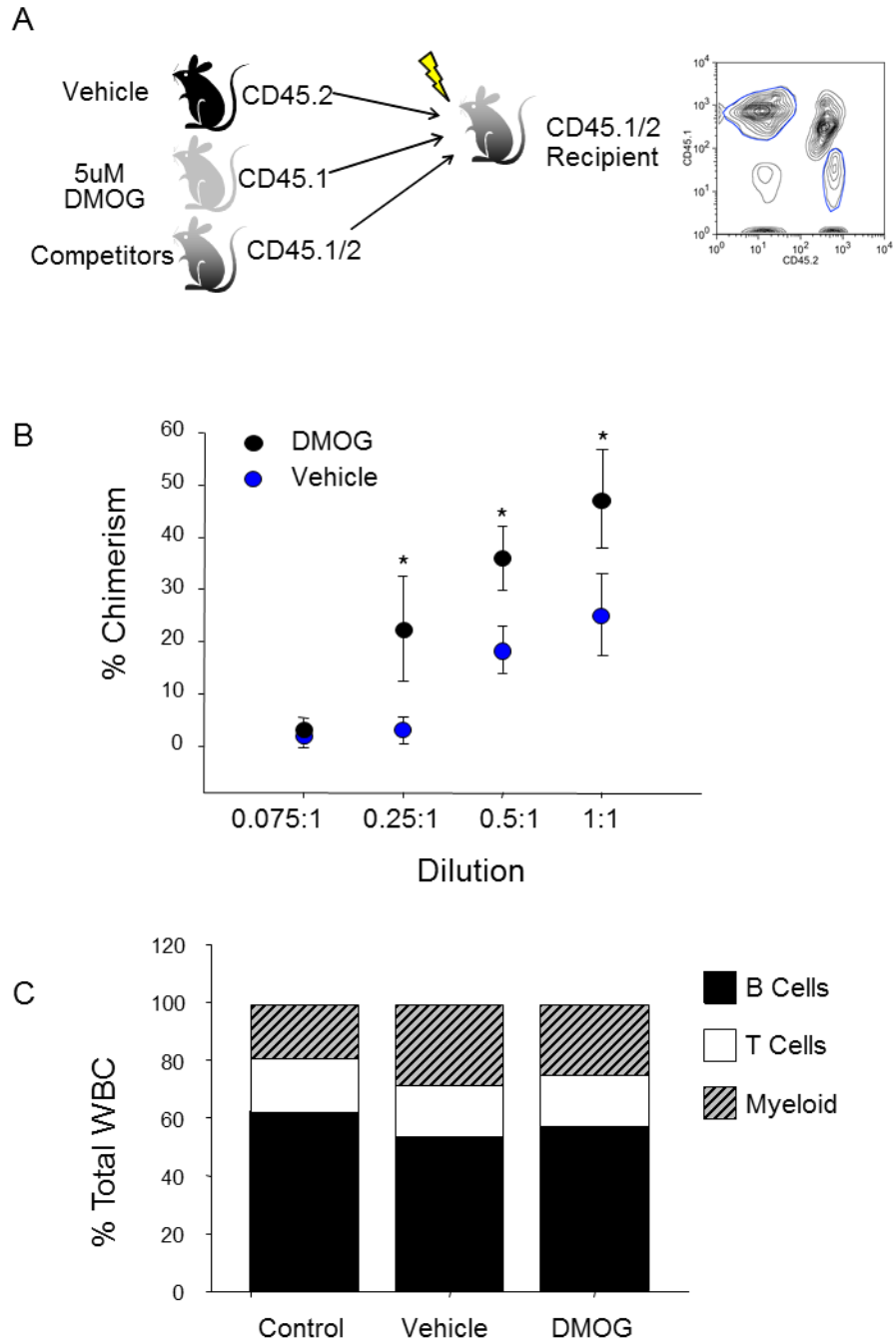

**Figure 10. DMOG enhances HSC engraftment.**

(A) (Left) Representative diagram of competitive head-to-head transplant model. Bone marrow from BoyJ (CD45.1) and C57Bl6 (CD45.2) mice was isolated and treated with either DMOG or vehicle for 2 hours at 37°C. The cells were then transplanted at various dilutions along with  $2 \times 10^5$  competitor cells (CD45.1/CD45.2 F1) into individual lethally irradiated CD45.1/CD45.2 F1 recipients. (Right) Representative flow plot detecting donor marrow chimerism of DMOG (CD45.1) and vehicle (CD45.2) treated cells at 6 months post-transplant. (B) Percent contribution (chimerism) of DMOG and vehicle treated cells in peripheral blood 6 months post-transplant. Data are represented as mean  $\pm$  SEM from two pooled experiments. (N=5 mice/group/expt. each assayed individually) \* $p < 0.05$ . (C) Multilineage analysis for primary transplants (24 weeks). Vehicle-treated cells were (mean  $\pm$  SEM) 28.5%  $\pm$  2.7% Myeloid, 53.8%  $\pm$  2.2% B cells, 17.7%  $\pm$  1.6% T cells, and DMOG-treated cells were 24.9%  $\pm$  0.8% Myeloid, 56.9%  $\pm$  1.4% B cells, 18.2%  $\pm$  1.1% T cells.

Figure 11

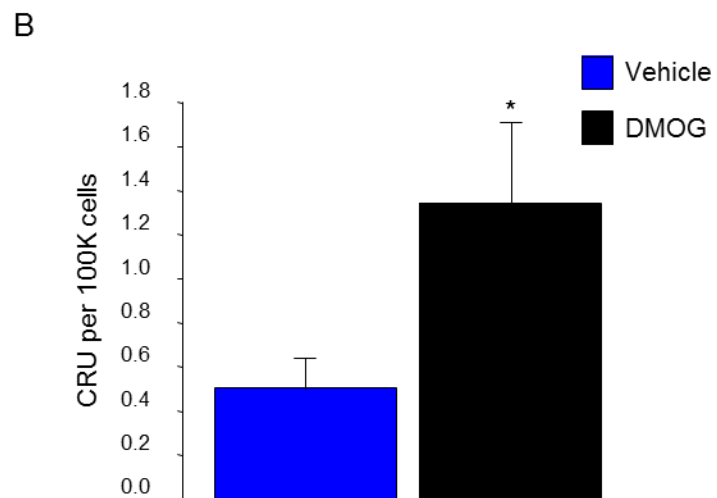
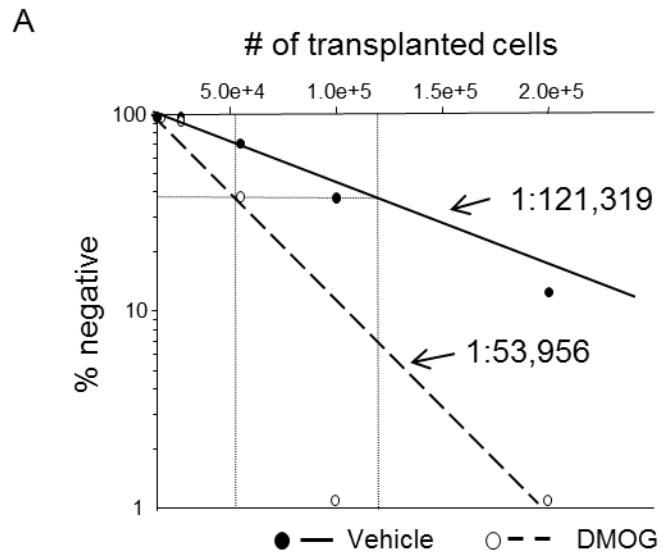

**Figure 11. DMOG increases HSC frequency after transplantation.**

(A) Frequency analysis for vehicle (solid line) and DMOG (dashed line) determined by Poisson statistics using L-Calc software (Stem Cell Technologies, Vancouver, Canada).  $P_0 = 121,319$  (Vehicle) and  $P_0 = 53,956$  (DMOG). (B) Competitive repopulating units (CRU) of DMOG and vehicle treated cells in peripheral blood 6 months post-transplant. Data are represented as mean  $\pm$  SEM from two pooled experiments. (N=5 mice/group/expt. each assayed individually) \* $p < 0.05$ .

### **HIF1 $\alpha$ transcriptional activity is required for PGE<sub>2</sub>-induced CXCR4 upregulation.**

As previously stated, the transcription factor HIF1 $\alpha$  is ubiquitinated and targeted for proteasomal degradation under normoxic conditions (Salceda & Caro, 1997; Maxwell et al., 1999; Kamura et al., 2000). In the absence of oxygen (a hypoxic state), HIF1 $\alpha$  is stabilized and translocated to the nucleus by the beta subunit (HIF1 $\beta$ ), also known as the Aryl Hydrocarbon nuclear translocator (ARNT). The translocated HIF complex interacts with HREs within the promoter of responsive genes (Kaluz et al., 2008) containing a core consensus A/GCGTG sequence, affecting the transcription of a number of genes that regulate migration, proliferation and survival, such as CXCR4 (Schioppa et al., 2003; Staller et al., 2003; Phillips et al., 2005; Zagzag et al., 2006; Wang et al., 2008; Ishikawa et al., 2009) and Survivin (Yang et al., 2004; Peng et al., 2006; Wei et al., 2006).

To further investigate a HIF1 $\alpha$  requirement for PGE<sub>2</sub>-induced CXCR4 upregulation, we utilized a mutant mouse hepatoma cell line lacking the HIF1 $\beta$  nuclear translocator, rendering HIF1 $\alpha$  unable to translocate to the nucleus and initiate gene transcription (Watson et al., 1992). Both the mutant and wild-type cell lines expressed detectable surface CXCR4 (Figure 12A) and mRNA for all four Prostanoid (EP) receptors (Figure 12B). In wild-type cells, pulse-treatment with dmPGE<sub>2</sub> resulted in an ~3-fold increase in CXCR4 mRNA and an ~2-fold increase in CXCR4 surface expression, while HIF1 $\beta$ (-) mutant cells failed to show a significant increase in either CXCR4 mRNA or protein following dmPGE<sub>2</sub> treatment (Figure 13), suggesting that HIF1 $\alpha$  transcriptional activity is required for PGE<sub>2</sub>-induced CXCR4 upregulation.

Figure 12

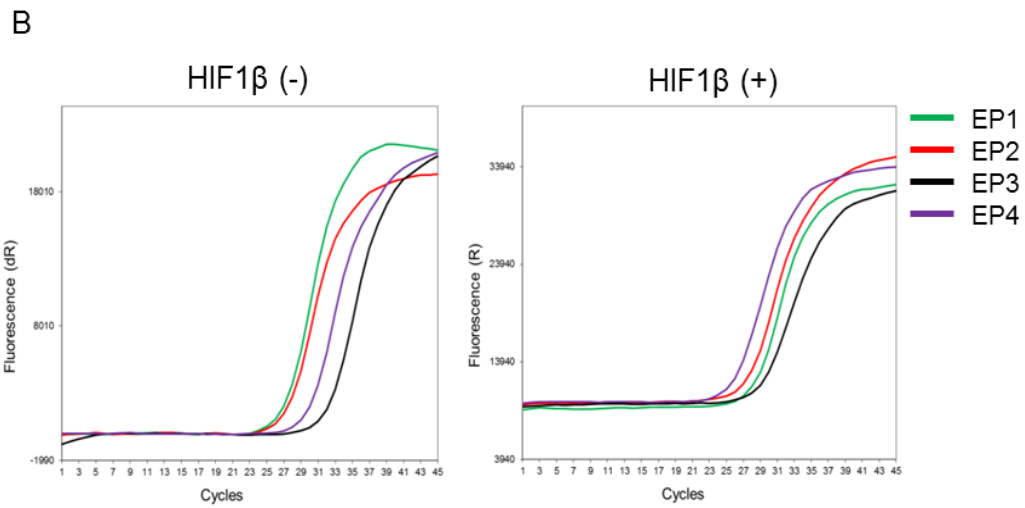
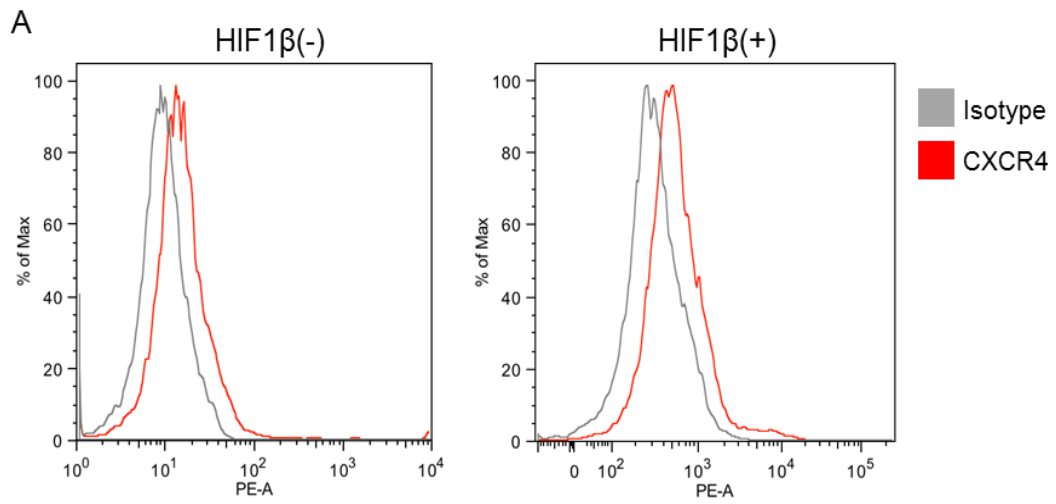
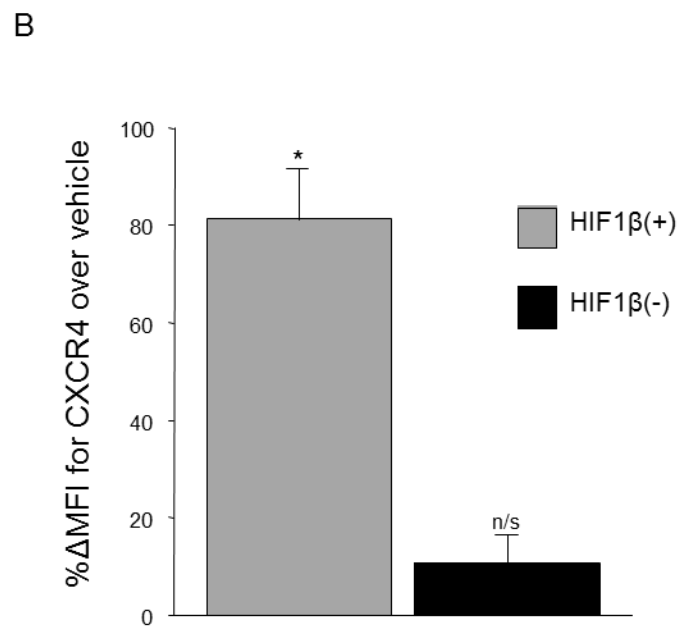
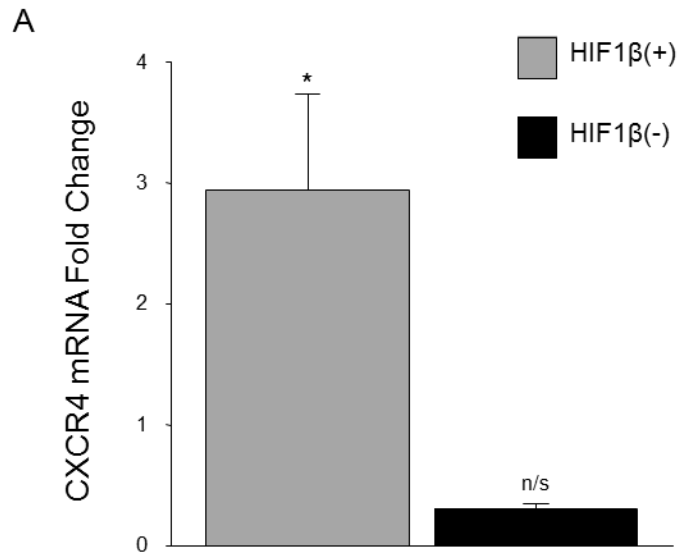



**Figure 12. Mutant HIF1 $\beta$  cells express CXCR4 and PGE<sub>2</sub> EP receptors.**

(A) Representative FACS histograms showing CXCR4 expression on HIF1 $\beta$ (-) and HIF1 $\beta$ (+) cells compared to isotype control. (B) Amplification plots detecting PGE<sub>2</sub> receptor message. Primers specifically for mouse EP1, EP2, EP3, or EP4 were used for qRT-PCR and plots with an activation step of 50°C for 2 minutes, denaturation at 95°C for 2 minutes, and amplification for 45 cycles at 95°C for 15 seconds, 50°C for 30 seconds, and 72°C for 30 seconds are shown.

Figure 13



**Figure 13. HIF1 $\alpha$  transcriptional activity is necessary for PGE<sub>2</sub>-induced CXCR4 upregulation.**

(A) CXCR4 expression (mean  $\pm$  SEM; N=3) in HIF1 $\beta$ (+) and HIF1 $\beta$ (-) cells 2 hours after treatment with vehicle or dmPGE<sub>2</sub> determined by SYBR Green qRT-PCR. (B) CXCR4 cell surface expression (mean  $\pm$  SEM; N=3) on HIF1 $\beta$ (+) and HIF1 $\beta$ (-) cells 24 hours after treatment with dmPGE<sub>2</sub>. CXCR4 cell surface expression was determined by flow cytometry. Data are expressed as percent change in mean fluorescence intensity (MFI) of CXCR4 over vehicle. \*p<0.05.

**The -1.3kb hypoxia response element is required for PGE<sub>2</sub>-induced CXCR4 upregulation.**

There are three potential HRE's within the CXCR4 promoter, located 2.0, 1.3 and 1.0 kilobases upstream from the transcriptional start site (Staller et al., 2003). By means of sequential exclusion of each HRE, it was determined that the HRE located at the -1.3kb position is required for upregulation of CXCR4 in hypoxia. Using the same truncated luciferase promoter vectors containing specific combinations of HREs within the CXCR4 promoter (Figure 14A), we observed a significant increase in luciferase activity in dmPGE<sub>2</sub>-treated cells transfected with the vector containing the -1.3kb HRE. However, when the -1.3kb HRE was either absent ( $\Delta$ HRE2) or mutated (HRE2 Mut), no change in luciferase activity (Figure 14B) was observed, indicating that the -1.3kb HRE is required for CXCR4 regulation by both hypoxia and dmPGE<sub>2</sub> treatment. This further supports the hypothesis that PGE<sub>2</sub> can act as a hypoxia mimetic by stabilizing HIF1 $\alpha$  as well as increasing downstream HIF-responsive genes. Furthermore, the mutant HIF1 $\beta$  data indicate that HIF1 $\alpha$  nuclear translocation is required for PGE<sub>2</sub>'s effects on CXCR4, and that gene transcription of CXCR4 after PGE<sub>2</sub> treatment occurs through nuclear translocation and binding to a specific HRE within the CXCR4 promoter.

Figure 14

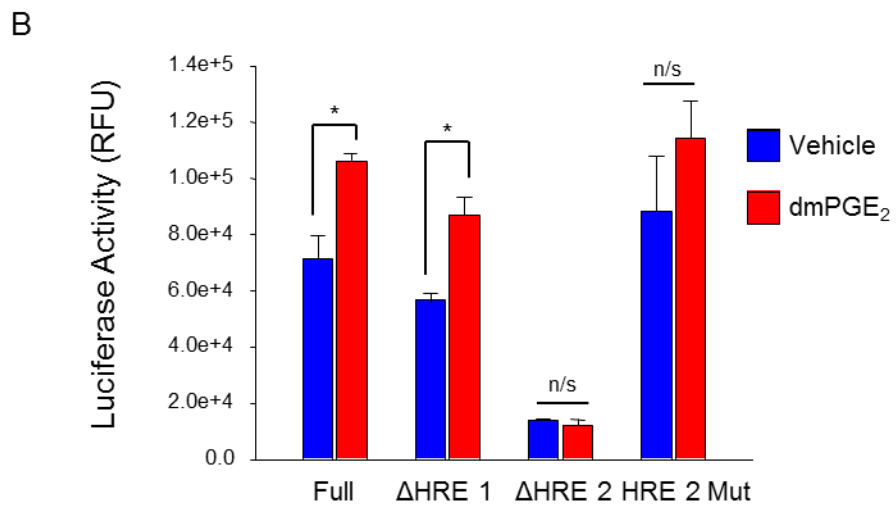
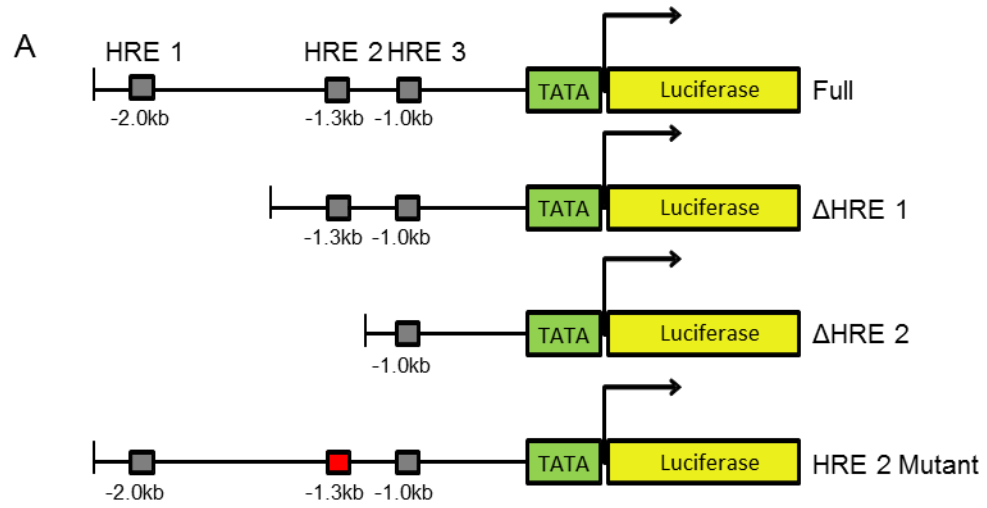

**Figure 14. The -1.3kb HRE is required for enhanced CXCR4 after PGE<sub>2</sub> treatment.**

(A) Schematic of pGL2b luciferase reporter constructs containing various regions of the murine CXCR4 promoter. (B) *In vitro* Luciferase reporter assay. 293T cells were transfected with either full-length CXCR4 promoter constructs containing all HREs (Full), truncated constructs containing two ( $\Delta$  HRE1) or one HRE ( $\Delta$  HRE2), or a mutated 1.3kb HRE (HRE 2 Mut). After 24 hours, cells were split equally and treated with either vehicle or dmPGE<sub>2</sub> for 16 hours at 37°C. Luciferase activity was measured using the Firefly Luciferase assay kit (Promega). Data are represented as mean  $\pm$  SEM from two separate experiments (N=6). \*p<0.05.

## **HIF1 $\alpha$ is required for CXCR4 upregulation and enhanced migration in PGE<sub>2</sub>-treated HSPCs.**

To further support the hypothesis that HIF1 $\alpha$  is required for transcriptional regulation of CXCR4 after PGE<sub>2</sub> treatment, we investigated whether the effects of PGE<sub>2</sub> on increasing CXCR4 expression and migration to SDF-1 in primary HSPCs could be blocked by treatment with sodium nitroprusside (SNP). SNP inhibits the stabilization of HIF1 $\alpha$  by acting as a nitric oxide (NO) donor and providing an oxygen substrate for prolyl hydroxylase activity (Sogawa et al., 1998). Treatment of Lineage<sup>neg</sup> mouse bone marrow with both dmPGE<sub>2</sub> and SNP inhibited both the increase in HIF1 $\alpha$  stabilization (Figure 15A) as well as upregulation of the HIF responsive genes *Adm* and *GLUT1* (Figure 15B). Addition of SNP also blocked the increase in CXCR4 expression and migration to SDF-1, normally seen with PGE<sub>2</sub> treatment (Figure 15C). To further link the effect of PGE<sub>2</sub> to HIF1 $\alpha$  we created a conditional HIF1 $\alpha$  knockout (KO) mouse model by breeding HIF1 $\alpha$ <sup>flox/flox</sup> mice with ERT2-Cre mice, creating a Cre<sup>+</sup>HIF1 $\alpha$ <sup>flox/flox</sup> mouse in which Cre recombinase is under the control of the estrogen receptor. Treatment with tamoxifen results in HIF1 $\alpha$  gene deletion, as evident in a ~99% knockdown of HIF1 $\alpha$  mRNA (Figure 16). Using this model of HIF1 $\alpha$  gene deletion, we observed no increase in functional HSPC homing in HIF1 $\alpha$  KO cells after dmPGE<sub>2</sub> treatment, compared to a 2-fold increase in their floxed wild-type (WT) counterparts (Figure 17A). In addition, no increase in CXCR4 expression was observed after dmPGE<sub>2</sub> treatment in the HIF1 $\alpha$  KO cells (Figure 17B), further supporting that HIF1 $\alpha$  is required for PGE<sub>2</sub>-induced CXCR4 upregulation.

Figure 15

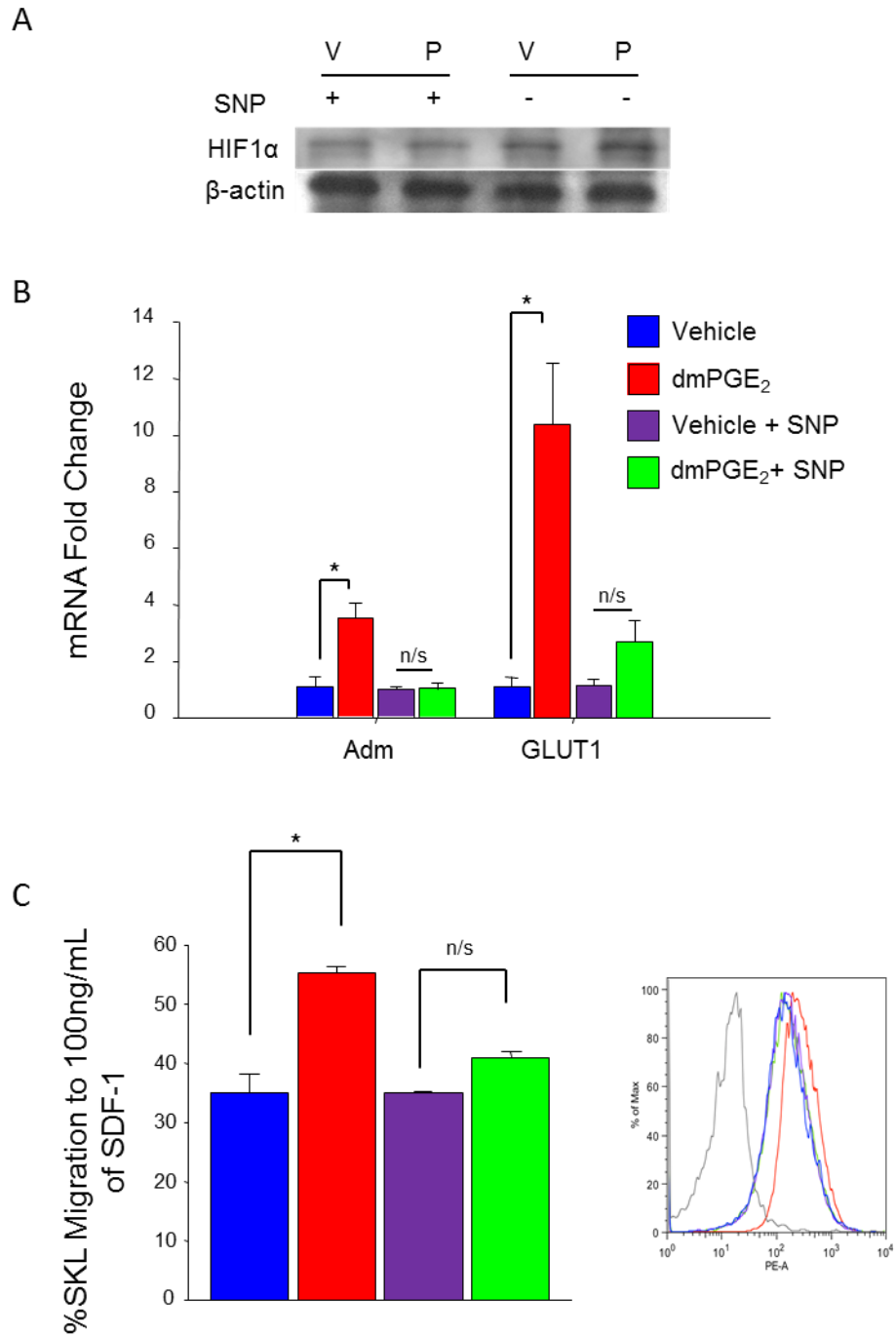
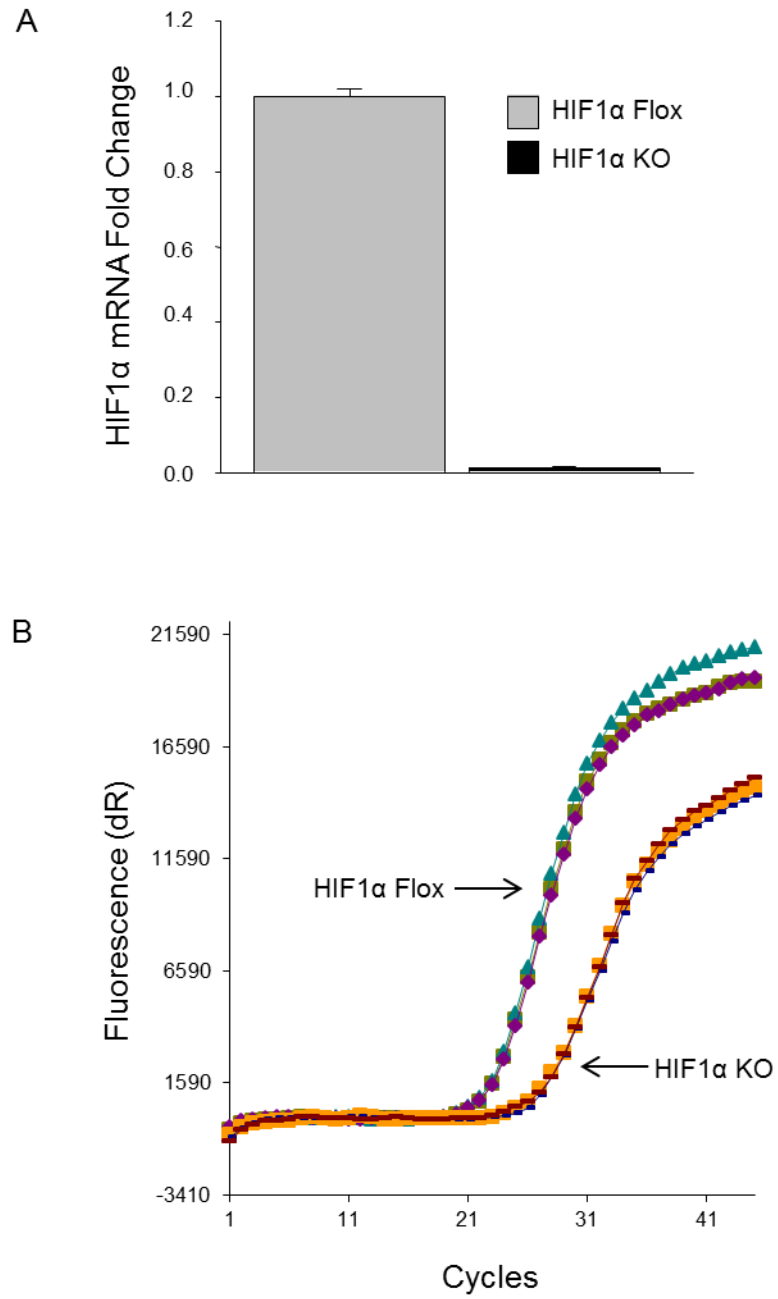



**Figure 15. Blockade of HIF1 $\alpha$  stabilization and activity by SNP inhibits PGE<sub>2</sub>-enhanced migration and CXCR4 expression.**

(A) (Top) Representative blot of HIF1 $\alpha$  protein 4 hours after treatment with vehicle or dmPGE<sub>2</sub>, with or without the addition of SNP. (Bottom) Expression of HIF1 responsive genes after treatment with vehicle or dmPGE<sub>2</sub> with or without SNP. Data are expressed as mean  $\pm$  SEM, N=3. (B) (Left) *In vitro* Transwell migration of murine SKL cells to 100ng/mL SDF-1. Lineage<sup>neg</sup> cells were treated with vehicle or 1 $\mu$ M dmPGE<sub>2</sub> with or without 100 $\mu$ M sodium nitroprusside (SNP) for 2 hours at 37°C. Data are expressed as mean  $\pm$  SEM, N=3. \*p<0.05. (Right) Representative FACS histogram showing CXCR4 expression on SKL cells compared to isotype control.

Figure 16



**Figure 16. Tamoxifen treatment of Cre<sup>+</sup>HIF1 $\alpha$ <sup>flox/flox</sup> mice results in HIF1 $\alpha$  gene deletion.**

(Top) HIF1 $\alpha$  message determined by SYBR Green qRT-PCR fourteen days post-tamoxifen treatment relative to wild-type expression. (Bottom) Representative amplification plot of HIF1 $\alpha$  mRNA from three individual mice.

Figure 17

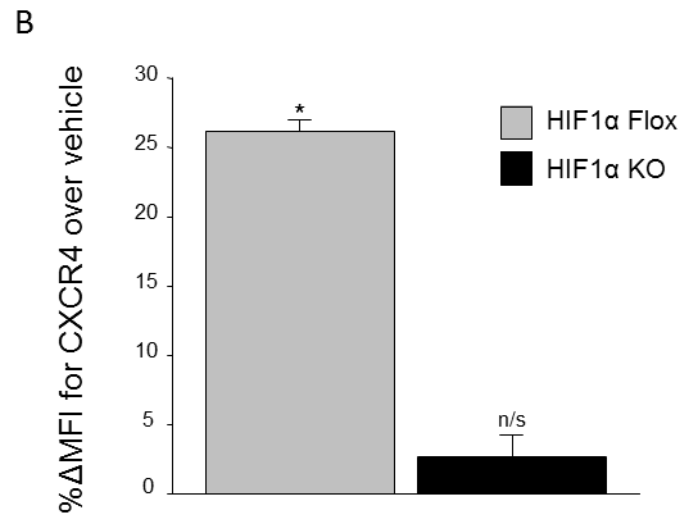
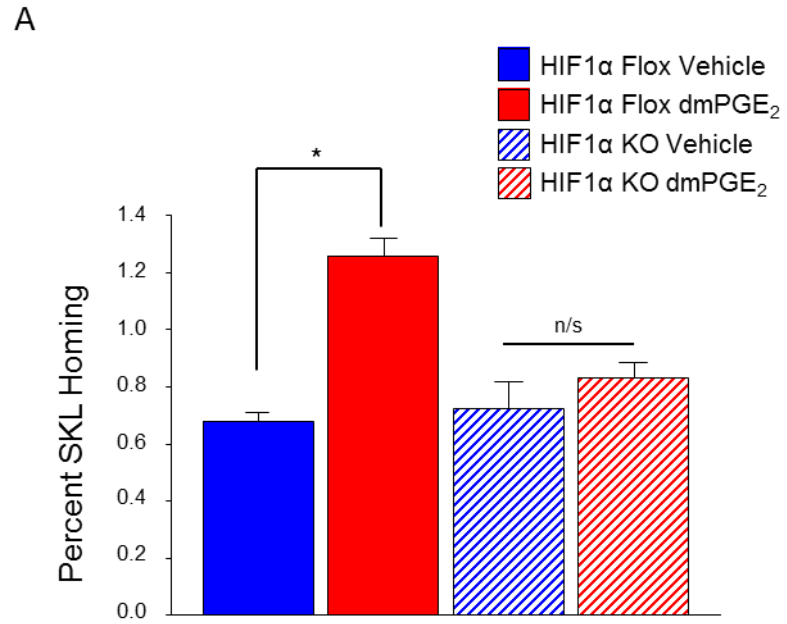

**Figure 17. HIF1 $\alpha$  is required for functional HSPC homing after PGE<sub>2</sub> treatment.**

(A) *In vivo* homing of HIF1 $\alpha$  KO cells. Bone marrow cells from conditional HIF1 $\alpha$  KO or Floxed control (CD45.2) mice were treated with vehicle or dmPGE<sub>2</sub> and 1x10<sup>6</sup> treated Lineage<sup>neg</sup> cells were transplanted into lethally irradiated BoyJ (CD45.1) mice. Sixteen hours later bone marrow was analyzed for homed SKL cells. Data are represented as mean  $\pm$  SEM from one experiment (N=4-5 mice per group, per experiment, each assayed individually). (B) CXCR4 expression (mean  $\pm$  SEM) on HIF1 $\alpha$  KO and HIF1 $\alpha$  Floxed SKL cells 24 hours after treatment with dmPGE<sub>2</sub>. N=3 individual mice. \*p<0.05.

## Discussion

While hypoxia and HIF1 $\alpha$  are widely known for their roles in steady-state and tumor angiogenesis, their role in hematopoiesis is now becoming more apparent. Given the low O<sub>2</sub> content in the bone marrow compared to the rest of the body (Harrison et al., 2002) and perturbation of hematopoiesis by elevated reactive oxygen species (ROS) in environments with high O<sub>2</sub> levels (Jang & Sharkis, 2007), it is logical to believe that hypoxia and HIF1 $\alpha$  would be involved in HSC function and maintenance. Interesting evidence from Parmar et al. suggested that more quiescent stem cells were located in highly hypoxic areas of the bone marrow based on their uptake of Hoechst 33342 diffusion dye, as well as their ability to produce long-term HSCs after transplant (Parmar et al., 2007). Kubota et al. demonstrated that highly quiescent stem cells were located furthest away from capillaries and closer to the bone surface within the hematopoietic bone marrow niche (Kubota et al., 2008).

More recently, HIF1 $\alpha$  specifically has been revealed as an important factor in cell-cycle regulation of HSCs and it appears that a specific level of HIF1 $\alpha$  stabilization is necessary for optimal HSC maintenance. Takubo et al. demonstrated that loss of HIF1 $\alpha$  in HSCs resulted in devastating effects on their long-term hematopoietic reconstitution, due to a loss of HSC quiescence (Takubo et al., 2010). Conversely, overexpression of HIF1 $\alpha$  via deletion of the HIF degradation-targeting ubiquitin ligase VHL, resulted in an increase in the number of HSCs in G<sub>0</sub> phase and impaired reconstitution after transplantation. Most interestingly, they observed a surprising increase in PB chimerism after transplant with partial stabilization of HIF1 $\alpha$  via heterozygous loss of VHL, while

total loss of VHL and overexpression of HIF1 $\alpha$  resulted in impaired homing ability and stem cell exhaustion. Additionally, it was shown by Roy et al. that human CD34<sup>+</sup> cells cultured in hypoxic conditions exhibited higher colony-forming and SCID-repopulating potential, as well as elevated levels of CXCR4 (Roy et al., 2012). These observations corroborate the idea that minimal levels of HIF1 $\alpha$  stabilization are beneficial to HSC function and maintenance within the bone marrow niche. Indeed, we now provide evidence that modest increases in HIF1 $\alpha$  stabilization by dmPGE<sub>2</sub> treatment result in significant improvements to HSC homing and engraftment, mainly due to upregulation of CXCR4.

Our previous studies suggested that pulse-exposure to dmPGE<sub>2</sub> has pleotropic effects on HSCs, including effects on apoptosis and cell cycle progression, resulting in a four-fold increase in HSC frequency after engraftment. The four-fold increase in frequency was attributed to a two-fold increase in homing paired with a two-fold increase in cells entering into cell cycle. In the current study, we only observed a two-fold increase in HSC frequency after pulse treatment with DMOG, as well as complete abolishment of DMOG-enhanced homing after CXCR4 antagonism, suggesting that stabilizing HIF1 $\alpha$  may only be affecting HSC engraftment through upregulation of CXCR4 that results in increased homing, but not cell proliferation. Despite Takubo's observed effects of HIF1 $\alpha$  on cell cycle regulation, it is possible that PGE<sub>2</sub>'s influence on HSC cell cycle is not specifically due to HIF1 $\alpha$  stabilization. Conversely, they did not see any effects on apoptosis in HIF1 $\alpha$  KO mice, despite evidence linking both HIF1 $\alpha$  and PGE<sub>2</sub> to regulation of the anti-apoptotic protein Survivin (Hoggatt et al., 2009; Li et al., 2013; Bai

et al., 2013). It is therefore entirely possible that PGE<sub>2</sub>, due to its multiple and sometimes opposing receptor signaling pathways, could be affecting different molecules independent of each other. Furthermore, despite our novel evidence that PGE<sub>2</sub> enhances HSC homing through stabilization of HIF1 $\alpha$ , the exact mechanism through which it is exerting its effects specifically on HIF1 $\alpha$  remains unknown. Therefore, further studies are needed in order to elucidate the specific receptor/pathway involved in each aspect of PGE<sub>2</sub>'s effects on HSC function. It is also important not to rule out effects on HIF2 $\alpha$ , as it has been well established that HIF1 and HIF2 have varying roles in cell function (Hu et al., 2003). It is entirely possible that the pleiotropic effects we observe on PGE<sub>2</sub>-treated cells could involve both proteins and their differential roles in gene regulation.

In summary, we have provided new mechanistic insight into PGE<sub>2</sub>'s effects on HSC functional homing and engraftment. A modest but significant increase of HIF1 $\alpha$  protein is observed in HSPCs after dmPGE<sub>2</sub> pulse-exposure, and when mimicked by DMOG treatment, this slight increase in HIF1 $\alpha$  protein translates to a two-fold increase in homing and HSC engraftment. This is the first evidence that HIF1 $\alpha$  stabilization by DMOG improves HSC homing and engraftment, and along with recent evidence that *in vivo* administration of DMOG enhances HSC recovery after total body irradiation (Forristal et al., 2013), reveals a new potential therapeutic tool to enhance HSC function after transplant both *in vitro* and *in vivo*.



### Chapter 3. Rac1: A player in the PGE<sub>2</sub>/HIF1 $\alpha$ /CXCR4 axis.

#### Introduction

In Chapter 2, we demonstrated that HIF1 $\alpha$  is required for PGE<sub>2</sub> to upregulate HSPC CXCR4 expression and enhance function after transplant. However, the exact mechanism through which PGE<sub>2</sub> is exerting its effects on HIF1 $\alpha$  remains unclear. Our previous studies suggest that pulse-exposure to dmPGE<sub>2</sub> has pleiotropic effects on HSCs as a consequence of interaction with its four receptors, and several pathways downstream of PGE<sub>2</sub> have been linked to HIF1 $\alpha$  regulation, such as cAMP/PKA/Wnt/ $\beta$ -catenin (Goessling et al., 2009; Lee et al., 2009) and PI3K/Akt (Jiang et al., 2001). Intriguingly, both pathways have been linked to regulation of the small GTPase Rac1 (Hirota & Semenza, 2001; Bachmann et al., 2013). As previously described, Rac1 is a member of the Rho family of small GTPases that are known to influence actin polymerization and facilitate cell motility. Rac proteins consist of three different isoforms, Rac1, Rac2 and Rac3, all with high sequence similarity. Rac1 is ubiquitously expressed throughout the body, whereas Rac2 is restricted to hematopoietic cells and Rac3 to the heart, brain and placenta. Interestingly, hematopoietic cells are the only cells that express all three isoforms (Williams et al., 2008).

Despite the separate and overlapping roles of Rac1 and Rac2 in hematopoietic cell function (Gu et al., 2003; Walmsley et al., 2003; Filippi et al., 2004), Rac1 has been shown to be most important for HSC homing and engraftment (Gu et al., 2003; Cancelas et al., 2005; Cancelas et al., 2006) and is required for HIF1  $\alpha$  activity (Hirota & Semenza,

2001). In addition to its involvement in HIF1 $\alpha$  regulation, Rac1 can colocalize with CXCR4 within lipid rafts in the cell membrane (Wysoczynski et al., 2005), suggesting Rac1 as a potential link in the PGE<sub>2</sub>/ HIF1 $\alpha$  /CXCR4 axis. In an attempt to further dissect the mechanism behind PGE<sub>2</sub>'s enhancing effects on HSCs, we hypothesized that PGE<sub>2</sub> may influence HIF1 $\alpha$  protein through modulation of Rac1 protein.

## **Materials and Methods**

### **Mice**

C57BL/6 mice were purchased from The Jackson Laboratory (Bar Harbor, ME) and maintained in the Indiana University School of Medicine (IUSM) animal facility. Conditional MxCre- Rac1 and germline Rac2 KO mice were provided by Dr. Rueben Kapur, Department of Pediatrics, Indiana University School of Medicine (IUSM). Rac1 gene deletion was initiated by five consecutive daily injections of PolyI:PolyC, followed by a 7 day rest period. All mouse experiments were approved by the Institutional Animal Care and Use Committee (IACUC) of IUSM.

### **dmPGE<sub>2</sub> Pulse-exposure**

16-16 dimethyl prostaglandin E<sub>2</sub> (dmPGE<sub>2</sub>) in methyl acetate (Cayman Chemical, Ann Arbor, MI) was evaporated on ice under N<sub>2</sub> and reconstituted with 100% ethanol at a concentration of 0.1 M. For pulse-exposure experiments, 1x10<sup>6</sup> cells/mL were incubated with dmPGE<sub>2</sub> at 37°C with 5% CO<sub>2</sub> for 2 hours, and were washed twice prior to use in experiments. Vehicle-treated cells were treated in the same manner, using an equivalent volume of ethanol.

### **Flow cytometry analysis**

Bone marrow was harvested from the femurs and tibias of mice and single-cell suspensions were prepared in PBS with 2% HI-FBS (Thermo Scientific HyClone, Logan, UT). Total nucleated cell counts were obtained using a Hemavet-950 (Drew Scientific,

Waterbury, CT). All antibodies were purchased from BD Biosciences (San Jose, CA) unless otherwise noted. For detection of mouse Lineage<sup>neg</sup> Sca-1<sup>pos</sup> ckit<sup>neg</sup> (SKL) populations, c-kit-APC or APC-Cy7, Sca-1-PE or PE-Cy7, Lineage-V450, APC or FITC, CD45.1-PE and CD45.2-FITC were used. CXCR4 was quantitated using CXCR4-PE. For detection of intracellular Rac1, cells were stained for cell surface molecules before being fixed and permeabilized with the BD Fix/Perm kit (BD Biosciences) and then stained with Rac1-FITC. Events were collected using an LSRII flow cytometer (BD Biosciences) and analyses performed using either CellQuest (BD Biosciences) or FlowJo (Tree Star Inc., Ashland, OR) software. For image analysis of Rac1 and CXCR4 colocalization, Lineage<sup>neg</sup> bone marrow cells were treated with vehicle or 1uM dmPGE<sub>2</sub>. Twenty-four hours post-treatment, bright field and fluorescent cell images were acquired using an ImageStream flow cytometer (Amnis, Seattle, WA) by excitation with 488-nm and 635-nm lasers and a time-delay integration charged-coupled device camera. Five thousand events were analyzed using ImageStream data exploration and analysis software. Compensation was digitally performed on a pixel-by-pixel basis prior to data analysis. Cell populations were gated on in focus, live, single cells and Bright Detail Similarity of FITC and APC staining was used to quantify Rac1 and CXCR4 colocalization. The Bright Detail Similarity feature is the log transformed Pearson's correlation coefficient of the localized bright spots with a radius of 3 pixels or less within the masked area of two input images. Correlation values fall between 0 and 1, where 0 is uncorrelated and 1 is perfect correlation.

## Migration Assays

Chemotaxis to SDF-1 was determined using a two-chamber Costar Transwell (6.5-mm diameter, 5µm pore; Cambridge, MA) system as previously described (Fukuda et al., 2005). Briefly, Lineage<sup>neg</sup> bone marrow cells from WT, Rac1 and Rac2 mice were treated with dmPGE<sub>2</sub> and vehicle for 2 hours at 37°C, 5% CO<sub>2</sub>, washed twice and cultured in RPMI/10% HI-FBS overnight to allow for up-regulation of CXCR4. After incubation, cells were washed, resuspended at 1x10<sup>6</sup> cells/mL in RPMI/0.5% BSA and 0.1 mL added to the top chamber of the transwells, with 100 ng/mL rmSDF-1 (R&D Systems, Minneapolis, MN) in the bottom chamber. Cultures were incubated for 4 hours at 37°C and total cells migrating to the bottom chamber were quantitated using a LSRII Flow Cytometer (BD Biosciences). Percent migration was calculated by dividing the total live cell counts in the lower well by the cell input multiplied by 100. Input cells and cells migrated to the lower chamber were stained with Lineage-FITC, Sca-1-PE and ckit-APC antibodies (BD Biosciences), and SKL cell migration determined by comparison to the proportion of input SKL cells.

## Western Blot Analysis

Lineage<sup>neg</sup> cells from WT and Rac1 KO mice were treated with 1µM dmPGE<sub>2</sub> and cultured for 6 hours at 37°C, 5% CO<sub>2</sub>. Cell lysates were obtained by incubating cell pellets in cold RIPA buffer containing protease inhibitor cocktail (Thermo Fisher, Rockford, IL) on ice for 30 minutes. The lysates were centrifuged at 10,000xg for 10 minutes and supernatants were resolved by SDS-Page gel and transferred onto a PVDF

membrane. Membranes were incubated with a monoclonal anti-Rac1 antibody (Clone 23A8) (Millipore, Temecula, CA). Anti- $\beta$ -actin (Cell Signaling Technology, Danvers, MA) was used as a loading control.

## Results

### **PGE<sub>2</sub> treatment increases the small GTPase Rac1.**

As previously mentioned, the Rho family of small GTPases are involved in cell polarization and cytoskeletal rearrangement (Hall, 1998; Tapon & Hall, 1997), and Rac1 and Rac2 have been implicated in HSPC survival, migration, homing and engraftment (Gu et al., 2003). Moreover, Rac1 can colocalize with CXCR4 to promote HSPC migration (Wysoczynski et al., 2005) and is required for activation of HIF1 $\alpha$  (Hirota & Semenza, 2001). This suggests that the enhancing effect of PGE<sub>2</sub> on HSPC homing may be a result of modulation of HSPC Rac1 levels. We therefore first wanted to determine whether dmPGE<sub>2</sub> treatment could upregulate Rac1 protein in HSPCs. Treatment of mouse Lineage<sup>neg</sup> bone marrow cells with dmPGE<sub>2</sub> for 2 hours demonstrated a consistent and significant increase in Rac1 protein expression in SKL cells measured by flow cytometry (Figure 18A), and an increase in Rac1 protein in Lineage<sup>neg</sup> cells measured by western blot (Figure 18B).

Figure 18

A

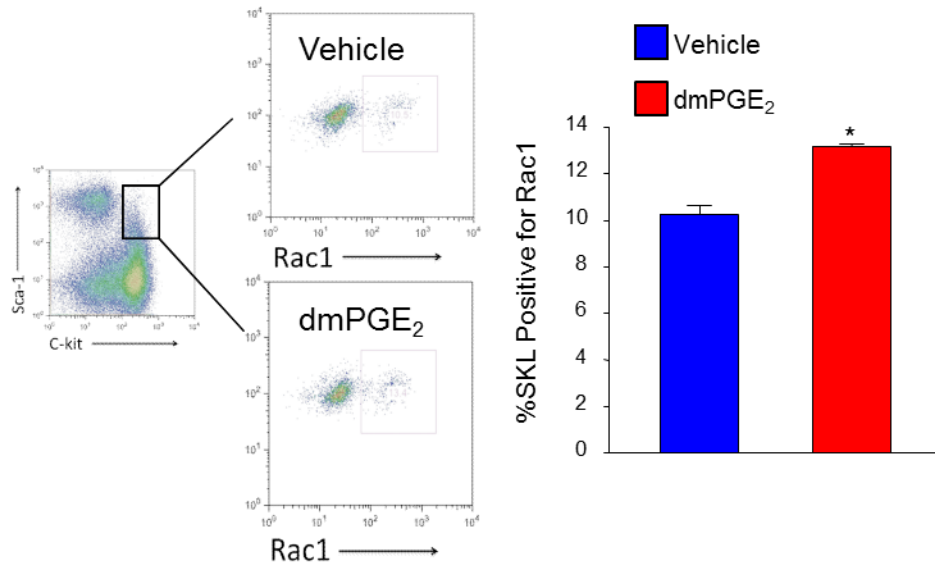

B

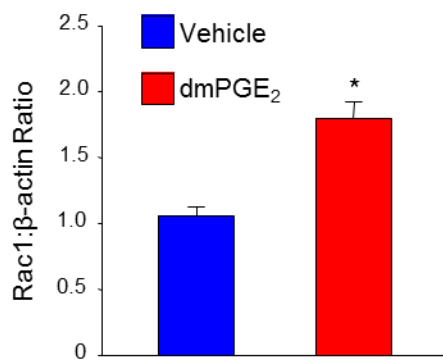



**Figure 18. PGE<sub>2</sub> increases Rac1 in HSPCs.**

(A) (Left) Representative flow plots detecting intracellular Rac1 in mouse SKL cells 24 hours after treatment with 1uM dmPGE<sub>2</sub>. (Right) Quantification of Rac1 positive SKL cells after dmPGE<sub>2</sub> treatment by flow cytometry. Data are expressed as mean percent cells positive for Rac1 ± SEM. N = 3. (B) Densitometry analysis of Rac1 protein in Lineage<sup>neg</sup> cells treated with 1uM dmPGE<sub>2</sub>, determined by western blot. Data are expressed as mean Rac1: β-actin ratio ± SEM. N = 3. \*p<0.05.

### **PGE<sub>2</sub> treatment increases Rac1 and CXCR4 colocalization.**

It is believed that activation of Rac and its downstream effectors controls membrane ruffling and actin polymerization both of which contribute to cell migration and adhesion (Ridley & Hall, 1992a; Ridley et al., 1992). Rac1 has been shown to colocalize with and be subsequently activated by CXCR4, mainly through the binding of SDF-1 (Wysoczynski et al., 2005). This colocalization event facilitates enhanced migration of HSPCs. Along with the observation that *in vivo* biallelic loss of Rac1 and Rac2 results in massive egress of HSPCs from the bone marrow, and that Rac1 null cells are unable to home to the endosteal regions of the bone marrow, these observations suggest that Rac1 and CXCR4 colocalization are crucial for movement of HSPCs to and from the bone marrow niche. Based on our evidence that PGE<sub>2</sub> can increase both Rac1 and CXCR4 expression, we hypothesized that the colocalization of these two proteins would also be enhanced after dmPGE<sub>2</sub> treatment. Using state-of-the-art imaging technology, we found that Rac1 and CXCR4 colocalization in Lineage<sup>neg</sup> bone marrow cells was indeed increased after 1uM dmPGE<sub>2</sub> treatment (Figure 19A). After normalization, the Bright Detail Similarity coefficient for vehicle treated cells was 0.095, indicating that there was little to no correlation between Rac1 and CXCR4 localization. However, the correlation coefficient for dmPGE<sub>2</sub> treated cells was 0.778, confirming higher colocalization between the two proteins.

Additionally, analysis of dose-response curves of SDF-1 concentration and HSPC migration revealed a significantly lowered half maximal effective concentration (EC<sub>50</sub>) of SDF-1 by approximately 10-fold in PGE<sub>2</sub>-treated cells (Figure 19B), indicating that PGE<sub>2</sub>

treatment and increased Rac1 and CXCR4 colocalization enhances HSPC's sensitivity to SDF-1. Taken together, these data confirm that PGE<sub>2</sub> treatment not only increases expression of both Rac1 and CXCR4, but facilitates their colocalization, priming the cells for enhanced migration in response to SDF-1 and/or other chemokines. Similar effects may occur for other chemokines, however this remains to be tested.

Figure 19

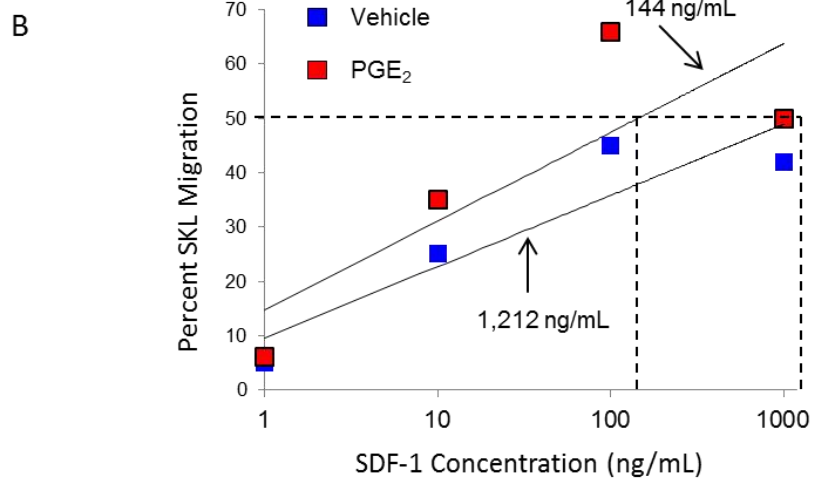
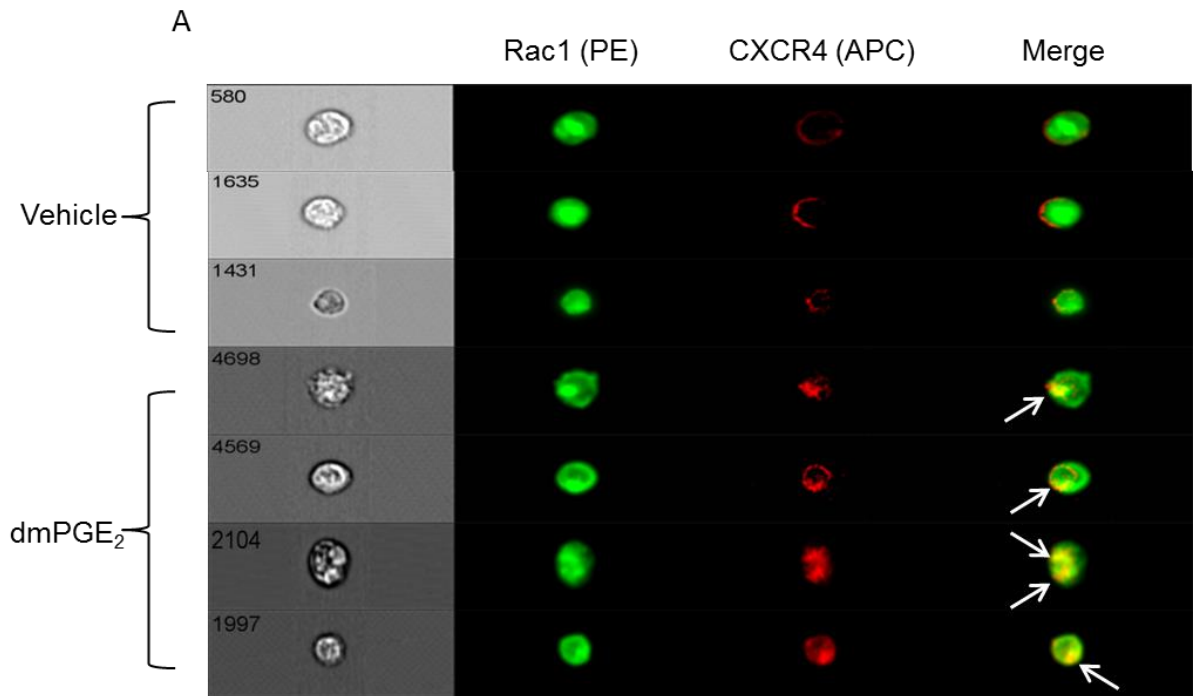

**Figure 19. PGE<sub>2</sub> increases Rac1 and CXCR4 colocalization in HSPCs.**

(A) Representative ImageStream images of a selection of Lineage<sup>neg</sup> bone marrow cells 24 hours after treatment with vehicle or 1uM dmPGE<sub>2</sub>. Arrows indicate areas of Rac1: CXCR4 colocalization. (B) Half maximal effective concentration analysis of SDF-1 in PGE<sub>2</sub> and vehicle treated cells as a function of SKL migration. Line of best fit equation for vehicle and PGE<sub>2</sub> treated cells are  $y = 5.6893\ln(x) + 9.6$  and  $y = 7.079\ln(x) + 14.8$ , respectively.

### **Rac1, but not Rac2 is required for PGE<sub>2</sub>-enhanced HSPC migration.**

Given the finding that dmPGE<sub>2</sub> treatment enhances the expression and colocalization of Rac1 and CXCR4 and the known fact that colocalization of Rac1 and CXCR4 enhances HSPC sensitivity to SDF-1 (Wysoczynski et al., 2005), we next evaluated a role for Rac1 in the enhancing effect of PGE<sub>2</sub> on HSPC function in a functional migration assay. Bone marrow cells from conditional Rac1 and germline Rac2 KO mice were treated with dmPGE<sub>2</sub> and CXCR4 expression and migration to SDF-evaluated *in vitro*. Treatment of Mx-Cre Rac1<sup>flox/flox</sup> mice with PolyI:C effectively reduces Rac1 protein in bone marrow cells (Figure 20A western blot). While SKL cells from WT mice showed increased migration to SDF-1 (Figure 20A) and enhanced CXCR4 expression (Figure 20B) following dmPGE<sub>2</sub> treatment, Rac1 KO cells failed to show the same increase.

Conversely, similar treatment of Rac2 KO cells with dmPGE<sub>2</sub> resulted in an increase SKL migration (Figure 21A) and enhanced CXCR4 expression (Figure 21B) equivalent to wild-type, suggesting that despite its exclusivity to hematopoietic cells, Rac2 is dispensable for PGE<sub>2</sub>'s effects on HSPC function. Overall, these studies indicate that Rac1, but not Rac2 is required for PGE<sub>2</sub>-induced enhanced CXCR4 expression and HSPC migration.

Figure 20

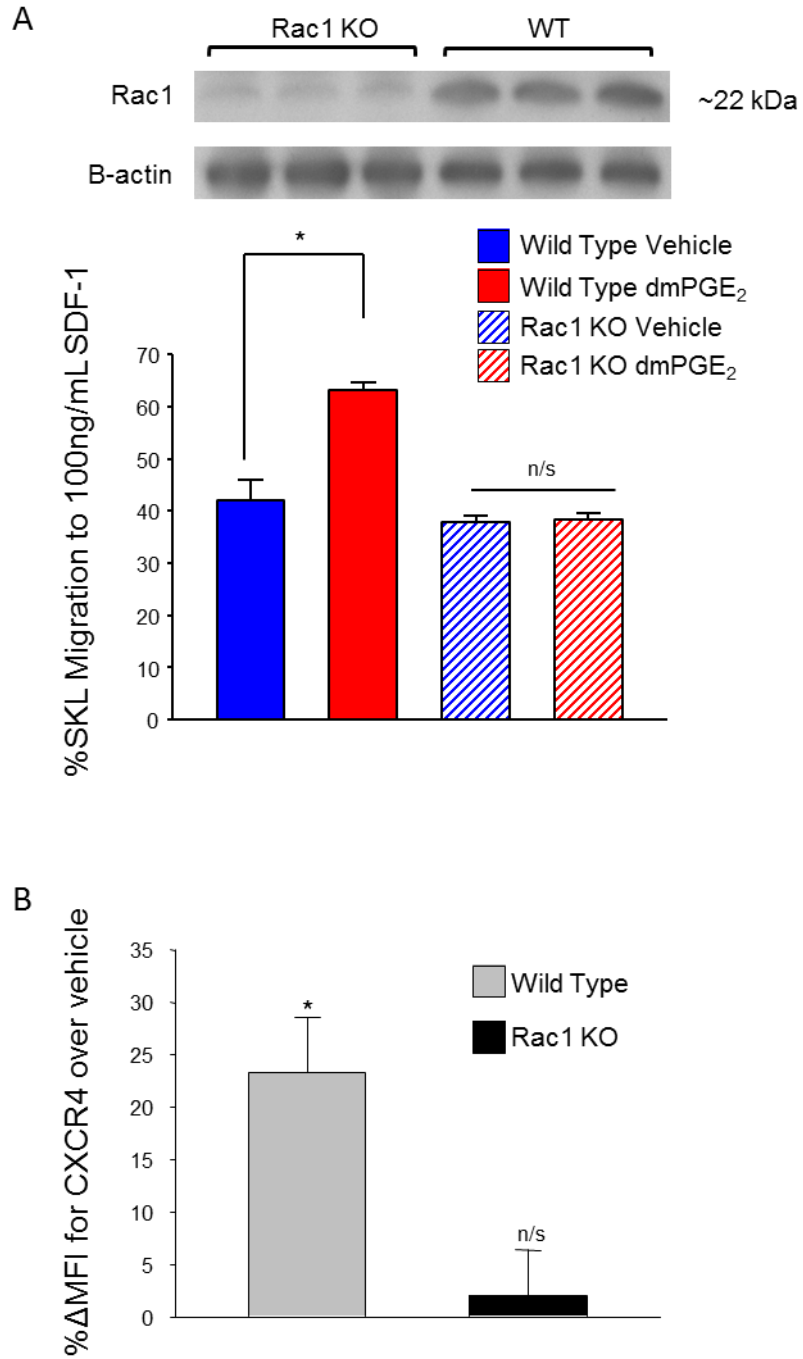
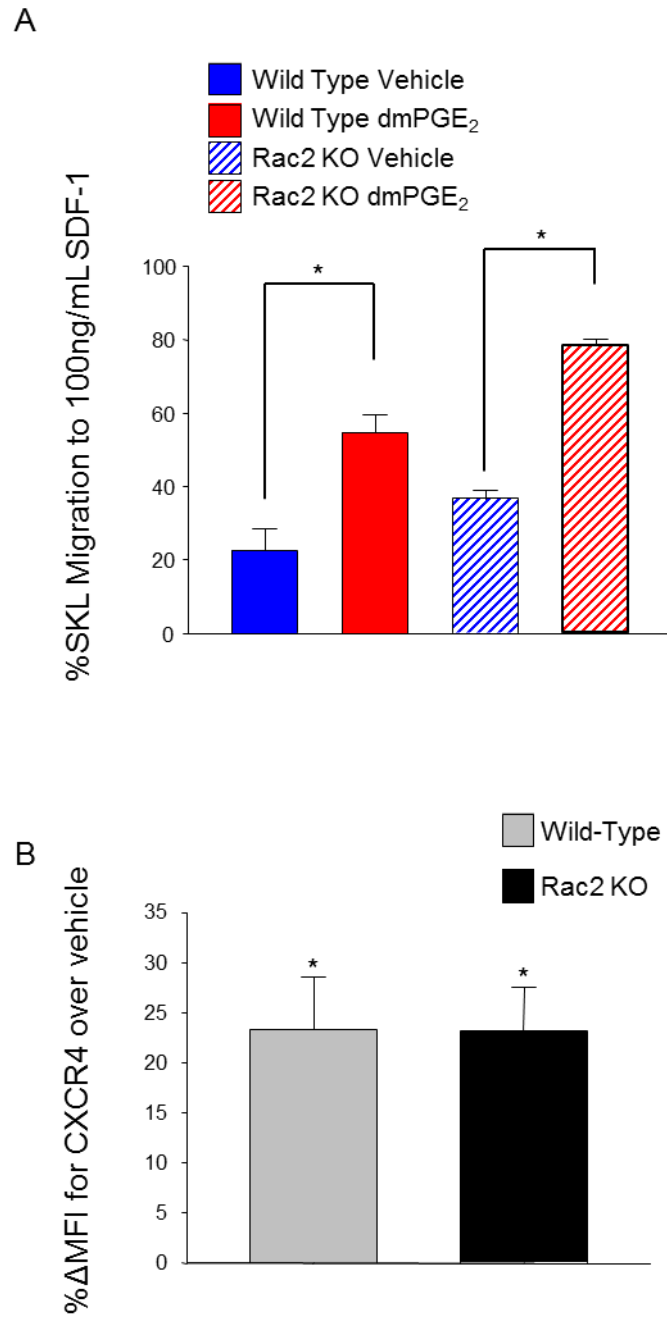

**Figure 20. Loss of Rac1 abolishes PGE<sub>2</sub>-enhanced HSPC migration.**

(A) (Top) Western blot of Rac1 protein representing knockout of Rac1 after PolyI:C treatment. (Bottom) *In vitro* Transwell Migration of murine WT or Rac1 KO SKL cells.  $1 \times 10^6$  Lineage<sup>neg</sup> cells were treated with vehicle or 1 $\mu$ M dmPGE<sub>2</sub> for 16 hours at 37°C. Cells were assayed for the ability to migrate to 100ng/mL rmSDF-1 for 4 hours at 37°C. Data are expressed as mean  $\pm$  SEM, N=3. (B) CXCR4 expression (Mean  $\pm$  SEM; N=3) on WT or Rac1 KO SKL cells 24 hours after treatment with dmPGE<sub>2</sub>. CXCR4 cell surface expression was measured as mean fluorescence intensity (MFI) based on isotype control. Data are expressed as percent change in MFI of CXCR4 over vehicle. \*p<0.05.



Figure 21



**Figure 21. Rac2 is dispensable for PGE<sub>2</sub>-enhanced HSPC migration.**

(A) *In vitro* Transwell Migration of murine WT or Rac2 KO SKL cells.  $1 \times 10^6$  Lineage<sup>neg</sup> cells were treated with vehicle or 1 $\mu$ M dmPGE<sub>2</sub> for 16 hours at 37°C. Cells were assayed for the ability to migrate to 100ng/mL rmSDF-1 for 4 hours at 37°C. Data are expressed as mean  $\pm$  SEM, N=3. (B) CXCR4 expression (Mean  $\pm$  SEM; N=3) on WT or Rac2 KO SKL cells 24 hours after treatment with dmPGE<sub>2</sub>. CXCR4 cell surface expression was measured as mean fluorescence intensity (MFI) based on isotype control. Data are expressed as percent change in MFI of CXCR4 over vehicle. \*p<0.05.

## Discussion

We now provide compelling evidence that the small GTPase Rac1 is involved in facilitating HSC motility and enhanced migration after dmPGE<sub>2</sub> treatment. Not only does loss of Rac1 abolish PGE<sub>2</sub>-enhanced CXCR4 upregulation, but also the ability of PGE<sub>2</sub> to enhance migration to SDF-1. Recently, it was discovered that Rac1 is required for regulation of CXCR4 conformation and activation, and loss of Rac1 expression and activity resulted in blocked receptor internalization and impaired SDF-1 induced G $\alpha$ i protein activation (Zoughlami, 2012). Our results using Rac1 KO mice validate the concept that Rac1 is necessary for modulation and activation of CXCR4, specifically after PGE<sub>2</sub> treatment. Furthermore, our findings support other published data suggesting that Rac1 is more important for HSC homing than Rac2 by showing that PGE<sub>2</sub>-enhanced CXCR4 upregulation and migration is maintained in Rac2 KO cells.

Interestingly, we also provide evidence that dmPGE<sub>2</sub> treatment enhances Rac1: CXCR4 colocalization within the cell membrane. Since homing is a relatively rapid event (within 48 hours of transplant) (Lapidot et al., 2005), it will be necessary to determine whether this colocalization event is more important early within the temporal span of the homing process. It has been suggested that the Rac1: CXCR4 colocalization event is necessary for enhanced sensitivity to SDF-1 (Wysoczynski et al., 2005). On the other hand, Rac1 is necessary for HIF1 $\alpha$  activity, which we have shown is necessary for CXCR4 upregulation after PGE<sub>2</sub> treatment. Since PGE<sub>2</sub>'s effect on CXCR4 is transcriptional in nature and thus the upregulation effect is seen at a later time point, it is possible that early colocalization of Rac1 and CXCR4 already present on the cells

facilitates initial directional movement towards the bone marrow; the concomitant stabilization of HIF1 $\alpha$  increases CXCR4 expression and allows the cells to be retained in the bone marrow once they arrive within the niche. Further dissection of the temporal events involving Rac1, HIF1 $\alpha$  and CXCR4 will be necessary to form a more clear timeline of events , and these studies will be discussed within the Future Directions chapter.

## Chapter 4. Future Directions

### DMOG in HSC transplants

Studies presented in this dissertation represent the first demonstration of enhanced homing and engraftment of HSCs resulting from *ex vivo* pulse-exposure of the hypoxia mimetic DMOG. Interestingly, we did not observe HSC engraftment equivalent to  $\text{dmPGE}_2$  treatment. This suggests that DMOG and HIF1 $\alpha$  stabilization may only be partially responsible for a portion of  $\text{PGE}_2$ 's effects on HSC function, mainly working through upregulation of CXCR4 expression and enhanced homing of HSCs, and not through increased cell cycling and proliferation (Figure 22). Based on Takubo's observation that increased HIF1 $\alpha$  stabilization increases HSCs quiescence, it makes sense that increased HIF1 $\alpha$  stabilization by DMOG would not result in more cell proliferation. So while *ex vivo* treatment of DMOG alone may not represent a more effective method for enhancing HSC function in transplant, it may remain an option in certain circumstances. For example, it has already been well established that the opposing effects of EP receptors can lead to differential signaling within cells, and that the expression and availability of the receptors can also affect signaling outcomes (Hull et al., 2004). Additionally, it has been shown in certain cases such as disease states and trauma, that cells can display decreases sensitivities to  $\text{PGE}_2$  (Santarpia et al., 1993; Laudanski et al., 2004; Huang et al., 2010). DMOG may present an alternative treatment option to  $\text{PGE}_2$  in cases of decreased  $\text{PGE}_2$  sensitivity or aberrant EP receptor function and expression.

Figure 22

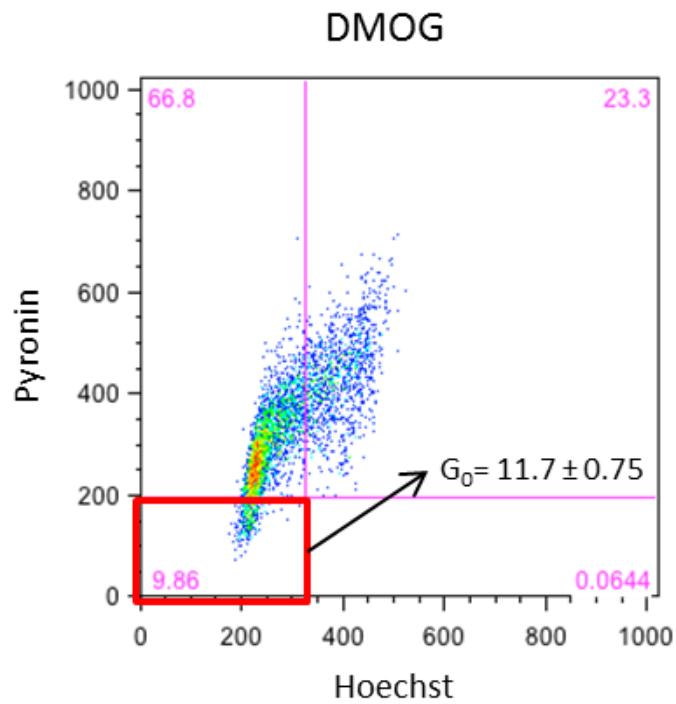
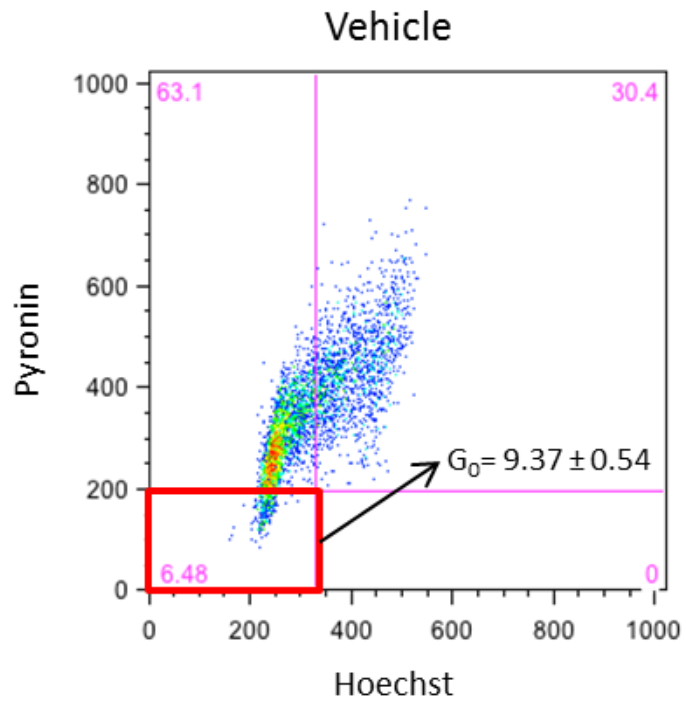

**Figure 22. Cell cycle analysis in SKL after DMOG treatment.**

Representative FACS cell cycle analysis in SKL cells. Lineage<sup>neg</sup> bone marrow cells were pulsed for 2 hours with either vehicle or 5uM DMOG. Twenty-four hours later, cells were stained with Hoechst and Pyronin-γ dyes and cell cycle was analyzed in SKL populations. The proportion of quiescent cells (cells in G<sub>0</sub>) was determined by gating on Hoechst<sup>neg</sup> and Pyronin<sup>neg</sup> populations. Data are expressed as mean ± SEM from three experiments.

In addition to DMOG's potential *ex vivo* role in HSC transplants in certain cases, daily *in vivo* treatment with DMOG prior to severe sublethal irradiation increases blood recovery and protects HSCs after radiation exposure (Forristal et al., 2013). We have shown similar radiomitigative effects with *in vivo* PGE<sub>2</sub> treatment post-irradiation (Hoggatt et al., 2013b), and *in vivo* treatment with Cobalt (II) Chloride (CoCl<sub>2</sub>), another hypoxia mimetic, results in higher colony-forming cells (CFCs) post-irradiation analogous to PGE<sub>2</sub> treatment (Hoggatt & Pelus, unpublished). Initial blood recovery after transplant is necessary for patient recovery and resistance to infection, therefore DMOG may be a potential therapeutic tool to not only enhance HSC donor cell function, but also to facilitate a speedier recipient recovery after irradiation and transplant (Figure 23).



Figure 23

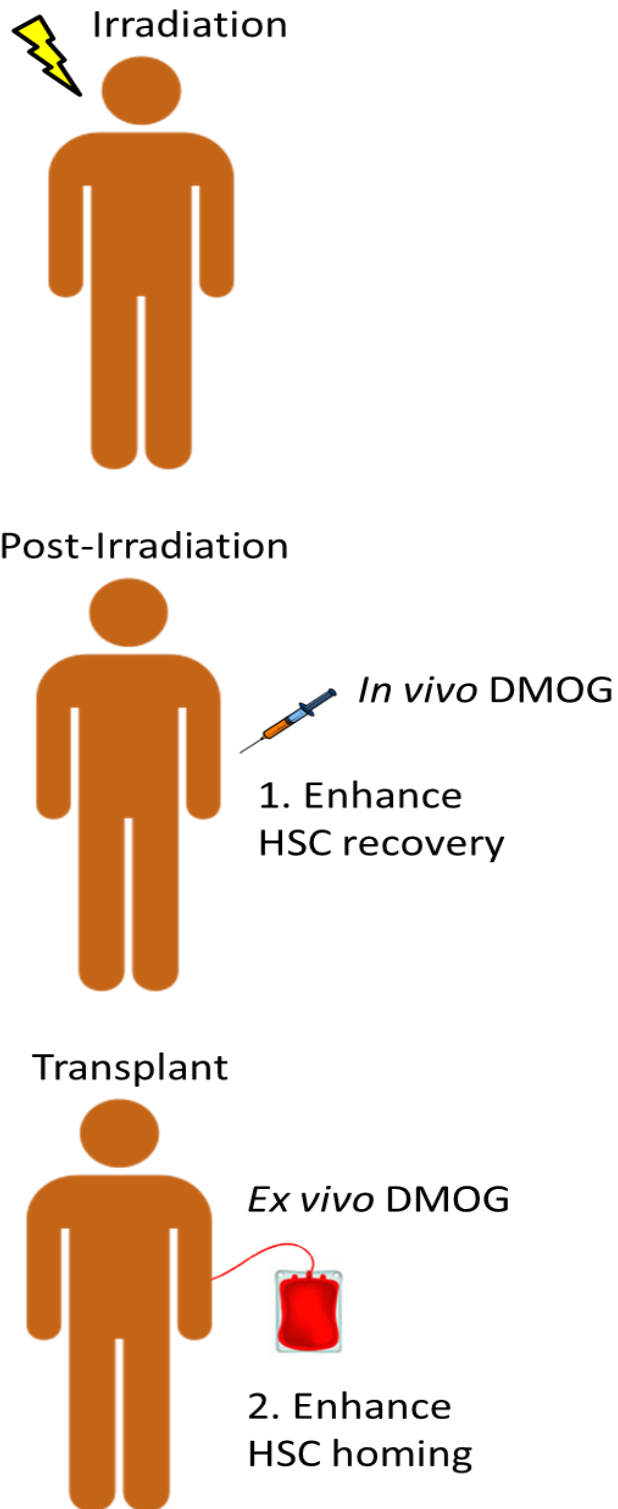

**Figure 23. DMOG in HSC Transplant.**

Based on recent evidence that DMOG enhances blood recovery after severe sub-lethal irradiation, our studies that show post-irradiation treatment with  $\text{CoCl}_2$  increases HSPCs, as well as the work presented in this dissertation suggesting DMOG enhances HSPC homing and engraftment, DMOG could potentially play a therapeutic role by enhancing both post-irradiation recovery and HSC function after transplant.

## Defining the EP receptor responsible for HIF1 $\alpha$ stabilization

While we have very comprehensively defined a mechanism in which HIF1 $\alpha$  is necessary for PGE<sub>2</sub>-enhanced HSC homing, the exact receptor through which this is occurring remains undetermined. Preliminary studies utilizing EP receptor KO mice indicate that both EP2 and EP4 may be involved. Loss of either receptor results in decreased HIF1 $\alpha$  stabilization in Lineage<sup>neg</sup> cells (Figure 24A), as well as lack of CXCR4 upregulation in SKL populations (Figure 24B). Recent evidence from our lab suggests a role for EP4 in retention of HSCs within the bone marrow (Hoggatt et al., 2013a). We show that blockade or loss of EP4 signaling in conjunction with other HSC mobilizing agents resulted in significantly enhanced egress of HSPCs from the bone marrow to the peripheral blood.

Therefore, based on the current knowledge that EP2 and EP4 both increase cAMP, this strongly indicates that cAMP signaling may be the mechanism through which PGE<sub>2</sub> affects HIF1 $\alpha$  stabilization. This could be tested by treating WT as well as EP2 and EP4 knockout cells with compounds that increase intracellular cAMP, such as  $\beta$ -agonists, synthetic nucleotides such as dbcAMP, or phosphodiesterase inhibitors. If increases in HIF1 $\alpha$  protein and CXCR4 expression are restored and similar to levels seen in PGE<sub>2</sub>-treated WT cells, it would suggest a requirement for cAMP in HIF1 $\alpha$  and CXCR4 regulation after PGE<sub>2</sub> treatment.

However, as was mentioned before, EP4 can signal through both cAMP as well as PI3K (Breyer et al., 2001; Tsuboi et al., 2002; Fujino et al., 2003; Hull et al., 2004; Sugimoto & Narumiya, 2007; Vo et al., 2013). Based on current literature, both

pathways can result in either Rac1 upregulation, or HIF1 $\alpha$  stabilization (Figure 25).

Future work should utilize the lab's individual EP2 and EP4 knockout mice and focus on the use of specific EP agonists, antagonists as well as PI3K and cAMP inhibitors to precisely determine which pathway is responsible for PGE<sub>2</sub>'s effects on Rac1, HIF1 $\alpha$  and CXCR4.

Figure 24

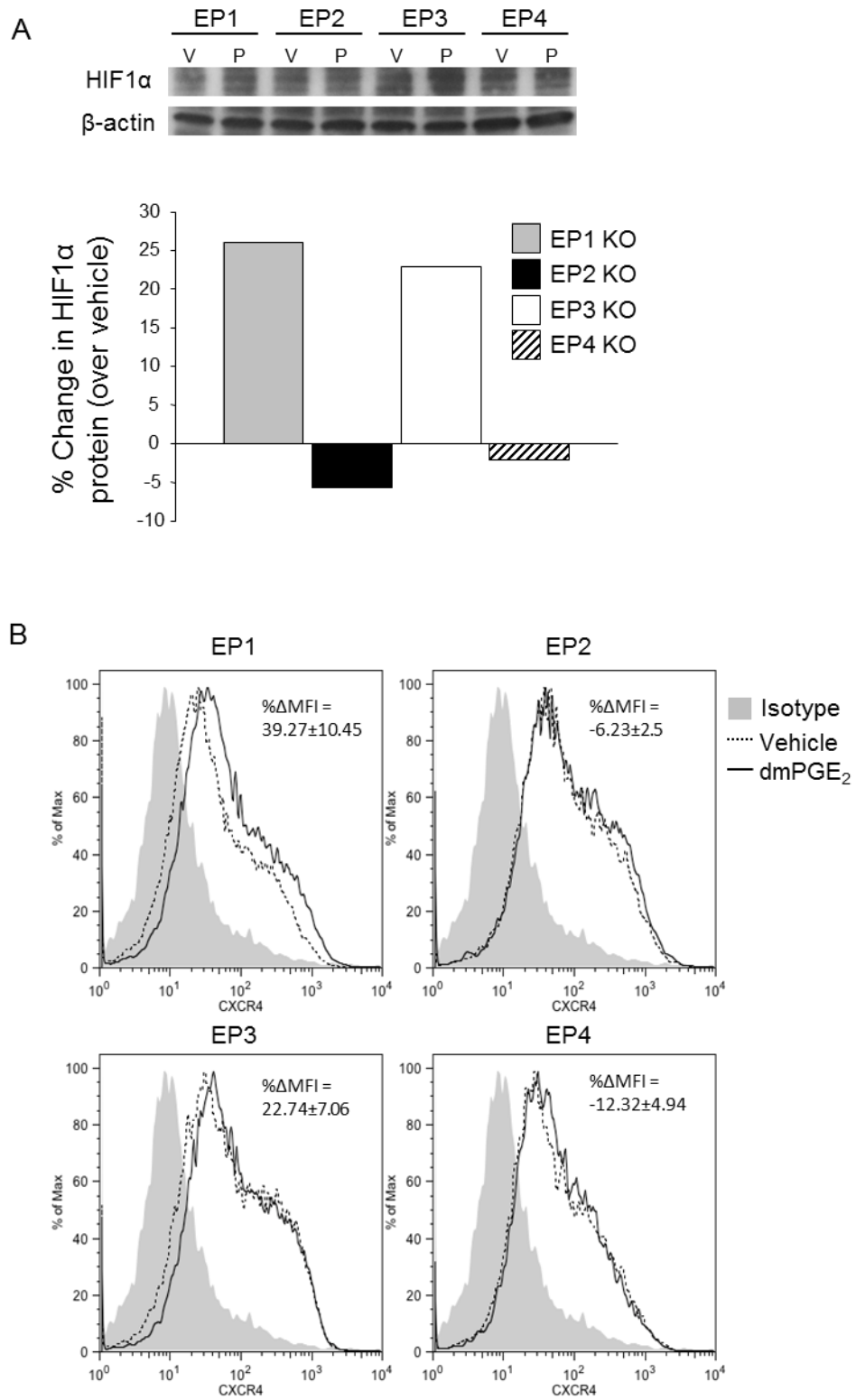

**Figure 24. EP2 and EP4 receptors are necessary for PGE<sub>2</sub>-induced HIF1 $\alpha$  stabilization and CXCR4 upregulation.**

(A) (Top) Representative western blot showing HIF1 $\alpha$  protein levels after dmPGE<sub>2</sub> treatment in EP KO mouse cells. (Bottom) Densitometry analysis of HIF1 $\alpha$  protein expression in mouse Lineage<sup>neg</sup> EP KO bone marrow cells treated with vehicle or 1 $\mu$ M dmPGE<sub>2</sub>. Data shown is from one experiment. (B) Representative FACS histograms showing CXCR4 expression after dmPGE<sub>2</sub> treatment on EP KO cells compared to isotype control. Within each histogram, CXCR4 expression (Mean  $\pm$  SEM; N=3) on EP KO SKL cells 24 hours after treatment with dmPGE<sub>2</sub> is shown. CXCR4 cell surface expression was measured as mean fluorescence intensity (MFI) based on isotype control. Data are expressed as percent change in MFI of CXCR4 over vehicle.

Figure 25

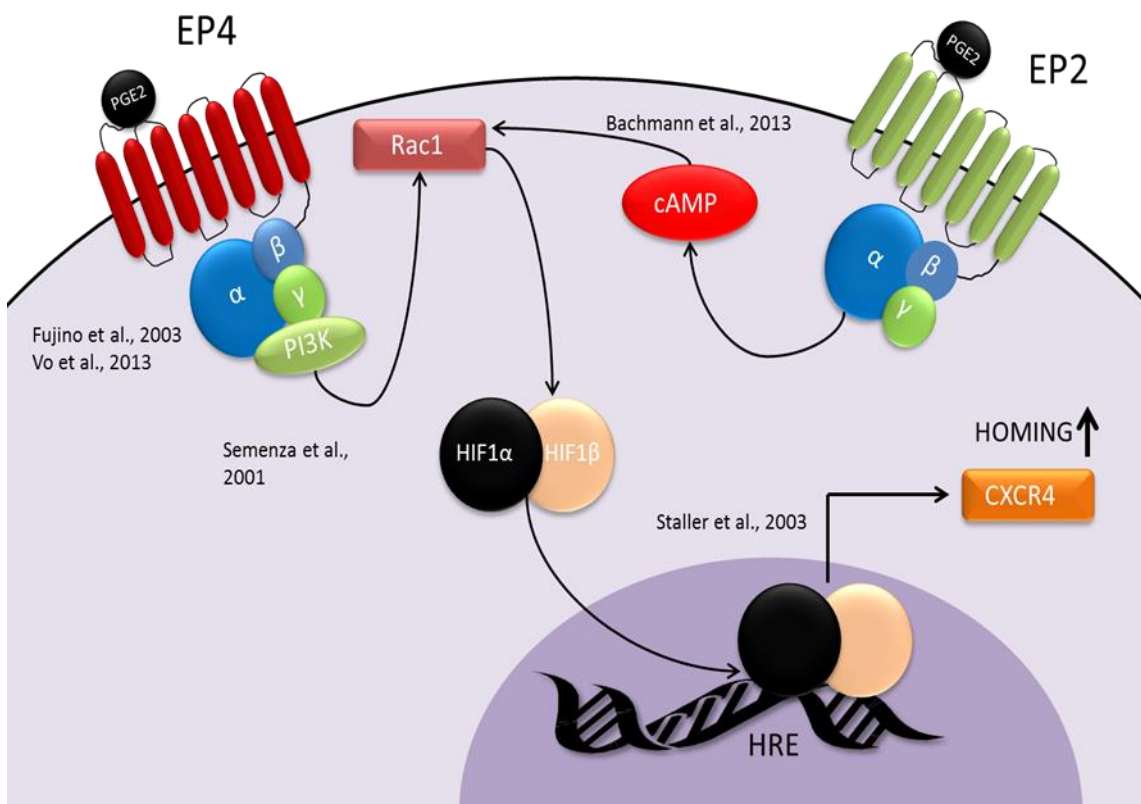

**Figure 25. Proposed mechanism(s) for PGE<sub>2</sub>'s effects on Rac1 and HIF1α.**

A schematic of potential signaling pathways that could affect Rac1 activity and localization, HIF1α and ultimately homing based on our evidence as well as current literature.



### **Digging deeper into Rac1's involvement in HSPC motility after PGE<sub>2</sub> treatment**

Our current observations involving PGE<sub>2</sub> and Rac1 suggest that increased colocalization of Rac1 and CXCR4 may enhance HSC migration to SDF-1 after PGE<sub>2</sub> treatment. Previous studies by others also suggest a role for Rac1 in HIF1 $\alpha$  activity (Hirota & Semenza, 2001). However, the kinetics of these interactions in regards to cell motility and homing are not very well defined. All of our prior studies involving HSPC migration and homing are done approximately 24 hours post-PGE<sub>2</sub> treatment, based on prior evidence that CXCR4 protein upregulation is at its greatest approximately 20 hours after exposure to PGE<sub>2</sub>. HIF1 $\alpha$  stabilization by PGE<sub>2</sub> occurs within 4-6 hours after treatment, supporting the theory that it is facilitating downstream transcriptional upregulation of CXCR4. It is not yet known whether Rac1 is involved early or late in this series of events. Preliminary studies reveal that in Rac1 KO HSPCs, overall HIF1 $\alpha$  protein stabilization is decreased compared to WT, and this stabilization remains the same after PGE<sub>2</sub> treatment (Figure 26), supporting the idea that Rac1 is necessary for HIF1 $\alpha$  stabilization and activity. This suggests that Rac1 is upstream of HIF1 $\alpha$  and explains the lack of CXCR4 upregulation in Rac1 KO cells after PGE<sub>2</sub> treatment. However it is still necessary to determine the kinetics of PGE<sub>2</sub>'s effects on Rac1 expression by performing timecourse experiments measuring Rac1 protein at 2, 6, 12 and 24 hours post-PGE<sub>2</sub> treatment. Furthermore, as was previously mentioned, it is possible that Rac1 and CXCR4 colocalization early on may initiate directional movement of cells immediately after transplant. ImageStream timecourse experiments at 2, 6 12 and 24 hours post-PGE<sub>2</sub> treatment may also be utilized to determine at which point Rac1 and CXCR4

colocalization is at its greatest. It would also be interesting to investigate whether DMOG treatment results in the same effects on Rac1 and CXCR4 colocalization. This would further define HIF1 $\alpha$ 's involvement in the steps necessary to enhance HSPC homing.

Additionally, despite the fact that Rac2 is not involved in PGE<sub>2</sub>-enhanced HSPC migration and CXCR4 upregulation, it is important to rule out its role in CXCR4 colocalization and altered SDF-1 sensitivity by performing additional colocalization experiments involving Rac2. It may also be beneficial to determine PGE<sub>2</sub>'s effects on overall Rac2 expression, due to Rac2's involvement in apoptosis and cell survival (Cancelas, 2011).

Figure 26

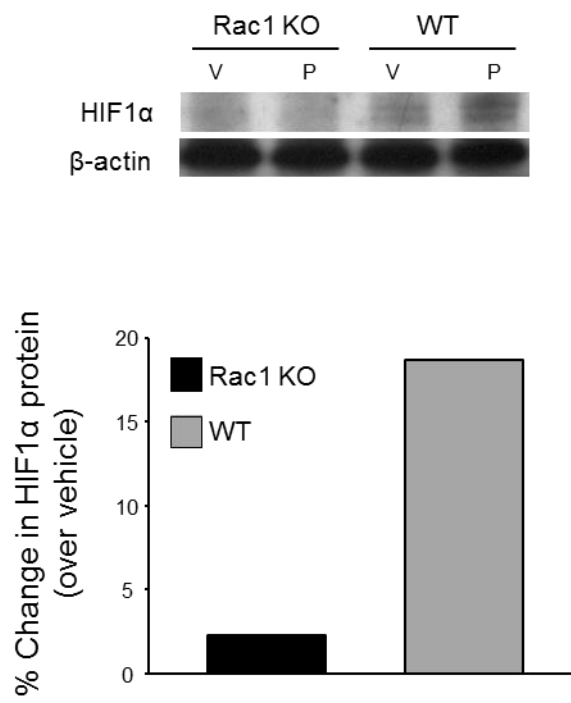

**Figure 26. Loss of Rac1 abolishes PGE<sub>2</sub>-enhanced HIF1 $\alpha$  stabilization.**

Representative western blot (Top) and densitometry analysis (Bottom) of HIF1 $\alpha$  protein in Rac1 KO and WT Lineage<sup>neg</sup> bone marrow cells after treatment with 1 $\mu$ M dmPGE<sub>2</sub>.

Data is from a single experiment.

## References

- Adelman, D. M., Maltepe, E., & Simon, M. C. (1999). Multilineage embryonic hematopoiesis requires hypoxic ARNT activity. *Genes Dev.*, *13*, 2478-2483.
- Akashi, K., Traver, D., Miyamoto, T., & Weissman, I. L. (2000). A clonogenic common myeloid progenitor that gives rise to all myeloid lineages. *Nature*, *404*, 193-197.
- Ananthkrishnan, R. & Ehrlicher, A. (2007). The forces behind cell movement. *Int.J.Biol Sci.*, *3*, 303-317.
- Andrews, R. G., Singer, J. W., & Bernstein, I. D. (1986). Monoclonal antibody 12-8 recognizes a 115-kd molecule present on both unipotent and multipotent hematopoietic colony-forming cells and their precursors. *Blood*, *67*, 842-845.
- Arai, F., Hirao, A., Ohmura, M., Sato, H., Matsuoka, S., Takubo, K. et al. (2004). Tie2/angiopoietin-1 signaling regulates hematopoietic stem cell quiescence in the bone marrow niche. *Cell*, *118*, 149-161.
- Asada, N., Katayama, Y., Sato, M., Minagawa, K., Wakahashi, K., Kawano, H. et al. (2013). Matrix-embedded osteocytes regulate mobilization of hematopoietic stem/progenitor cells. *Cell Stem Cell*, *12*, 737-747.
- Ash, R. C., Detrick, D. A., & Zanjani, E. D. (1981). Studies of human pluripotential hemopoietic stem cells (CFU-GEMM) in vitro. *Blood*, *58*, 309-316.

Asikainen, T. M., Ahmad, A., Schneider, B. K., Ho, W. B., Arend, M., Brenner, M. et al. (2005). Stimulation of HIF-1alpha, HIF-2alpha, and VEGF by prolyl 4-hydroxylase inhibition in human lung endothelial and epithelial cells. *Free Radic.Biol.Med.*, *38*, 1002-1013.

Bachmann, V. A., Riml, A., Huber, R. G., Baillie, G. S., Liedl, K. R., Valovka, T. et al. (2013). Reciprocal regulation of PKA and Rac signaling. *Proc.Natl.Acad.Sci.U.S.A*, *110*, 8531-8536.

Bai, H., Ge, S., Lu, J., Qian, G., & Xu, R. (2013). Hypoxia inducible factor-1alpha-mediated activation of survivin in cervical cancer cells. *J.Obstet.Gynaecol.Res.*, *39*, 555-563.

Bailly, M., Condeelis, J. S., & Segall, J. E. (1998). Chemoattractant-induced lamellipod extension. *Microsc.Res.Tech.*, *43*, 433-443.

Becker, A. J., McCulloch, E. A., & Till, J. E. (1963). Cytological demonstration of the clonal nature of spleen colonies derived from transplanted mouse marrow cells. *Nature*, *197*, 452-454.

Benveniste, P., Frelin, C., Janmohamed, S., Barbara, M., Herrington, R., Hyam, D. et al. (2010). Intermediate-term hematopoietic stem cells with extended but time-limited reconstitution potential. *Cell Stem Cell*, *6*, 48-58.

Bonewald, L. F. (2011). The amazing osteocyte. *J.Bone Miner.Res.*, *26*, 229-238.

Bradley, T. R. & Metcalf, D. (1966). The growth of mouse bone marrow cells in vitro. *Aust.J.Exp Biol Med Sci.*, *44*, 287-299.

Brenner, S., Whiting-Theobald, N., Kawai, T., Linton, G. F., Rudikoff, A. G., Choi, U. et al. (2004). CXCR4-transgene expression significantly improves marrow engraftment of cultured hematopoietic stem cells. *Stem Cells*, 22, 1128-1133.

Breyer, R. M., Bagdassarian, C. K., Myers, S. A., & Breyer, M. D. (2001). Prostanoid receptors: subtypes and signaling. *Annu.Rev.Pharmacol.Toxicol.*, 41, 661-690.

Broxmeyer, H. E. (2012). Enhancing engraftment of cord blood cells via insight into the biology of stem/progenitor cell function. *Ann.N.Y.Acad.Sci.*, 1266, 151-160.

Broxmeyer, H. E., Douglas, G. W., Hangoc, G., Cooper, S., Bard, J., English, D. et al. (1989). Human umbilical cord blood as a potential source of transplantable hematopoietic stem/progenitor cells. *Proc Natl.Acad.Sci.U.S.A*, 86, 3828-3832.

Broxmeyer, H. E., Hangoc, G., Cooper, S., Campbell, T., Ito, S., & Mantel, C. (2007). AMD3100 and CD26 modulate mobilization, engraftment, and survival of hematopoietic stem and progenitor cells mediated by the SDF-1/CXCL12-CXCR4 axis. *Ann.N.Y.Acad.Sci.*, 1106, 1-19.

Broxmeyer, H. E., Kohli, L., Kim, C. H., Lee, Y., Mantel, C., Cooper, S. et al. (2003). Stromal cell-derived factor-1/CXCL12 directly enhances survival/antiapoptosis of myeloid progenitor cells through CXCR4 and G(alpha)i proteins and enhances engraftment of competitive, repopulating stem cells. *J.Leukoc.Biol.*, 73, 630-638.

Broxmeyer, H. E., Orschell, C. M., Clapp, D. W., Hangoc, G., Cooper, S., Plett, P. A. et al. (2005). Rapid mobilization of murine and human hematopoietic stem and progenitor cells with AMD3100, a CXCR4 antagonist. *J.Exp.Med.*, 201, 1307-1318.

Broxmeyer, H. E., Srour, E., Orschell, C., Ingram, D. A., Cooper, S., Plett, P. A. et al. (2006). Cord blood stem and progenitor cells. *Methods Enzymol.*, 419, 439-473.

Butler, J. M., Nolan, D. J., Vertes, E. L., Varnum-Finney, B., Kobayashi, H., Hooper, A. T. et al. (2010). Endothelial cells are essential for the self-renewal and repopulation of Notch-dependent hematopoietic stem cells. *Cell Stem Cell*, 6, 251-264.

Calvi, L. M., Adams, G. B., Weibrecht, K. W., Weber, J. M., Olson, D. P., Knight, M. C. et al. (2003). Osteoblastic cells regulate the haematopoietic stem cell niche. *Nature*, 425, 841-846.

Cancelas, J. A. (2011). On how Rac controls hematopoietic stem cell activity. *Transfusion*, 51 Suppl 4, 153S-159S.

Cancelas, J. A., Jansen, M., & Williams, D. A. (2006). The role of chemokine activation of Rac GTPases in hematopoietic stem cell marrow homing, retention, and peripheral mobilization. *Exp.Hematol.*, 34, 976-985.

Cancelas, J. A., Lee, A. W., Prabhakar, R., Stringer, K. F., Zheng, Y., & Williams, D. A. (2005). Rac GTPases differentially integrate signals regulating hematopoietic stem cell localization. *Nat.Med.*, 11, 886-891.

Carow, C. E., Hangoc, G., Cooper, S. H., Williams, D. E., & Broxmeyer, H. E. (1991). Mast cell growth factor (c-kit ligand) supports the growth of human multipotential progenitor cells with a high replating potential. *Blood*, 78, 2216-2221.



Chen, J., Ellison, F. M., Keyvanfar, K., Omokaro, S. O., Desierto, M. J., Eckhaus, M. A. et al. (2008). Enrichment of hematopoietic stem cells with SLAM and LSK markers for the detection of hematopoietic stem cell function in normal and Trp53 null mice. *Exp.Hematol.*, *36*, 1236-1243.

Chen, Q. R., Miyaura, C., Higashi, S., Murakami, M., Kudo, I., Saito, S. et al. (1997). Activation of cytosolic phospholipase A2 by platelet-derived growth factor is essential for cyclooxygenase-2-dependent prostaglandin E2 synthesis in mouse osteoblasts cultured with interleukin-1. *J.Biol Chem.*, *272*, 5952-5958.

Choi, K., Kennedy, M., Kazarov, A., Papadimitriou, J. C., & Keller, G. (1998). A common precursor for hematopoietic and endothelial cells. *Development*, *125*, 725-732.

Ciraci, E., Della, B. S., Salvucci, O., Rofani, C., Segarra, M., Bason, C. et al. (2011). Adult human circulating CD34(-)Lin(-)CD45(-)CD133(-) cells can differentiate into hematopoietic and endothelial cells. *Blood*, *118*, 2105-2115.

Civin, C. I., Strauss, L. C., Brovall, C., Fackler, M. J., Schwartz, J. F., & Shaper, J. H. (1984). Antigenic analysis of hematopoiesis. III. A hematopoietic progenitor cell surface antigen defined by a monoclonal antibody raised against KG-1a cells. *J.Immunol.*, *133*, 157-165.

Coceani, F., Bishai, I., Lees, J., & Sirko, S. (1989). Prostaglandin E2 in the pathogenesis of pyrogen fever: validation of an intermediary role. *Adv.Prostaglandin Thromboxane Leukot.Res.*, *19*, 394-397.

Condeelis, J. S., Wyckoff, J. B., Bailly, M., Pestell, R., Lawrence, D., Backer, J. et al. (2001). Lamellipodia in invasion. *Semin.Cancer Biol*, *11*, 119-128.

Cooper, M. C., Levy, J., Cantor, L. N., Marks, P. A., & Rifkind, R. A. (1974). The effect of erythropoietin on colonial growth of erythroid precursor cells in vitro. *Proc Natl.Acad.Sci.U.S.A*, 71, 1677-1680.

Corselli, M., Chin, C. J., Parekh, C., Sahaghian, A., Wang, W., Ge, S. et al. (2013). Perivascular support of human hematopoietic stem/progenitor cells. *Blood*, 121, 2891-2901.

El-Badri, N. S., Wang, B. Y., Cherry, & Good, R. A. (1998). Osteoblasts promote engraftment of allogeneic hematopoietic stem cells. *Exp.Hematol.*, 26, 110-116.

Eliasson, P., Rehn, M., Hammar, P., Larsson, P., Sirenko, O., Flippin, L. A. et al. (2010). Hypoxia mediates low cell-cycle activity and increases the proportion of long-term-reconstituting hematopoietic stem cells during in vitro culture. *Exp.Hematol.*, 38, 301-310.

Ema, M., Taya, S., Yokotani, N., Sogawa, K., Matsuda, Y., & Fujii-Kuriyama, Y. (1997). A novel bHLH-PAS factor with close sequence similarity to hypoxia-inducible factor 1alpha regulates the VEGF expression and is potentially involved in lung and vascular development. *Proc Natl.Acad.Sci.U.S.A*, 94, 4273-4278.

Fauser, A. A. & Messner, H. A. (1978). Granuloerythropoietic colonies in human bone marrow, peripheral blood, and cord blood. *Blood*, 52, 1243-1248.

Fauser, A. A. & Messner, H. A. (1979). Identification of megakaryocytes, macrophages, and eosinophils in colonies of human bone marrow containing neutrophilic granulocytes and erythroblasts. *Blood*, 53, 1023-1027.

Fernandez-Martinez, A. B., Jimenez, M. I., Manzano, V. M., & Lucio-Cazana, F. J. (2012). Intracrine prostaglandin E(2) signalling regulates hypoxia-inducible factor-1alpha expression through retinoic acid receptor-beta. *Int.J.Biochem.Cell Biol.*, *44*, 2185-2193.

Filippi, M. D., Harris, C. E., Meller, J., Gu, Y., Zheng, Y., & Williams, D. A. (2004). Localization of Rac2 via the C terminus and aspartic acid 150 specifies superoxide generation, actin polarity and chemotaxis in neutrophils. *Nat.Immunol.*, *5*, 744-751.

Folco, G. & Murphy, R. C. (2006). Eicosanoid transcellular biosynthesis: from cell-cell interactions to in vivo tissue responses. *Pharmacol.Rev.*, *58*, 375-388.

Forristal, C. E., Winkler, I. G., Nowlan, B., Barbier, V., Walkinshaw, G., & Levesque, J. P. (2013). Pharmacologic stabilization of HIF-1alpha increases hematopoietic stem cell quiescence in vivo and accelerates blood recovery after severe irradiation. *Blood*, *121*, 759-769.

Fruehauf, S. & Seggewiss, R. (2003). It's moving day: factors affecting peripheral blood stem cell mobilization and strategies for improvement [corrected]. *Br.J.Haematol.*, *122*, 360-375.

Fujino, H., Xu, W., & Regan, J. W. (2003). Prostaglandin E2 induced functional expression of early growth response factor-1 by EP4, but not EP2, prostanoid receptors via the phosphatidylinositol 3-kinase and extracellular signal-regulated kinases. *J.Biol Chem.*, *278*, 12151-12156.

Fukata, M., Nakagawa, M., & Kaibuchi, K. (2003). Roles of Rho-family GTPases in cell polarisation and directional migration. *Curr.Opin.Cell Biol*, *15*, 590-597.

Fukuda, S., Broxmeyer, H. E., & Pelus, L. M. (2005). Flt3 ligand and the Flt3 receptor regulate hematopoietic cell migration by modulating the SDF-1 $\alpha$ (CXCL12)/CXCR4 axis. *Blood*, *105*, 3117-3126.

Fukuda, S. & Pelus, L. M. (2008). Transmigration of human CD34+ cells. *Methods Mol.Biol.*, *430*, 55-75.

Galy, A., Travis, M., Cen, D., & Chen, B. (1995). Human T, B, natural killer, and dendritic cells arise from a common bone marrow progenitor cell subset. *Immunity.*, *3*, 459-473.

Gentile, P., Byer, D., & Pelus, L. M. (1983). In vivo modulation of murine myelopoiesis following intravenous administration of prostaglandin E2. *Blood*, *62*, 1100-1107.

Gentile, P. S. & Pelus, L. M. (1987). In vivo modulation of myelopoiesis by prostaglandin E2. II. Inhibition of granulocyte-monocyte progenitor cell (CFU-GM) cell-cycle rate. *Exp.Hematol.*, *15*, 119-126.

Gentile, P. S. & Pelus, L. M. (1988). In vivo modulation of myelopoiesis by prostaglandin E2. IV. Prostaglandin E2 induction of myelopoietic inhibitory activity. *J.Immunol.*, *141*, 2714-2720.

Gluckman, E. (2011). Milestones in umbilical cord blood transplantation. *Blood Rev.*, *25*, 255-259.

Goessling, W., North, T. E., Loewer, S., Lord, A. M., Lee, S., Stoick-Cooper, C. L. et al. (2009). Genetic interaction of PGE2 and Wnt signaling regulates developmental specification of stem cells and regeneration. *Cell*, *136*, 1136-1147.

Goldman, J. M. & Horowitz, M. M. (2002). The international bone marrow transplant registry. *Int.J.Hematol.*, 76 Suppl 1, 393-397.

Goodell, M. A., Brose, K., Paradis, G., Conner, A. S., & Mulligan, R. C. (1996). Isolation and functional properties of murine hematopoietic stem cells that are replicating in vivo. *J.Exp Med*, 183, 1797-1806.

Grassinger, J., Haylock, D. N., Storan, M. J., Haines, G. O., Williams, B., Whitty, G. A. et al. (2009). Thrombin-cleaved osteopontin regulates hemopoietic stem and progenitor cell functions through interactions with alpha9beta1 and alpha4beta1 integrins. *Blood*, 114, 49-59.

Gu, Y., Filippi, M. D., Cancelas, J. A., Siefring, J. E., Williams, E. P., Jasti, A. C. et al. (2003). Hematopoietic cell regulation by Rac1 and Rac2 guanosine triphosphatases. *Science*, 302, 445-449.

Hall, A. (1998). Rho GTPases and the actin cytoskeleton. *Science*, 279, 509-514.

Hall, K. M., Horvath, T. L., Abonour, R., Cornetta, K., & Srour, E. F. (2006). Decreased homing of retrovirally transduced human bone marrow CD34+ cells in the NOD/SCID mouse model. *Exp.Hematol.*, 34, 433-442.

Harrison, D. E. (1972). Lifesparing ability (in lethally irradiated mice) of W-W mouse marrow with no macroscopic colonies. *Radiat.Res.*, 52, 553-563.

Harrison, D. E. (1980). Competitive repopulation: a new assay for long-term stem cell functional capacity. *Blood*, 55, 77-81.

Harrison, D. E. (1993). Competitive repopulation in unirradiated normal recipients. *Blood*, 81, 2473-2474.

Harrison, J. S., Rameshwar, P., Chang, V., & Bandari, P. (2002). Oxygen saturation in the bone marrow of healthy volunteers. *Blood*, *99*, 394.

Hess, D. A., Wirthlin, L., Craft, T. P., Herrbrich, P. E., Hohm, S. A., Lahey, R. et al. (2006). Selection based on CD133 and high aldehyde dehydrogenase activity isolates long-term reconstituting human hematopoietic stem cells. *Blood*, *107*, 2162-2169.

Hinson, R. M., Williams, J. A., & Shacter, E. (1996). Elevated interleukin 6 is induced by prostaglandin E2 in a murine model of inflammation: possible role of cyclooxygenase-2. *Proc.Natl.Acad.Sci.U.S.A*, *93*, 4885-4890.

Hirota, K. & Semenza, G. L. (2001). Rac1 activity is required for the activation of hypoxia-inducible factor 1. *J.Biol Chem.*, *276*, 21166-21172.

Hoggatt, J., Mohammad, K. S., Singh, P., Hoggatt, A. F., Chitteti, B. R., Speth, J. M. et al. (2013a). Differential stem- and progenitor-cell trafficking by prostaglandin E2. *Nature*, *495*, 365-369.

Hoggatt, J., Singh, P., Sampath, J., & Pelus, L. M. (2009). Prostaglandin E2 enhances hematopoietic stem cell homing, survival, and proliferation. *Blood*, *113*, 5444-5455.

Hoggatt, J., Singh, P., Stilger, K. N., Plett, P. A., Sampson, C. H., Chua, H. L. et al. (2013b). Recovery from hematopoietic injury by modulating prostaglandin E(2) signaling post-irradiation. *Blood Cells Mol.Dis.*, *50*, 147-153.

Hooper, A. T., Butler, J. M., Nolan, D. J., Kranz, A., Iida, K., Kobayashi, M. et al. (2009). Engraftment and reconstitution of hematopoiesis is dependent on VEGFR2-mediated regeneration of sinusoidal endothelial cells. *Cell Stem Cell*, *4*, 263-274.

Hu, C. J., Wang, L. Y., Chodosh, L. A., Keith, B., & Simon, M. C. (2003). Differential roles of hypoxia-inducible factor 1alpha (HIF-1alpha) and HIF-2alpha in hypoxic gene regulation. *Mol. Cell Biol*, *23*, 9361-9374.

Huang, S. K., Fisher, A. S., Scruggs, A. M., White, E. S., Hogaboam, C. M., Richardson, B. C. et al. (2010). Hypermethylation of PTGER2 confers prostaglandin E2 resistance in fibrotic fibroblasts from humans and mice. *Am.J.Pathol.*, *177*, 2245-2255.

Hull, M. A., Ko, S. C., & Hawcroft, G. (2004). Prostaglandin EP receptors: targets for treatment and prevention of colorectal cancer? *Mol.Cancer Ther.*, *3*, 1031-1039.

Ichikawa, Y., Pluznik, D. H., & Sachs, L. (1966). In vitro control of the development of macrophage and granulocyte colonies. *Proc Natl.Acad.Sci.U.S.A*, *56*, 488-495.

Ikuta, K. & Weissman, I. L. (1992). Evidence that hematopoietic stem cells express mouse c-kit but do not depend on steel factor for their generation. *Proc.Natl.Acad.Sci.U.S.A*, *89*, 1502-1506.

Imtiyaz, H. Z., Williams, E. P., Hickey, M. M., Patel, S. A., Durham, A. C., Yuan, L. J. et al. (2010). Hypoxia-inducible factor 2alpha regulates macrophage function in mouse models of acute and tumor inflammation. *J.Clin.Invest*, *120*, 2699-2714.

Iscove, N. N. & Sieber, F. (1975). Erythroid progenitors in mouse bone marrow detected by macroscopic colony formation in culture. *Exp Hematol.*, *3*, 32-43.

Ishikawa, T., Nakashiro, K., Klosek, S. K., Goda, H., Hara, S., Uchida, D. et al. (2009). Hypoxia enhances CXCR4 expression by activating HIF-1 in oral squamous cell carcinoma. *Oncol.Rep.*, *21*, 707-712.

- Ivan, M., Kondo, K., Yang, H., Kim, W., Valiando, J., Ohh, M. et al. (2001). HIF $\alpha$  targeted for VHL-mediated destruction by proline hydroxylation: implications for O<sub>2</sub> sensing. *Science*, 292, 464-468.
- Ivanov, A. I. & Romanovsky, A. A. (2004). Prostaglandin E<sub>2</sub> as a mediator of fever: synthesis and catabolism. *Front Biosci.*, 9, 1977-1993.
- Jacobson, L. O., Simmons, E. L., & Bethard, W. F. (1950a). Studies on hematopoietic recovery from radiation injury. *J.Clin.Invest*, 29, 825.
- Jacobson, L. O., Simmons, E. L., MARKS, E. K., ROBSON, M. J., Bethard, W. F., & GASTON, E. O. (1950b). The role of the spleen in radiation injury and recovery. *J.Lab Clin.Med.*, 35, 746-770.
- Jang, Y. Y. & Sharkis, S. J. (2007). A low level of reactive oxygen species selects for primitive hematopoietic stem cells that may reside in the low-oxygenic niche. *Blood*, 110, 3056-3063.
- Jiang, B. H., Jiang, G., Zheng, J. Z., Lu, Z., Hunter, T., & Vogt, P. K. (2001). Phosphatidylinositol 3-kinase signaling controls levels of hypoxia-inducible factor 1. *Cell Growth Differ.*, 12, 363-369.
- Kahn, J., Byk, T., Jansson-Sjostrand, L., Petit, I., Shivtiel, S., Nagler, A. et al. (2004). Overexpression of CXCR4 on human CD34<sup>+</sup> progenitors increases their proliferation, migration, and NOD/SCID repopulation. *Blood*, 103, 2942-2949.
- Kaluz, S., Kaluzova, M., & Stanbridge, E. J. (2008). Regulation of gene expression by hypoxia: integration of the HIF-transduced hypoxic signal at the hypoxia-responsive element. *Clin.Chim.Acta*, 395, 6-13.



Kamura, T., Sato, S., Iwai, K., Czyzyk-Krzeska, M., Conaway, R. C., & Conaway, J. W. (2000). Activation of HIF1alpha ubiquitination by a reconstituted von Hippel-Lindau (VHL) tumor suppressor complex. *Proc.Natl.Acad.Sci.U.S.A*, 97, 10430-10435.

Katayama, Y., Battista, M., Kao, W. M., Hidalgo, A., Peired, A. J., Thomas, S. A. et al. (2006). Signals from the sympathetic nervous system regulate hematopoietic stem cell egress from bone marrow. *Cell*, 124, 407-421.

Kiel, M. J., Yilmaz, O. H., Iwashita, T., Yilmaz, O. H., Terhorst, C., & Morrison, S. J. (2005). SLAM family receptors distinguish hematopoietic stem and progenitor cells and reveal endothelial niches for stem cells. *Cell*, 121, 1109-1121.

Kim, C. H. & Broxmeyer, H. E. (1998). In vitro behavior of hematopoietic progenitor cells under the influence of chemoattractants: stromal cell-derived factor-1, steel factor, and the bone marrow environment. *Blood*, 91, 100-110.

Klein-Nulend, J., Semeins, C. M., Ajubi, N. E., Nijweide, P. J., & Burger, E. H. (1995). Pulsating fluid flow increases nitric oxide (NO) synthesis by osteocytes but not periosteal fibroblasts--correlation with prostaglandin upregulation. *Biochem.Biophys.Res.Comm.*, 217, 640-648.

Kollet, O., Spiegel, A., Peled, A., Petit, I., Byk, T., Hershkoviz, R. et al. (2001). Rapid and efficient homing of human CD34(+)CD38(-/low)CXCR4(+) stem and progenitor cells to the bone marrow and spleen of NOD/SCID and NOD/SCID/B2m(null) mice. *Blood*, 97, 3283-3291.

Kondo, M., Wagers, A. J., Manz, M. G., Prohaska, S. S., Scherer, D. C., Beilhack, G. F. et al. (2003). Biology of hematopoietic stem cells and progenitors: implications for clinical application. *Annu.Rev.Immunol.*, *21*, 759-806.

Kondo, M., Weissman, I. L., & Akashi, K. (1997). Identification of clonogenic common lymphoid progenitors in mouse bone marrow. *Cell*, *91*, 661-672.

Kubota, Y., Takubo, K., & Suda, T. (2008). Bone marrow long label-retaining cells reside in the sinusoidal hypoxic niche. *Biochem.Biophys.Res.Commun.*, *366*, 335-339.

Kurland, J. I., Broxmeyer, H. E., Pelus, L. M., Bockman, R. S., & Moore, M. A. (1978). Role for monocyte-macrophage-derived colony-stimulating factor and prostaglandin E in the positive and negative feedback control of myeloid stem cell proliferation. *Blood*, *52*, 388-407.

Kurtzberg, J. (2009). Update on umbilical cord blood transplantation. *Curr.Opin.Pediatr.*, *21*, 22-29.

Lapidot, T., Dar, A., & Kollet, O. (2005). How do stem cells find their way home? *Blood*, *106*, 1901-1910.

Laudanski, K., De, A., Brouxhon, S., Kyrkanides, S., & Miller-Graziano, C. (2004). Abnormal PGE(2) regulation of monocyte TNF-alpha levels in trauma patients parallels development of a more macrophage-like phenotype. *Shock*, *22*, 204-212.

Lazarus, M. (2006). The differential role of prostaglandin E2 receptors EP3 and EP4 in regulation of fever. *Mol.Nutr.Food Res.*, *50*, 451-455.

Lee, S. H., Kim, M. H., & Han, H. J. (2009). Arachidonic acid potentiates hypoxia-induced VEGF expression in mouse embryonic stem cells: involvement of Notch, Wnt, and HIF-1alpha. *Am.J.Physiol Cell Physiol*, 297, C207-C216.

Levesque, J. P., Leavesley, D. I., Niutta, S., Vadas, M., & Simmons, P. J. (1995). Cytokines increase human hemopoietic cell adhesiveness by activation of very late antigen (VLA)-4 and VLA-5 integrins. *J.Exp.Med.*, 181, 1805-1815.

Li, W., Chen, Y. Q., Shen, Y. B., Shu, H. M., Wang, X. J., Zhao, C. L. et al. (2013). HIF-1alpha knockdown by miRNA decreases survivin expression and inhibits A549 cell growth in vitro and in vivo. *Int.J.Mol.Med.*

Lin, K. K. & Goodell, M. A. (2006). Purification of hematopoietic stem cells using the side population. *Methods Enzymol.*, 420, 255-264.

Liu, P., Wen, M., Sun, L., & Hayashi, J. (1993). Activation of phospholipase A2 and stimulation of prostaglandin E2 production by transforming growth factor-alpha in rat thymic epithelial cells requires influx of calcium. *Biochem.J.*, 293 ( Pt 1), 109-113.

Liu, X. H., Kirschenbaum, A., Lu, M., Yao, S., Dosoretz, A., Holland, J. F. et al. (2002). Prostaglandin E2 induces hypoxia-inducible factor-1alpha stabilization and nuclear localization in a human prostate cancer cell line. *J.Biol.Chem.*, 277, 50081-50086.

Liu, Y., Cox, S. R., Morita, T., & Kourembanas, S. (1995). Hypoxia regulates vascular endothelial growth factor gene expression in endothelial cells. Identification of a 5' enhancer. *Circ.Res.*, 77, 638-643.

Lu, L., Pelus, L. M., & Broxmeyer, H. E. (1984). Modulation of the expression of HLA-DR (Ia) antigens and the proliferation of human erythroid (BFU-E) and multipotential (CFU-GEMM) progenitor cells by prostaglandin E. *Exp Hematol.*, *12*, 741-748.

Lu, L., Pelus, L. M., Broxmeyer, H. E., Moore, M. A., Wachter, M., Walker, D. et al. (1986). Enhancement of the proliferation of human marrow erythroid (BFU-E) progenitor cells by prostaglandin E requires the participation of OKT8-positive T lymphocytes and is associated with the density expression of major histocompatibility complex class II antigens on BFU-E. *Blood*, *68*, 126-133.

Madaule, P. & Axel, R. (1985). A novel ras-related gene family. *Cell*, *41*, 31-40.

Magnani, C. F., Tettamanti, S., Maltese, F., Turazzi, N., Biondi, A., & Biagi, E. (2013). Advanced targeted, cell and gene-therapy approaches for pediatric hematological malignancies: results and future perspectives. *Front Oncol.*, *3*, 106.

Manz, M. G., Miyamoto, T., Akashi, K., & Weissman, I. L. (2002). Prospective isolation of human clonogenic common myeloid progenitors. *Proc Natl.Acad.Sci.U.S.A.*, *99*, 11872-11877.

Matsuzaki, Y., Kinjo, K., Mulligan, R. C., & Okano, H. (2004). Unexpectedly efficient homing capacity of purified murine hematopoietic stem cells. *Immunity.*, *20*, 87-93.

Maxwell, P. H., Wiesener, M. S., Chang, G. W., Clifford, S. C., Vaux, E. C., Cockman, M. E. et al. (1999). The tumour suppressor protein VHL targets hypoxia-inducible factors for oxygen-dependent proteolysis. *Nature*, *399*, 271-275.

Medvinsky, A. & Dzierzak, E. (1996). Definitive hematopoiesis is autonomously initiated by the AGM region. *Cell*, *86*, 897-906.

Mendez-Ferrer, S., Michurina, T. V., Ferraro, F., Mazloom, A. R., Macarthur, B. D., Lira, S. A. et al. (2010). Mesenchymal and haematopoietic stem cells form a unique bone marrow niche. *Nature*, *466*, 829-834.

Miller, S. B. (2006). Prostaglandins in health and disease: an overview. *Semin.Arthritis Rheum.*, *36*, 37-49.

Miyaura, C., Inada, M., Matsumoto, C., Ohshiba, T., Uozumi, N., Shimizu, T. et al. (2003). An essential role of cytosolic phospholipase A2alpha in prostaglandin E2-mediated bone resorption associated with inflammation. *J.Exp Med*, *197*, 1303-1310.

Moore, M. A. & Metcalf, D. (1970). Ontogeny of the haemopoietic system: yolk sac origin of in vivo and in vitro colony forming cells in the developing mouse embryo. *Br.J.Haematol.*, *18*, 279-296.

Muller-Sieburg, C. E., Whitlock, C. A., & Weissman, I. L. (1986). Isolation of two early B lymphocyte progenitors from mouse marrow: a committed pre-pre-B cell and a clonogenic Thy-1-lo hematopoietic stem cell. *Cell*, *44*, 653-662.

Murakami, M. & Kudo, I. (2006). Prostaglandin E synthase: a novel drug target for inflammation and cancer. *Curr.Pharm.Des*, *12*, 943-954.

Nilsson, S. K., Johnston, H. M., Whitty, G. A., Williams, B., Webb, R. J., Denhardt, D. T. et al. (2005). Osteopontin, a key component of the hematopoietic stem cell niche and regulator of primitive hematopoietic progenitor cells. *Blood*, *106*, 1232-1239.

- Ogawa, M. (1993). Differentiation and proliferation of hematopoietic stem cells. *Blood*, *81*, 2844-2853.
- Ohh, M., Park, C. W., Ivan, M., Hoffman, M. A., Kim, T. Y., Huang, L. E. et al. (2000). Ubiquitination of hypoxia-inducible factor requires direct binding to the beta-domain of the von Hippel-Lindau protein. *Nat. Cell Biol*, *2*, 423-427.
- Osawa, M., Hanada, K., Hamada, H., & Nakauchi, H. (1996). Long-term lymphohematopoietic reconstitution by a single CD34-low/negative hematopoietic stem cell. *Science*, *273*, 242-245.
- Palayoor, S. T., Tofilon, P. J., & Coleman, C. N. (2003). Ibuprofen-mediated reduction of hypoxia-inducible factors HIF-1alpha and HIF-2alpha in prostate cancer cells. *Clin. Cancer Res.*, *9*, 3150-3157.
- Papayannopoulou, T. (2004). Current mechanistic scenarios in hematopoietic stem/progenitor cell mobilization. *Blood*, *103*, 1580-1585.
- Park, J. Y., Pillinger, M. H., & Abramson, S. B. (2006). Prostaglandin E2 synthesis and secretion: the role of PGE2 synthases. *Clin. Immunol.*, *119*, 229-240.
- Parmar, K., Mauch, P., Vergilio, J. A., Sackstein, R., & Down, J. D. (2007). Distribution of hematopoietic stem cells in the bone marrow according to regional hypoxia. *Proc Natl. Acad. Sci. U.S.A.*, *104*, 5431-5436.
- Peled, A., Kollet, O., Ponomaryov, T., Petit, I., Franitza, S., Grabovsky, V. et al. (2000). The chemokine SDF-1 activates the integrins LFA-1, VLA-4, and VLA-5 on immature human CD34(+) cells: role in transendothelial/stromal migration and engraftment of NOD/SCID mice. *Blood*, *95*, 3289-3296.

Peled, A., Petit, I., Kollet, O., Magid, M., Ponomaryov, T., Byk, T. et al. (1999). Dependence of human stem cell engraftment and repopulation of NOD/SCID mice on CXCR4. *Science*, 283, 845-848.

Pelus, L. M. (1982). Association between colony forming units-granulocyte macrophage expression of Ia-like (HLA-DR) antigen and control of granulocyte and macrophage production. A new role for prostaglandin E. *J.Clin.Invest*, 70, 568-578.

Pelus, L. M. (1989). Blockade of prostaglandin biosynthesis in intact mice dramatically augments the expansion of committed myeloid progenitor cells (colony-forming units-granulocyte, macrophage) after acute administration of recombinant human IL-1 alpha. *J.Immunol.*, 143, 4171-4179.

Pelus, L. M., Broxmeyer, H. E., Kurland, J. I., & Moore, M. A. (1979). Regulation of macrophage and granulocyte proliferation. Specificities of prostaglandin E and lactoferrin. *J.Exp.Med.*, 150, 277-292.

Pelus, L. M., Broxmeyer, H. E., & Moore, M. A. (1981). Regulation of human myelopoiesis by prostaglandin E and lactoferrin. *Cell Tissue Kinet.*, 14, 515-526.

Pelus, L. M., Saletan, S., Silver, R. T., & Moore, M. A. (1982). Expression of Ia-antigens on normal and chronic myeloid leukemic human granulocyte-macrophage colony-forming cells (CFU-GM) is associated with the regulation of cell proliferation by prostaglandin E. *Blood*, 59, 284-292.

Peng, X. H., Karna, P., Cao, Z., Jiang, B. H., Zhou, M., & Yang, L. (2006). Cross-talk between epidermal growth factor receptor and hypoxia-inducible factor-1 $\alpha$  signal pathways increases resistance to apoptosis by up-regulating survivin gene expression. *J.Biol.Chem.*, *281*, 25903-25914.

Phillips, P. G., Birnby, L. M., & Narendran, A. (1995). Hypoxia induces capillary network formation in cultured bovine pulmonary microvessel endothelial cells. *Am.J.Physiol*, *268*, L789-L800.

Phillips, R. J., Mestas, J., Gharaee-Kermani, M., Burdick, M. D., Sica, A., Belperio, J. A. et al. (2005). Epidermal growth factor and hypoxia-induced expression of CXC chemokine receptor 4 on non-small cell lung cancer cells is regulated by the phosphatidylinositol 3-kinase/PTEN/AKT/mammalian target of rapamycin signaling pathway and activation of hypoxia inducible factor-1 $\alpha$ . *J.Biol.Chem.*, *280*, 22473-22481.

Ploemacher, R. E., van der Sluijs, J. P., Voerman, J. S., & Brons, N. H. (1989). An in vitro limiting-dilution assay of long-term repopulating hematopoietic stem cells in the mouse. *Blood*, *74*, 2755-2763.

Ponomaryov, T., Peled, A., Petit, I., Taichman, R. S., Habler, L., Sandbank, J. et al. (2000). Induction of the chemokine stromal-derived factor-1 following DNA damage improves human stem cell function. *J.Clin.Invest*, *106*, 1331-1339.

Pore, N. & Maity, A. (2006). The chemokine receptor CXCR4: a homing device for hypoxic cancer cells? *Cancer Biol.Ther.*, *5*, 1563-1565.



Purton, L. E. & Scadden, D. T. (2007). Limiting factors in murine hematopoietic stem cell assays. *Cell Stem Cell*, *1*, 263-270.

Raisz, L. G., Vanderhoek, J. Y., Simmons, H. A., Kream, B. E., & Nicolaou, K. C. (1979). Prostaglandin synthesis by fetal rat bone in vitro: evidence for a role of prostacyclin. *Prostaglandins*, *17*, 905-914.

Rambach, W. A., Alt, H. L., & Cooper, J. A. (1954). Protective effect of hypoxia against irradiation injury of the rat bone marrow and spleen. *Proc Soc Exp Biol Med*, *86*, 159-161.

Ridley, A. J. & Hall, A. (1992a). Distinct patterns of actin organization regulated by the small GTP-binding proteins Rac and Rho. *Cold Spring Harb. Symp. Quant. Biol.*, *57*, 661-671.

Ridley, A. J. & Hall, A. (1992b). The small GTP-binding protein rho regulates the assembly of focal adhesions and actin stress fibers in response to growth factors. *Cell*, *70*, 389-399.

Ridley, A. J., Paterson, H. F., Johnston, C. L., Diekmann, D., & Hall, A. (1992). The small GTP-binding protein rac regulates growth factor-induced membrane ruffling. *Cell*, *70*, 401-410.

Ringden, O., Remberger, M., Runde, V., Bornhauser, M., Blau, I. W., Basara, N. et al. (2000). Faster engraftment of neutrophils and platelets with peripheral blood stem cells from unrelated donors: a comparison with marrow transplantation. *Bone Marrow Transplant.*, *25 Suppl 2*, S6-S8.

Rodesch, F., Simon, P., Donner, C., & Jauniaux, E. (1992). Oxygen measurements in endometrial and trophoblastic tissues during early pregnancy. *Obstet.Gynecol.*, *80*, 283-285.

Rossi, G. B., Migliaccio, A. R., Migliaccio, G., Lettieri, F., Di, R. M., Peschle, C. et al. (1980). In vitro interactions of PGE and cAMP with murine and human erythroid precursors. *Blood*, *56*, 74-79.

Roy, S., Tripathy, M., Mathur, N., Jain, A., & Mukhopadhyay, A. (2012). Hypoxia improves expansion potential of human cord blood-derived hematopoietic stem cells and marrow repopulation efficiency. *Eur.J.Haematol.*, *88*, 396-405.

Sabin, F. R. (1920). Studies on the origin of blood vessels and of red blood corpuscles as seen in the living blastoderm of chicks during the second day of incubation. *Contrib.Embryol*, *9*, 213-262.

Sahai, E. & Marshall, C. J. (2002). RHO-GTPases and cancer. *Nat.Rev.Cancer*, *2*, 133-142.

Salceda, S. & Caro, J. (1997). Hypoxia-inducible factor 1alpha (HIF-1alpha) protein is rapidly degraded by the ubiquitin-proteasome system under normoxic conditions. Its stabilization by hypoxia depends on redox-induced changes. *J.Biol.Chem.*, *272*, 22642-22647.

Samuelsson, B., Morgenstern, R., & Jakobsson, P. J. (2007). Membrane prostaglandin E synthase-1: a novel therapeutic target. *Pharmacol.Rev.*, *59*, 207-224.

Santarpia, G., Venza, M., Salmeri, F. M., Valenti, A., Sottile, A., & Teti, D. (1993). Impairment of lymphocyte sensitivity to prostaglandin E2 in cultures from patients with lymphadenopathy associated syndrome. *Ann.Clin.Lab Sci.*, 23, 350-357.

Schioppa, T., Uranchimeg, B., Sacconi, A., Biswas, S. K., Doni, A., Rapisarda, A. et al. (2003). Regulation of the chemokine receptor CXCR4 by hypoxia. *J.Exp.Med.*, 198, 1391-1402.

Schmidt, A. & Hall, A. (2002). Guanine nucleotide exchange factors for Rho GTPases: turning on the switch. *Genes Dev.*, 16, 1587-1609.

Schofield, R. (1978). The relationship between the spleen colony-forming cell and the haemopoietic stem cell. *Blood Cells*, 4, 7-25.

Schweizer, A., Feige, U., Fontana, A., Muller, K., & Dinarello, C. A. (1988). Interleukin-1 enhances pain reflexes. Mediation through increased prostaglandin E2 levels. *Agents Actions*, 25, 246-251.

Serhan, C. N. & Levy, B. (2003). Success of prostaglandin E2 in structure-function is a challenge for structure-based therapeutics. *Proc Natl.Acad.Sci.U.S.A*, 100, 8609-8611.

Shibata, Y. (1989). Humoral factors in the induction of prostaglandin E2-producing macrophages in vitro. *Reg Immunol.*, 2, 158-168.

Shinjo, K., Koland, J. G., Hart, M. J., Narasimhan, V., Johnson, D. I., Evans, T. et al. (1990). Molecular cloning of the gene for the human placental GTP-binding protein Gp (G25K): identification of this GTP-binding protein as the human homolog of the yeast cell-division-cycle protein CDC42. *Proc Natl.Acad.Sci.U.S.A*, 87, 9853-9857.

Siminovitch, L., McCulloch, E. A., & Till, J. E. (1963). The distribution of colony-forming cells among spleen colonies. *J.Cell Physiol*, *62*, 327-336.

Skuli, N., Majmundar, A. J., Krock, B. L., Mesquita, R. C., Mathew, L. K., Quinn, Z. L. et al. (2012). Endothelial HIF-2alpha regulates murine pathological angiogenesis and revascularization processes. *J.Clin.Invest*, *122*, 1427-1443.

Sogawa, K., Numayama-Tsuruta, K., Ema, M., Abe, M., Abe, H., & Fujii-Kuriyama, Y. (1998). Inhibition of hypoxia-inducible factor 1 activity by nitric oxide donors in hypoxia. *Proc.Natl.Acad.Sci.U.S.A*, *95*, 7368-7373.

Soki, F. N., Li, X., Berry, J., Koh, A., Sinder, B. P., Qian, X. et al. (2013). The effects of zoledronic acid in the bone and vasculature support of hematopoietic stem cell niches. *J.Cell Biochem.*, *114*, 67-78.

Spangrude, G. J., Heimfeld, S., & Weissman, I. L. (1988). Purification and characterization of mouse hematopoietic stem cells. *Science*, *241*, 58-62.

Staller, P., Sulitkova, J., Lisztwan, J., Moch, H., Oakeley, E. J., & Krek, W. (2003). Chemokine receptor CXCR4 downregulated by von Hippel-Lindau tumour suppressor pVHL. *Nature*, *425*, 307-311.

Stock, J. L., Shinjo, K., Burkhardt, J., Roach, M., Taniguchi, K., Ishikawa, T. et al. (2001). The prostaglandin E2 EP1 receptor mediates pain perception and regulates blood pressure. *J.Clin.Invest*, *107*, 325-331.

Sugimoto, Y. & Narumiya, S. (2007). Prostaglandin E receptors. *J.Biol Chem.*, *282*, 11613-11617.

Sugiyama, T., Kohara, H., Noda, M., & Nagasawa, T. (2006). Maintenance of the hematopoietic stem cell pool by CXCL12-CXCR4 chemokine signaling in bone marrow stromal cell niches. *Immunity*, 25, 977-988.

Sutherland, H. J., Lansdorp, P. M., Henkelman, D. H., Eaves, A. C., & Eaves, C. J. (1990). Functional characterization of individual human hematopoietic stem cells cultured at limiting dilution on supportive marrow stromal layers. *Proc.Natl.Acad.Sci.U.S.A*, 87, 3584-3588.

Szilvassy, S. J., Humphries, R. K., Lansdorp, P. M., Eaves, A. C., & Eaves, C. J. (1990). Quantitative assay for totipotent reconstituting hematopoietic stem cells by a competitive repopulation strategy. *Proc.Natl.Acad.Sci.U.S.A*, 87, 8736-8740.

Takubo, K., Goda, N., Yamada, W., Iriuchishima, H., Ikeda, E., Kubota, Y. et al. (2010). Regulation of the HIF-1alpha level is essential for hematopoietic stem cells. *Cell Stem Cell*, 7, 391-402.

Tanaka, Y., Hayashi, M., Kubota, Y., Nagai, H., Sheng, G., Nishikawa, S. et al. (2012). Early ontogenic origin of the hematopoietic stem cell lineage. *Proc.Natl.Acad.Sci.U.S.A*, 109, 4515-4520.

Tang, D. D. & Anfinogenova, Y. (2008). Physiologic properties and regulation of the actin cytoskeleton in vascular smooth muscle. *J.Cardiovasc.Pharmacol.Ther.*, 13, 130-140.

Tapon, N. & Hall, A. (1997). Rho, Rac and Cdc42 GTPases regulate the organization of the actin cytoskeleton. *Curr.Opin.Cell Biol.*, 9, 86-92.

- Terstappen, L. W., Huang, S., Safford, M., Lansdorp, P. M., & Loken, M. R. (1991). Sequential generations of hematopoietic colonies derived from single nonlineage-committed CD34+. *Blood*, *77*, 1218-1227.
- Till, J. E. & McCulloch, E. A. (1961). A direct measurement of the radiation sensitivity of normal mouse bone marrow cells. *Radiat.Res.*, *14*, 213-222.
- Tsuboi, K., Sugimoto, Y., & Ichikawa, A. (2002). Prostanoid receptor subtypes. *Prostaglandins Other Lipid Mediat.*, *68-69*, 535-556.
- Urade, Y., Watanabe, K., & Hayaishi, O. (1995). Prostaglandin D, E, and F synthases. *J.Lipid Mediat.Cell Signal.*, *12*, 257-273.
- Visnjic, D., Kalajzic, Z., Rowe, D. W., Katavic, V., Lorenzo, J., & Aguila, H. L. (2004). Hematopoiesis is severely altered in mice with an induced osteoblast deficiency. *Blood*, *103*, 3258-3264.
- Vo, B. T., Morton, D., Jr., Komaragiri, S., Millena, A. C., Leath, C., & Khan, S. A. (2013). TGF-beta effects on prostate cancer cell migration and invasion are mediated by PGE2 through activation of PI3K/AKT/mTOR pathway. *Endocrinology*, *154*, 1768-1779.
- Vos, O. (1972). Stem cell renewal in spleen and bone marrow of mice after repeated total-body irradiations. *Int.J.Radiat.Biol.Relat Stud.Phys.Chem.Med.*, *22*, 41-50.
- Vos, O. & Dolmans, M. J. (1972). Self-renewal of colony forming units (CFU) in serial bone marrow transplantation experiments. *Cell Tissue Kinet.*, *5*, 371-385.
- Walmsley, M. J., Ooi, S. K., Reynolds, L. F., Smith, S. H., Ruf, S., Mathiot, A. et al. (2003). Critical roles for Rac1 and Rac2 GTPases in B cell development and signaling. *Science*, *302*, 459-462.

Wang, G. L., Jiang, B. H., Rue, E. A., & Semenza, G. L. (1995). Hypoxia-inducible factor 1 is a basic-helix-loop-helix-PAS heterodimer regulated by cellular O<sub>2</sub> tension. *Proc Natl.Acad.Sci.U.S.A*, 92, 5510-5514.

Wang, G. L. & Semenza, G. L. (1993). Characterization of hypoxia-inducible factor 1 and regulation of DNA binding activity by hypoxia. *J.Biol Chem.*, 268, 21513-21518.

Wang, G. L. & Semenza, G. L. (1995). Purification and characterization of hypoxia-inducible factor 1. *J.Biol Chem.*, 270, 1230-1237.

Wang, X., Li, C., Chen, Y., Hao, Y., Zhou, W., Chen, C. et al. (2008). Hypoxia enhances CXCR4 expression favoring microglia migration via HIF-1 $\alpha$  activation. *Biochem.Biophys.Res.Comm.*, 371, 283-288.

Watson, A. J., Weir-Brown, K. I., Bannister, R. M., Chu, F. F., Reisz-Porszasz, S., Fujii-Kuriyama, Y. et al. (1992). Mechanism of action of a repressor of dioxin-dependent induction of Cyp1a1 gene transcription. *Mol.Cell Biol.*, 12, 2115-2123.

Wei, H., Wang, C., & Chen, L. (2006). Proliferating cell nuclear antigen, survivin, and CD34 expressions in pancreatic cancer and their correlation with hypoxia-inducible factor 1 $\alpha$ . *Pancreas*, 32, 159-163.

Weissman, I. L. & Shizuru, J. A. (2008). The origins of the identification and isolation of hematopoietic stem cells, and their capability to induce donor-specific transplantation tolerance and treat autoimmune diseases. *Blood*, 112, 3543-3553.

Williams, D. A., Zheng, Y., & Cancelas, J. A. (2008). Rho GTPases and regulation of hematopoietic stem cell localization. *Methods Enzymol.*, 439, 365-393.

Winkler, I. G., Barbier, V., Nowlan, B., Jacobsen, R. N., Forristal, C. E., Patton, J. T. et al. (2012). Vascular niche E-selectin regulates hematopoietic stem cell dormancy, self renewal and chemoresistance. *Nat.Med*, *18*, 1651-1657.

Wu, H. M., Lewis, J. P., Sky-Peck, H. H., & Trobaugh, F. E., Jr. (1968). Biochemical studies of spleens of heavily irradiated mice transfused with bone marrow. *Radiat.Res.*, *33*, 50-65.

Wysoczynski, M., Reza, R., Ratajczak, J., Kucia, M., Shirvaikar, N., Honczarenko, M. et al. (2005). Incorporation of CXCR4 into membrane lipid rafts primes homing-related responses of hematopoietic stem/progenitor cells to an SDF-1 gradient. *Blood*, *105*, 40-48.

Yang, F. C., Atkinson, S. J., Gu, Y., Borneo, J. B., Roberts, A. W., Zheng, Y. et al. (2001). Rac and Cdc42 GTPases control hematopoietic stem cell shape, adhesion, migration, and mobilization. *Proc Natl.Acad.Sci.U.S.A*, *98*, 5614-5618.

Yang, L., Cao, Z., Li, F., Post, D. E., Van Meir, E. G., Zhong, H. et al. (2004). Tumor-specific gene expression using the survivin promoter is further increased by hypoxia. *Gene Ther.*, *11*, 1215-1223.

Ylostalo, J. H., Bartosh, T. J., Coble, K., & Prockop, D. J. (2012). Human mesenchymal stem/stromal cells cultured as spheroids are self-activated to produce prostaglandin E2 that directs stimulated macrophages into an anti-inflammatory phenotype. *Stem Cells*, *30*, 2283-2296.

Yoder, M. C. & Williams, D. A. (1995). Matrix molecule interactions with hematopoietic stem cells. *Exp.Hematol.*, *23*, 961-967.



Zagzag, D., Lukyanov, Y., Lan, L., Ali, M. A., Esencay, M., Mendez, O. et al. (2006).

Hypoxia-inducible factor 1 and VEGF upregulate CXCR4 in glioblastoma: implications for angiogenesis and glioma cell invasion. *Lab Invest*, 86, 1221-1232.

# Curriculum Vitae

Jennifer M. Speth

## EDUCATION

2006	<b>B.S.</b> Microbiology Ball State University	Muncie, IN
2013	<b>Ph.D.</b> Department of Microbiology & Immunology Indiana University	Indianapolis, IN

## ACTIVITIES & AWARDS

- Fong-Clontech Award Committee Chair, *2012-2013*
- Harold Raidt Graduate Student Teaching Award, *June, 2012*
- American Society of Hematology Abstract Achievement Award for Oral Presentation, *December, 2011*
- Honorable Mention, IU Cancer Research Day Poster Presentation, *May, 2011*
- Appointed to NIH Gene Therapy Training Grant, *January 2009*
- Presidential Scholarship, *2002-2006*
- Cardinal Legacy Scholarship, *2002-2006*
- B. Retherford Clyde & Thelma Scholarship, *2002-2006*
- Honors Fellowship, *2005-2006*
- Newell C. Cook Jr. Award in Microbiology, *2005*
- American Cancer Society Scholarship, *2002*

## TEACHING EXPERIENCE

**Nursing Microbiology Lab Instructor**, IUPUI, Indianapolis, IN, *January 2011-May 2011*

- Led a microbiology lab section and taught basic microbiology, including laboratory skills and techniques.

## WORK EXPERIENCE

**Research Technician**, IUPUI Department of Pathology & Laboratory Medicine  
Indianapolis, IN, *June 2006-August 2008*

- Investigated the role of Signal Transducers and Activators of Transcription 3 (STAT3) in chronic lung inflammation and adenocarcinoma.

## PUBLICATIONS

**Speth JM**, Hoggatt J, Pelus LM. Pharmacologic Increase in HIF1 $\alpha$  Enhances Hematopoietic Stem and Progenitor Homing and Engraftment. *Blood*, submitted 2013.

Hoggatt J, **Speth JM**, Pelus LM. Sowing the seeds of a fruitful harvest: hematopoietic stem cell mobilization. *Stem Cells*, in press.

Hoggatt J, Khalid SM, Singh P, Hoggatt AF, Chitteti BR, **Speth JM**, Hu P, Poteat BA, Stilger KN, Ferraro F, Silberstein L, Wong FK, Farag S, Czader M, Breyer R, Scadden DT, Guise T, Srour EF, Pelus LM. Differential Stem and Progenitor Cell Trafficking by Prostaglandin E<sub>2</sub>. *Nature*, 495(7441):365-9, 2013.

Broxmeyer HE, Hoggatt J, O'Leary HA, Mantel C, Chitteti BR, Cooper S, Messina-Graham S, Hangoc G, Farag S, Rohrabough SL, Ou X, **Speth J**, Pelus LM, Srour EF, Campbell TB. Dipeptidylpeptidase 4 negatively regulates colony-stimulating factor activity and stress hematopoiesis. *Nat Med*, 18(12): 1786-96, 2012.

Singh P, Hoggatt J, Hu P, **Speth JM**, Fukuda S, Breyer RM, Pelus LM. Blockade of prostaglandin E<sub>2</sub> signaling through EP1 and EP3 receptors attenuates Flt3L-dependent dendritic cell development from hematopoietic progenitor cells. *Blood*, 119(7): 1671-82, 2012.

Pelus, L, **Speth, J** and Hoggatt, J. Prostaglandin E<sub>2</sub> and Other Eicosanoid Based Strategies to Enhance Umbilical Cord Blood Stem Cell Engraftment. *Cord Blood - Biology, Transplantation, Banking and Regulation*, 3rd Edition, Edited by Hal E. Broxmeyer, AABB Press, Bethesda, MD, ISBN No. 978-1-56395-318-7,187-201, 2011.

P Qu, **J Roberts**, Y Li, M Albrecht, OW Cummings, JN Eble, H Du, C Yan. Stat3 downstream genes serve as biomarkers in human lung carcinomas and chronic obstructive pulmonary disease. *Lung Cancer*, 63(3):341-7, 2008.

Y Li, H Du, Y Qin, **J Roberts**, OW Cummings, C Yan. Activation of the signal transducers and activators of transcription 3 pathway in alveolar epithelial cells induces inflammation and adenocarcinomas in mouse lung. *Cancer Res*, 67(18):8494-503, 2007.

## ABSTRACTS

**Jennifer M Speth**, Jonathan Hoggatt, and Louis M. Pelus. Enhanced Homing of HSPCs After Treatment with Prostaglandin E<sub>2</sub> (PGE<sub>2</sub>) May Be An Effect of Transcriptional Regulation of CXC Chemokine Receptor 4 (CXCR4) Through Hypoxia Inducible Factor 1 $\alpha$  (HIF1 $\alpha$ ). *Blood* (ASH Annual Meeting Abstracts), Nov 2011; 118:918.

Jonathan Hoggatt, Khalid S Mohammad, Brahmananda Reddy Chitteti, Pratibha Singh, **Jennifer M Speth**, Peirong Hu, Bradley Poteat, Edward Srour, Theresa Guise, and Louis M. Pelus. Bone Marrow Niche Attenuation by Non-Steroidal Anti-Inflammatory Drugs Mobilizes Hematopoietic Stem and Progenitor Cells by Differing Mechanisms. *Blood* (ASH Annual Meeting Abstracts), Nov 2011; 118:724.

Pratibha Singh, Jonathan Hoggatt, **Jennifer Speth**, and Louis M. Pelus. Prostaglandin E<sub>2</sub> Modulates Monocytes and Dendritic Cells Specific Progenitor Cell (MDP) Fate by Regulating M-CSF Receptor and Flt3 Receptor Expression. *Blood* (ASH Annual Meeting Abstracts), Nov 2010; 116: 2636.

Seiji Fukuda, Pratibha Singh, Jonathan Hoggatt, **Jennifer Speth**, Mariko Abe, Edward M. Conway, John Crispino, Giuseppina Nucifora, Seiji Yamaguchi, and Louis M. Pelus. Survivin Modulates Gene Expression That Connects through An Extensive Functional Signaling Network and Regulates Proliferation of Hematopoietic Stem Cells through Evi-1. *Blood* (ASH Annual Meeting Abstracts), Nov 2010; 116: 87.

Jonathan Hoggatt, Pratibha Singh, Amber Hoggatt, **Jennifer M Speth**, and Louis M Pelus. Inhibition of Prostaglandin E<sub>2</sub> (PGE<sub>2</sub>) Signaling by Non-Steroidal Anti-Inflammatory Drugs (NSAIDs) or EP4 Receptor Antagonism Expands Hematopoietic Stem and Progenitor Cells (HSPC) and Enhances Their Mobilization to Peripheral Blood in Mice and Baboons. *Blood* (ASH Annual Meeting Abstracts), Nov 2009; 114: 84.

Pratibha Singh, Jonathan Hoggatt, **Jennifer M Speth**, and Louis M Pelus. Cyclooxygenase-2 Derived Prostaglandin E<sub>2</sub> Is Required for Dendritic Cell Differentiation From Hematopoietic Progenitor Cells. *Blood* (ASH Annual Meeting Abstracts), Nov 2009; 114: 1499.