

4-1-2004

Kit-of-parts architecture : an exploration into the standardization and simplification of an urban residential building unit

John Anderson Allmand
Florida International University

Follow this and additional works at: <http://digitalcommons.fiu.edu/etd>

 Part of the [Urban, Community and Regional Planning Commons](#)

Recommended Citation

Allmand, John Anderson, "Kit-of-parts architecture : an exploration into the standardization and simplification of an urban residential building unit" (2004). *FIU Electronic Theses and Dissertations*. Paper 1070.
<http://digitalcommons.fiu.edu/etd/1070>

This work is brought to you for free and open access by the University Graduate School at FIU Digital Commons. It has been accepted for inclusion in FIU Electronic Theses and Dissertations by an authorized administrator of FIU Digital Commons. For more information, please contact dcc@fiu.edu.

FLORIDA INTERNATIONAL UNIVERSITY

Miami, Florida

KIT-OF-PARTS ARCHITECTURE:
AN EXPLORATION INTO THE STANDARDIZATION
AND SIMPLIFICATION OF AN URBAN
RESIDENTIAL BUILDING UNIT

A thesis submitted in partial fulfillment of the
requirements for the degree of
MASTER OF ARCHITECTURE

by

John Anderson Allmand

2004

To: Dean Juan Antonio Bueno
School of Architecture

This thesis, written by John Anderson Allmand, and entitled Kit-of-Parts Architecture: An Exploration into the Standardization and Simplification of an Urban Residential Building Unit, having been approved in respect to style and intellectual content, is referred to you for judgment.

We have read this thesis and recommend that it be approved.

Gray Read

William McMinn

Jason Chandler, Major Professor

Date of Defense: April 1, 2004

The thesis of John Anderson Allmand is approved.

Dean Juan Antonio Bueno
School of Architecture

Dean Douglas Wartzok
University Graduate School

© Copyright 2004 by John Anderson Allmand
All rights reserved.

DEDICATION

I dedicate this thesis to Christine, who inspires me to excel at everything I do.

ABSTRACT OF THESIS

KIT-OF-PARTS ARCHITECTURE:

AN EXPLORATION INTO THE STANDARDIZATION

AND SIMPLIFICATION OF AN URBAN

RESIDENTIAL BUILDING UNIT

by

John Anderson Allmand

Florida International University

Miami, Florida

Professor Jason Chandler, Major Professor

This thesis focuses on the design of a construction method that utilizes a single adaptable kit-of-parts system. The new system is designed to be flexible while also enhancing construction speeds without severely limiting the building's ability to merge into an urban fabric. This thesis proposes a residential structure to be built from a handful of simple structural units.

This is accomplished through the design of a residential building situated in an area of Miami currently under reconstruction.

TABLE OF CONTENTS

CHAPTER	PAGE
I. INTRODUCTION.....	1
II. SITE.....	2
III. PRECEDENTS.....	4
IV. FORMAL COMPOSITION.....	6
V. PROCESS.....	14
VI. ADAPTABILITY.....	20
VII. ECONOMIC VIABILITY.....	21
VIII. PROTOTYPE.....	22
IX. CONCLUSION.....	37
BIBLIOGRAPHY.....	38
ENDNOTES.....	39

LIST OF FIGURES

FIGURE	PAGE
1. Site Overview.....	1
2. Site Overview.....	1
3. Site Ariel.....	2
4. Site Photo - Low Density Example.....	2
5. Site Photo - Low Density Example.....	2
6. Site Photo - Medium Density Example.....	2
7. Site Photo - Medium Density Example.....	2
8. Site Photo - High Density Example.....	2
9. Site Photo - High Density Example.....	2
10. Site Photo - Miami River.....	2
11. Site Photo - Miami River.....	2
12. Site Axonometric.....	3
13. Census Tracts.....	3
14. Zip Code Boundary.....	3
15. Minor Statistical Areas.....	3
16. Hispanic Distribution.....	3
17. Municipalities.....	3
18. Districts.....	3
19. Takara Pavilion 1970.....	4
20. Assembly.....	5
21. Crystal Palace - Hyde Park.....	5
22. Crystal Palace - Hyde Park.....	5
23. Crystal Palace - Assembly.....	5
24. Cross Unit.....	6

25. Horizontal Plate.....	6
26. Assembly.....	7
27. Assembly.....	7
28. Cross and Plates.....	7
29. Cross Family.....	8
30. Plate Family.....	9
31. Material Axonometric.....	10
32. Material Axonometric.....	11
33. Material Axonometric.....	12
34. Louver Balcony Large.....	12
35. Louver Balcony Small.....	12
36. Railing Balcony Large.....	12
37. Railing Balcony Small.....	12
38. Storefront Balcony Large.....	12
39. Storefront Balcony Small.....	12
40. Walled Balcony Large.....	12
41. Walled Balcony Small.....	12
42. Balcony Family.....	13
43. Full Assembly.....	14
44. Assembly Detail.....	15
45. Assembly Detail.....	16
46. Assembly Detail.....	17
47. Unit Section Detail.....	17
48. Assembly Detail.....	18
49. Assembly Detail.....	18
50. Assembly Detail.....	18

51. Assembly Detail.....	18
52. Assembly Detail.....	18
53. Framing Axonometric.....	19
54. Example Rendering.....	20
55. Building Rendering - close up.....	21
56. Building Rendering.....	22
57. Site Plan.....	23
58. Typical Plan A.....	24
59. Typical Plan B.....	25
60. Typical Double Unit.....	26
61. Single Unit A and B.....	27
62. North Elevation.....	28
63. South Elevation.....	29
64. East Elevation.....	30
65. West Elevation.....	31
66. Section A.....	32
67. Section B.....	33
68. Section C.....	34
69. Section D.....	35
70. Section E.....	36
71. Final Building.....	37

INTRODUCTION

Is there a way to improve today's urban construction techniques that would increase the efficiency and lower the cost of the entire process? This question allowed for an investigation of methods and concepts of construction that could be utilized to simplify the building procedure. Is it possible to design a construction system based around a single adaptable kit-of-parts system without severely limiting the building's ability to merge into the current urban fabric? This thesis is sited in downtown Miami. It is an urban residential structure built with a handful of structural units. With close attention to formal composition, process, adaptability, and economic viability, the design will embrace its surrounding context and provide an effective urban element within downtown Miami.

With the reemergence of Miami's downtown, architects increasingly focus on new urban conditions such as increased density and building within a historic context (See Figures 1-2). The solutions that have been presented to date utilize the current construction system of building that can be costly and time consuming. A kit-of-parts building system and streamlined construction process could create more cost-effective space and create savings which could be passed onto the consumer. The revitalization of the city could reduce all kinds of problems from reducing morning traffic to slowing the effects of urban sprawl and providing more affordable housing.

This project was to design a new construction system which when introduced into Miami's urban fabric, could both increase density quickly and effectively. This new system is done through a design of a residential building situated in an area of the city currently under reconstruction.



Figure 1 – Site Overview



Figure 2 – Site Overview

SITE

The chosen site, in Miami, has several existing residential buildings, as well as other support uses in the surrounding area (See Figures 3-18). The site is located in an area of low density with a potential for growth. The area is located on the Miami River between the inner city of downtown Miami and the sprawling residential area outside.



Figure 3 – Site Ariel



Figure 4 – Site Photo – Low Density Example



Figure 5 – Site Photo – Low Density Example



Figure 6 – Site Photo - Medium Density Example



Figure 7 – Site Photo – Medium Density Example



Figure 8 – Site Photo – Miami River

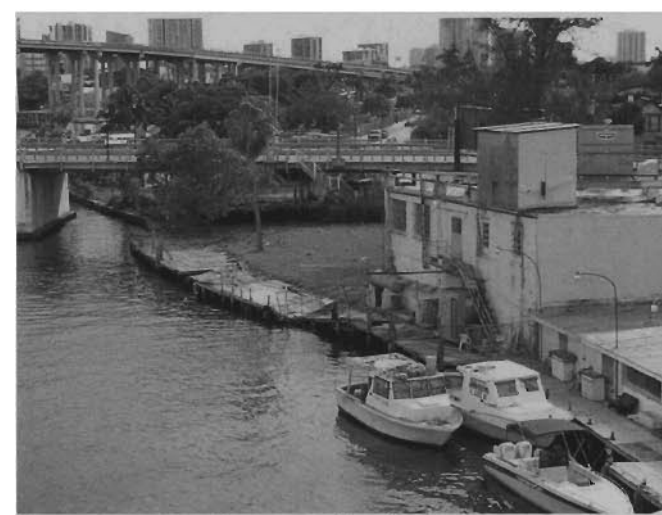

Figure 9 – Site Photo – Miami River



Figure 10 – Site Photo- High Density Example



Figure 11 – Site Photo – High Density Example



Figure 12 – Site Axonometric



Figure – 13 Census Tracts

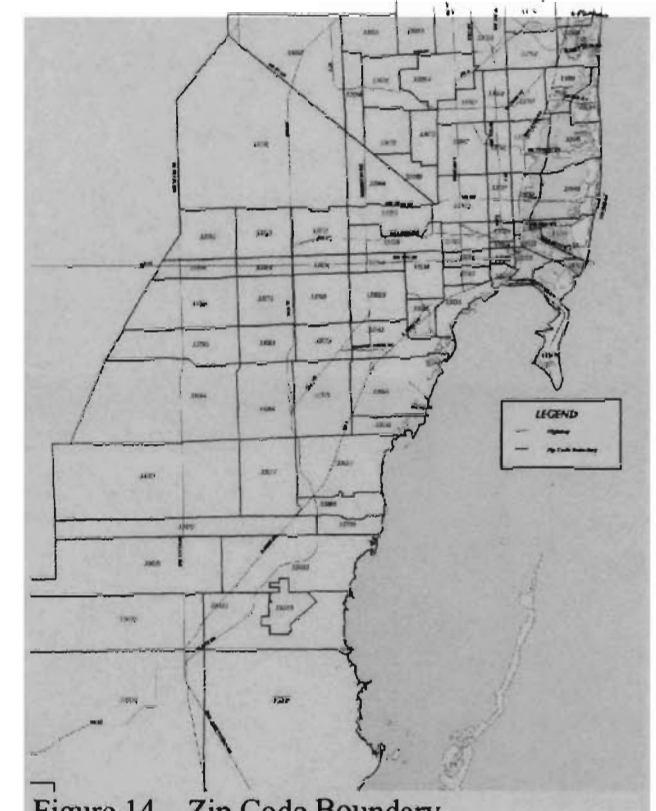

Figure 14 – Zip Code Boundary

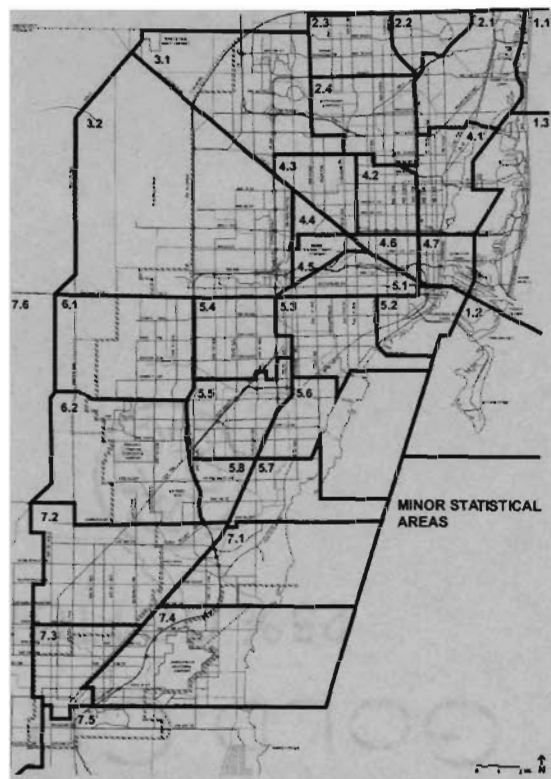

Figure 15 – Minor Statistical Areas

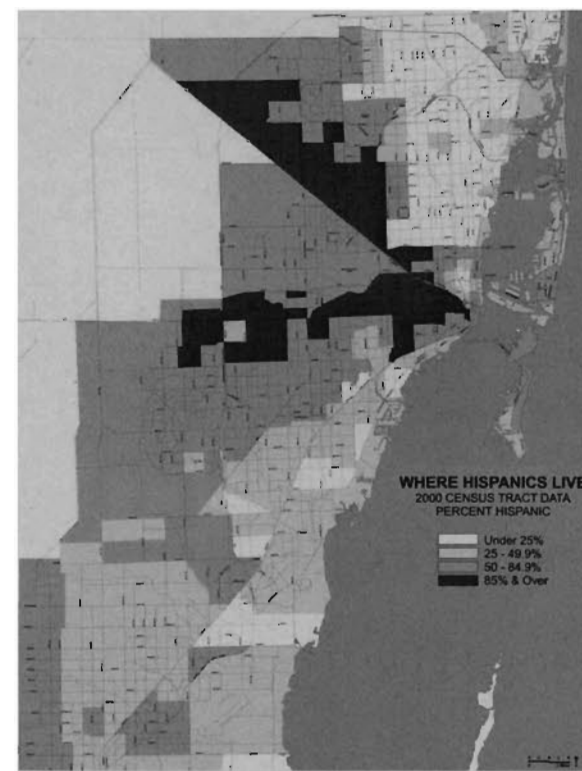

Figure 16 – Hispanic Distribution



Figure 17 – Municipalities

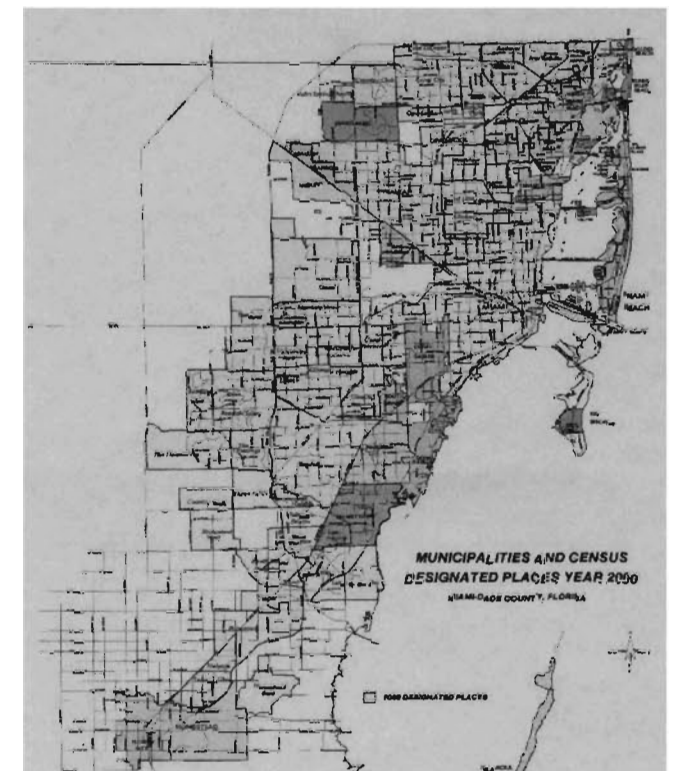

Figure 18 – Districts

PRECEDENTS

The Takara Pavilion of 1970, designed by Noriaki Kurokawa, used steel tubing to form a similar construction system (See Figure 19). Robin Boyd explained the system, "The structural system is based on a single pre-fabricated framing unit which is repeated some 200 times. Each unit is made up of 12 blunt right-angle bends of steel pipe (10 cm diameter) welded to make six arms, each consisting of four pipes grouped in a square, thus forming overall a 3-d, six-pointed cross measuring 3.3 meters in each of the three dimensions... The end of each arm is welded to a flat circular disc, like a hand holed for bolts. When several of these units are bolted together at the discs, they make up a space frame of repetitive cubes... Floors are of pre-cast concrete slabs dropped into the steel frame. The whole system looks as easy and as full of fun as a toy construction kit." He goes on to say, "Joining was accomplished by the use of high tension bolts and assembly was extremely easy to complete, only a few days were required."¹

The main form of the project's structural unit was derived from the figure present in the pavilion. Rather than steel, concrete was used because it can be considered a finished material and the replication process is easier when considering the degree of flexibility required. Finally, a key observation that Mr. Boyd made was the ease and speed of the construction process, which are definite goals of the design.

The first kit-of-parts building, The Crystal Palace, built in London in 1851, exemplifies the speed and efficiency by which these types of building's can be assembled (See Figure 20-23). That year England was scheduled to host an exhibition of the most modern technologies and they needed a large space to hold the event. They employed Joseph Paxton, a botanist with experience in building greenhouses, who assembled the Crystal Palace in ten days. "Built out of prefabricated and wrought-iron elements and based on a four-foot module, this 1,848-foot-long ferro-vitreous construction was erected to the designs of Joseph Paxton and Charles Fox of Fox, Henderson & Co. Its interior volume was organized into galleries that were alternately 24 feet and 48 feet wide. The roof of these galleries stepped up by 20 feet every 72 feet and culminated in a central nave 72 feet wide. The 'ridge and furrow' roof glazing system specially devised for the occasion required 49-inch glass sheets capable of spanning between furrows 8 feet apart, with three ridges occurring every 24 feet."² It was located in Hyde Park and housed over a million square feet of

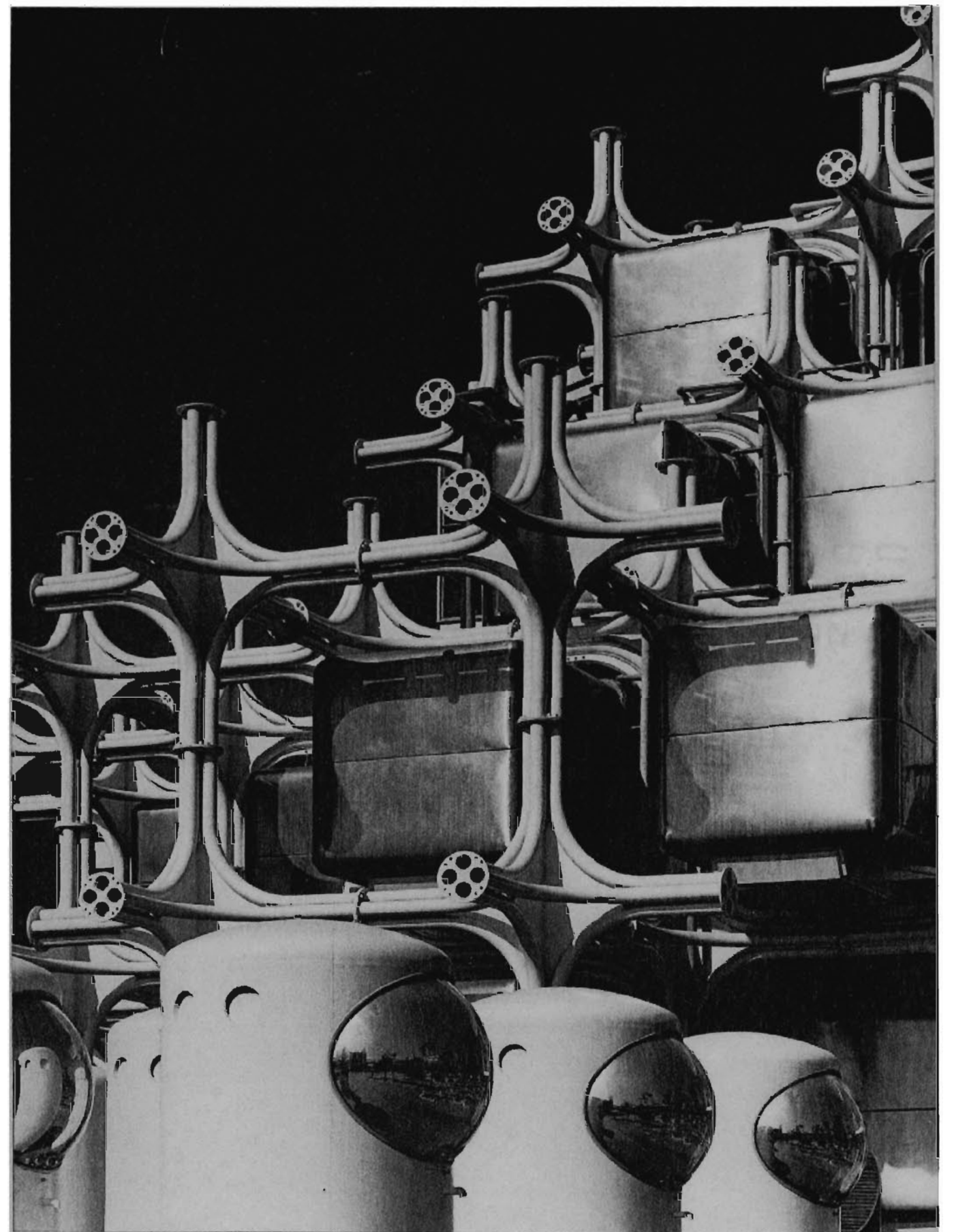

Figure 19 – Takara Pavilion 1970

exhibition space. So successful was the Crystal Palace that when no longer needed it was disassembled and moved to another location. The idea that an entire building could be moved by simply disassembling it and reassembling it somewhere else motivates this thesis. The lesson from this masterpiece is the importance of construction organized where all the pieces arrive together to form the building with economy and speed.

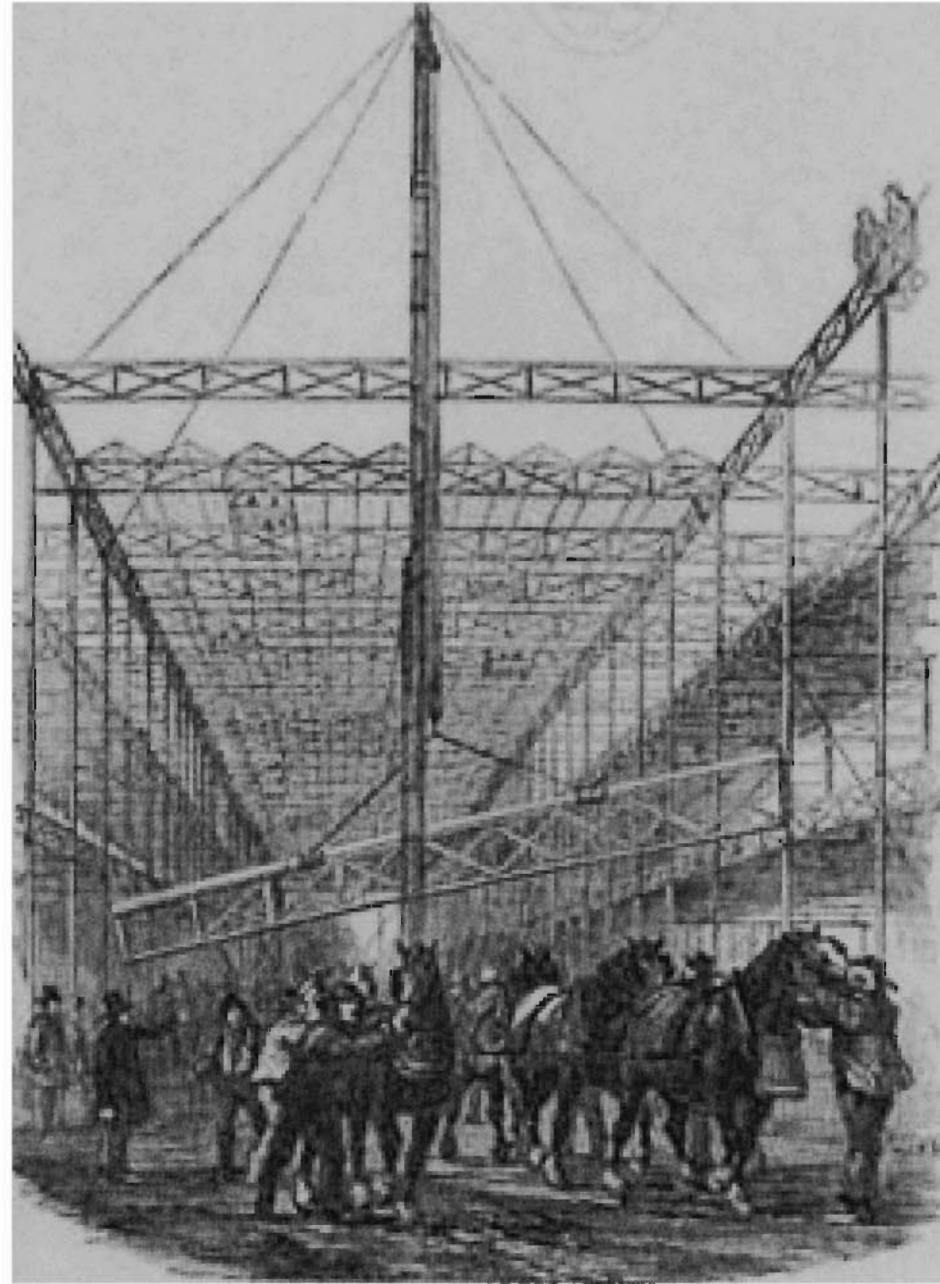

Figure 20 – Assembly

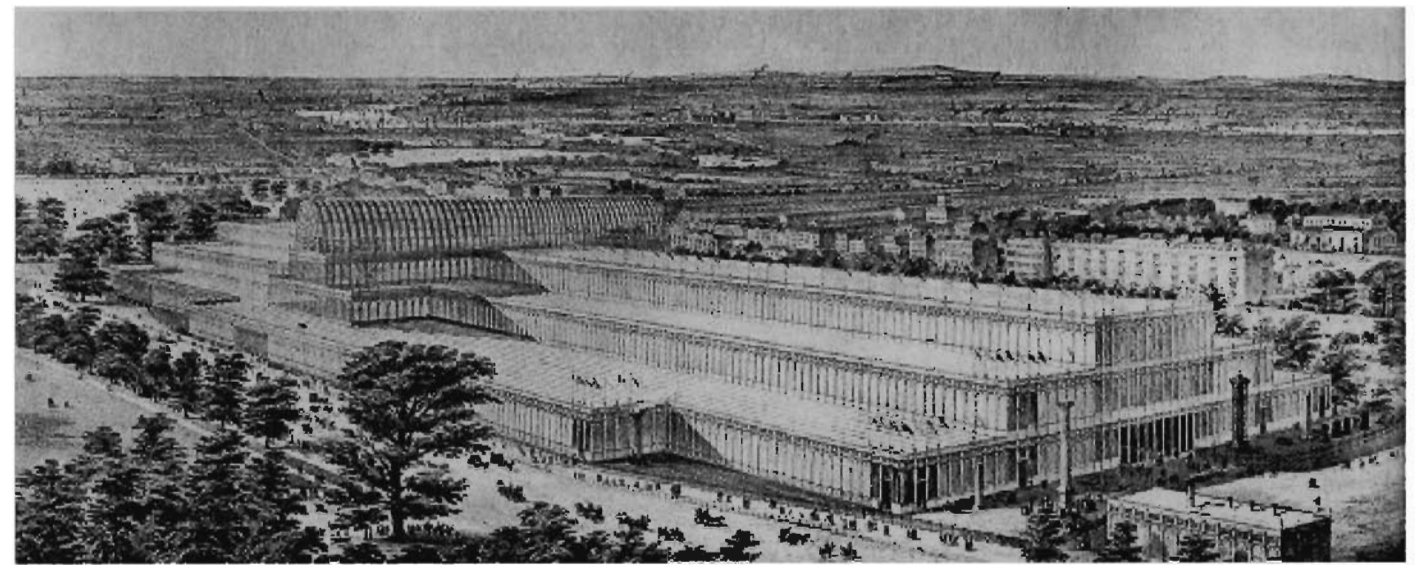

Figure 21 – Crystal Palace – Hyde Park

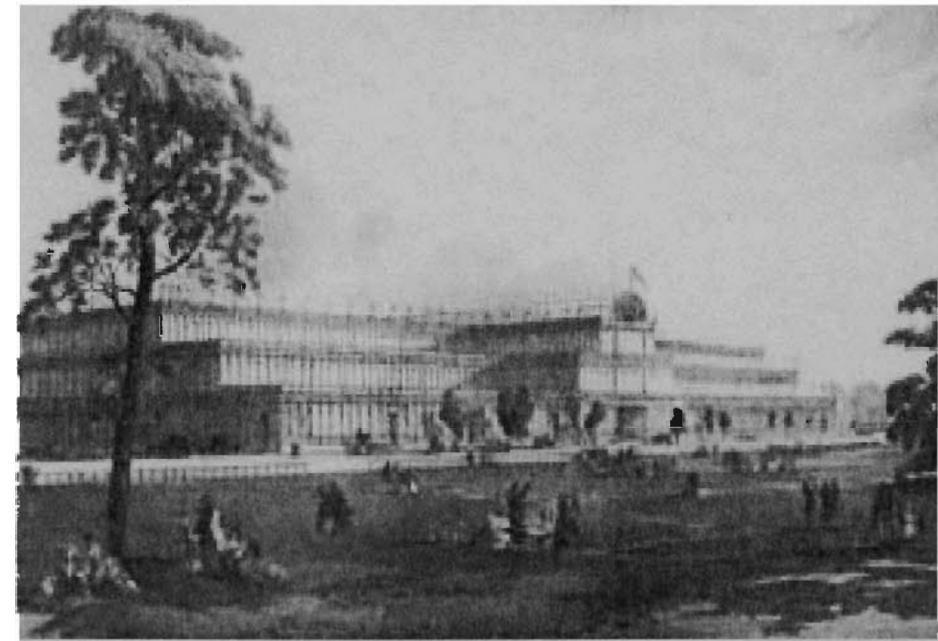

Figure 22 – Crystal Palace – Hyde Park

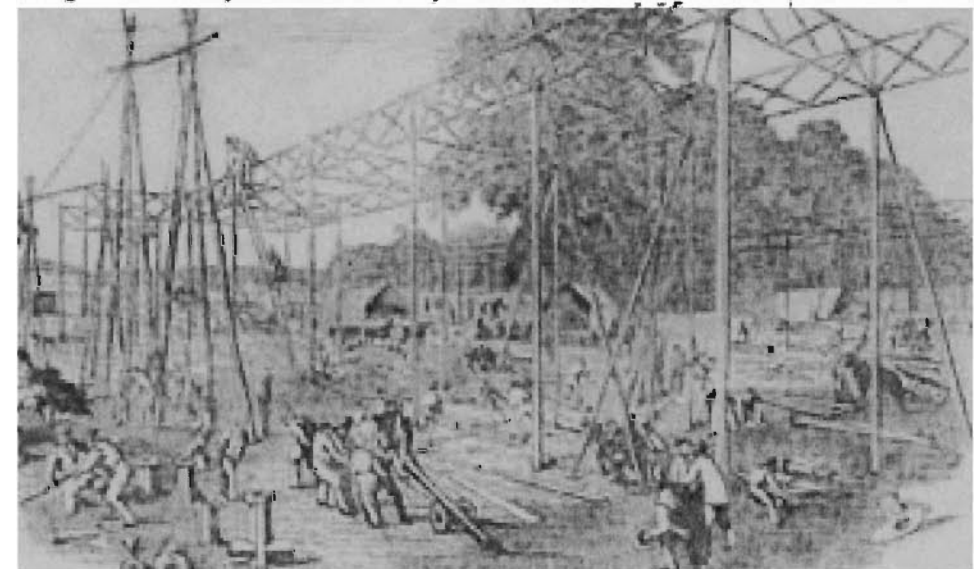

Figure 23 – Assembly

FORMAL COMPOSITION

The form the units take is generated from an analysis of the structural needs of the building (See Figures 24, 25). This system employs the simplicity of the Cartesian cross, which is made by combining the x, y, and, z-axis. This form combines beams and columns into one structural unit. By merging two elements into one, the cross halves the number of connections needed, thus simplifying the system. Rather than a beam having two connections, one on either end, each cross joins the next one in the middle of a span. Four crosses arranged in a square will be joined by a flat plate made of an aluminum grid. Horizontal plates form the floors and ceilings of the building while the vertical plates will function as demising walls as well as elements that resist shear and other lateral forces (See Figures 26-28).

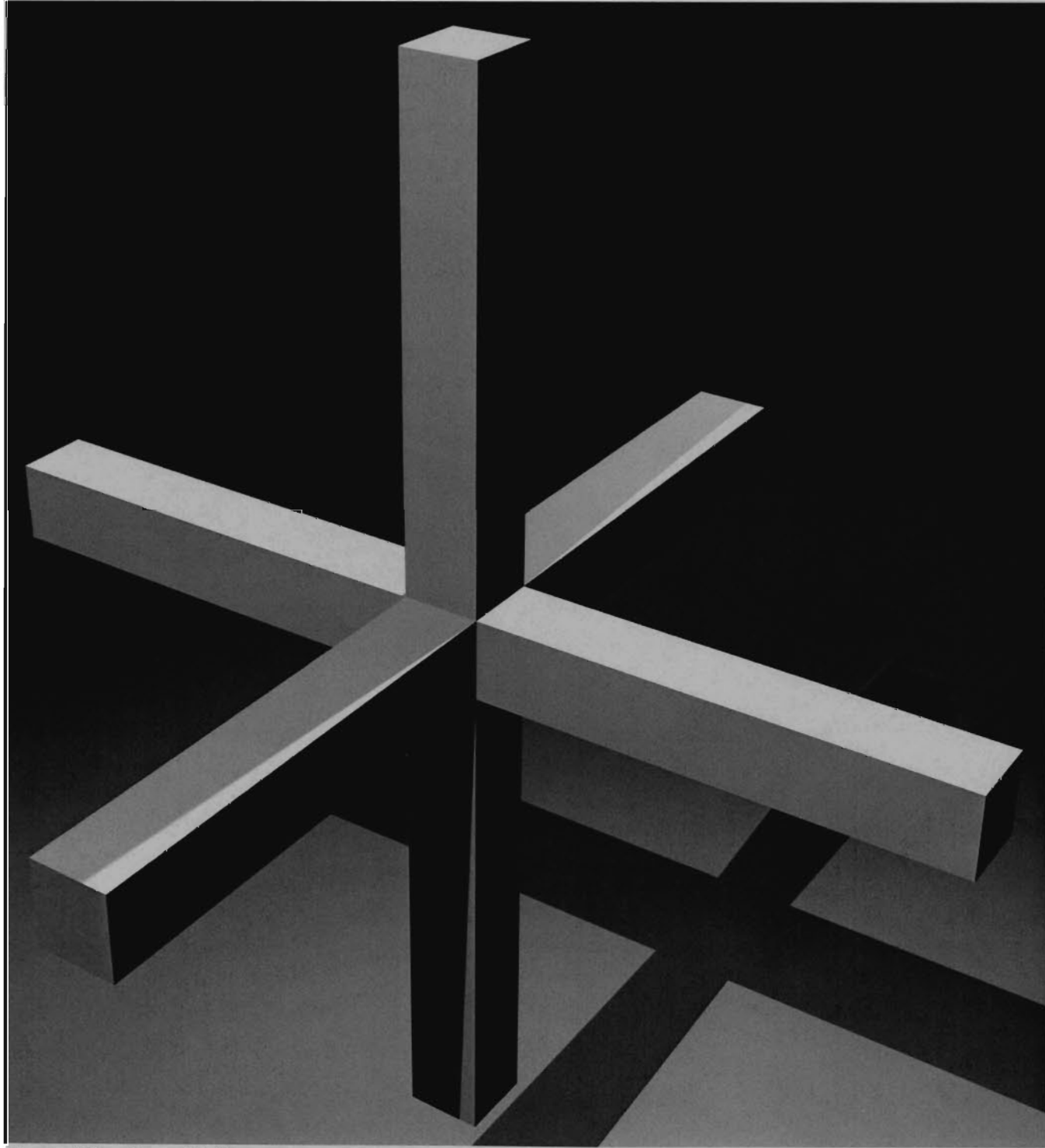

Figure 24 – Cross Unit

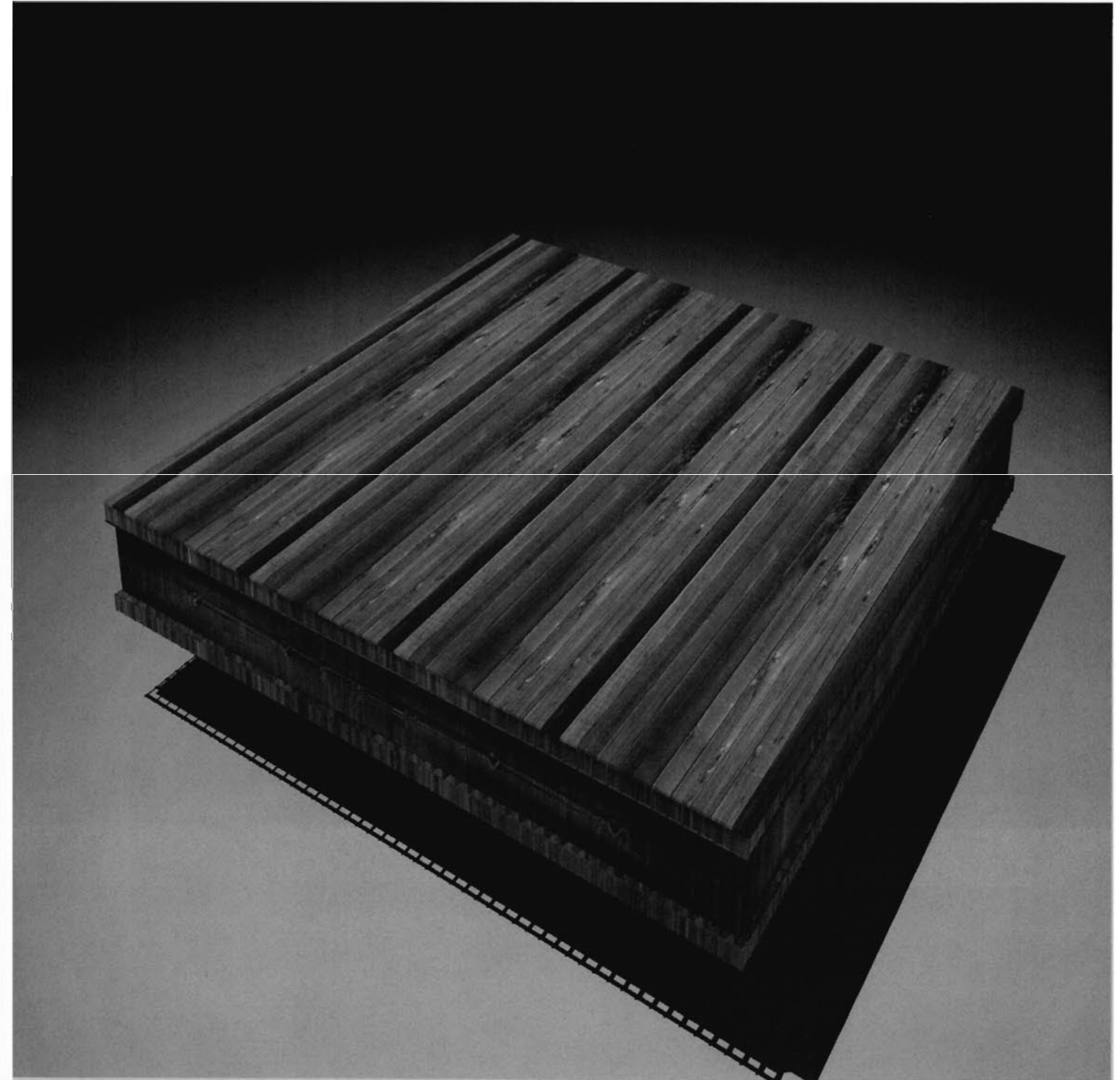

Figure 25 – Horizontal Plate

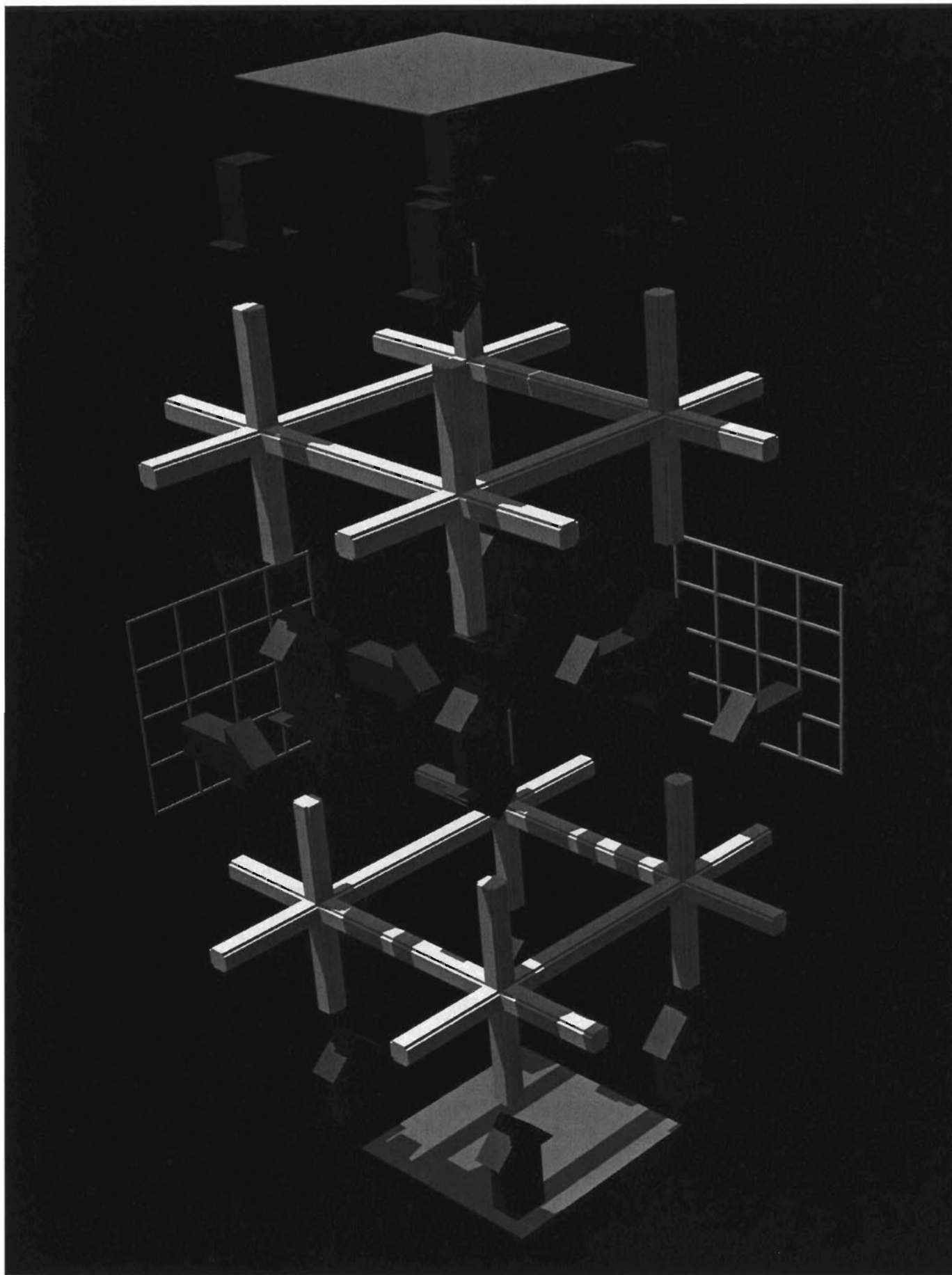

Figure 26 – Assembly

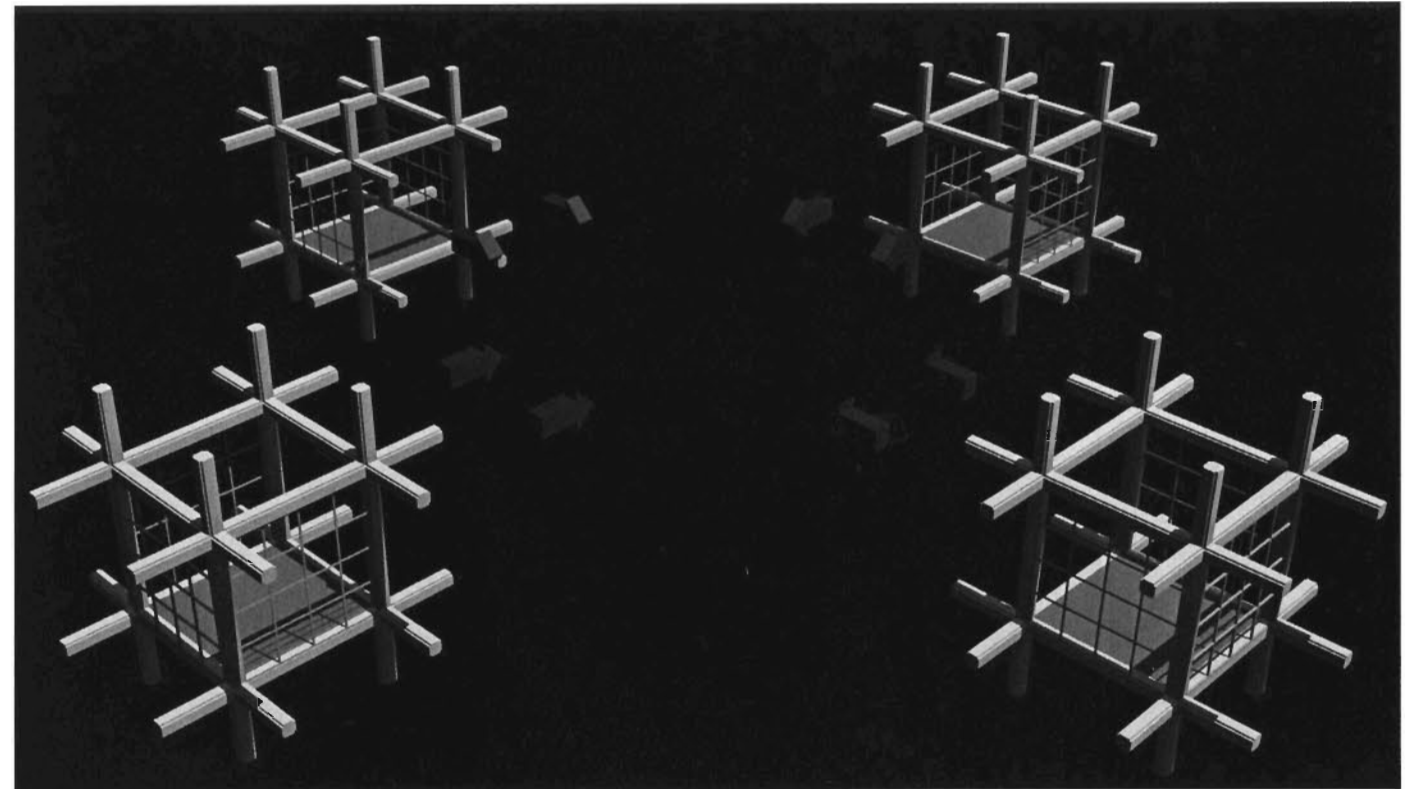

Figure 27 – Assembly

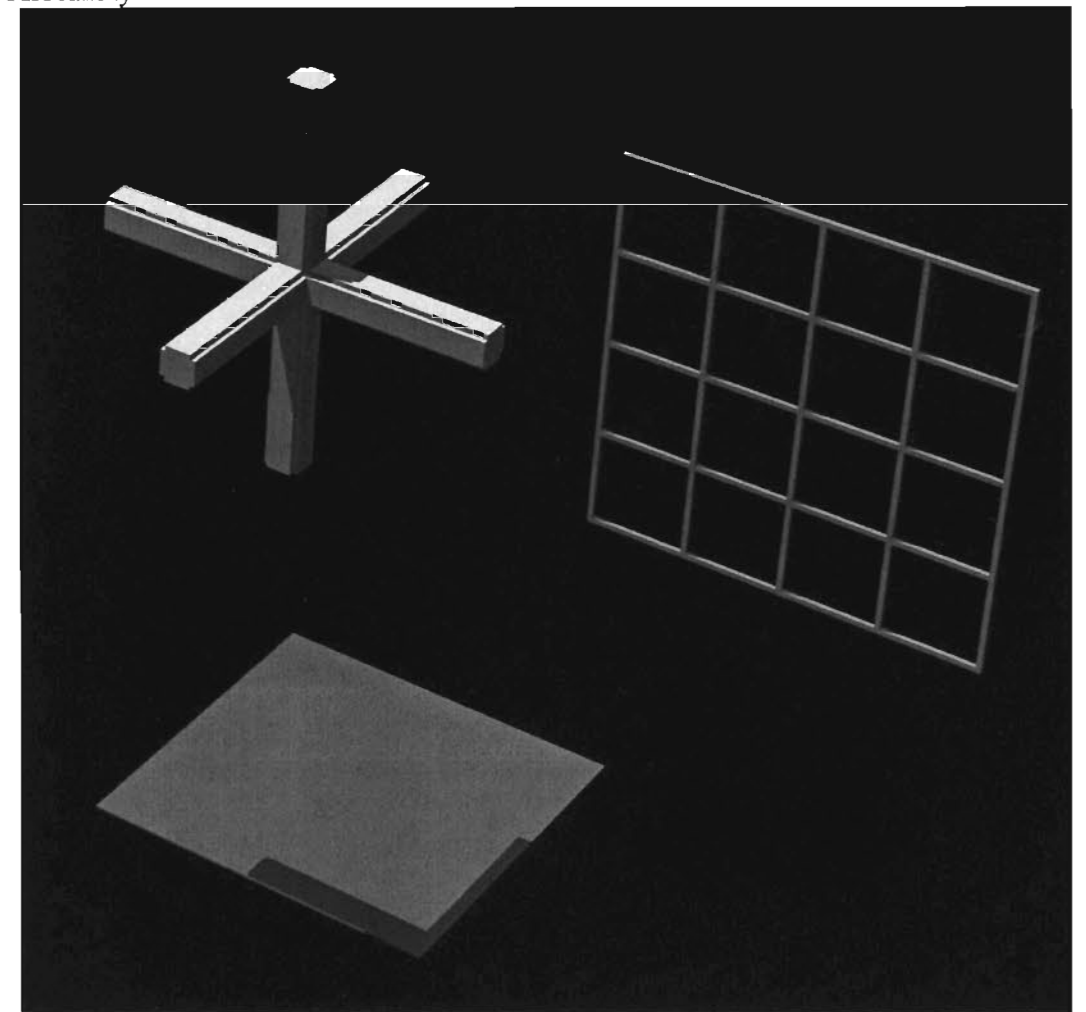

Figure 28 – Assembly

Each generative figure developed its own family of forms based on their special uses (See Figure 29). The transfer cross is used to span distances larger than the normal unit is able. A receptor cross works in conjunction with the transfer unit and acts as a load-acceptance unit. The terminator cross is used in circumstances where the structure does not continue upward past that unit. The ramp units make vertical circulation within the parking areas possible.

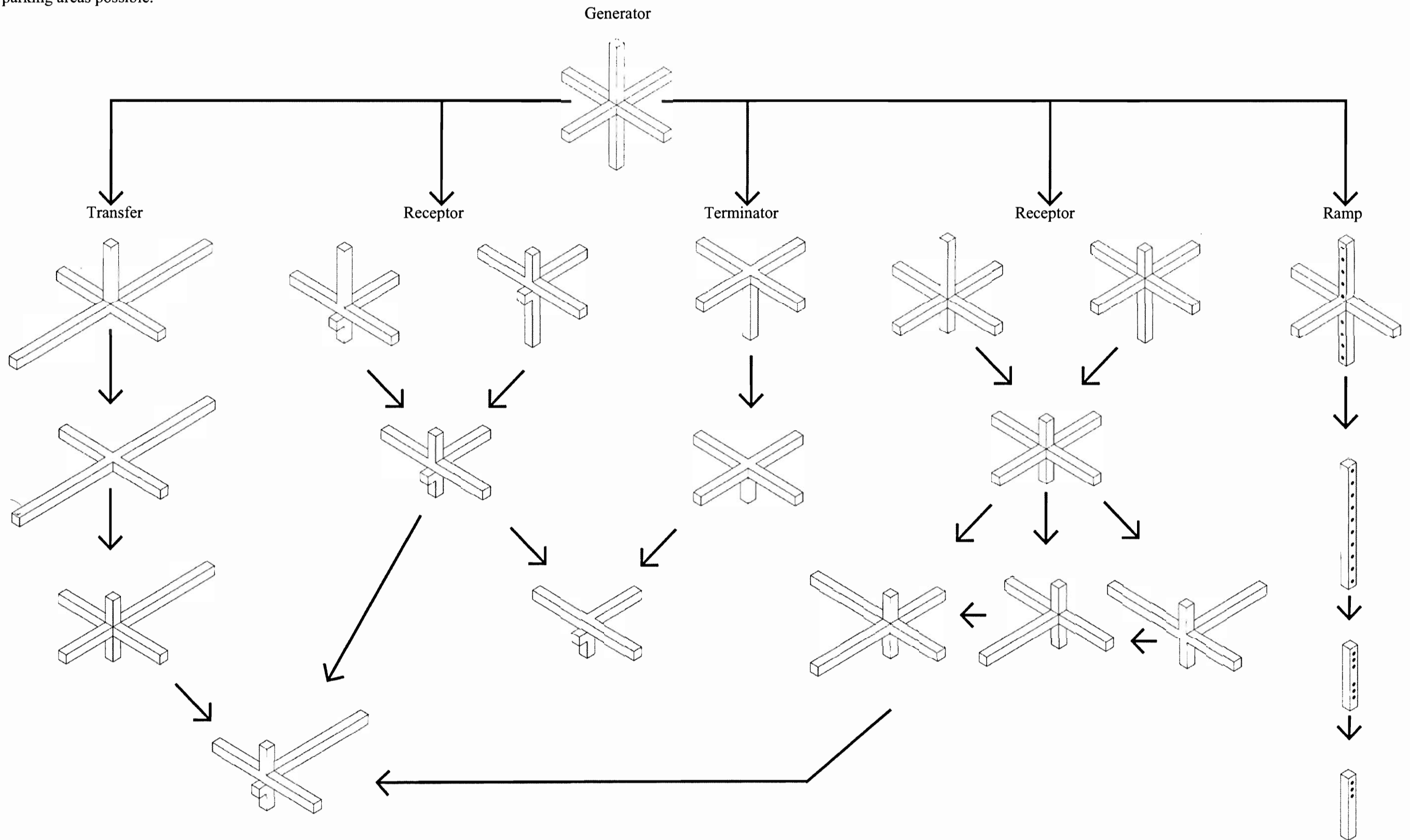

Figure 29 – Cross Family

The plate generator allows for a series of horizontal and vertical typologies (See Figure 30). Each having its own specific uses; they are further divided into open and closed versions. This enables the system to have a greater flexibility in the size and shape of the spaces that are formed within the building.

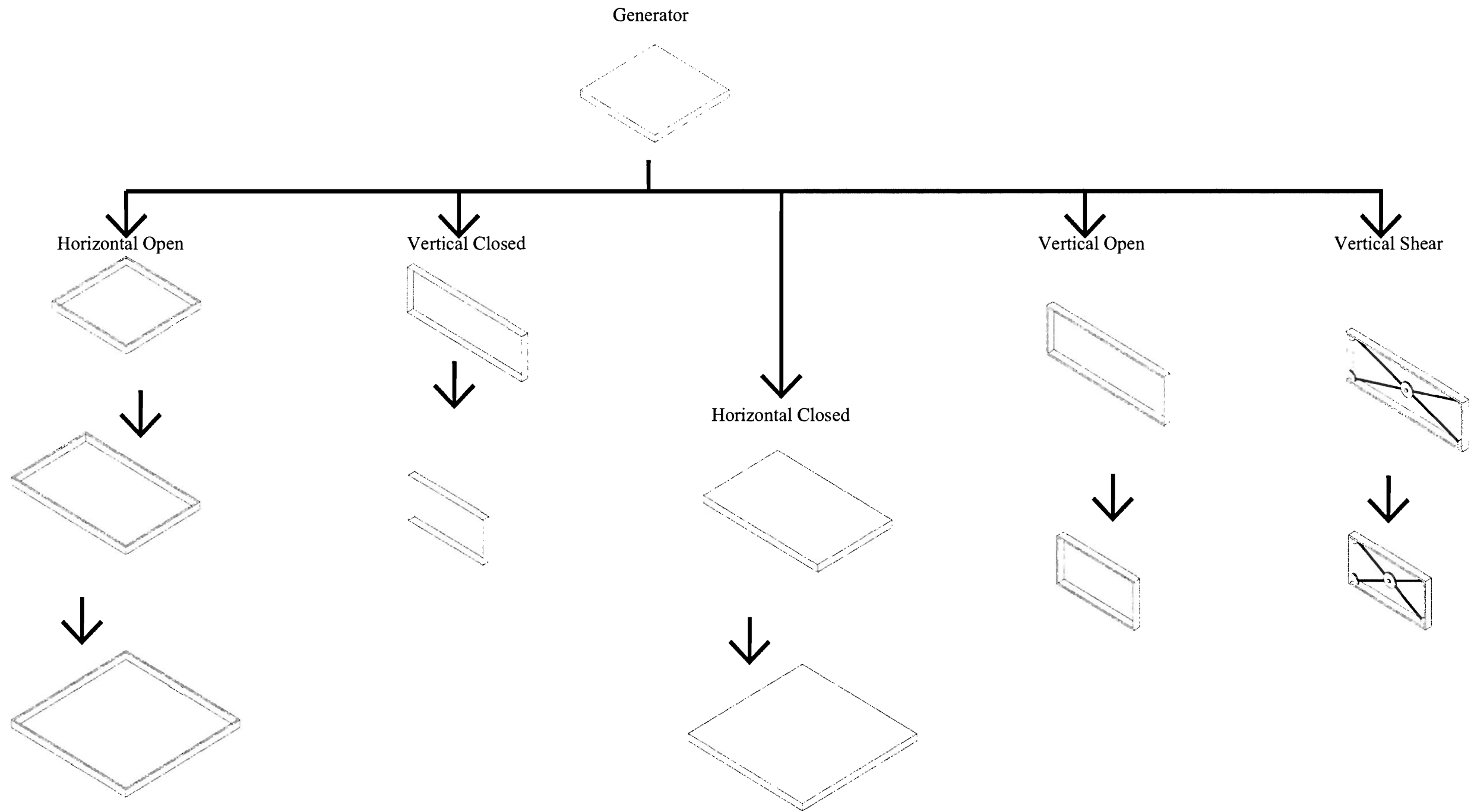

Figure 30 – Plate Family

Along with the form, alternative materials of construction were a special area of focus (See Figures 31, 32). My system uses a concrete structure combined with steel plates and aluminum grid. The mixture of different materials was used in order to harness the strengths and counter the weaknesses of each material. Concrete was used for its basic form because it can be cast easily and resists compressive forces.³ Steel was used to resist tension and to provide a strong and stable platform for connections. Aluminum was used for its lightweight and ability to be molded into different forms easily.³

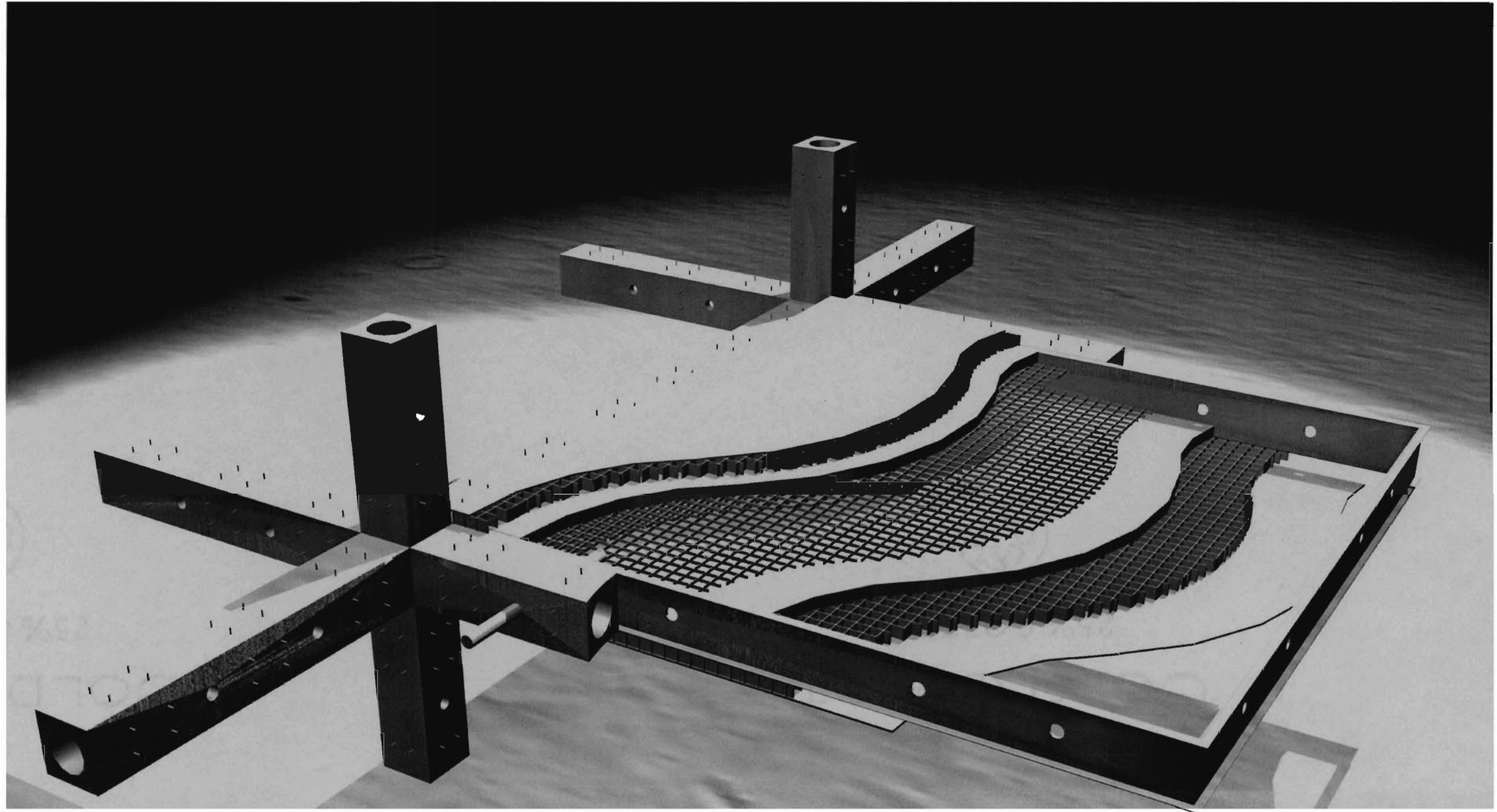

Figure 31 – Material Axonometric

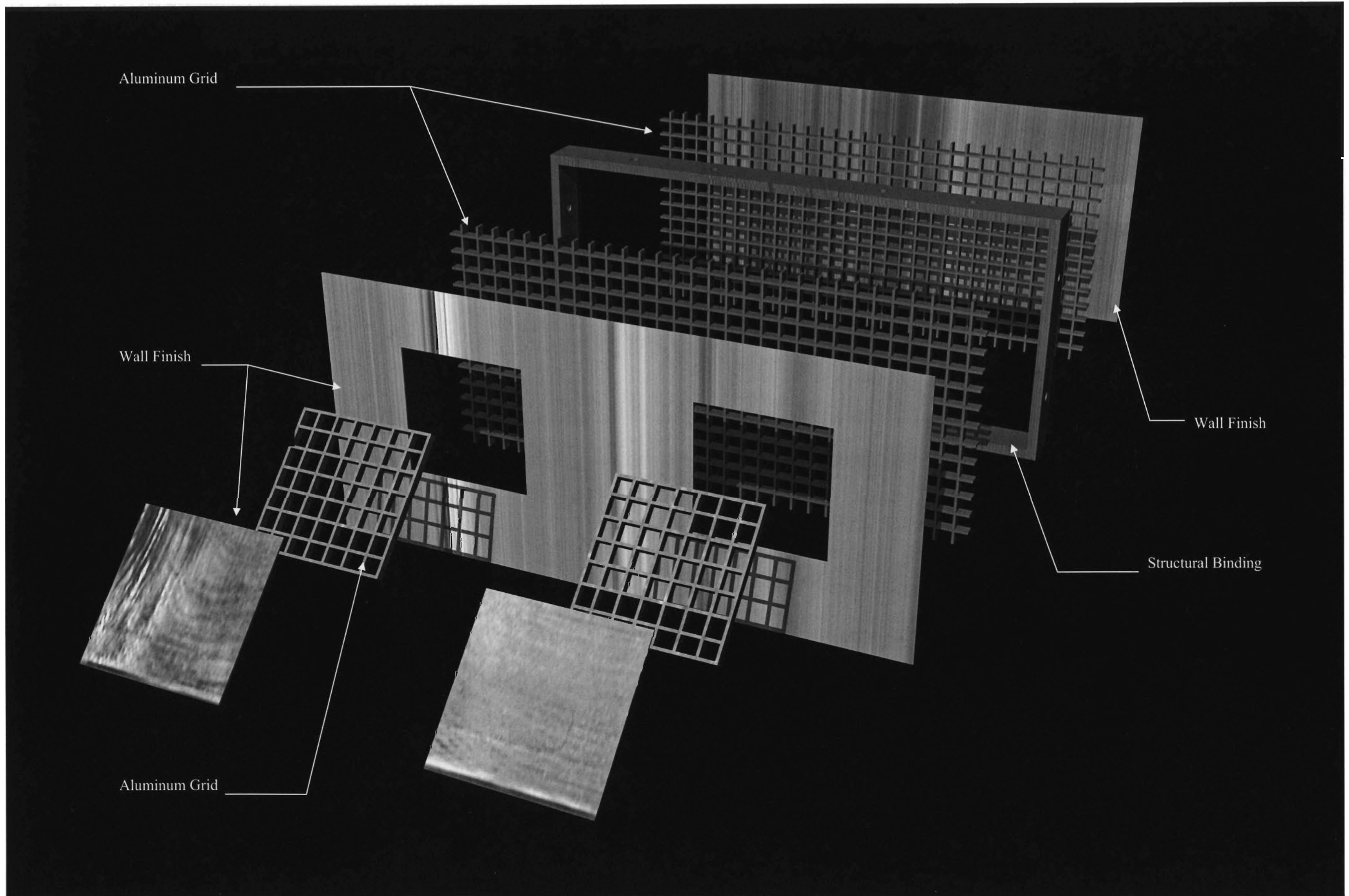

Figure 32 – Material Axonometric

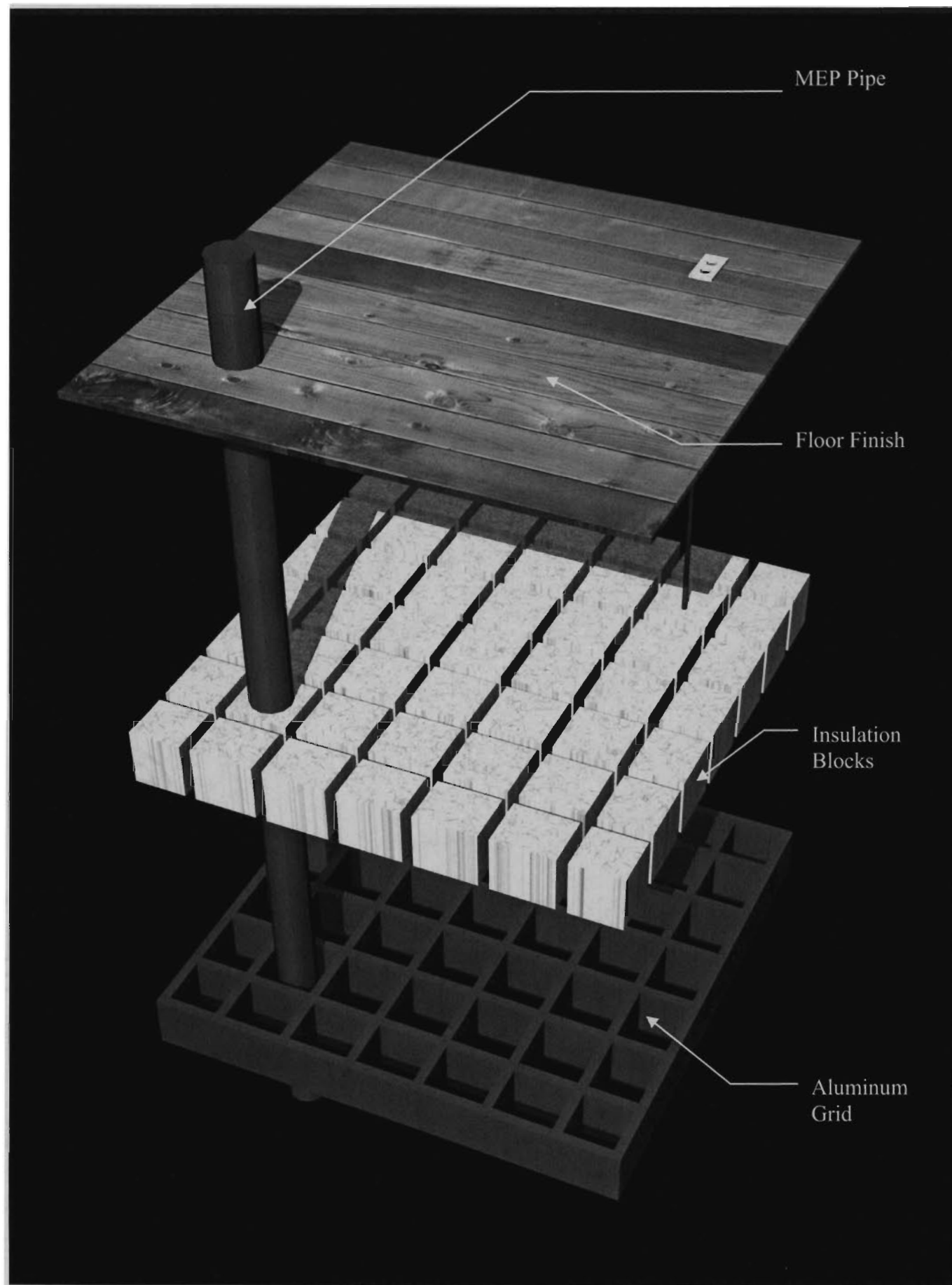

Figure 33 – Material Axonometric

Mechanical, electrical, plumbing (MEP) pipes move through the aluminum grid, and then pass through the insulation blocks (See Figure 33). The floor finish is cut away and the pipe is brought to the unit where it supplies the occupant with mechanical, electrical and plumbing utilities. All utilities are supplied to the unit in this way except the air conditioning, which is brought to the occupant through single wall units.

The last units are the balcony assemblies. (See Figures 34-42) These pieces arrive on the site pre-constructed and fit directly onto the facade of the building.

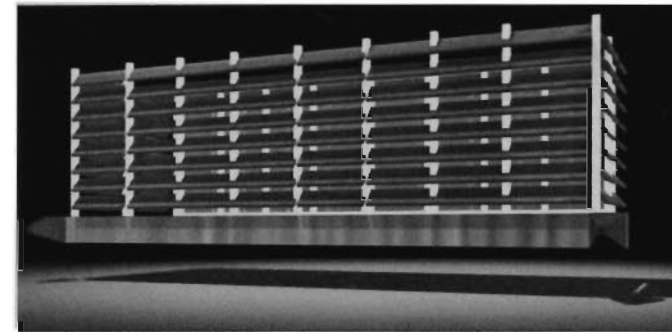

Figure 34 – Louver Balcony Large

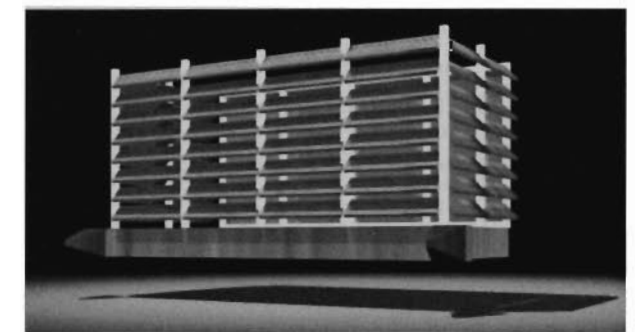

Figure 35 – Louver Balcony Small

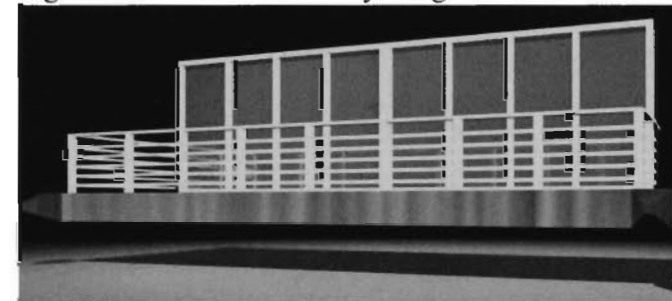

Figure 36 – Railing Balcony Large



Figure 37 – Railing Balcony Small

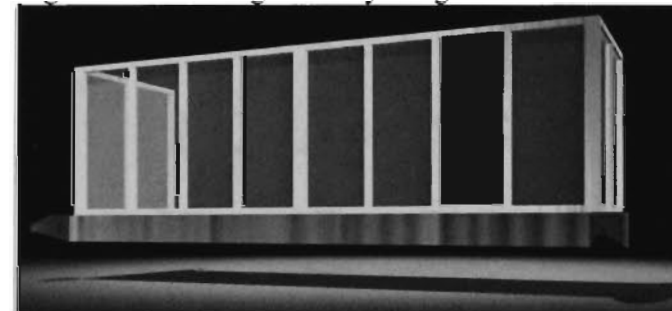

Figure 38 – Storefront Balcony Large

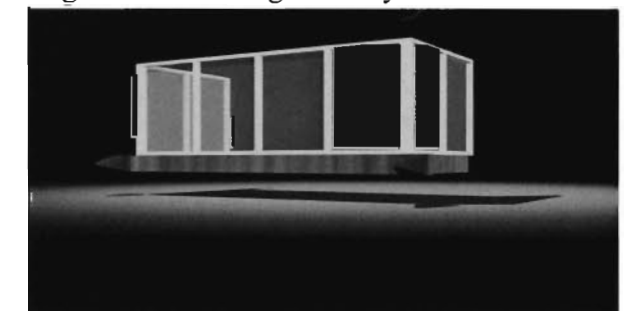

Figure 39 – Storefront Balcony Small

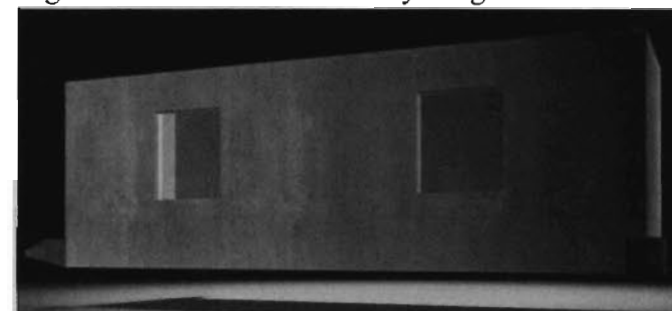
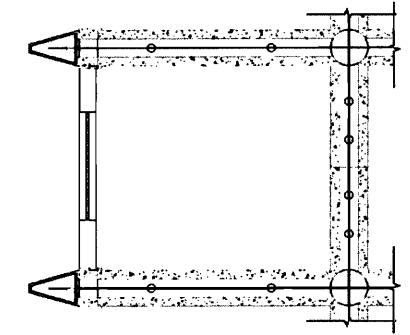
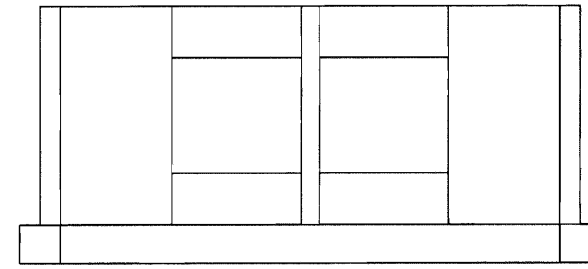
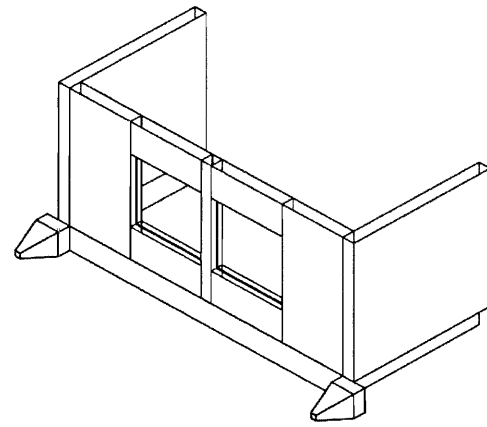

Figure 40 – Walled Balcony Large

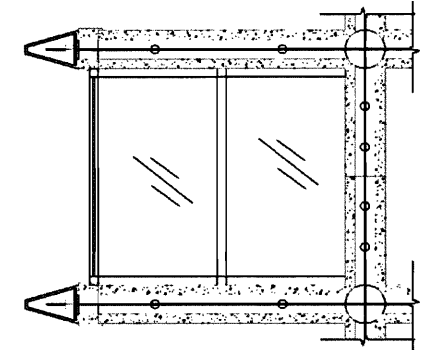
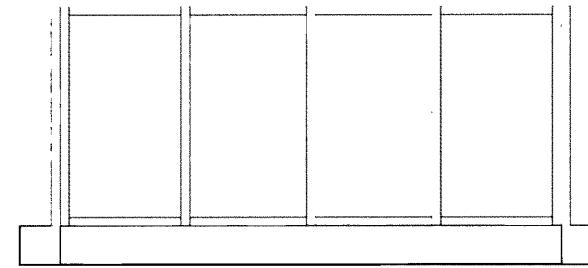
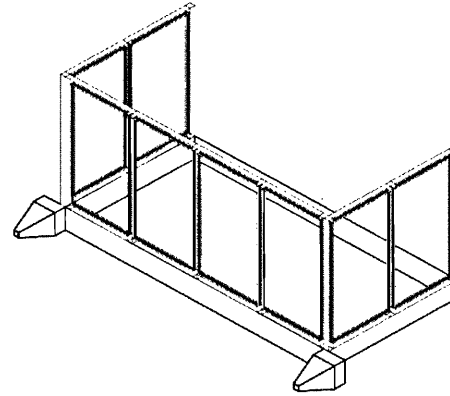

Figure 41 – Walled Balcony Small

Walled Balcony



Storefront Balcony



Louvered Balcony

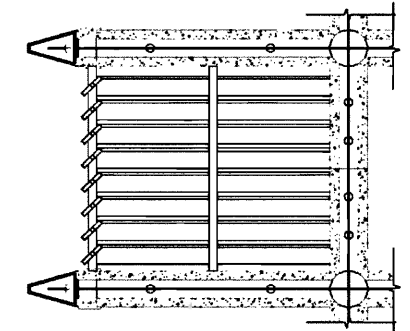
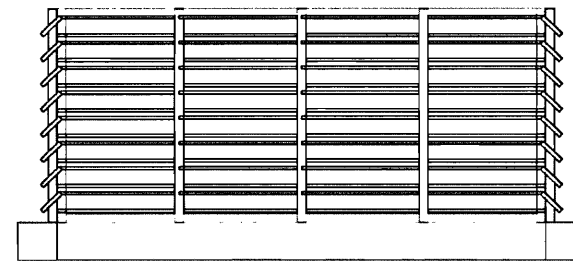
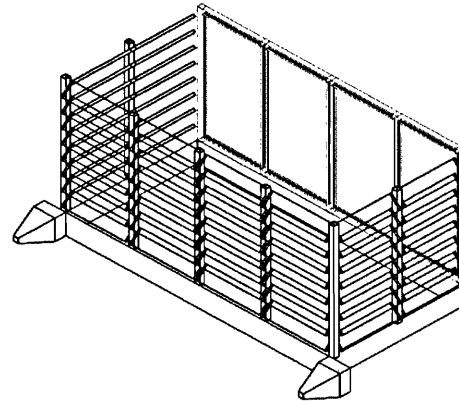

Railing Balcony

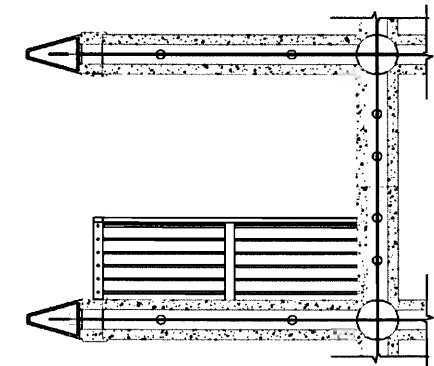
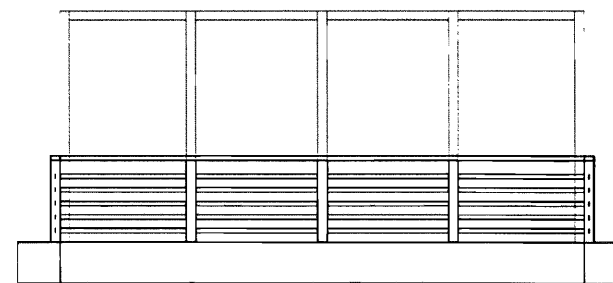
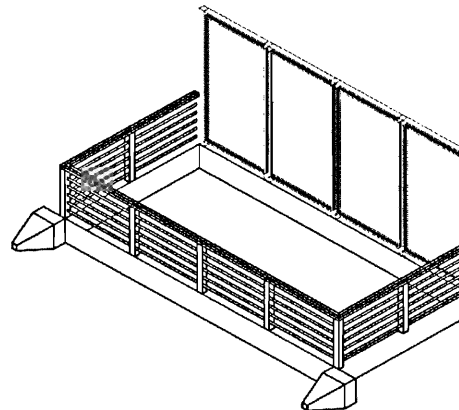

Figure 42 – Balcony Family

PROCESS

The design of each piece gives special attention to the method by which they would be assembled. Their relationship with each other in the assembly process was key to the viability of the system. In order to enhance productivity during the construction process, I developed a limited typology of units that enables assembly to be greatly simplified. This ease translates into a shorter and less costly construction time (See Figure 43). The manufacture of the construction unit takes place in a factory where it is cast and assembled by conventional means. Its size was a consideration when being transported to the site. A pre-cast piece too large for a truck would be problematic. After arriving to the site, the units are stored according to type and arranged so they can be hoisted easily onto the building. Two types of cranes are used. The first type is assembled within the elevator core. This crane will stay with the building to be used when needed to disassemble or reassemble parts over the life of the structure. The other cranes will be temporary conventional cranes placed around the perimeter of the site.

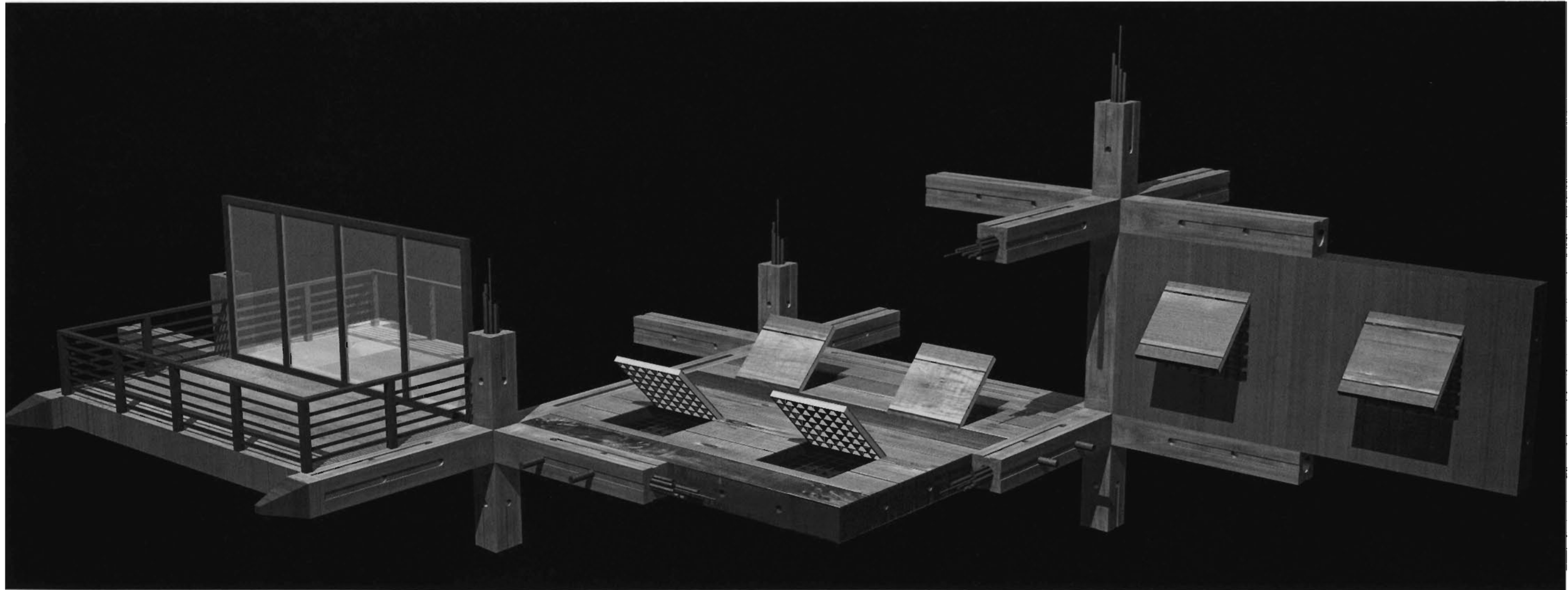

Figure 43 – Full Assembly

Due to the nature of the connections employed, the construction system dictates that the floor and structural systems be assembled together. A small crew of four to five laborers quickly pins the floor plates to the Cartesian structural units while the cranes hold the pieces in place. One crewmember is responsible for connecting the structural members to each side of the floor plate. Because of the ease of the pin connection, workers should be able to assemble pieces as quickly as the cranes can place them. The more cranes that can be used, the faster the assembly process. This connection method is repeated until the building structure is complete. Once

this is accomplished, the building is ready to accept finishes and equipment. Specialized pieces can be quickly connected to the aluminum mesh exposed on the floor and wall plates in the residential unit. Finishes can be removed and replaced easily by the same process, allowing a high level of customization for apartment tenants.

Through this process a significant amount of time is saved in the construction process, and the system becomes a viable alternative to current construction techniques.

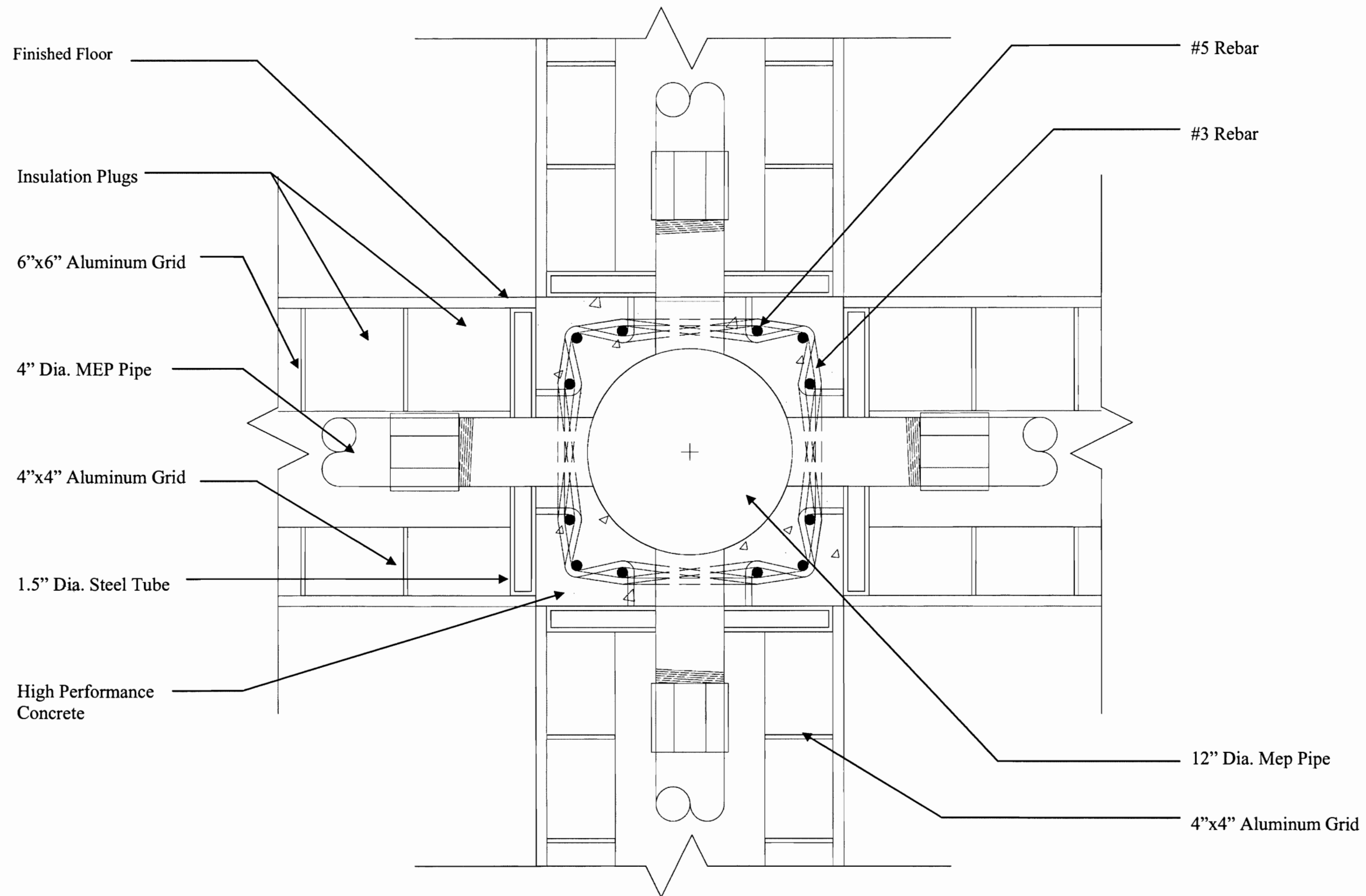

Figure 44 – Assembly Detail

Here is a column or beam section detail with walls or floors on all sides (See Figure 44). This detail shows a beam or column section through which there is no wall on one side. Instead, a structural cap replaces the wall. This cap performs the same connection that the plates would accomplish in its place (See Figure 45).

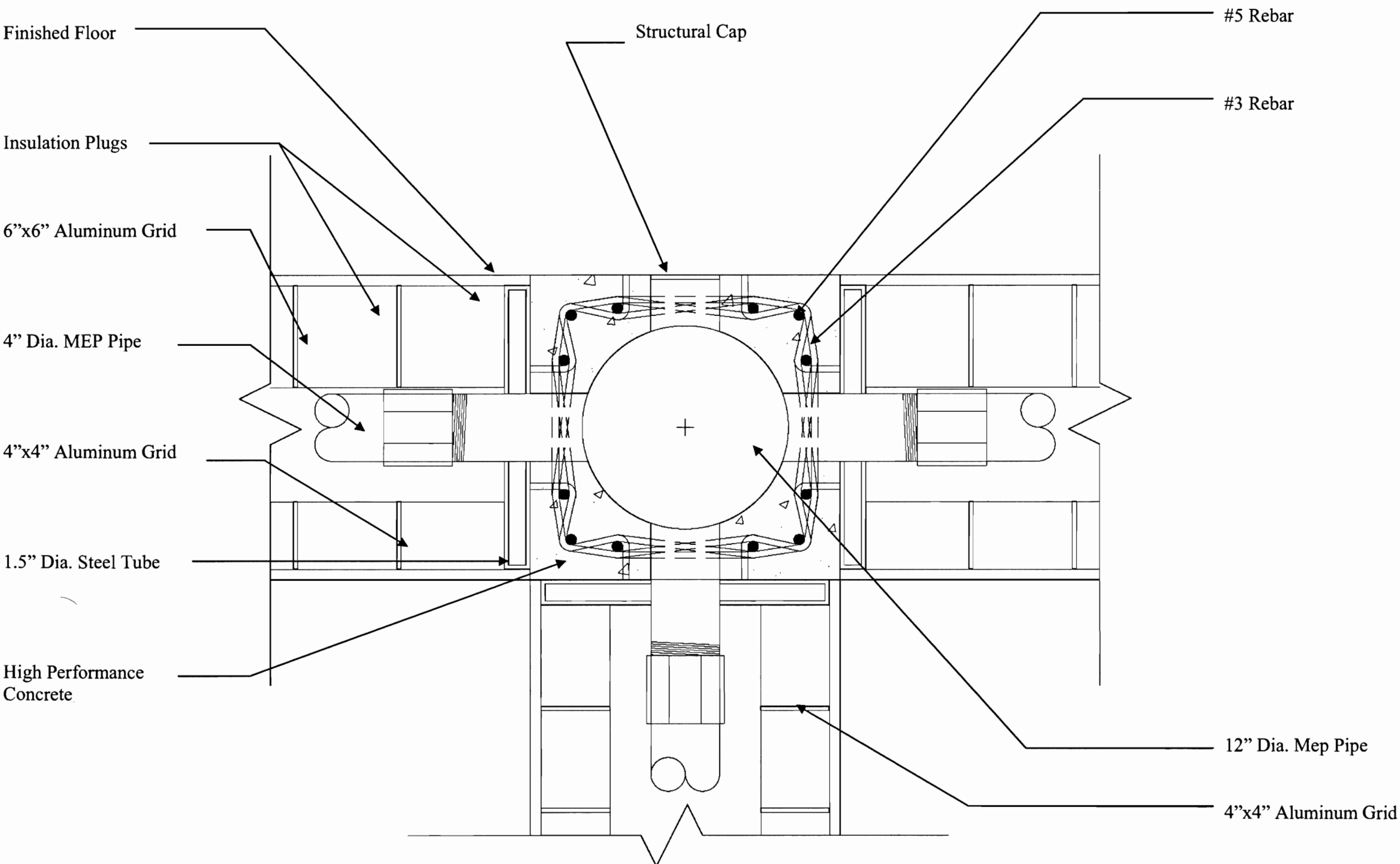

Figure 45 – Assembly Detail

Here is a detail that explains the method by which the floor plate slides between two beams. Once in place the access panels are opened and the MEP pipes are slid into the beams connecting the plate. The result is seen in the section below (See Figures 46-53).

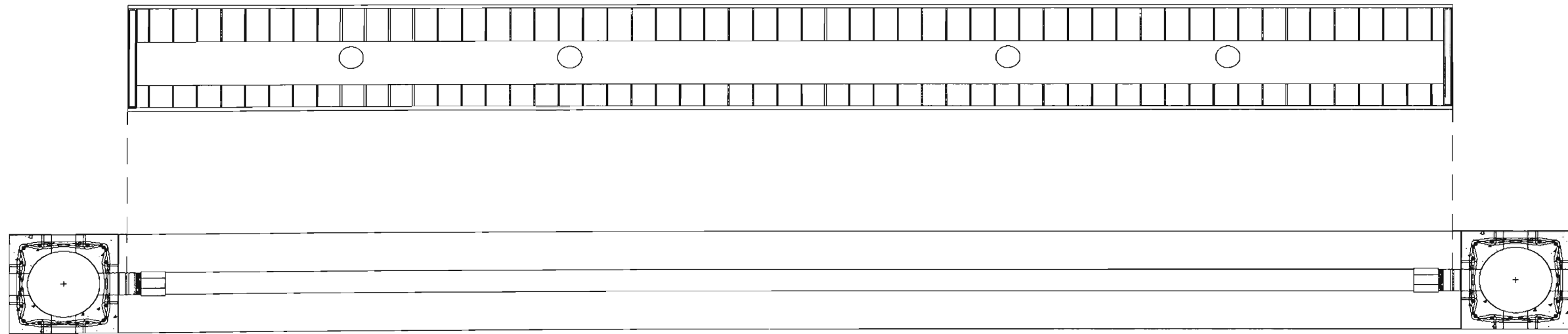

Figure 46 – Assembly Detail

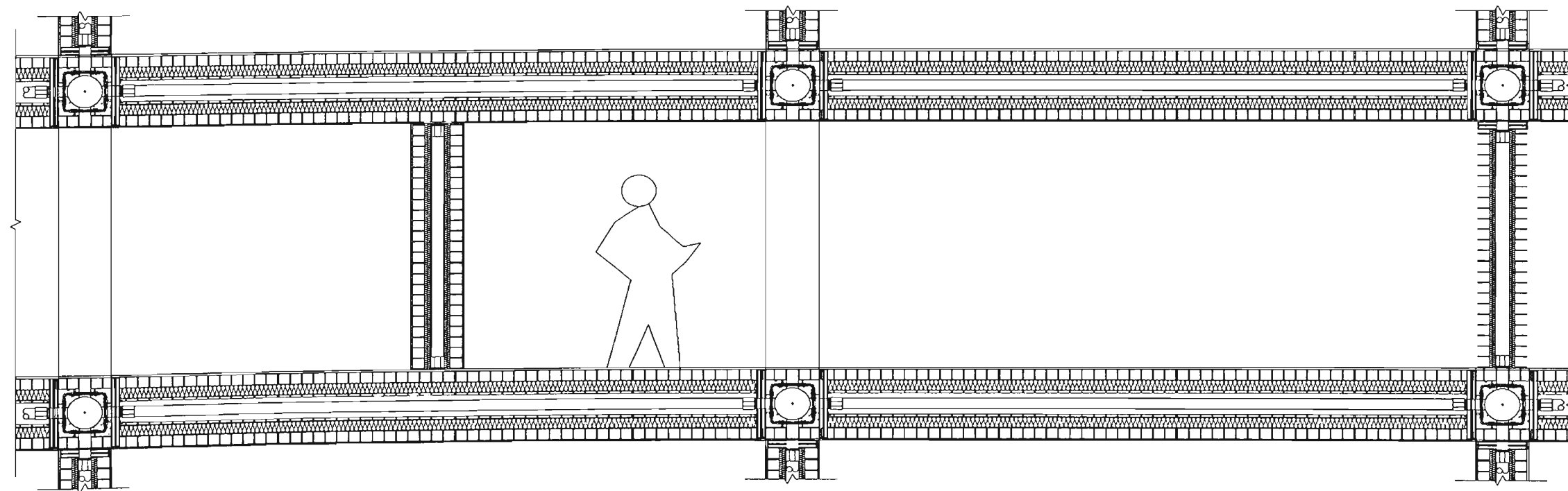

Figure 47 – Unit Section Detail

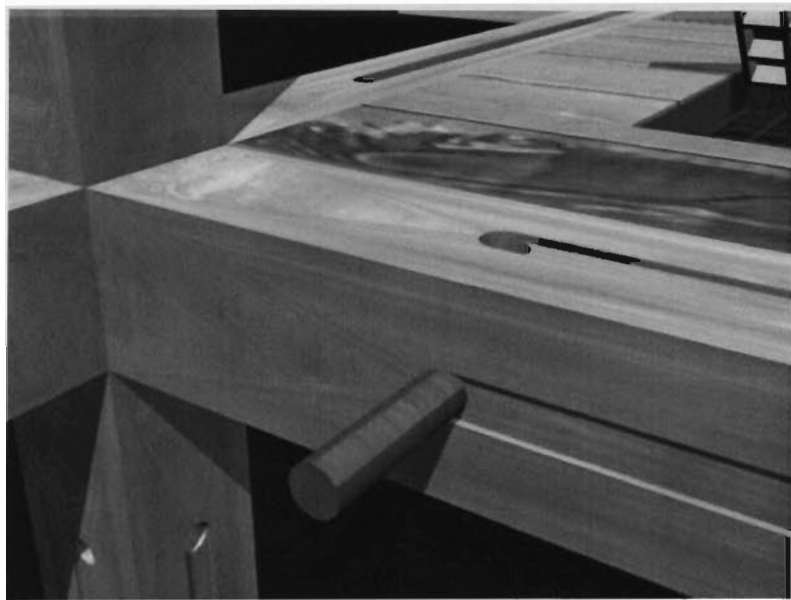

Figure 48 – Assembly Detail

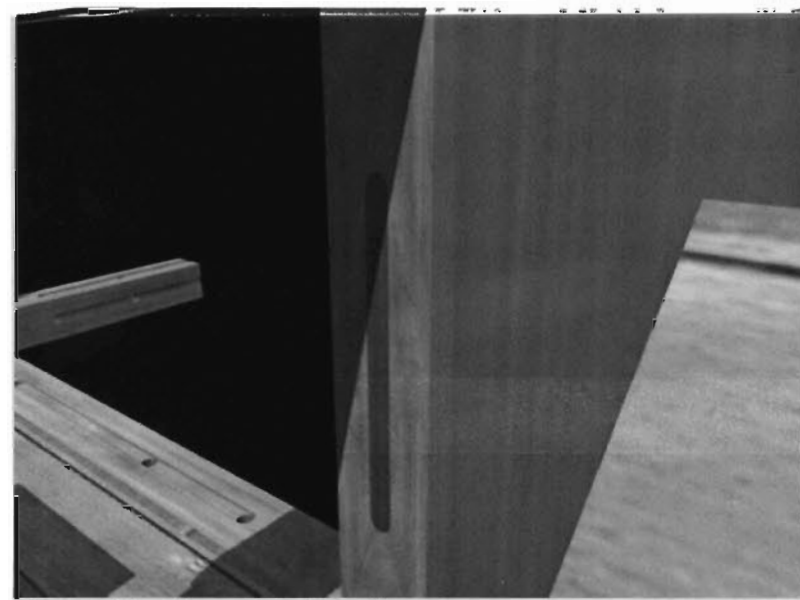

Figure 49 – Assembly Detail

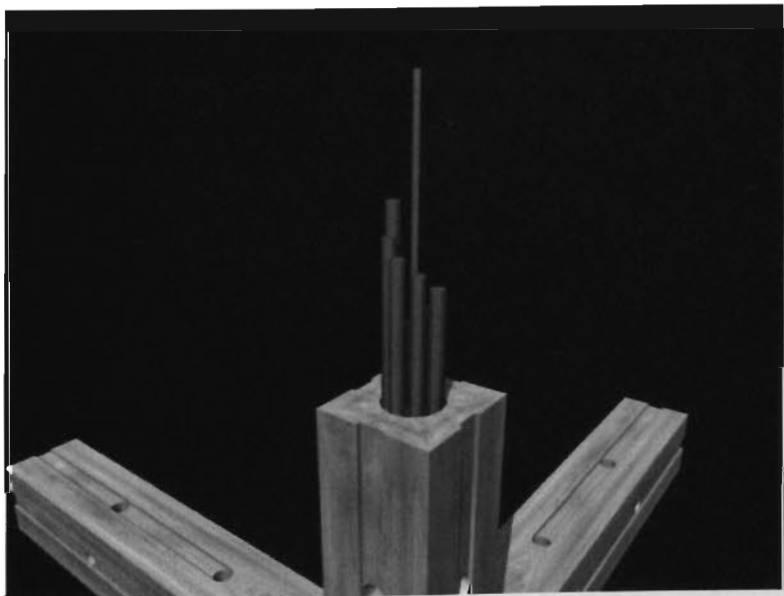

Figure 50 – Assembly Detail

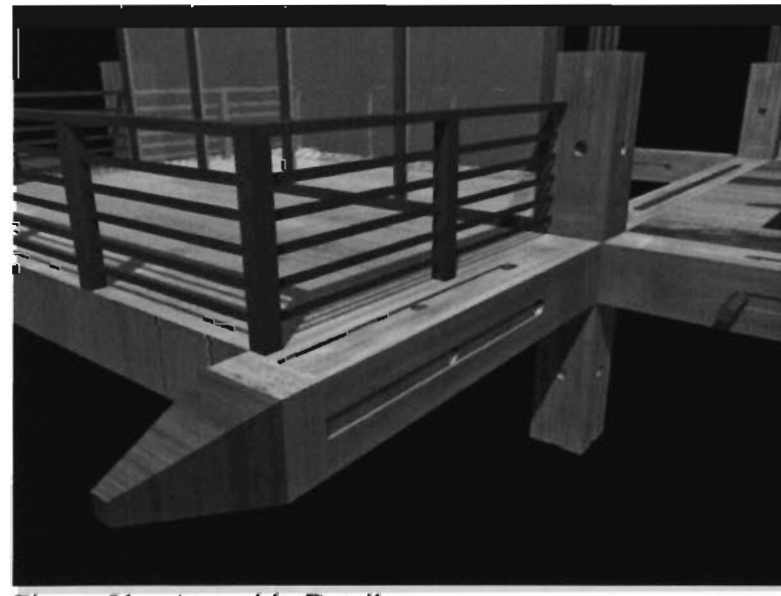

Figure 51 – Assembly Detail

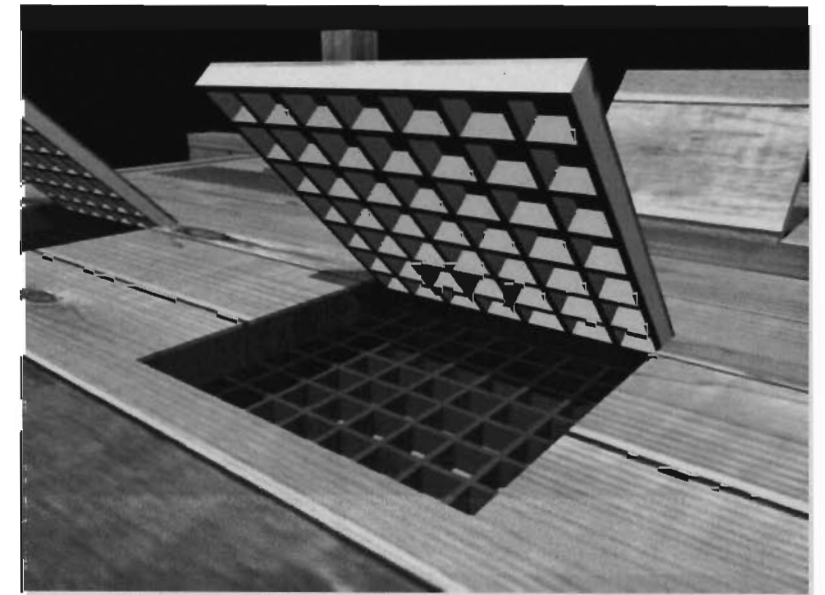

Figure 52 – Assembly Detail

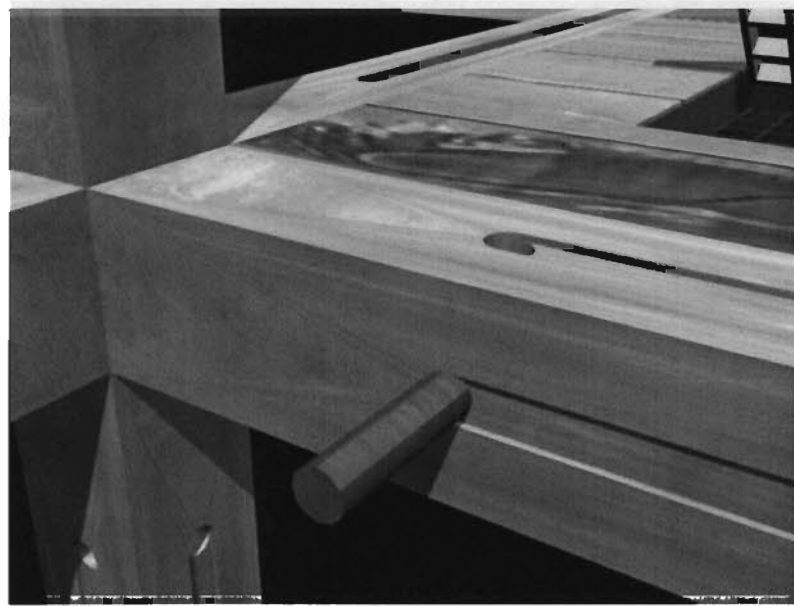

Figure 48 – Assembly Detail

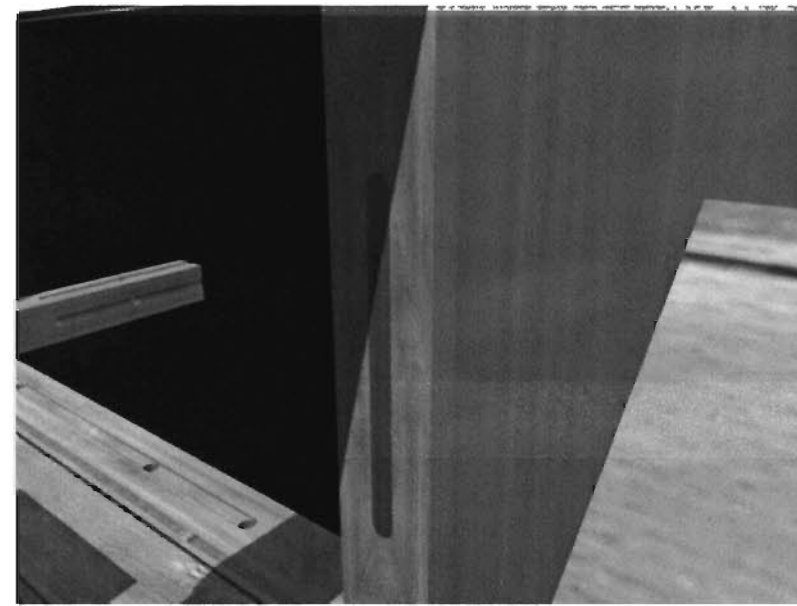

Figure 49 – Assembly Detail

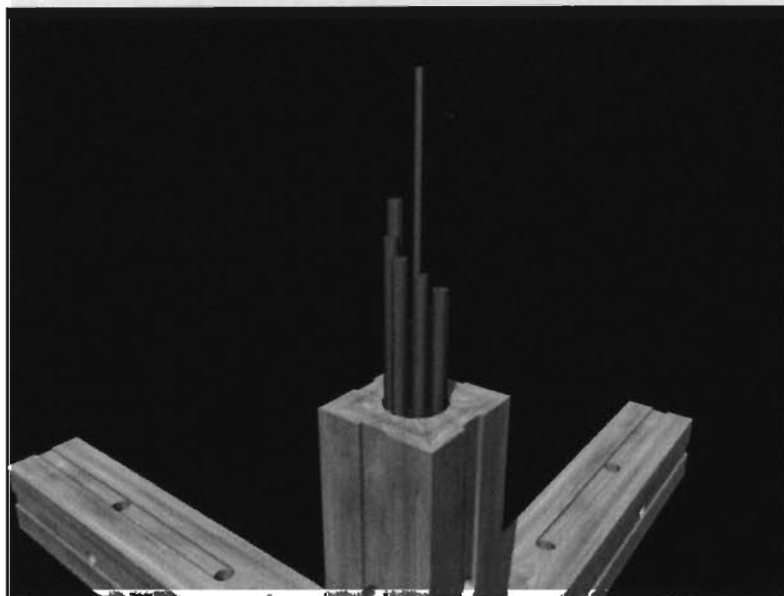

Figure 50 – Assembly Detail



Figure 51 – Assembly Detail

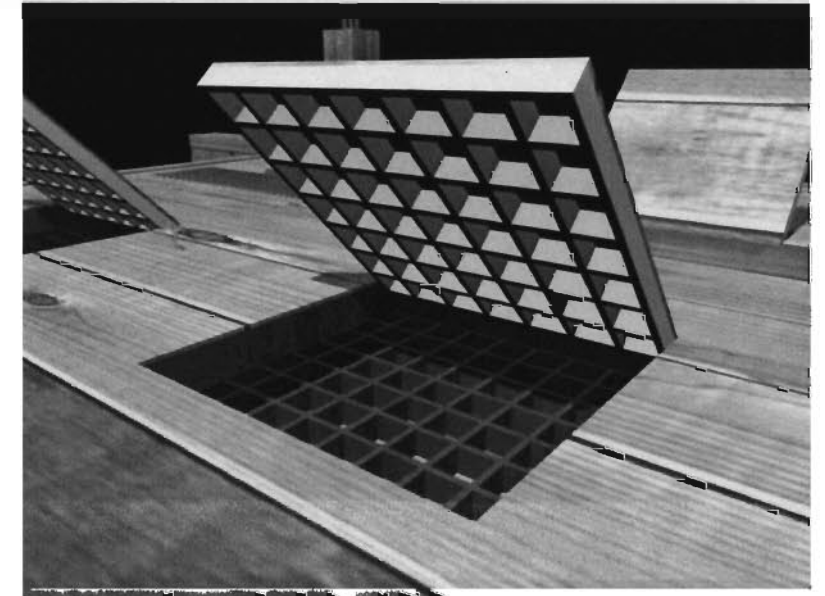

Figure 52 – Assembly Detail

Below is a framing plan which shows a typical floor layout and the pieces that are used to construct it. (See Figure 53).

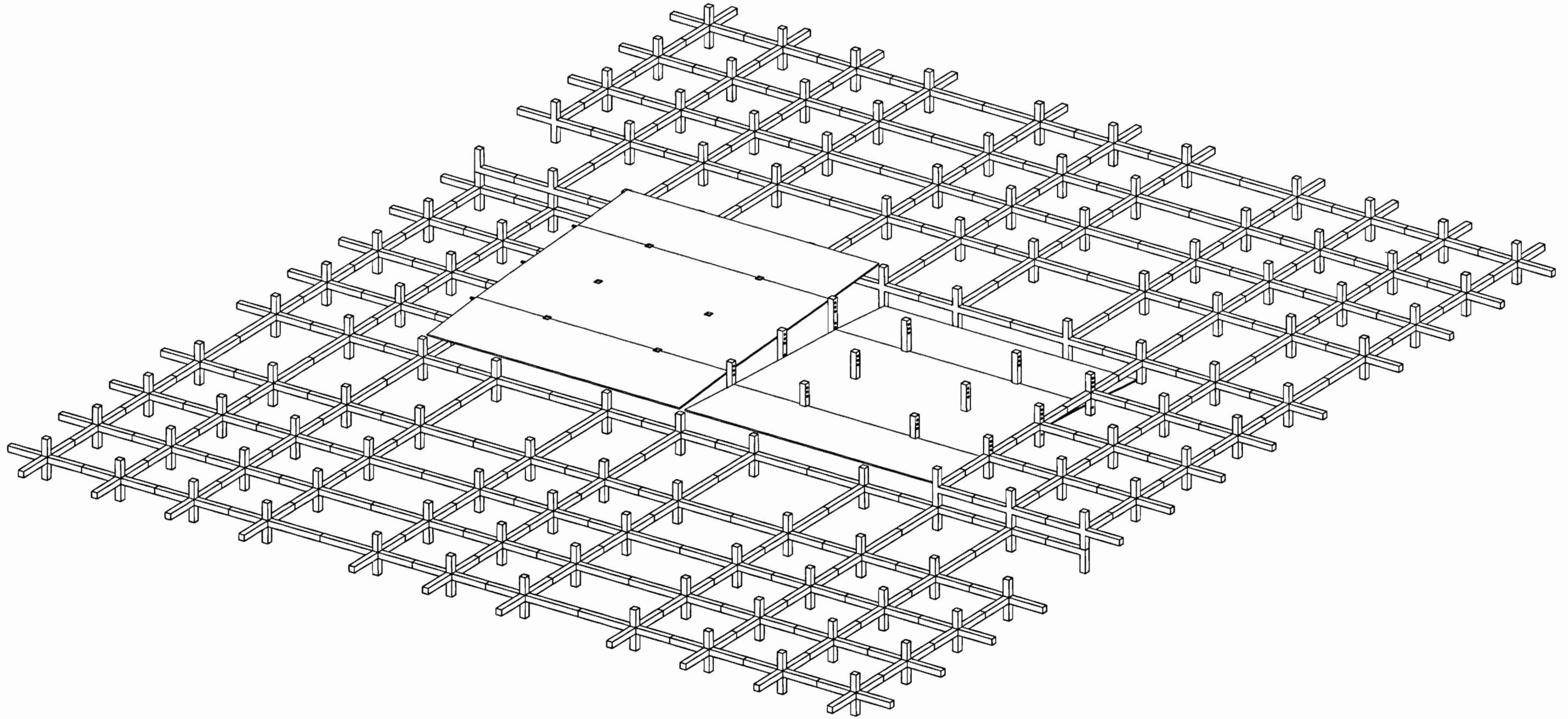

Figure 53 – Framing Axonometric

ADAPTABILITY

This system allows flexibility of use as well as variation within the urban fabric. Conventional forms of construction tend to be either flexible or easy to build (See Figure 54). Standard pre-cast modules are designed with specific rigid forms, so they are limited in flexibility. On the other hand, site cast concrete, iron frame or wood frame construction, while highly flexible, are labor-intensive to assemble.³ My design occupies the middle of this spectrum. It finds its niche as a highly flexible and easily assembled module that has yet to be explored and developed in urban residential construction. Each module is identical, so it can be recycled and reused in another place in the building or in another building. The permanent cranes left atop the elevator can assist in the recycling of these units with speed and economy. Enabling the building to be easily recycled allows the owner and tenant to respond with fluidity to changes within the urban landscape and adds a layer of economic flexibility to the entire system.



Figure 54 – Example Rendering

ECONOMIC VIABILITY

The economic viability of the system is crucial to its success. Kit-of-parts systems have been traditionally cost effective, if built in sufficient volume.⁴ Any replication procedure is high on the front end, meaning that the first of these buildings will be more expensive than conventional construction; however, as more and more modules are manufactured, the cost will come down, making the assembly of these urban residential building fast and lucrative. Modular construction is a huge time saver. The less time needed for construction, the more labor costs are reduced and the sooner investors are able to reap a profit. Factory construction of parts allows site preparation to proceed simultaneously, followed by quick on-site assembly. The economic viability of a modular system is found in the ease and speed by which the buildings are assembled (See Figure 55).

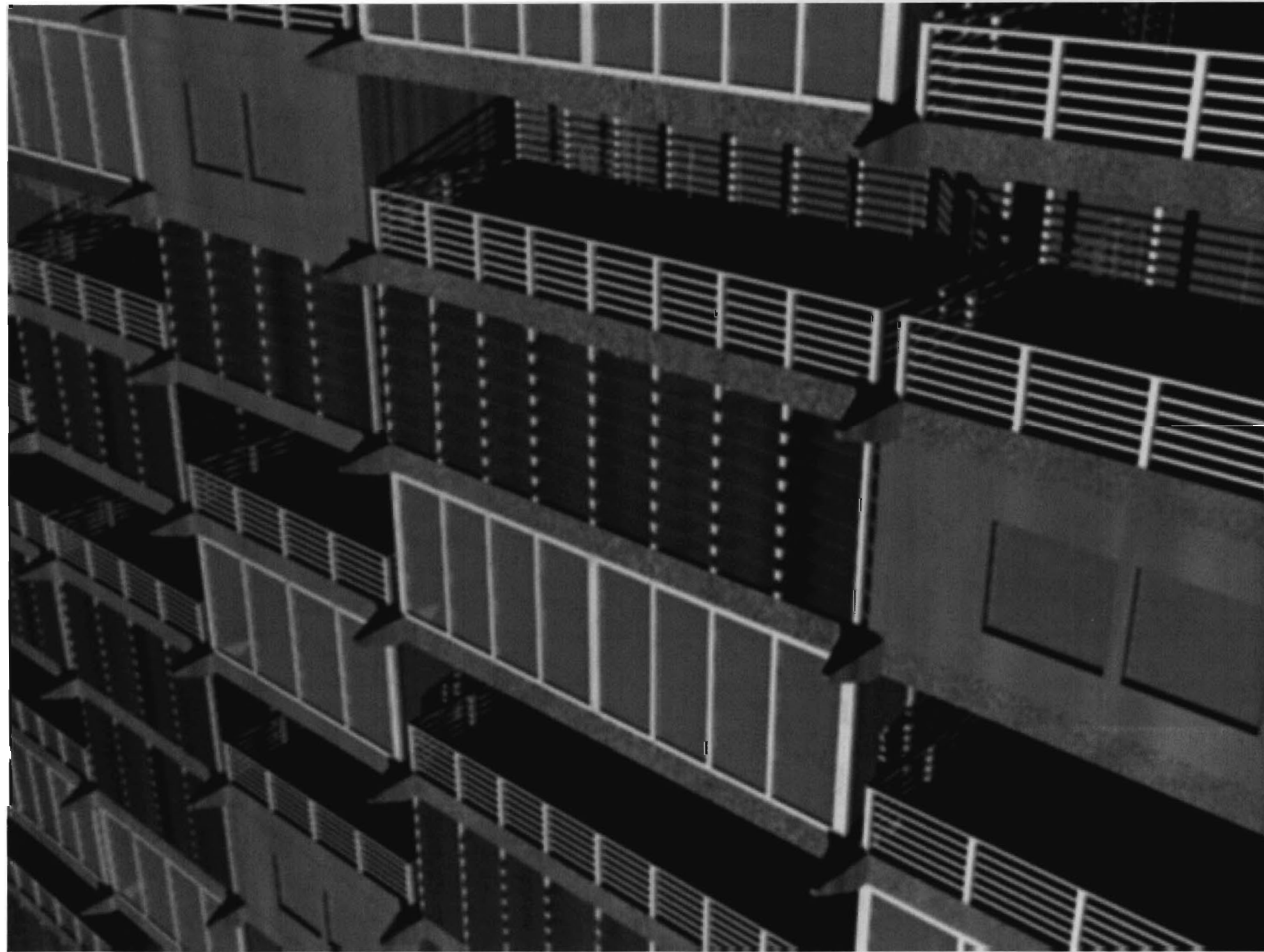

Figure 55 – Building Rendering – Close up

PROTOTYPE

This construction system can be used to build a residential apartment building quickly and easily. This prototype is meant to display the maximum capability of the system. The residential complex has twenty floors, the maximum allowed within the confines of the cross structural unit. There are sixteen units per floor: four double units and twelve singles. The parking garage extends through the building center and has sixty to sixty four parking spaces per floor depending on the needs for accessibility (See Figures 55-71).

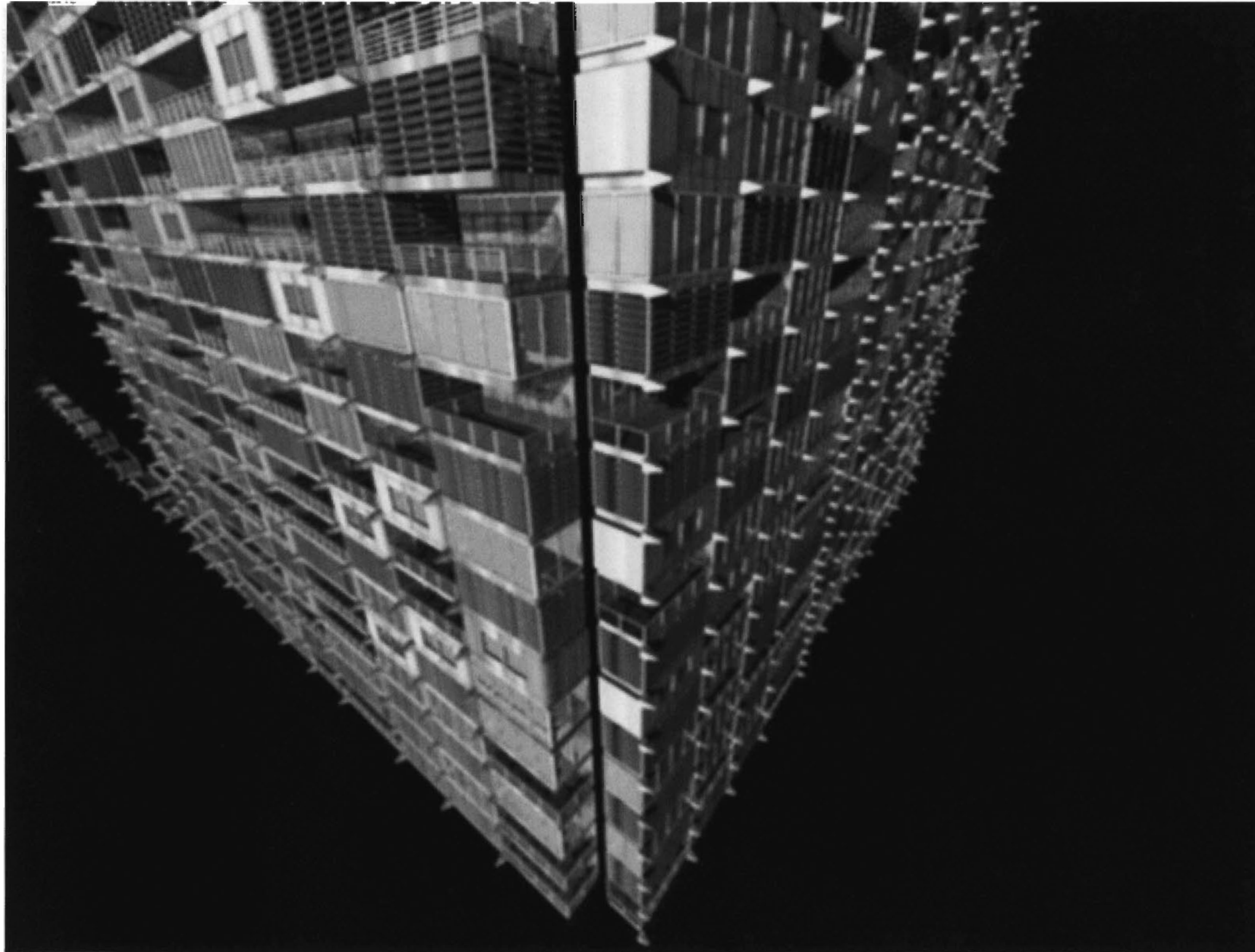

Figure 56 – Building Rendering

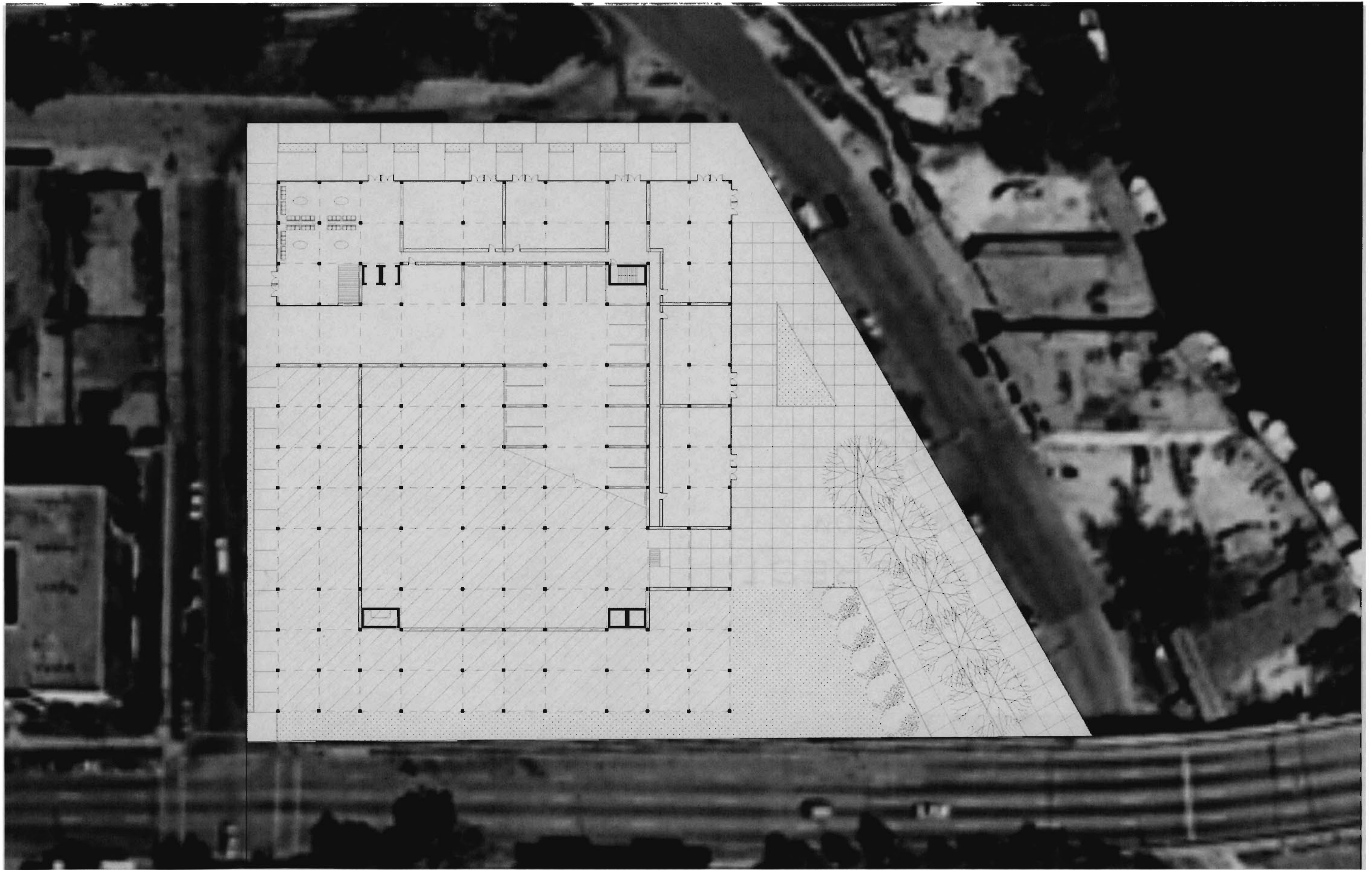

Figure 57 – Site Plan

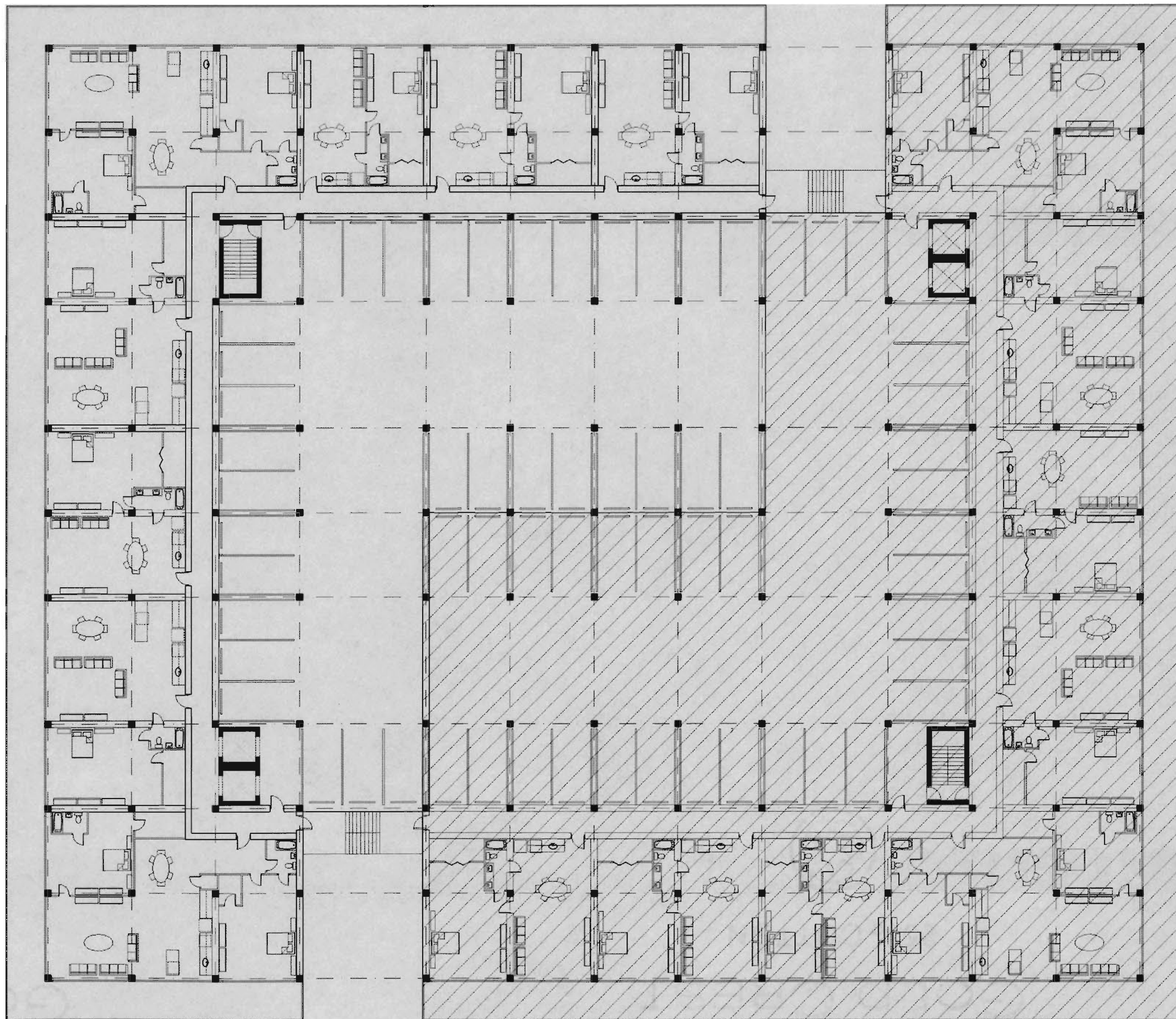

Figure 58 – Typical Plan A

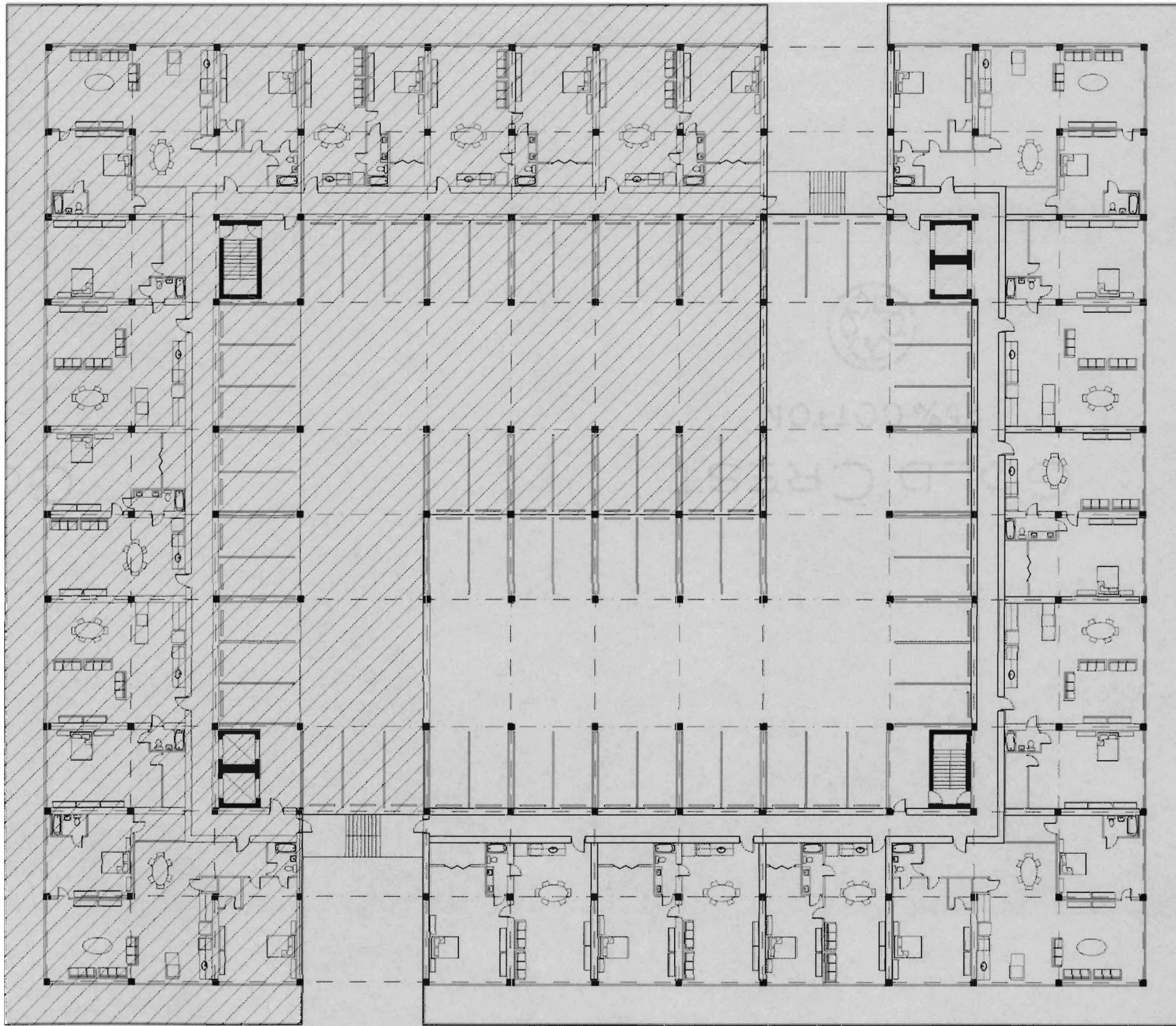

Figure 59 – Typical Plan B

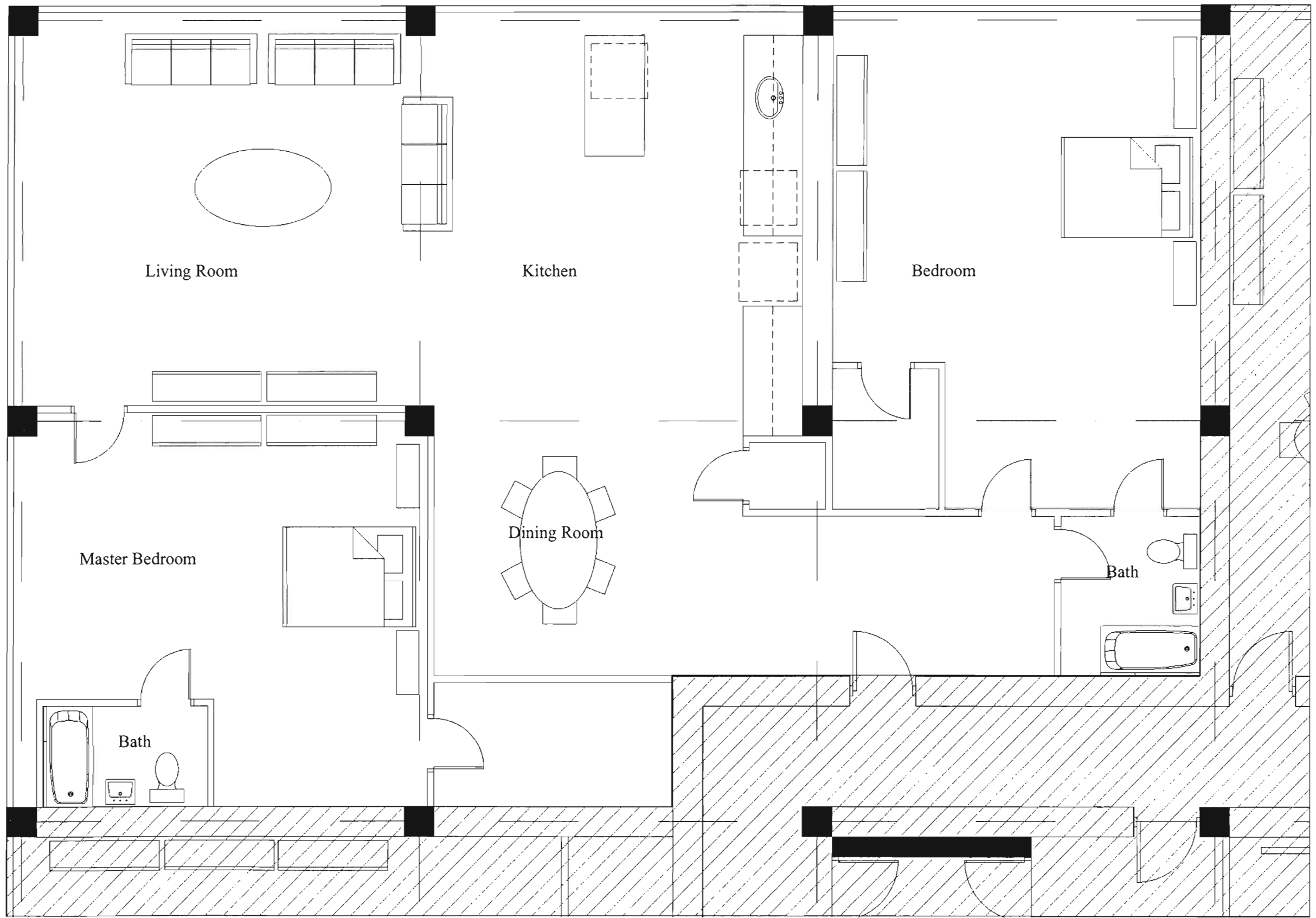

Figure 60 – Typical Double Unit

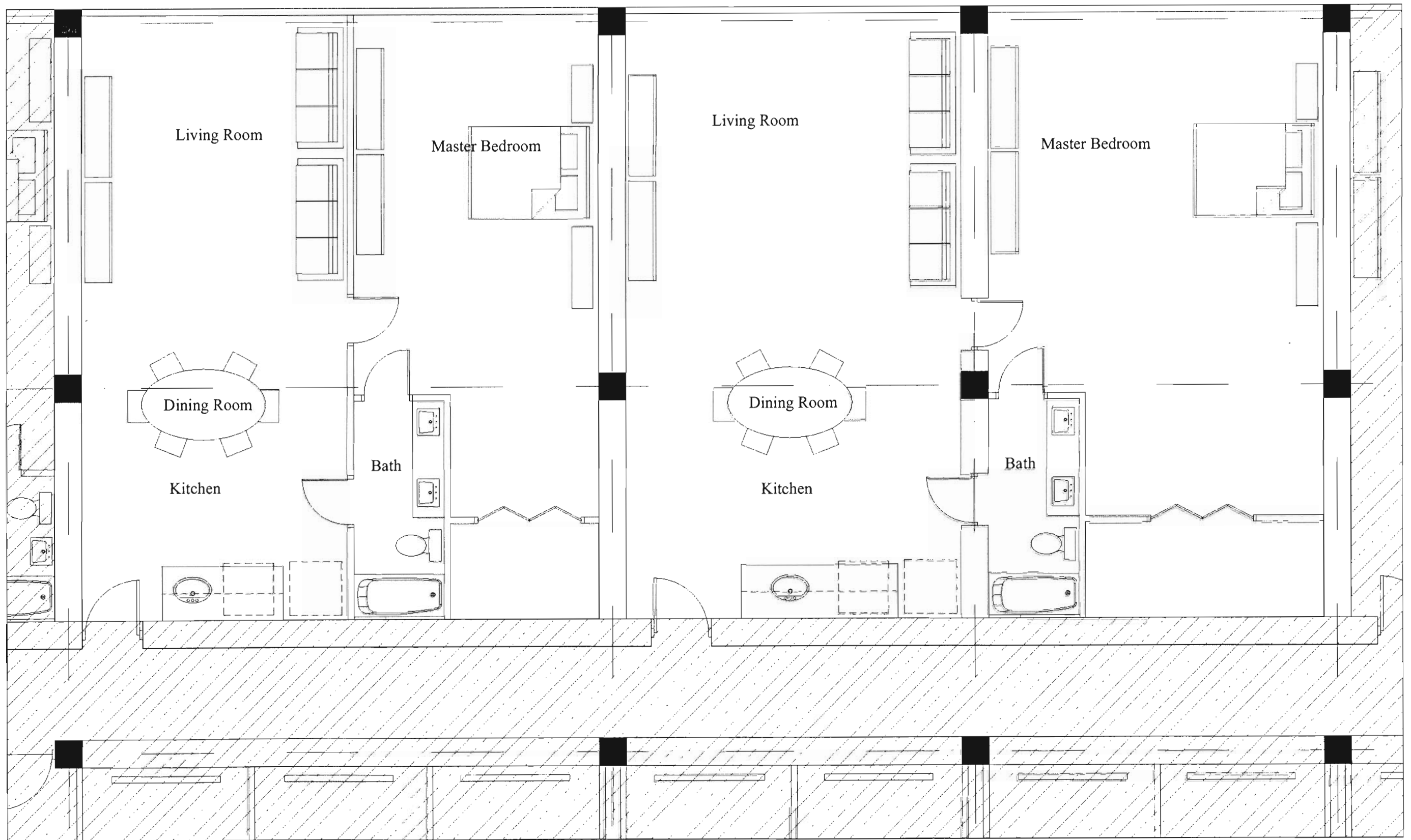

Figure 61 – Typical Single Unit A and B



Figure 62 – North Elevation



Figure 63 – South Elevation

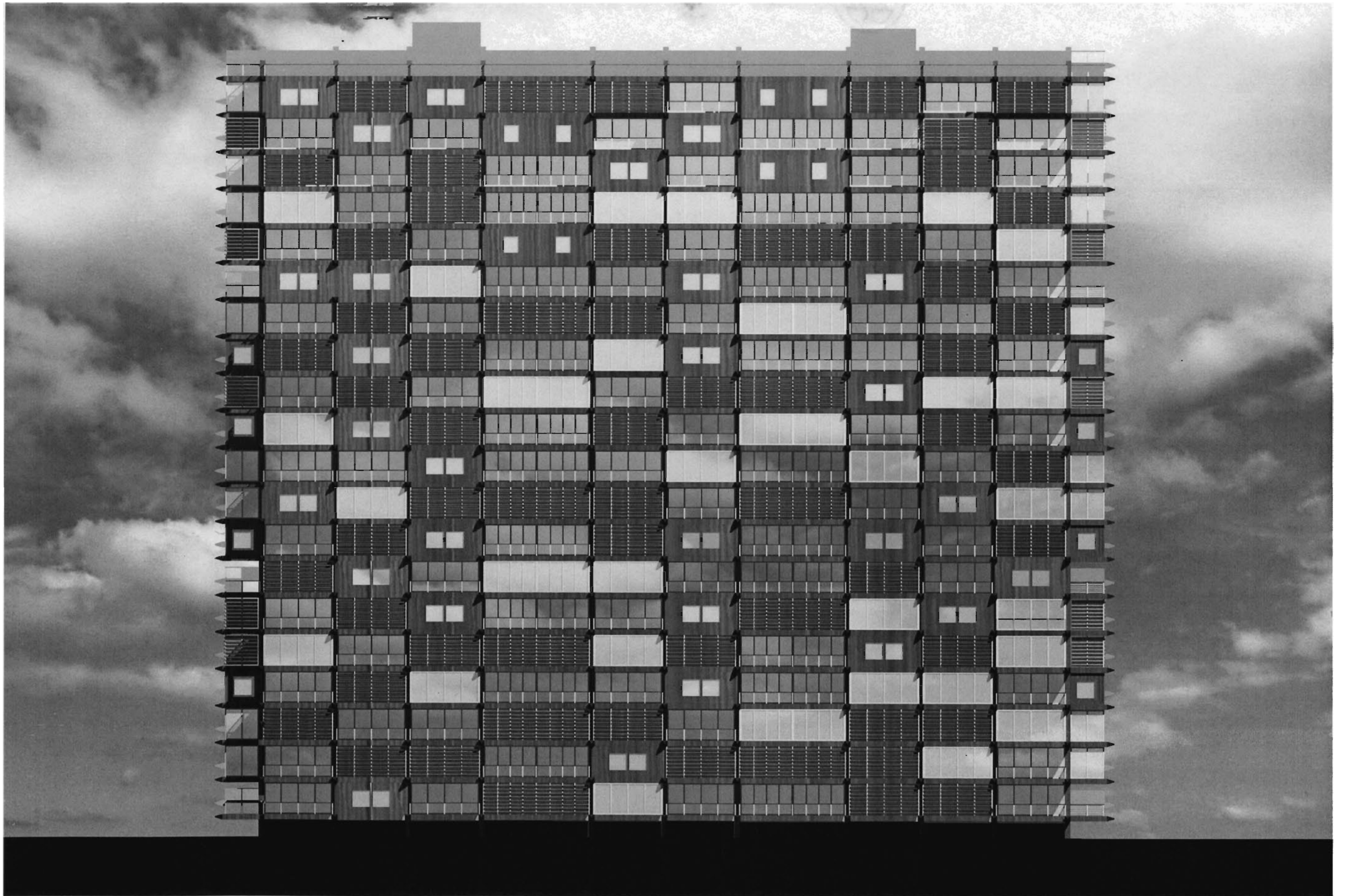

Figure 64 – East Elevation

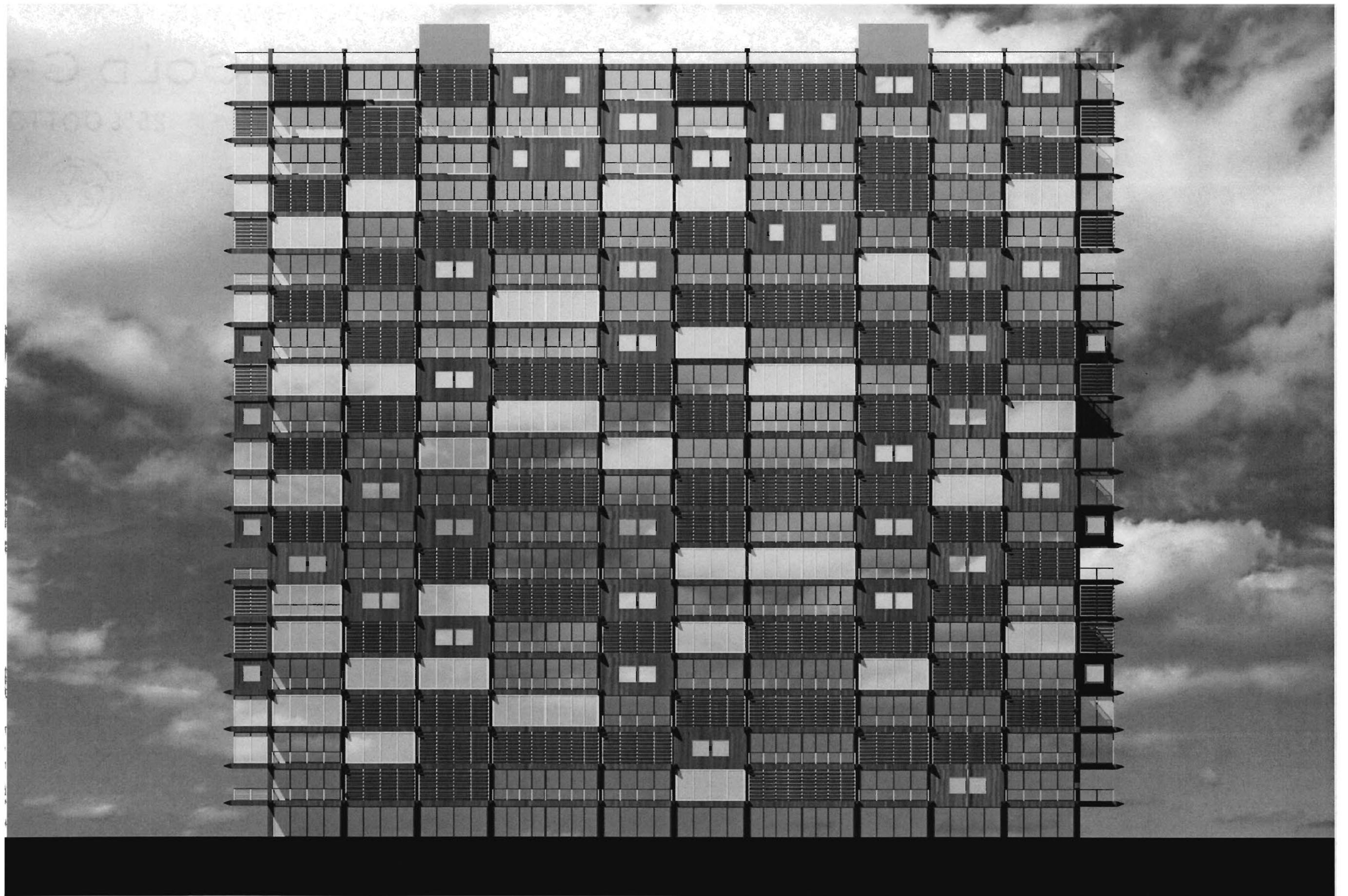

Figure 65 – West Elevation

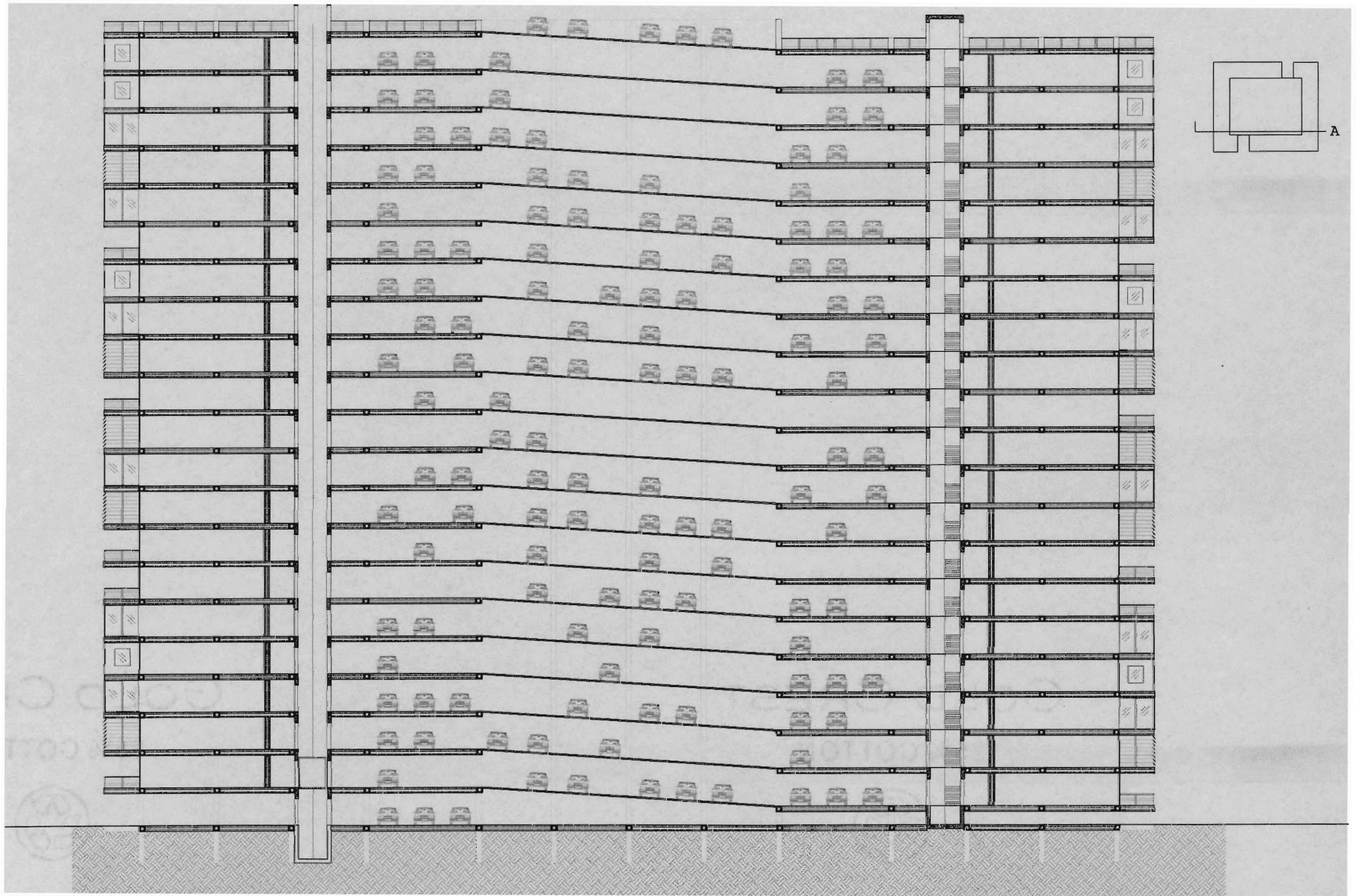

Figure 66 – Section A

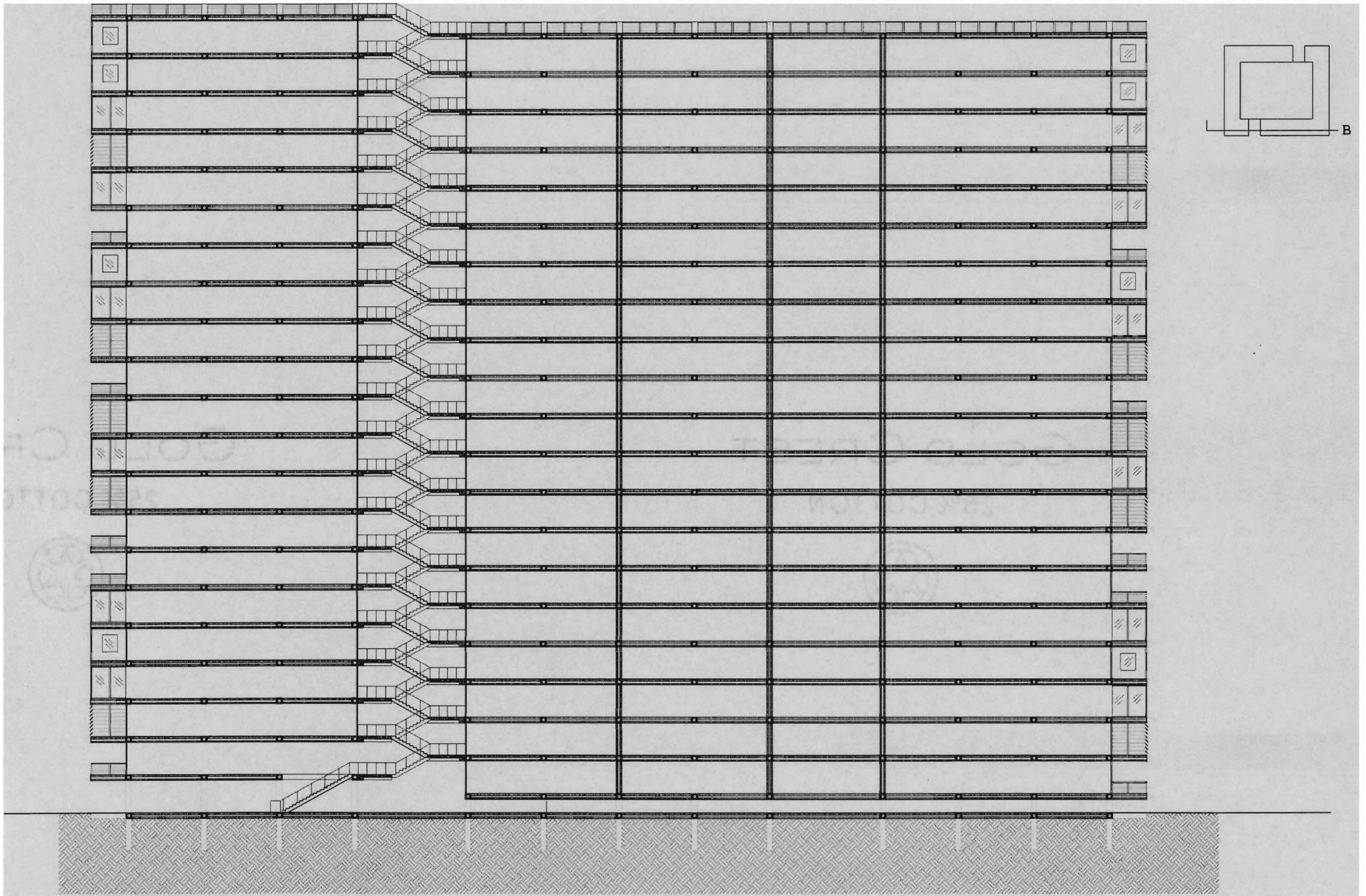

Figure 67 – Section B

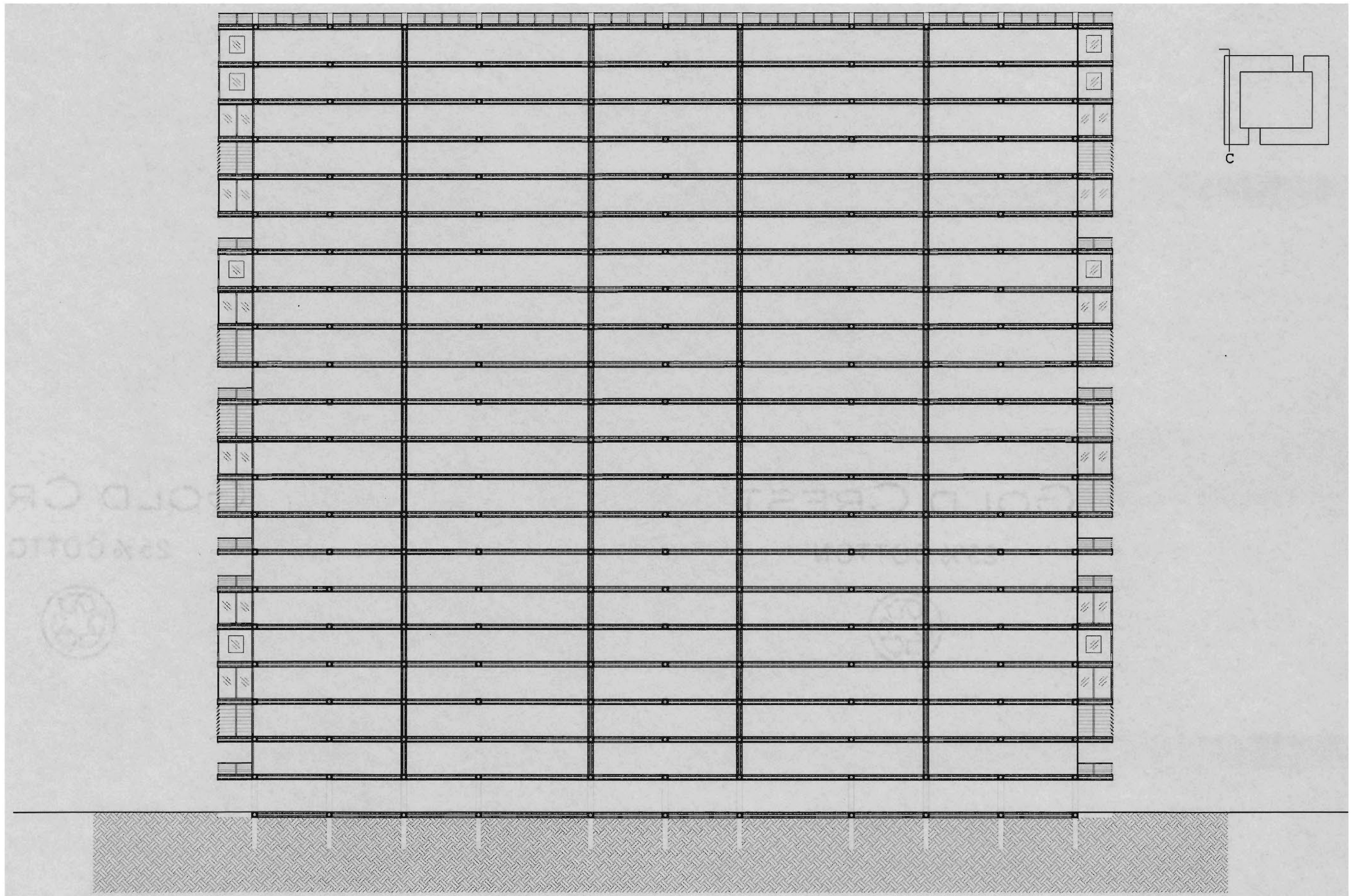

Figure 68 – Section C

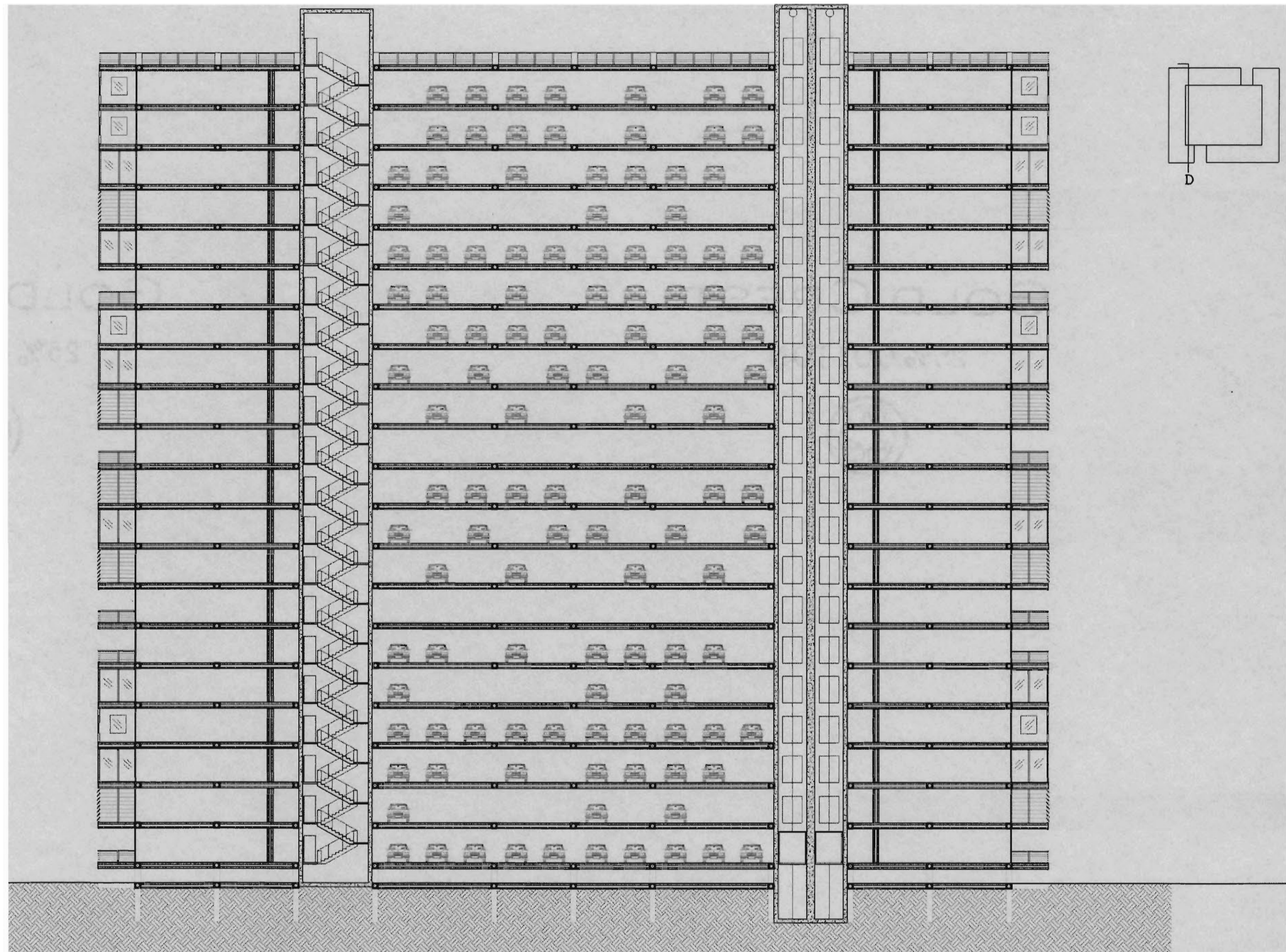

Figure 69 – Section D

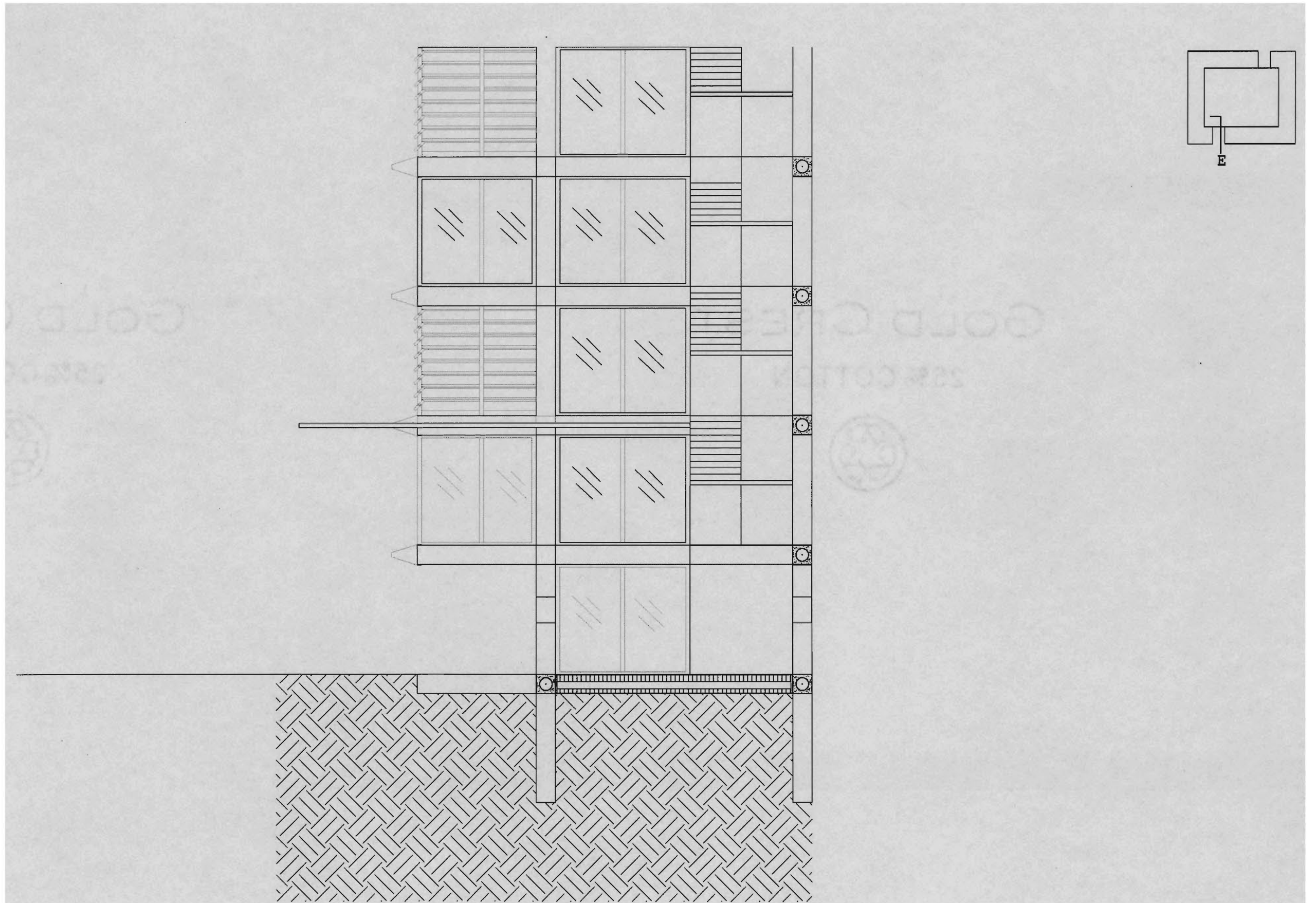

Figure 70 – Section E

CONCLUSION

What problems in society might this system solve? It is possible that an urban renewal based on an aggressive modular system could begin to counteract urban sprawl.

If the modular system were implemented in our cities, taking advantage of the current urban infrastructure, by building vertically rather than horizontally, the urban sprawl epidemic would be lessened. The building unit would create an easy and effective way of making buildings and possibly connecting them physically to create a larger mega-complex. This thesis documents that a kit-of-parts system can create a thriving low-cost community which is both beneficial to its inhabitants as well as lucrative for its developers.



Figure 71 – Final Building

BIBLIOGRAPHY

- A.E.J. Morris. Pre-cast Concrete in Architecture. New York: Whitney Library of Design, 1978 p.270
- Allen, Edmund. Fundamentals in Building Construction Second Edition. New York: Wiley-Interscience, 1990 pp.366,442
- Alvarez, Leonardo, Ford , Joseph. Places in Time : Historic Architecture and Landscapes of Miami. Miami, FL : Florida International University, School of Design, c1994.
- Burayidi, Michael A.. Downtowns : Revitalizing the Centers of Small Urban Communities. New York : Routledge, 2001.
- Dunlop, Beth. Miami : Trends and Traditions New York : Monacelli Press, 1996.
- Ebenezer Howard, Frank Lloyd Wright, and Le Corbusier / Robert Fishman. Urban utopias in the twentieth century New York : Basic Books, c1977.
- Fritz W. Wagner, Timothy E. Joder, Anthony J. Mumphrey, Jr. Human Capital Investment for Central City Revitalization. New York : Routledge, 2003.
- Gosling, David. The Evolution of American Urban Design : a chronological anthology. Chichester ; Hoboken, NJ : Wiley-Academy, 2003.
- Gugler, Josef. The Urban Transformation of the Developing World. Oxford ; New York : Oxford University Press, 1996.
- Hove, Erik van. Networking neighborhoods. Columbia, S.C. : University of South Carolina Press, c2001
- Kenneth Frampton and Yukio Futagawa. Modern Architecture 1851-1945. New York: Rizzoli, 1983
- Kolson, Kenneth. Big plans : the Allure and Folly of Urban Design. Baltimore : Johns Hopkins University Press, 2001.
- Kurokawa, Kisho. Metabolism in Architecture. London: Studio Vista, 1977. pp.101-103
- Le Corbusier. Modular 2. Cambridge, Mass: M.I.T. Press, 1958
- Lippman, Katherine M. Downtown Revitalization. Beltsville, Md. : Rural Information Center, National Agricultural Library, [2000]
- Manzanilla, Linda. Emergence and Change in Early Urban Societies. New York : Plenum Press, c1997
- More, Thomas, Sir, Saint. Utopia. Cambridge, U.K. ; New York : Cambridge University Press, 2002.
- Ockman, Joan. Out of Ground Zero : Case Studies in Urban Reinvention. New York : Prestel, c2002.
- Powell, Ken. City Transformed : Urban Architecture at the Beginning of the 21st Century. New York : te Neues, 2000.
- Patricios, Nicholas N. Building Marvelous Miami. Gainesville : University Press of Florida, c1994
- Reyner Banham. Megastructure : Urban Futures of the Recent Past. New York : Harper and Row, 1976
- Rothstein, Edward. Visions of Utopia. New York : Oxford University Press, 2003
- The Livable City : Revitalizing Urban Communities New York : McGraw Hill, 2000
- Von Hoffman, Alexander. House by House, Block by Block : the Rebirth of America's Urban Neighborhoods. Oxford ; New York : Oxford University Press, 2003.
- Williams, Donald C. Urban Sprawl : a Reference Handbook. Santa Barbara, Calif. : ABC-CLIO, c2000.

ENDNOTES

1. Kurokawa, Kisho. Metabolism in Architecture. London: Studio Vista, 1977. pp.101-103
2. Kenneth Frampton and Yukio Futagawa. Modern Architecture 1851-1945. New York: Rizzoli, 1983
3. Edmund Allen. Fundamentals in Building Construction Second Edition. New York: Wiley-Interscience, 1990 pp.366,442
4. A.E.J. Morris. Pre-cast Concrete in Architecture. New York: Whitney Library of Design, 1978 p.270