

EyasSAT: A Revolution in Teaching and Learning Space Systems Engineering

David J. Barnhart⁽¹⁾, Jerry J. Sellers⁽²⁾, Carlee A. Bishop⁽³⁾,
Jesse R. Gossner⁽⁴⁾, James J. White⁽⁵⁾, John B. Clark⁽⁶⁾

⁽¹⁾ Recently with the U. S. Air Force Academy CO 80840. Now at the Surrey Space Centre, University of Surrey, Guildford Surrey GU2 7XH UK (d.barnhart@surrey.ac.uk)

⁽²⁾ Teaching Science & Technology, Inc., 14 Via Piedras, Manitou Springs CO 80829

⁽³⁾ GTRI-ELSYS, Georgia Institute of Technology, Atlanta GA 30332

⁽⁴⁾ National Security Space Institute, 7150 Campus Drive, Colorado Springs CO 80920

⁽⁵⁾ Colorado Satellite Services, 45777 Rampart Rd. Parker CO 80138

⁽⁶⁾ Consultant, 11480 Valle Verde Drive, Colorado Springs CO 80926

ABSTRACT

EyasSAT (patent pending) has transformed the spacecraft systems engineering teaching and learning experience. This new development is a fully functional nanosatellite project that is built up, tested, and “flown” in the classroom. EyasSAT has been used in various space education programs involving high school, undergraduate, and professional students. The overall concept and results from two years of experience are presented.

1.0 Introduction

EyasSAT is a revolutionary concept in space systems engineering education. Up until now, space systems engineering has been typically conducted behind the cloak of clean rooms protecting intellectual property by a select few individuals with millions of dollars at stake. To the contrary, EyasSAT has ushered in an opportunity for large numbers of students with varied backgrounds to build, test, and “fly” a satellite in the classroom, at virtually no financial risk.

The EyasSAT Educational Satellite System (ESS) is not just a set of hardware, but a complete systems engineering experience. Student teams working in the context of an introductory, engineering, or professional short course are guided through virtually the entire satellite acquisition process. After deriving (optionally), understanding, and validating the basic system requirements, students begin the process of verifying test results from hands-on integration against those requirements. By the end of the course, students have worked through all the significant issues associated with each spacecraft subsystem and have a better understanding how they work in concert as a complete spacecraft system.

A brief overview of the EyasSAT development history and system description is presented first, followed by application examples and results from two years’ experience in high school, undergraduate, graduate, and professional short courses. Over 1,500 students now experience EyasSAT annually.

2.0 History of Development

EyasSAT was born out of the need to more effectively teach and learn spacecraft systems engineering across the full spectrum of academia. EyasSAT literally means “baby FalconSAT,” where FalconSAT is the name of the flagship undergraduate-built satellite program at the United States Air Force Academy¹. The USAF Academy has realized three successful FalconSAT missions since 1997 through the SmallSat Engineering capstone design course². Despite these unprecedented successes at the undergraduate level, SmallSat instructors realized students needed a more thorough prerequisite hands-on understanding of space systems engineering³.

Inspired by the Department of Astronautics’ motto “learning space by doing space,” a team of engineers took on the challenge to create an experience that would more thoroughly prepare students for designing, building, and testing satellites. The EyasSAT vision of students working in small teams to build a functional educational satellite was born January 2003.

An analysis of alternatives, considering other educational space systems engineering approaches, was the first step. While the topic of space systems engineering education is not new^{4,5,6}, the topic in general has enjoyed a lot of attention in recent years^{7,8,9,10,11,12}.

The University NanoSAT concept was first explored, where students compete for government funding to design, build and test a satellite that will eventually be launched into space¹³. However, this concept was too long-term, as the projects typically run for several years. Our desired timeline at first was to complete the project within a semester.

The Stanford/Cal Poly CubeSAT concept offers the framework for a space-worthy nanosatellite that has been successful for a handful of universities with more being built¹⁴. This concept was closer to our vision of a module-based system for educational use. However, it only provides a basic structure, power module, data handling module, programming interface, and documentation. The customer must provide their own solar array, communication, attitude control, and payload hardware. In addition, the kit did not seem to lend itself to heavy laboratory use where the unit would be repeatedly assembled and disassembled. Stanford University has also addressed the problem at length on an academic level, but none of these successful spacecraft design education concepts have ever been commercialized¹⁵.

After investigating these ideas, our team quickly realized that a comprehensive in-house solution was required. In addition, the laboratory curriculum had to be developed in parallel. A detailed list of program requirements and specifications was developed to guide and focus the design and development process. A prototype set of hardware and educational materials was developed and fielded by Fall 2003.

EyasSAT was originally designed to supplement the USAF Academy's semester long, junior-level undergraduate Space Mission Analysis and Design (SMAD)¹⁶-based prerequisite Space Systems Engineering Course. However, after seeing the success in the classroom during Fall 2003, colleagues at the National Security Space Institute suggested that EyasSAT could be used in an abbreviated sense to provide a half-day lab component to their month-long Space 200 course. Space 200 is the first course specifically developed to answer the Space Commission's¹⁷ recommendation to develop a cadre of technically competent space professionals. The target audience is Department of Defense (DoD) and national agency civilian and military space system acquirers and operators at the mid-career (8-10 year) point. During Spring 2004, the first Space 200 class experienced EyasSAT at the USAF Academy.

After the success of EyasSAT during Spring 2004, another educational experiment was conducted Summer 2004. During the annual Summer Seminar program, where hundreds of prospective high-school students visit campus, several small groups of students interested in space went through a one-hour EyasSAT hands-on introduction. Seeing the overwhelming enthusiasm of young students who flew EyasSAT, the idea was inserted into the USAF Academy's Introduction to Astronautics course, which is a graduation requirement for all cadets. At the same time, ideas were born to introduce EyasSAT for use in other professional short courses and graduate programs. An interim report was presented at the American Society of Engineering Educators that summer, detailing the course implementation and design of "Revision A"¹⁸. The next section details the design of "Revision B," which was launched Fall 2004.

3.0 System Description and Specifications

EyasSAT demonstrates six traditional satellite subsystems: Structural, Electrical Power (EPS), Data Handling, Communications (Comm), Attitude Determination and Control (ADCS), and Thermal, as shown in Figure 1. It also has the capability to integrate student payloads and other subsystems. Each subsystem is capable of receiving commands and generating telemetry via the graphical user interface (GUI) provided with EyasSAT. Screen shots of each subsystem's GUI interface are included throughout the discussion.

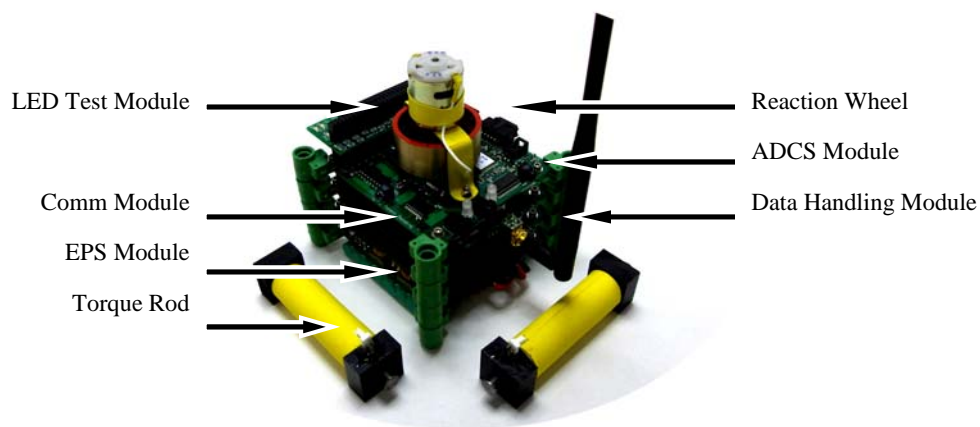

Figure 1. EyasSAT Subsystems

3.1. Structure

The purpose of a typical spacecraft structure is to hold all the other subsystems together during launch and on orbit. Keeping this in mind, the design of the EyasSAT structure was focused on literally eliminating the “black box” thinking of space systems engineering.

A final design was achieved using Plexiglas and thumbscrews for tool-free assembly as shown in Figure 2. In the educational environment, the structure serves to mount and enclose the subsystem module stack, mount the solar and thermal panels, provide lifting point for freefall simulations, protect, and display the final result. The mass budget is highlighted in Table 1 and is compared to the SMAD LightSat missions.



Figure 2. Structure

Dimensions: 19 cm L (7.5 in) x 19 cm W (7.5 in) x 22 cm H (8.5")

Table 1. Mass Budget

Subsystem	Mass (kg)	%	LightSat
Payload (generic)	0.5	17%	24.40%
Structure	0.83	29%	22.70%
EPS	0.67	23%	24.60%
DH	0.13	5%	6.50%
Comm	0.08	3%	6.50%
ADCS	0.59	20%	13.00%
Thermal	0.11	4%	2.00%
Total	2.91	100%	100%

3.2. Electrical Power Subsystem

A spacecraft EPS is typically responsible for four basic functions: providing a power source, storing energy, regulating and controlling power, and finally distributing power. The EyaSAT EPS Module was designed to demonstrate all these functions, while being rugged enough for student laboratory use.

Resilient, inexpensive solar panels were chosen to demonstrate solar power generation, but are not efficient enough to provide primary power. They provide $V_{oc}=18$ VDC, $I_{sc}=120$ mA, peak power of 750 mW at 10 VDC in full sun. The rechargeable battery module provides 8.4 VDC, 1400 mAh.

The power regulation and control module, shown in Figure 3, provides regulated 5 and 3.3 VDC @ 1 A max, either fixed or switchable on command. On board telemetry reports voltage and current status on solar and battery inputs, 5 and 3.3 VDC outputs. Initially, telemetry and commands can be sent between the module and a PC using a simple serial link and is reported via the GUI as shown in Figure 4. Once integrated with other modules, telemetry, commands, and power are handled through the EyaBUS. The physical configuration of the modules conforms to the PC104 standard. However, the EyaBUS configuration is proprietary and does not match that of PC104 and was never intended to do so.

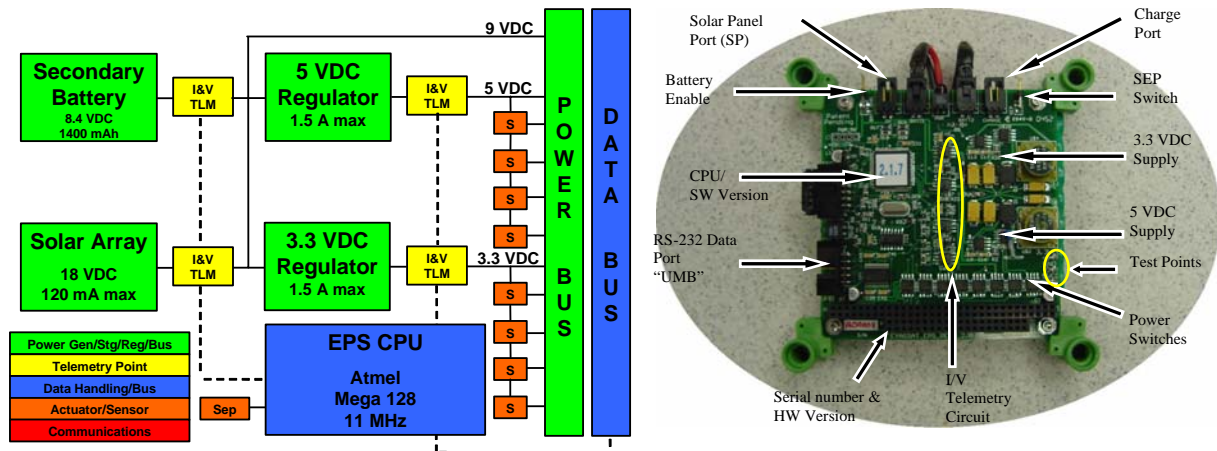

Figure 3. Electrical Power Subsystem Block Diagram and Module

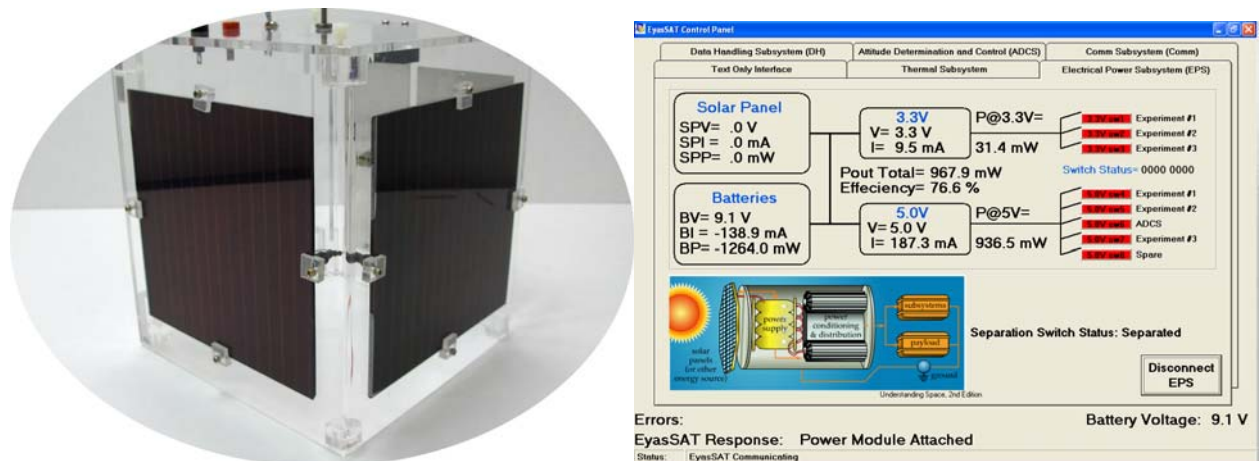

Figure 4. Electrical Power Subsystem Solar panels and GUI Screen. Embedded subsystem diagrams on the GUI screens used throughout this paper are from Understanding Space¹⁹ and can be used as a classroom demonstration and teaching aide

3.3. Data Handling Subsystem

The data handling subsystem is basically the on-board computer for the satellite, responsible for several jobs. It receives, validates, decodes, and distributes commands from the ground, payload, or a subsystem to other spacecraft subsystems. It also gathers, processes, timestamps, and formats spacecraft housekeeping and mission data for downlink or use on board.

The EyasSAT Data Handling Module, shown in Figure 5, was designed to demonstrate and provide this functionality. Similar to the EPS module, the Data Handling module can be initially interfaced by a serial link to a PC. Once integrated with other subsystems, the Data Handling module serves as the master controller of the data bus, which uses the serial peripheral interconnect (SPI) standard. One additional function the module performs, slightly cutting across subsystem boundaries, is to interface with eight thermistors that are distributed throughout EyasSAT to collect temperature data.

All telemetry can be viewed using the basic text interface view of the GUI as shown in Figure 6. The GUI also offers the option to record the data stream of the session for later review or analysis using third party tools, such as Microsoft Excel. Similar to the other subsystems, the Data Handling specific pushbutton commands and telemetry are also shown in Figure 6.

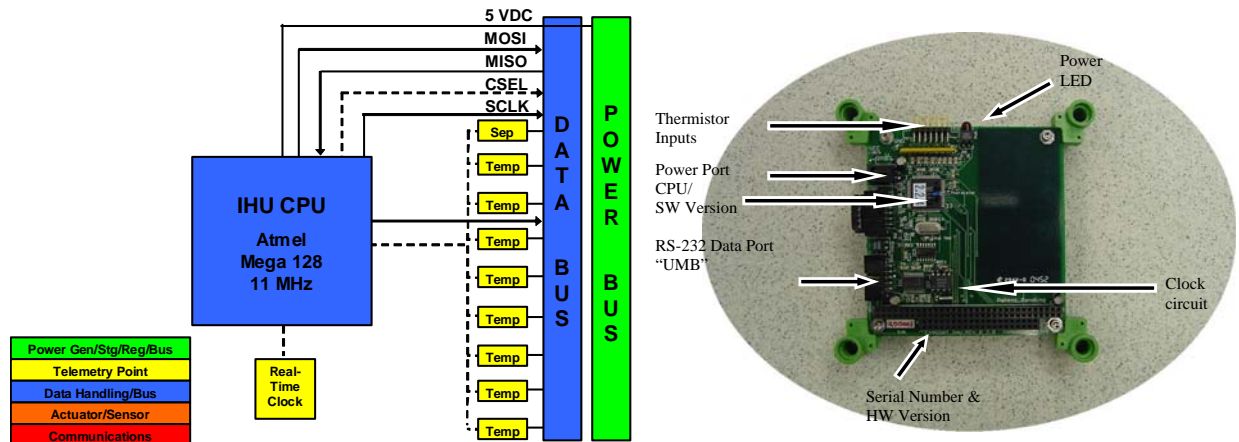

Figure 5. Data Handling Block Diagram and Module

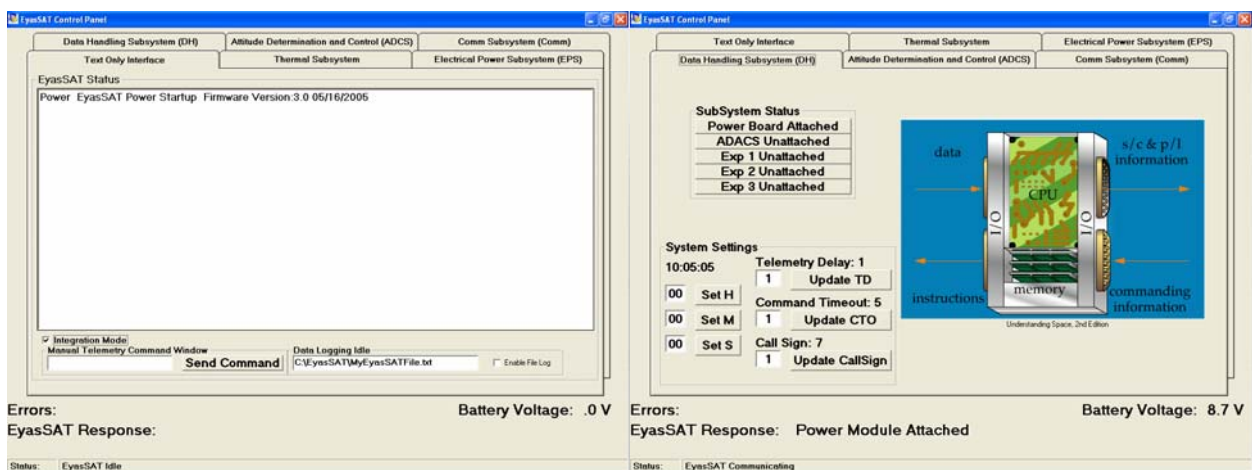

Figure 6. Basic Text Interface and Data Handling GUI Screens

3.4. Communications Subsystem

The communication system of any satellite provides the wireless link necessary to the ground site to send commands and download satellite health and payload data. The EyasSAT Communication Module, shown in Figure 7, links to a small “ground station” shown in Figure 8 which is a commercial data radio that connects to a PC either through a standard RS-232 serial or USB port.

The commercial technology used operates in the 900 MHz ISM band (or 2.4 GHz in Europe) at 9600 baud. The ground stations are paired with a specific EyasSAT by a “channel” designator, which utilizes spread spectrum frequency hopping technology. This allows multiple EyasSATs to be used in a single laboratory. An optional assured data delivery mode can be set in particularly noisy environments.

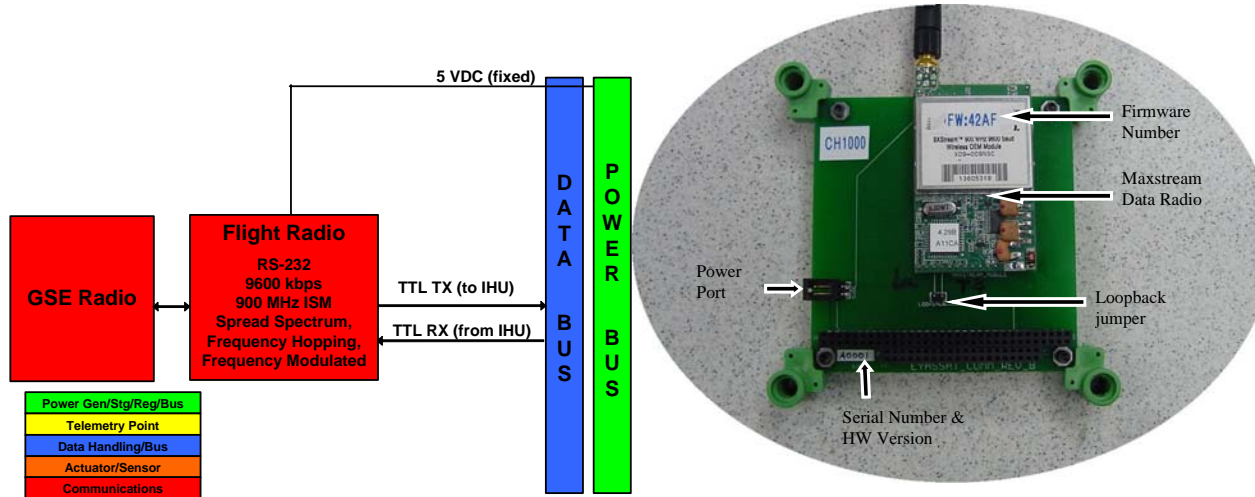

Figure 7. Communication Block Diagram and Module

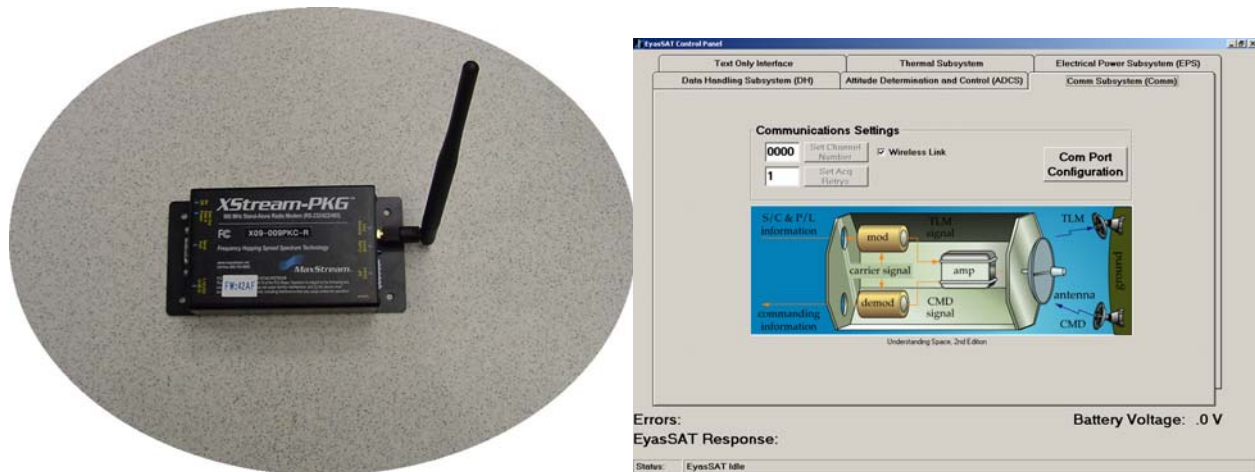

Figure 8. Ground Support Equipment (GSE) and Communication Subsystem GUI Screen

3.5. Attitude Determination and Control

To keep the spacecraft pointed in a desired direction to meet mission requirements, the current attitude must be determined with certain accuracy over a given range. Once the current attitude is known, it must be controlled to a specified accuracy, while meeting range, jitter, drift, and settling time requirements.

The EyasSAT ADCS Module, shown in Figure 9, was designed to demonstrate several sensor and actuator types, shown in Figure 10, ultimately providing a simple demonstration of one degree-of-freedom closed loop control. This can be initiated by setting initial conditions then activating as shown in Figure 11.

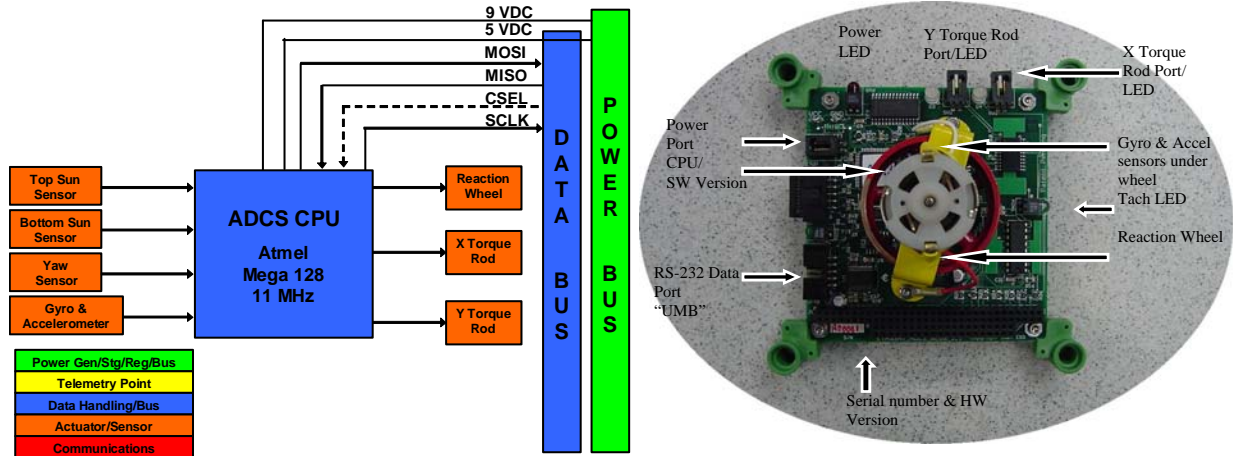

Figure 9. ADCS Module Features Integrated Reaction Wheel, Accelerometers, and Gyroscope

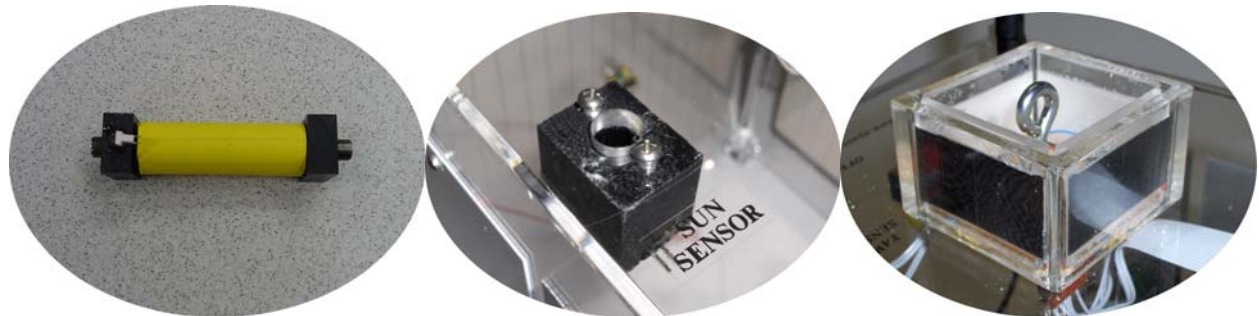

Figure 10. ADCS Actuators and Sensors Mounted to Structure

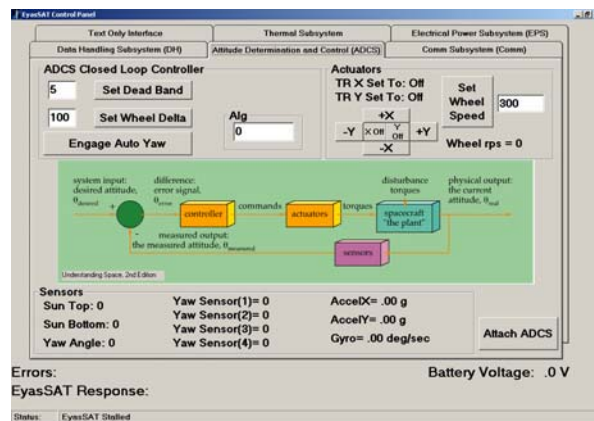

Figure 11. Attitude Determination and Control GUI Screen

3.6. Thermal Control Subsystem

In a typical satellite, Thermal Control Subsystem (TCS) is designed to keep any temperature sensitive satellite component within an acceptable temperature range. EyasSAT has no active thermal control, however it features a set of eight temperature sensors monitoring the 5 VDC DC-DC converter, Data Handling module, solar panel, battery, ambient, and one open slot for experiments. There are two thermal surfaces that are monitored as well and used to demonstrate solar absorptivity and infrared emissivity concepts. These points are shown in Figure 12.

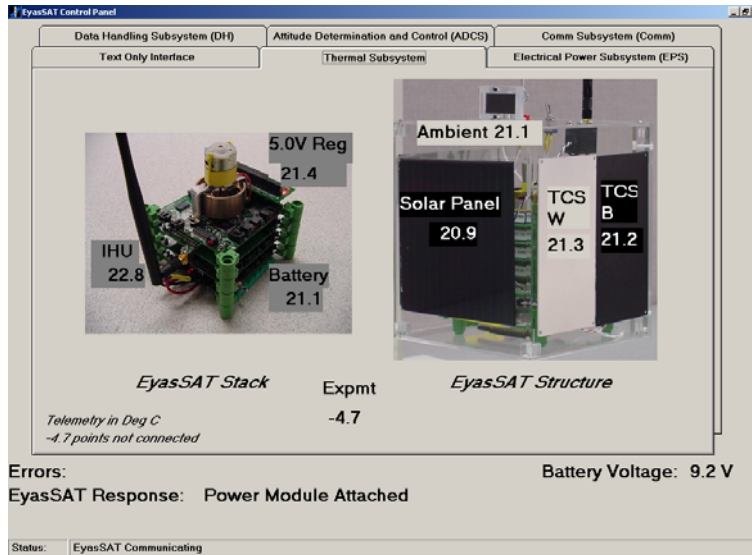

Figure 12. Thermal Control Subsystem GUI Screen

3.7. Final Assembly

Once all the subsystem modules have passed their acceptance test and have been integrated with all the other modules, they are inserted into the structure and connected electrically using a ribbon cable. The final mass budget was previously presented in Table 1. The final power budget can only be calculated after final assembly and is shown in Table 2.

Table 2. Power Budget

Subsystem	Power (W)	%
Structure	0.00	0%
EPS	0.34	21%
DH	0.26	16%
Comm	0.29	18%
ADCS	0.72	45%
Thermal	0.00	0%
Total	1.60	100%
Duty-cycled devices		
Wheel	1.12	-
Torque rod	1.40	-
Comm TX	0.35	-

4.0 Curriculum Description and Applications

This section gives a brief overview of the available curriculum materials available for education and covers high school, undergraduate, graduate, and short course applications.

4.1. Curriculum Description

The EyasSAT hardware was designed and built with educational requirements first and foremost. Starting with a few lab exercises outlined on a legal pad, the EyasSAT ESS has grown into a full set of educational materials for a variety of applications:

- Comprehensive 100+ page User's Manual
- Twenty page engineering course workbook
- Seven page executive course workbook
- Written and "hands-on" demonstration exams
- 50 page Owner's manual, including demonstration guides for small groups and introductory classroom use as well as laboratory support information

This set of materials has been dynamically developed in cooperation with over 700 students and a team of instructors and support personnel. Starting with the original set of laboratory exercises, incremental additions and improvements were deployed, seeking real-time feedback from the students. The design team had to be very careful in providing a quality educational experience for each student without the frustration typically found in prototype courses. Fortunately, numerous instructors sharing the vision of EyasSAT were there every step of the way to help students through, achieving these goals. The set of materials was put under configuration control during Spring 2005 and has been used successfully since then with very positive feedback from students and instructors alike.

The User's Manual walks the students through six distinct laboratory exercises, one for each spacecraft subsystem. All six exercises can be completed in as little as three hours total, which is best applied to an executive short course environment. At the other extreme, the six complete exercises can be applied to an undergraduate space systems engineering course environment, where each lab takes approximately two hours and the final lab can take up to four hours. To enable this range of application, the User's Manual features an easy-to-follow "branching" technique, which guides the student through the appropriate exercises depending on the course they are taking. Another feature of the manual is "learning moments," which provide all students an opportunity to pause and reflect as a team what they have learned and how it is applied to real space systems engineering. These statements can be used as testable material.

Depending on the course students are taking, a workbook has been developed for students to record their work for reflection and analysis. In the engineering course, the workbook also serves as the template for a lab report that can be used as a graded exercise. Depending on the rigor of the course, exam questions can be used to assess the students' understanding. Multiple choice questions and individual student demonstrations in the laboratory have been used successfully.

For the instructor and laboratory administrator, there is an Owner's Manual, which features support, setup, troubleshooting, and technical information. In addition, a guide is included for demonstrating EyasSAT to small groups or as an introduction to satellites in the classroom.

These materials are updated several times a year and are posted to a user website as better methods of teaching and learning are discovered. New educational materials are being developed every day and are freely shared between users in the EyasSAT community.

4.2. Undergraduate Applications

The foundation of developing EyasSAT was to provide a world-class experience to help instructors teach and students learn spacecraft systems engineering at the undergraduate level. EyasSAT has been successfully used for four semesters of “Astronautics 331: Space Systems Engineering” at the USAF Academy. The sequence of the course follows a comprehensive look at SMAD¹⁶. After covering approximately 12 lessons on system level design issues, the course presents each subsystem in a block of three to four lessons. After each block is presented, a session in the lab follows, where the students use EyasSAT to focus on the real-world issues associated with the subsystem they just studied.

Typical comments from students who have completed the course are “Building and operating a real satellite has been one of the most rewarding in class experiences ever,” “The best part of the course,” and “Great experience! Taught the principles behind our studies.” Exactly 99 students have successfully completed the course during the first four semesters it has been offered. Consequently, enrollment in the course for future years has jumped up 30% from the average, simply from word-of-mouth excitement about the experience. In addition, enrollment in the Astronautical Engineering and Space Operations majors is up by 42% from previous years. Many new students cite EyasSAT demonstrations at the bi-annual major’s nights as one of the reasons they were first drawn to the course or major.

A spin-off application of EyasSAT is its inclusion in the USAF Academy’s core Astronautical Engineering course, required by approximately 950 graduates each year. “Astro 310: Introduction to Astronautics,” covers the spectrum of space mission issues for the warfighter¹⁹. Of the 42 lessons presented, eight of them are allocated to spacecraft payload and subsystem issues and design. During these lessons, instructors use the hardware and the GUI to briefly demonstrate the top-level concepts²⁰.

Another spin-off effort in the works is a project to use EyasSAT as an advanced demonstrator and laboratory tool to support undergraduate control system theory courses at the USAF Academy. These concepts are currently being prototyped and will be introduced in the classroom starting Fall 2006.

EyasSAT was designed to be modular and expandable. Programs are underway at the USAF Academy for using EyasSAT as a balloon and sounding rocket experiment payload platform, testbed for new payload and subsystem prototype development, and student independent study project platform. Student or instructor built payloads/subsystems can easily be added such as: GPS, digital visible and IR imaging, proximity operations on air table (i.e. space “battle bots”), high efficiency solar arrays, or composite structure. A student successfully built a cold gas thruster Spring 2005 for an independent research project.

Besides the USAF Academy, the University of Surrey, United Kingdom and Pennsylvania State University are also using EyasSAT in their undergraduate programs. Embry-Riddle Aeronautical University, Arizona uses EyasSAT to support an undergraduate spacecraft attitude determination and control course.



Figure 13. USAF Academy Cadet Performing Final Assembly of a Revision A EyasSAT Spring 2004

4.3. Graduate Program Application

One of EyasSAT's major strengths is its broad applicability to systems engineering education making it a perfect fit for graduate level programs as well. The School of Aerospace Engineering at the Georgia Institute of Technology will capitalize on that strength by incorporating EyasSAT into a graduate level design course in space mission architecture. Here EyasSAT will be used for an in-depth study of the space element of the architecture.

Following an introduction to the requirements and functions of each of the major spacecraft subsystems, students will thoroughly investigate the EyasSAT subsystems then perform subsystem testing and integration. EyasSAT will provide a rare hands-on satellite experience that will connect the concepts to actual systems.

Georgia Tech will also use EyasSAT in its Systems Engineering Certificate program currently under development. The certificate program is targeted at experienced engineers and technical professionals who desire current, practical skill sets and process understanding in systems engineering. Here EyasSAT will be used to demonstrate system level design considerations based on applicable case studies. The case studies will provide the setting and EyasSAT will provide the practical application of systems engineering processes including requirements definition and tracking, testing, and integration.

In addition to Georgia Tech, the University of Colorado, Boulder campus and Cleveland State University, Ohio have been using EyasSAT for some time as a significant part of their space systems engineering graduate courses.

4.4. Continuing Education Applications

The National Security Space Institute (NSSI) is the DoD, intelligence, civil, and commercial community's focal point for educating professionals on all aspects of how space assets are brought to bear to enhance and preserve national security. HQ NSSI is answering the call to develop a cadre of space professionals who can draft and prioritize warfighter requirements for future systems; and acquire, operate, manage, and maintain space systems based on strategic and tactical needs.

Over 400 military and civilian career space professionals have taken the half-day EyasSAT executive course as part of Space 200. Capping a block of instruction on Space Mission Design, EyasSAT provides an opportunity for students to get their hands on space hardware. A similar number of students will take the course annually.

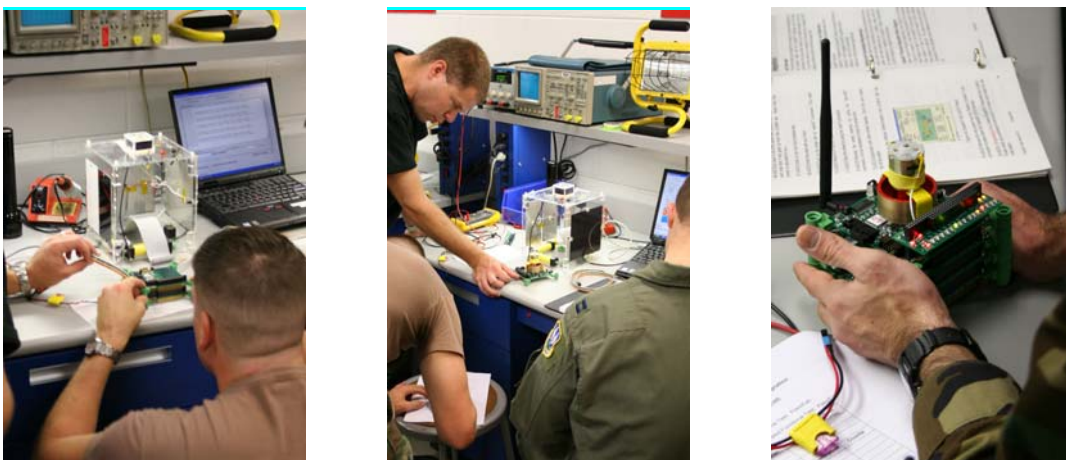

Figure 14. Space 200 Students Completing the 3-hour Executive Course Version

4.5. Professional Short Course Applications

Systems engineering education has traditionally focused well on the “front-end” of the process—requirements capture and design. Usually coming toward the end of the lifecycle, system verification and validation (V&V) receives far less academic attention. Yet, numerous disasters can be traced directly to poor V&V²¹. Recognizing the critical need for their engineers to have a keen understanding of this critical part of systems engineering, NASA’s Marshall Space Flight Center, working with the NASA Engineering Training (NET) organization and the NASA Systems Engineering Working Group sought to develop a V&V short course for NASA engineers.

Working with NASA, Teaching Science & Technology Inc. (TSTI) set out to create a Space Systems Verification & Validation (SSVV) course that addressed the following objectives:

- Explain the end-to-end SE process and how it applies to system (and lower level) requirements definition, allocation, validation and verification.
- Describe the purpose and scope of key documents required in the validation and verification processes, and describe typical errors committed.
- Describe various methods of verification, when they are appropriate, and how they are used as part of a verification plan for a system of interest.
- Determine appropriate circumstances and applicability of verification methods to prototype and proto-flight systems.
- Analyze representative verification plans, test sequences and activities for an example system of interest (spacecraft).
- Develop, evaluate and implement a master verification plan for a space system including hardware, software and associated ground support equipment (GSE).
- Apply processes and techniques in a hands-on workshop associated with a system of interest.
- Use applicable NASA, DoD and Industry Standards and lessons learned to support system validation and verification decisions and activities.

From the outset of course development, it was recognized that a true understanding and internalization of V&V processes and goals couldn’t happen from only a pile of PowerPoint slides. V&V is so tied to real hardware and software that only hands-on example could make this otherwise dry subject come to life. The EyasSAT system offered a unique opportunity for short course participants to learn V&V by applying it in the classroom. During the 4-day TSTI SSVV course, EyasSAT is used from the component to the system level to illustrate V&V principles and allow participants, working in teams, to apply processes (hands-on) to hardware and software—complete with nagging details that, without good planning, plague real programs.

During the course, participants cover the following topics during lectures, discussions and group exercises:

- Day 1: Intro to System Verification & Validation in the Space Mission Lifecycle
 - Lectures: Intro to SE, V&V, Implementation and the Course System of Interest
 - Group Exercise 1: System and subsystem requirements validation & verification planning
- Day 2: Verification Methods, Techniques & Standards
 - Lectures: Space Environment, Testing, COTS V&V
 - Group Exercise 2: Part-level Verification

- Day 3: Software & Subsystem-Level Verification
 - Lecture: Software IVV
 - Group Exercise 3: Software Verification
 - Group Exercise 4: Subsystem-level Verification
- Day 4: System Integration, Verification & Validation
 - Group Exercise 5: System Integration
 - Group Exercise 6: Integrated Functional Testing
 - Group Exercise 7: System Acceptance Review
 - Group Exercise 8: Mock Environmental Test Campaign
 - Lecture: Launch Site, Operational V&V

Lectures are key to outlining processes, describing standards, and highlighting lessons learned. But the real learning happens when EyasSAT is unveiled as the course “system of interest.” In the course scenario, EyasSAT is presented as a risk reduction project for a larger program to design a constellation of small satellites to provide global Tsunami tracking & information (“TsTISat”) from ocean warning buoys. As such, EyasSAT is given to have the following top-level requirements:

- 1.0 EyasSAT shall demonstrate the TsTISat EPS design
- 2.0 EyasSAT shall demonstrate the TsTISat data handling architecture
- 3.0 EyasSAT shall demonstrate functionality of TsTISat ADCS software and associated math models
- 4.0 EyasSAT shall demonstrate TsTISat EGSE interfaces for testing and check-out
- 5.0 EyasSAT shall provide the ability to evaluate the effects of different thermal coatings
- 6.0 EyasSAT shall demonstrate basic TsTISat integration procedures
- 7.0 EyasSAT EGSE shall demonstrate operations of prototype TsTISat GSE

As all V&V is ultimately requirements driven, special emphasis is given to system requirements and flow down. Nearly 200 requirements are derived from the top-level requirements and are used as a basis for subsequent exercises. During these exercises, participants:

- Verify component-level requirements for transistors, diodes, etc. using standard lab equipment
- Verify software at the code-level during both a code review and a calibration exercise
- Verify subsystem-level performance against requirements using the EyasSAT GSE and GUI
- Verify & validate system-level performance against requirements

The EyasSAT Lab Manual discussed earlier in this paper was rewritten as a Master Verification Plan and drives all verification activities. Results are captured on a massive Integrated Requirements Verification Compliance Matrix—presented as 3 large 3’x4’ posters that all participants can see at a glance status of the verification process.

During course development, a 1-day version of the course was presented to the local Colorado INCOSE chapter as a dry run. As of this paper, the full course has been presented twice to NASA and once to industry to over 75 participants around the US. Feedback on the use of EyasSAT to reinforce key V&V processes and issues has been overwhelmingly positive, showing the overall versatility and robustness of the EyasSAT system for systems engineering education.

Both NASA and Boeing have benefited from the TSTI application of EyasSAT in a professional short course. Microsat Systems Inc. and Southern Cross Space & Communications Pty Ltd, Australia, have used EyasSAT to support their commercial efforts.

4.6. High School Applications

EyasSAT was successfully used during the summers of 2004 and 2005 where a total of 240 high school students visited the lab in groups of a dozen or less at a time. These sessions were a part of a four-hour class on space operations, which was one of eight possible classes students attended during their one-week visit to the USAF Academy as a part of the Summer Seminar program.

These students were given the opportunity to command and control an assembled EyasSAT for about an hour to give them an introduction to satellites. Based on the feedback we received, these high-school students, many whom had no idea what a satellite was, walked away with an eye-opening experience that gave them much greater insight into satellites and space operations in general.

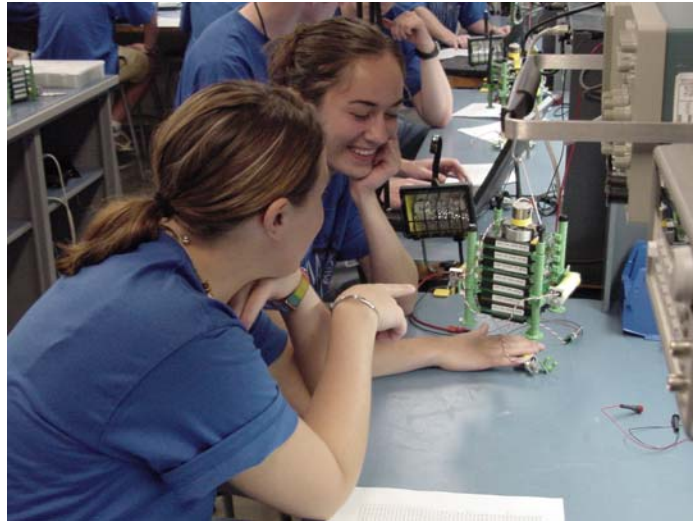

Figure 15. High School Students Conducting Revision A ADCS Experiments Summer 2004

5.0 Summary

A brief overview of the EyasSAT ESS was presented, followed by applications and results from two years' of success in high school, undergraduate, graduate, and professional short courses. Over 1,500 students now experience EyasSAT annually.

The EyasSAT ESS was presented at the 16th International Conference on College Teaching and Learning and received the prestigious 2005 Boyer International Award for Excellence In Teaching, Learning and Technology. The space community has also recognized EyasSAT on numerous occasions^{22,23}.

EyasSAT was co-developed under a Cooperative Research and Development Agreement (USAF CRDA NUMBER 04-AFA-239-1, 25 August 2004) by the U.S. Air Force Academy, Colorado, USA and Colorado Satellite Services, Parker, Colorado, USA. This concept and the embodiment of the idea have been submitted for U.S. patent consideration, which is currently in the "patent pending" status. The EyasSAT ESSTM is available from Colorado Satellite Services, LLC, Parker, Colorado. We gratefully acknowledge the National Security Space Institute, Colorado Springs, Colorado, who provided significant contributions of funding and course development. More information, including FAQ and some of the referenced documents, is available at www.eyassat.com

The views expressed in this article are those of the author and do not reflect the official policy or position of the United States Air Force, Department of Defense, or the U.S. Government. Cleared for public release (USAF/DFAS 26 October 2005).

6.0 References

- ¹ Siegenthaler, K, Lawrence, T. J., Miller, D. A, Swanson, D, Meerman, M. J, Barnhart, D. J, McHarg, J and White, J. J, "Nurturing Our Satellite Space Workforce at the United States Air Force Academy," AIAA Space 2005 Proceedings, 2005.
- ² Busch, B, Lawrence, T. J, Meerman, M. J, "The Undergraduate Satellite and Rocket Design, Fabrication, Launch and Operations Program," AIAA Space 2004 Proceedings, 2004.
- ³ Ritchey, O. NG, Barnhart, D. J, Sellers, J. J, White, J. J, White, T. L, Clark, J. B, "EyasSAT: Creating a Progressive Space Workforce—Today," AIAA 2nd Responsive Space Conference Proceedings, 2004.
- ⁴ Evans, B. G, "Training in satellite engineering provided by the University of Surrey," IEE Colloquium on Education in the Space and Satellite Community Proceedings, pp. 9/1 - 9/9, 1990.
- ⁵ Johnson, V. S, "Tying it all together - The NASA/USRA University Advanced Design Program," Aerospace Design Conference Proceedings, 1992.
- ⁶ Boyd, A. W, "Initiatives for Space Systems Education of Military Officers," Space Programs and Technologies Conference and Exhibit Proceedings, 1993.
- ⁷ Moore, R. C, "Characteristics of a Successful Space System Engineer," 18th Digital Avionics Systems Conference Proceedings, Volume 2, pp. 7.B.6-1 - 7.B.6-8, 1999.
- ⁸ Graziani, F, Ferrante, M, Palmerini, G. B, Santoni, F, Tortora, P and Marchiori, C, "UNISAT Program - A University Tool for Space Education," 39th Aerospace Sciences Meeting Proceedings, 2001.
- ⁹ Hughson, M.C, Liebst, B. S, "A Vision for Graduate Aerospace Education in the 21st Century Air (and Space) Force," 39th Aerospace Sciences Meeting and Exhibit Proceedings, 2001.
- ¹⁰ Cheng, P, Chism, D, Goodman, W, Smith, P and Tosney, W, "Space Systems Engineering Lessons Learned System," SatMax 2002: Satellite Performance Workshop Proceedings, 2002.
- ¹¹ Swartwout, M. Bennett, K, Macke, J, "Integrating Hands-On Design Education and Faculty Research at Washington University," AIAA Space 2004 Proceedings, 2004.
- ¹² Gardner, B, Hoheb, A, "A Corporate University Approach to National Security Space Education," AIAA Space 2005 Proceedings, 2005.
- ¹³ Hunyadi, G, Ganley, J, Peffer, A, Kumashiro, M, "The University Nanosat Program: An Adaptable, Responsive and Realistic Capability Demonstration Vehicle," IEEE Aerospace Conference Proc., 2004.
- ¹⁴ Heidt, H, Puig-Suari, J, Moore, A. S, Nakasuka, S, Twiggs, R. J, "CubeSat: A New Generation of Picosatellite for Education and Industry Low-Cost Space Experimentation," Utah State University Small Satellite Conference Proceedings, 2001.
- ¹⁵ Kitts, C. A, "Three Project-based Approaches to Spacecraft Design Education," 1999 IEEE Aerospace Conference Proceedings, Volume 5, pp. 359 – 366, 1999.
- ¹⁶ Wertz, J. R, Larson, W. J, *Space Mission Analysis and Design*, 3rd Edition, Microcosm Press, El Segundo, CA, 1999.
- ¹⁷ Rumsfeld, D. H, et al., "Report of the Commission to Assess United States National Security Space Management and Organization," Washington, DC, January 2001.
- ¹⁸ Barnhart, D. J, Ritchey, O. NG, Sellers, J. J, White, J. J, White, T. L, Clark, J. B, "EyasSAT: Transforming the Way Students Experience Space Systems Engineering," 2004 ASEE Annual Conference & Exposition Proceedings, 2004.
- ¹⁹ Sellers, J. J, *Understanding Space*, 3rd Edition, McGraw Hill, Boston, MA, 2005.
- ²⁰ Siegenthaler, K, Barnhart, D. J, Sellers, J. J, "Educational Methods/Aids Used in the Astronautics Core Course at the United States Air Force Academy," 2004 ASEE Annual Conference Proceedings, 2004.
- ²¹ Bahill, A. T, Henderson, S. J, "Requirements Development, Verification, and Validation Exhibited in Famous Failures," Journal of Systems Engineering, Vol. 8, No. 1, 2005.
- ²² David, L, "Hands-on Satellite Teaching Tool," Space.com News Article, 23 August 2004.
- ²³ White, J. J, "EyasSAT Educational Satellite System," AMSAT News Service Bulletin 221.06 From AMSAT HQ, August 8, 2004.