



Title	Efficient production of a correctly folded mouse $\alpha$ -defensin, cryptdin-4, by refolding during inclusion body solubilization
Author(s)	Tomisawa, Satoshi; Sato, Yuji; Kamiya, Masakatsu; Kumaki, Yasuhiro; Kikukawa, Takashi; Kawano, Keiichi; Demura, Makoto; Nakamura, Kiminori; Ayabe, Tokiyoshi; Aizawa, Tomoyasu
Citation	Protein expression and purification, 112, 21-28 <a href="https://doi.org/10.1016/j.pep.2015.04.007">https://doi.org/10.1016/j.pep.2015.04.007</a>
Issue Date	2015-08
Doc URL	<a href="http://hdl.handle.net/2115/62595">http://hdl.handle.net/2115/62595</a>
Rights	©2015, Elsevier. Licensed under the Creative Commons Attribution-NonCommercial-NoDerivatives 4.0 International <a href="http://creativecommons.org/licenses/by-nc-nd/4.0/">http://creativecommons.org/licenses/by-nc-nd/4.0/</a>
Rights(URL)	<a href="http://creativecommons.org/licenses/by-nc-nd/4.0/">http://creativecommons.org/licenses/by-nc-nd/4.0/</a>
Type	article (author version)
File Information	Manuscript PEP112 21-28.pdf



[Instructions for use](#)

Efficient production of a correctly folded mouse  $\alpha$ -defensin, cryptdin-4, by refolding during inclusion body solubilization

Satoshi Tomisawa<sup>1</sup>, Yuji Sato<sup>1</sup>, Masakatsu Kamiya<sup>1</sup>, Yasuhiro Kumaki<sup>1</sup>, Takashi Kikukawa<sup>1</sup>, Keiichi Kawano<sup>1</sup>, Makoto Demura<sup>1</sup>, Kiminori Nakamura<sup>2</sup>, Tokiyoshi Ayabe<sup>2</sup>, Tomoyasu Aizawa<sup>1\*</sup>

<sup>1</sup>. Protein Science Laboratory, Graduate School of Life Science, Hokkaido University, Sapporo, Hokkaido 060-0810, Japan

<sup>2</sup>. Innate Immunity Laboratory, Graduate School of Life Science, Hokkaido University, Sapporo, Hokkaido 001-0021, Japan

\* Corresponding author: Dr. Tomoyasu Aizawa.

Graduate School of Life Science, Hokkaido University, Sapporo, Hokkaido 060-0810, Japan.

Tel.: +81-11-706-3806

Fax: +81-11-706-3806

Email: aizawa@mail.sci.hokudai.ac.jp

## Abstract

Mammalian  $\alpha$ -defensins contribute to innate immunity by exerting antimicrobial activity against various pathogens. To perform structural and functional analysis of  $\alpha$ -defensins, large amounts of  $\alpha$ -defensins are essential. Although many expression systems for the production of recombinant  $\alpha$ -defensins have been developed, attempts to obtain large amounts of  $\alpha$ -defensins have been only moderately successful. Therefore, in this study, we applied a previously developed aggregation-prone protein coexpression method for the production of mouse  $\alpha$ -defensin cryptdin-4 (Crp4) in order to enhance the formation of inclusion bodies in *E. coli* expression system. By using this method, we succeeded in obtaining a large amount of Crp4 in the form of inclusion bodies. Moreover, we attempted to refold Crp4 directly during the inclusion-body solubilization step under oxidative conditions. Surprisingly, even without any purification, Crp4 was efficiently refolded during the solubilization step of inclusion bodies, and the yield was better than that of the conventional refolding method. NMR spectra of purified Crp4 suggested that it was folded into its correct tertiary structure. Therefore, the method described in this study not only enhances the expression of  $\alpha$ -defensin as inclusion bodies, but also eliminates the cumbersome and time-consuming refolding step.

Keywords (a maximum of 6 keywords)

$\alpha$ -defensin, Coexpression, Inclusion bodies, Refolding, NMR

## Introduction

Cationic antimicrobial peptides produced by animal cells represent the first line of defense against invasion by pathogens [1]. Defensins and cathelicidins are the two major classes of mammalian antimicrobial peptides [2]. Previous studies have shown that defensins are microbicidal against Gram-positive and Gram-negative bacteria, yeast, fungi, spirochetes, protozoa, and enveloped viruses [3,4]. Moreover, some defensins are known to act as chemokines that activate the adaptive immune response [2-5]. The mammalian defensins are characterized by six cysteine residues forming three intramolecular disulfide bridges, and are divided into two subfamilies,  $\alpha$ - and  $\beta$ -defensins, based on the amino acid sequence similarities and the linkages of the disulfide bonds [3-5].

The  $\alpha$ -defensins are cationic, amphipathic 3-4 kDa peptides [5]. They were first isolated from myeloid cells and later identified in intestinal Paneth cells. Structurally,  $\alpha$ -defensins are characterized by a triple-stranded  $\beta$ -sheet structure that is constrained by three invariant disulfide bonds between Cys<sup>I</sup>-Cys<sup>VI</sup>, Cys<sup>II</sup>-Cys<sup>IV</sup>, and Cys<sup>III</sup>-Cys<sup>V</sup>. This characteristic pattern of disulfide bridges is considered to be crucial for maintenance of the three-dimensional structure and proteolytic stability of these peptides [5]. Moreover,  $\alpha$ -defensins have conserved biochemical features including a canonical Arg-Glu salt

bridge, a conserved Gly residue at Cys<sup>III+8</sup>, and high content of Arg relative to that of Lys.

The mouse Paneth cell  $\alpha$ -defensins, termed cryptdins (Crps), are secreted into the lumen of the small intestinal crypts in response to exposure to bacteria or bacterial antigens [6]. Among the known isoforms, cryptdin-4 (Crp4) has the most potent antimicrobial activity [7]. Furthermore, the primary structure of Crp4 uniquely lacks three amino acids residues between the fourth and fifth cysteine residues [7]. Because Crp4 has these features that distinguish it from other Crps, Crp4 has been studied most intensively. The solution structure of Crp4 has been determined by NMR spectroscopy [8,9]. Moreover, until now, cysteine-deleted mutants [10,11], salt bridge-deficient mutants [9,12], positive-to-negative charge-reversal mutants [13] and an Arg-to-Lys mutant of Crp4 [14,15] have been studied to elucidate the role of the conserved biochemical features of  $\alpha$ -defensins. In previous studies, the wild-type and mutants of Crp4 were prepared using the *Escherichia coli* expression system [8-15]. In this expression system, the recombinant wild-type and Crp4 mutants are expressed in *E. coli* as N-terminally linked, 6-histidine-tagged fusion peptides.

Large quantities of correctly folded  $\alpha$ -defensin are essential to study the structure and antimicrobial activity of  $\alpha$ -defensin. In general, it is difficult to obtain large amounts of

$\alpha$ -defensins from natural sources due to their low concentration in these materials. Although chemically synthesized  $\alpha$ -defensins were widely used in some previous studies [16-19], the chemical synthesis of  $\alpha$ -defensin is very costly. Therefore, many strategies have been developed to produce  $\alpha$ -defensin using recombinant techniques [20-25]. Because *E. coli* is easy to handle, is inexpensive, and grows quite fast, *E. coli* is the most widely used host strain for the overproduction of  $\alpha$ -defensin [20-23]. However, the recombinant production of  $\alpha$ -defensins using *E. coli* has been difficult due to their toxicity and proteolytic susceptibility.

To prevent their degradation,  $\alpha$ -defensins are usually expressed as fusion proteins in *E. coli* cells [20-23]. The attachment of soluble protein to  $\alpha$ -defensins has been adopted to prevent degradation and promote proper folding [22]. However, the soluble expression of antimicrobial peptides such as  $\alpha$ -defensins may cause damage to the host cells by disrupting their cell membranes. Moreover, in fusion protein systems, enzymatic or chemical cleavage is necessary to remove fusion protein tags [20-23]. Enzymatic cleavage often causes unfavorable degradation of recombinant peptides, because widely used proteases, such as enterokinase and factor Xa, often show non-specific cleavages at unexpected sites [26,27]. Furthermore, many peptides often contain potential cleavage sites cleaved by chemicals. For instance, CNBr is commonly used to cleave peptide

bonds C-terminal to methionine residues in proteins and peptides [28]. However, because many  $\alpha$ -defensins contain methionine in their amino acid sequences, CNBr cannot be used to separate such  $\alpha$ -defensins from fusion proteins.

On the other hand, the formation of inclusion bodies may also be useful to avoid proteolytic degradation of  $\alpha$ -defensins. However, it is difficult to control inclusion body formation in *E. coli* cells. As another way to produce fusion expression, utilization of insoluble protein tags has also been reported [20,23]. While this method prevents both degradation and toxicity, it does not readily allow the use of enzymatic cleavage due to the insolubility of the fusion protein, and thus chemical cleavage is the only practical method for cleavage. Moreover, when  $\alpha$ -defensins are expressed in an insoluble form, they must be refolded in order to finally yield a correctly folded peptide. Thus, these cleavage and refolding steps are the drawbacks of this method.

Therefore, we here applied the coexpression method [29] to produce mouse  $\alpha$ -defensin Crp4 in order to enhance the inclusion body formation. By using this method, it was expected that coexpression of the aggregation-prone protein (partner protein) would enhance inclusion body formation by the peptide of interest (target peptide) while simultaneously protecting the target peptide from proteolytic degradation by protease. Moreover, we attempted to refold Crp4 directly during the inclusion-body solubilization



step under oxidative conditions. Interestingly, even without any purification, Crp4 was efficiently refolded in the solubilization step, and the yield was better than that by the conventional refolding method.

## Materials and methods

### Bacterial strains

*E. coli* DH5 $\alpha$  was used as a host strain for cloning and for preparing template plasmids.

*E. coli* BL21 (DE3) was used as an expression host.

### Construction of a vector coexpressing Crp4 and a partner protein

The Crp4 gene (GenBank accession no. NM010039) fragment was amplified by PCR with a set of primers using the cDNA-containing vector as template (Table I). This product was ligated to the pCOLADuet1 vector (Novagen) by using *NdeI-XhoI* sites (Fig. 1), and the resulting vector was designated pCOLA-Crp4. In this study, we selected two aggregation-prone proteins, human  $\alpha$ -lactalbumin (HLA; GenBank accession no. NM002289) and Cys-less human  $\alpha$ -lactalbumin (Cys-less HLA), as partner proteins. The cDNA of Cys-less HLA was synthesized by Eurofins MWG Operon. In this mutant, all eight Cys residues in HLA were replaced by Ser. The

PCR-amplified partner protein gene fragments (HLA and Cys-less HLA) were digested using restriction enzymes, and each was subcloned into the pCOLA-Crp4 vector by using *NcoI*-*Bam*HI sites. For instance, in this study, the pCOLA-Crp4 vector containing the HLA gene was named pCOLA-[HLA]-Crp4. The clone sequence was confirmed by capillary sequencing.

#### Evaluating the effect of Cys residues of HLA on the Crp4 expression level

*E. coli* BL21 (DE3) cells were transformed with the various expression constructs (pCOLA-[HLA]-Crp4, pCOLA-[Cys-less HLA]-Crp4, and pCOLA-Crp4). The transformed cells were grown at 37°C in 5 mL of LB medium until the OD<sub>600</sub> reached 1.0-1.2. The cells were induced by the addition of 1 mM IPTG and further cultivated for 4 h. The cells were harvested by centrifugation at 15,000 rpm for 5 min at 4°C. After the cells were lysed using Bugbuster protein extraction reagent (Novagen), the inclusion bodies were isolated by centrifugation at 15,000 rpm for 5 min at 4°C and analyzed by Tricine-SDS PAGE. The intensity of Crp4 bands was quantified by densitometry.

#### Oxidative folding of chemically synthesized Crp4

Crp4 synthesized by Fmoc chemistry (Sigma-Aldrich Japan) was dissolved at 2 mg/ml

in 50 mM Gly-NaOH buffer (pH 9.0) containing various concentrations of urea (0, 2, 4, 6 and 8 M). A 50  $\mu$ l aliquot was withdrawn at different time intervals (0, 2, 4, 8 and 12 h). Then, the samples were acidified by 0.1% TFA to quench the folding reaction and injected into HPLC. HPLC analysis was performed on a Cosmosil 5C18-AR-300 column (Nacalai Tesque) using a linear gradient of 20-40% acetonitrile containing 0.1% TFA at a flow rate of 1 ml/min over 40 min. The folding yields were calculated by dividing the integrated area of the correctly folded Crp4 peak by the sum of the integrated area of all peaks.

#### Expression and inclusion body isolation for large scale production

The *E. coli* strain BL21(DE3) harboring the pCOLA-[Cys-less HLA]-Crp4 vector was cultured overnight at 37°C in 50 mL of medium (LB or M9) containing 20  $\mu$ g/mL kanamycin. This preculture was inoculated into 1 L of medium (LB or M9) containing 20  $\mu$ g/mL kanamycin.  $^{15}$ N labeling was achieved by growing *E. coli* in M9 medium containing  $^{15}$ NH<sub>4</sub>Cl as the sole nitrogen source. The culture was grown at 37°C, and protein expression was induced by the addition of 1 mM IPTG when the OD<sub>600</sub> reached 1.0-1.2. After an additional 4 h of cultivation, cells were harvested by centrifugation at 6,000 rpm for 10 min. The cells were resuspended in lysis buffer (50 mM Gly-NaOH, 1

mM EDTA, pH 9.0) and disrupted by sonication. Next, inclusion bodies composed mainly of Cys-less HLA and Crp4 were isolated by centrifugation at 7,500 rpm for 30 min at 4°C. The inclusion bodies were washed twice with lysis buffer containing 0.1% TritonX-100 and washed once with lysis buffer (without TritonX-100).

#### Conventional refolding method with a reducing step

The procedure of the conventional refolding method is described in Figure 2. The washed inclusion bodies were solubilized in solubilization buffer (6 M urea, 50 mM Gly-NaOH, 3 mM EDTA, 200 mM  $\beta$ -mercaptoethanol, pH 9.0) to prepare completely reduced, unfolded Crp4. After centrifugation at 7,500 rpm at 4°C for 30 min, the clarified supernatant was loaded onto a HiTrap SP HP cation-exchange column (GE Healthcare) pre-equilibrated with equilibration buffer (6 M urea, 50 mM Gly-NaOH, 3 mM EDTA, 20 mM  $\beta$ -mercaptoethanol, pH 9.0). The bound Crp4 was eluted with a linear gradient of equilibration buffer with 0-1 M NaCl. The fractions containing Crp4 were identified using Tricine-SDS PAGE. These fractions were collected and dialyzed twice against refolding buffer (50 mM Gly-NaOH, 3 mM reduced glutathione, 0.3 mM oxidized glutathione, pH 9.0) for 12 h at 4°C. Next, the sample was dialyzed twice against 0.1% acetic acid for 12 h at 4°C. Correctly folded Crp4 was purified by

RP-HPLC on a Cosmosil 5C18-AR-300 column (Nacalai Tesque). The elution was carried out with a linear gradient of 20-40% acetonitrile with 0.1% trifluoroacetic acid. The yield of Crp4 was determined by measuring the absorbance at 280 nm. The purified recombinant Crp4 was lyophilized and stored at -30°C.

Direct refolding method without a reducing step

An experimental flowchart for the new method is shown in Figure 2. The washed inclusion bodies were solubilized in solubilization buffer without reducing agent (6 M urea, 50 mM Glycylglycine-NaOH, 3 mM EDTA, pH 9.0) and incubated for 12 h at 37°C in a shaker incubator to enhance oxidative folding of Crp4. After centrifugation at 7,500 rpm at 4°C for 30 min, the clarified supernatant was loaded onto a HiTrap SP HP cation-exchange column (GE Healthcare) pre-equilibrated with equilibration buffer (6 M urea, 50 mM Glycylglycine-NaOH, 3 mM EDTA, pH 9.0). The bound Crp4 was eluted with a linear gradient of equilibration buffer with 0-1 M NaCl. The fractions containing Crp4 were identified using Tricine-SDS PAGE. These fractions were collected and dialyzed twice against 0.1% acetic acid for 12 h at 4°C. The HPLC purification was performed using the same method as described above.

### Acid-urea polyacrylamide gel electrophoresis analysis

Acid-urea polyacrylamide gel electrophoresis (AU-PAGE) was performed basically according to the previously described method [30]. Prior to loading on a gel, an aliquot from each purification step was diluted in 3 × AU-PAGE sample buffer (9 M urea, 5% acetic acid, methyl green). For the analysis of Crp4 in inclusion bodies, inclusion bodies isolated from *E. coli* were directly solubilized into 3 × AU-PAGE sample buffer and then diluted in 5% acetic acid to prevent the formation of disulfide bonds of Crp4 during inclusion body solubilization. These samples were electrophoresed on 12.5% acrylamide gel containing 5% acetic acid and 5 M urea at 150 V. After electrophoresis, the gel was stained with Coomassie blue.

### Bactericidal peptide assay of Crp4

Refolded Crp4 was tested for microbicidal activity against *E. coli* ML35 and *Listeria monocytogenes* (*L. monocytogenes*). The bacteria were cultured in the following media: *E. coli* ML35, tryptic soy broth; *L. monocytogenes*, brain heart infusion (BHI). Bacteria growing exponentially at 37°C were deposited by centrifugation at 9,300 g at 4°C for 5 min. Next, the bacteria were washed in 10 mM sodium phosphate buffer (pH 7.4) supplemented with a 0.01 volume of the culture medium and resuspended in the same

buffer. The bacteria ( $\sim 5 \times 10^6$  CFU/ml) were then incubated with recombinant Crp4 in 50  $\mu$ l for 1 h in a shaker incubator at 37°C, and the surviving bacteria were counted as CFU/ml after overnight growth on tryptic soy agar plates for *E. coli* ML35 and BHI agar plates for *L. monocytogenes*.

### NMR spectroscopy

Recombinant Crp4 refolded during inclusion body solubilization was dissolved in a mixture of 90% H<sub>2</sub>O/10% D<sub>2</sub>O and adjusted to pH 4.2 by the addition of minute amounts of HCl or NaOH. NMR experiments were performed on a Bruker Avance III HD 600 MHz spectrometer. The HSQC spectrum was collected at 30°C. The data were processed using NMRPipe 4.1 [31] and analyzed using Sparky 3.113 software [32].

## Results

### Effect of coexpression of HLA and Cys-less HLA on the Crp4 expression level

To avoid enzymatic and chemical cleavage of fusion proteins, we tried to directly produce Crp4 in *E. coli* as an inclusion body. However, the expression level of Crp4 was extremely low (Fig. 3). Therefore, to enhance the inclusion body formation by Crp4,

we applied the coexpression method.

In a previous study, we experimentally demonstrated that the inclusion body formation of a cationic antimicrobial peptide was enhanced by coexpression with an anionic aggregation-prone partner protein [29]. Therefore, we chose an anionic partner protein, HLA, as a coexpression partner. The results showed that the expression of Crp4 was moderately increased by the coexpression of Crp4 and HLA.

Moreover, in this study, we evaluated the effect of Cys residues of HLA on the inclusion body formation of Crp4 by using Cys-less HLA, in which all eight Cys residues were converted to Ser residues. The expression of Crp4 was markedly increased as an inclusion body by coexpression of Cys-less HLA (Fig. 3). Because the expression level of Crp4 was most increased by coexpression of Cys-less HLA, we selected Cys-less HLA as a partner protein for the large-scale production of Crp4.

#### Oxidative folding of chemically synthesized Crp4

To obtain a large amount of correctly folded Crp4, it is important to determine the best condition for refolding of Crp4. It has been reported that human  $\alpha$ -defensins folded efficiently in the presence of a proper quantity of denaturant [33]. Therefore, we examined the folding behavior of chemically synthesized Crp4 under denaturing



conditions. Moreover, we evaluated the effect of the concentration of urea on the refolding yield of Crp4. As shown in Figure 4, the optimal concentration of urea is 2 M, yielding a 35.4% recovery after 12 h at room temperature. Similarly, in the presence of 4 M urea, the refolding yield after 12 h was 34.0%. As the concentration of urea increased from 4 M to 8 M, the refolding yield gradually declined. Also under non-denaturing conditions, Crp4 folded correctly, although at a ,much slower rate. No aggregation of Crp4 was observed under any of the experimental conditions employed.

Purification and refolding of Crp4 by using a conventional refolding method with a reducing step

Because Crp4 has a charge that is opposite that of Cys-less HLA, we succeeded in separating Crp4 from Cys-less HLA efficiently by a simple one-step cation-exchange chromatography without enzymatic or chemical cleavage (Fig. 5a). After cation-exchange chromatography, we obtained 12 mg of reduced recombinant Crp4. Then, this crude Crp4 was refolded by a simple standard dialysis refolding protocol (Fig. 2). From the results of refolding analysis using chemically synthesized Crp4, we refolded Crp4 in the presence of 2 M urea. After the refolding and purification procedure, we obtained 2.0 mg of correctly folded Crp4 from 1 L of culture. Although

we succeeded in obtaining milligram quantities of correctly folded Crp4 by using a conventional method with a reducing agent, a large amount of Crp4 precipitate was observed after the refolding process.

#### Purification and refolding of Crp4 using the new method without a reducing step

To enhance the refolding yield of Crp4 and avoid the cumbersome refolding step, we attempted to refold Crp4 directly during inclusion body solubilization. Because we expected that the omission of reducing agent from the solubilization buffer would lead to the disulfide bridge formation of Crp4, we attempted to solubilize inclusion bodies of Crp4 in the solubilization buffer without reducing agent. Although we demonstrated that chemically synthesized Crp4 could be folded efficiently in the presence of 2-4 M urea, the inclusion body was not solubilized in 2-4 M urea (data not shown). Therefore, the inclusion body was solubilized in solubilization buffer containing 6 M urea. Refolding of Crp4 during inclusion body solubilization was examined by AU-PAGE analysis. Because small cationic peptides are separated on the basis of both the molecular size and charge, AU-PAGE is a suitable method for evaluating the homogeneity and formation of native structure of defensins. In the case that the isolated inclusion body was directly solubilized in acidic AU PAGE buffer (approximately pH 3), the mobility

of Crp4 was equal to that of reduced chemically synthesized Crp4, suggesting that no disulfide bridges were formed (Fig 5b). In contrast, the mobility of Crp4 after 12 h solubilization using solubilization buffer (pH 9.0) without reducing agent was clearly different from that of reduced Crp4. Moreover, the mobility of Crp4 was not changed during the following purification step. These results indicated that the disulfide bridge formation of Crp4 did not occur in *E. coli* cells but was completed during inclusion body solubilization without a reducing agent. Aggregation of Crp4 was not confirmed after the refolding process. After HPLC purification, we obtained 4.6 mg of correctly folded Crp4 from 1 L of culture.

#### Antimicrobial activity of recombinant Crp4

The microbicidal activity of refolded Crp4 was examined by colony count assay (Fig. 6). The purified Crp4 was active against both *E. coli* ML35 and *L. monocytogenes*. Moreover, the Gram-negative bacterium (*E. coli* ML35) was more sensitive than the Gram-positive bacterium (*L. monocytogenes*). These results were in accordance with the findings reported previously [10].

#### TOCSY and HSQC spectrum of Crp4

To confirm that the Crp4 refolded by new refolding method had the correct structure, the TOCSY and HSQC spectra of Crp4 were obtained. The fingerprint region of the TOCSY spectrum is presented in Figure 7. We confirmed that the chemical shift of the side chain amide proton of Arg7 was shifted markedly downfield. Such a shift was also reported in the previous study [8]. Moreover, the spectrum was quite similar to that observed in the previous study. These results indicate that the Crp4 refolded during inclusion body solubilization had the correct structure. In addition, we could easily prepare isotopically labeled Crp4 due to the good expression efficiency. The HSQC spectrum of  $^{15}\text{N}$ -labeled Crp4 is presented in Figure 8. The well-dispersed peaks in HSQC also indicate that Crp4 was correctly folded. Sequential specific  $^1\text{H}$  and  $^{15}\text{N}$  resonance assignments were also determined without any ambiguity.

## Discussion

In this study, we chose a mouse  $\alpha$ -defensin, Crp4, as the target peptide. To avoid enzymatic or chemical cleavage of the fusion protein, we at first tried to express Crp4 directly in *E. coli*. Unfortunately, the direct expression of Crp4 in *E. coli* was insufficient, probably due to the instability of the expressed cellular Crp4 itself (Fig. 3). We speculated that this low-level expression of Crp4 was caused by the degradation of

expressed Crp4 by proteases of *E. coli*. Therefore, we decided to apply a previously developed method [29], which enhances the inclusion body formation of the target peptide by coexpression of aggregation-prone protein as a partner protein, for overexpression of Crp4.

In our previous study, we examined the effect of the charge of the partner protein on the inclusion body formation by the target peptide via this method and concluded that the opposite charge of the partner protein efficiently enhanced the formation of an inclusion body of the target peptide [29]. In this study, because Crp4 is a cationic antimicrobial peptide (pI 9.9), we selected anionic HLA (pI 4.7) as a candidate for the coexpression partner protein for overexpression of Crp4. To further elucidate the mechanism of inclusion body formation by the target peptide via this method, we evaluated the effect of Cys residues of the partner protein on the inclusion body formation by the target peptide using Cys-less HLA.

Similarly to HLA, Cys-less HLA formed a large amount of inclusion bodies when overexpressed in *E. coli* (Fig. 3a). This result was consistent with earlier findings that a mutant of HLA, in which all eight Cys residues are substituted to Ala residues, forms inclusion bodies in *E. coli* [34], although in our study the Cys residues of HLA were mutated to Ser residues. From these results, it can be said that the Cys mutations of

HLA did not affect the propensity to form inclusion bodies in *E. coli*. Interestingly, while coexpression of HLA modestly enhanced the expression level of Crp4, Crp4 was produced effectively as an inclusion body in the case of coexpression with Cys-less HLA. In this study, we could not clarify why Cys-less HLA induced a greater increase in the expression level of Crp4 than HLA.

To enhance the refolding yield of Crp4, we focused on previous studies which showed that proteins in inclusion bodies have a native-like secondary structure, and the restoration of this native-like structure using mild solubilization conditions promotes refolding of the proteins [35]. Unfortunately, in the present study the inclusion bodies that mainly contained Crp4 and Cys-less HLA were not solubilized under a mild condition (2-4 M urea). However, we were able to confirm that chemically synthesized Crp4 was also refolded even in the presence of a high concentration of urea (6-8 M urea). Therefore, we expected that the refolding of Crp4 without a complete denaturing step would enhance the refolding yield of Crp4. We therefore tried to apply our present method to induce Crp4 to form disulfide bridges during the solubilization of inclusion bodies (Fig. 2). In this method, to facilitate disulfide bridge formation of Crp4 during inclusion body solubilization, we removed the reducing agent from the inclusion body solubilization buffer. As a result, we succeeded in the refolding of Crp4 during inclusion

body solubilization and obtaining 4.6 mg of correctly folded Crp4 after HPLC purification. We also tried to refold Crp4 during the solubilization of inclusion bodies mainly composed of Crp4 and HLA (Cys-containing), but the refolding of Crp4 was inhibited by intermolecular disulfide bridge formation between Crp4 and HLA (data not shown). From these results, it can be said that the coexpression of Cys-less HLA is effective not only to enhance the expression of Crp4 as inclusion bodies but also to prevent the interruption of refolding of Crp4 during inclusion body solubilization caused by the formation of intermolecular disulfide bridges.

In order to avoid the degradation of recombinant proteins and peptides by host-derived proteases in and after the refolding step, partially purified proteins and peptides are generally used as starting materials for the *in vitro* refolding of inclusion body. In this study, we confirmed that Crp4 has the ability to refold efficiently in the presence of a proper concentration of urea (Fig. 4). Under these conditions, host-derived proteases are thought to be denatured. This may be the reason why the yield of correctly folded Crp4 obtained by the direct refolding method was high even without partial purification.

Unlike in the conventional fusion protein system, there is no need to remove the fusion protein tag by enzymatic or chemical methods in our coexpression method. Therefore, our coexpression system can be applied to the production of any  $\alpha$ -defensin. In future

studies, we plan to use this method to produce  $\alpha$ -defensins that are difficult to synthesize by conventional fusion protein methods.

## Conclusion

In this study, we demonstrated that the expression of Crp4 was enhanced by coexpression of an anionic partner protein. By using a Cys-less coexpression partner protein, we succeeded in direct refolding of Crp4 during inclusion body solubilization while eliminating the cumbersome and time-consuming refolding step. After HPLC purification, we obtained milligram quantities of correctly folded Crp4.



## Acknowledgments

This work was partially supported by the Programme for the Promotion of Basic and Applied Researches for Innovations in Bio-Oriented Industry.

## References

- [1] H.G. Boman, Innate immunity and the normal microflora, *Immunol. Rev.* 173 (2000) 5-16.
- [2] E. Guaní-Guerra, T. Santos-Mendoza, S.O. Lugo-Reyes, L.M. Terán, Antimicrobial peptides: General overview and clinical implications in human health and disease, *Clin. Immunol.* 135 (2010) 1-11.
- [3] M.E. Selsted, A.J. Ouellette, Mammalian defensins in the antimicrobial immune response. *Nat. Immunol.* 6 (2005) 551-557.
- [4] R.I. Lehrer, T. Ganz, Defensins of vertebrate animals, *Curr. Opin. Immunol.* 14 (2002) 96-102.
- [5] J. Jarczak, E.M. Kościuczuk, P. Lisowski, N. Strzałkowska, A. Joźwik, J. Horbańczuk, J. Krzyżewski, L. Zwierzchowski, E. Bagnicka, Defensins: Natural component of human innate immunity, *Hum. Immunol.* 74 (2013) 1069-1079.

[6] T Ayabe, D.P. Satchell, C.L. Wilson, W.C. Parks, M.E. Selsted, A.J. Ouellette, Secretion of microbicidal alpha-defensins by intestinal Paneth cells in response to bacteria, *Nat. Immunol.* 1 (2000) 113-118.

[7] A.J. Ouellette, M.M. Hsieh, M.T. Nosek, D.F. Cano-Gauci, K.M. Huttner, R.N. Buick, M.E. Selsted, Mouse Paneth cell defensins: primary structures and antibacterial activities of numerous cryptdin isoforms, *Infect. Immun.* 62 (1994) 5040-5047.

[8] W. Jing, H.N. Hunter, H. Tanabe, A.J. Ouellette, H.J. Vogel, Solution structure of cryptdin-4, a mouse paneth cell alpha-defensin, *Biochemistry* 43 (2004) 15759-15766.

[9] K.J. Rosengren, N.L. Daly, L.M. Fornander, L.M. Jönsson, Y. Shirafuji, X. Qu, H.J. Vogel, A.J. Ouellette, D.J. Craik, Structural and functional characterization of the conserved salt bridge in mammalian paneth cell alpha-defensins: solution structures of mouse CRYPTDIN-4 and (E15D)-CRYPTDIN-4, *J. Biol. Chem.* 281 (2006) 28068-28078.

[10] A. Maemoto, X Qu, K.J. Rosengren, H. Tanabe, A. Henschen-Edman, D.J. Craik,

A.J. Ouellette, Functional analysis of the  $\alpha$ -defensin disulfide array in mouse cryptdin-4, J. Biol. Chem. 279 (2004) 44188-44196.

[11] C. Hadjicharalambous, T. Sheynis, R. Jelinek, M.T. Shanahan, A.J. Ouellette, E. Gizeli, Mechanisms of alpha-defensin bactericidal action: comparative membrane disruption by Cryptdin-4 and its disulfide-null analogue, Biochemistry 47 (2008) 12626-12634.

[12] H. Tanabe, X Qu, C.S. Weeks, J.E. Cummings, S. Kolusheva, K.B. Walsh, R. Jelinek, T.K. Vanderlick, M.E. Selsted, A.J. Ouellette, Structure-activity determinants in paneth cell alpha-defensins: loss-of-function in mouse cryptdin-4 by charge-reversal at arginine residue positions, J. Biol. Chem. 279 (2004) 11976-11983.

[13] H.S. Andersson, S.M. Figueredo, L.M. Haugaard-Kedström, E. Bengtsson, N.L. Daly, X. Qu, D.J. Craik, A.J. Ouellette, K.J. Rosengren, The  $\alpha$ -defensin salt-bridge induces backbone stability to facilitate folding and confer proteolytic resistance, Amino Acids 43 (2012) 1471-1483.

[14] R.A. Llenado, C.S. Weeks, M.J. Cocco, A.J. Ouellette, Electropositive charge in alpha-defensin bactericidal activity: functional effects of Lys-for-Arg substitutions vary with the peptide primary structure, *Infect. Immun.* 77 (2009) 5035-5043.

[15] N.W. Schmidt, K.P. Tai, K. Kamdar, A. Mishra, G.H. Lai, K. Zhao, A.J. Ouellette, G.C. Wong, Arginine in  $\alpha$ -defensins: differential effects on bactericidal activity correspond to geometry of membrane curvature generation and peptide-lipid phase behavior, *J. Biol. Chem.* 287 (2012) 21866-21872.

[16] N.F. Dawson, D.J. Craik, A.M. Mcmanus, S.G. Dashper, E.C. Reynolds, G.W. Tregear, L.O. JR, J.D. Wade, Chemical synthesis, characterization and activity of RK-1, a novel alpha-defensin-related peptide, *J. Pept. Sci.* 6 (2000) 19-25.

[17] P.A. Raj, K.J. Antonyraj, T. Karunakaran, Large-scale synthesis and functional elements for the antimicrobial activity of defensins, *Biochem. J.* 347 (2000) 633-641.

[18] Z. Wu, B. Ericksen, K. Tucker, J. Lubkowski, W. Lu, Synthesis and characterization of human  $\alpha$ -defensins 4-6, *J. Pept. Res.* 64 (2004) 118-125.

[19] E. Vernieri, J. Valle, D. Andreu, B.G. de la Torre, An optimized Fmoc synthesis of human defensin 5, *Amino Acids* 46 (2014) 395-400.

[20] M. Pazgier, J. Lubkowski, Expression and purification of recombinant human  $\alpha$ -defensins in *Escherichia coli*, *Protein Expression Purif.* 49 (2006) 1-8.

[21] O. Bruhn, P. Regenhard, M. Michalek, S. Paul, C. Gelhaus, S. Jung, G. Thaller, R. Podschun, M. Leippe, J. Grötzinger, E. Kalm, A novel horse  $\alpha$ -defensin: gene transcription, recombinant expression and characterization of the structure and function, *Biochem. J.* 407 (2007) 267-276.

[22] A. Wang, Y. Su, S. Wang, M. Shen, F. Chen, M. Chen, X. Ran, T. Cheng, J. Wang, High efficiency preparation of bioactive human  $\alpha$ -defensin 6 in *Escherichia coli* Origami(DE3)pLysS by soluble fusion expression, *Appl. Biochem. Biotechnol.* 87 (2010) 1935-1942.

[23] N. Chapnik, A. Levit, M.Y. Niv, O. Froy, Expression and structure/function

relationships of human defensin 5, *Appl. Biochem. Biotechnol.* 166 (2012) 1703-1710.

[24] A Wang, S. Wang, M. Shen, F. Chen, Z. Zou, X. Ran, T. Cheng, Y. Su, J. Wang, High level expression and purification of bioactive human  $\alpha$ -defensin 5 mature peptide in *Pichia pastoris*, *Appl. Microbiol. Biotechnol.* 84 (2009) 877-884.

[25] K.H. Hsu, C. Pei, J.Y. Yeh, C.H. Shih, Y.C. Chung, L.T. Hung, B.R. Ou, Production of bioactive human  $\alpha$ -defensin 5 in *Pichia pastoris*, *J. Gen. Appl. Microbiol.* 55 (2009) 395-401.

[26] W. Cao, Y. Zhou, Y. Ma, Q. Luo, D. Wei, Expression and purification of antimicrobial peptide adenoregulin with C-amidated terminus in *Escherichia coli*, *Protein Expression Purif.* 40 (2005) 404-410.

[27] Y. Yang, Z. Tian, D. Teng, J. Zhang, J. Wang, J. Wang, High-level production of a candidacidal peptide lactoferrampin in *Escherichia coli* by fusion expression, *J. Biotechnol.* 139 (2009) 326-331.

[28] M. Zorko, R. Jerala, Production of recombinant antimicrobial peptides in bacteria, *Methods Mol Biol*, 618 (2010) 61-76.

[29] S. Tomisawa, E. Hojo, Y. Umetsu, Y. Kato, M. Miyazawa, M. Mizuguchi, M. Kamiya, Y. Kumaki, T. Kikukawa, M. Demura, T. Aizawa, Overexpression of an antimicrobial peptide derived from *C. elegans* using an aggregation-prone protein coexpression system, *AMB Express* 3 (2013) 45.

[30] S. Figueredo, J.R. Mastroianni, K.P. Tai, A.J. Ouellette, Expression and Purification of Recombinant  $\alpha$ -Defensins and  $\alpha$ -Defensin Precursors in *Escherichia coli*, *Methods Mol. Biol.* 618 (2010) 47-60.

[31] F. Delaglio, S. Grzesiek, G.W. Vuister, G. Zhu, J. Pfeifer, A. Bax, NMRPipe: A multidimensional spectral processing system based on UNIX pipes, *J. Biomol. NMR* 6 (1995) 277-293.

[32] T.D. Goddard, D.G. Kneller, SPARKY 3 software, University of California, San Francisco, USA (2006).



[33] Z. Wu, R. Powell, W. Lu, Productive folding of human neutrophil  $\alpha$ -defensins in vitro without the pro-peptide, JACS 125 (2003) 2402-2403.

[34] Z. Peng, L.C. Wu, P.S. Kim, Local structural preferences in the  $\alpha$ -lactalbumin molten globule, Biochemistry 34 (1995) 3248-3252.

[35] S.M. Singh, A.K. Panda, Solubilization and refolding of bacterial inclusion body proteins, J. Biosci. Bioeng. 99 (2005) 303-310.

## Figure captions

Figure 1. Schematic representation of the expression vector. P, T7 promoter; partner, partner protein gene; Crp4, Crp4 gene; T, T7 terminator.

Figure 2. Comparison of the conventional refolding method and the direct refolding method without a reducing step. Flowcharts are given for the conventional method (left) and the direct refolding method (right). The time point of Crp4 refolding, the presence or absence of reducing agent, and the time required for each step are shown.

Figure 3. Effect of the Cys residues of HLA on Crp4 expression level. (a) Tricine-SDS-PAGE analysis of the expression level of Crp4. (b) The intensity data of the coexpression method are expressed in relation to those for the direct expression method.

Figure 4. Time dependence of the folding yields for chemically synthesized Crp4 under different urea concentrations.

Figure 5. Expression and purification of recombinant Crp4. Tricine-SDS PAGE (a) and

AU-PAGE (b) analysis of Crp4. (a) Lane 1: Inclusion body after ultrasonication and centrifugation. Lane 2: Solubilized inclusion body. Lane 3: A flowthrough fraction that was passed through cation-exchange chromatography. Lane 4: Purified Crp4 using cation-exchange chromatography. Lane 5: Purified correctly folded Crp4 using RP-HPLC. (b) Lane 1: Chemically synthesized reduced Crp4. Lane 2: Inclusion body solubilized in AU-PAGE buffer (approximately pH 3). Lane 3: Inclusion body after 12 h solubilization in solubilization buffer (pH 9.0). Lane 4: Purified correctly folded Crp4 using cation-exchange chromatography. Lane 5: Purified correctly folded Crp4 using RP-HPLC.

Figure 6. Bactericidal activity of Crp4 refolded by using the direct refolding method.

Figure 7. Fingerprint region of the 2D TOCSY spectrum of Crp4.

Figure 8.  $^1\text{H}$ - $^{15}\text{N}$  HSQC spectrum of 0.5 mM  $^{15}\text{N}$ -labeled Crp4.

Table

**Table I.** Sequence of primers used in this study

Name	Primer sequence <sup>a</sup> (from the 5' end to 3' end)	Restriction site
Primers for the Crp4 gene	F = GGAATT <u>CATATG</u> GACATCG	<i>NdeI</i>
	ACTTTAGTACTTGTGC	
Primers for the HLA gene	R = <u>CCGCTCGAGT</u> CAGCGGCGGG	<i>XhoI</i>
	GG	
Primers for the HLA gene	F = GAATT <u>TCATGA</u> AAGCAATTC	<i>NcoI</i>
	ACAAAATGTGAGCTG	
Primers for the Cys-less HLA gene	R = <u>CGGGATCC</u> TTACAACCTTCTC	<i>BamHI</i>
	ACAAAGCCACTG	
Primers for the Cys-less HLA gene	F = GAAT <u>TCCCATGGG</u> CAAGCAA	<i>NcoI</i>
	TTCACAAAATCTGAG	
Primers for the Cys-less HLA gene	R = <u>CGGGATCC</u> TTACAACCTTCTC	<i>BamHI</i>
	AGAAAGCCAC	

a. Restriction sites are underlined.

Figure 1.

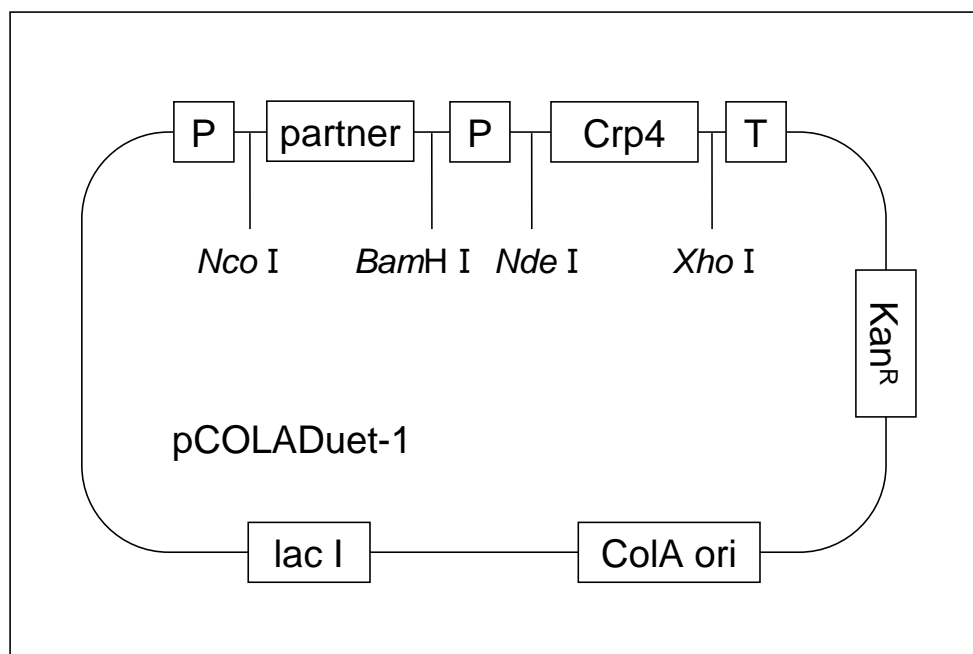

Figure 2.

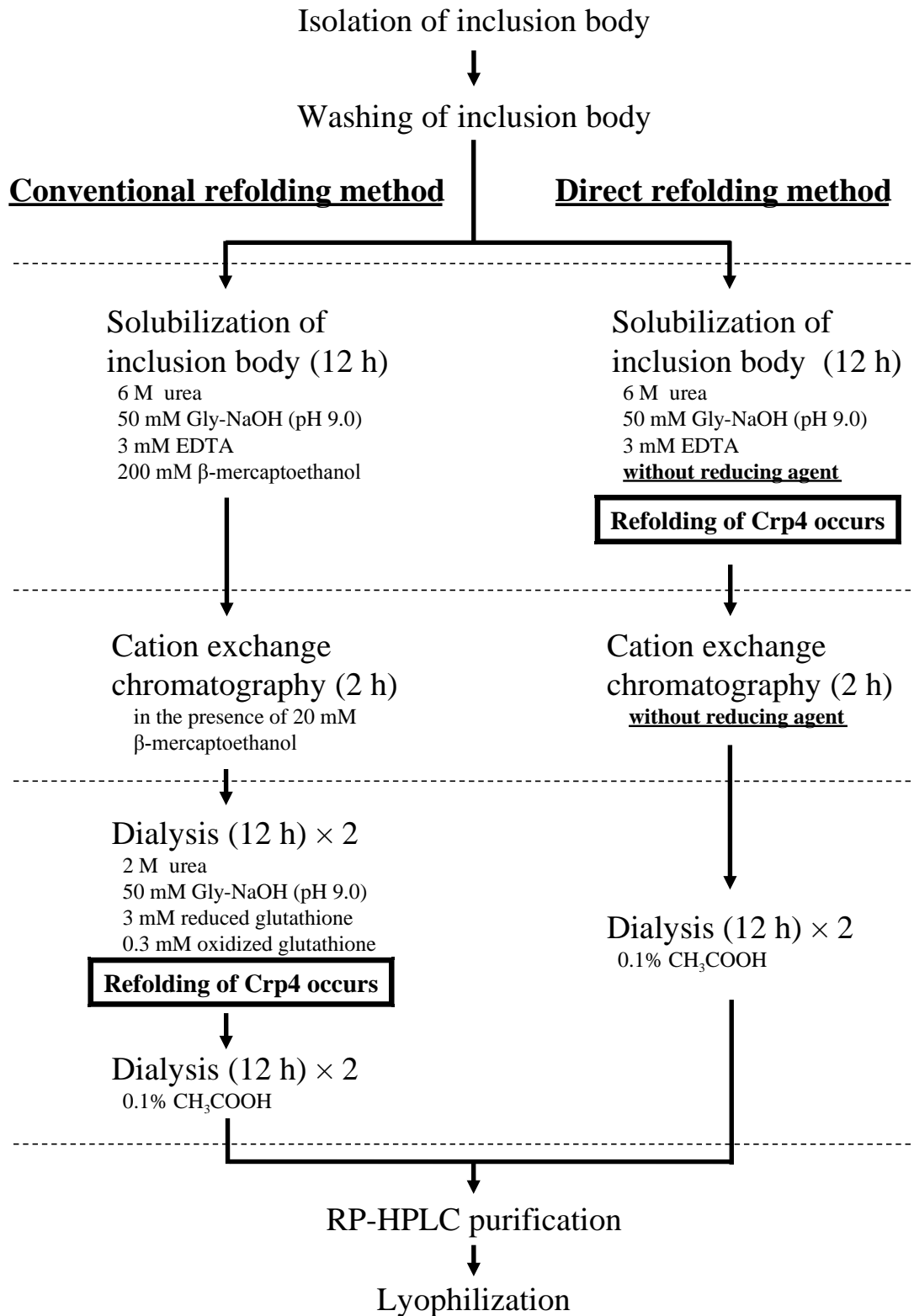

Figure 3.

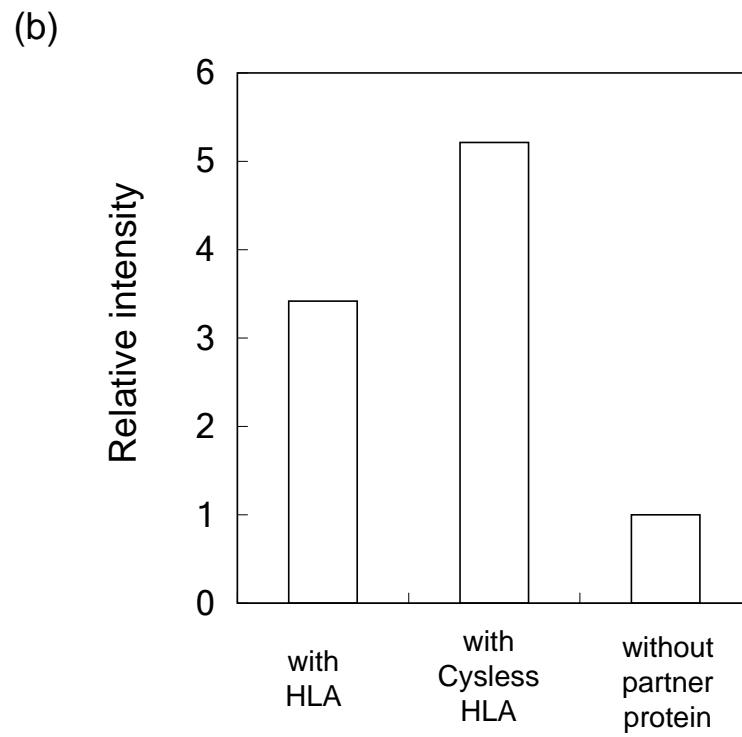
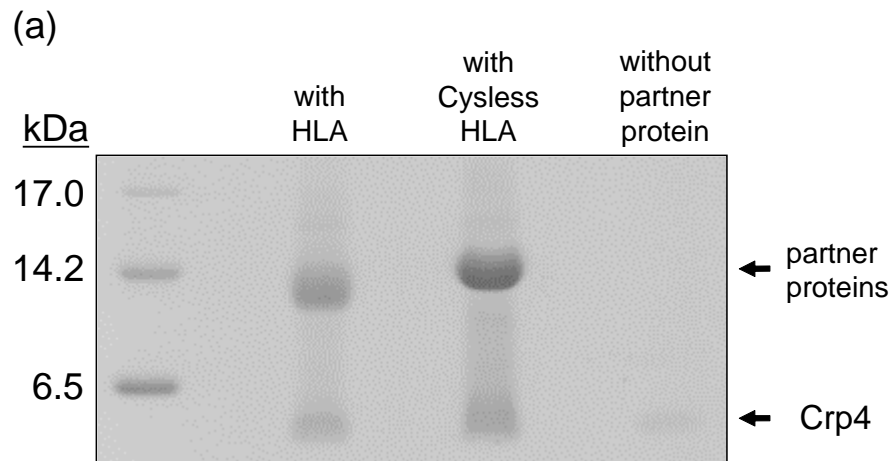

Figure 4.

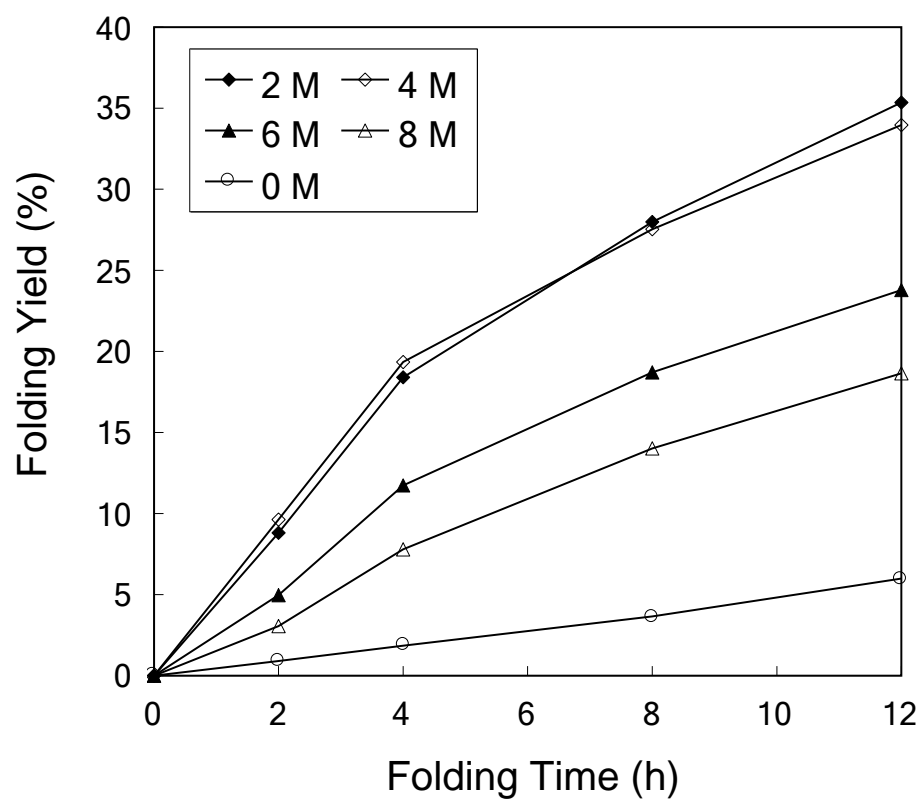



Figure 5.

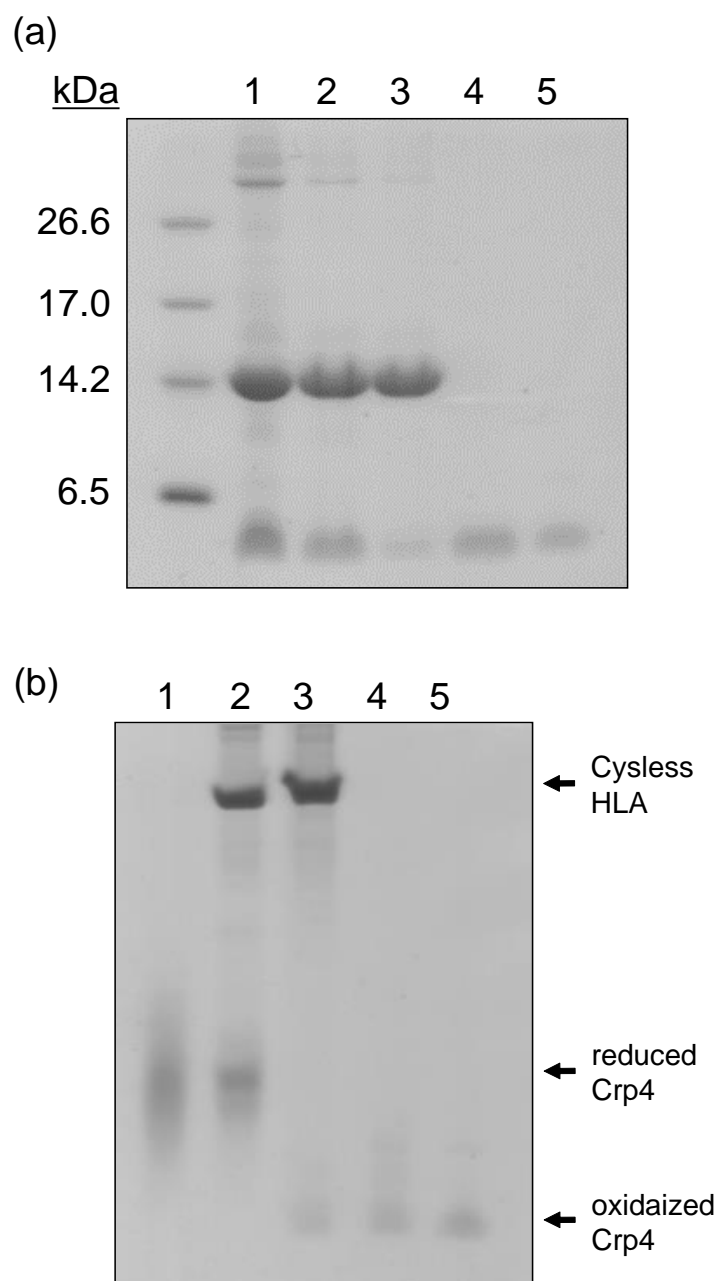

Figure 6.

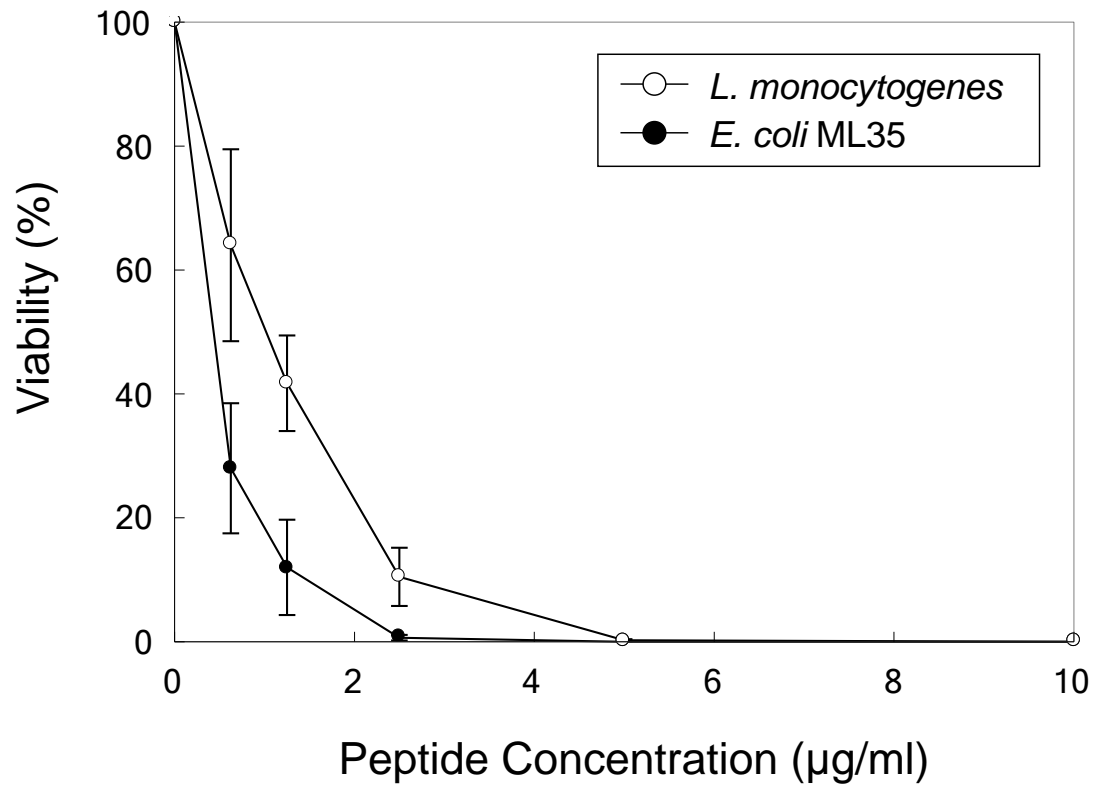

Figure 7.

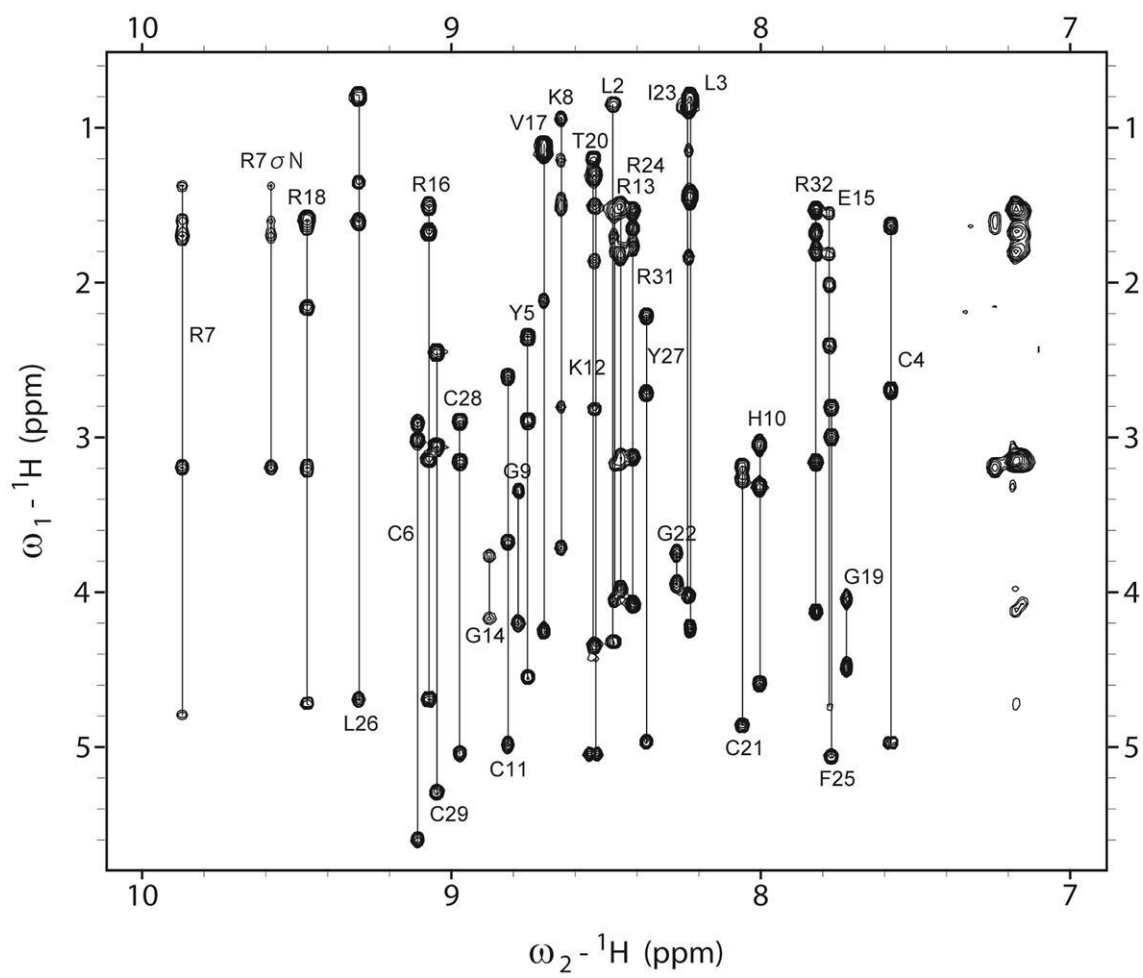

Figure 8.

